

1

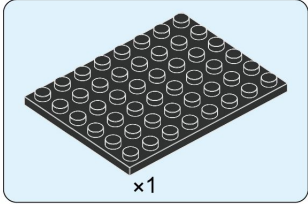

2

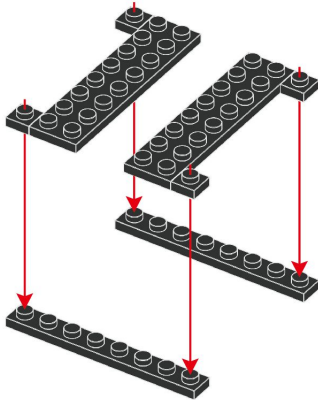
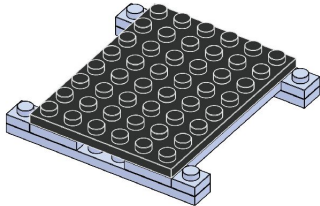

=2=

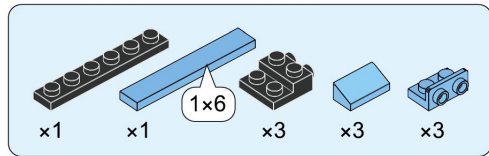

3

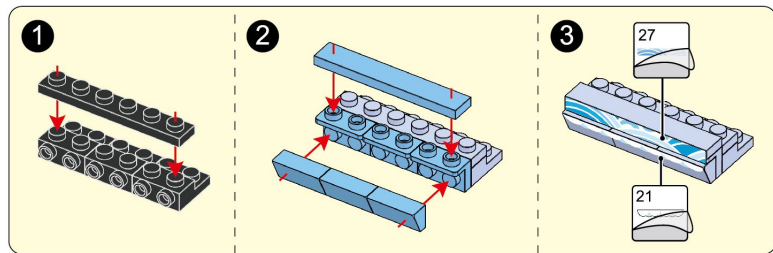

=3=

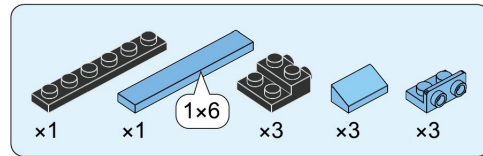
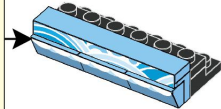

4

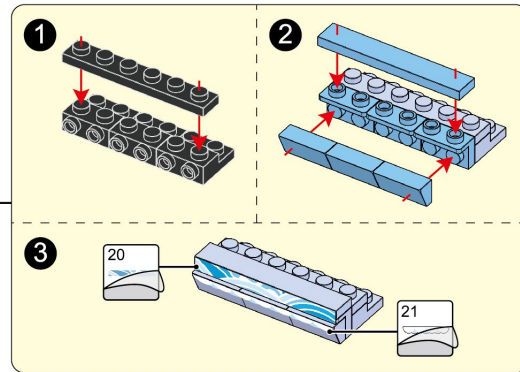
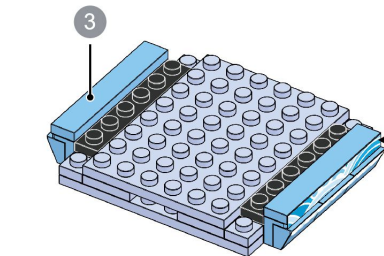

=4=

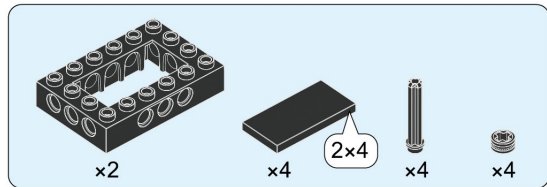

5

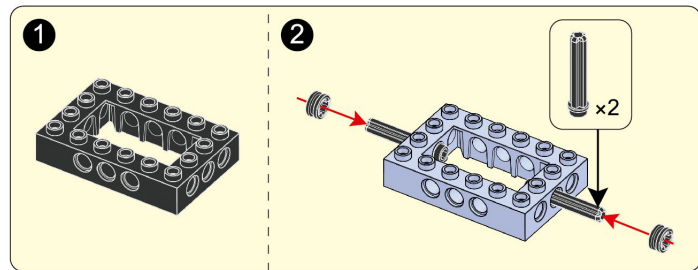

=5=

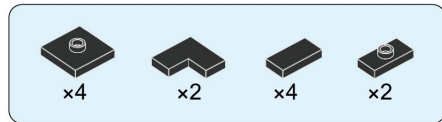
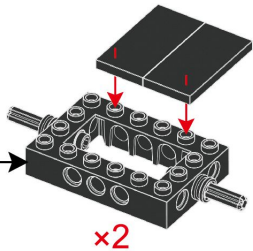

6

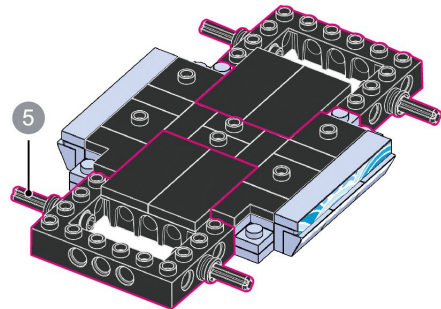

=6=

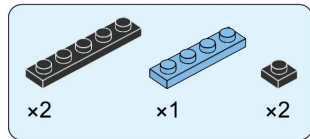

7

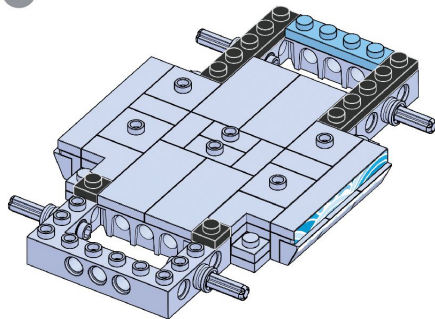

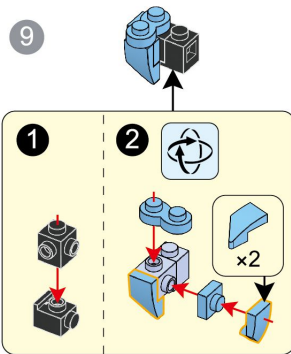
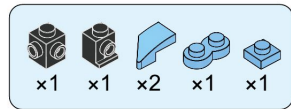
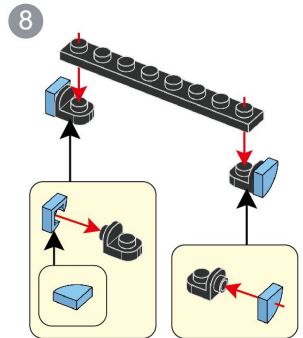
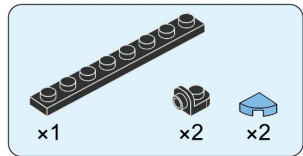

=7=

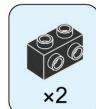
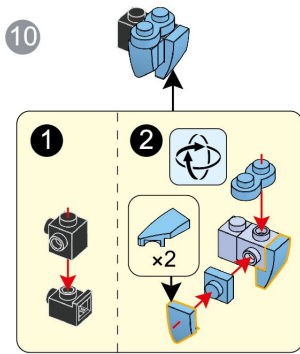
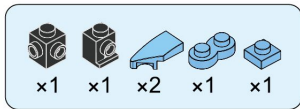

11

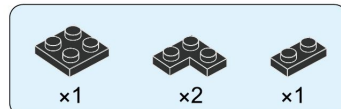
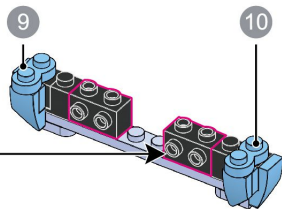
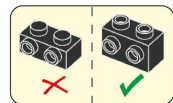

12

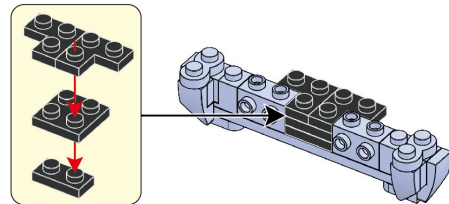

=8=

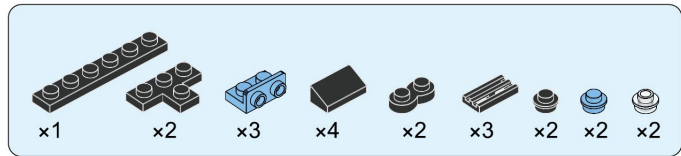

13

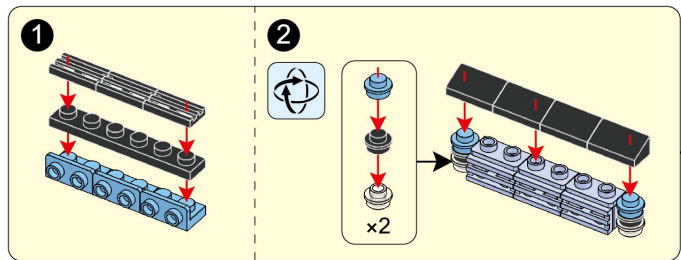

=9=

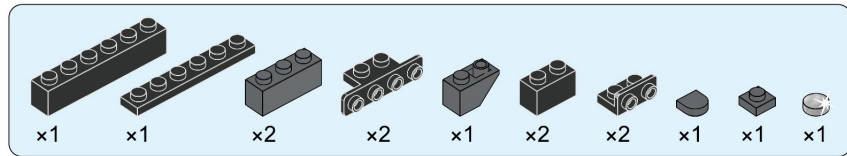
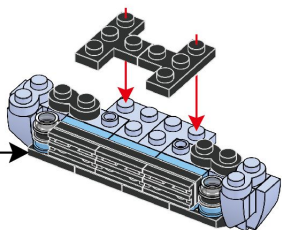

14

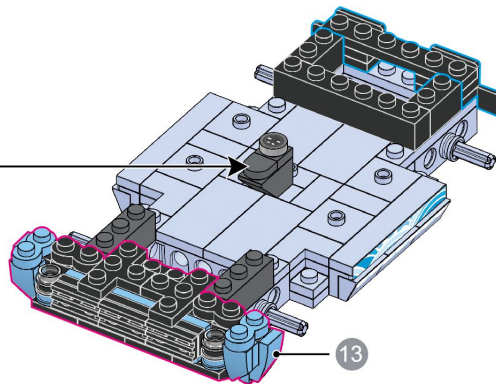
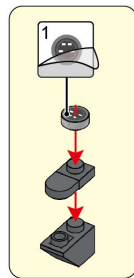

=10=

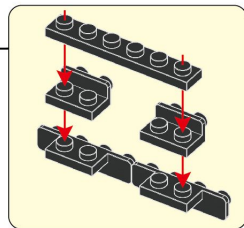

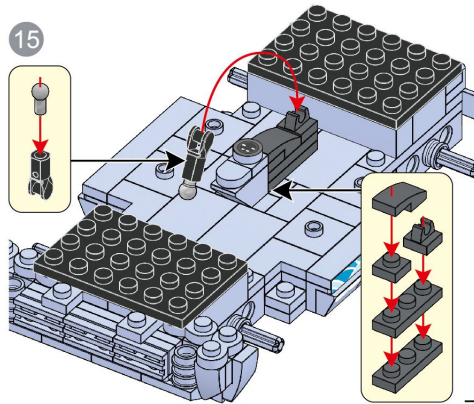
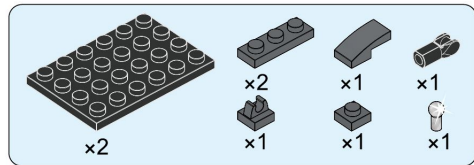

=11=

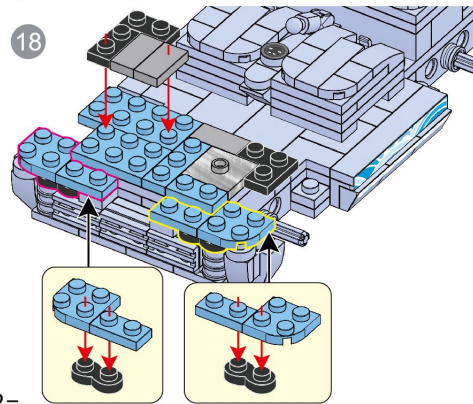
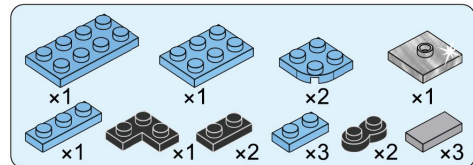
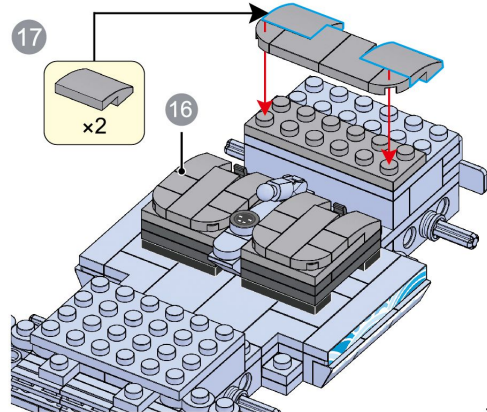
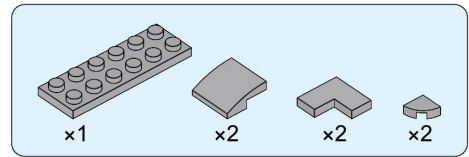
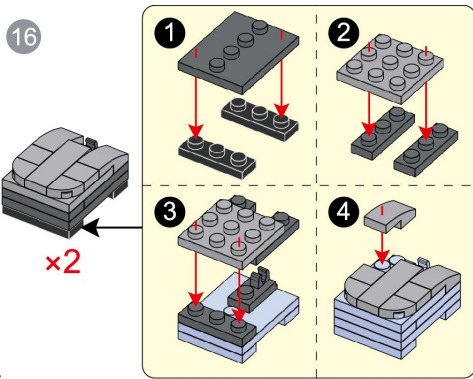
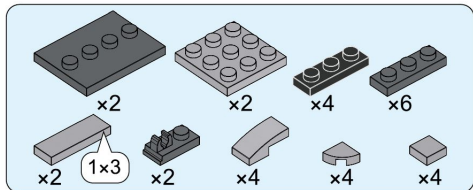

=12=

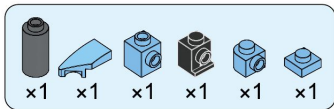

19

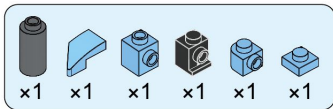
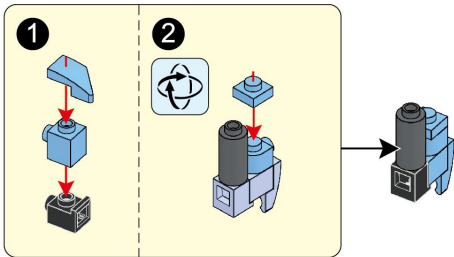

20

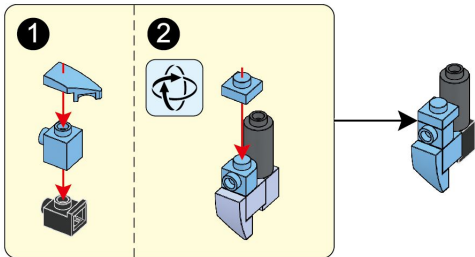

=13=

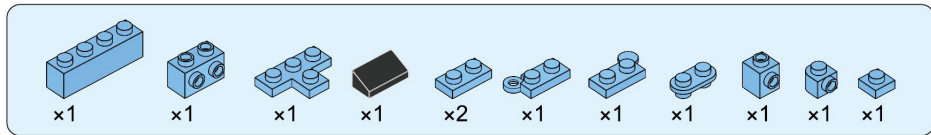

21

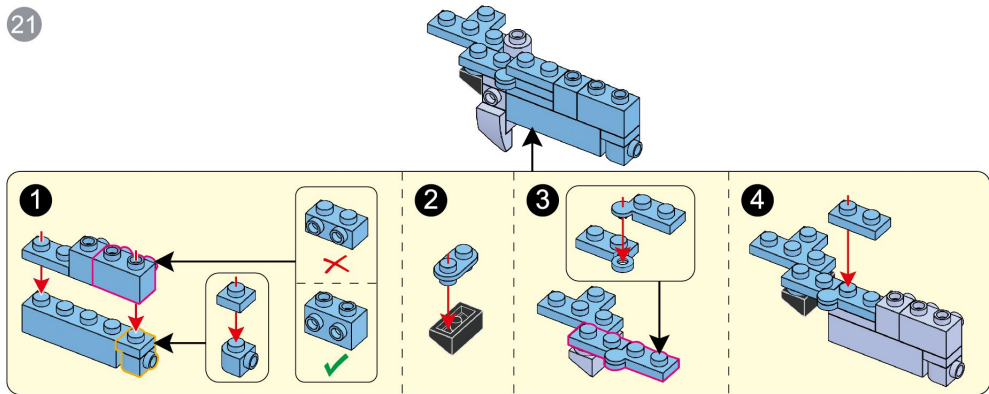

=14=

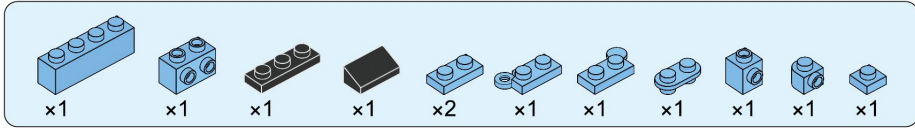

22

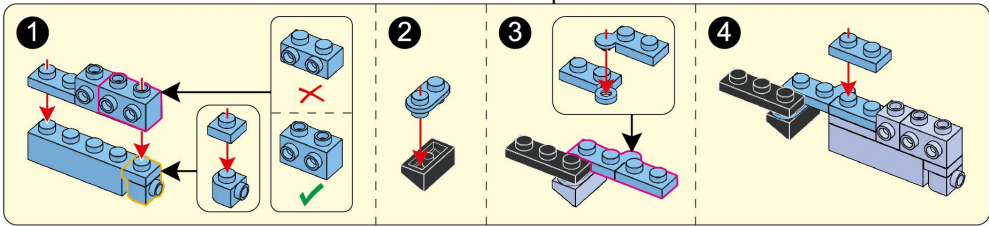
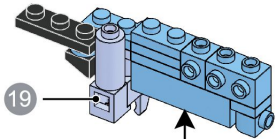

=15=

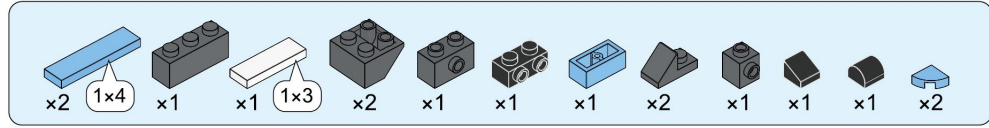

23

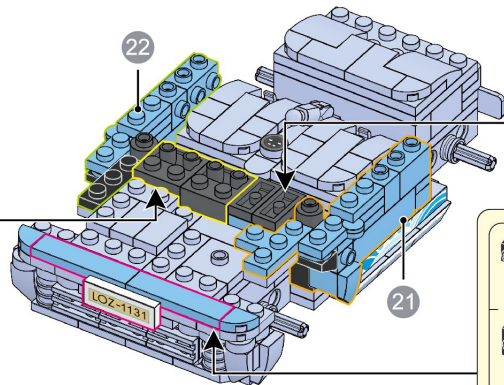
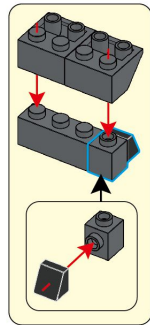

=16=

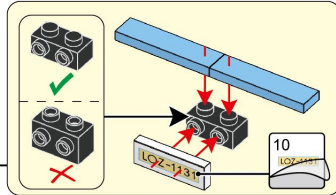
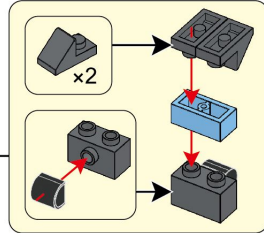



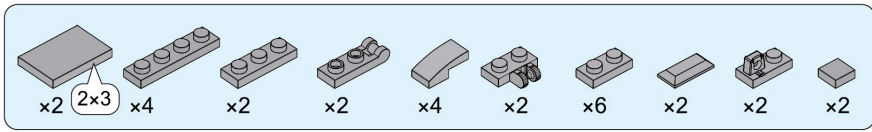

24

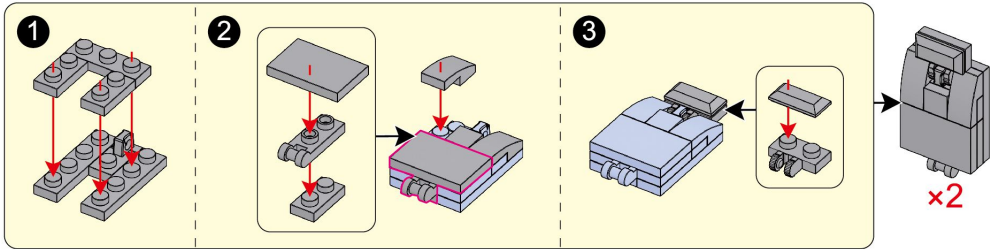

=17=

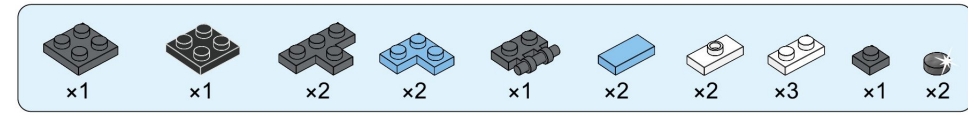

25

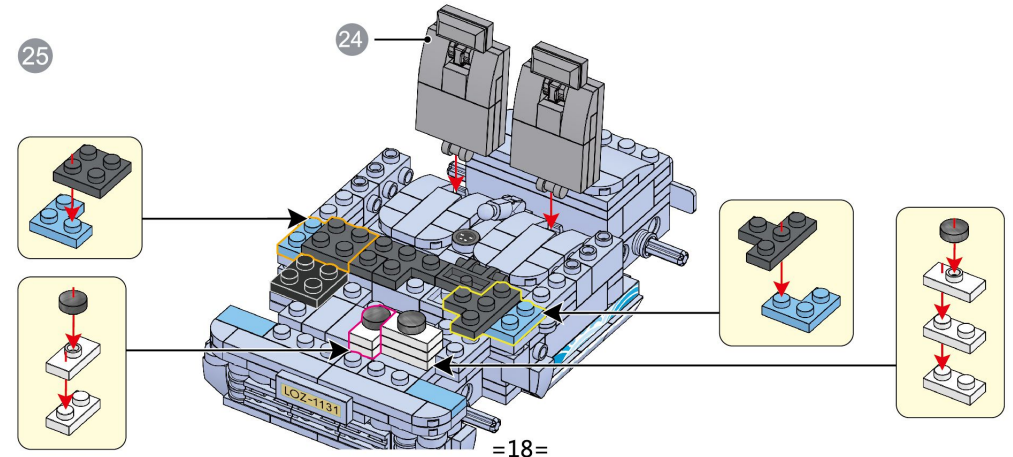

=18=

26

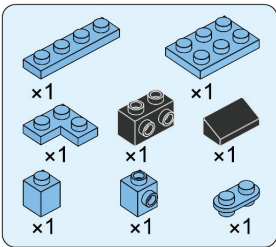
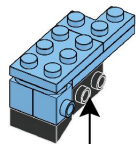

1

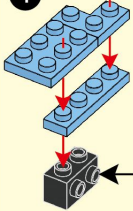

2

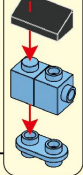
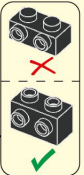
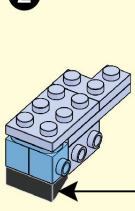

=19=

27

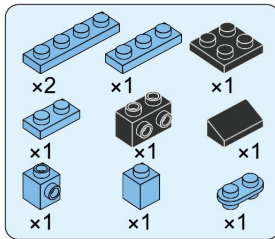
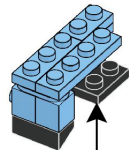

1

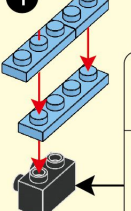

2

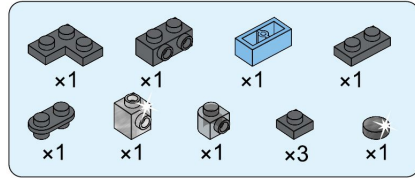
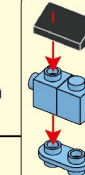
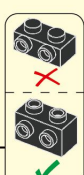
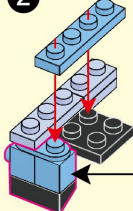

28

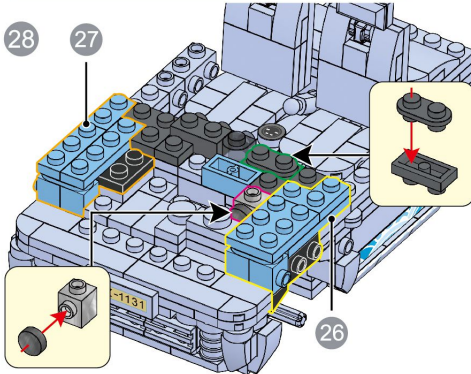

27

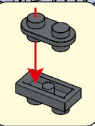

26

8

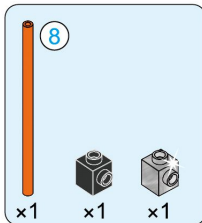

29

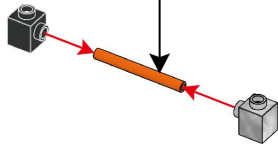
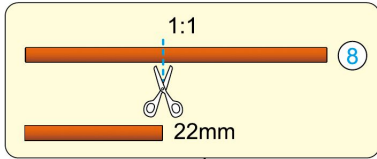

=20=

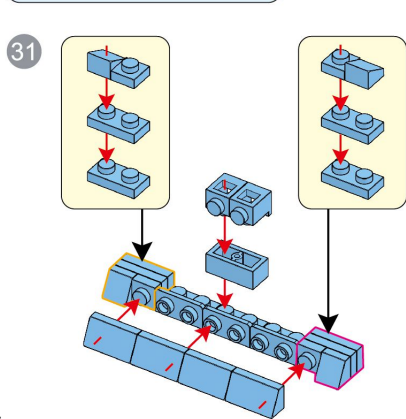
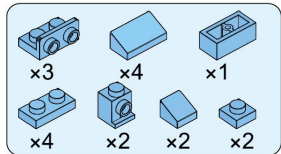
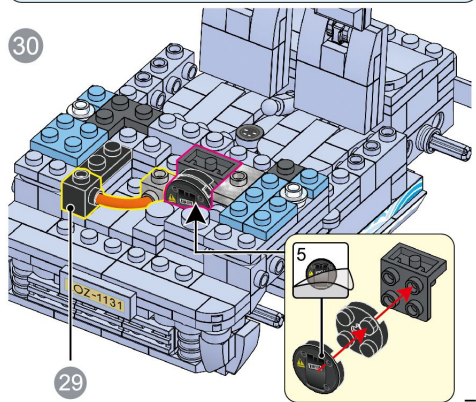
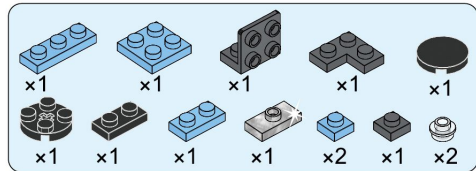

=21=

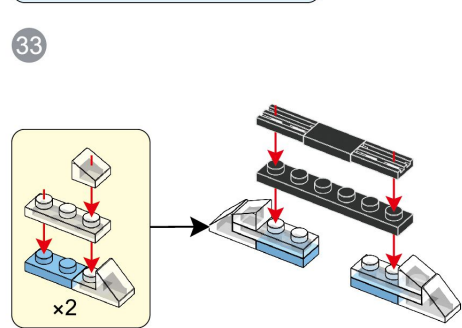
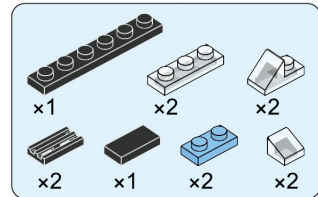
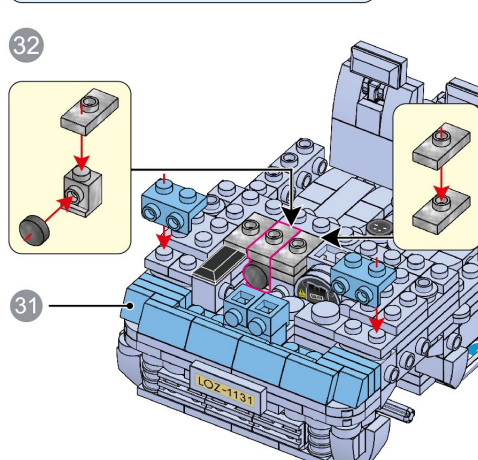
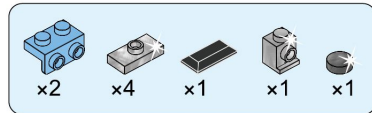

=22=

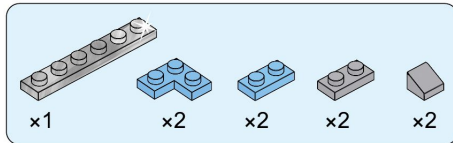

34

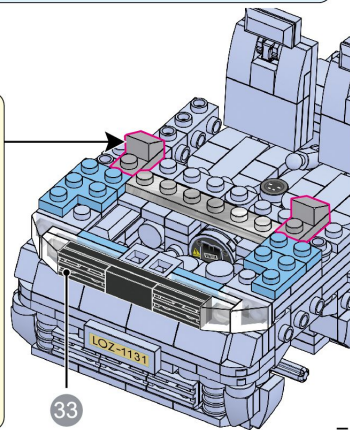
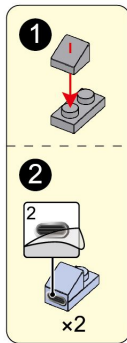

=23=

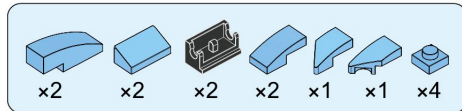

35

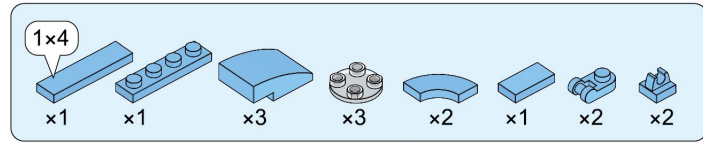
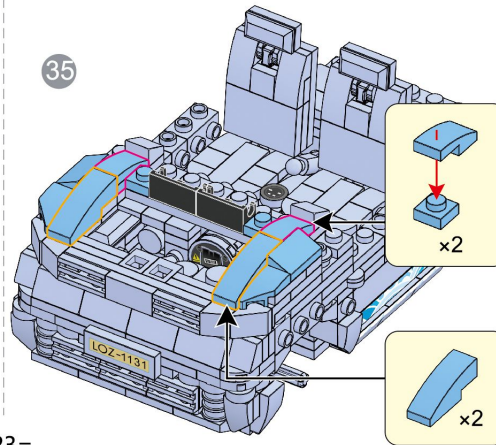

36

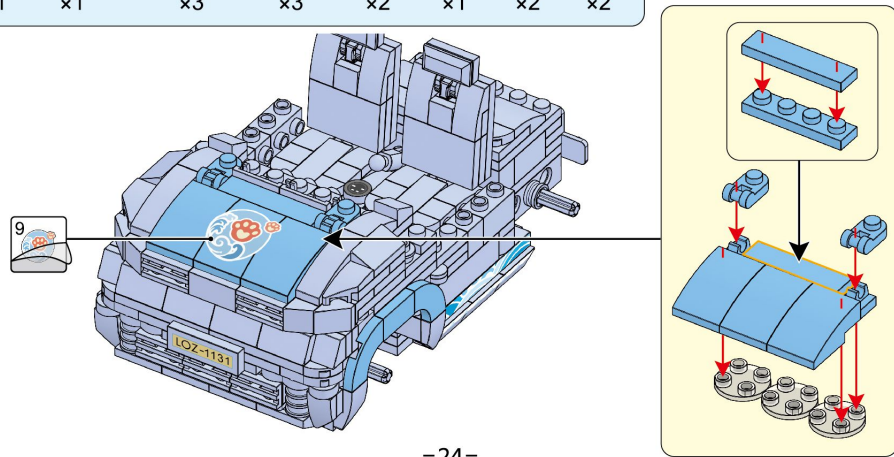

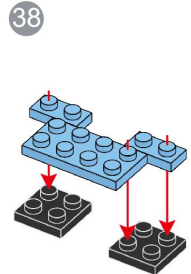
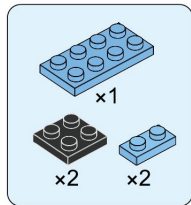
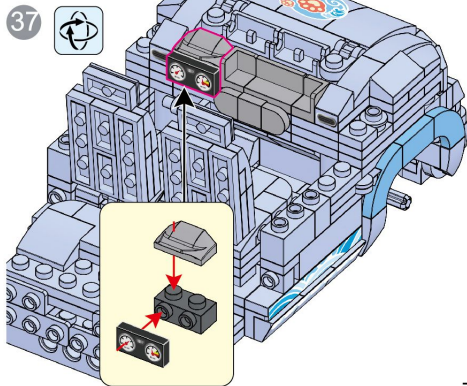
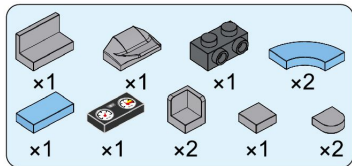

=25=

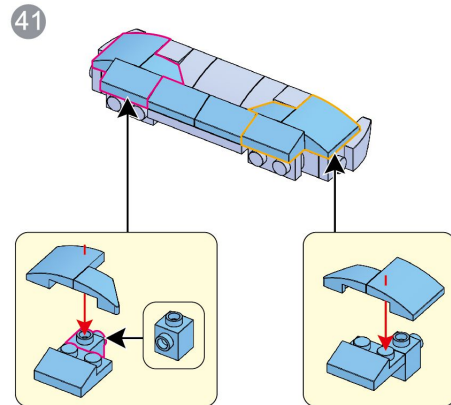
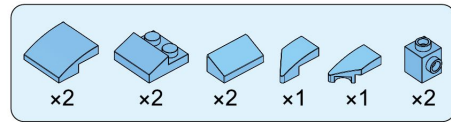
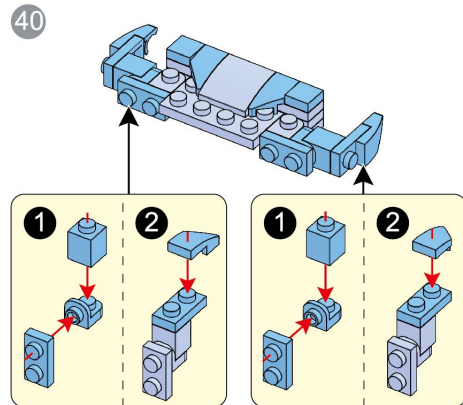
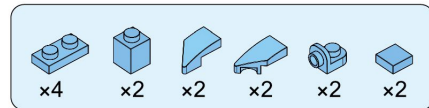
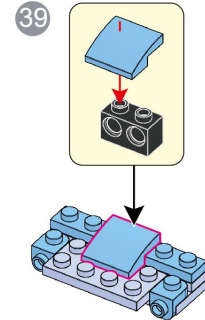
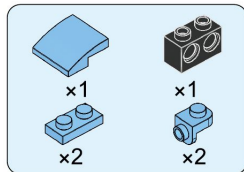

=26=

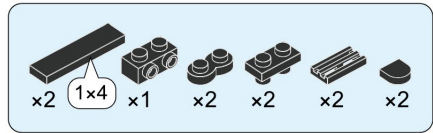

42

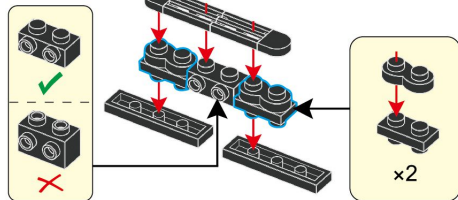

43

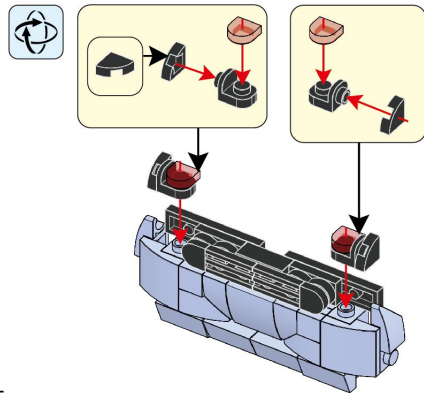

=27=

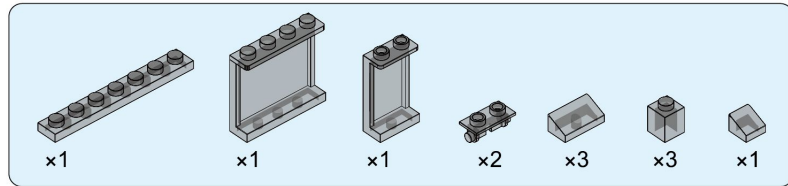

44

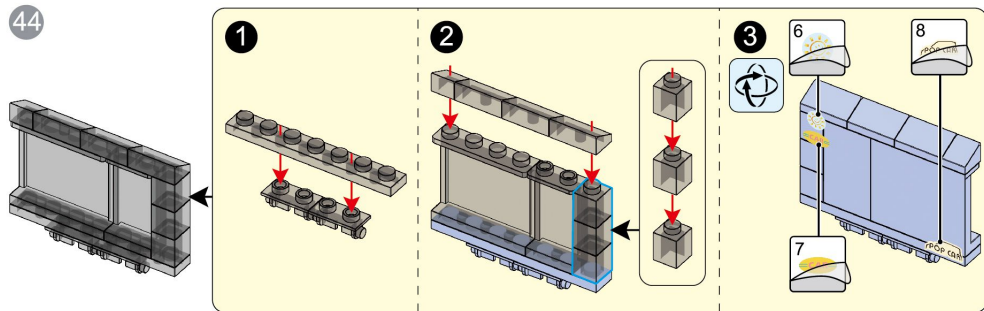

=28=

45

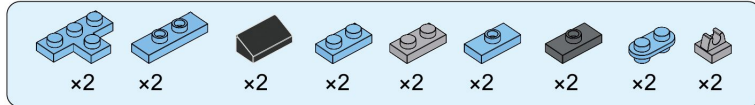
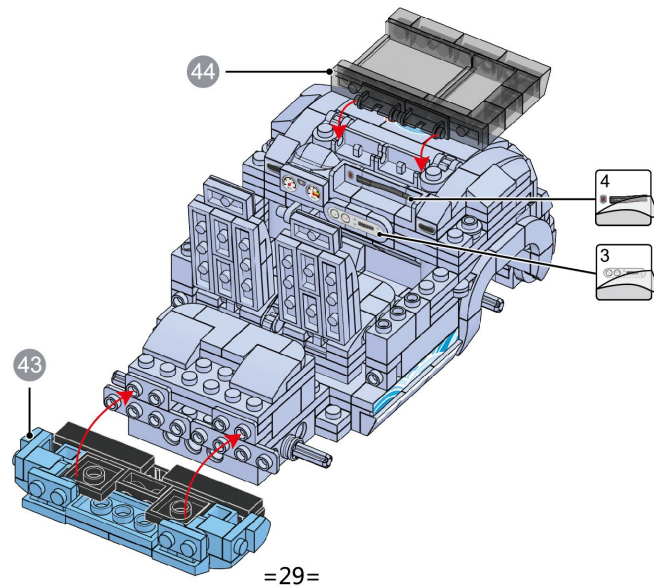

46

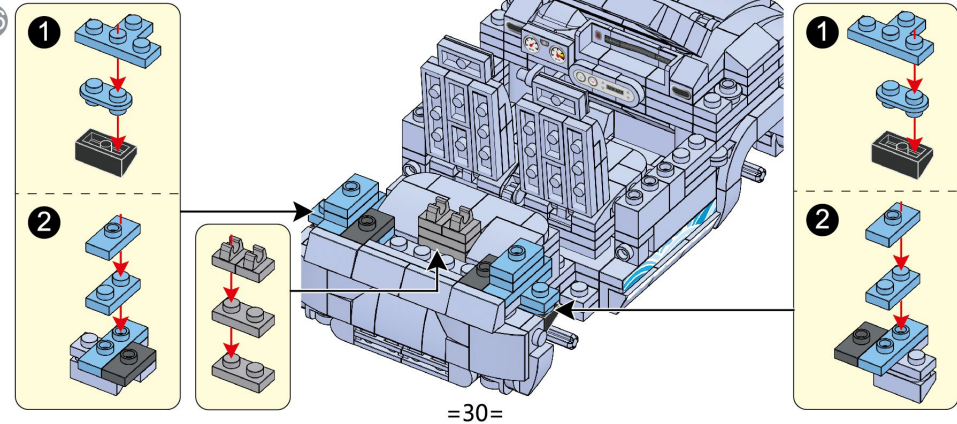

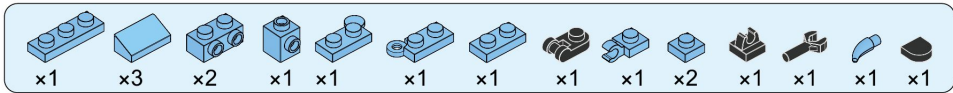

47

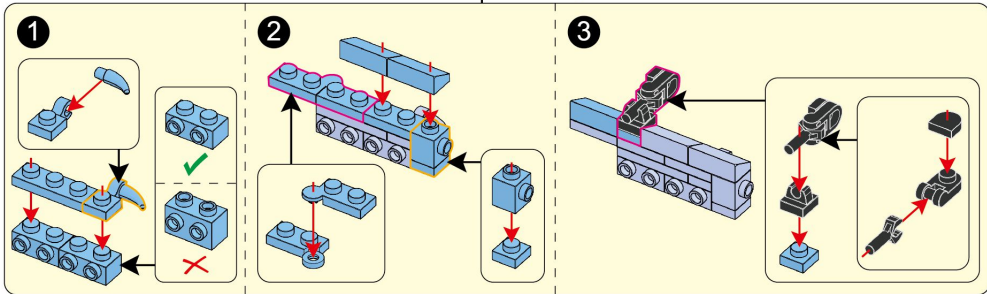
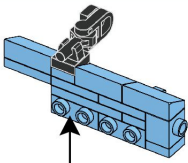

=31=

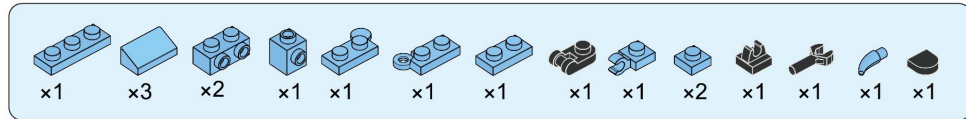

48

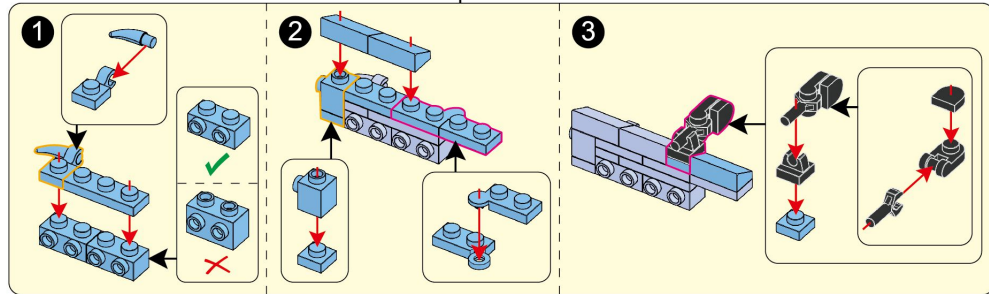
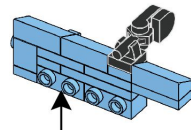

=32=



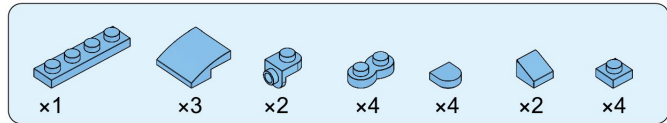

49

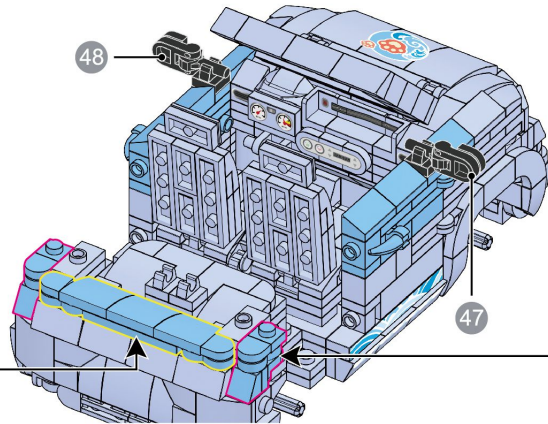
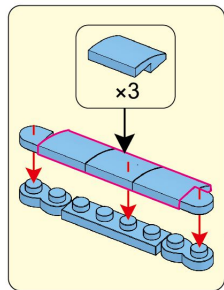

=33=

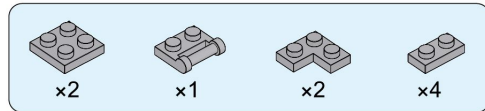
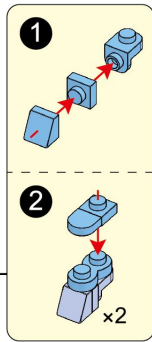

50

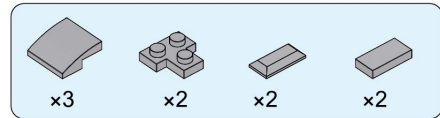
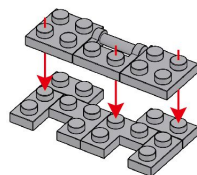

51

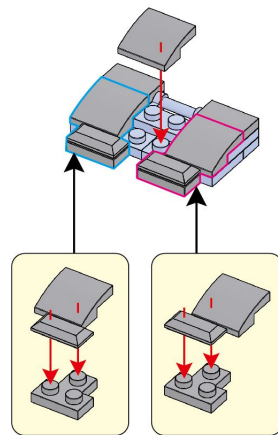

=34=

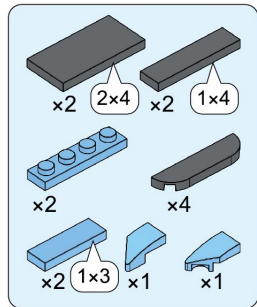

52

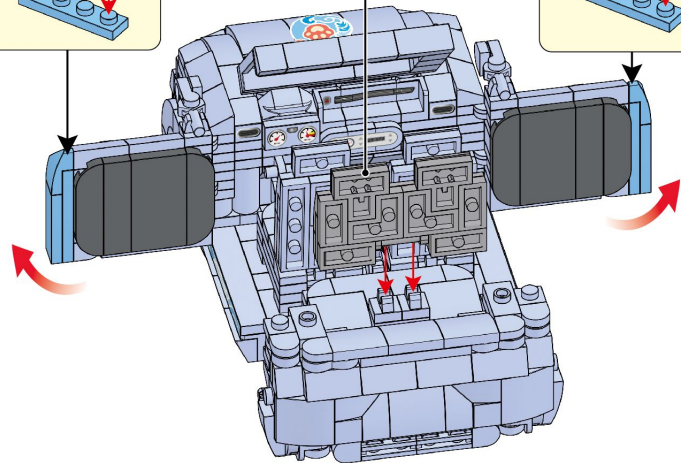
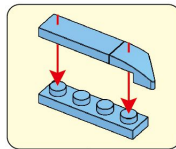

=35=

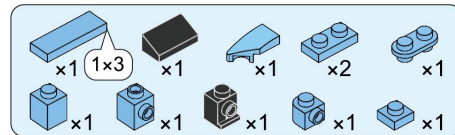
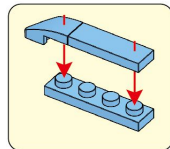

53

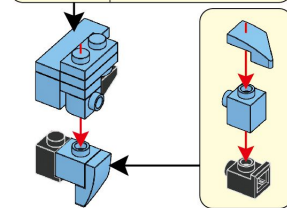
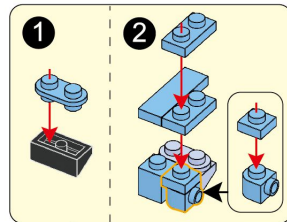

=36=

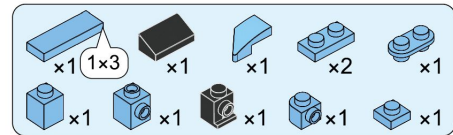

54

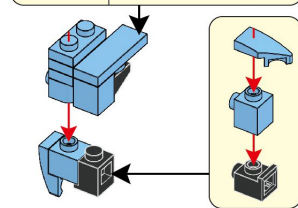
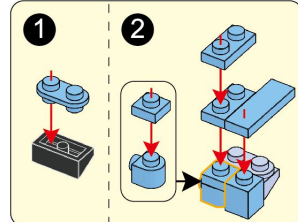



57



56



=39=

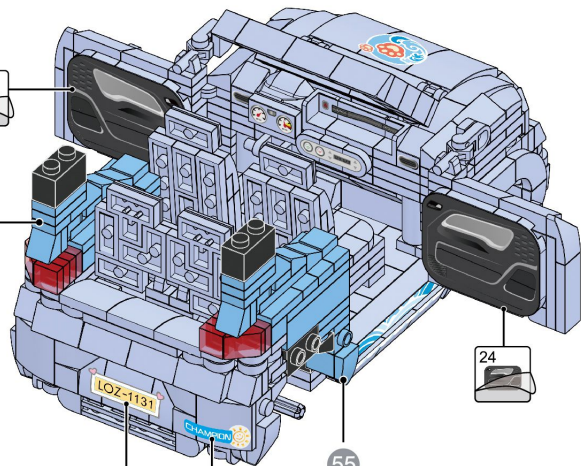

55

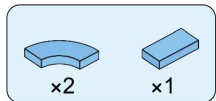

58



x2

x1

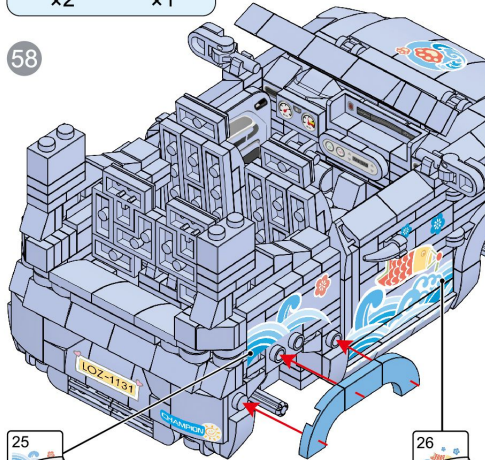

=40=

59



x1

x2

x1

x1

x1

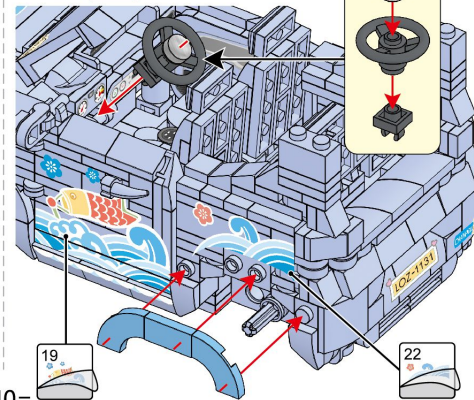
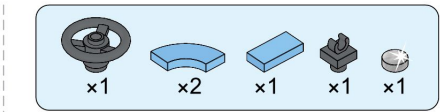

22

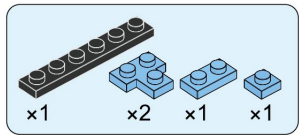

60

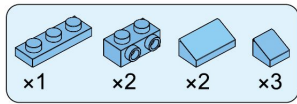
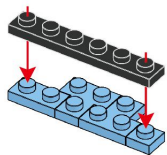

61

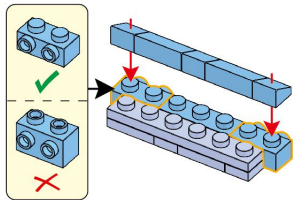

=41=

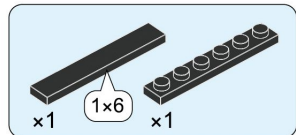

62

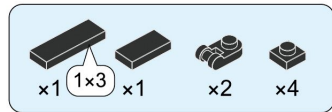
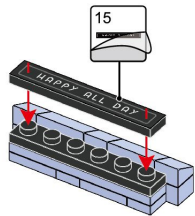

63

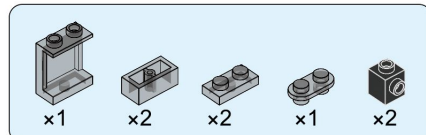
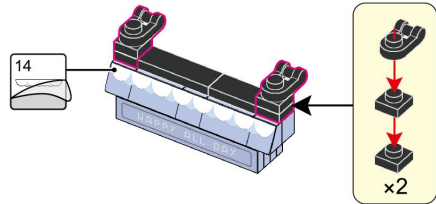

64

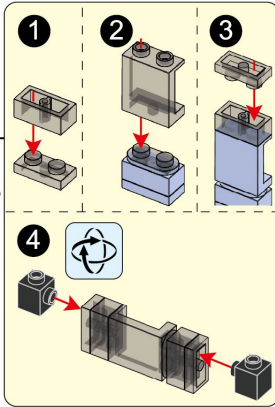
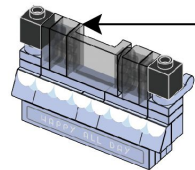

=42=

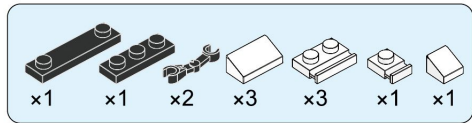

65

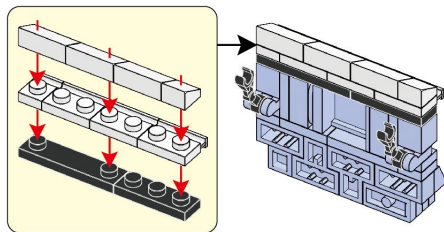

=43=

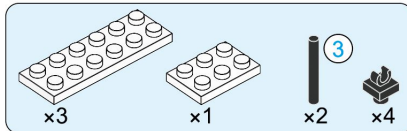

66

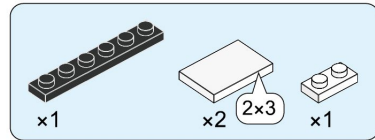
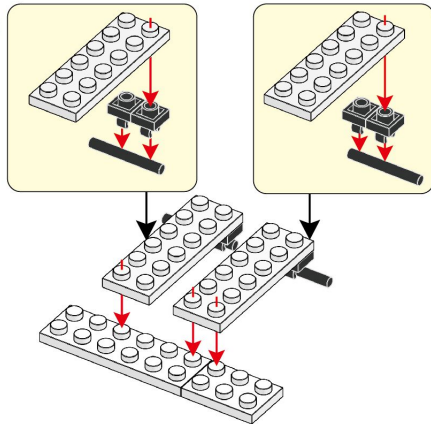

67

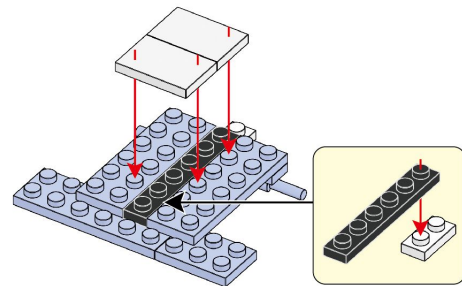

=44=

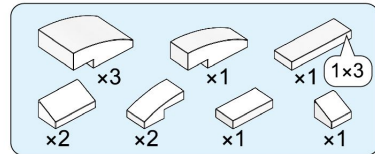

68

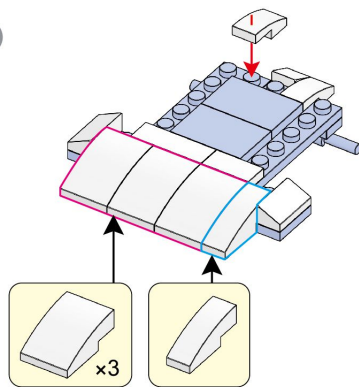

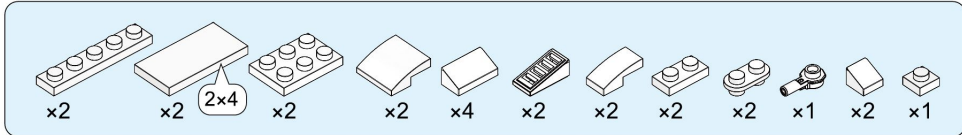

69

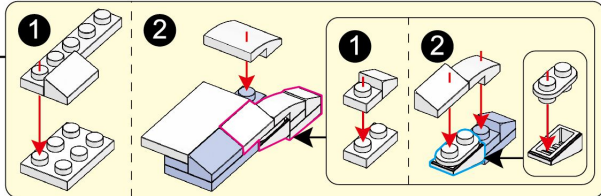
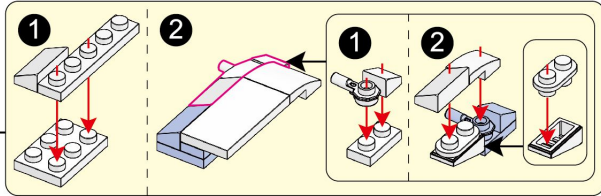
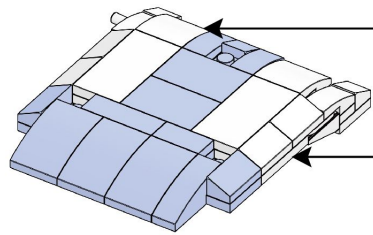

=45=

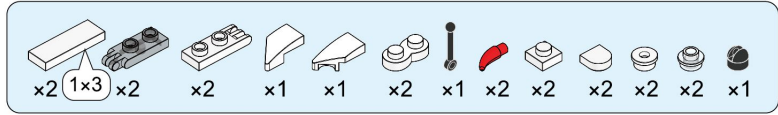

70

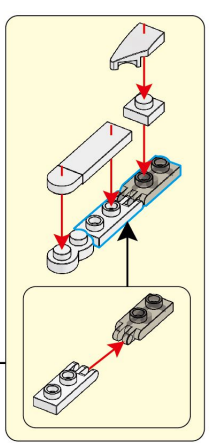
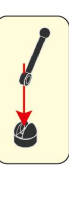
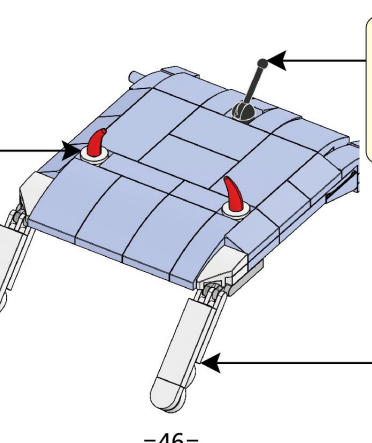
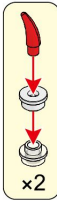
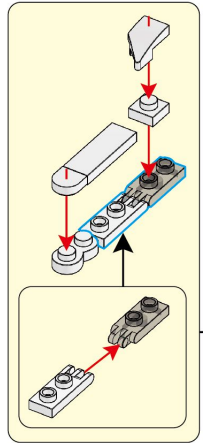
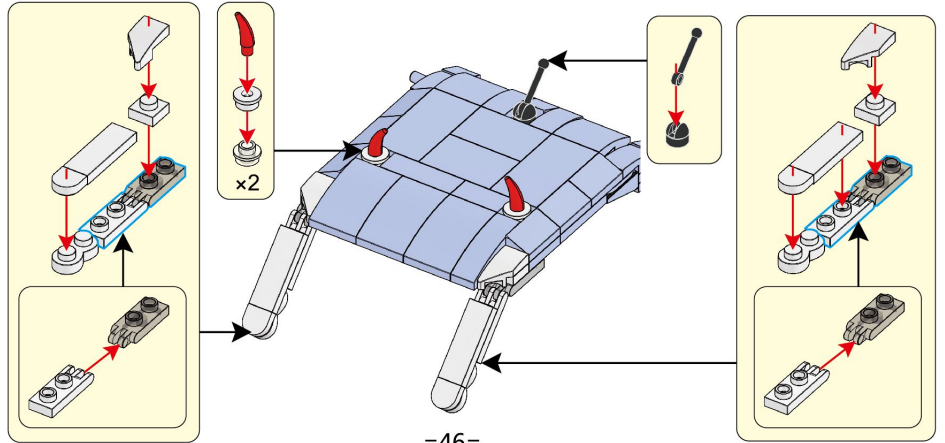

=46=

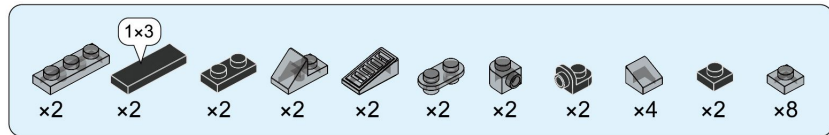

71

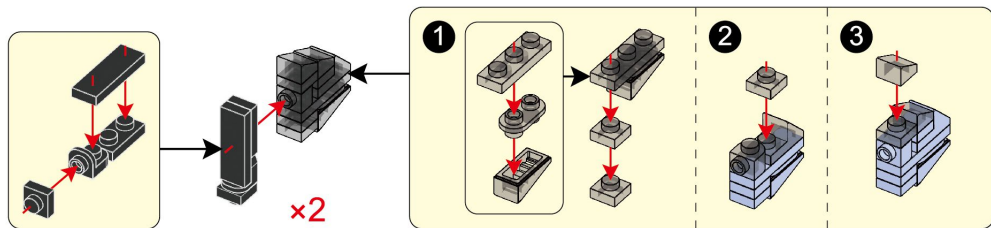

=47=

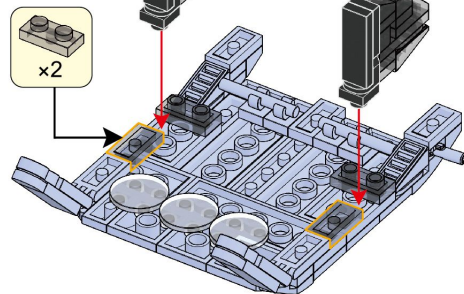
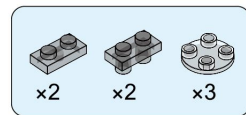

=48=

73

65

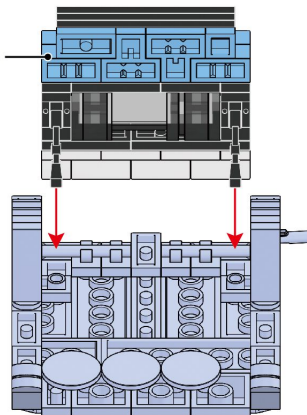



74

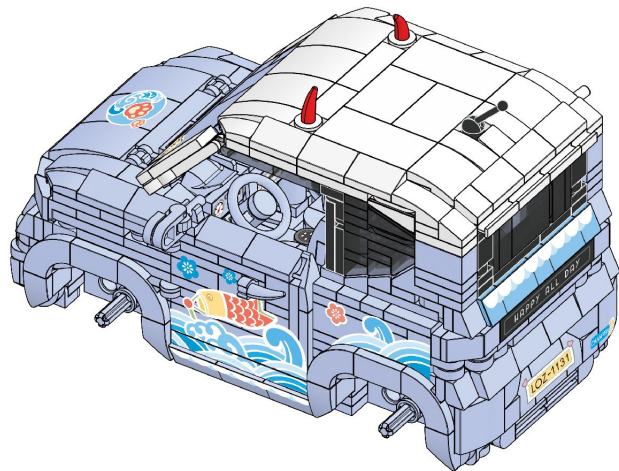

=49=

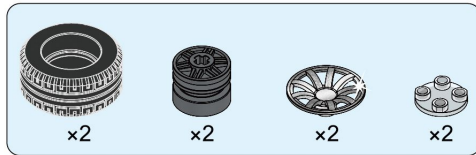

75

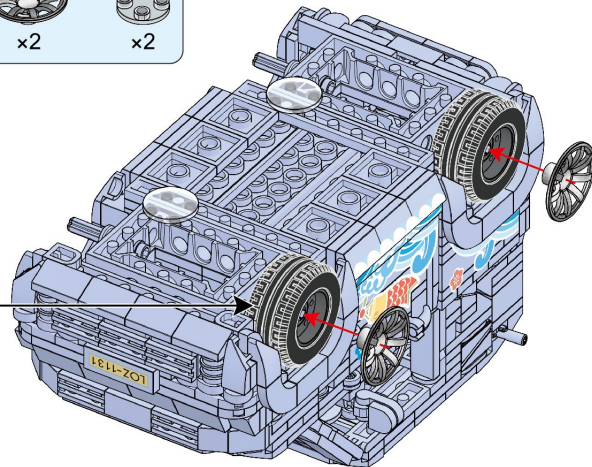
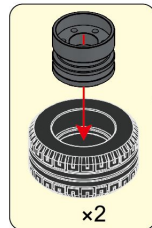

=50=

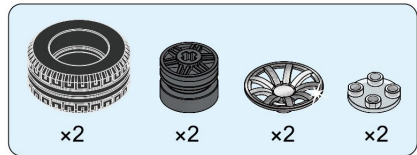

76

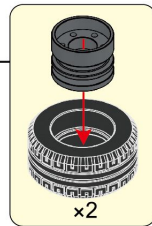
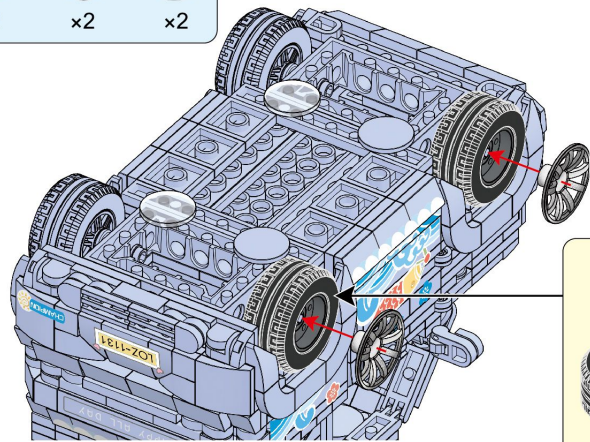

=51=

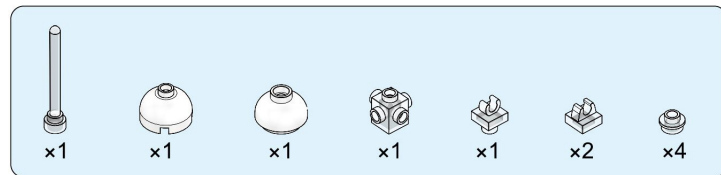

77

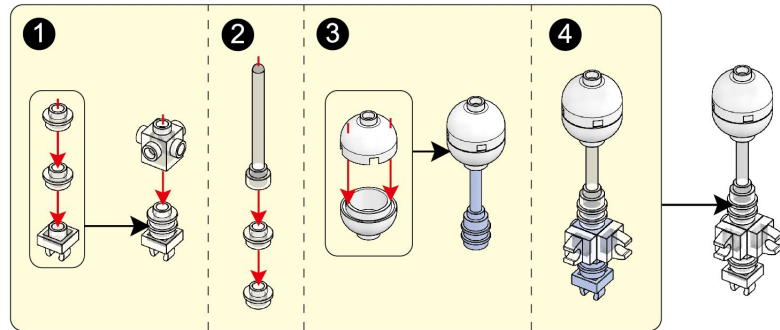

=52=

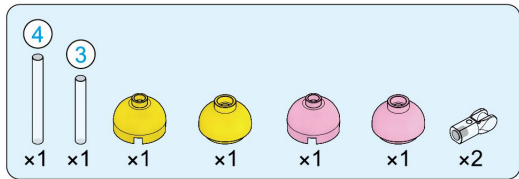

78

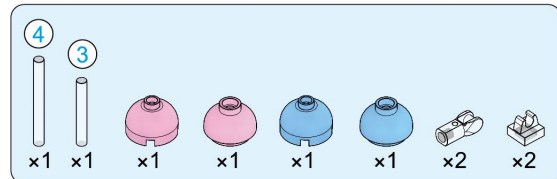
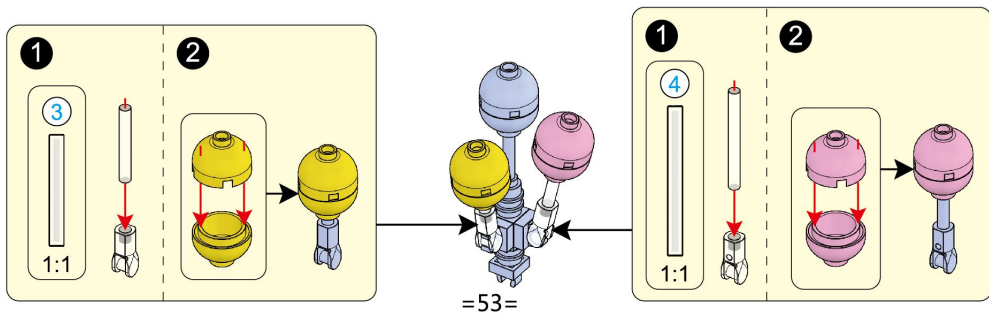

79

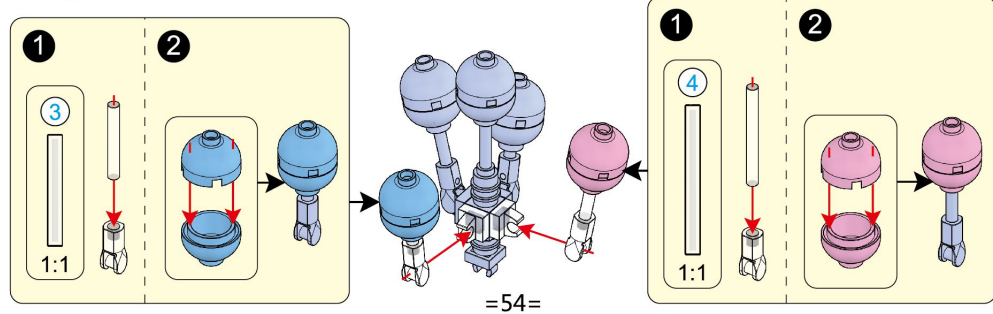

80

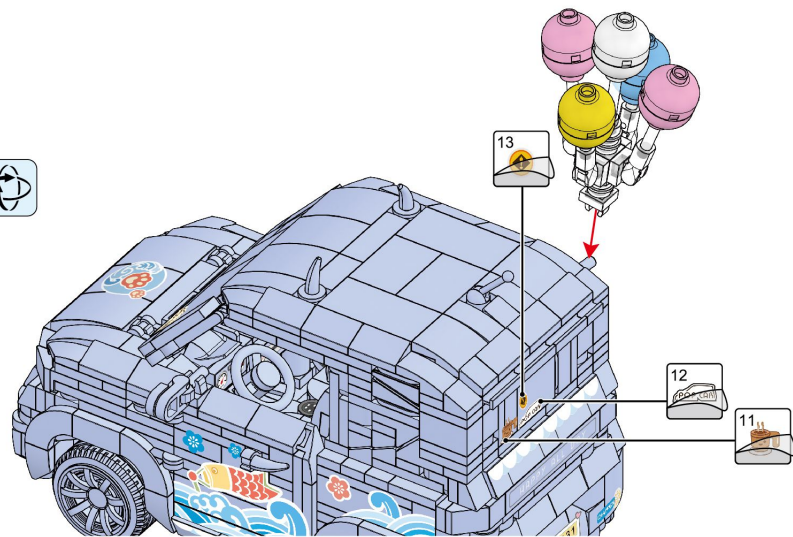

=55=

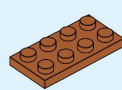

x1



x2



x1



x4



x3

2



x1



x1

81



1

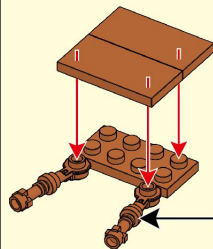

x2

2

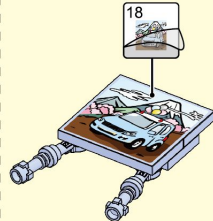

3

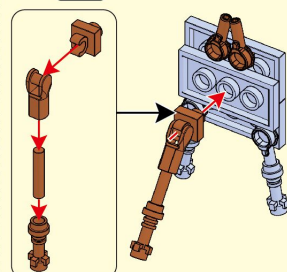

=56=

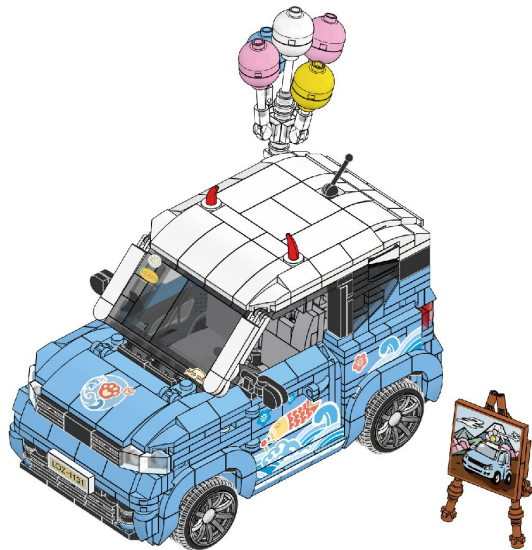

=57=

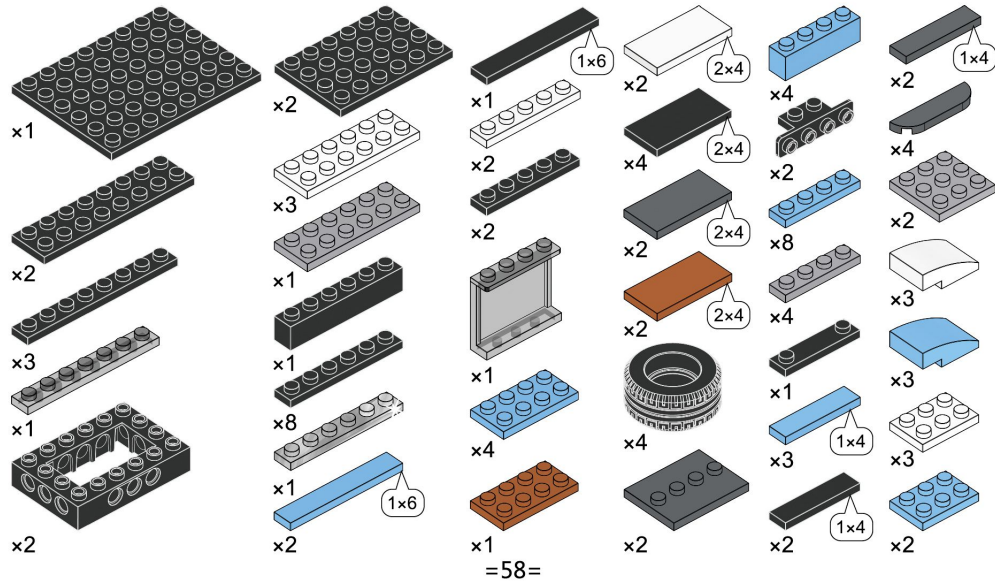

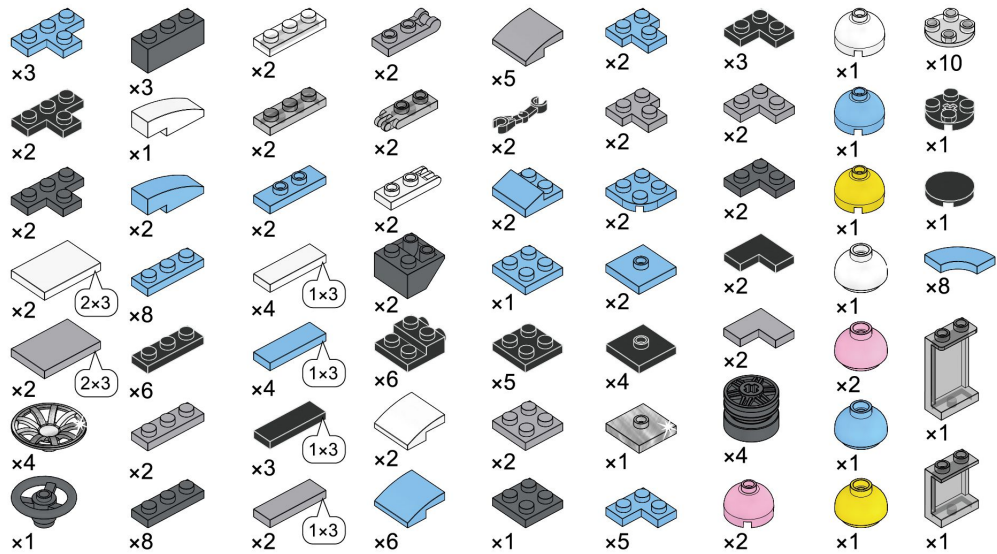

=59=

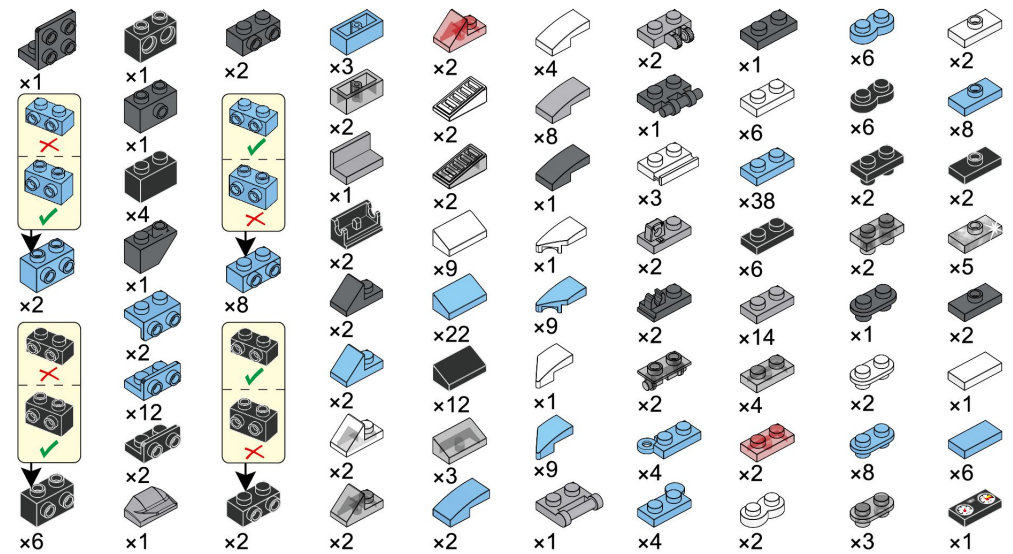

=60=

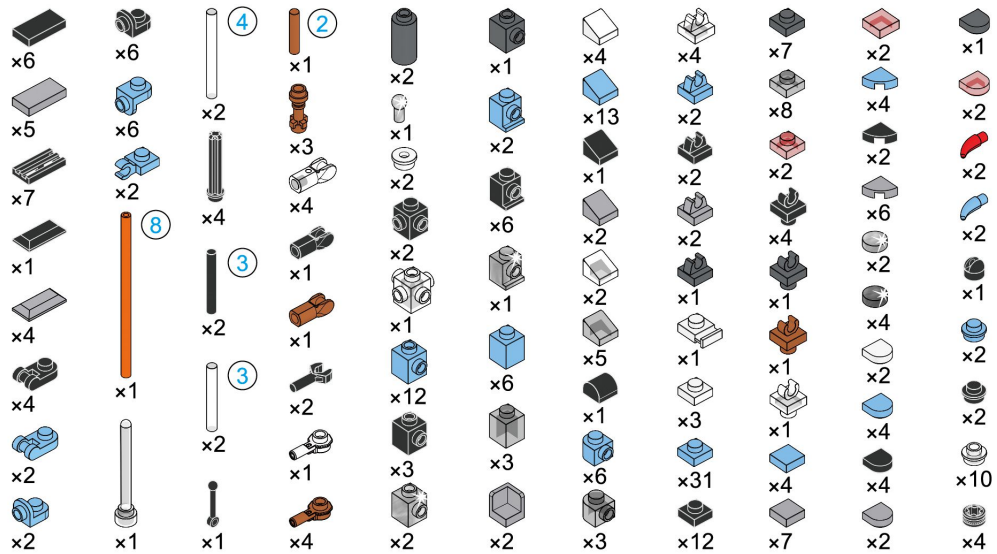

=61=

