

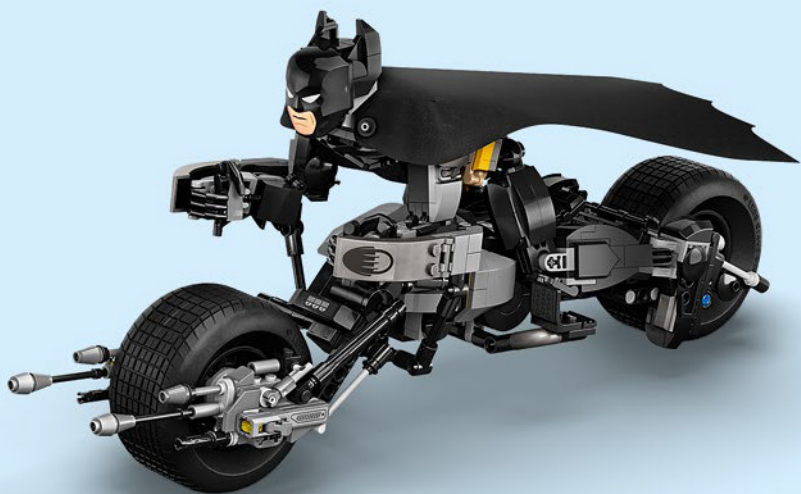

76273



1



LEGO® Builder



LEGO.com/sustainable-packaging



 **FR**
DONNEZ
OU
RECYCLEZ

 OU  OU 

ASSOCIATION MAGASIN DÉCHÈTERIE

Adresses sur quefairedemesdechets.fr

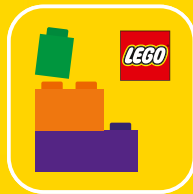

LEGO® Builder

BUILDER



Apple and the Apple logo are trademarks of Apple Inc., registered in the U.S. and other countries and regions. App Store is a service mark of Apple Inc. Google Play and the Google Play logo are trademarks of Google LLC. Tencent and the Tencent logo are trademarks of Tencent Inc.

LEGO.com/devicecheck

EN Ask parents' permission before going online | **DE** Eltern um Erlaubnis bitten, bevor du online gehst | **FR** Demande l'autorisation d'un parent avant d'aller en ligne | **IT** Chiedi il permesso ai tuoi genitori prima di andare online | **ES** Pídeles permiso a tus papás antes de conectarte a Internet | **PT** Pede autorização aos pais antes de acederes online | **ZH** 上网前应先征得父母的同意 | **PL** Poproś rodziców o zgodę, zanim wejdiesz do Internetu | **CS** Než půjdeš na internet, požádej rodiče o svolení | **SK** Skôr než pôjdeš na internet, vypýtaj si povolenie od rodičov | **HU** Kérj szülői engedélyt, mielőtt online csatlakoznál! | **RO** Cere permisiunea părinților înainte de a te conecta online | **BG** Поискайте разрешение от родител, преди да влезете онлайн | **LV** Pirms došanās tiešsaistē palūdz atļauju vecākiem | **ET** Enne Interneti kasutamist küsi vanematelt luba | **LT** Prieš prisijungdami prie interneto, atsiklauskite tėvų

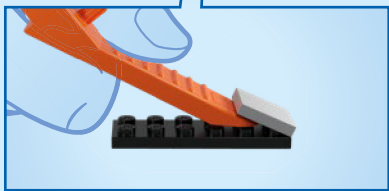
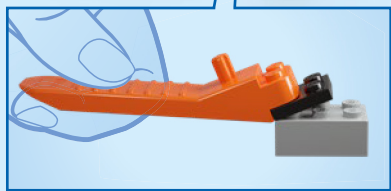
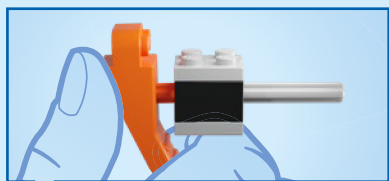
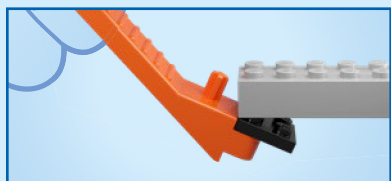

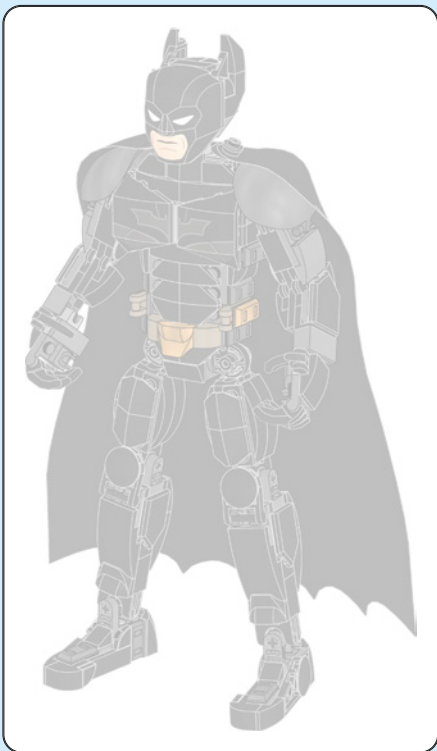

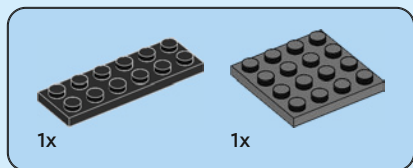

1

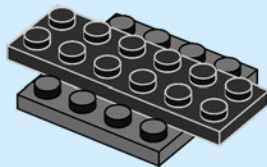



2

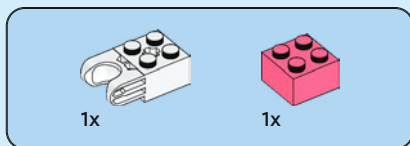
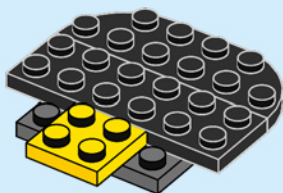

3

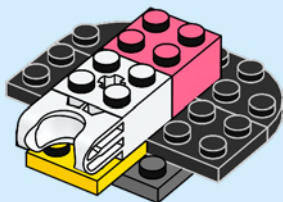



2x



1x



2x

4

1

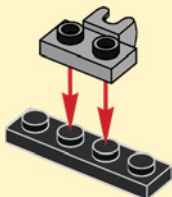

2

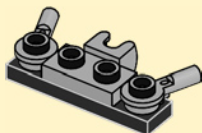

3

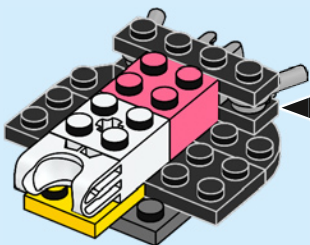
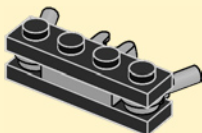



2x

5

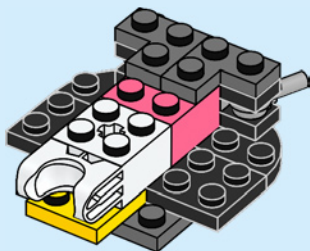

2x



2x

6

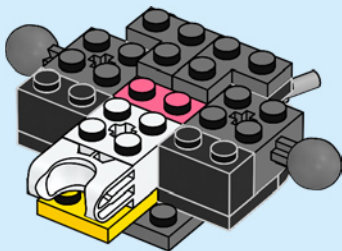



2x

7

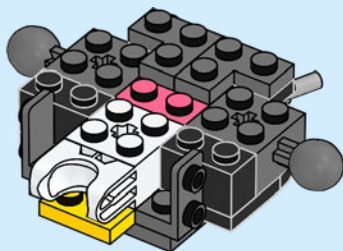

2x

8

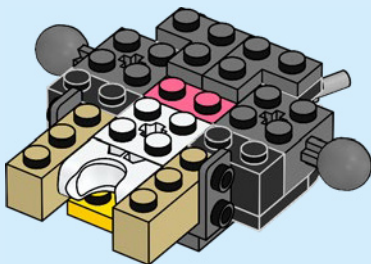

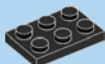

2x

9

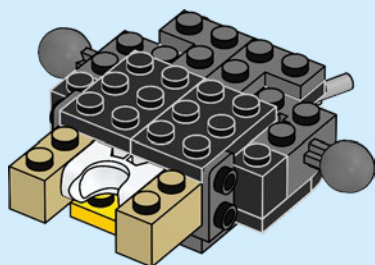

2x

10

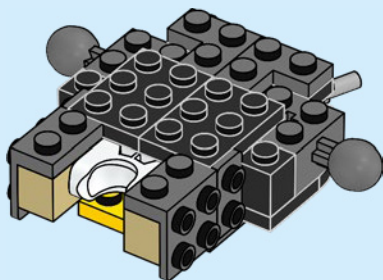

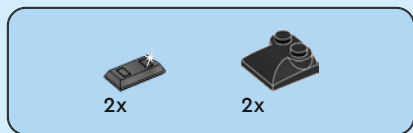

11

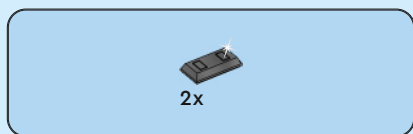
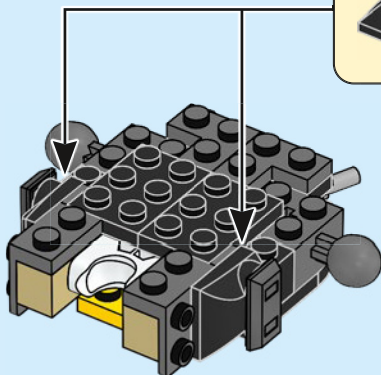
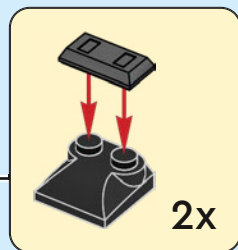

12

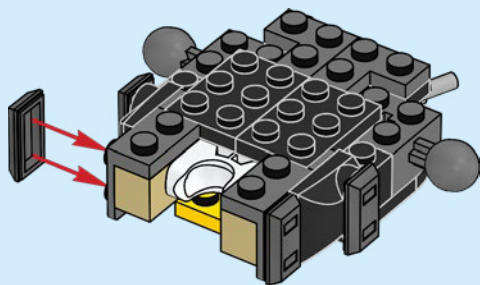



2x

13

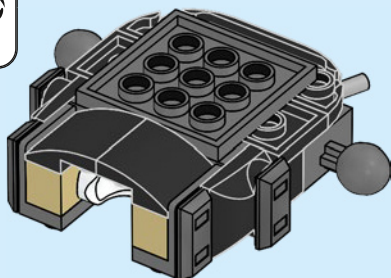

1x



4x

14

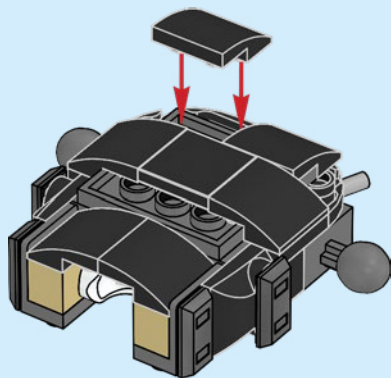



1x



1x



1x

15

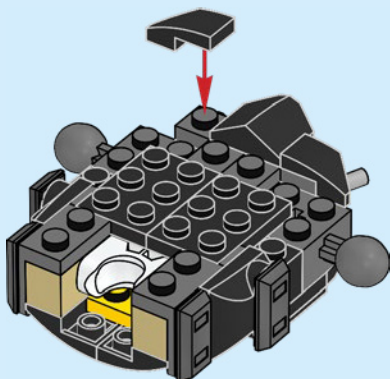

2x

16

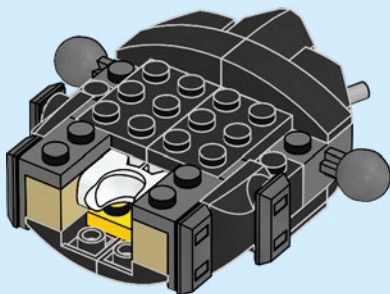

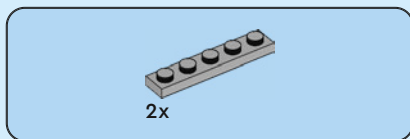

17

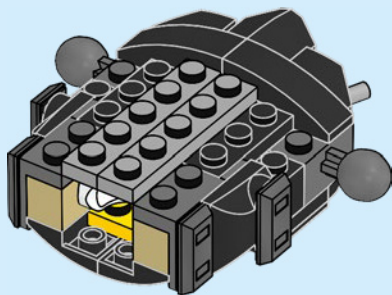

18

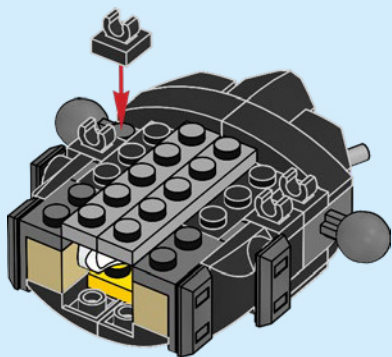

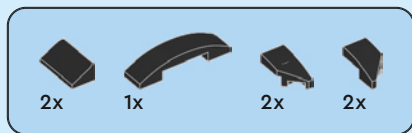

19

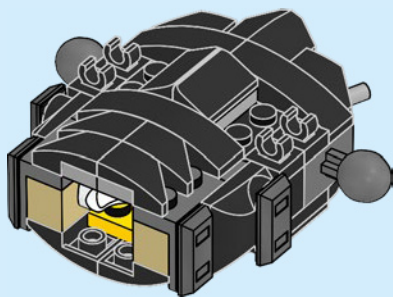

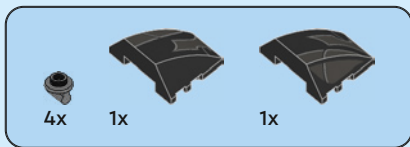

20

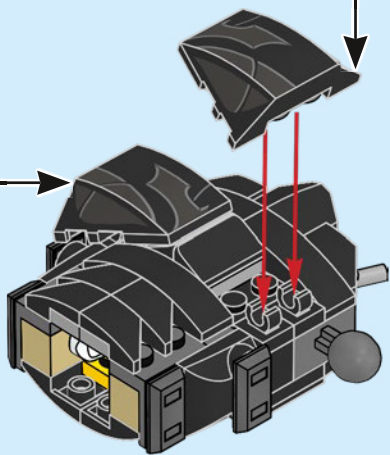
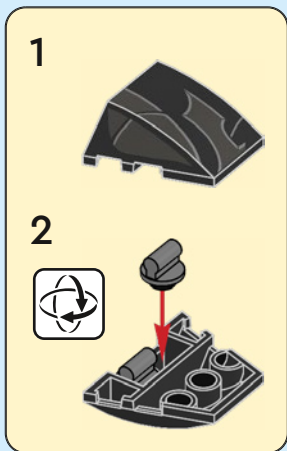
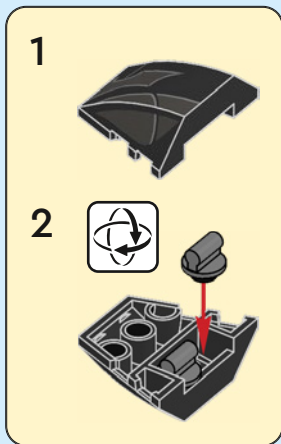

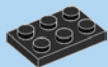

1x



1x

21

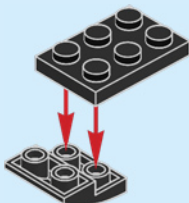

2x

22

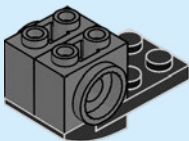

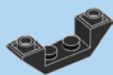

1x

23

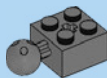
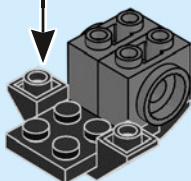
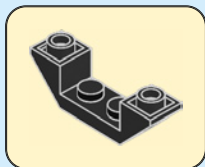

1x

24

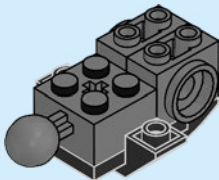



2x



2x

25

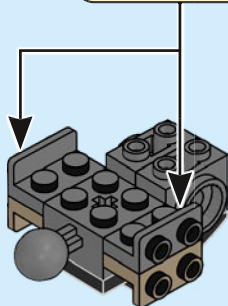
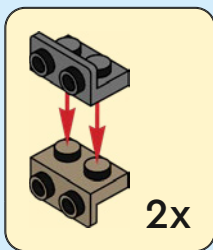

2x

26

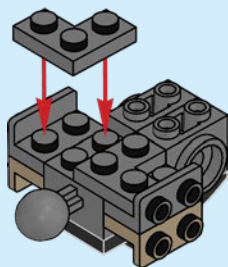

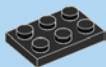

1x



1x

27

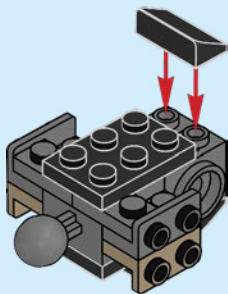

2x



2x

28

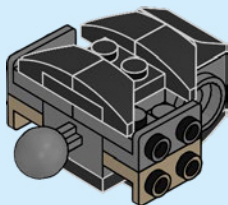



2x



2x

29

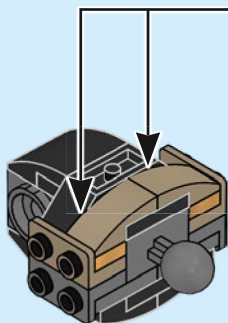

2x



2x

30

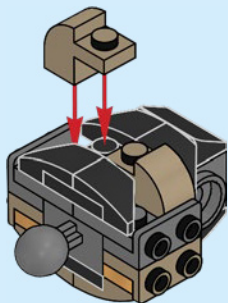



1x

31

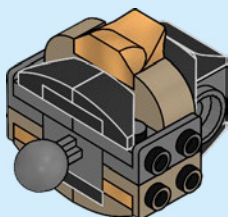

2x



2x

32

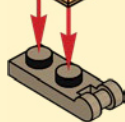
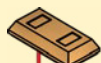

2x

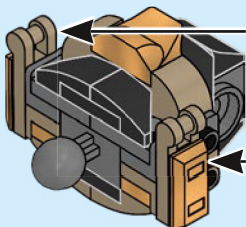



2x

33

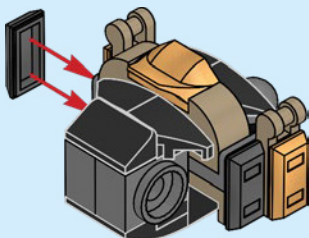

34

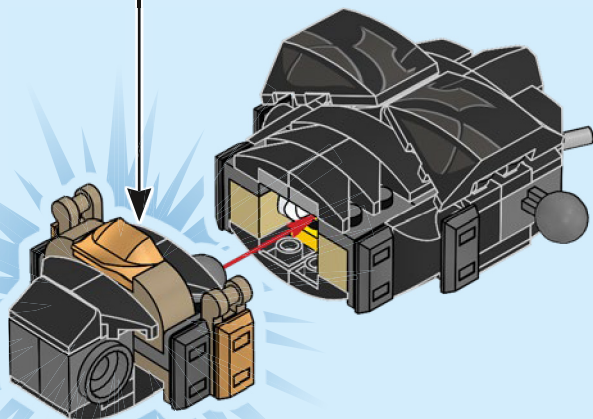





2x



1x

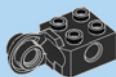

1x

35

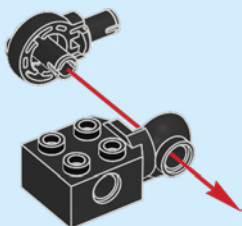

1x



1x

36

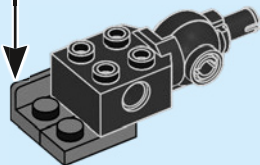



1x

37

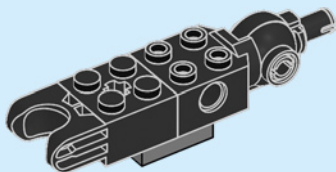

1x



1x

38

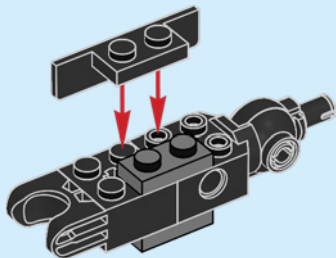



2x

39

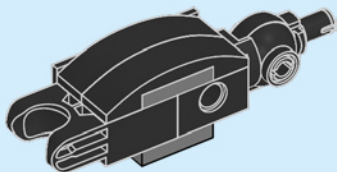

2x

40

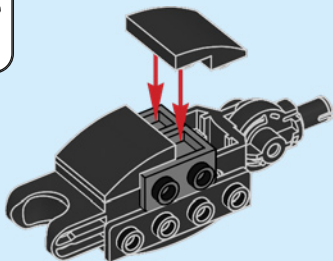



2x

41

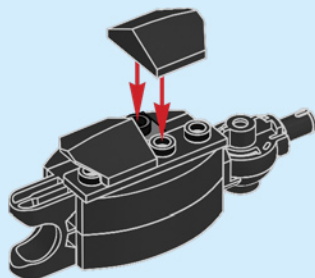

2x

42

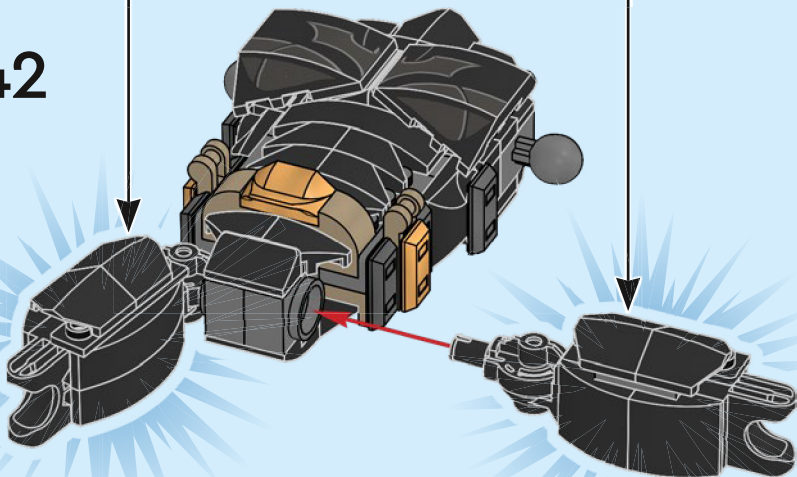



2x



1x



1x

43

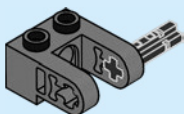

1x

44

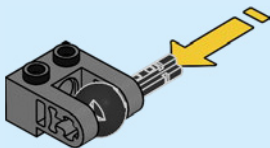

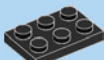

1x

45

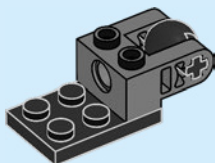

2x

46

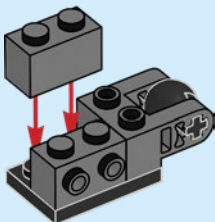



1x

47

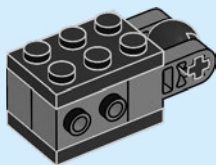

2x

48

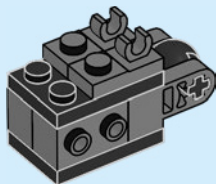



2x



1x

49

1

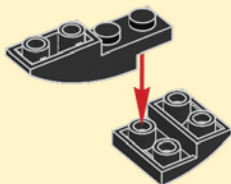

2

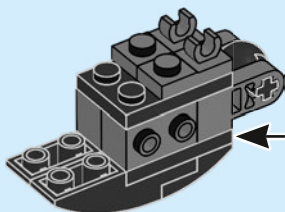
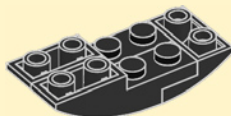

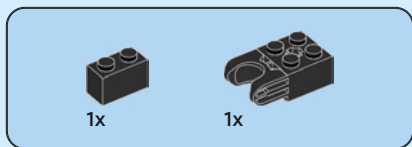

50

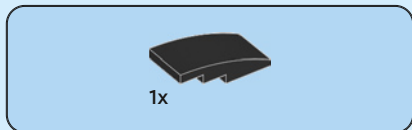
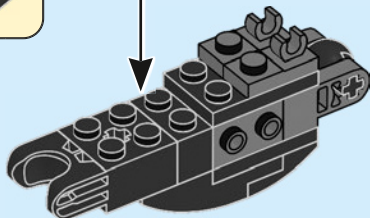
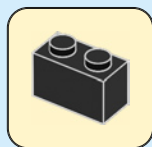

51

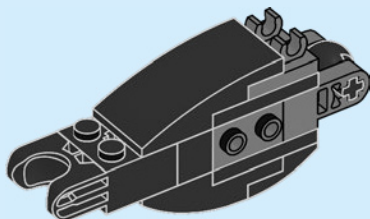



1x

52

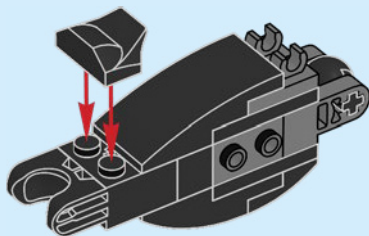

2x

53

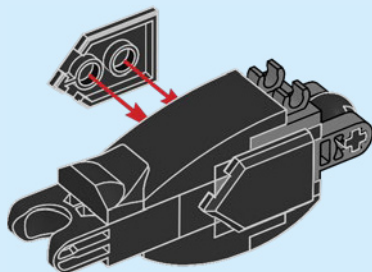

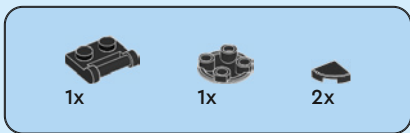

54

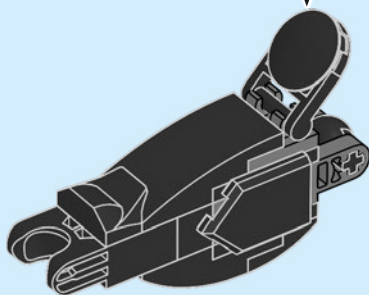
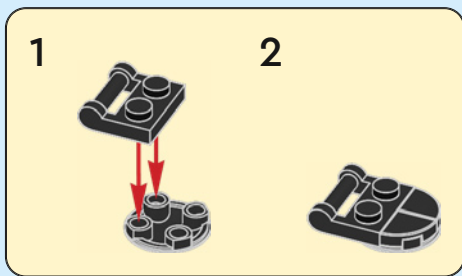

55

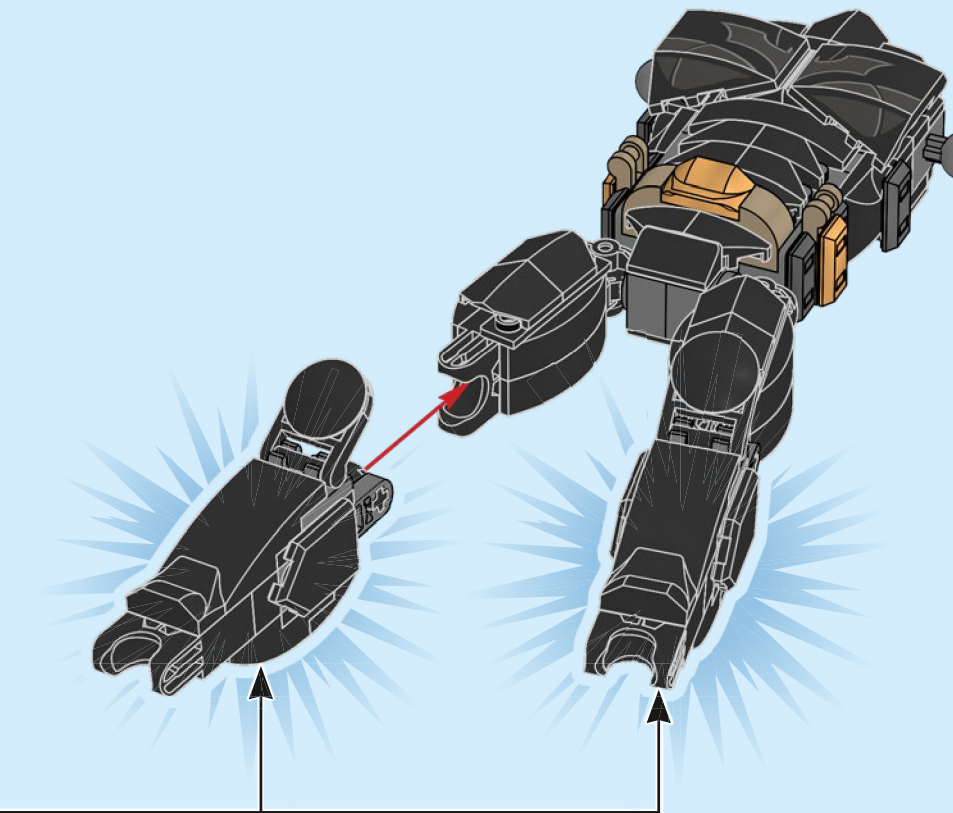



1x



1x

56

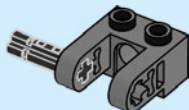

1x

57

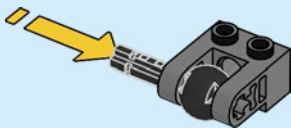

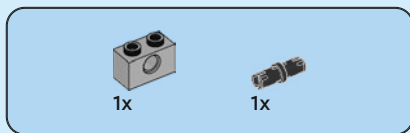

58

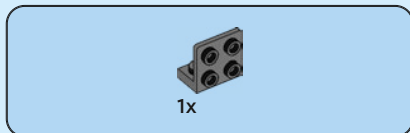
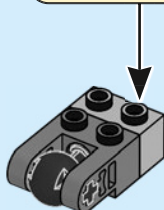
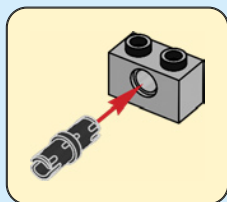

59

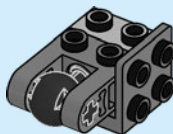

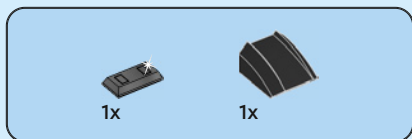

60

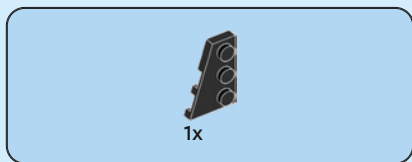
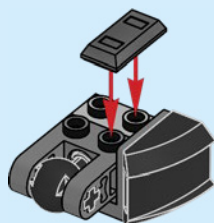

61

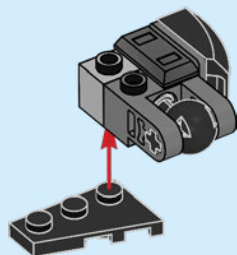

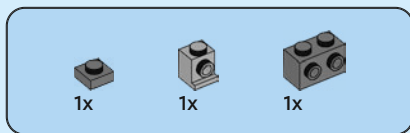

62

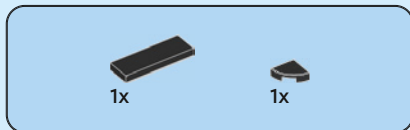
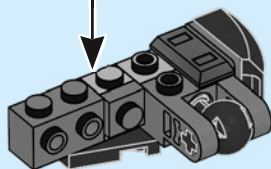
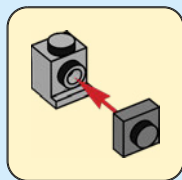

63

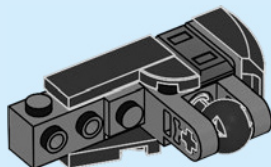



1x

64

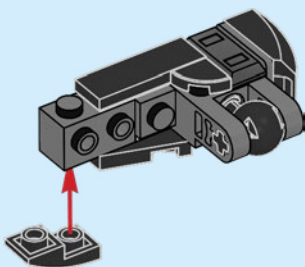

1x



1x

65

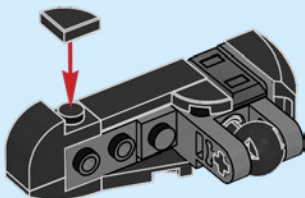



1x



1x

66

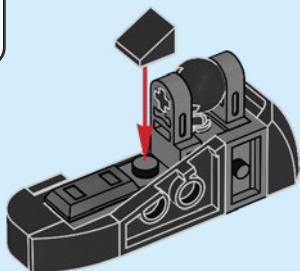

1x

67

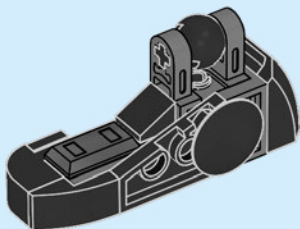



68

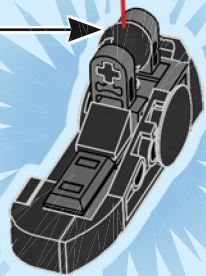
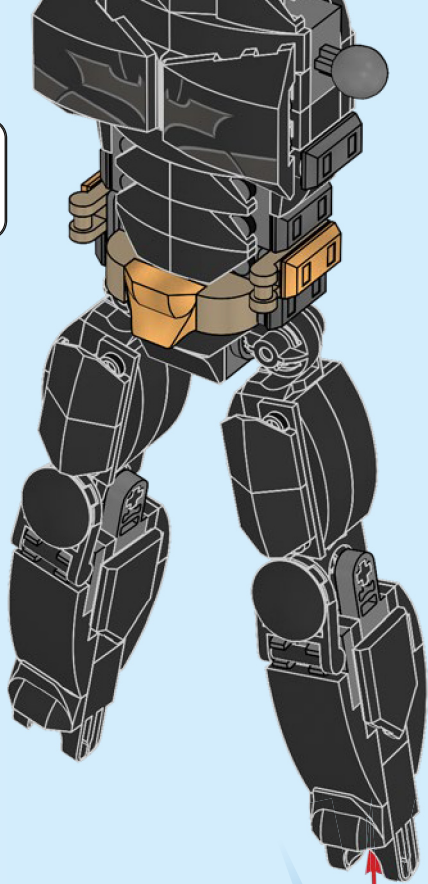



69

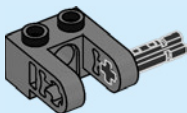

70

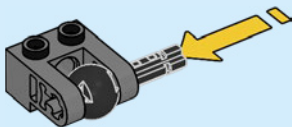



1x



1x

71

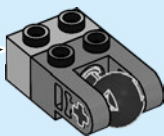
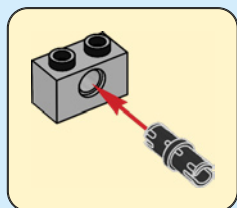

1x

72

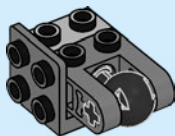

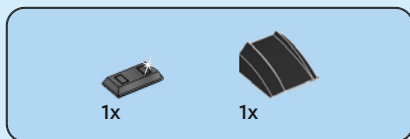

73

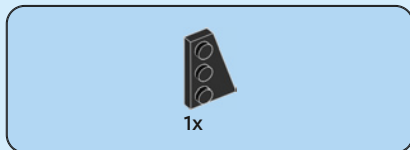
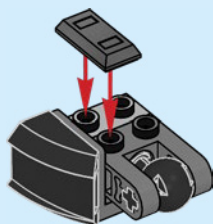

74

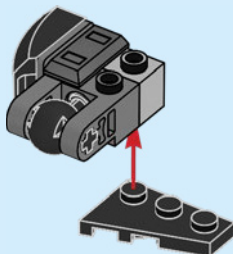

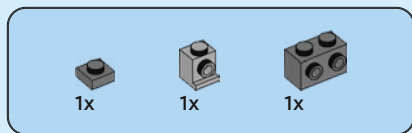

75

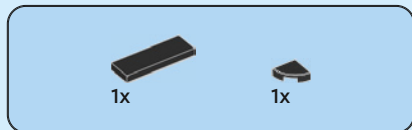
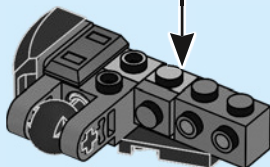
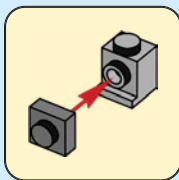

76

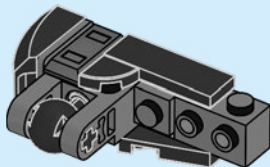



1x

77

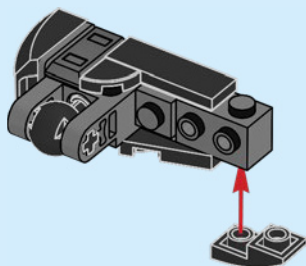

1x



1x

78

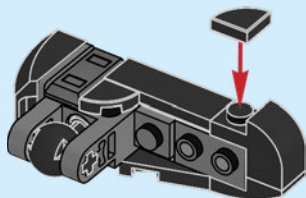



1x



1x

79

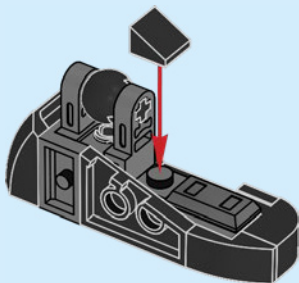

1x

80

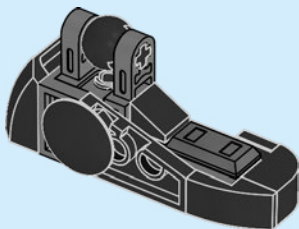

81

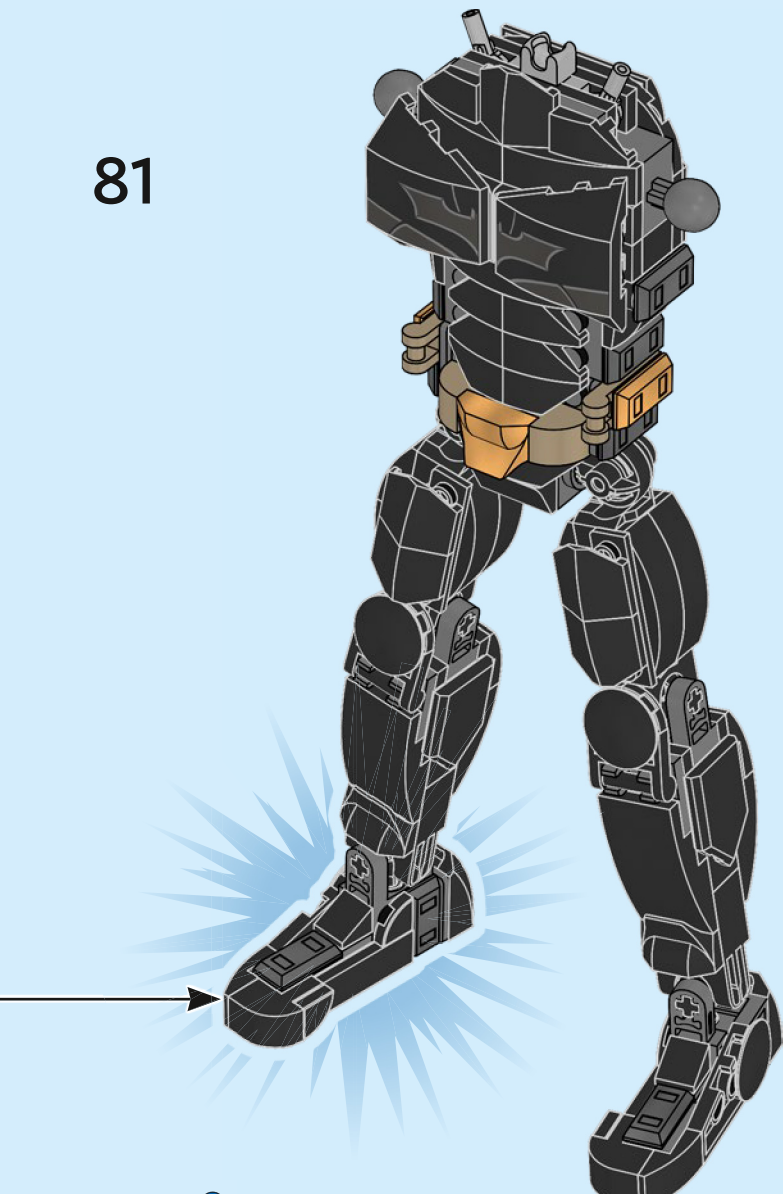



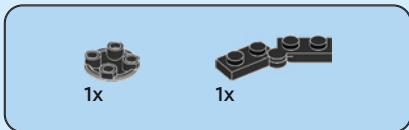

82

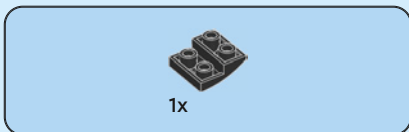
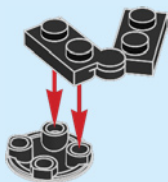

83





1x



1x

84

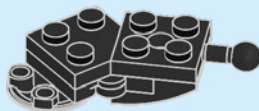

1x

85



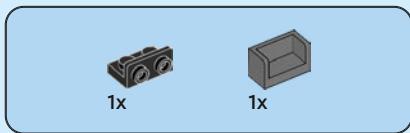

86

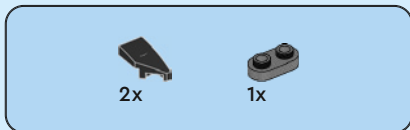
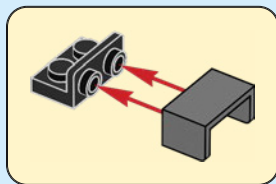

87

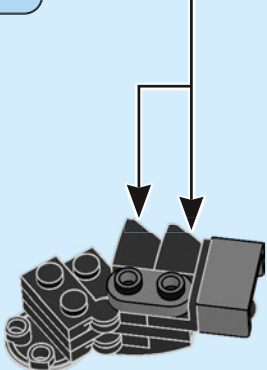
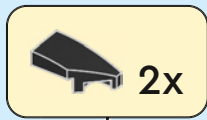



1x



1x

88

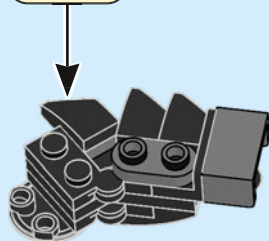
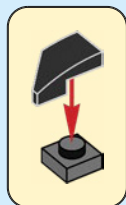

1x

89

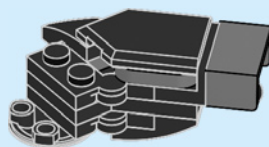

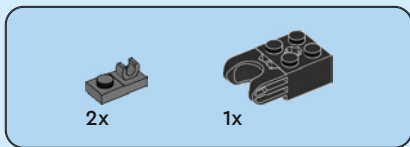

90

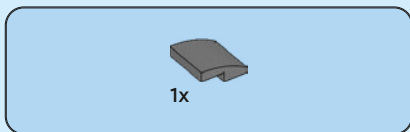
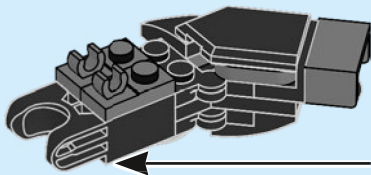
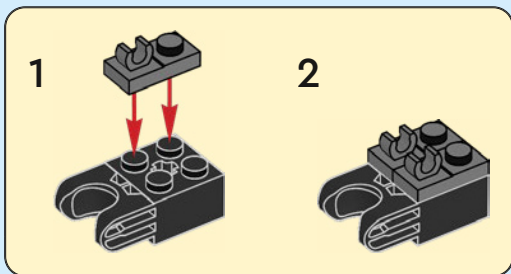

91

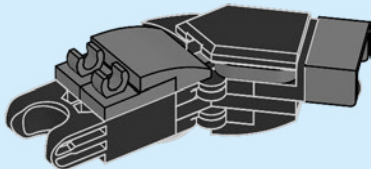

92

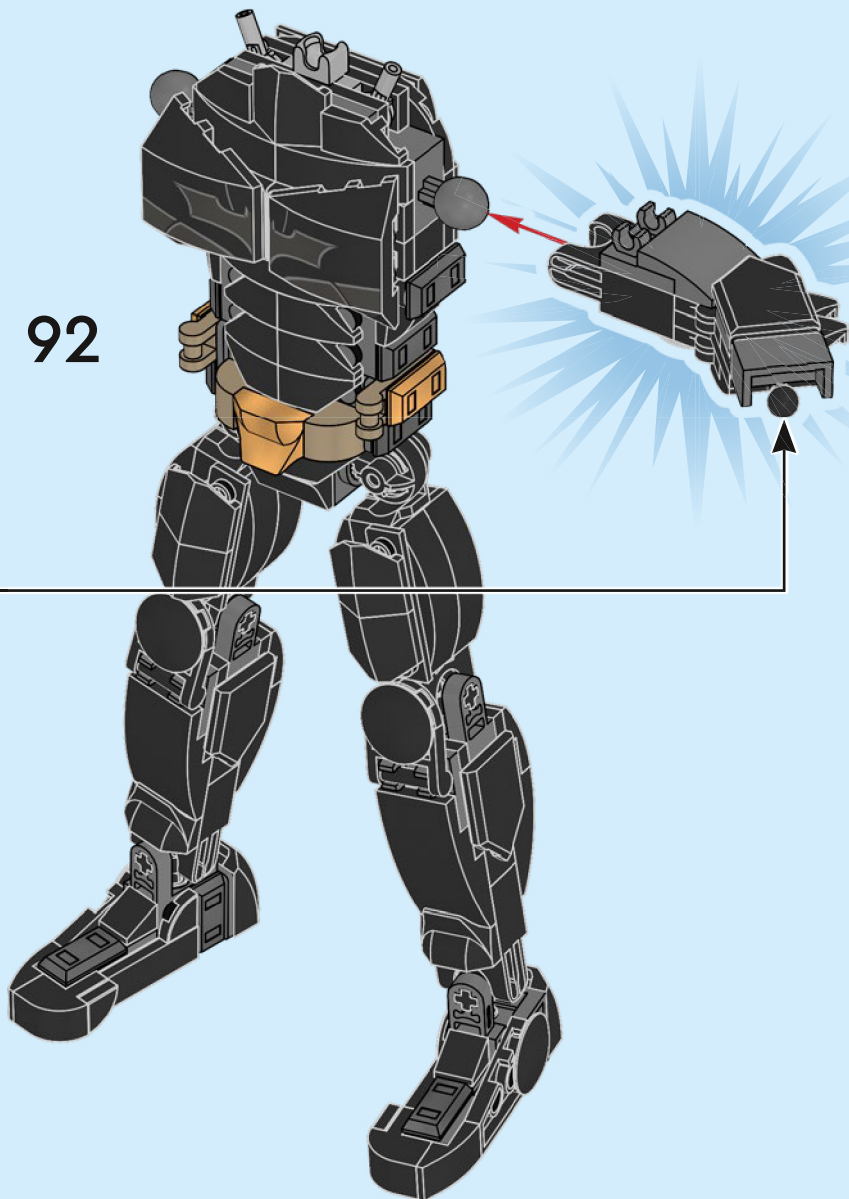

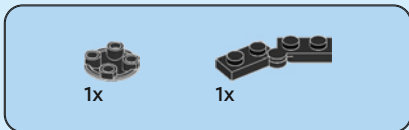

93

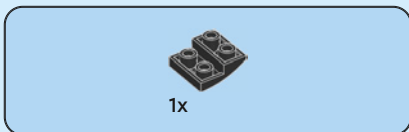
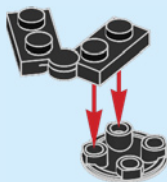

94





1x



1x

95



1x

96



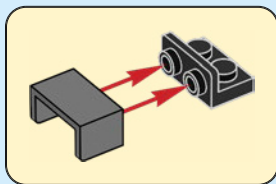
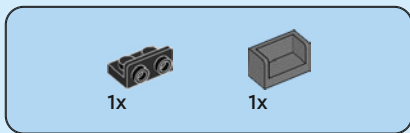

97

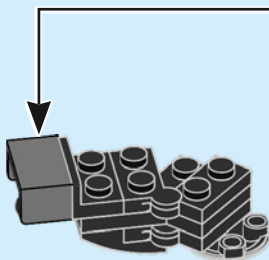

98

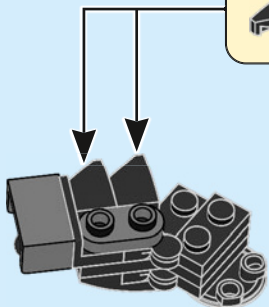



99

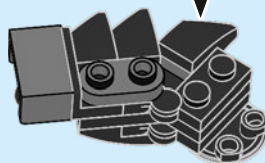
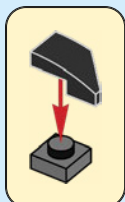

100

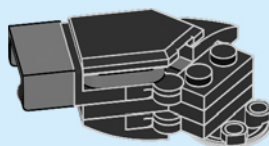

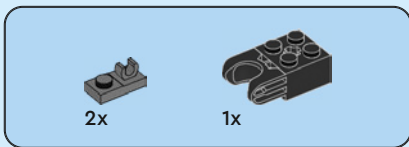

101

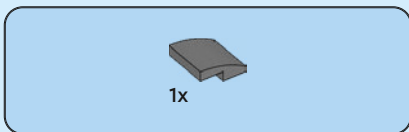
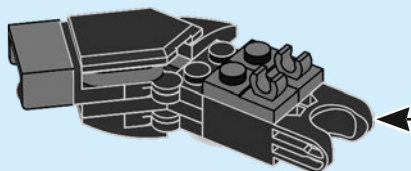
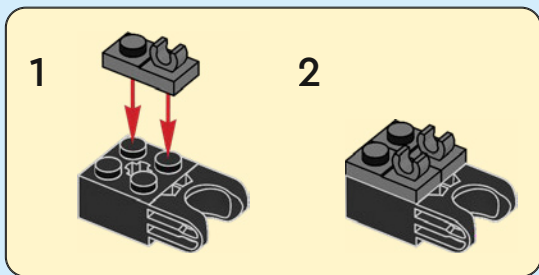

102

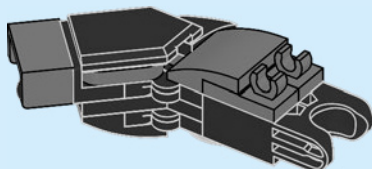

103

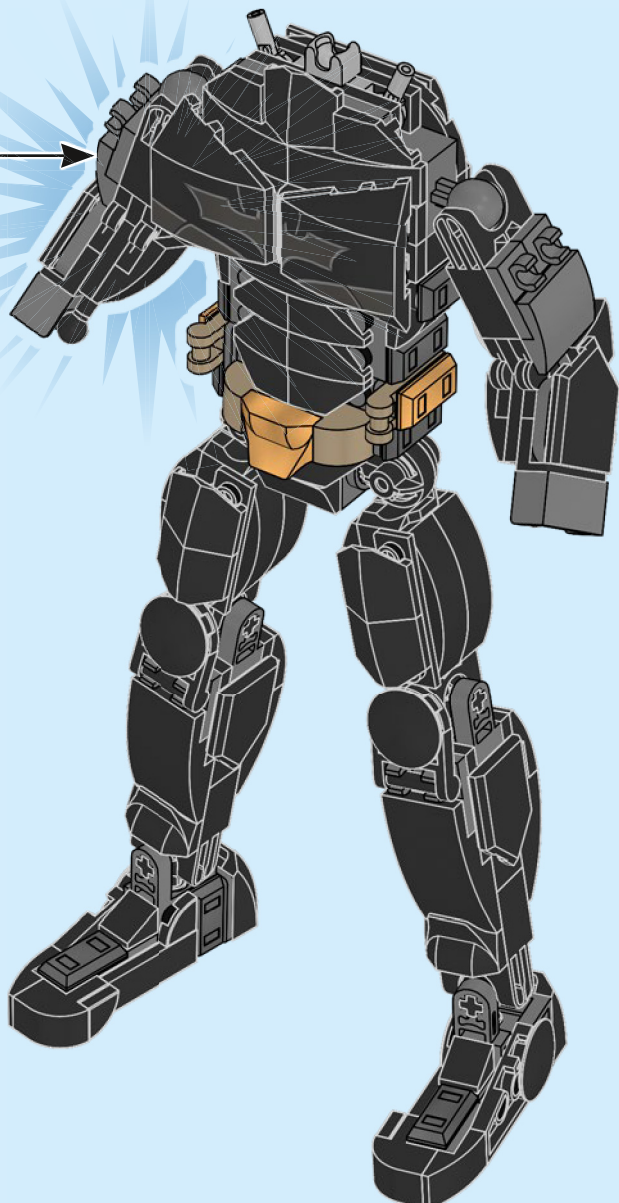

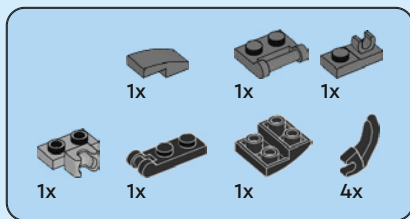

104

1

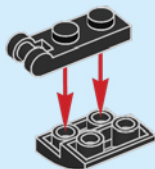

2



3

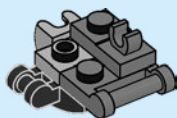

4

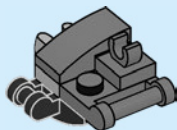

5

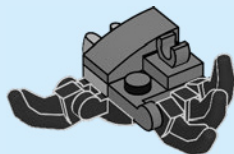

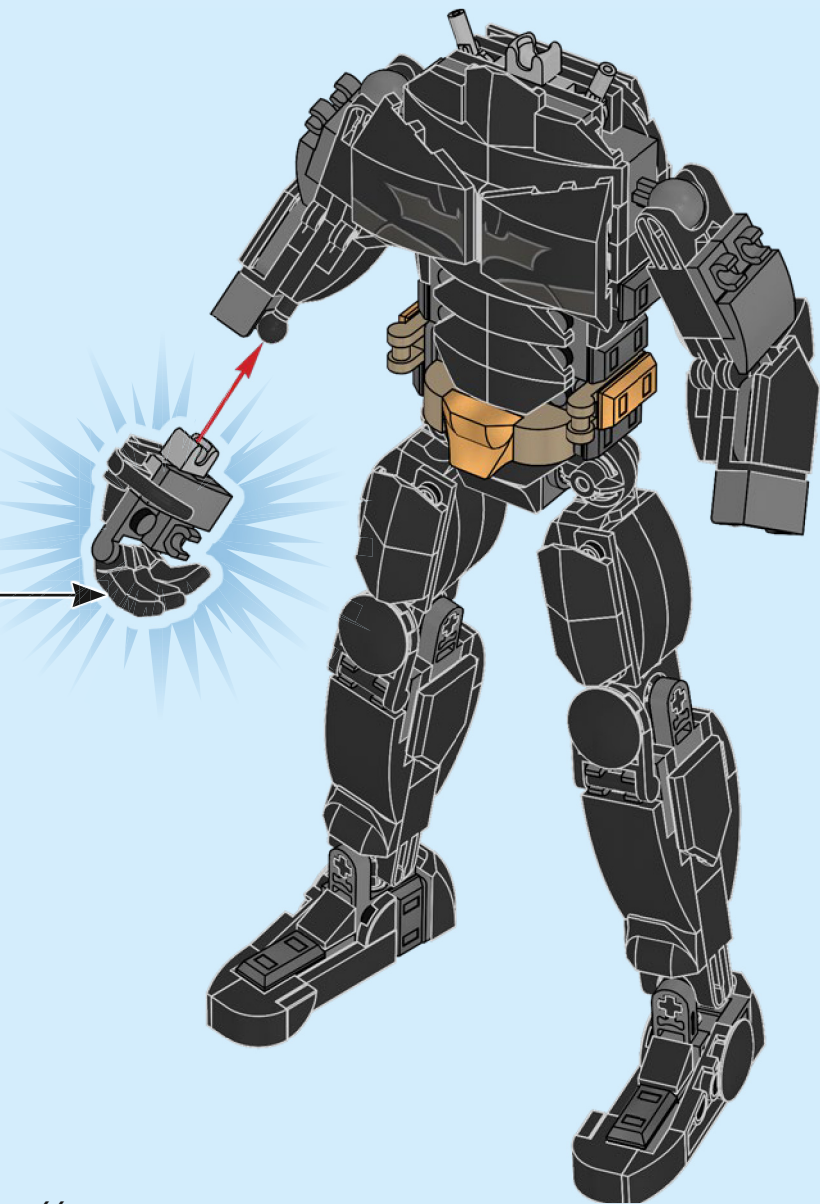

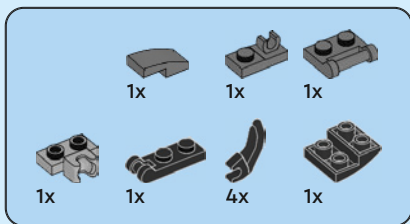

105

1

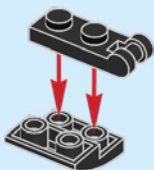

2

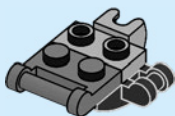

3

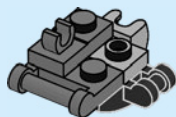

4

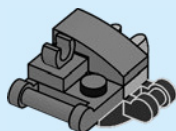

5

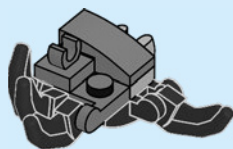

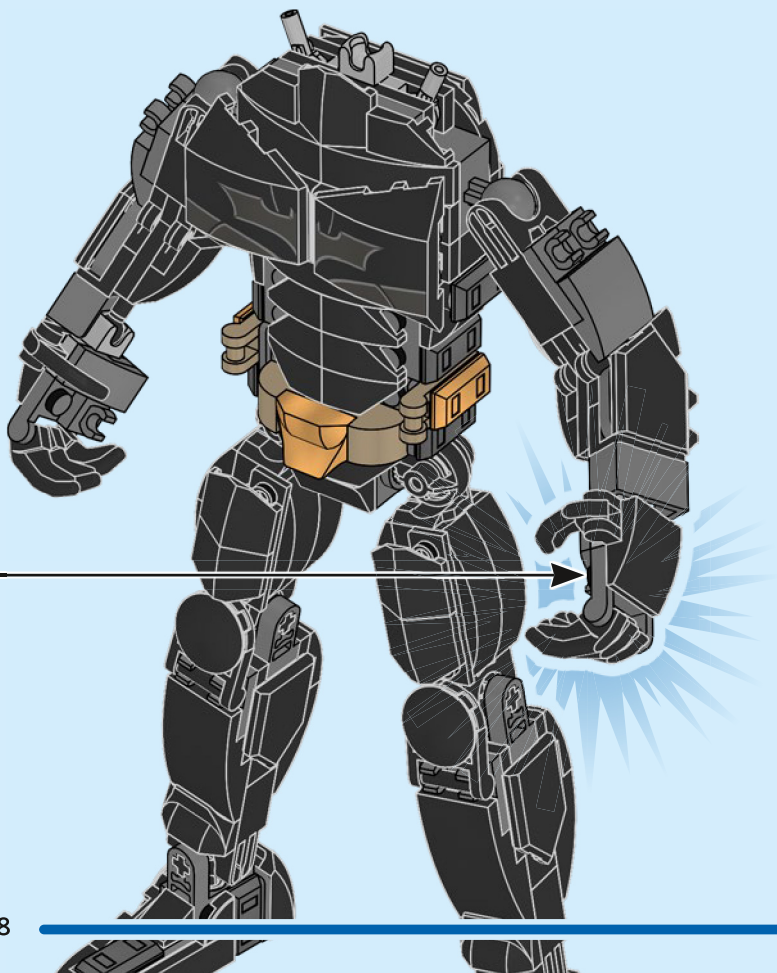



2x

106

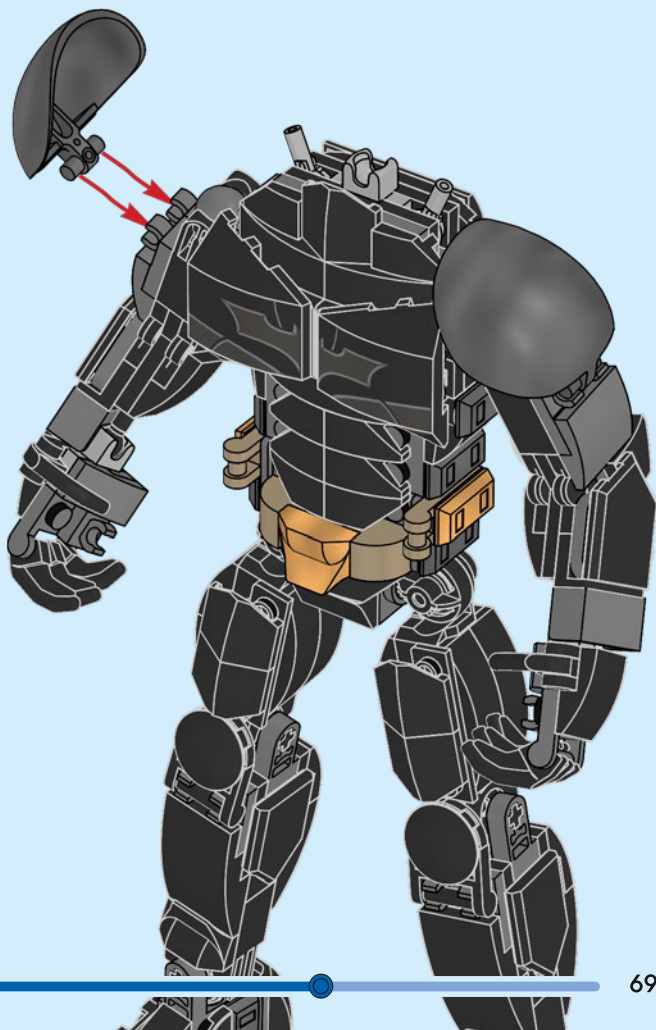

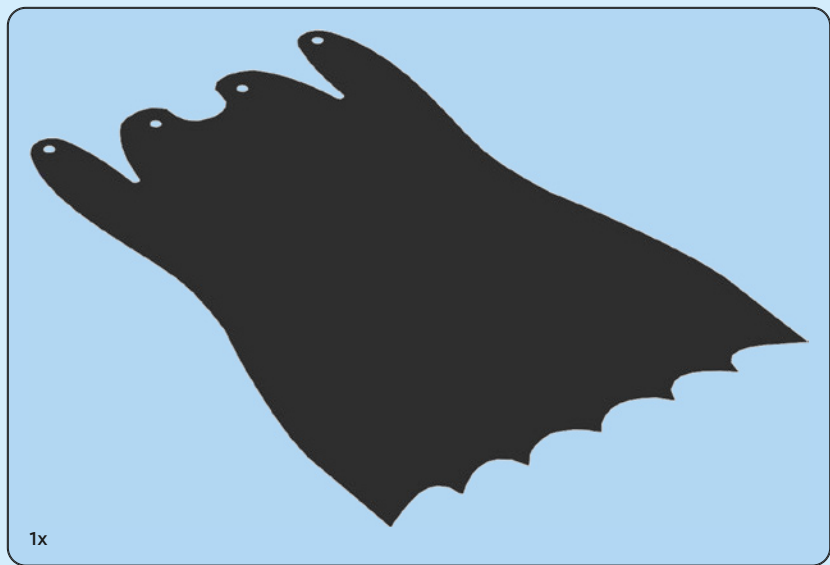

107

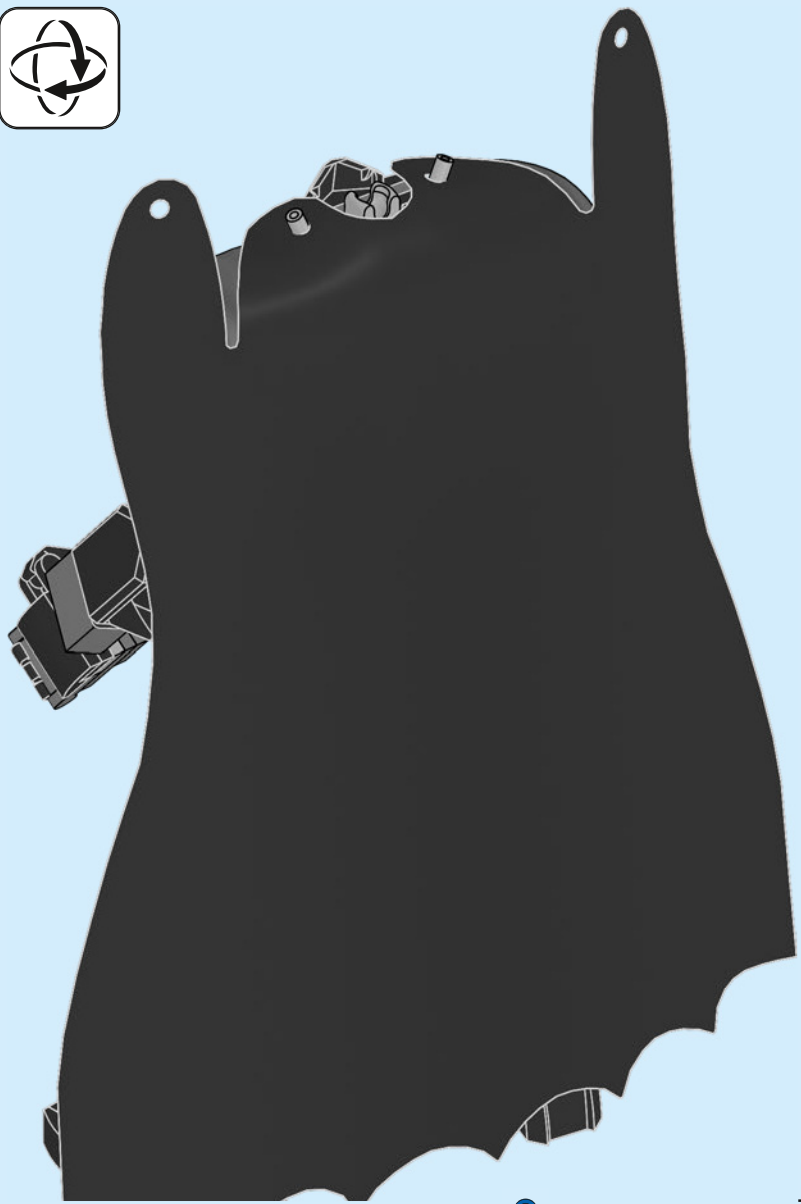

108

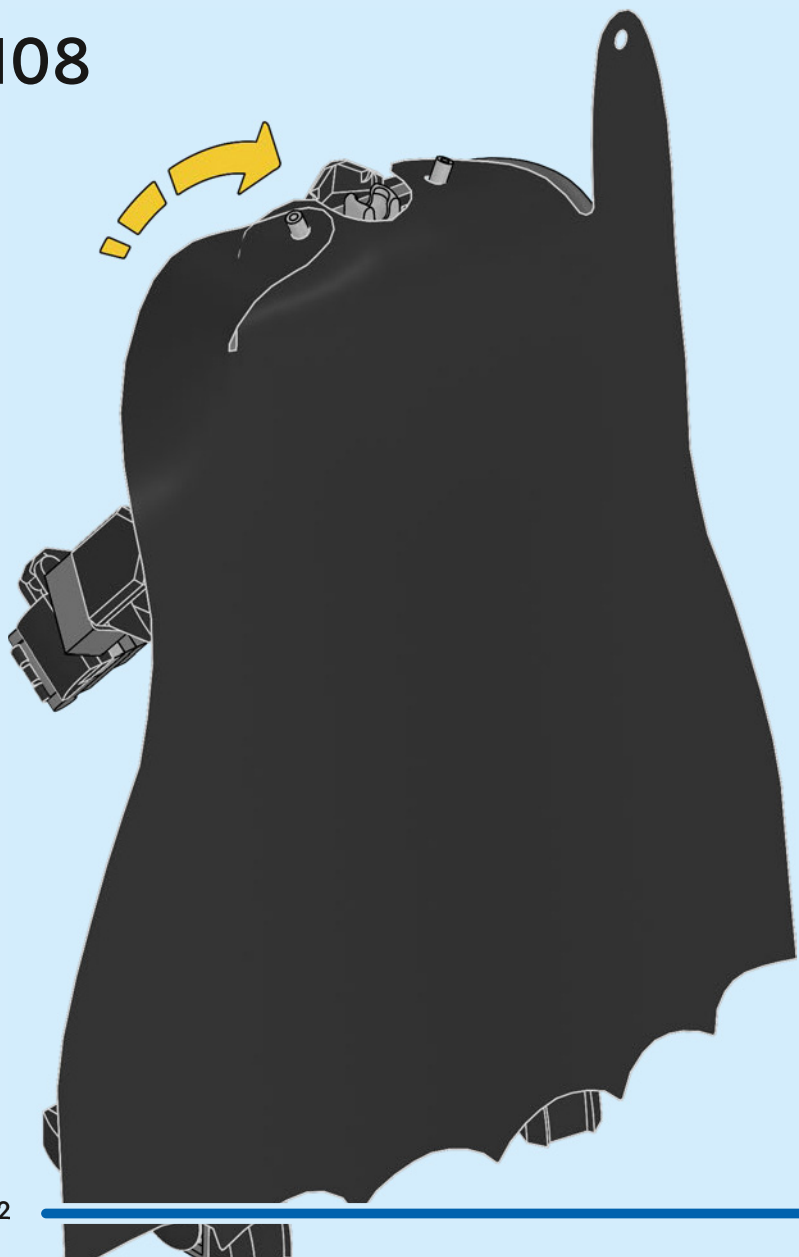

109



2x

110

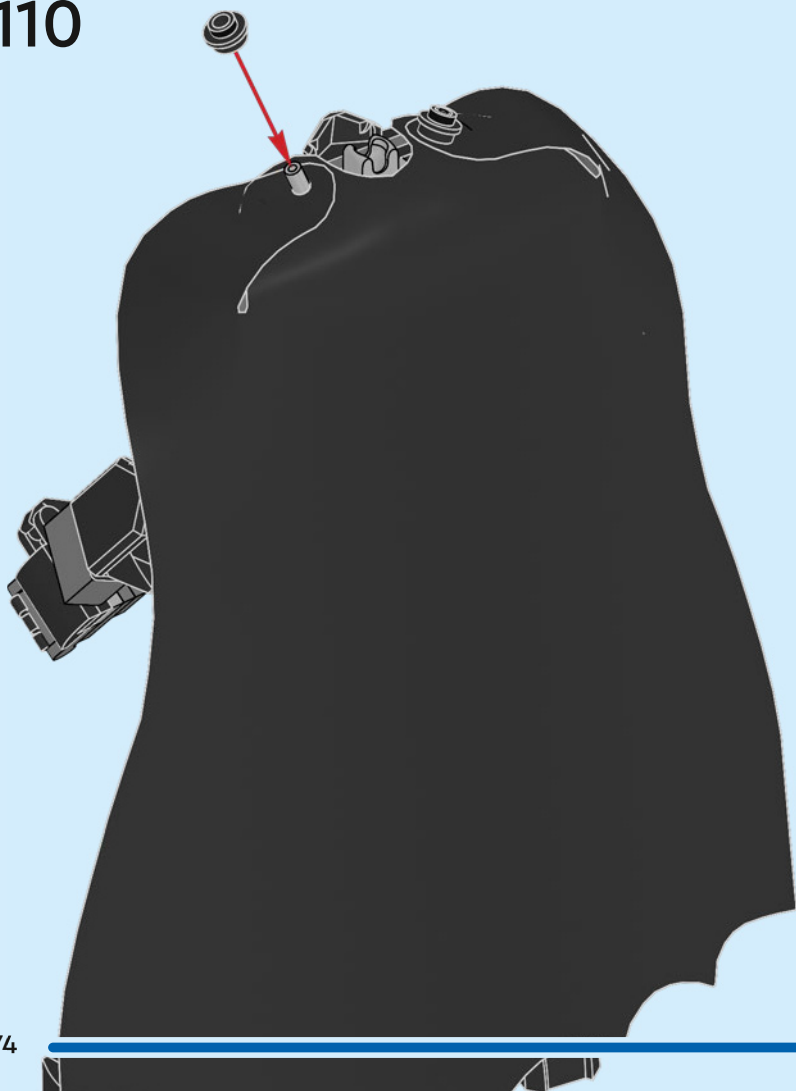

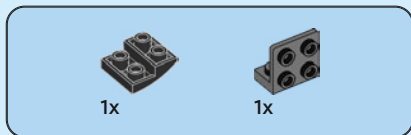

111

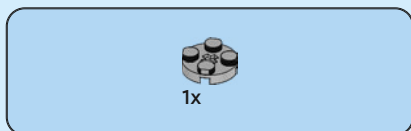
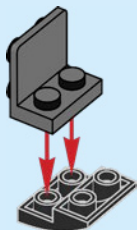

112





1x

113

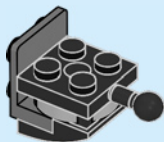

1x

114

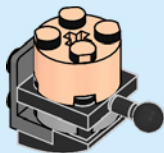



2x

115

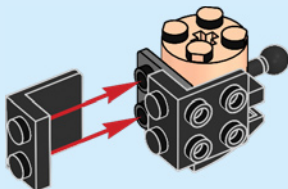

1x



2x

116

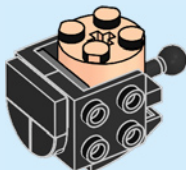



1x



1x

117

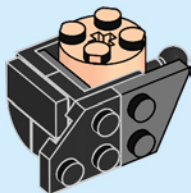

1x



1x

118

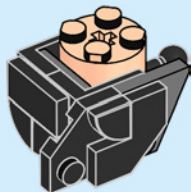



1x

119

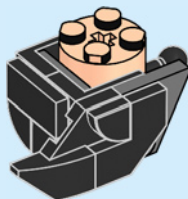

1x



1x

120

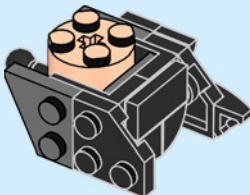



1x



1x

121

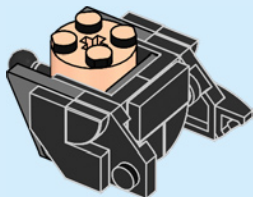

1x

122

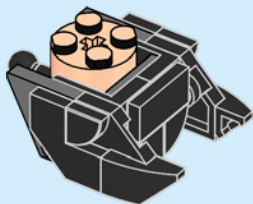

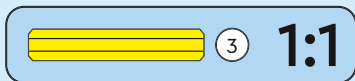
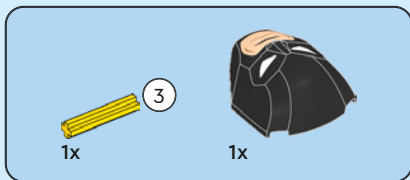

123

