



Disney · PIXAR
TOY
STORY



7590



1

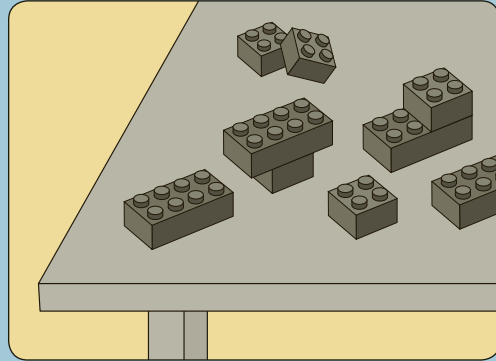
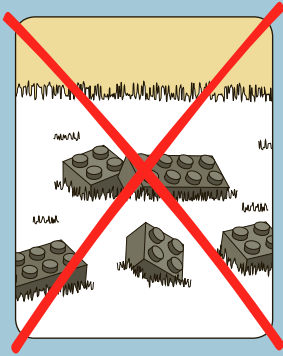

2

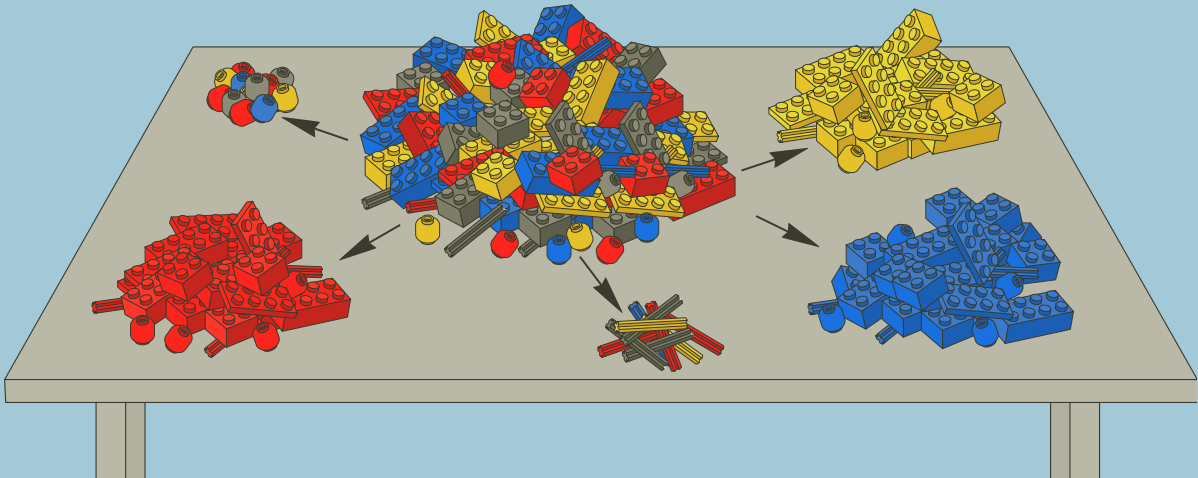

3

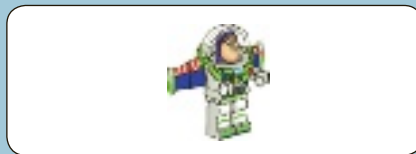
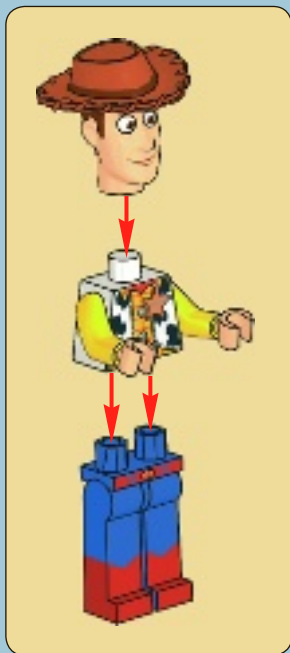

1

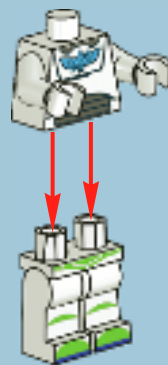

2

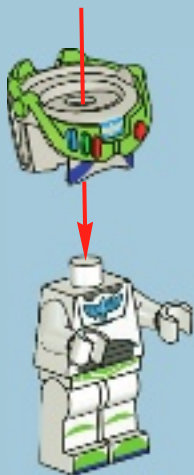

3

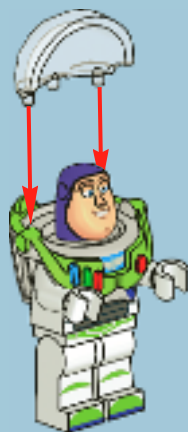

4

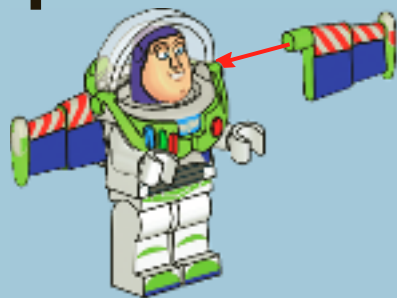



1



2



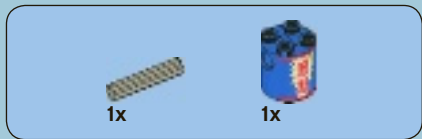

3

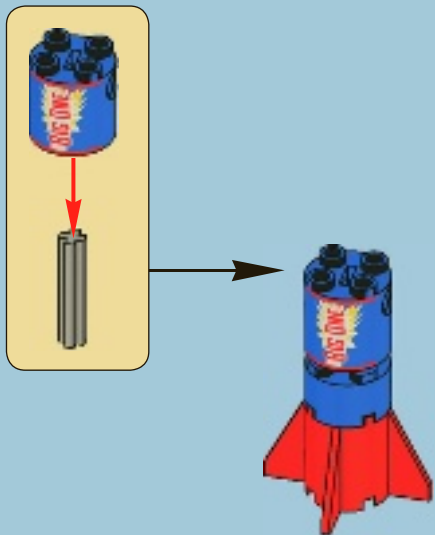

4





1x

5



1x

6

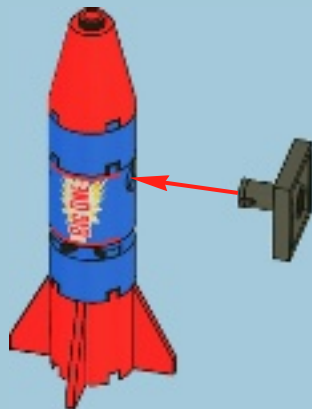



1

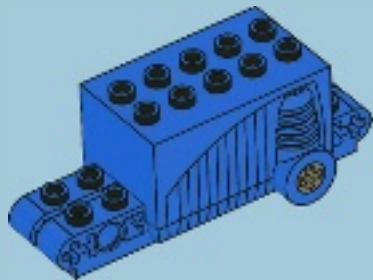



1x



1x



2x

2

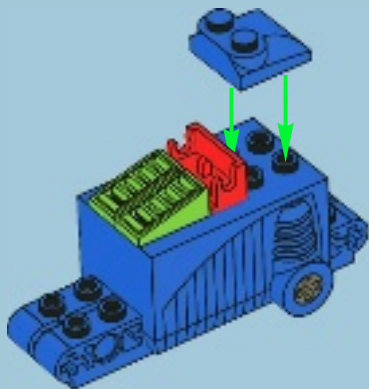

1x

3

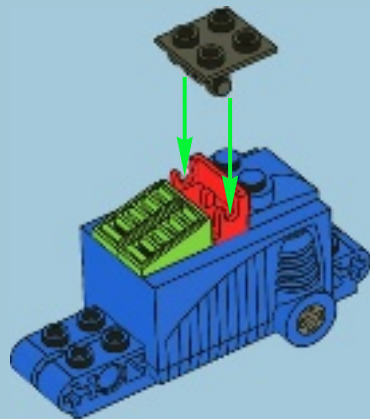

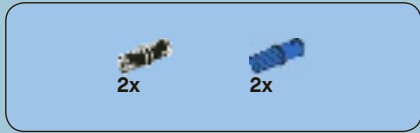

4

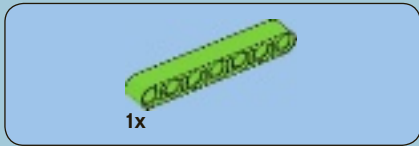
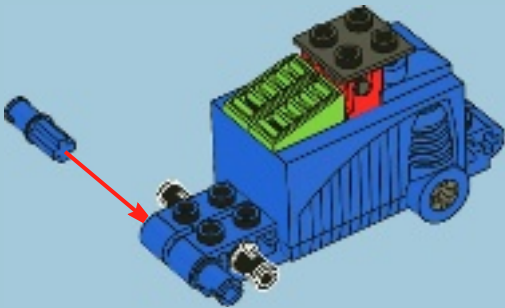

5

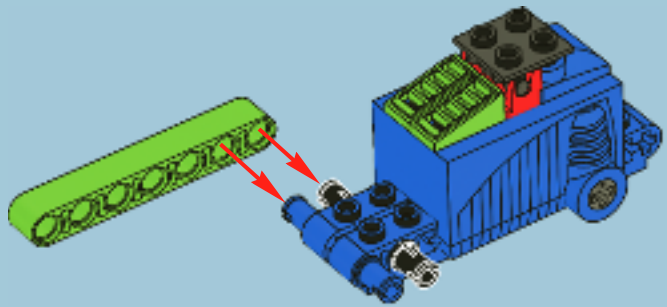



1x

6

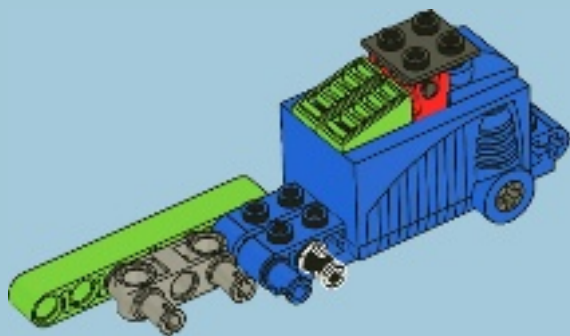



7

1



2

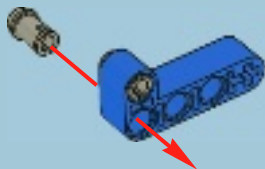

3



4

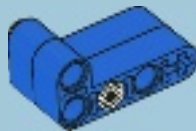

5

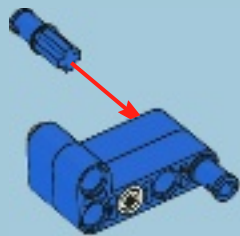

6

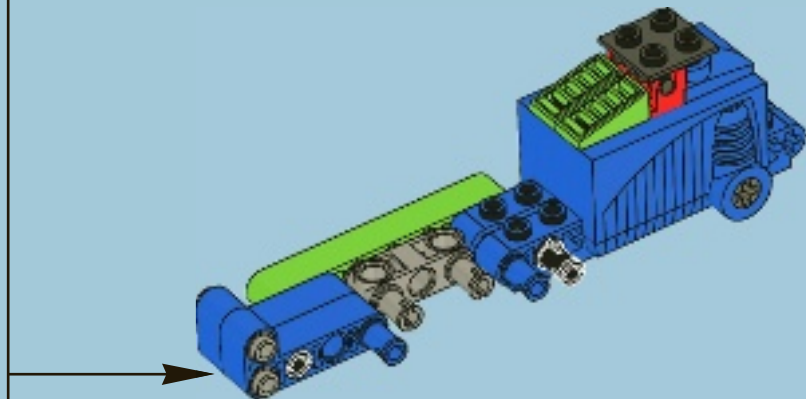
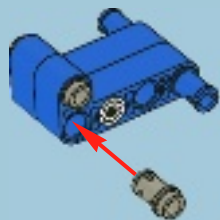



1x

8

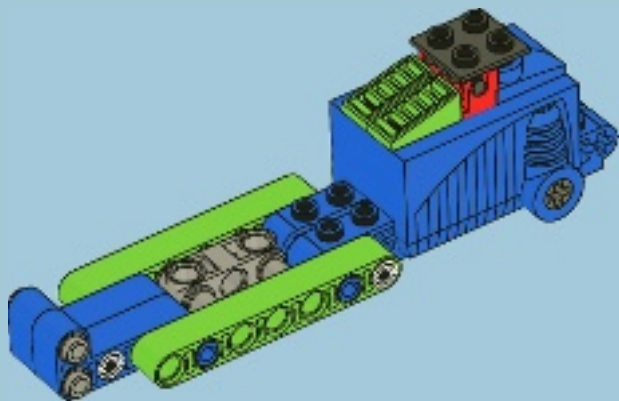

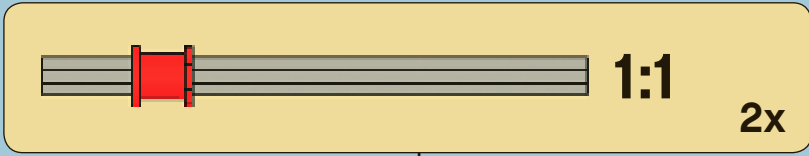
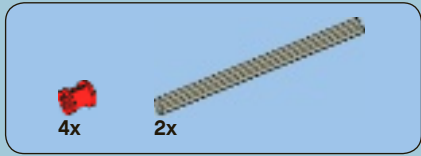

9

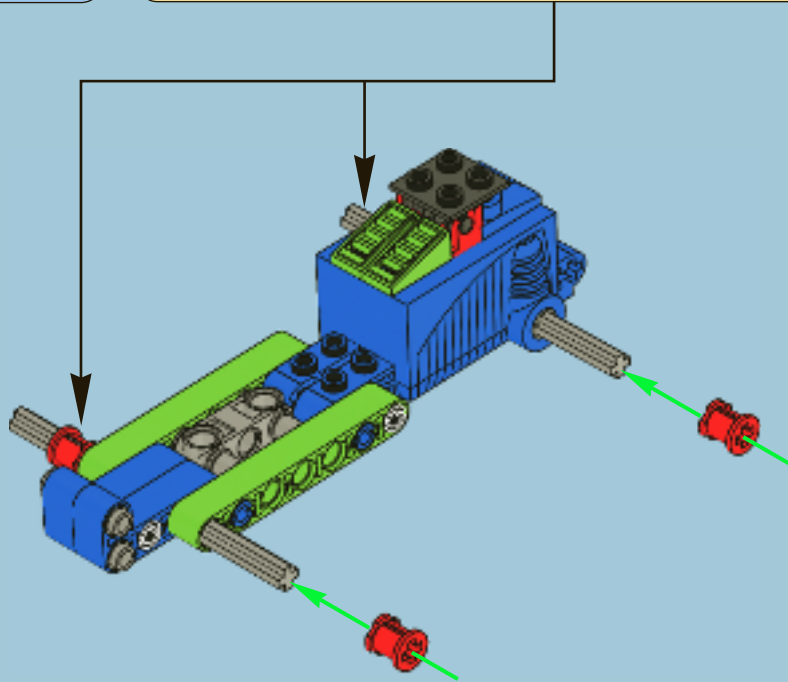

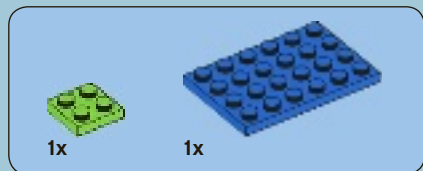

10

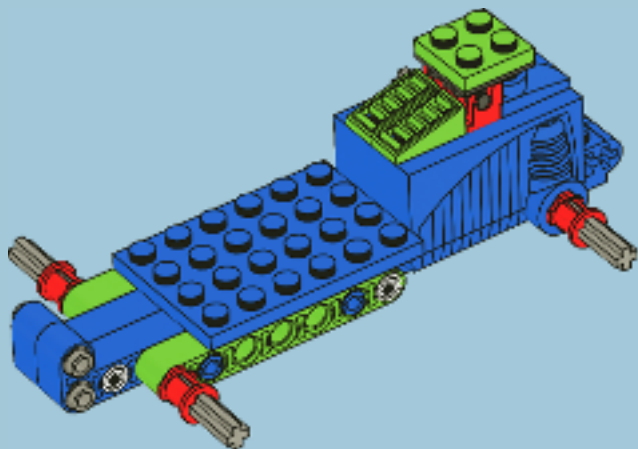



3x

11

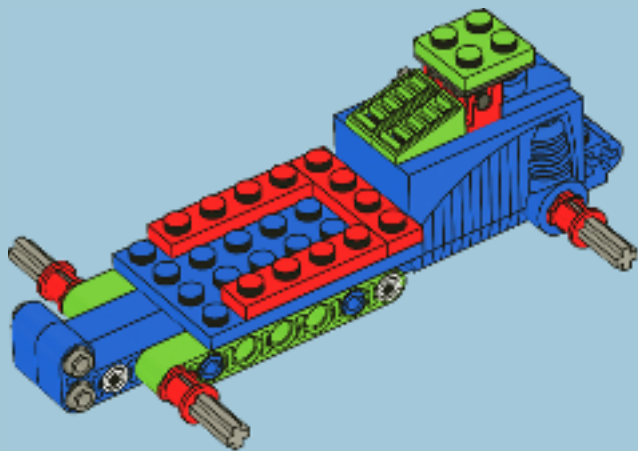



1x



2x

12

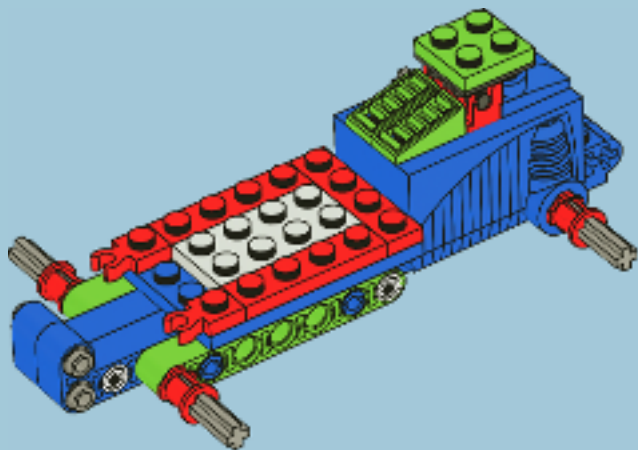



2x

13

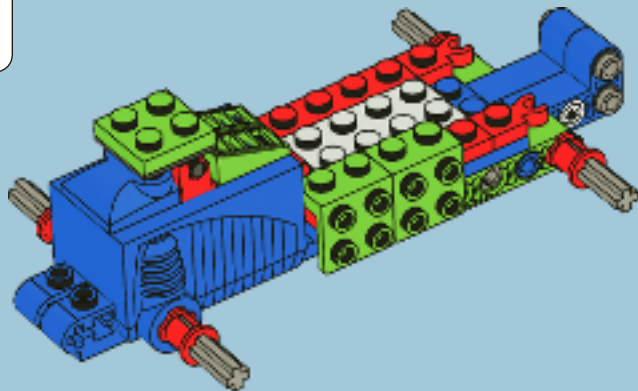



14

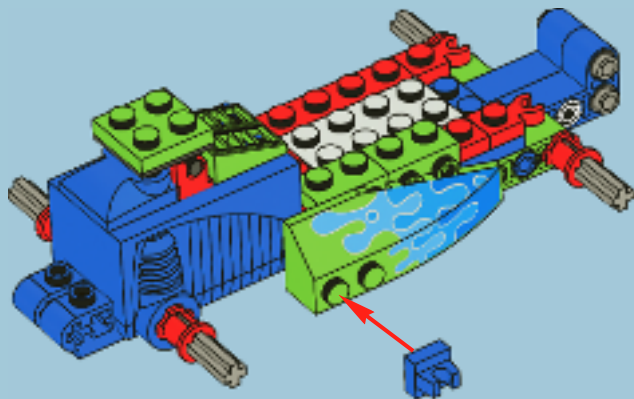

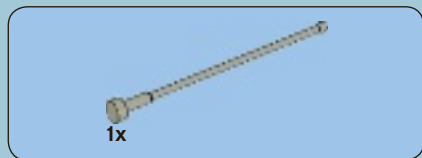

15

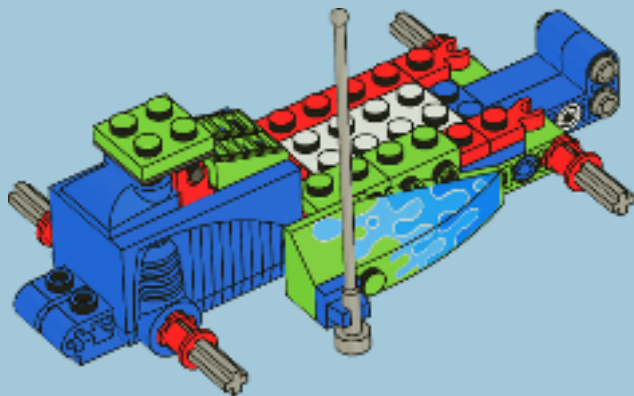



2x

16

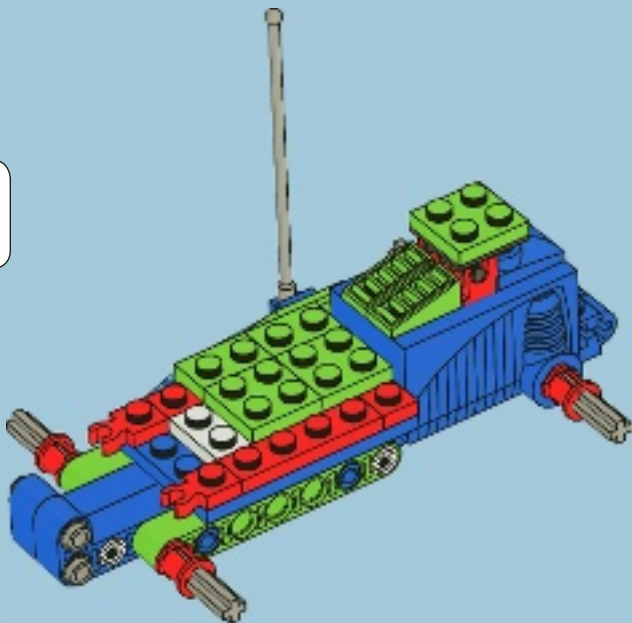



2x

17

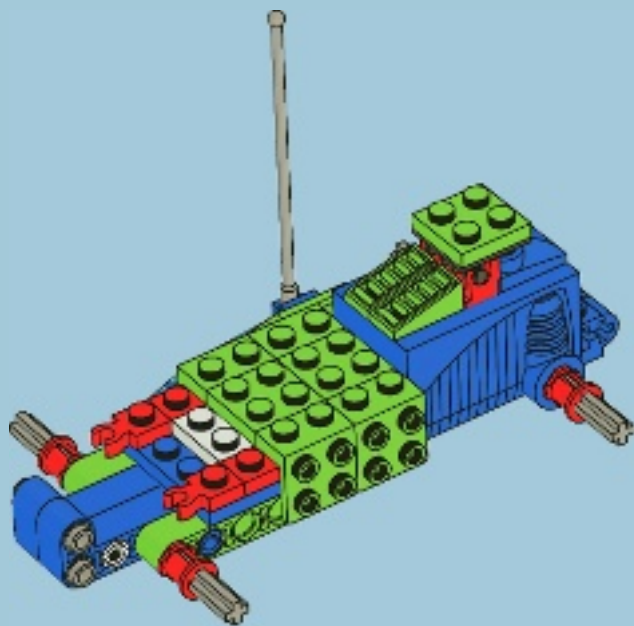



1x

18

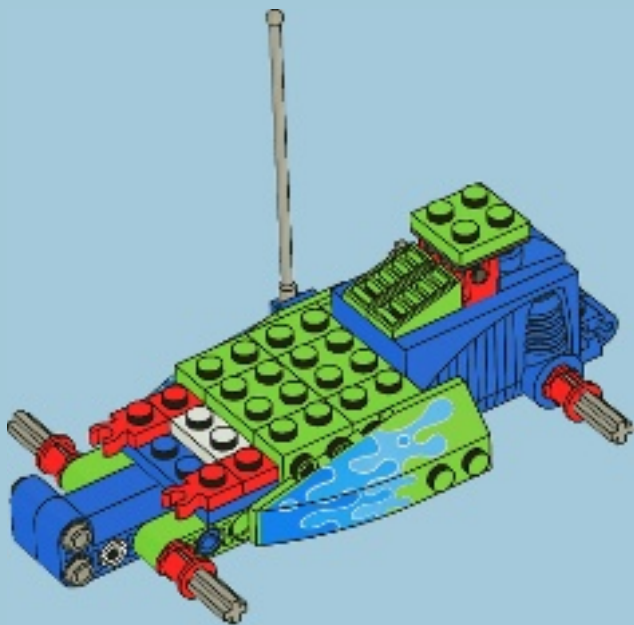



2x

19

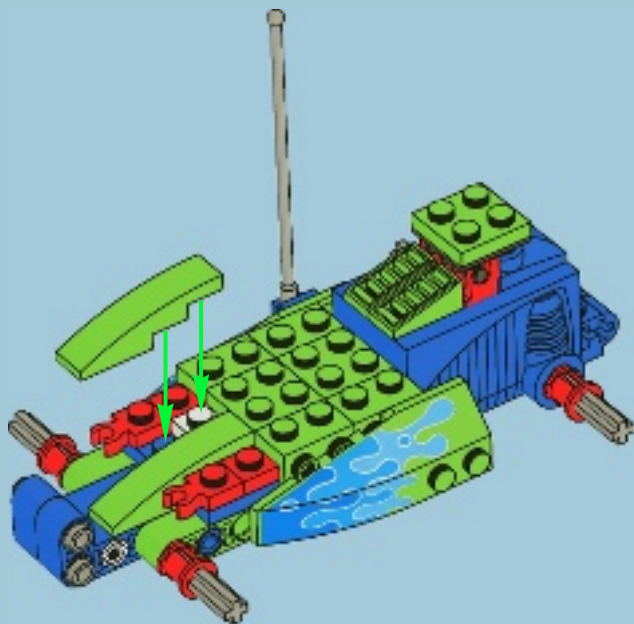



2x

20

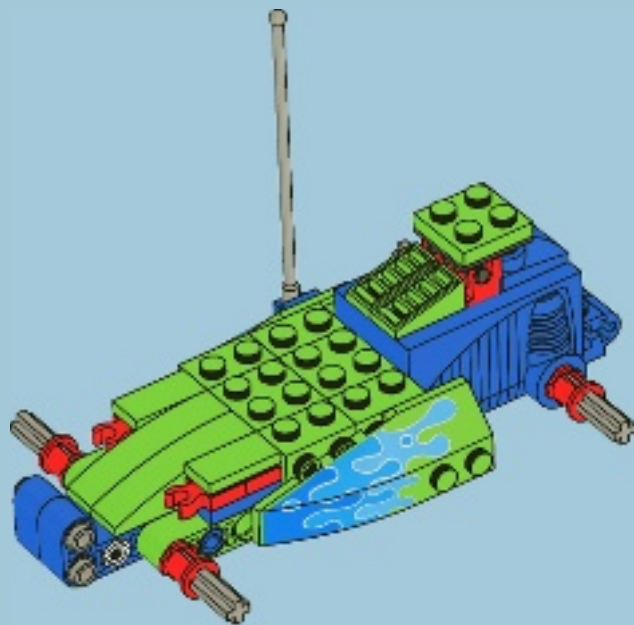

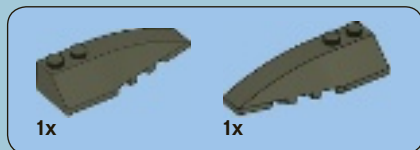

21

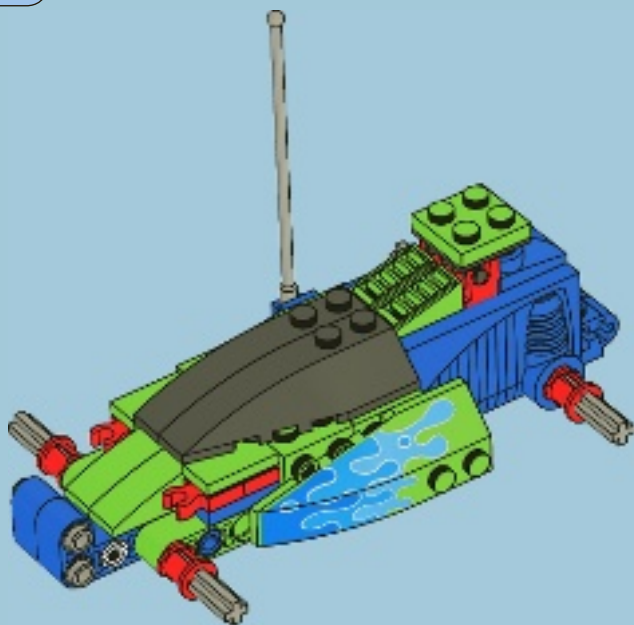



2x

22

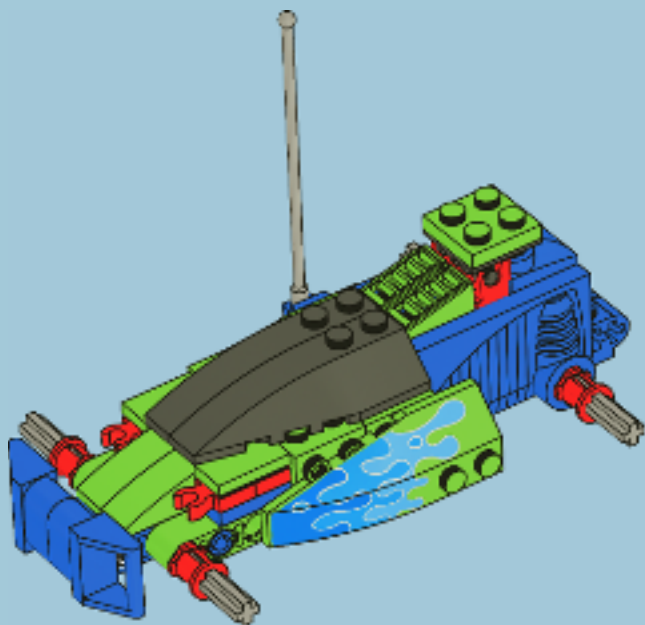



23

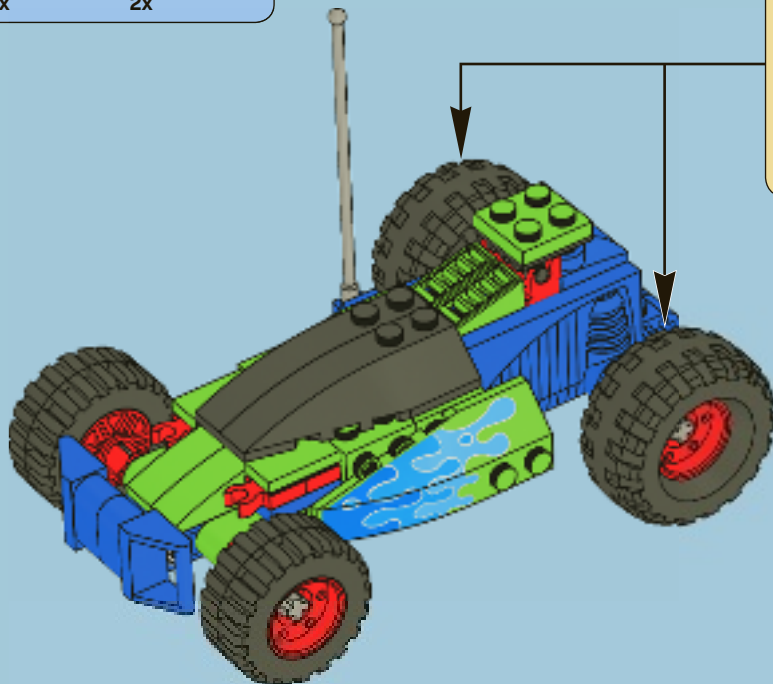



24

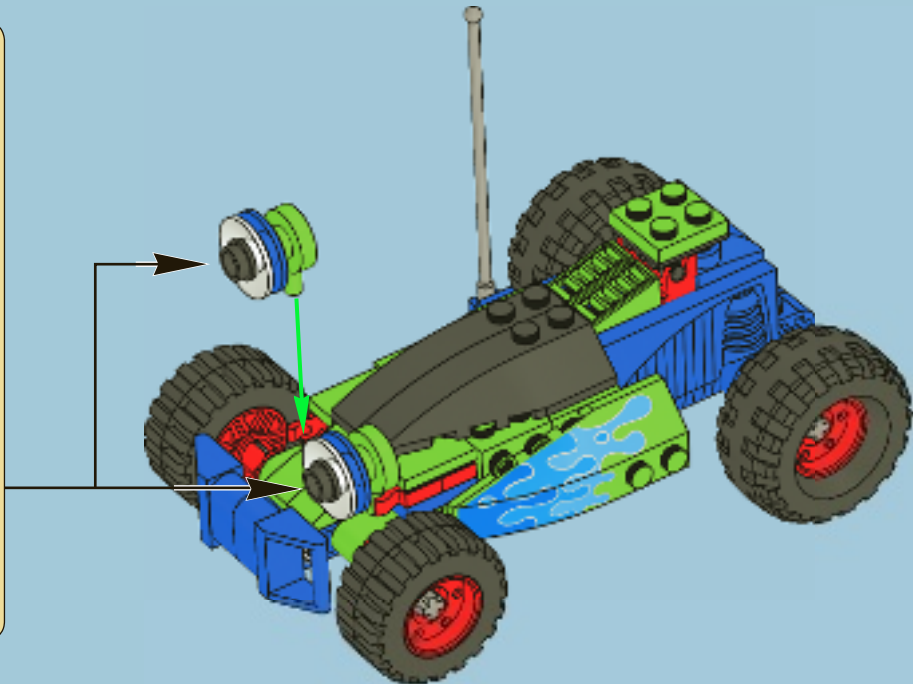
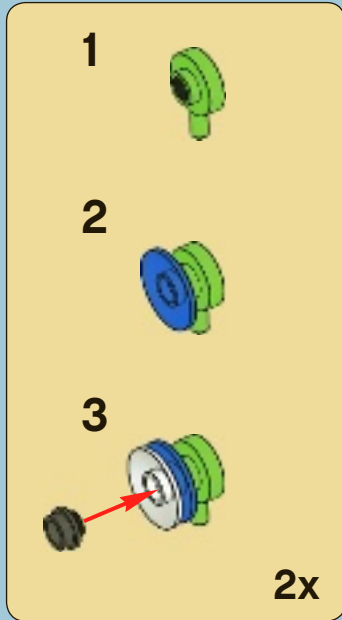

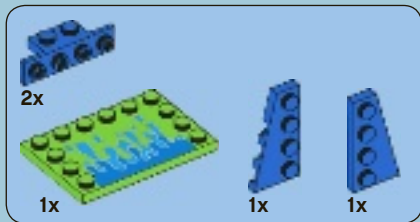

25

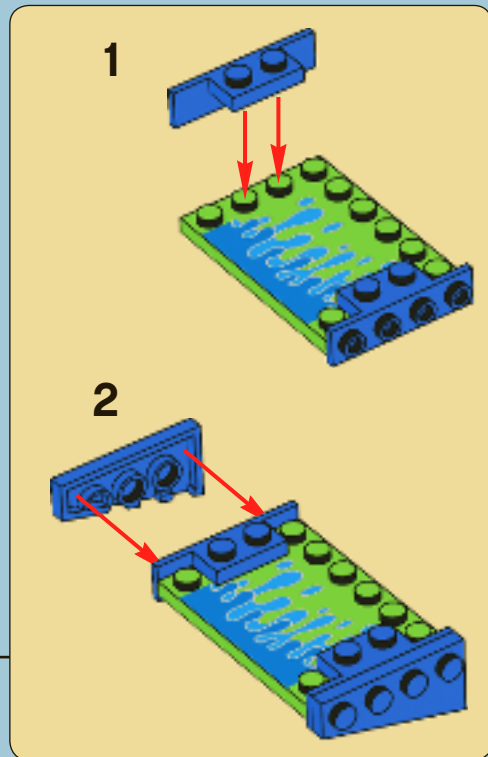
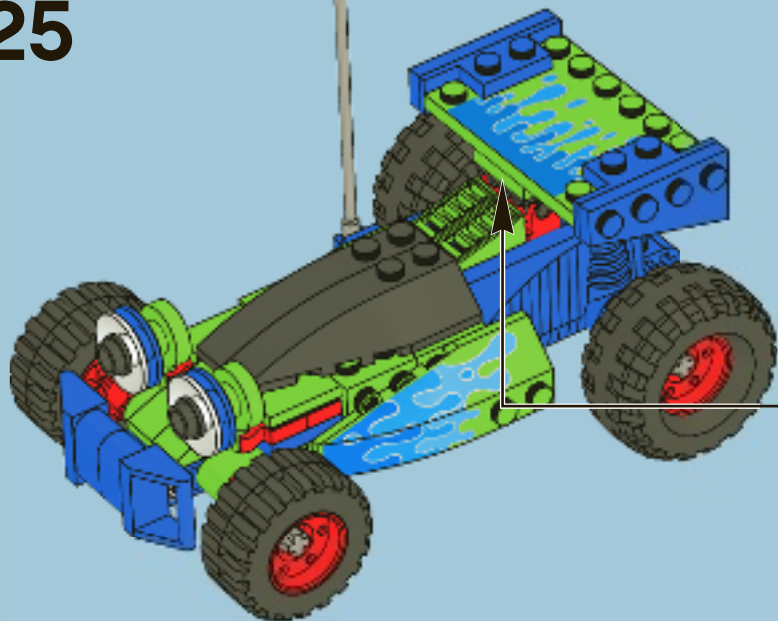

26

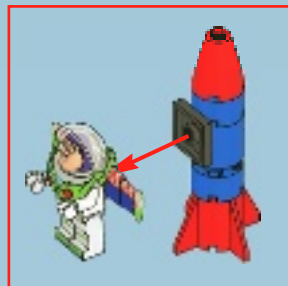



LEGO and the LEGO logo are trademarks of the LEGO group. ©2010 The LEGO group.
© Disney/Pixar.



7593



7594



7595





1x
30200



2x
47400



1x
4578907



1x
4578800



1x
4569506



1x
4565857



1x
4565852



1x
4562523



3x
371021



2x
408521



4x
4570807



1x
4570282



1x
393721



4x
4227155



1x
4528786



1x
4566144



1x
4569543



1x
4578592



4x
4206482



2x
4570283



1x
4496366



2x
4168114



2x
243223



1x
303223



1x
4570553



2x
4282744



1x
4160867



2x
614323



1x
4500613



1x
4225033



2x
4535768



1x
4251564



1x
4211815



4x
4211483



3x
4121715



1x
4160108



1x
4160130



1x
4258354



2x
614126



2x
4140670



2x
4506553



1x
4124096



2x
4540385



2x
4537927



1x
4566135



1x
4566139



2x
4500125



3x
4537937



2x
4569073



2x
4569507

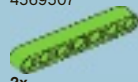

2x
4495928



1x
4578645



4x
4569452



Customer Service

Kundenservice

Service Consommateurs

Servicio Al Consumidor

www.lego.com/service or dial



00800 5346 5555 :



1-800-422-5346 :



FREE! GRATIS! GRATUIT!



club
MAGAZINE™

www.LEGOclub.com



00800 5346 5555*



1-866-534-6258 • 1-877-518-5346

US & Canada only

Canada seulement

* Freephone. Mobile charges may apply. * Numéro sans Frais. Des Frais peuvent s'appliquer avec les téléphones cellulaires. * Gebührenfrei, Kosten Für Anrufe aus Mobilfunknetzen können abweichen.
* Gratis telefoonnummer vanaf vaste lijn. * Det er ett gratis nummer, når du ringer fra Posttelefon. * Det är gratis, när du ringer från en Post telefon.



VISIT THE WORLD'S
BIGGEST LEGO® SHOP!

www.LEGOshop.com



WIN!

Go to www.nielsen.com/LEGO
to fill out a survey for a chance
to win a cool LEGO® Product.

No purchase necessary.

Open to all residents where not prohibited.



www.LEGO.com



www.nielsen.com/LEGO

GEWINNE!

Nimm an der Umfrage auf www.nielsen.com/LEGO teil und hab die Chance ein cooles LEGO® Produkt zu gewinnen!

Die Teilnahme am Gewinnspiel führt zu keinerlei Kaufverpflichtungen. Teilnahme in allen nicht ausgeschlossenen Ländern möglich.

WIN!

Ga naar www.nielsen.com/LEGO, vul een enquêteformulier in en maak kans op een cool LEGO® product.

Geen aankoopverplichting. Iedereen mag deelnemen, uitgezonderd ingezetenden van landen waar een enquêteverbod geldt.

GAGNE!

Visite www.nielsen.com/LEGO pour répondre à un questionnaire et avoir une chance de gagner un produit LEGO® très cool!

Aucune obligation d'achat. Ouvert à tous les résidents des pays autorisés.

当てよう!

www.nielsen.com/LEGO にアクセスして、アンケートにご記入ください。当選者にはレゴ®製品を差し上げます。

お買い上げの必要はありません。禁止されていない限り、すべての皆様にご利用いただけます。