



STAR WARS

75310



Disney





Check for compatibility
Kompatibilität prüfen
Vérifier la compatibilité
Control·la la compatibilitat
Comprueba tu compatibilidad
Verificar a compatibilidade
Ellenörizd a kompatibilitást
Pärbaudít saderibu
检查兼容性

[LEGO.com/devicecheck](https://www.lego.com/devicecheck)

乐高®拼搭指引

 LEGO® Building Instructions



Apple and the Apple logo are trademarks of Apple Inc.
Google Play and the Google Play logo are trademarks of Google LLC.
Tencent and the Tencent logo are trademarks of Tencent Inc.

1

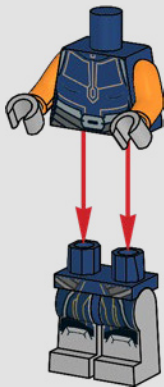

2



3

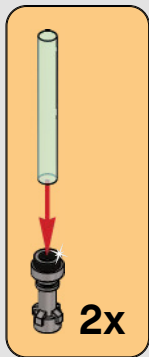

1

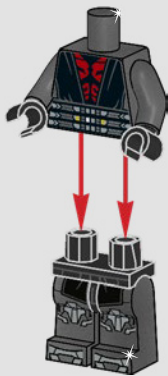

2



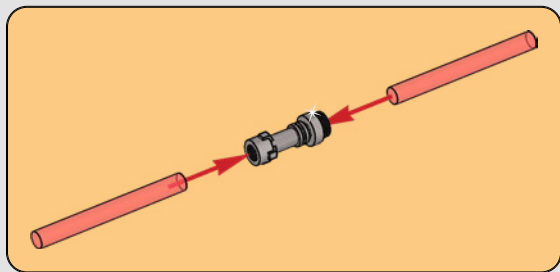

3

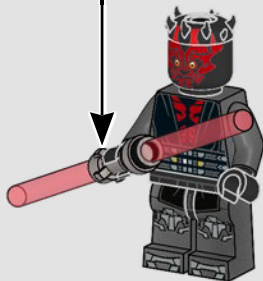



1x

1

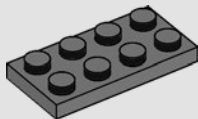

8

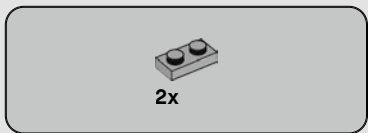

2

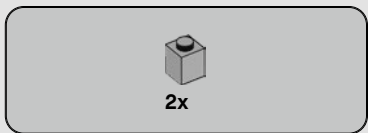
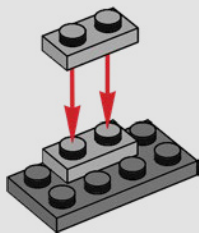

3

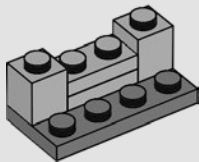



1x

4

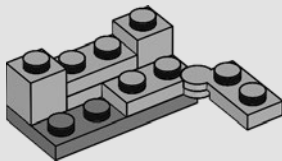

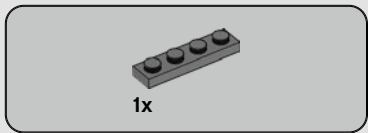

5

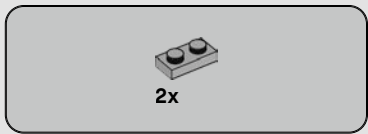
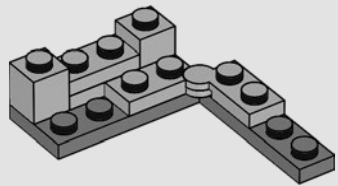

6

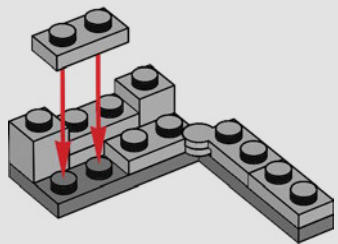

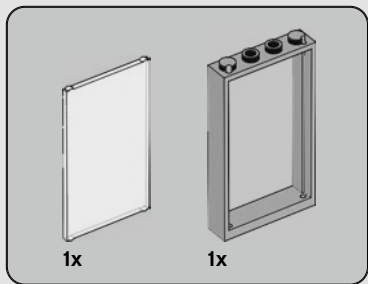

7

1

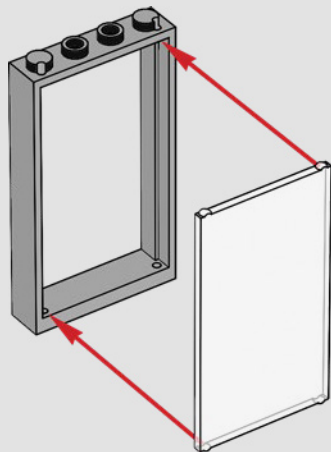

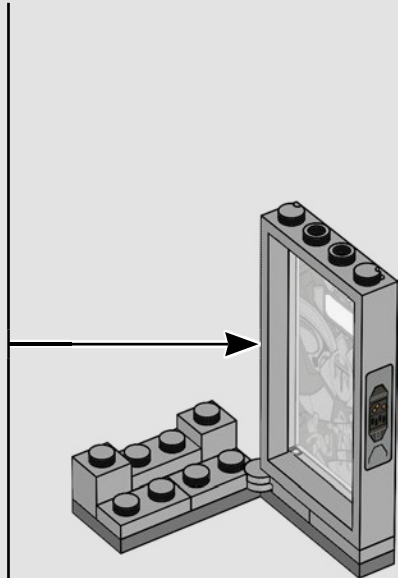
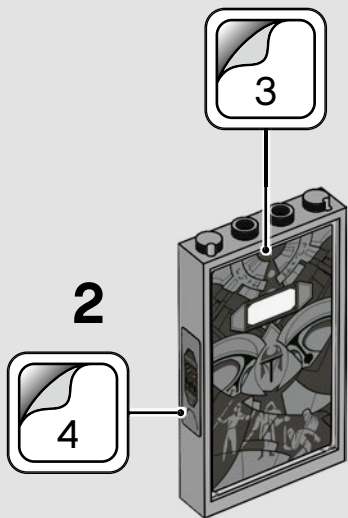

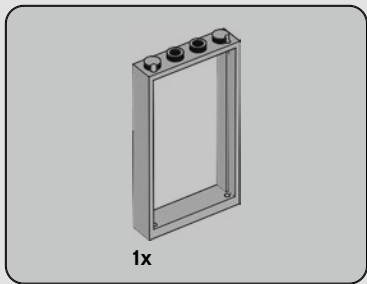

8

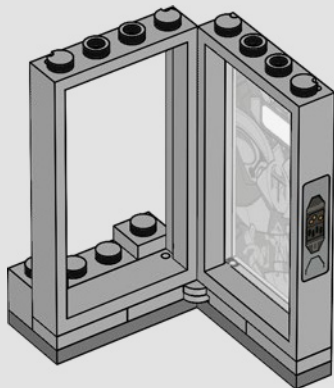

14



1x



1x

9

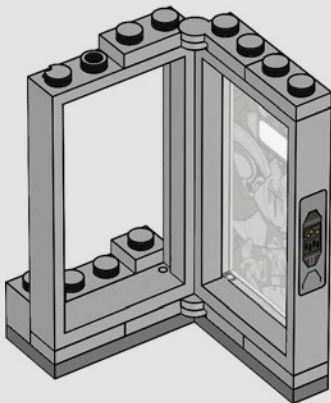



1x

10

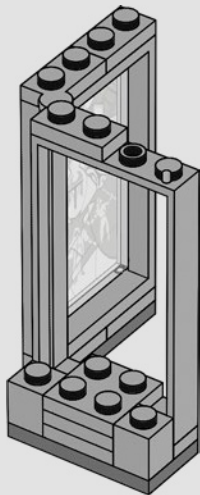

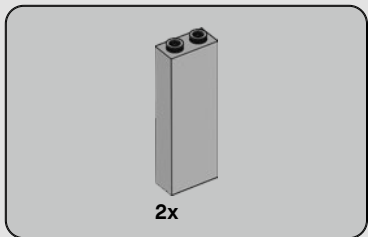

11

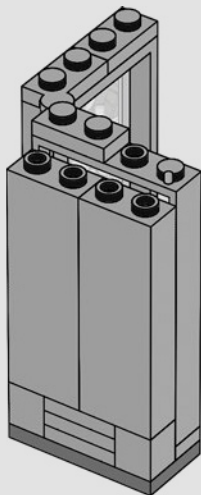



1x

12

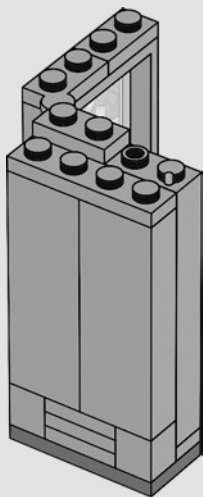

18



1x



1x

13

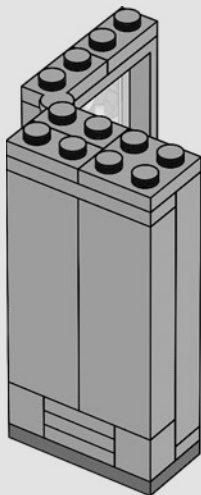

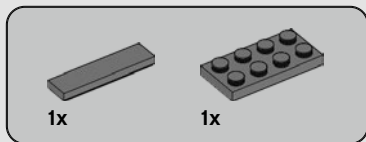

14



15

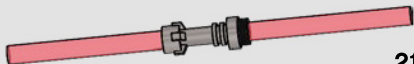



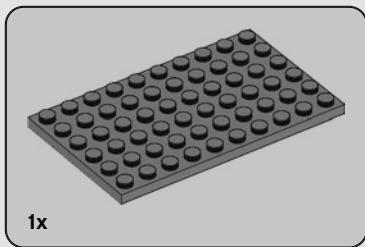

1x

1

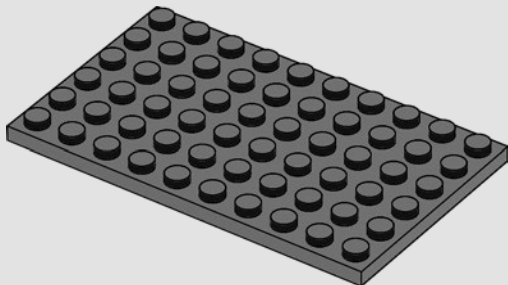



2x



1x

2



2x

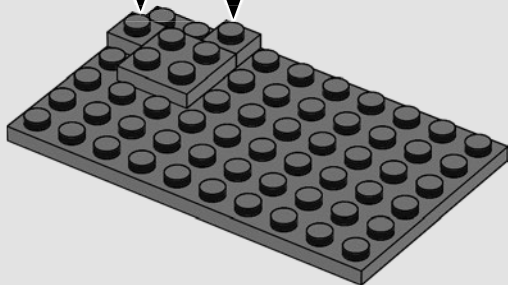

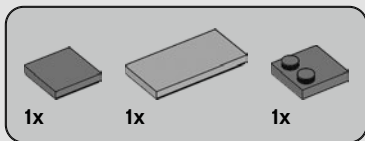

3

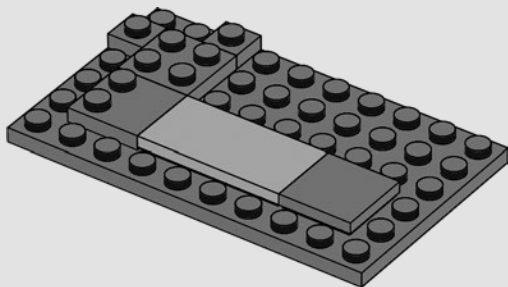



2x



1x

4



2x

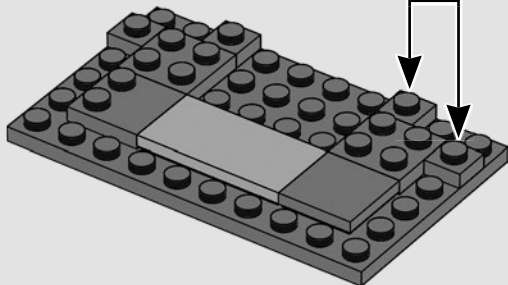

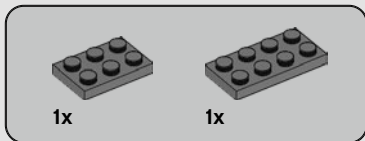

5

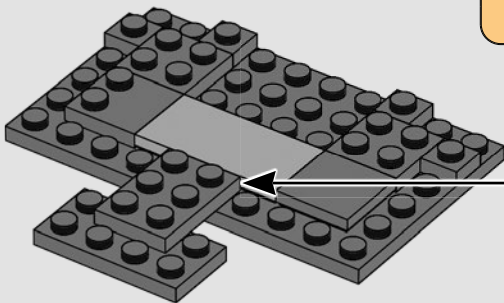
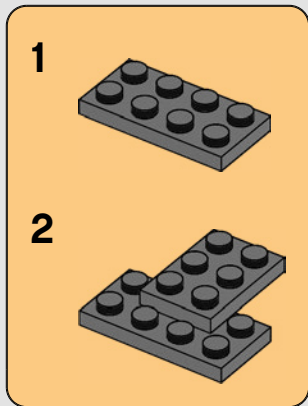



2x

6

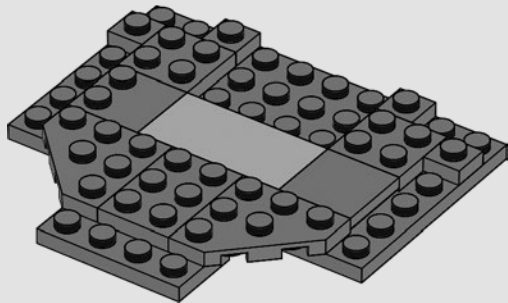



2x

7

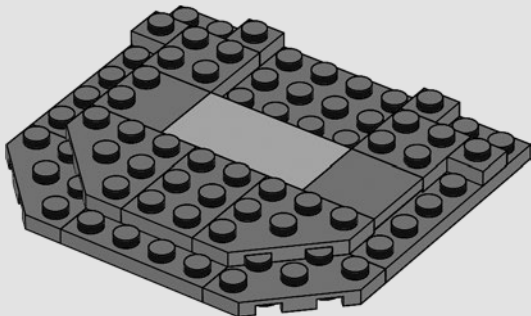



1x



1x

8

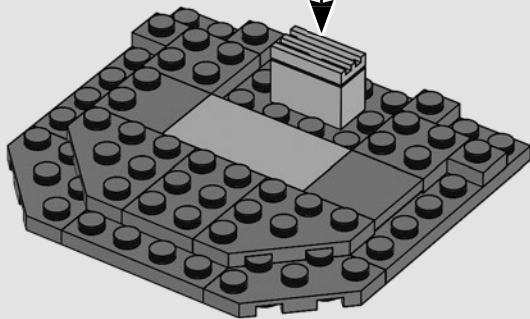
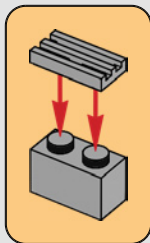

30

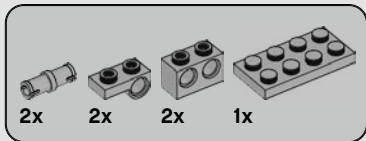
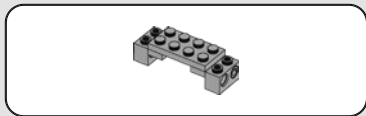

9

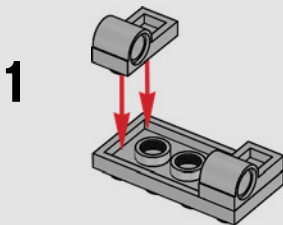

2

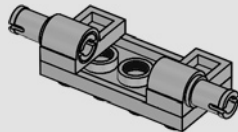

3

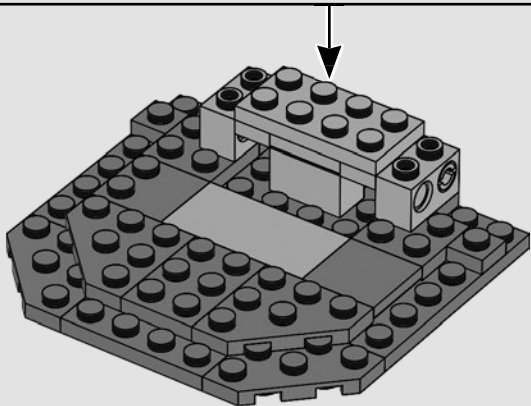
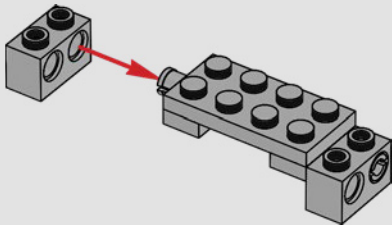

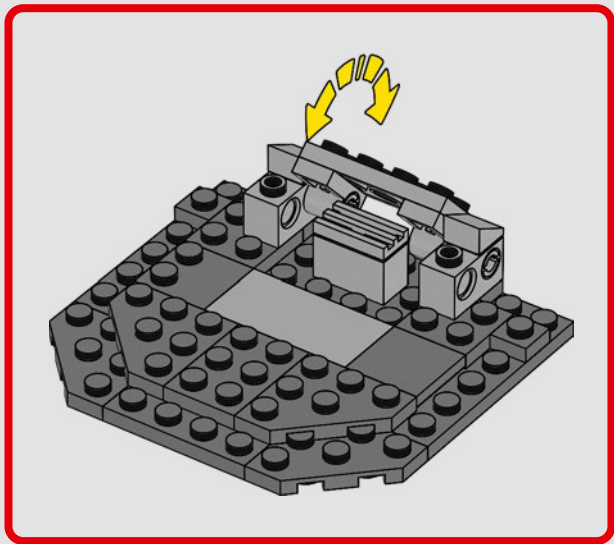



2x

10

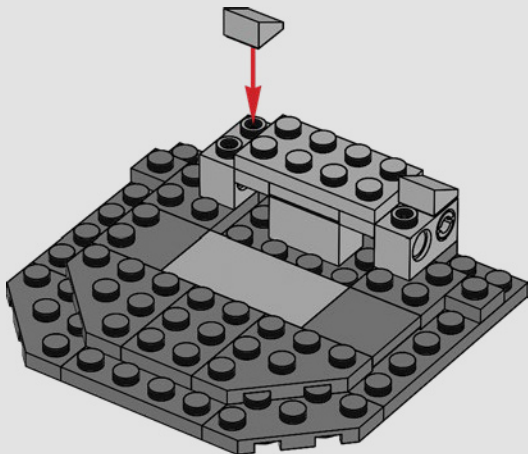

34



2x

11

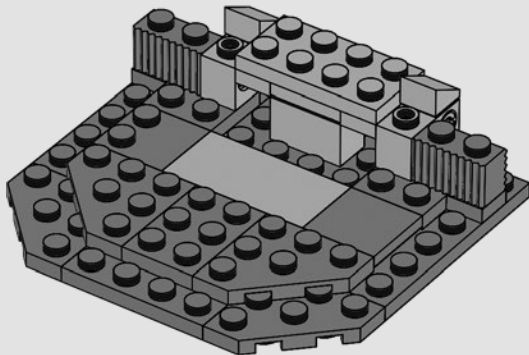



2x

12

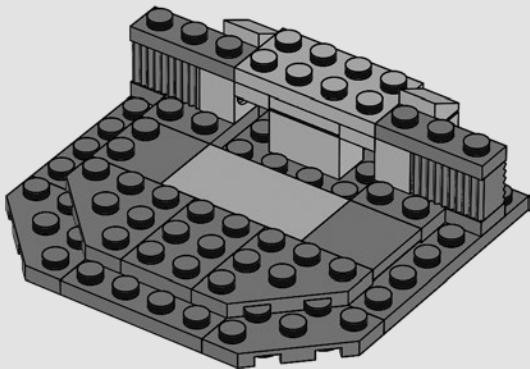

36

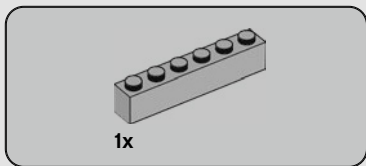

13

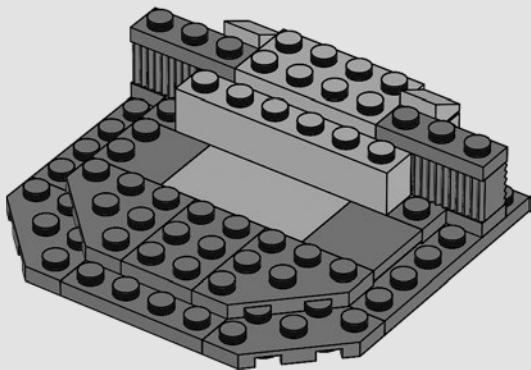



1x

14

1

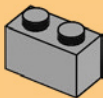

2

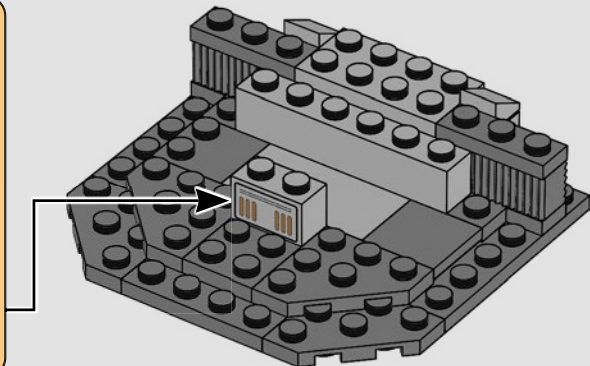



2x



2x

15



2x

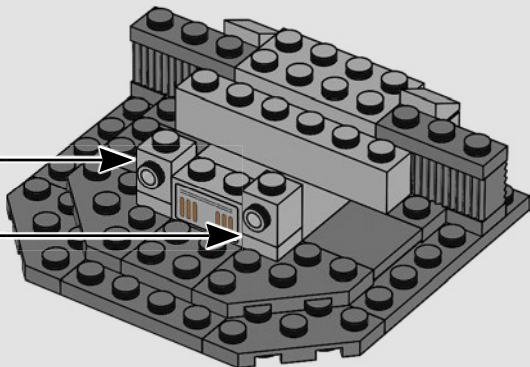



2x

16

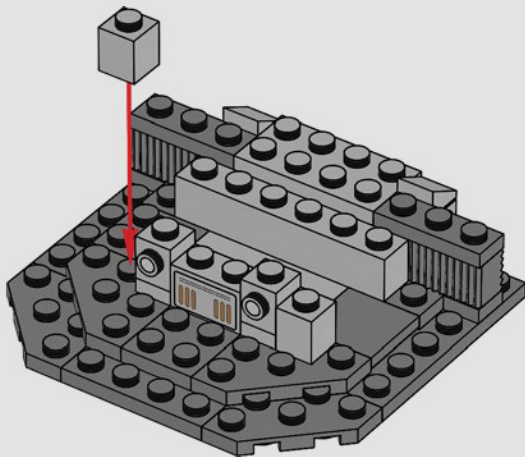

40

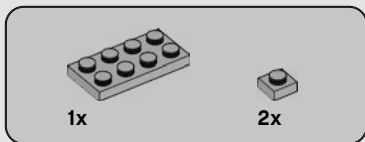

17

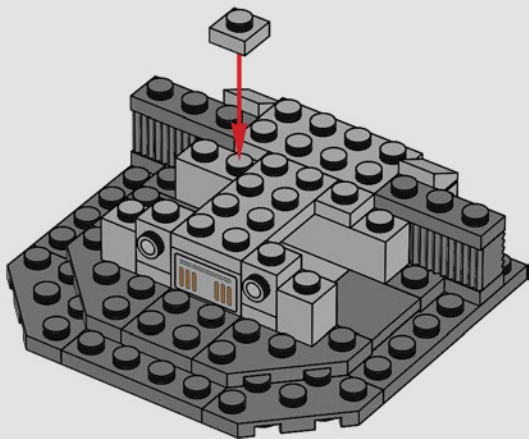



2x



2x

18

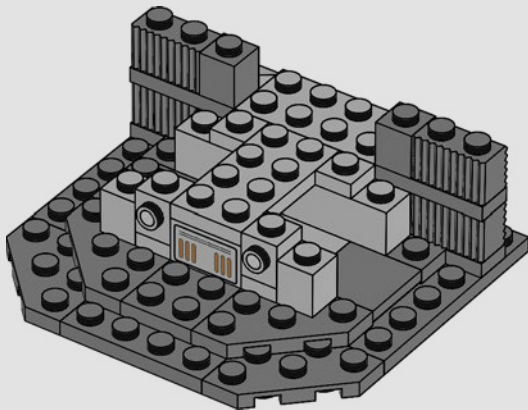

42



2x

19

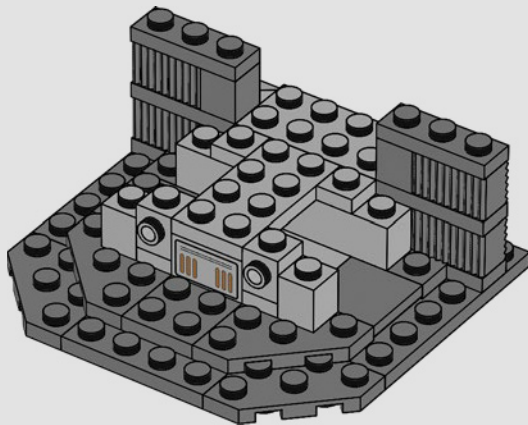

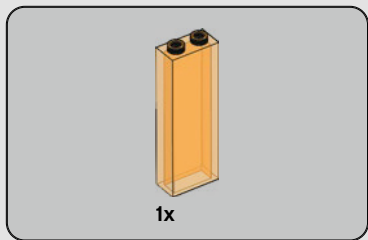

20

1

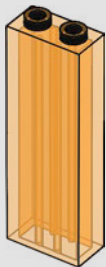

2

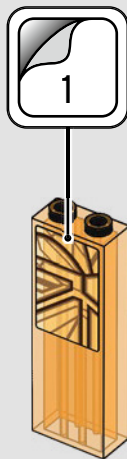

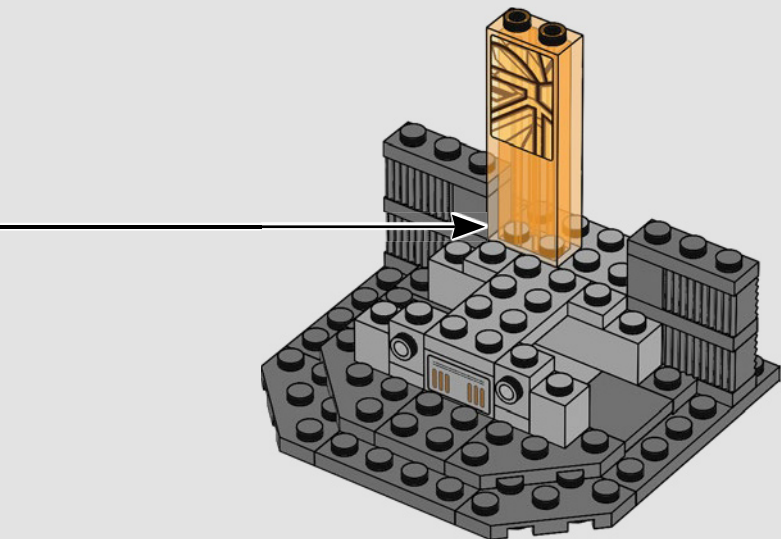

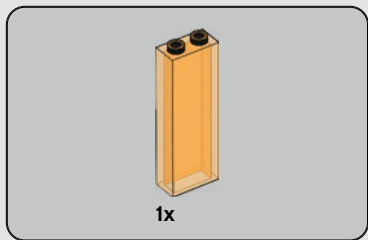

21

1



2



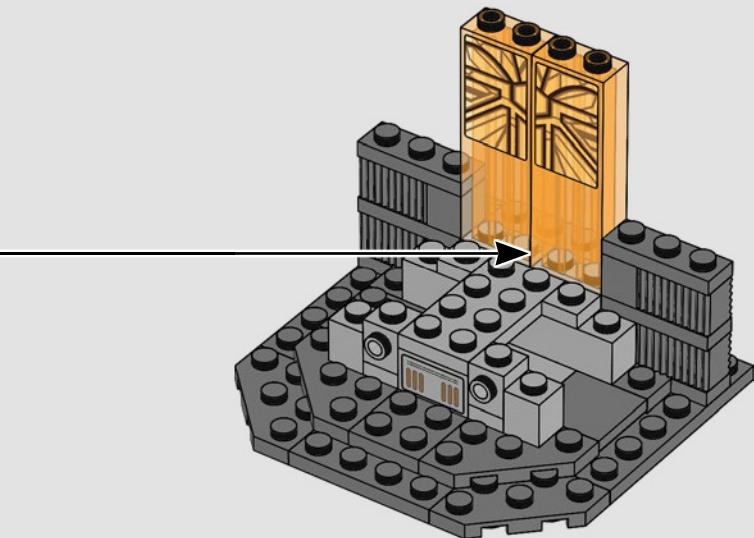



1x



1x

22

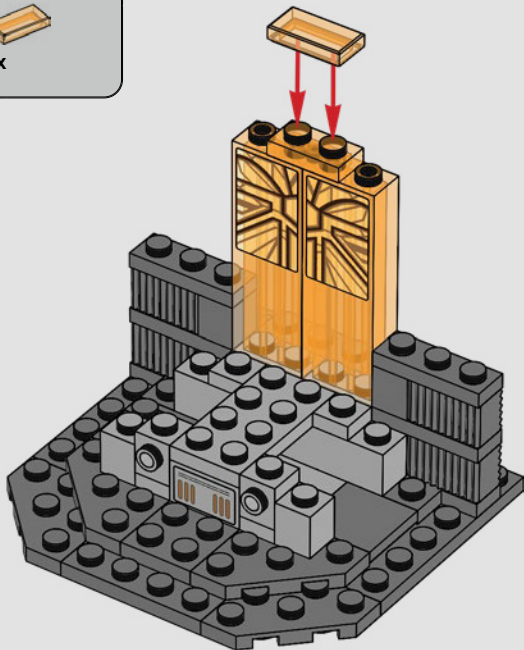



2x

23

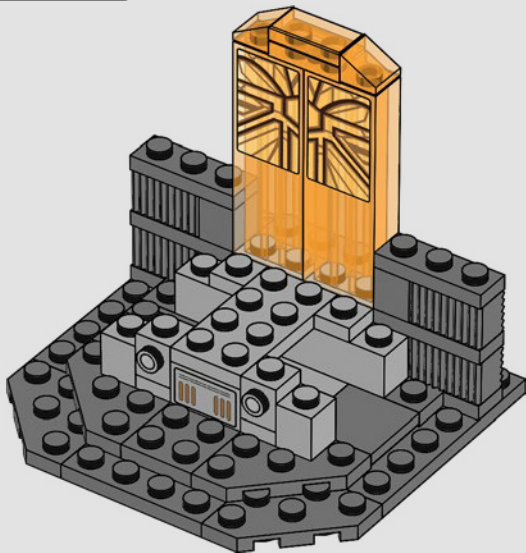



2x



2x

24

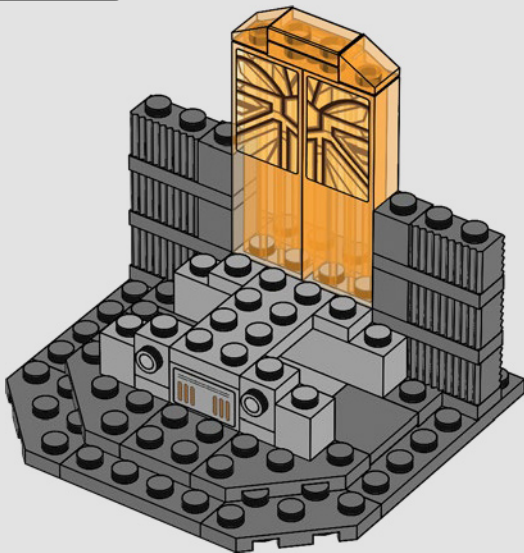



4x



2x

25

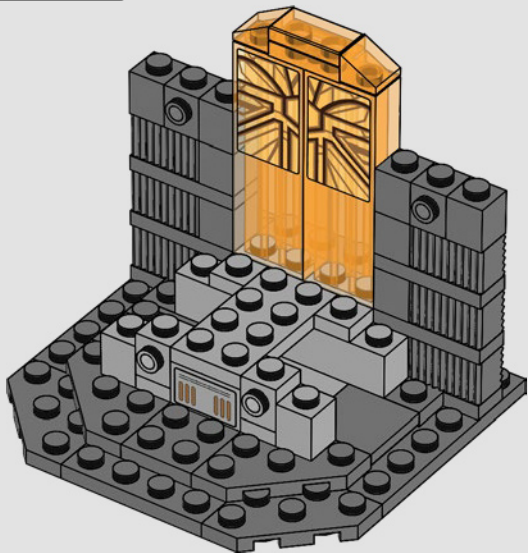



2x



2x

26

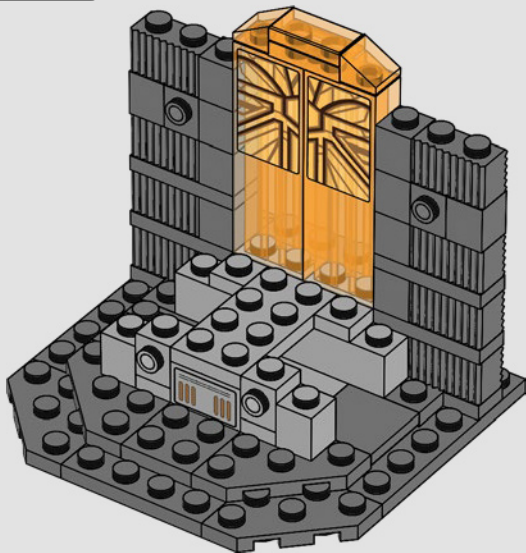

52



2x



2x

27

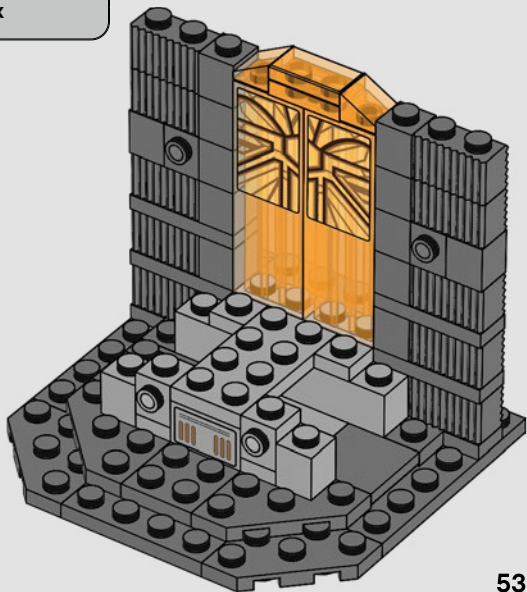



2x



2x

28

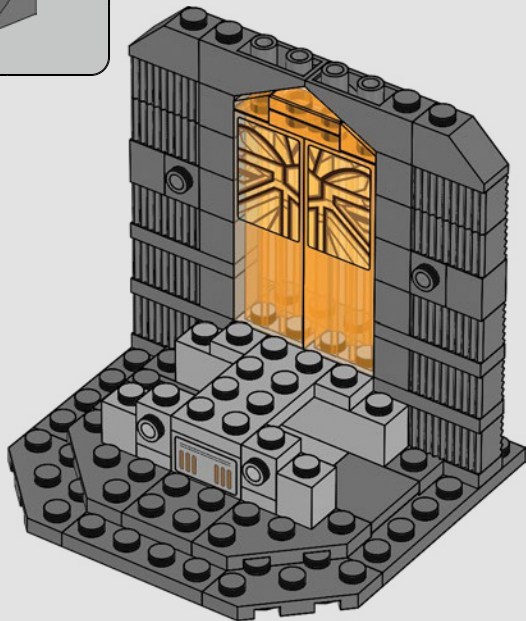

54

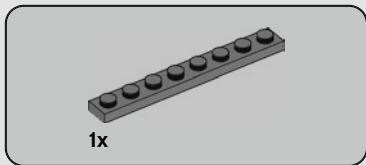

29

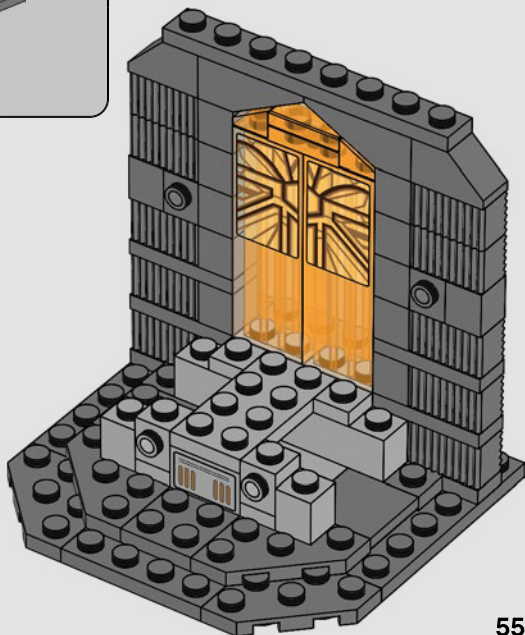



2x

30

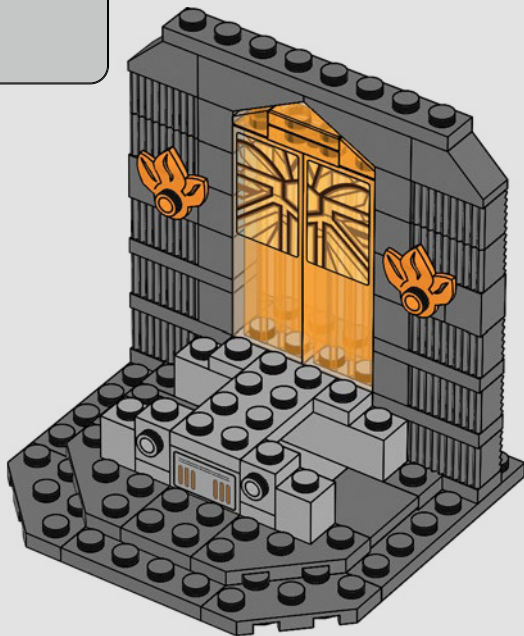

56



1x



1x

31

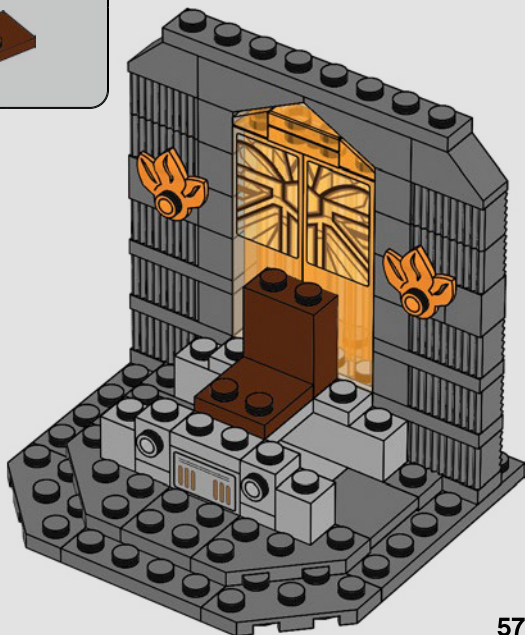



2x



2x



2x



2x

32

1

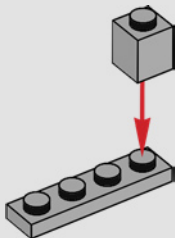

2

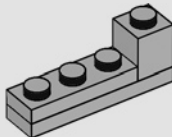

2x

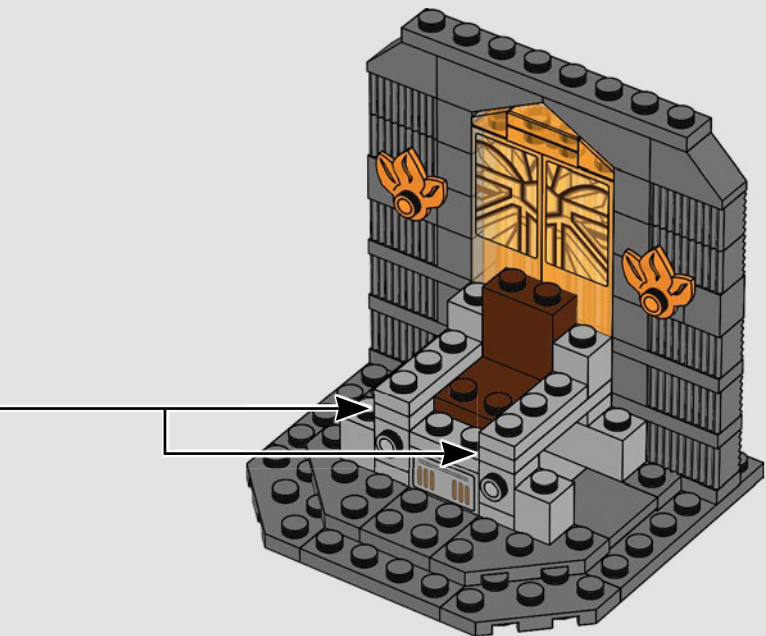



2x



2x



4x

33

1

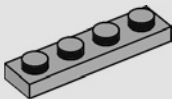

2

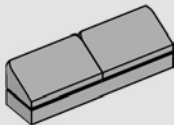

2x

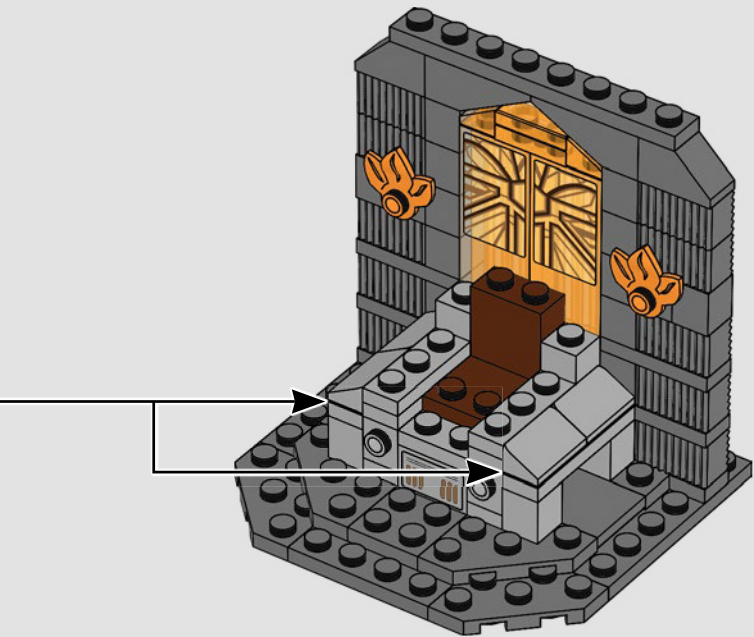



2x



2x

34

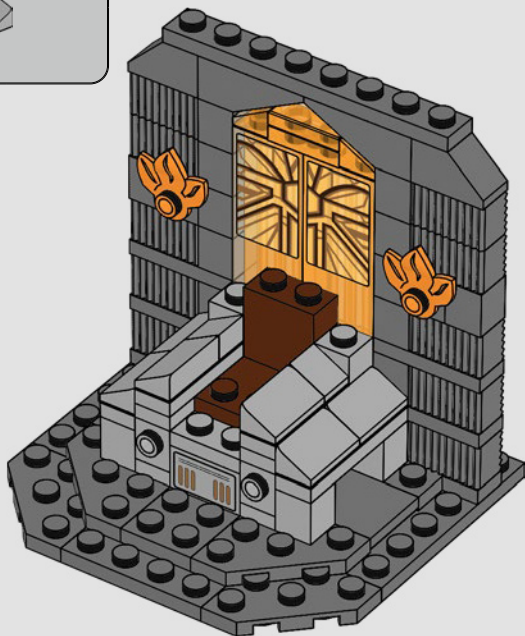



2x

35

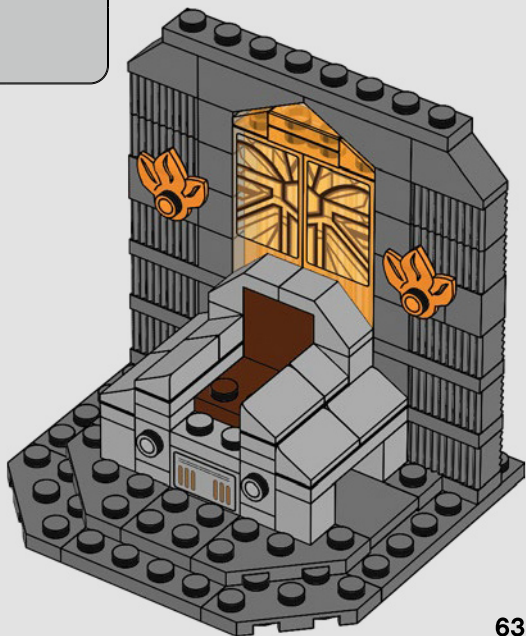

63



2x

36

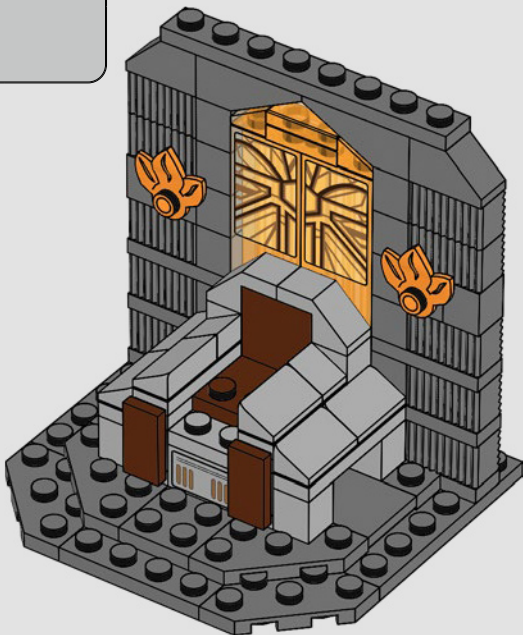

64

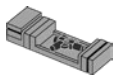

1x



1x

37

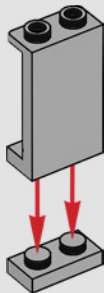



1x



1x

38

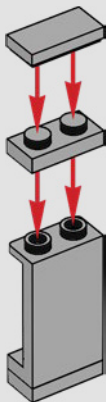



1x

39

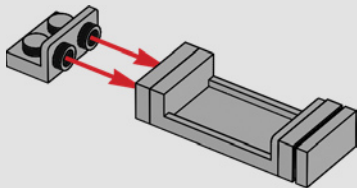
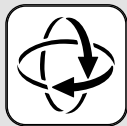



1x



1x

40

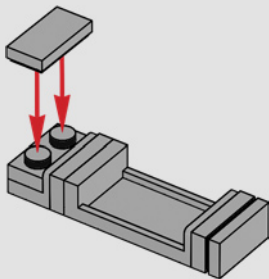

1x

41

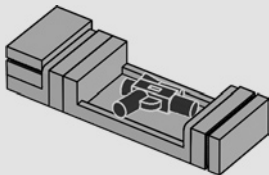

42

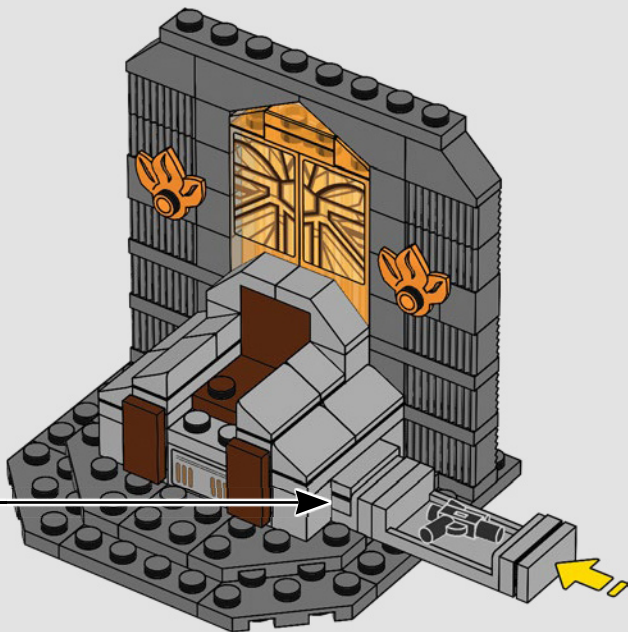

69





STAR WARS™

75316



75314



75280



75283



75281



75310

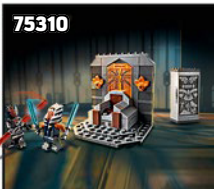



STAR WARS™



75314



75311



75310



75319



75315

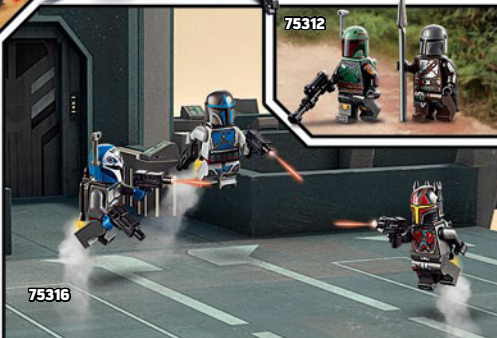

75312



75316

The LEGO logo is displayed in its characteristic white, bold, sans-serif font with a thick black outline, set against a red square background.

STAR WARS™

THE SKYWALKER SAGA



GAMES



ONE



PS4

PC



LEGO® STAR WARS™: THE SKYWALKER SAGA. SOFTWARE © 2020 TT Games Ltd. Produced by TT Games under license from the LEGO Group. LEGO, the LEGO logo, the Brick and the Knob configurations and the Minifigure are trademarks and/or copyrights of the LEGO Group. © 2020 The LEGO Group. STAR WARS® &™ Lucasfilm Ltd. All rights reserved. Used under authorization. WB GAMES LOGO, WB SHIELD:™ & © Warner Bros. Entertainment Inc. (s20)



1x
6308058



1x
6296263



1x
6020297



1x
4609050



1x
6355615



1x
6256058

74



2x
6167284



1x
6308046



2x
6253884



2x
6245265



1x
6251306



1x
6240217



2x
6251286



2x
6170187



1x
6172808



2x
4211151



1x
6196221



4x
4521921



4x
4211399



2x
4558953



6x
4211389



6x
4568637



2x
4211807



1x
6308053



2x
6213378



1x
4211350



2x
6168633



2x
4211363



2x
4211388



9x
4211398



2x
4211414



2x
4211541



1x
6004990



2x
4211397



2x
4211429



5x
4211445



1x
4585429



1x
6311516

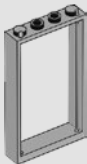

2x
6262961



2x
4211395



1x
4211393



2x
6102769



1x
4560183



2x
4558955



12x
4211098



4x
4210719



10x
4210636



2x
4211135



1x
6309059



2x
4211094



1x
4211055



2x
4211068



4x
4211133



1x
4211043



1x
4211053



1x
4210998



3x
4211065



1x
4211001



4x
4210897



1x
4211114



1x
6346747



3x
6051389



Customer Service

Kundenservice

Service Consommateurs

Servicio Al Consumidor

LEGO.com/service or dial



: 00800 5346 5555



: 1-800-422-5346

WIN

GO TO WWW.LEGO.COM/PRODUCTFEEDBACK AND
GIVE US YOUR SHORT **FEEDBACK** ABOUT THIS
LEGO® SET FOR A CHANCE TO WIN
A COOL LEGO PRIZE.

Terms & Conditions apply

LEGO.com/productfeedback

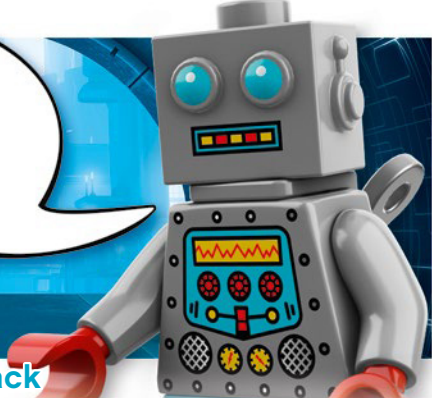

GEWINNE

Erzähle uns auf
www.LEGO.com/productfeedback

etwas über die Erfahrungen,
die du mit diesem LEGO® Set
gemacht hast, und sichere dir
die Chance auf einen coolen
LEGO Preis!

Es gelten die Teilnahmebedin-
gungen

GAGNE

Rends-toi sur
www.LEGO.com/productfeedback

et donne-nous quelques
commentaires sur ce produit
LEGO® pour avoir une chance
de gagner un prix LEGO !

Voir Conditions Générales

GANAN

Visita
www.LEGO.com/productfeedback

y envíanos tu opinión acerca
de este set LEGO®. ¡Parti-
ciparás en el sorteo de un
premio LEGO!

Términos y Condiciones
aplicables

获取奖品

登录
www.LEGO.com/productfeedback

给出关于此乐高®套装的简
短反馈，就有机会获得炫
酷乐高奖品

《条款及条件》适用

LEGO and the LEGO logo are trademarks of the/sont des marques de commerce du/son marcas
registradas de LEGO Group. ©2021 The LEGO Group.

© & ™ Lucasfilm Ltd.

6382340