



LEGENDS OF

TM

CHIMA

70228



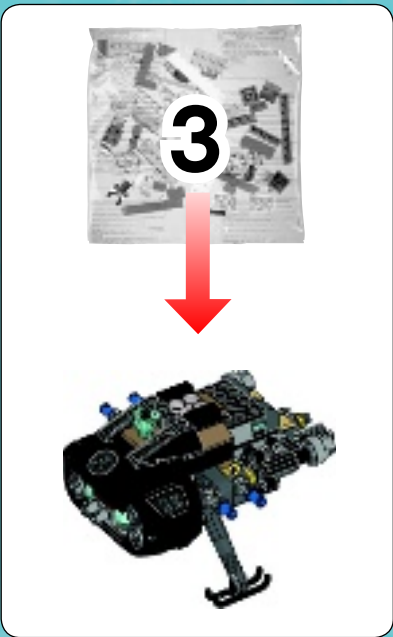

1



2



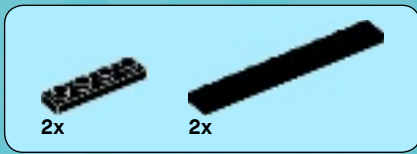

3

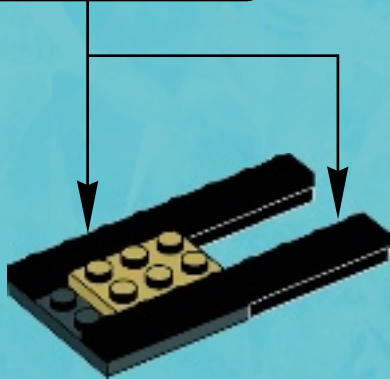
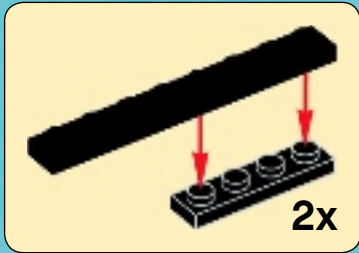

4

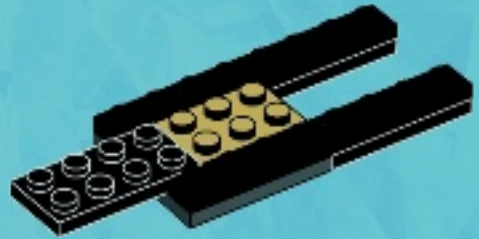

5

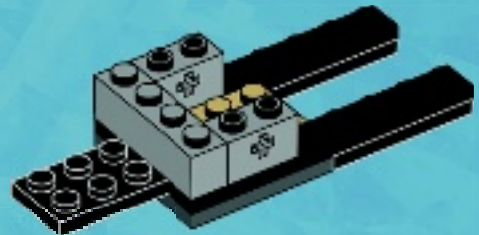

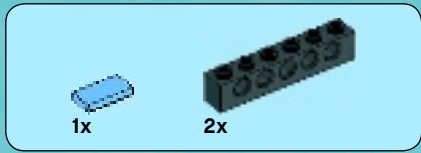

6

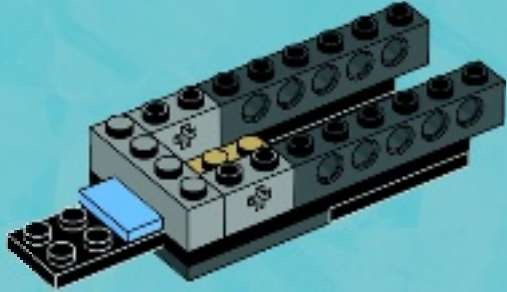

7

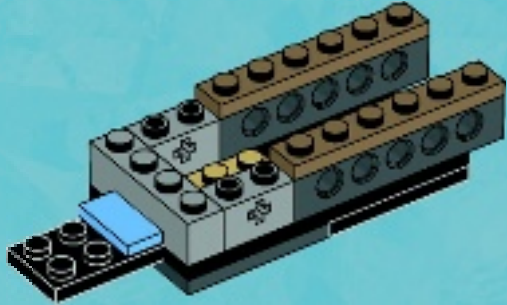

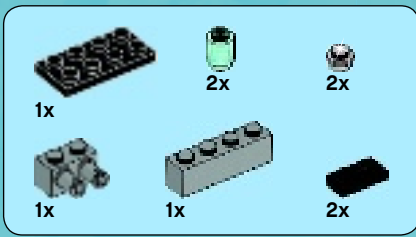

8

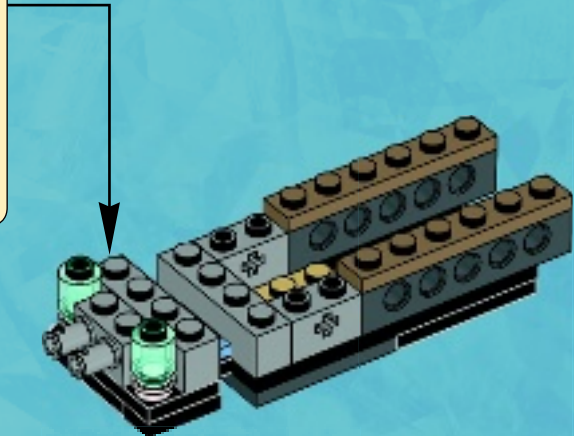
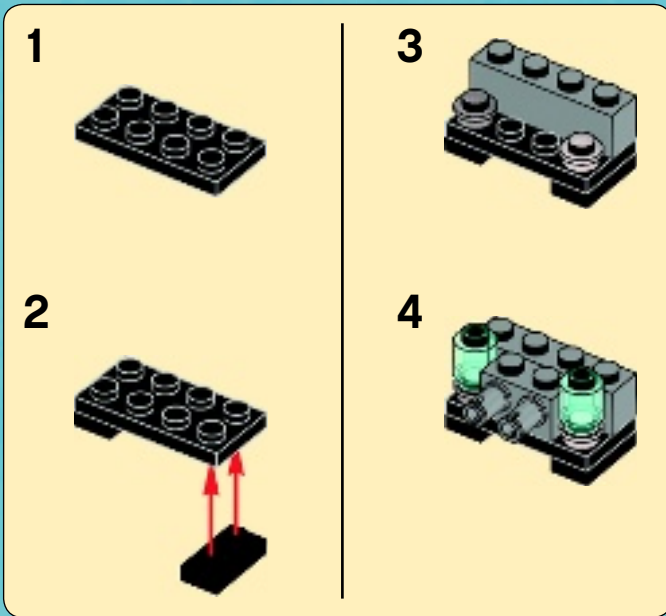

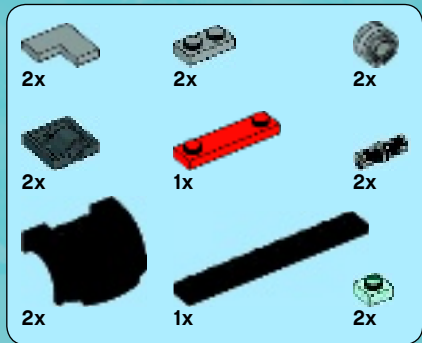

9

1

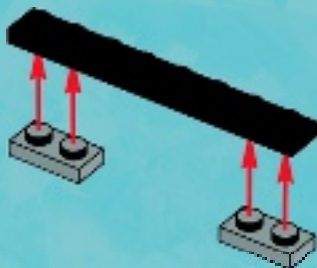

2

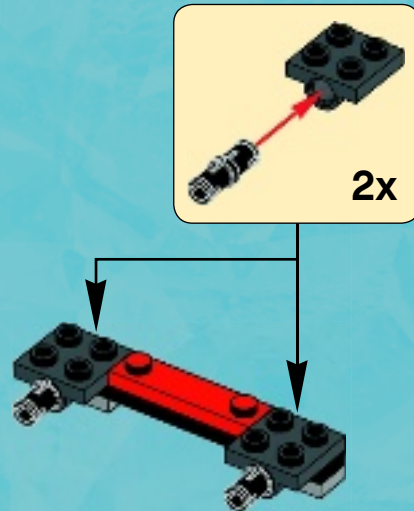

3

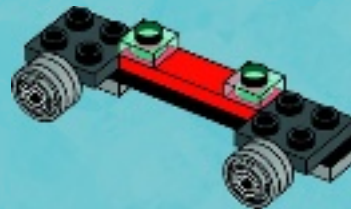

4

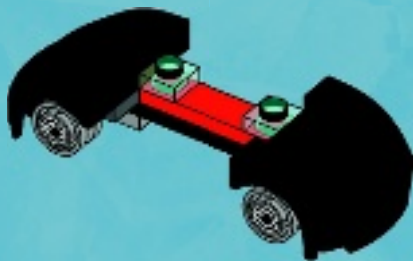

5

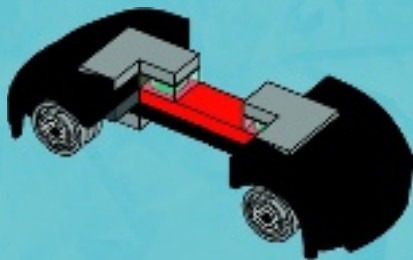

6

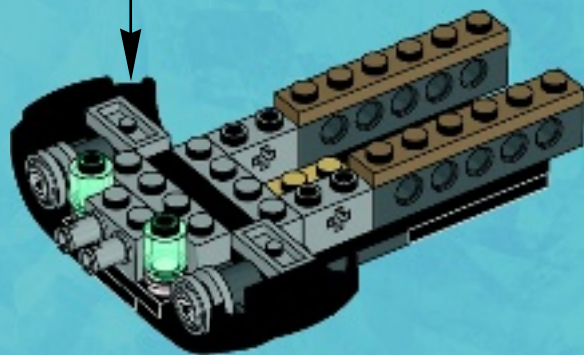
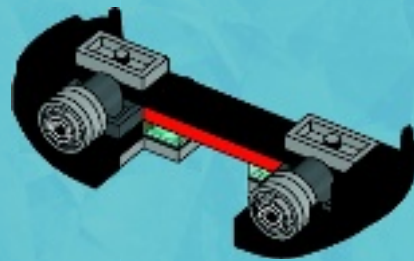



1x

10

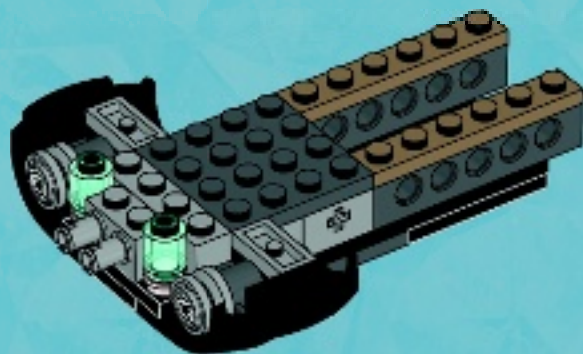



11

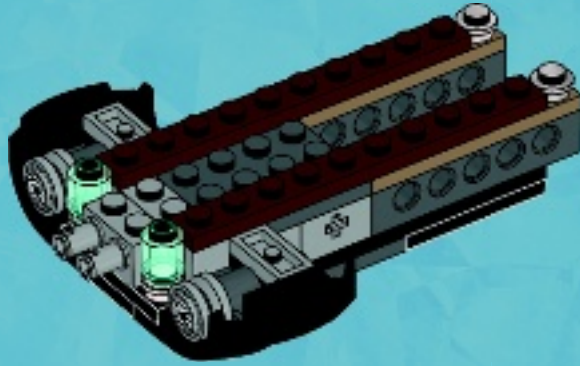

12

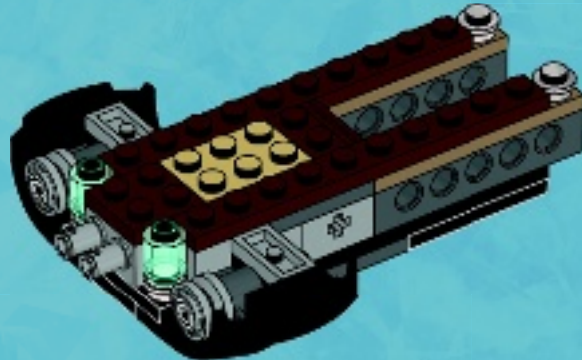



1x

1



2x

2



1x

3

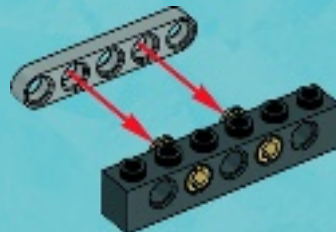

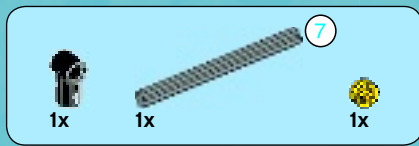

4

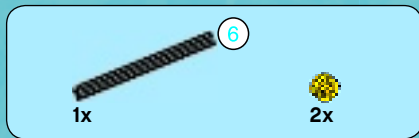
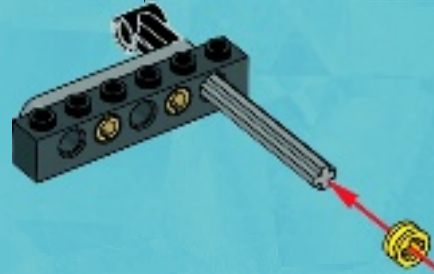
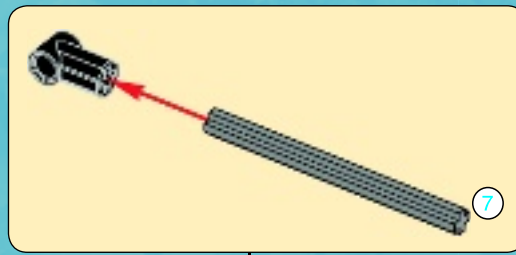

5

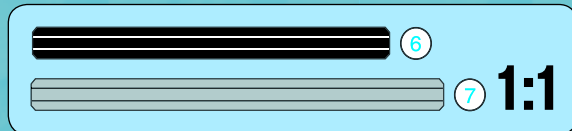
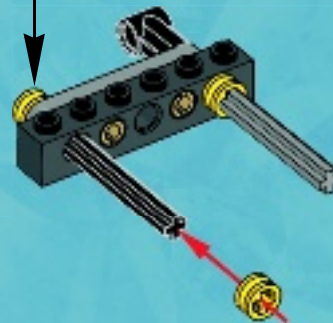
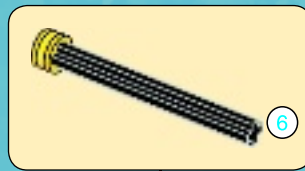

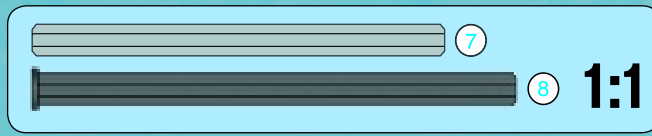
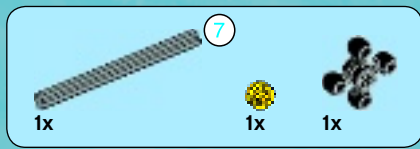

6

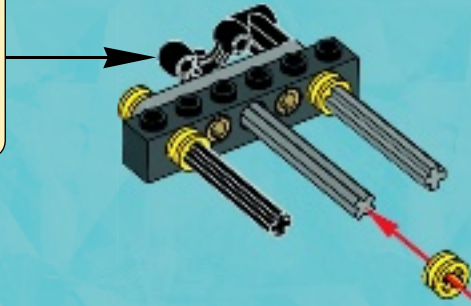
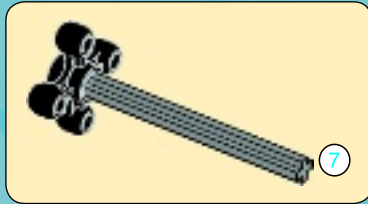

7

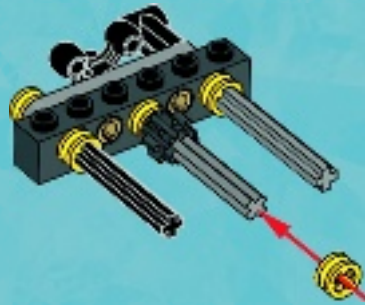

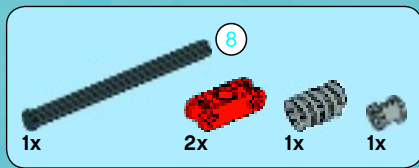

8

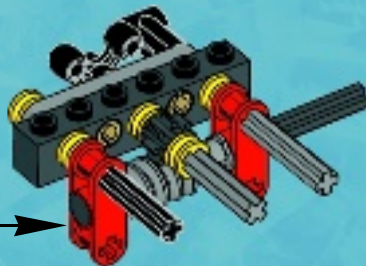
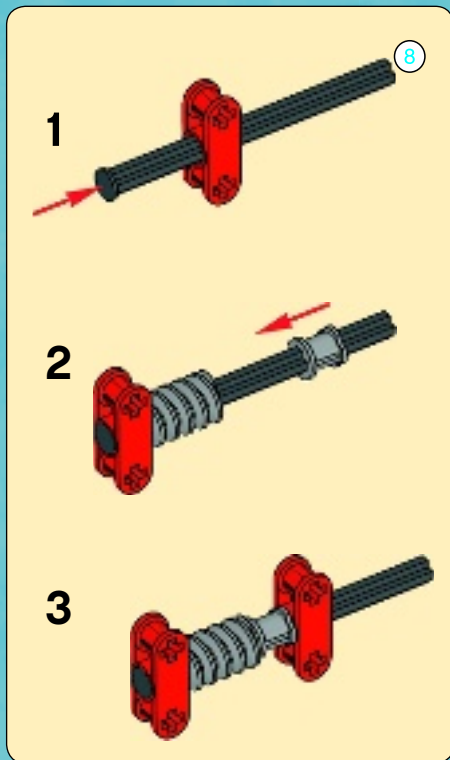



9

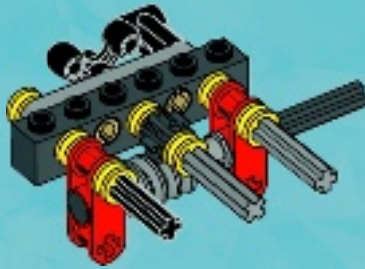

10

1

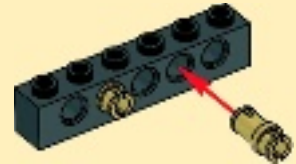

2

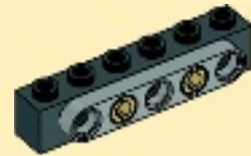



11

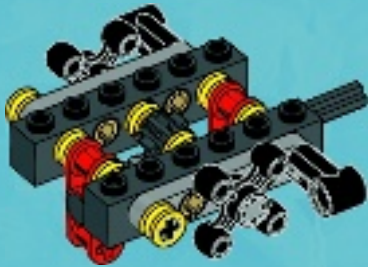

13

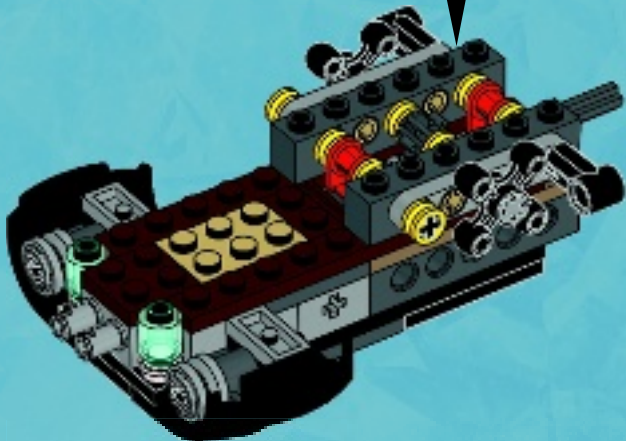

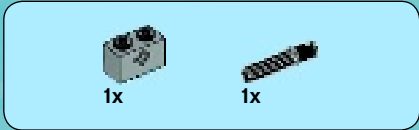

1x

1x

1

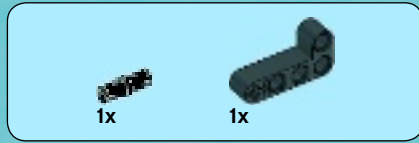
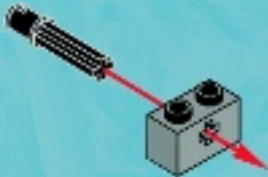

1x

1x

2

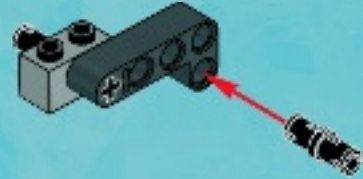

1x

3

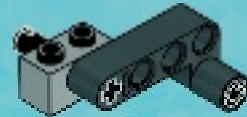

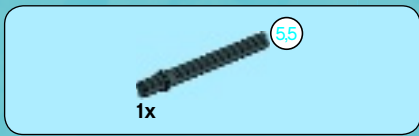

4

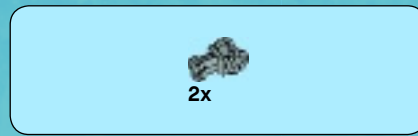

5

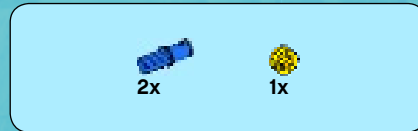
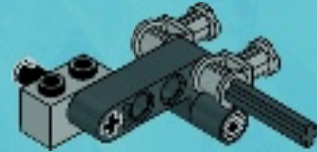

6

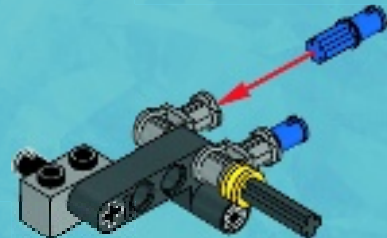



7

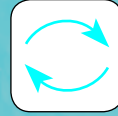
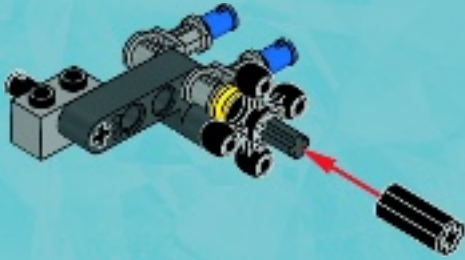

8

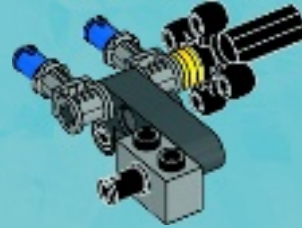

14

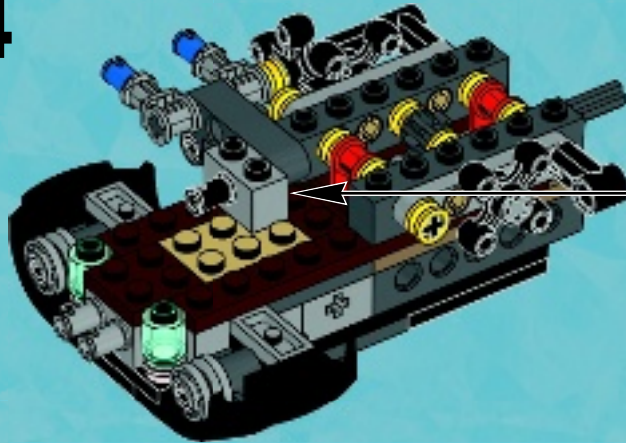

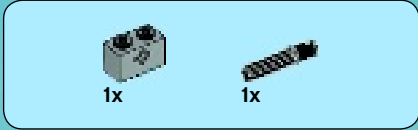

1

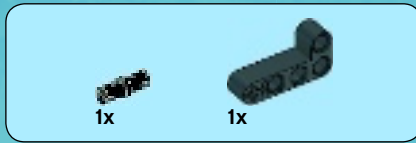
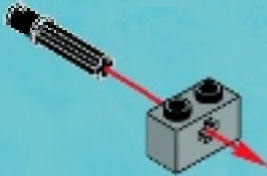

2

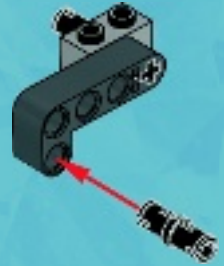

3

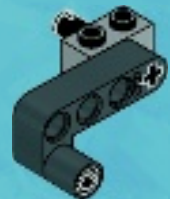



4

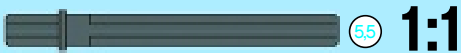
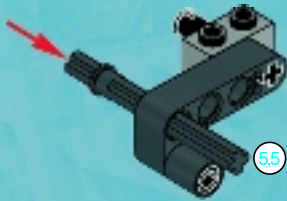

5

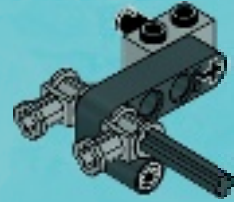

6

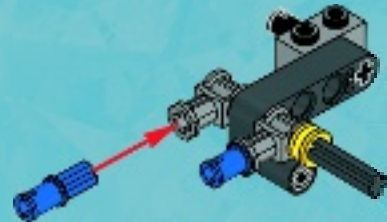



7

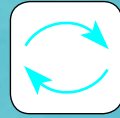
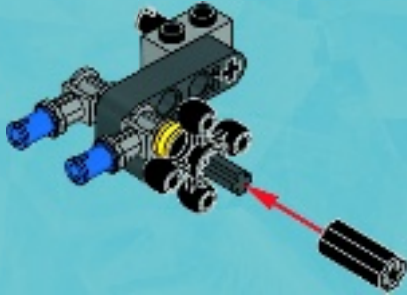

8

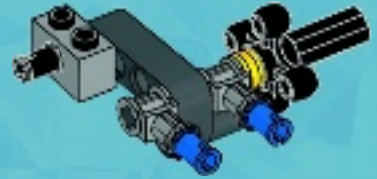

15

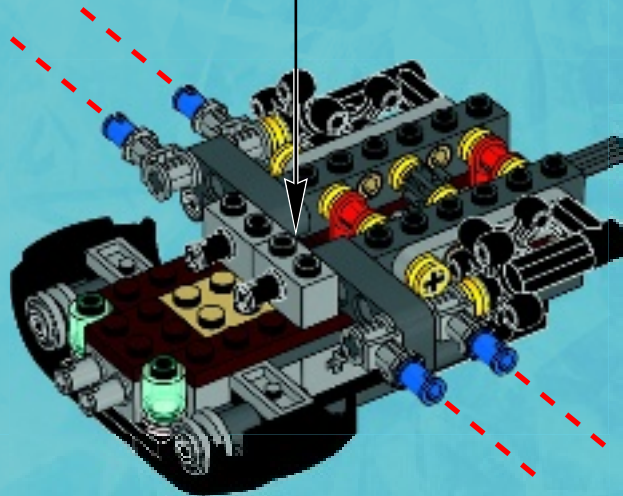



2x



2x

16

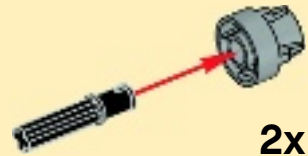

2x

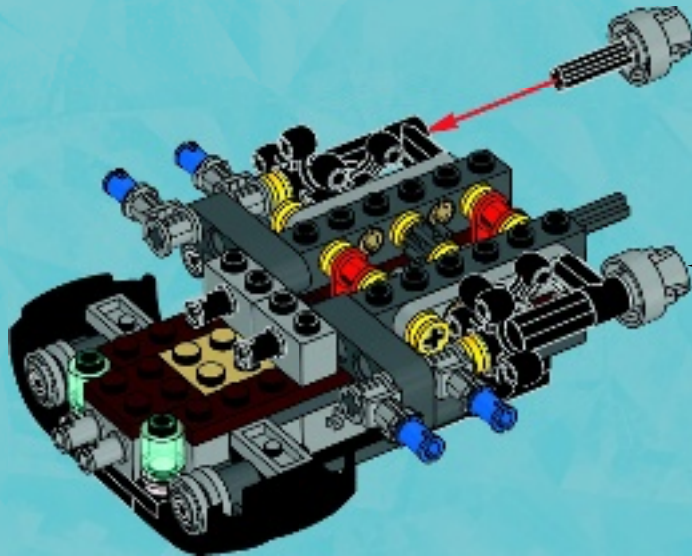



1x

17

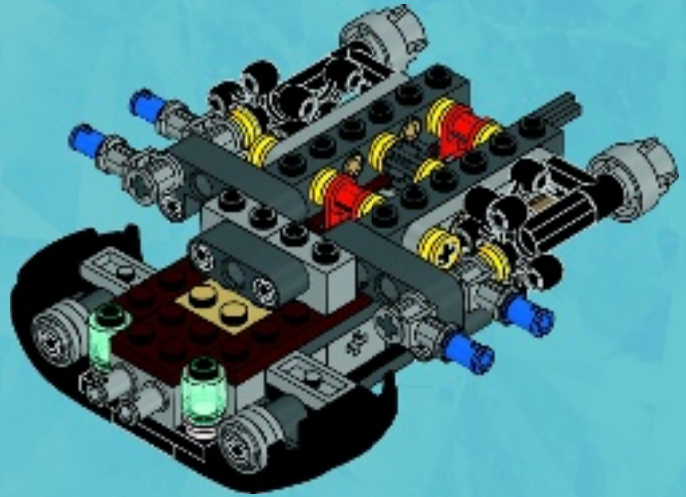

2x



4x

18



1



2



2x

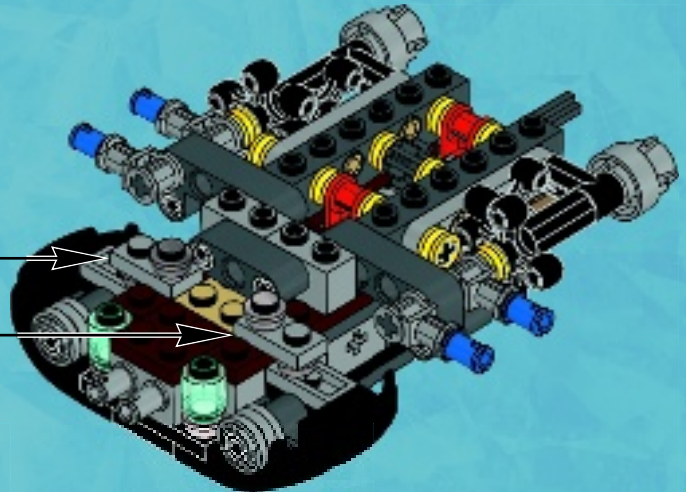

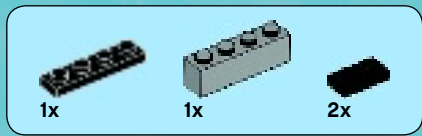

19

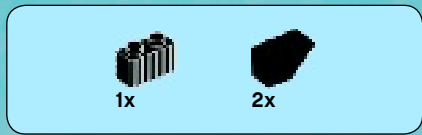
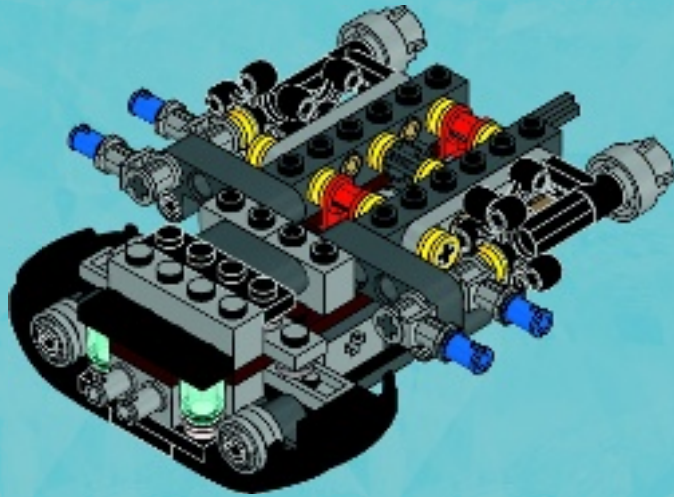

20

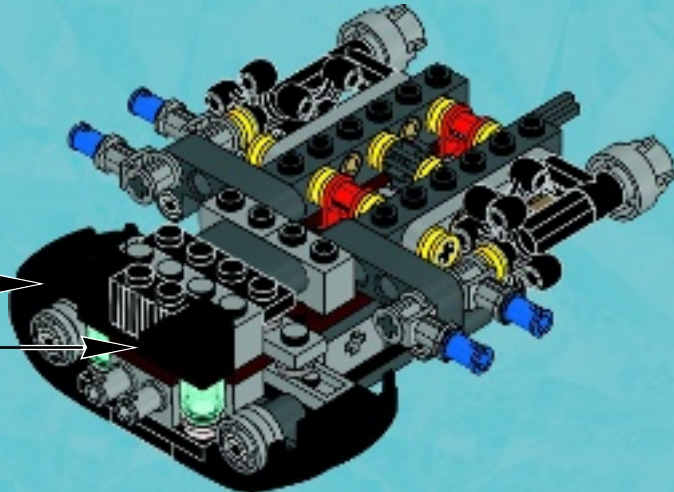



21

1. Two red arrows point from a grey Technic brick with a hole to a black curved piece, indicating alignment.

2. A red arrow points from a black axle with a bush to a hole in the grey Technic brick, indicating insertion.

3. A black curved piece is shown with the grey Technic brick attached to its top surface.

4. A white square with the number '3' is shown above the assembly. A red arrow points from this square to a hole in the black curved piece. A circular arrow icon indicates that the assembly should be rotated.

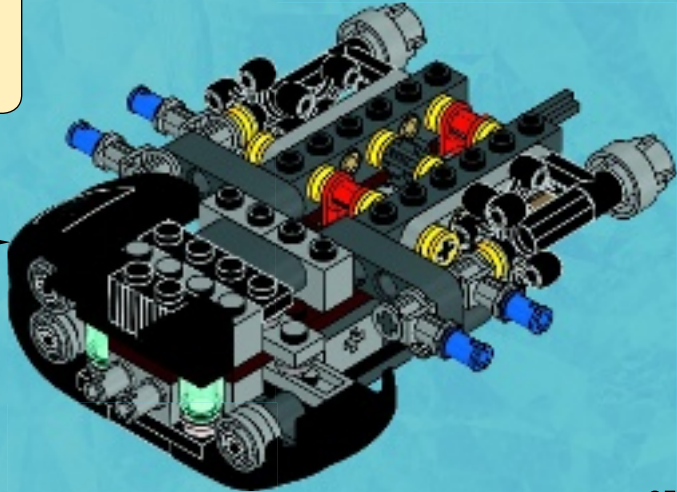



22

1

2

3

4

4

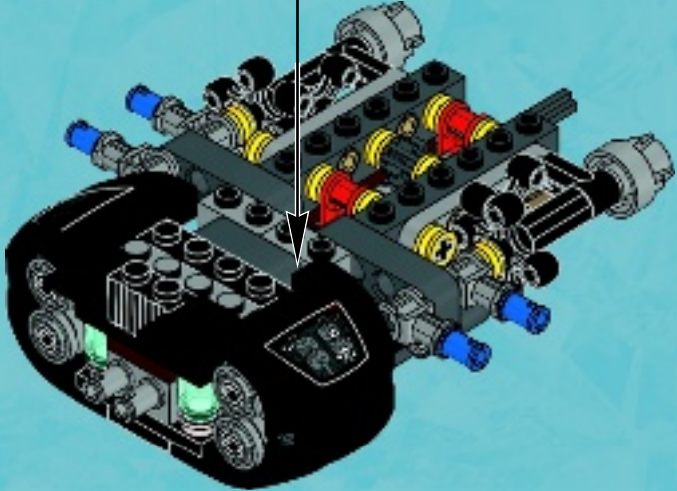



2x

23

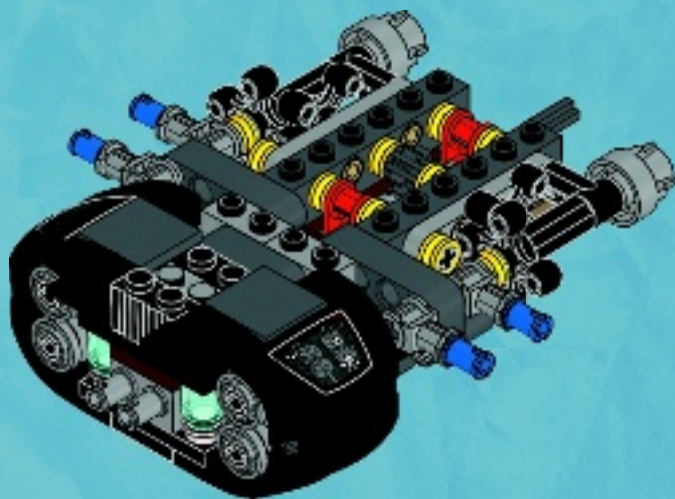

1x



2x



2x

24

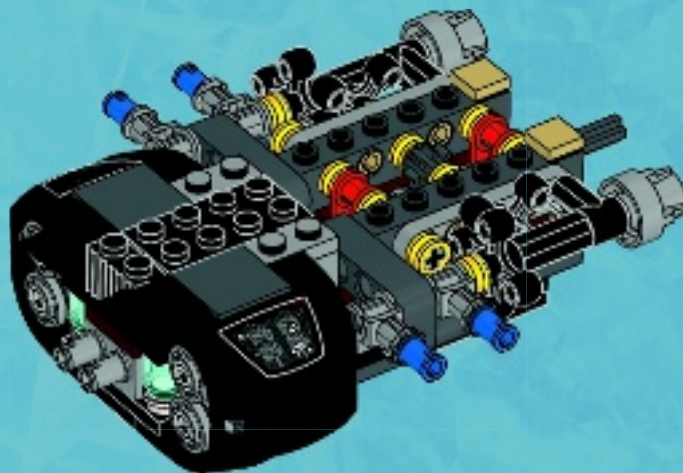

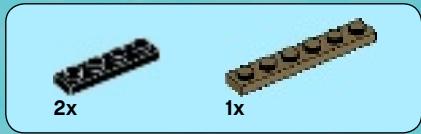

25

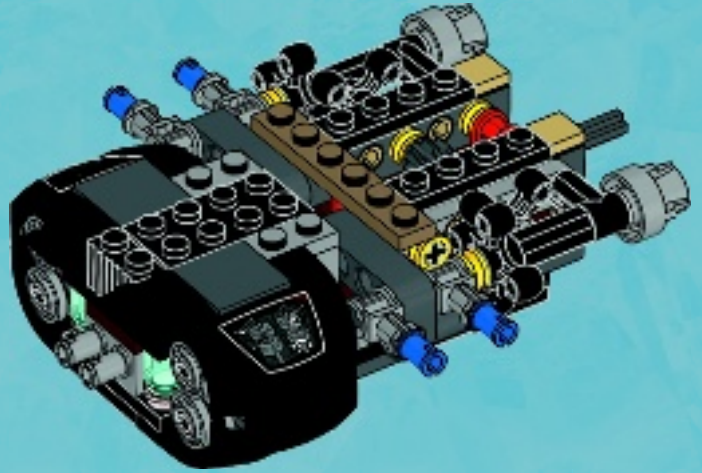

26

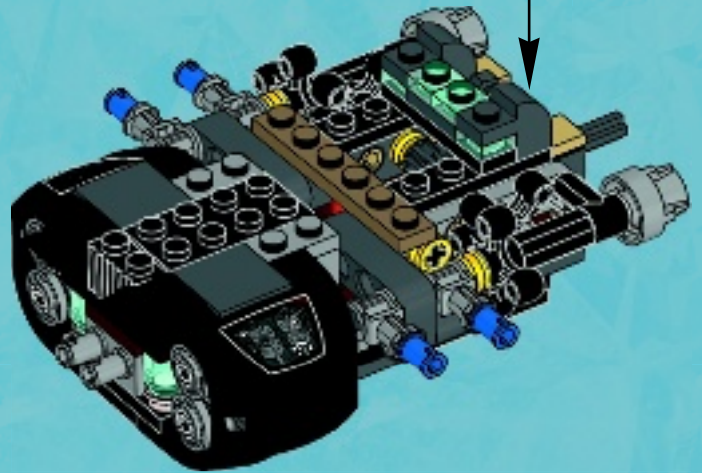



1x



2x

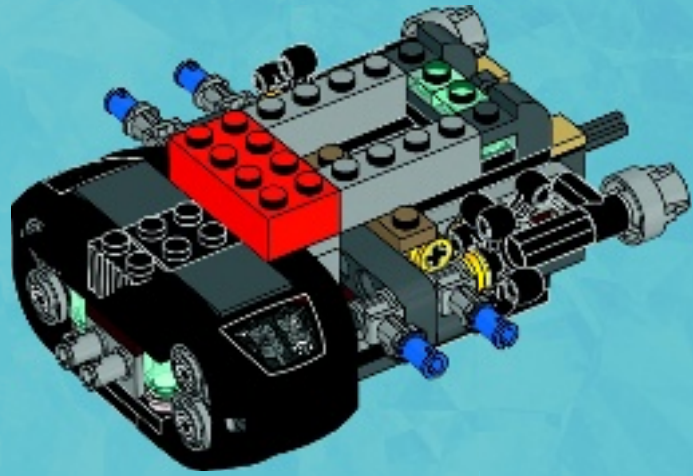

27



1x

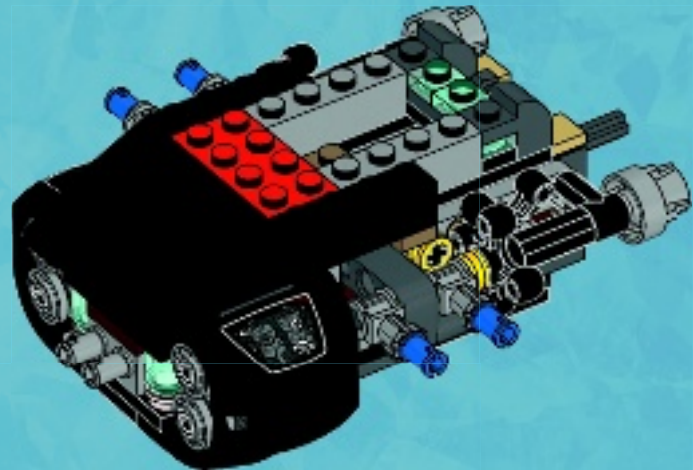

28

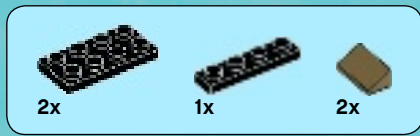

29

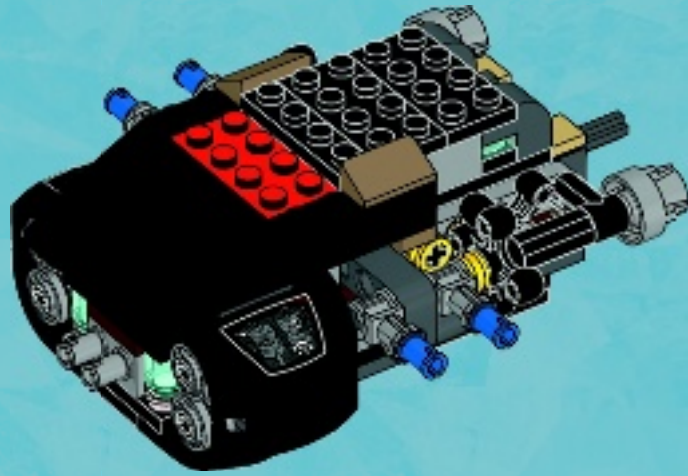

30

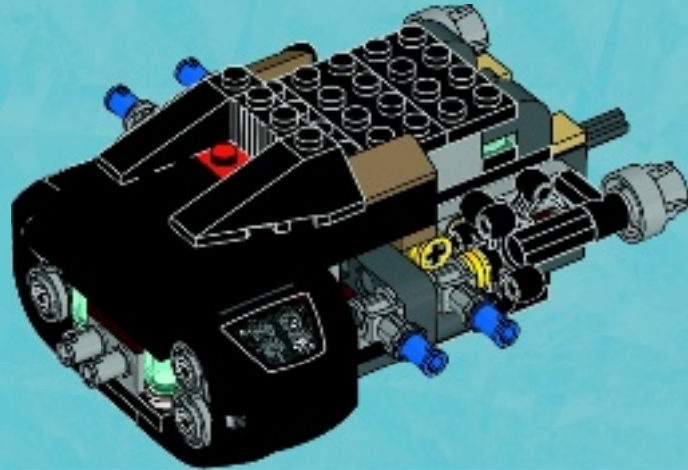



1x



1x

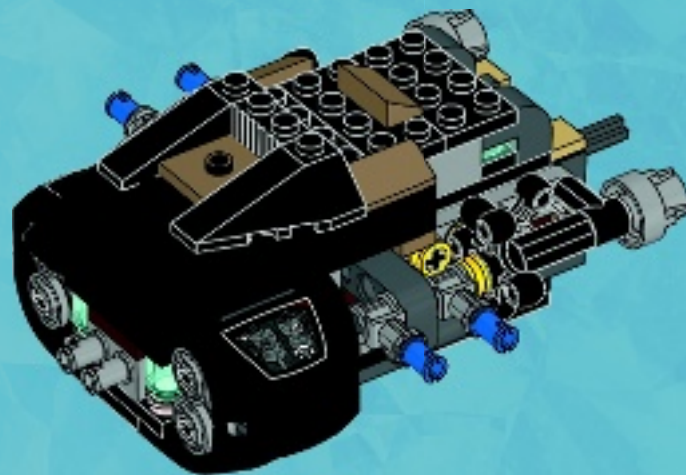

31



4x



1x

1



2



32

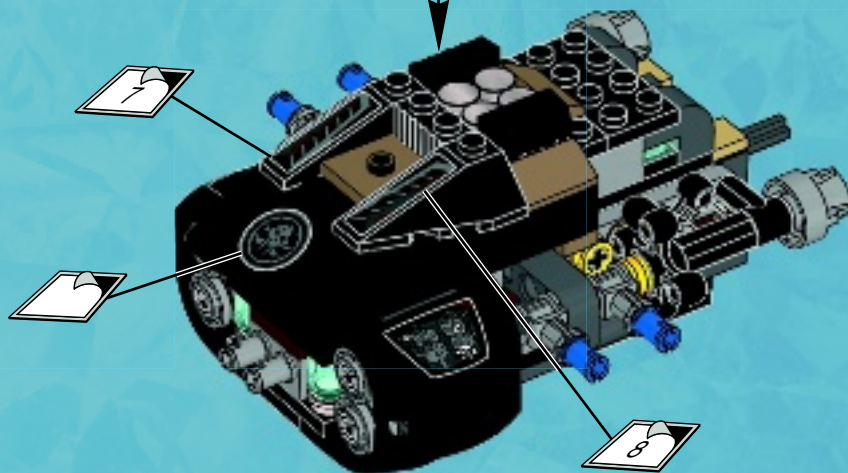

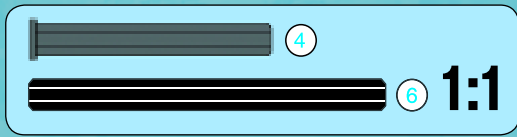
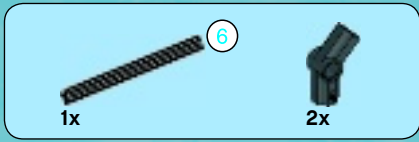

33

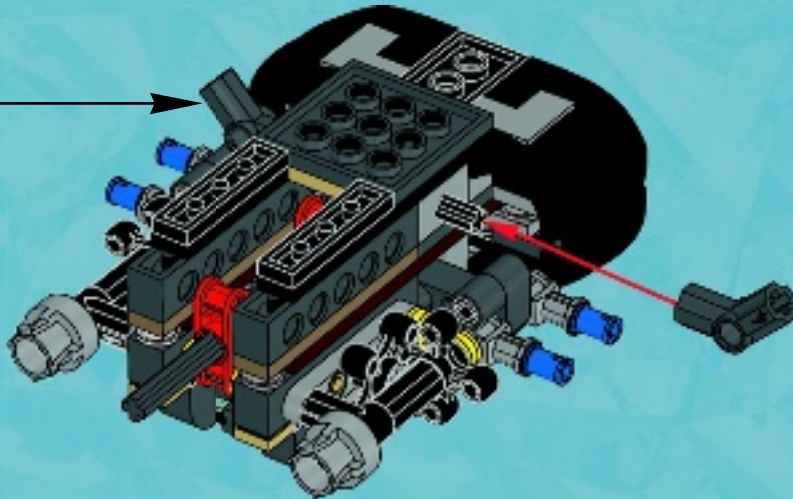
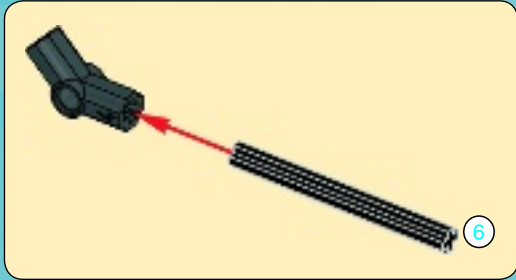

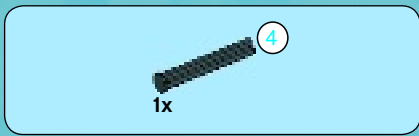

34

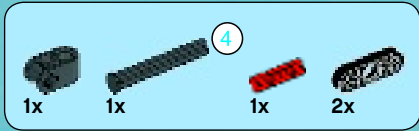
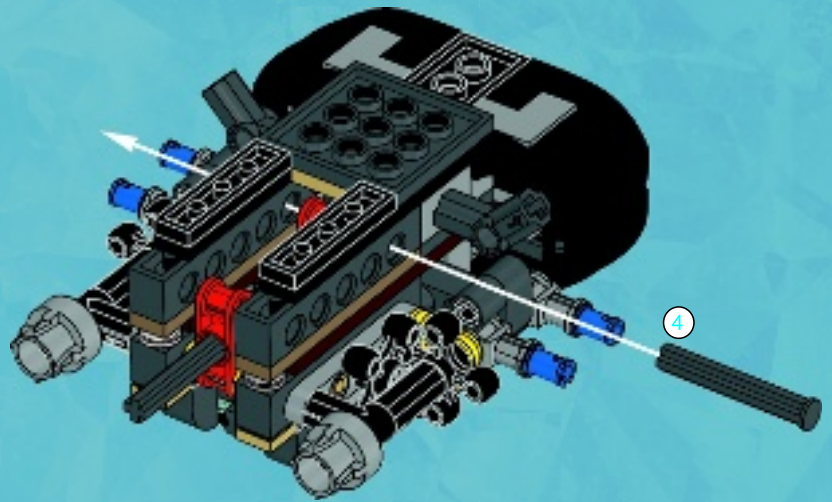

35

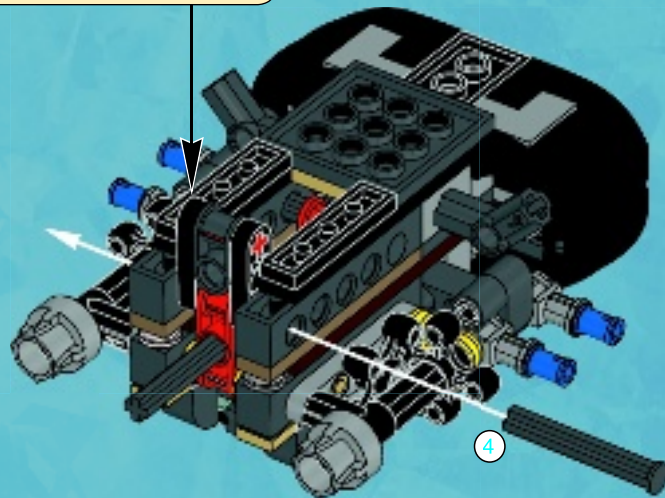
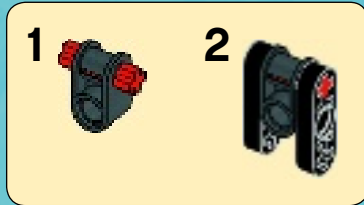

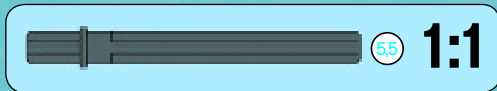
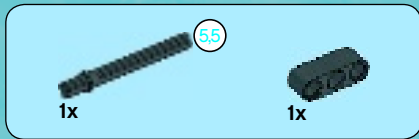

36

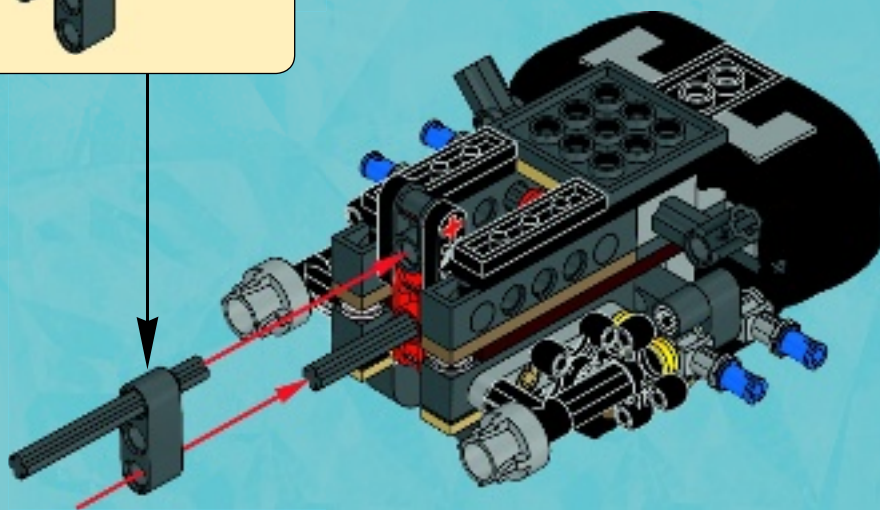
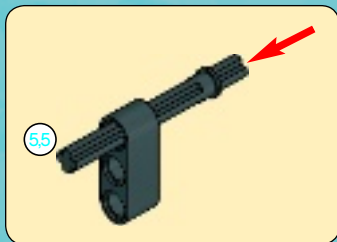



2x

37

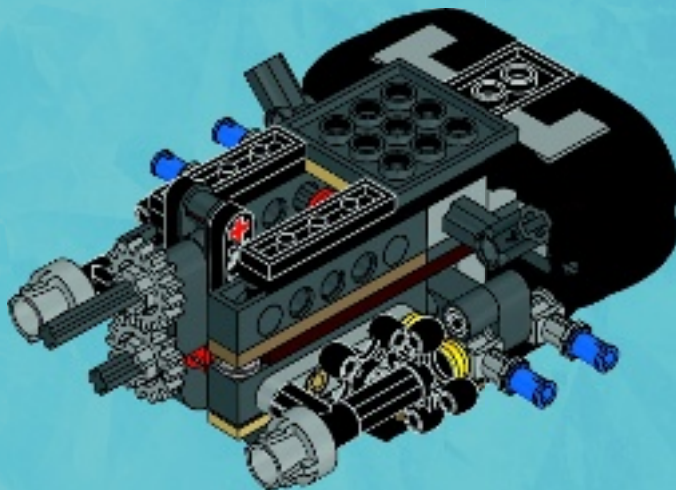

1x



1x

38

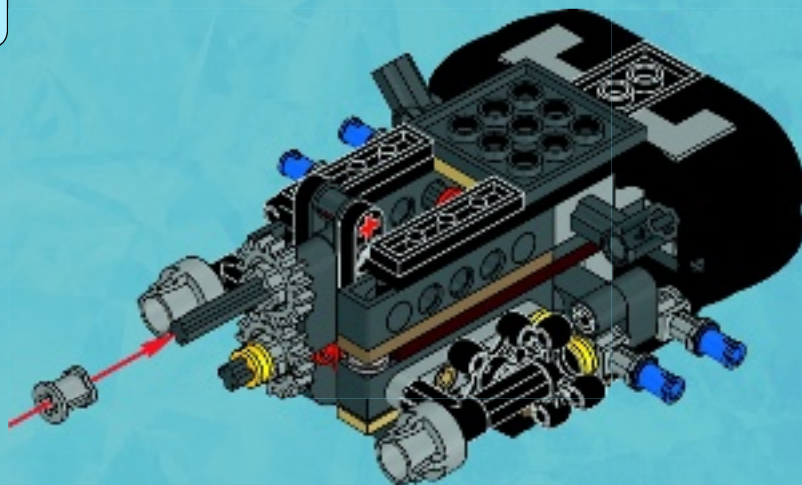



1x

39

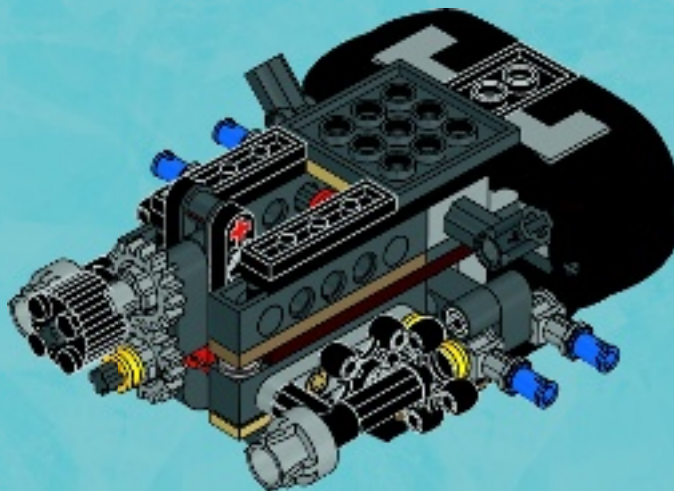

2x

40

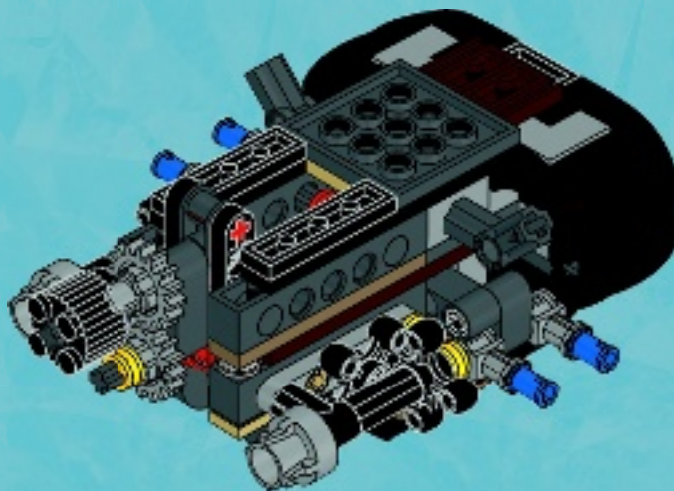



1x



1x

41

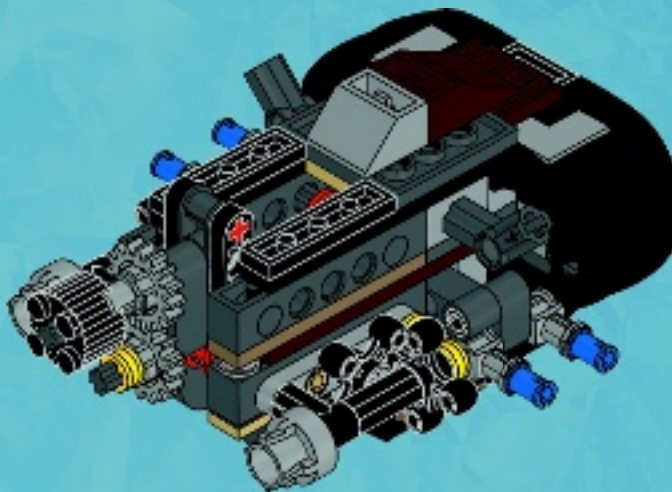

1x

42

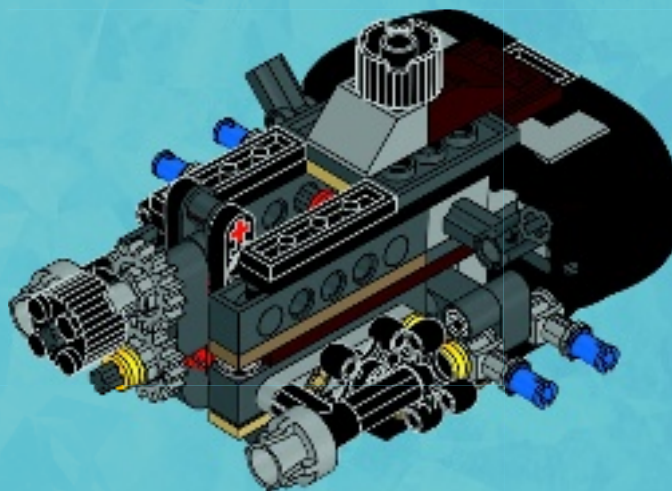

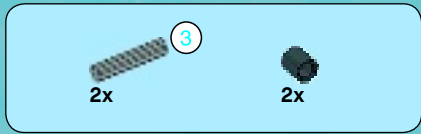

43

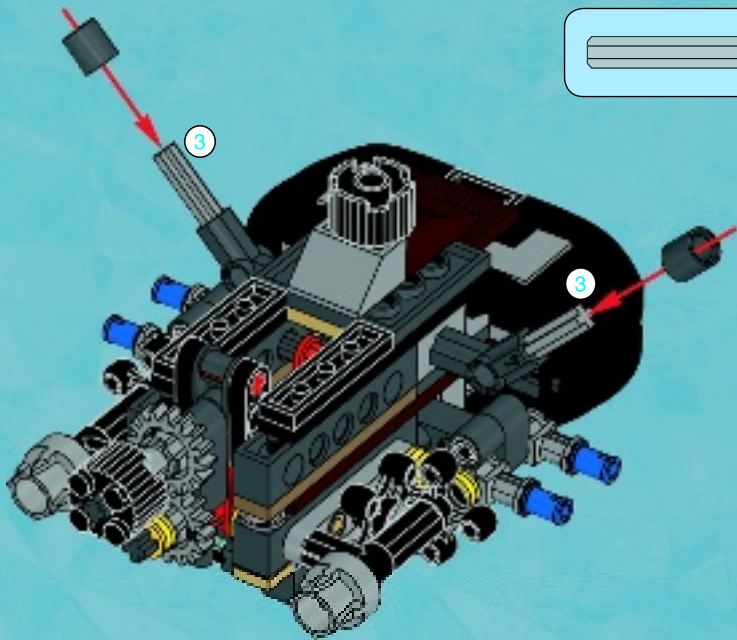
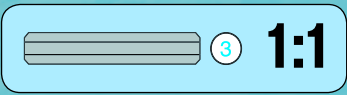

44

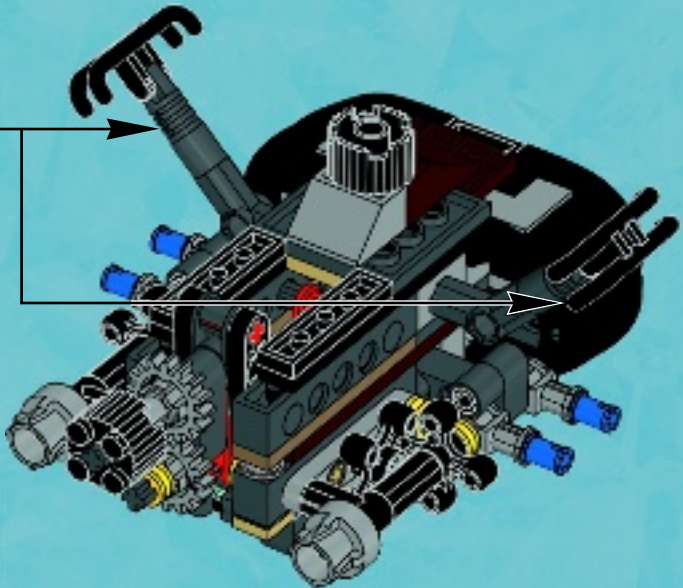
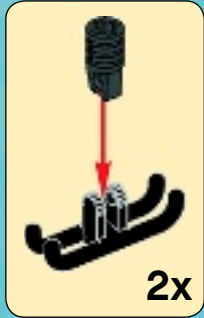



1x

45

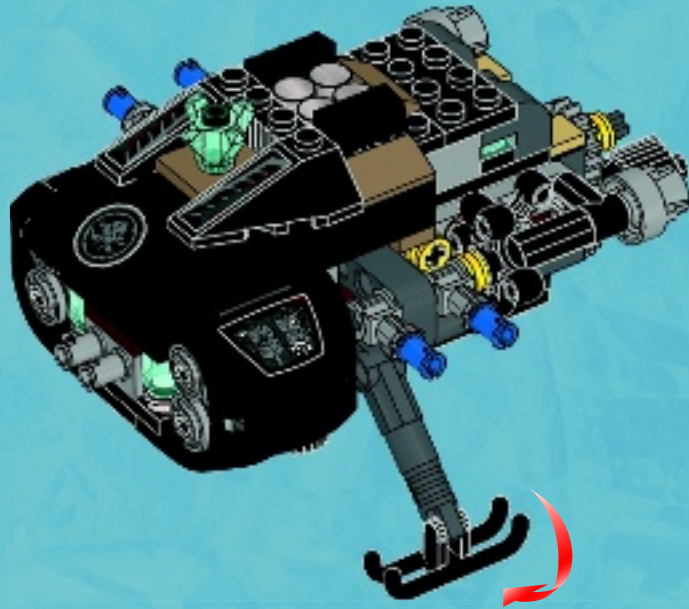
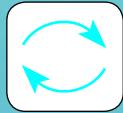

46

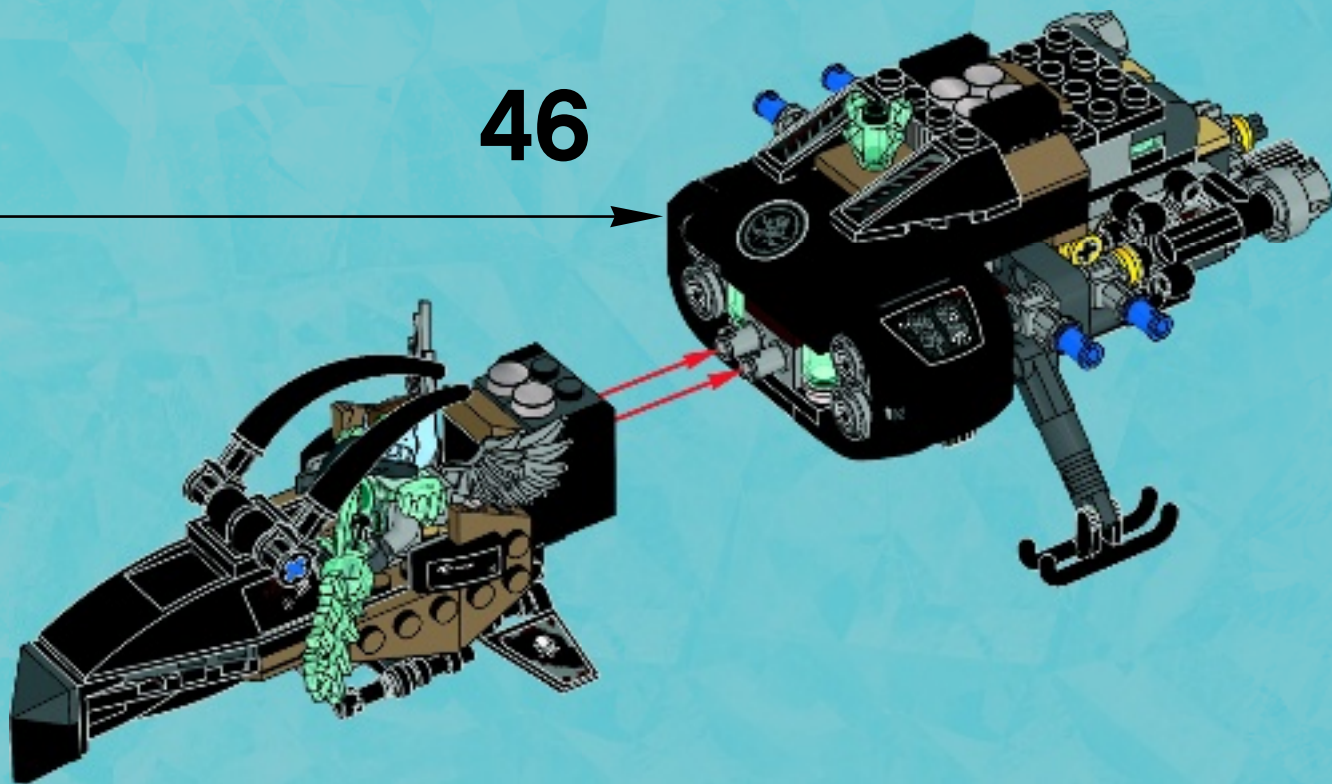

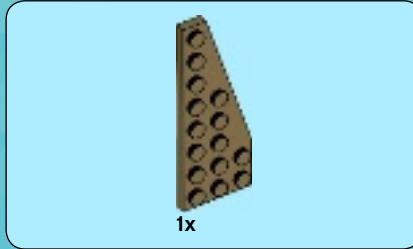
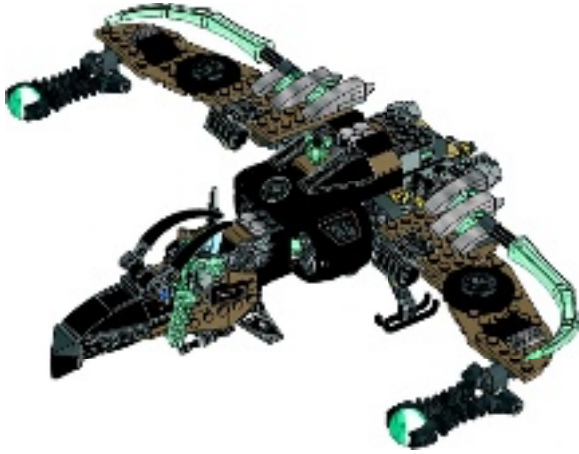

1x

1

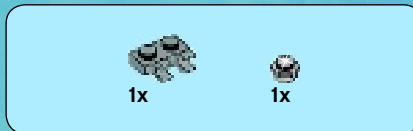
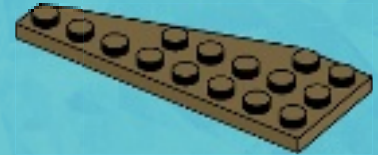

1x

1x

2

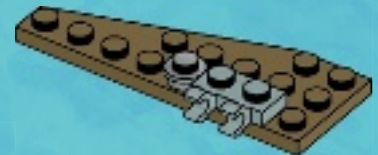

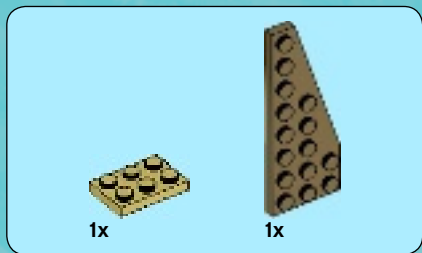

3

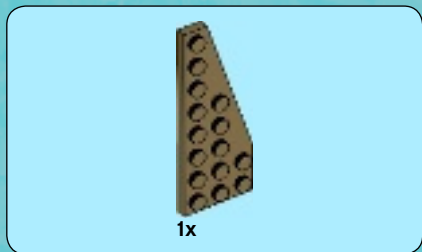

4

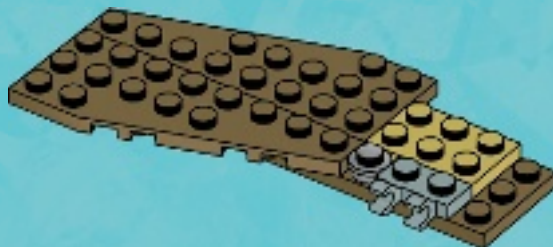



2x

5



1x

6





7

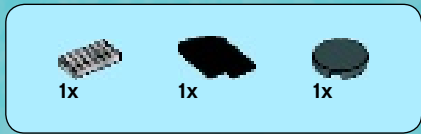
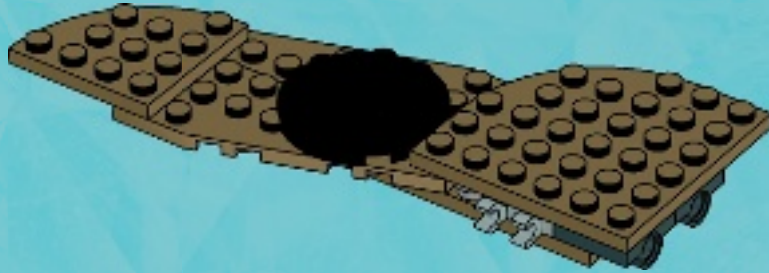

8

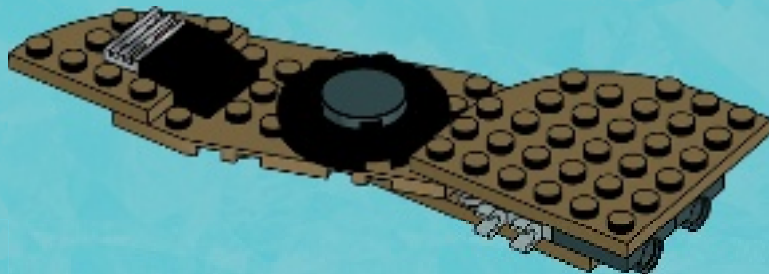



1x



1x



1x

9

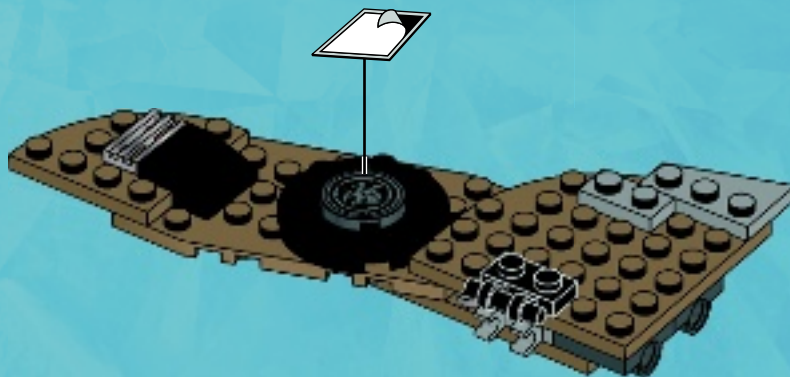

1x



2x

10





11

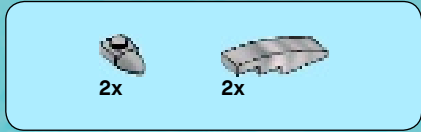
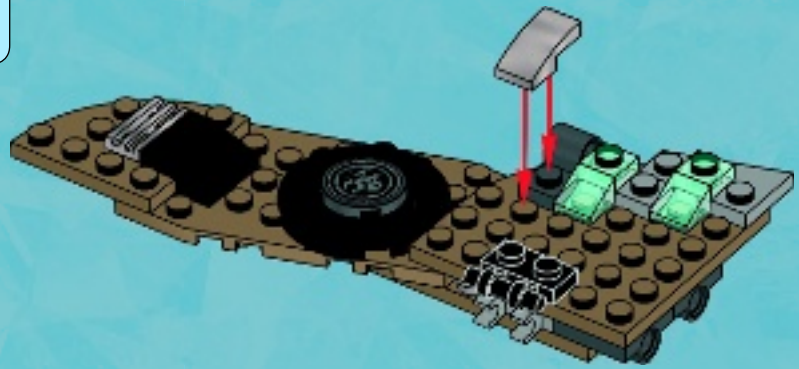

12

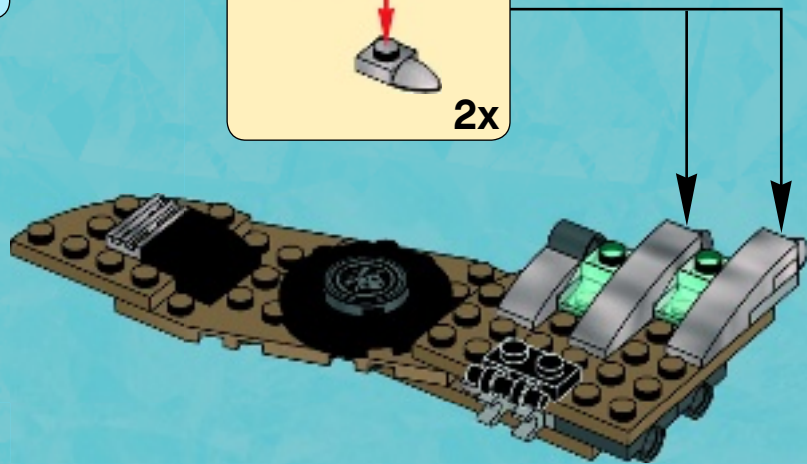
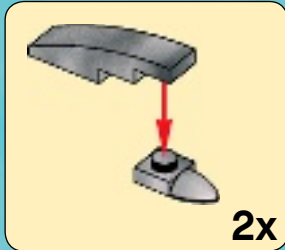

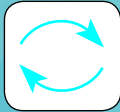

13

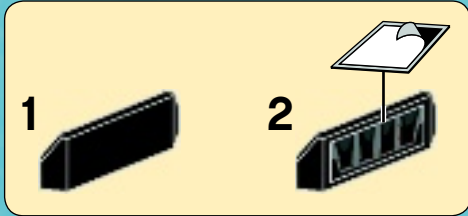
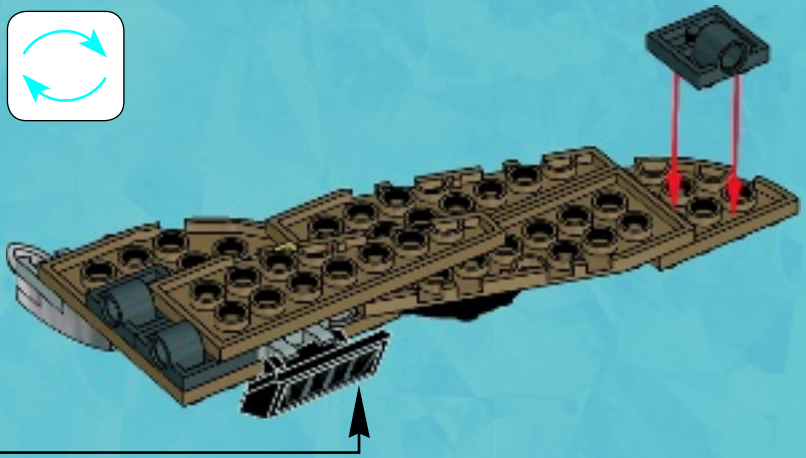

14

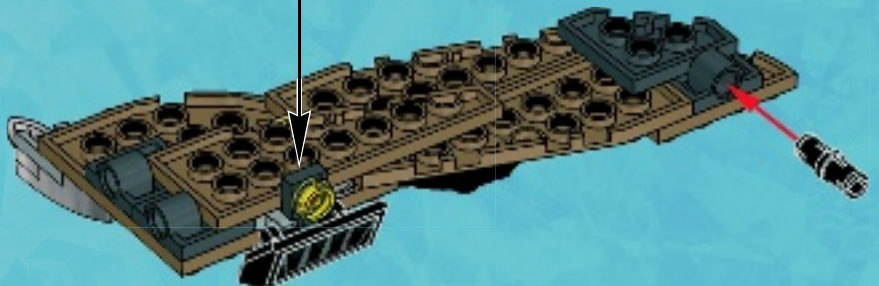

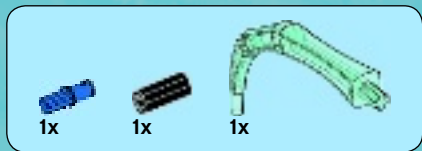

15

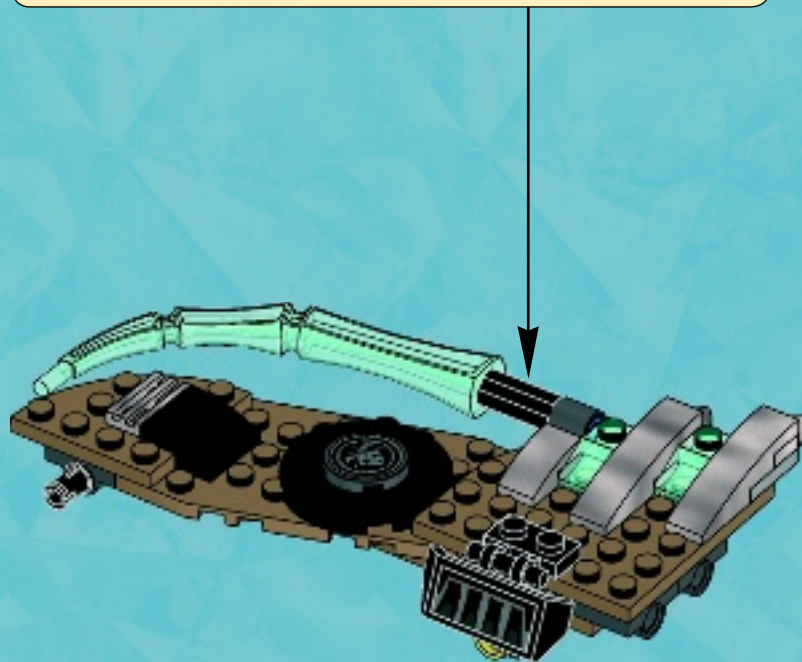
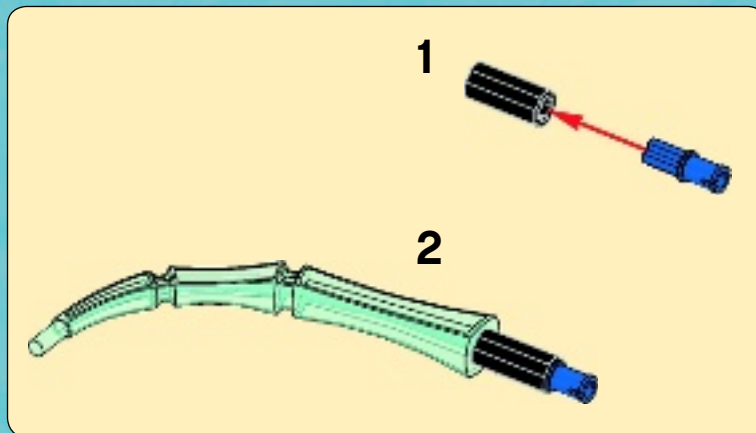

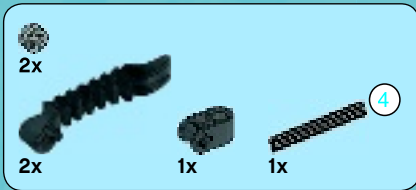

16

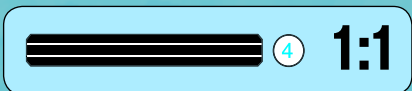
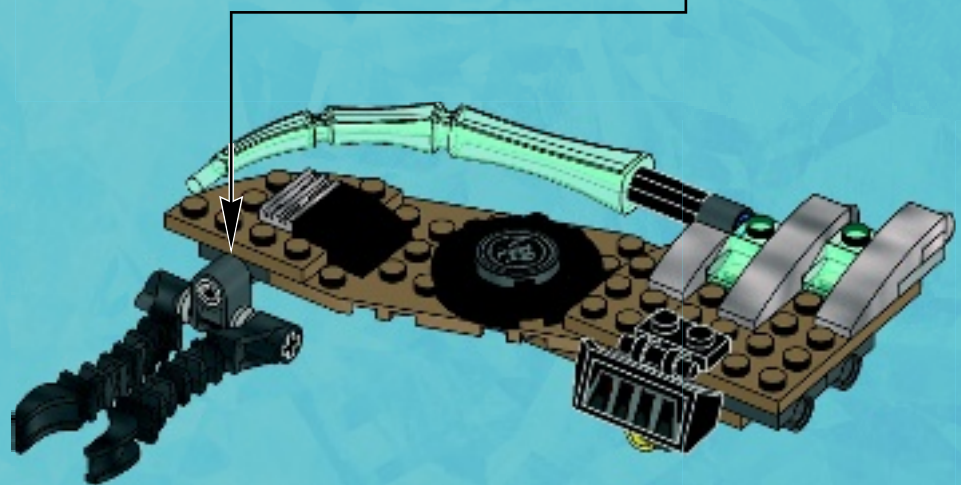
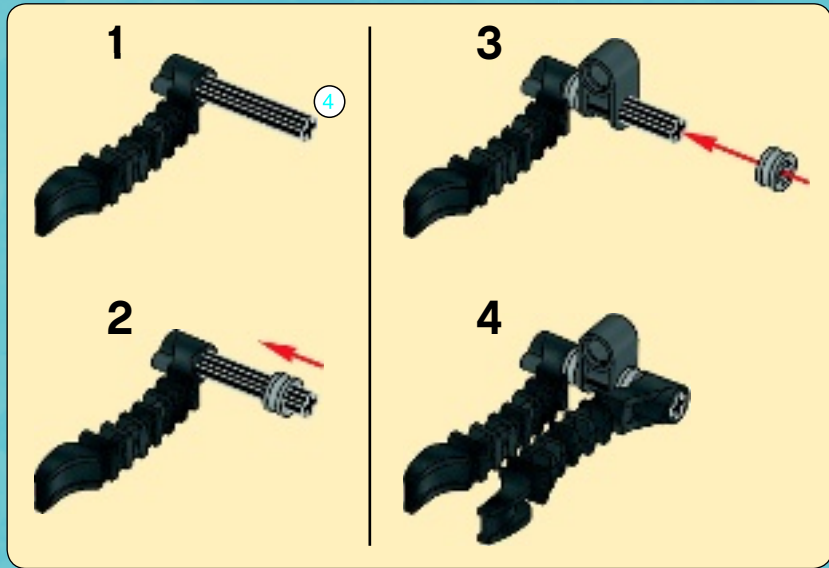

47

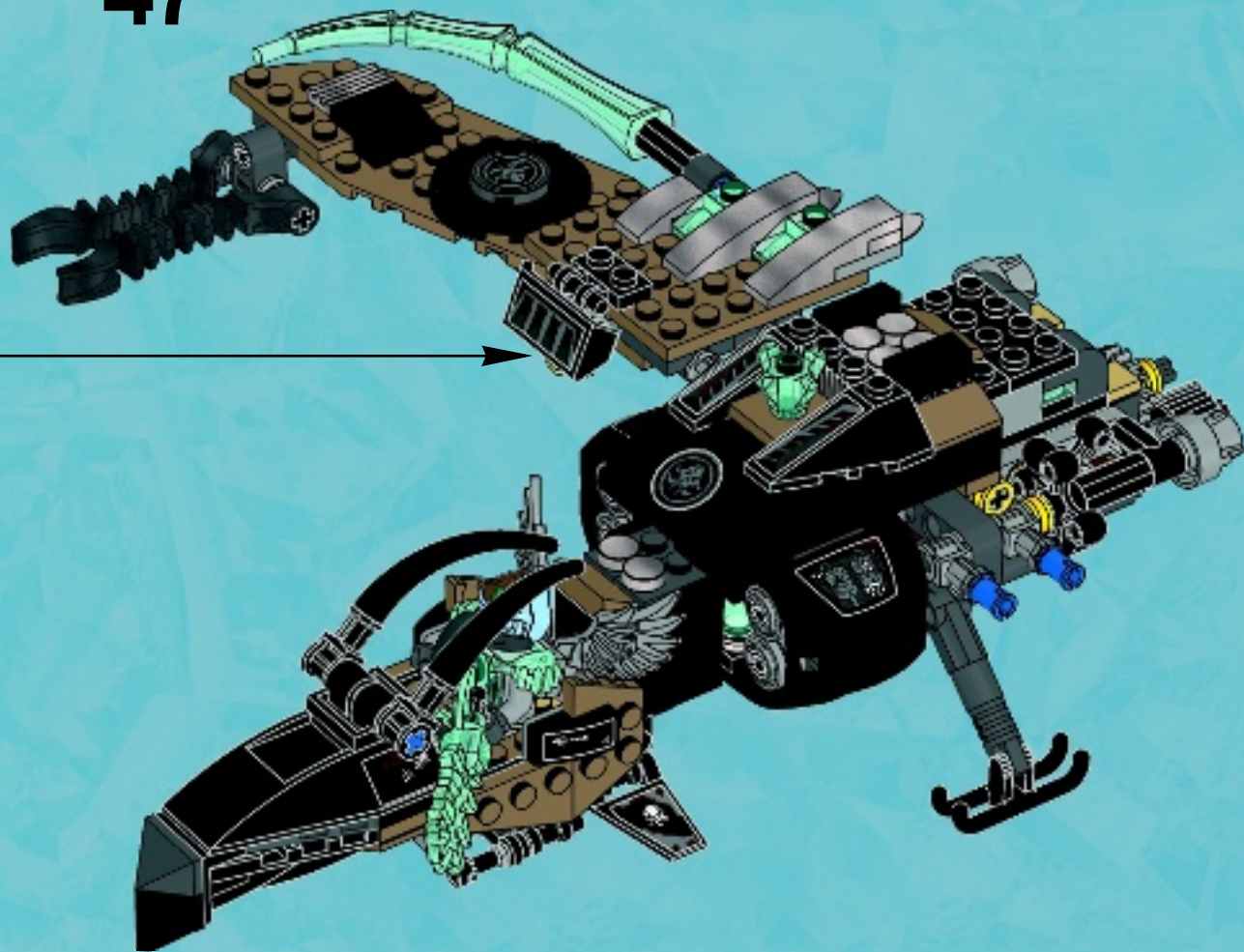

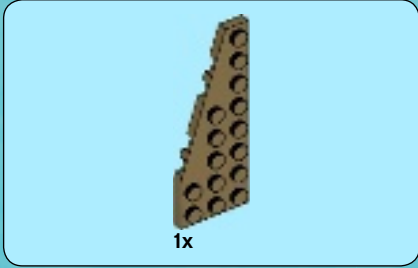
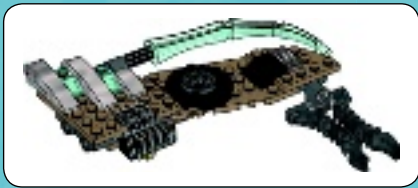

1



2

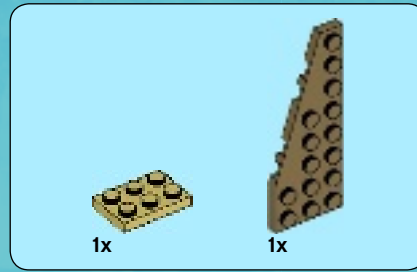
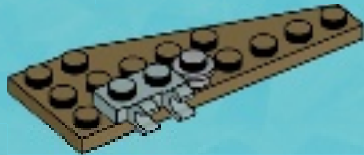

3



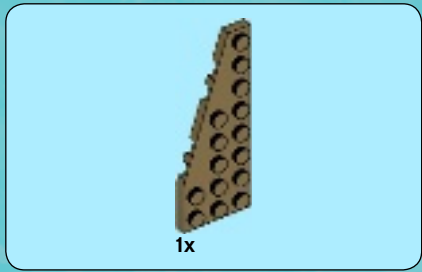

4



5

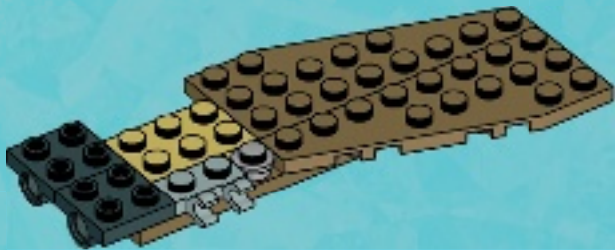

6





7

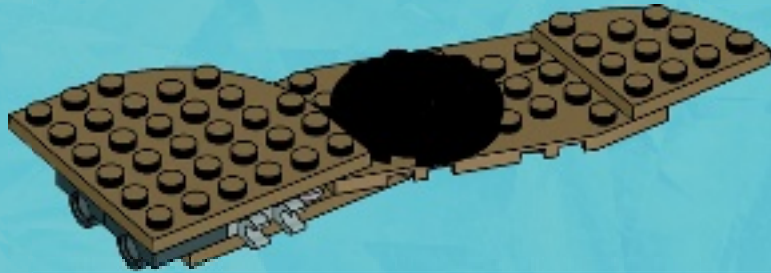

8





9

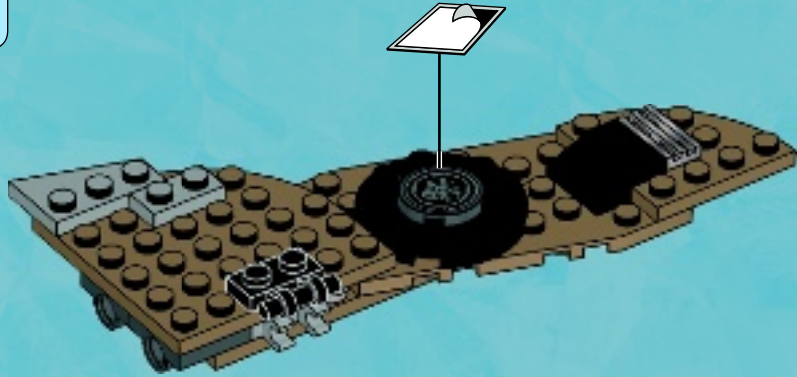

10





1x



2x

11



2x



2x

12

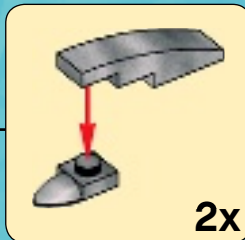



13

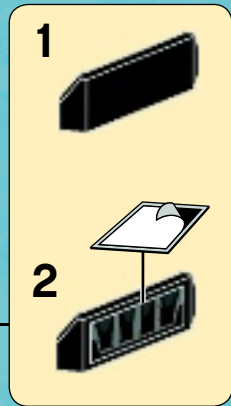
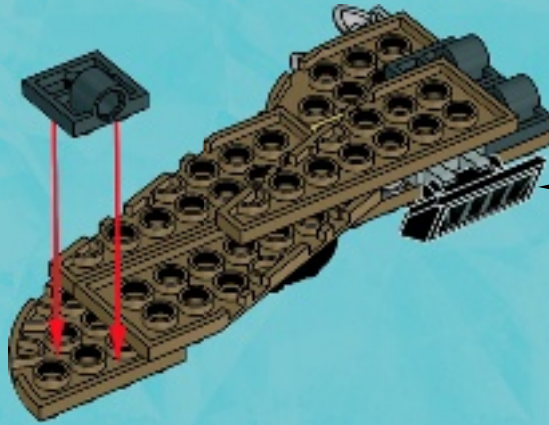

14

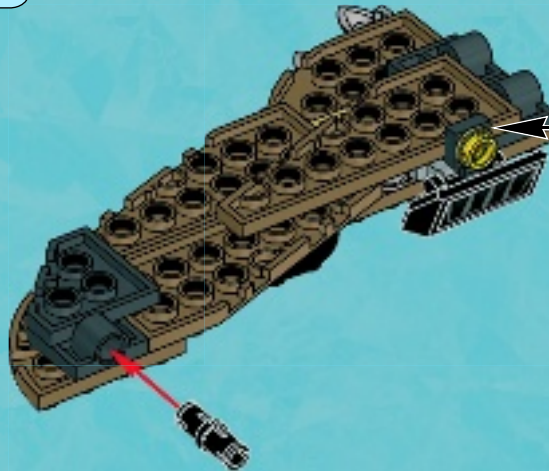

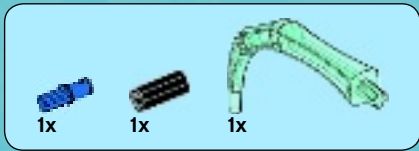

15

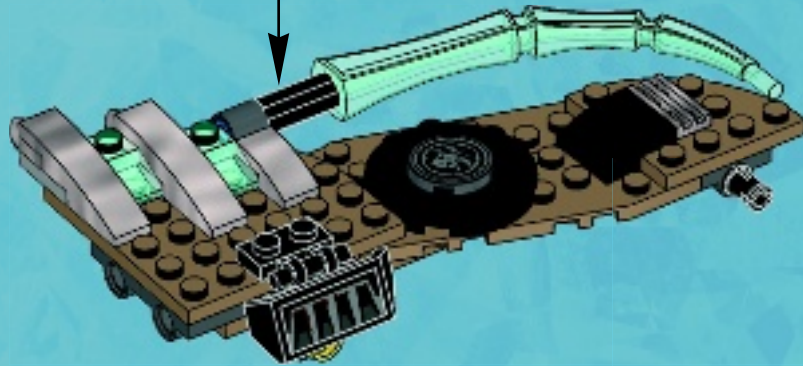
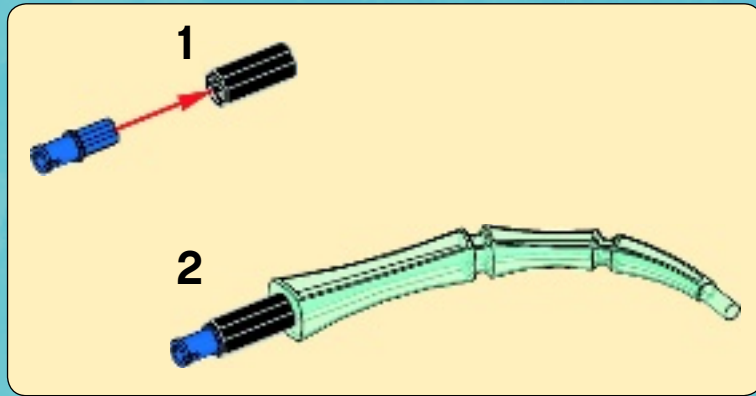

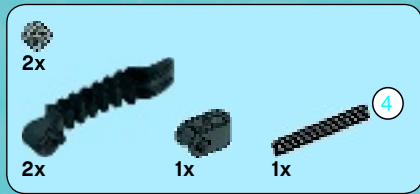

16

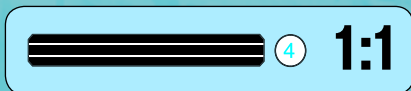
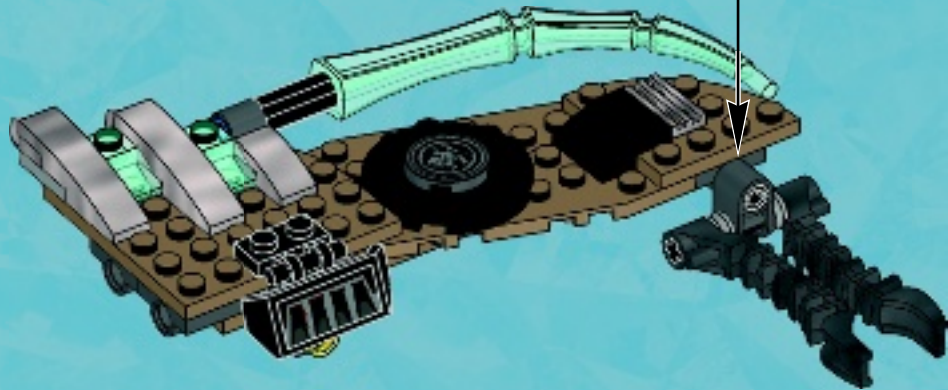
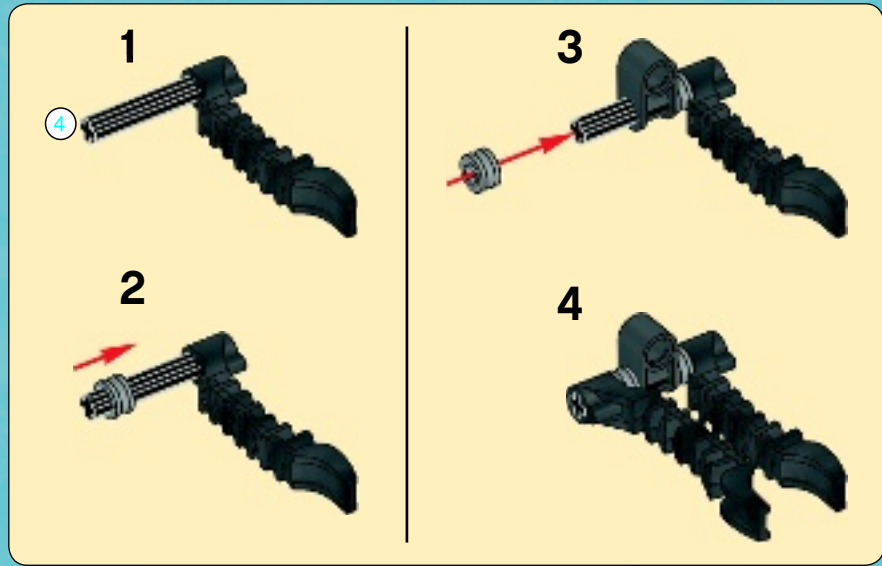

48

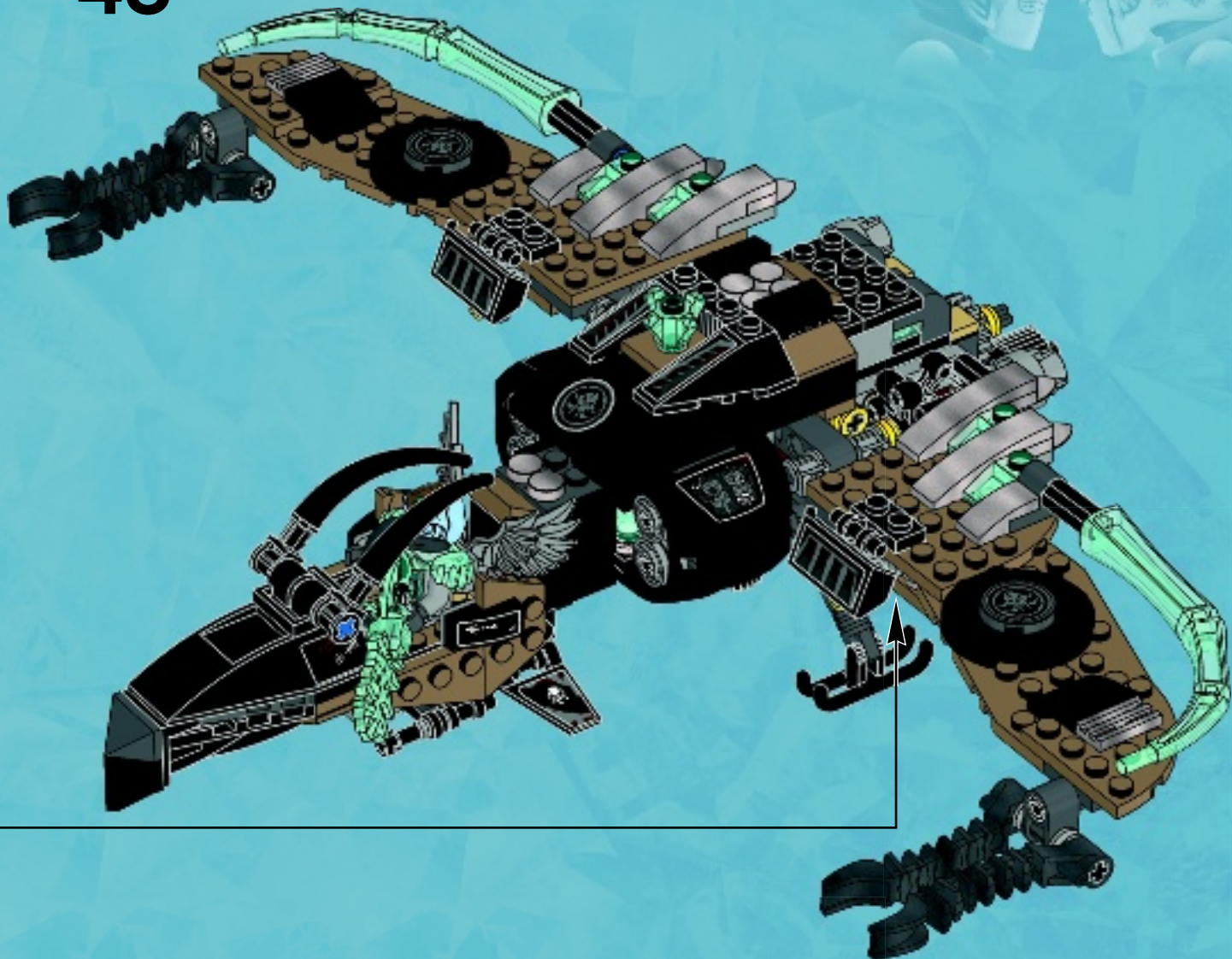



2x



49

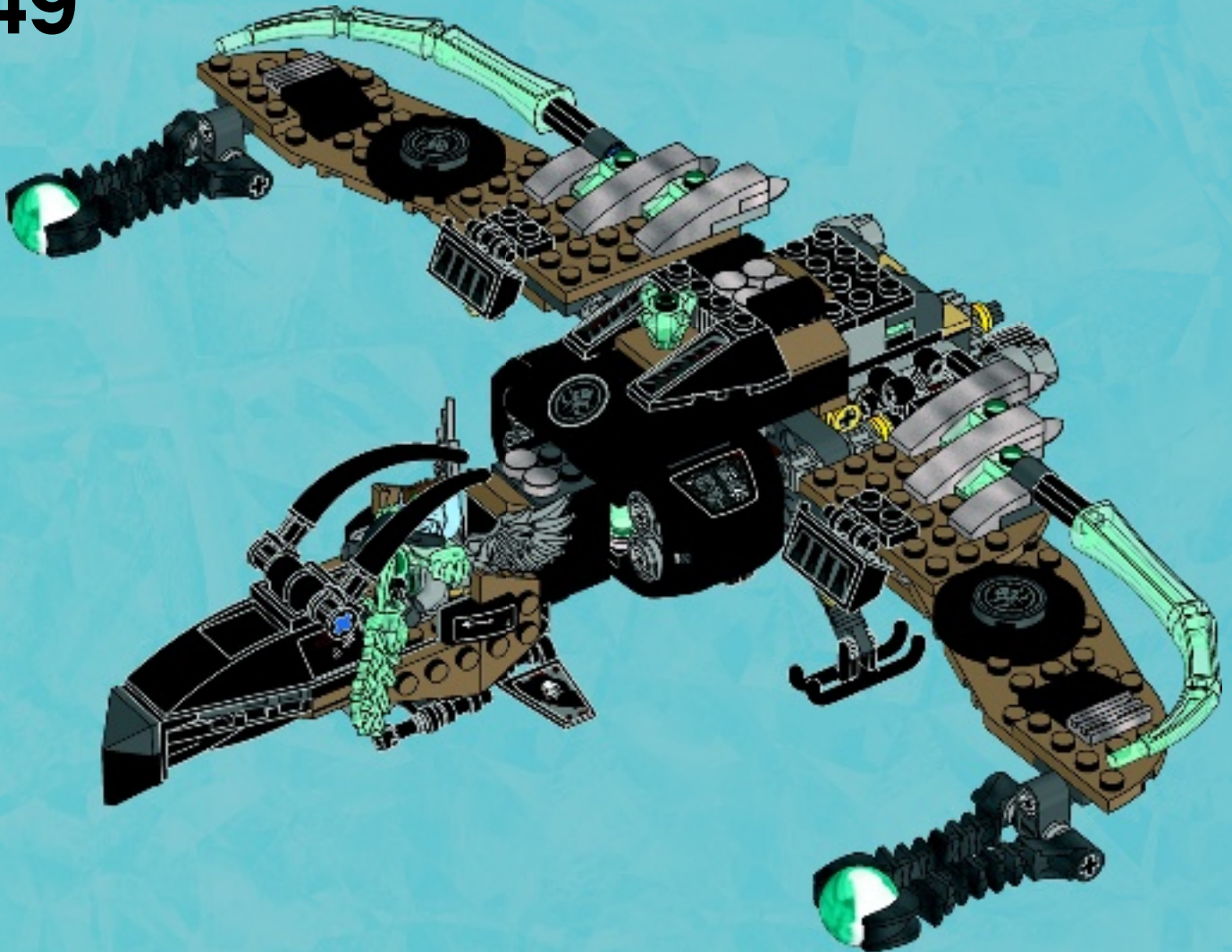

50

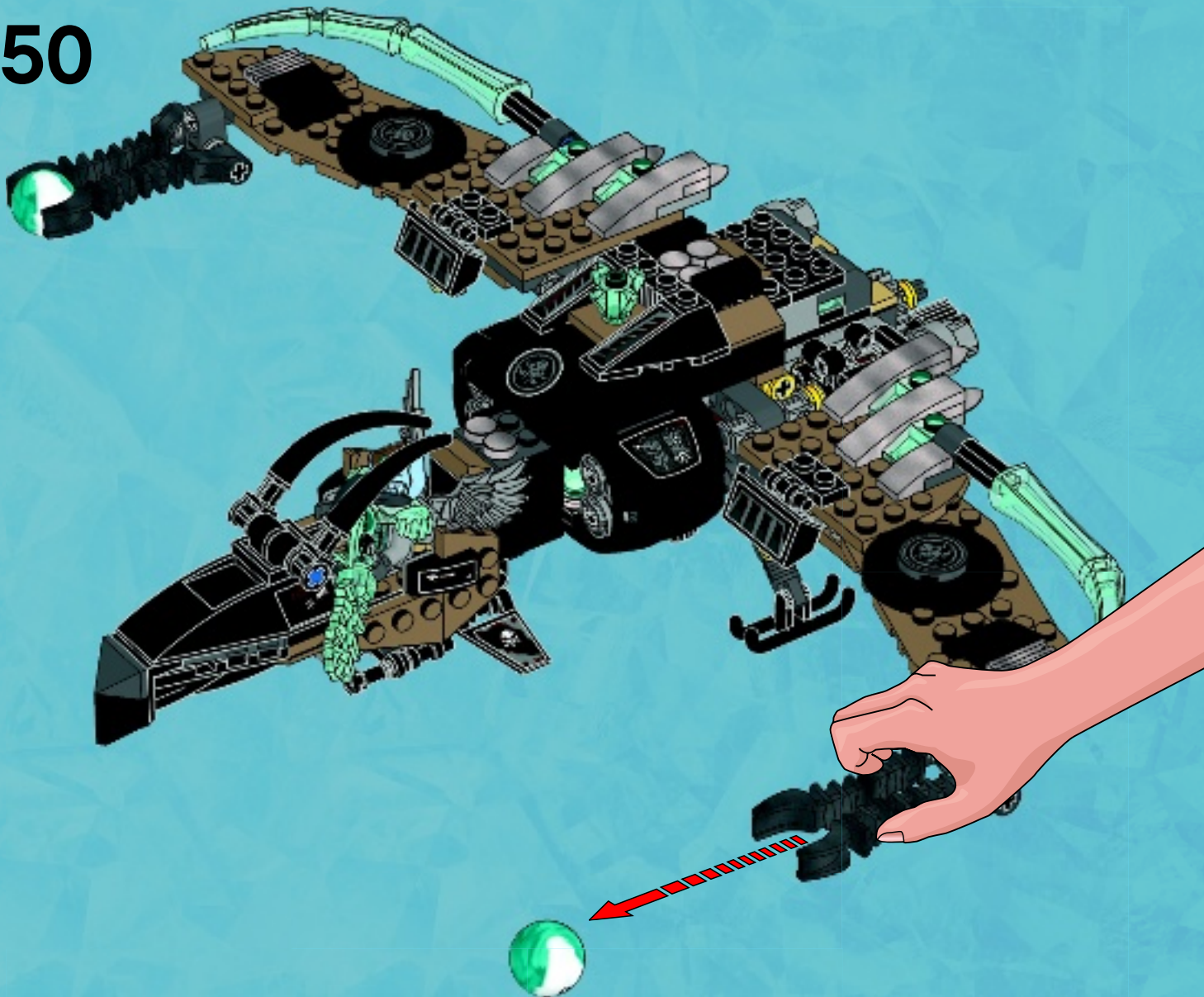

51

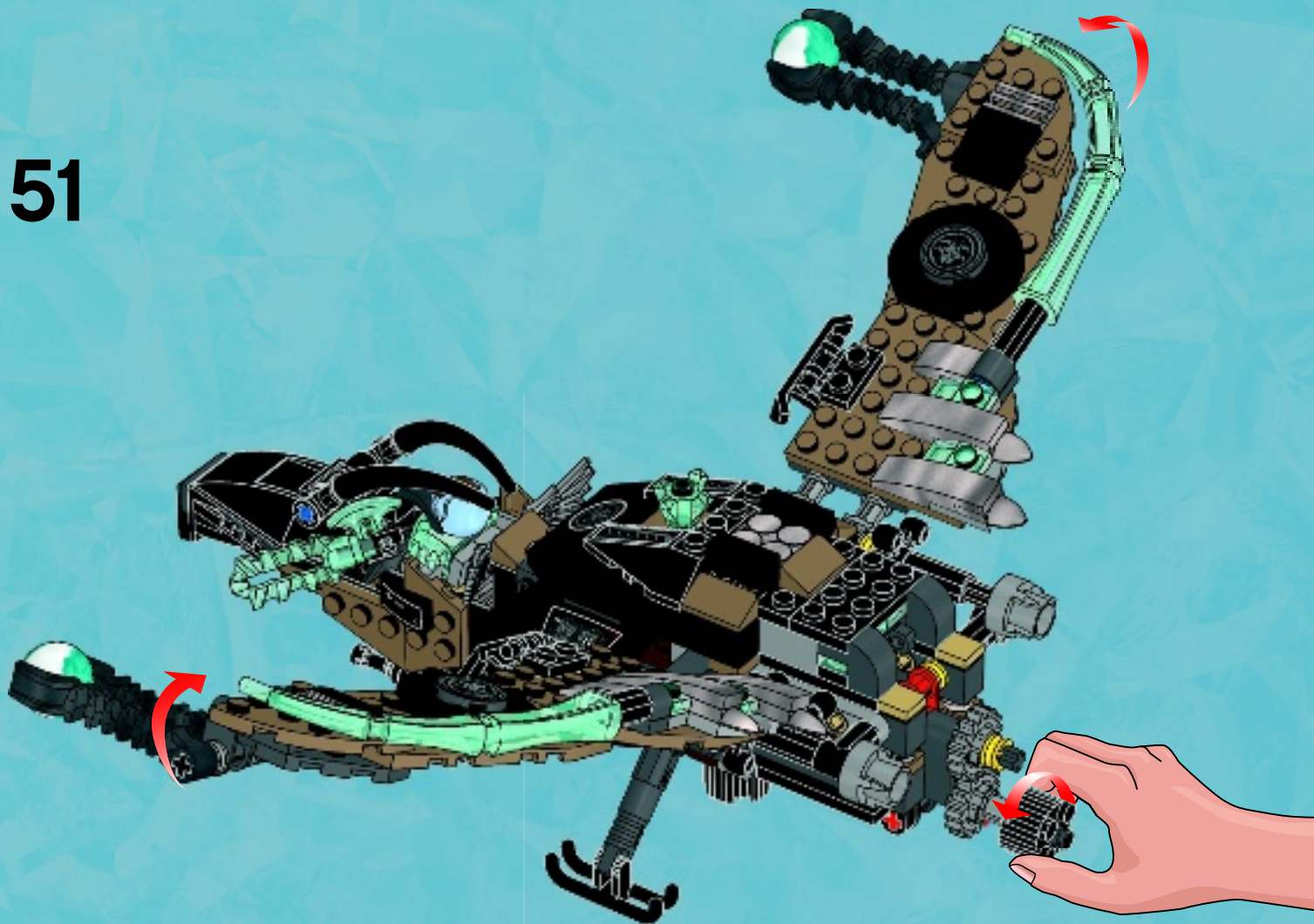

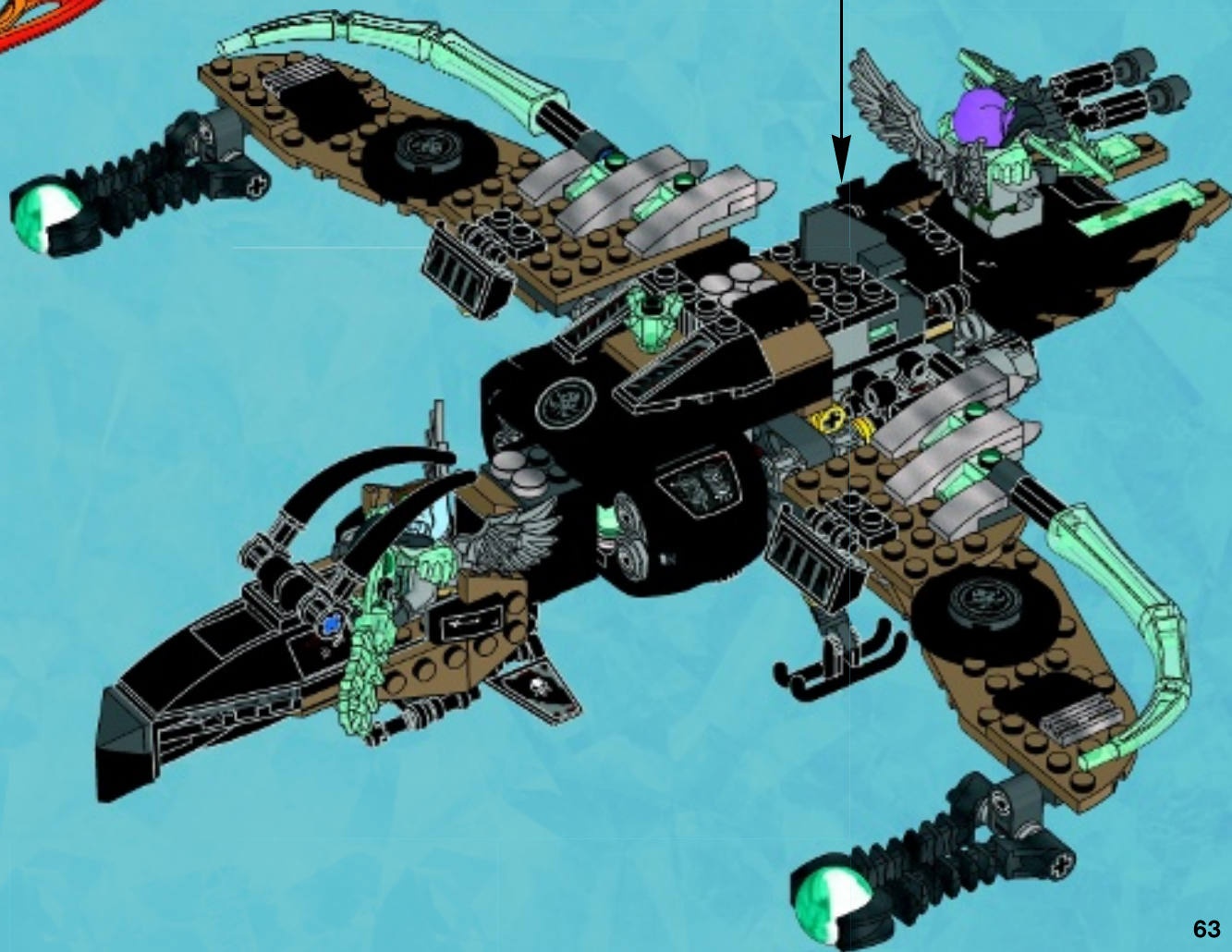
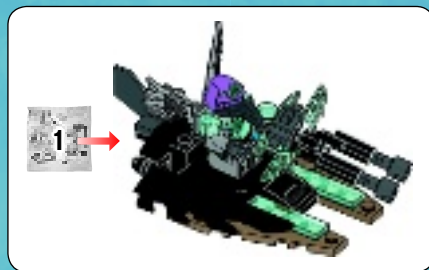





5x
4211394



1x
6028811



2x
4529241



4x
4233493



1x
4211660



1x
4211436



8x
4211398



2x
6065824



4x
6071229



1x
4515341



4x
4654580



2x
4654582



2x
4556157



2x
4515369



1x
4211791



1x
4211794



2x
4221775



1x
6075649



1x
6101835



1x
6075646



1x
6103688



4x
6074698



2x
4503416



4x
4211573



2x
4211622



3x
4278756



4x
4211553



1x
4211510

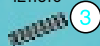

2x
4211815



2x
4211805



2x
4640536



4x
4211758



1x
4211552



1x
6099909



4x
4210917



1x
6076203



2x
4211076



2x
4210797



1x
4648256



2x
4211055



2x
4243831



5x
6071226



3x
4579354



2x
4587212



1x
4210892



2x
6019987



2x
6048854



10x
6047417



2x
6056296



1x
4596895



2x
4210897



1x
4582820



2x
4210694



1x
4210631



2x
4210667



2x
4210751



4x
6100030



1x
6012451



3x
4210851



2x
4210688



2x
6005030



3x
4508553



1x
4499858



2x
4610374



1x
6103678



1x
6103640



6x
6083865



3x
6046943



8x
6047037



2x
6058221



2x
4654915



1x
6068035



3x
4519946



2x
6005030



2x
4650257



2x
6071262



1x
6063706



4x
6051183



1x
6061594



3x
4619636



10x
4633691



6x
4655241



2x
6047418



4x
6078607



4x
4625146



4x
6021670



1x
6075229



1x
6070630



2x
6071259



1x
6019984

Customer Service

Kundenservice

Service Consommateurs

Servicio Al Consumidor

LEGO.com/service or dial



: 00800 5346 5555

: 1-800-422-5346



LEGENDS OF CHIMA™



WORRIZ

70220



GORZAN

70222



CROCKENBURG

70231



FLINX

70221



RAZAR

70223



ERIS

70224



L'ELLA

70229

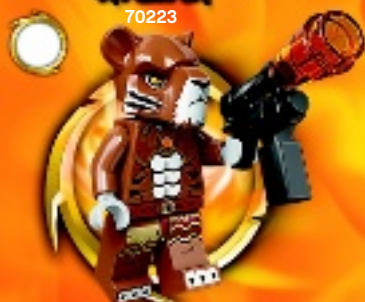

TAZAR

70224



BULKAR

70223



TORMAK

70222



SIR FANGAR
70224



SIBRESS
70224



ICEBITE
70223



ICERLOT
70230



SIROX
70232



SYKOR
70222



TRAKKAR
70224



ICEPAW
70223



STRAINOR
70220



VOOMVOOM
70221



BREEZOR
70224

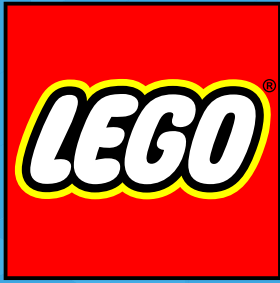

club™



LEGO.com/club

1

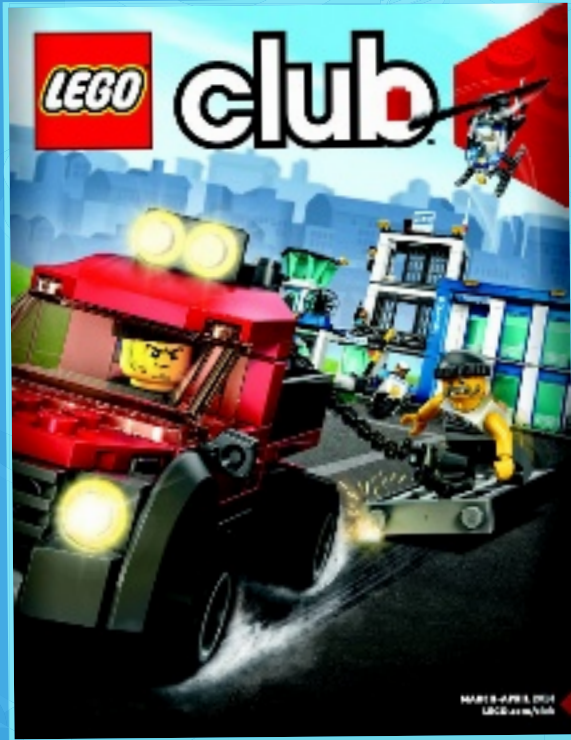

2



3

