



CITY

60434



10

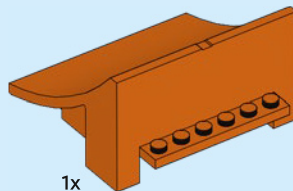
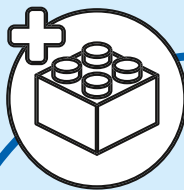

1x



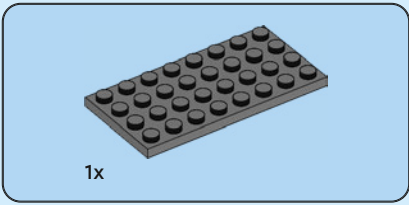

1

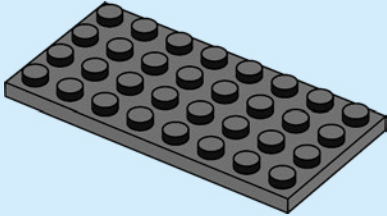

2

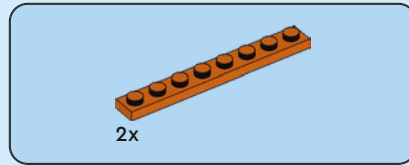
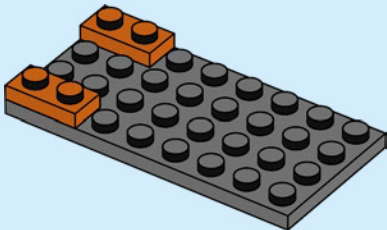

3

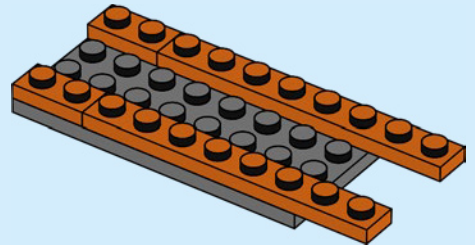

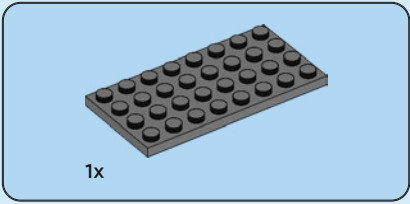

4

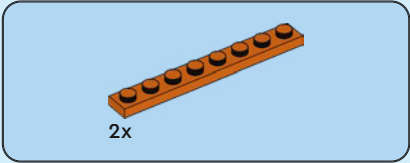
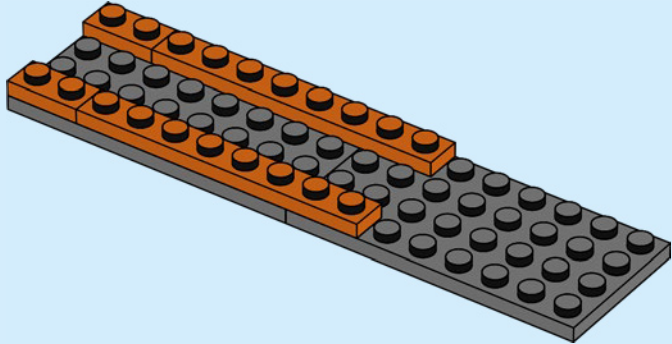

5

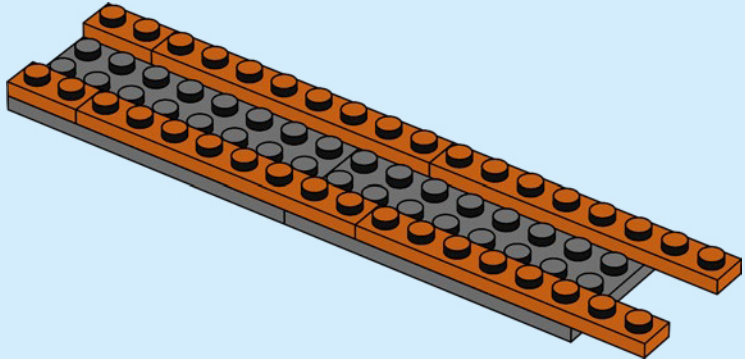

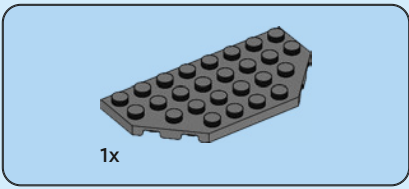

6

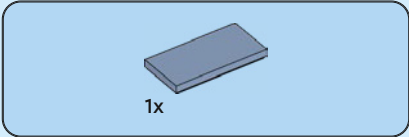
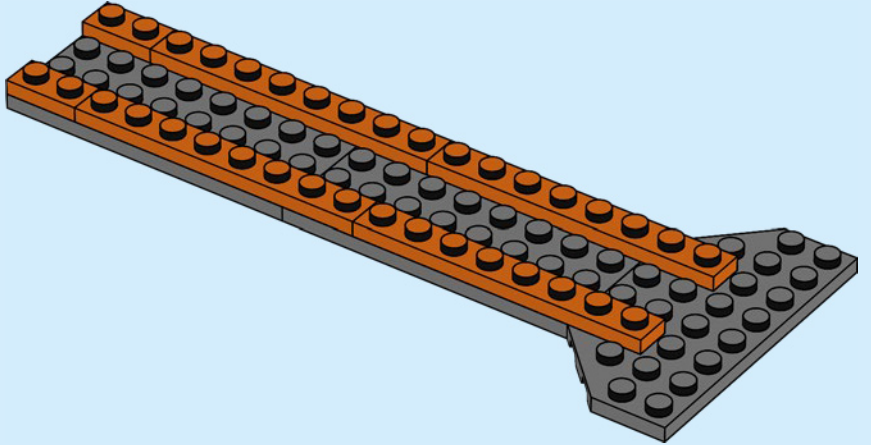

7

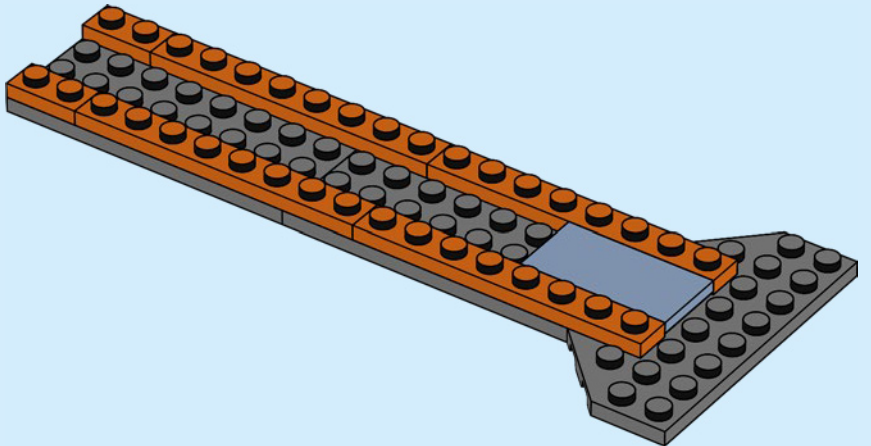

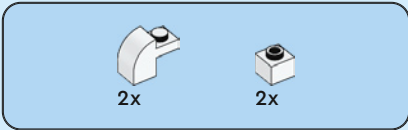

8

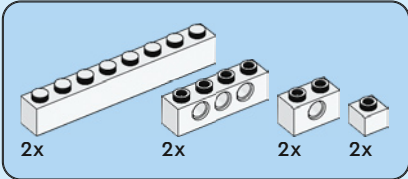
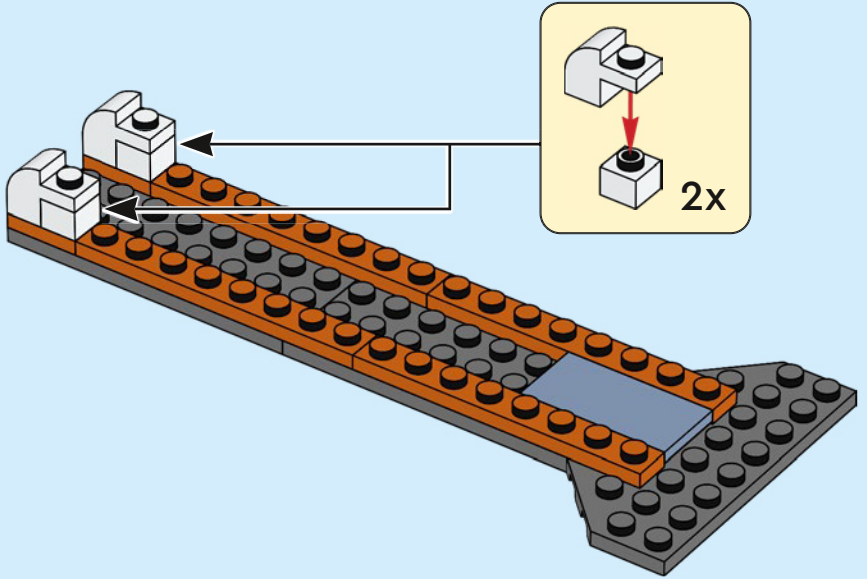

9

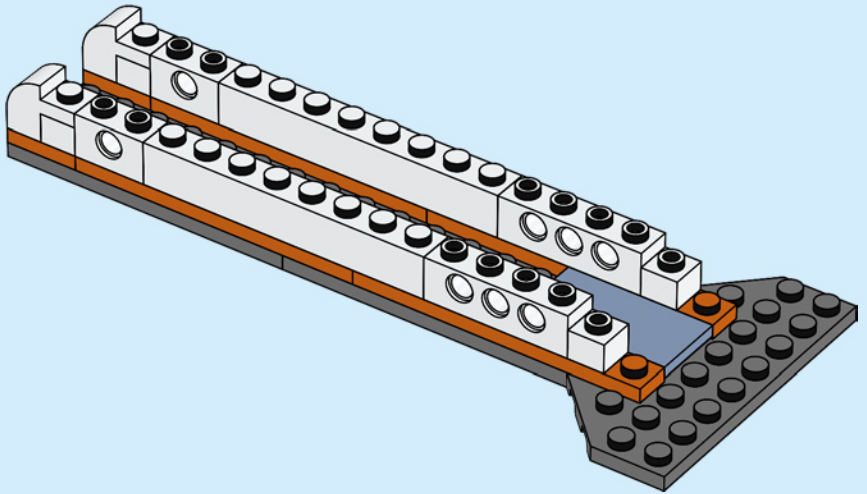



2x

10

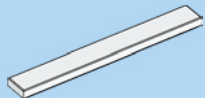
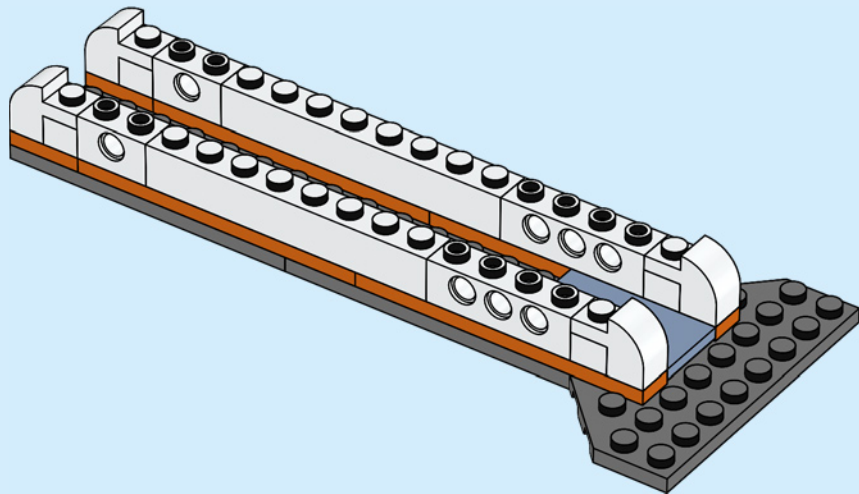

4x

11

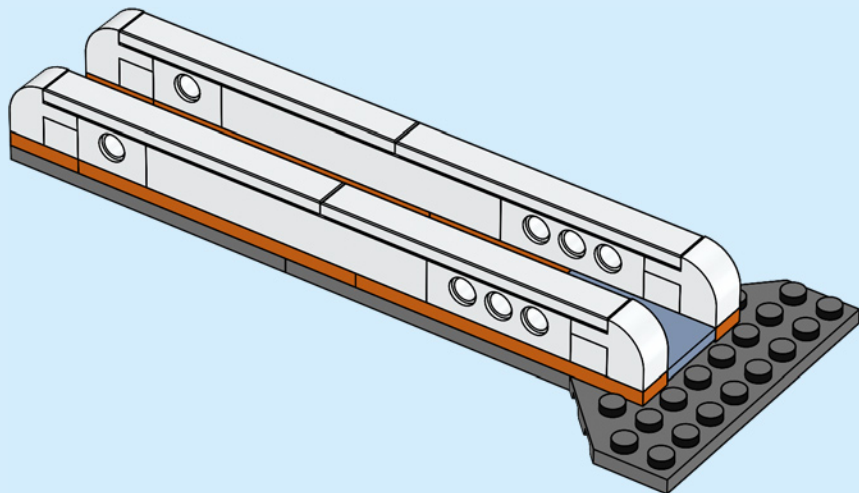



6x

12

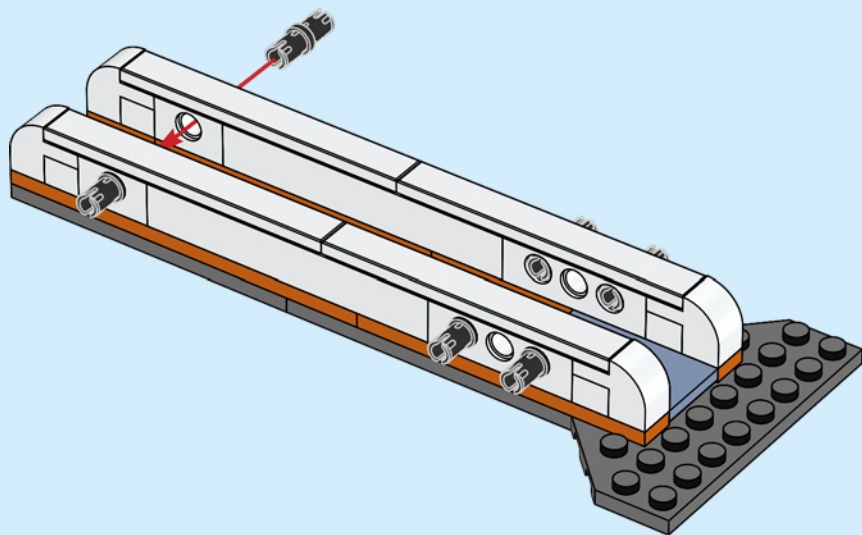



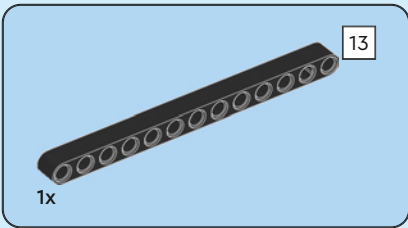

13

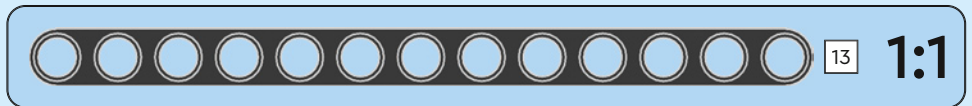
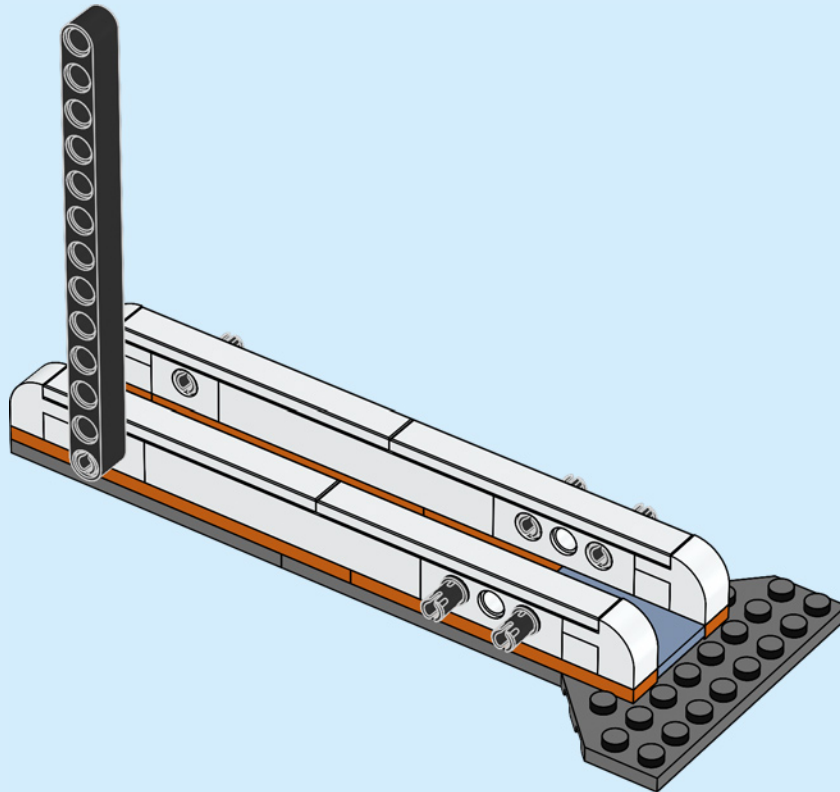

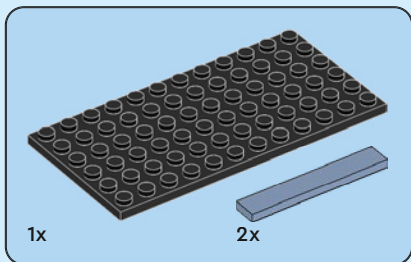
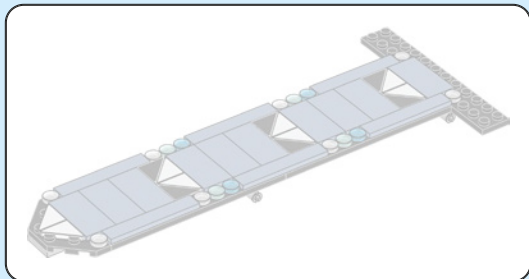

14

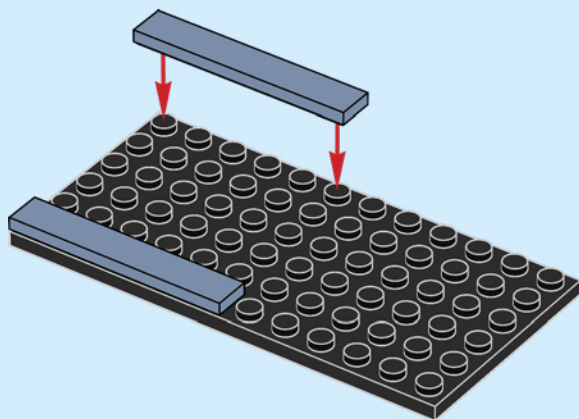

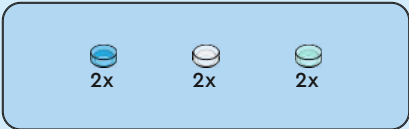

15

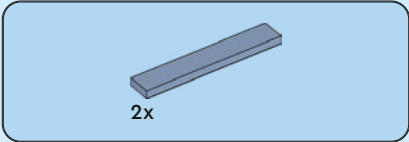
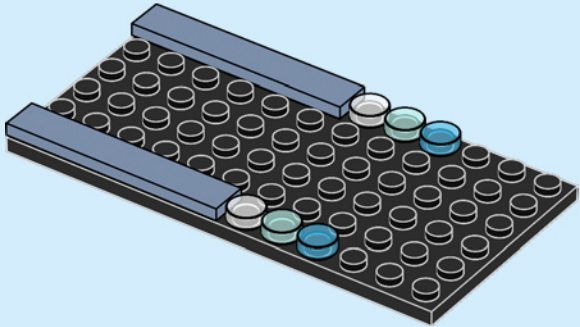

16

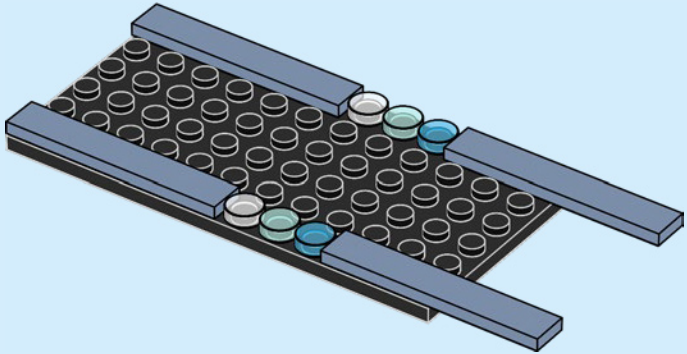

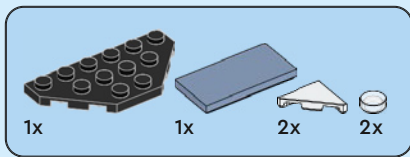

17

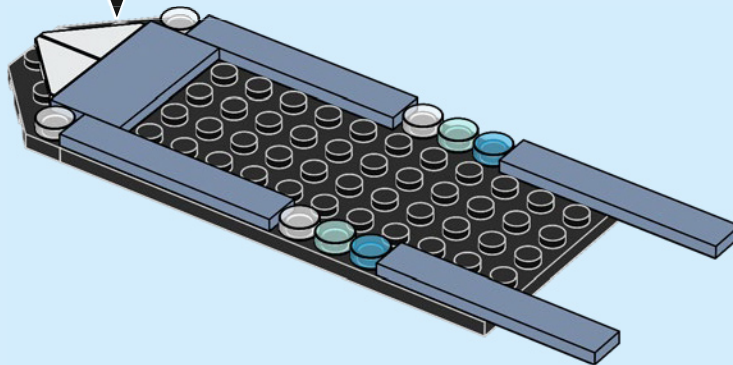
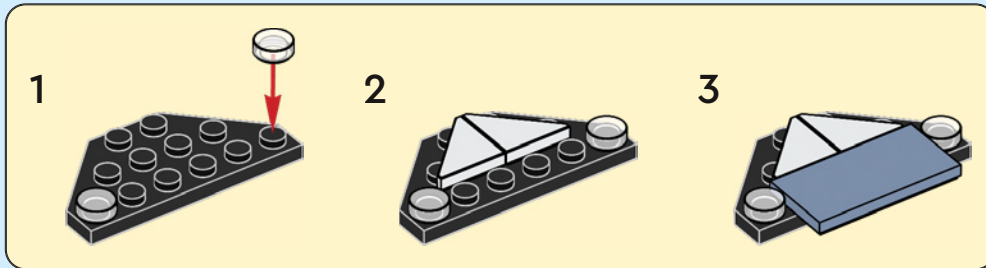

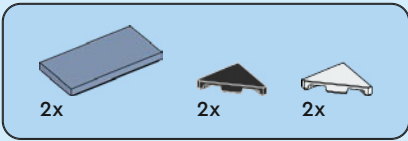

18

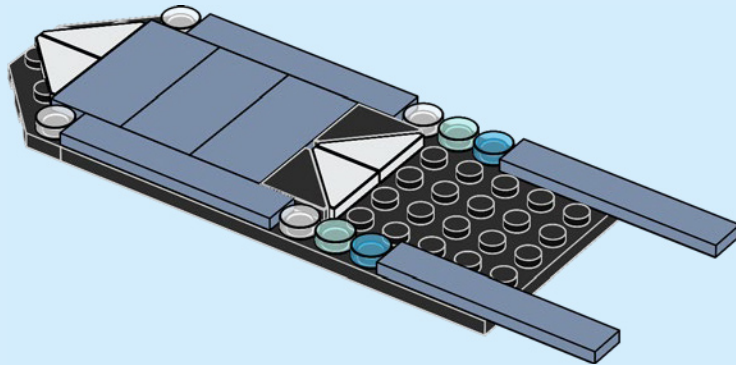

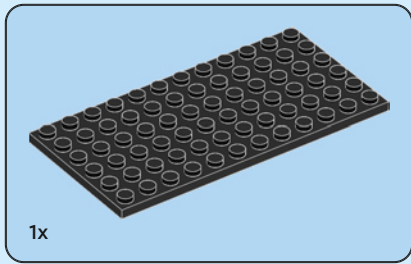

19

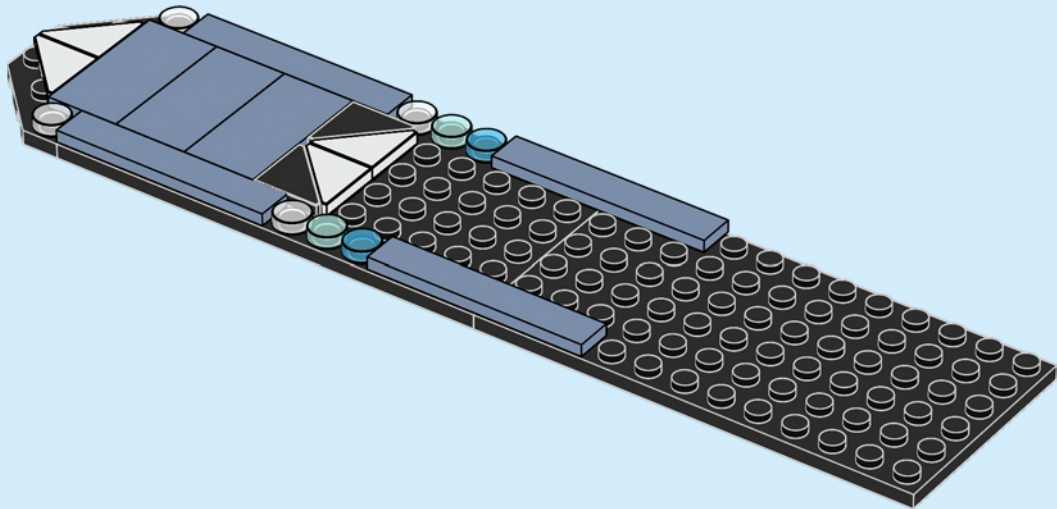

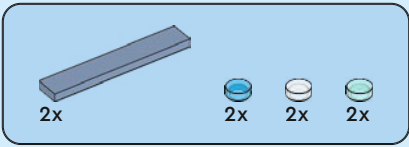

20

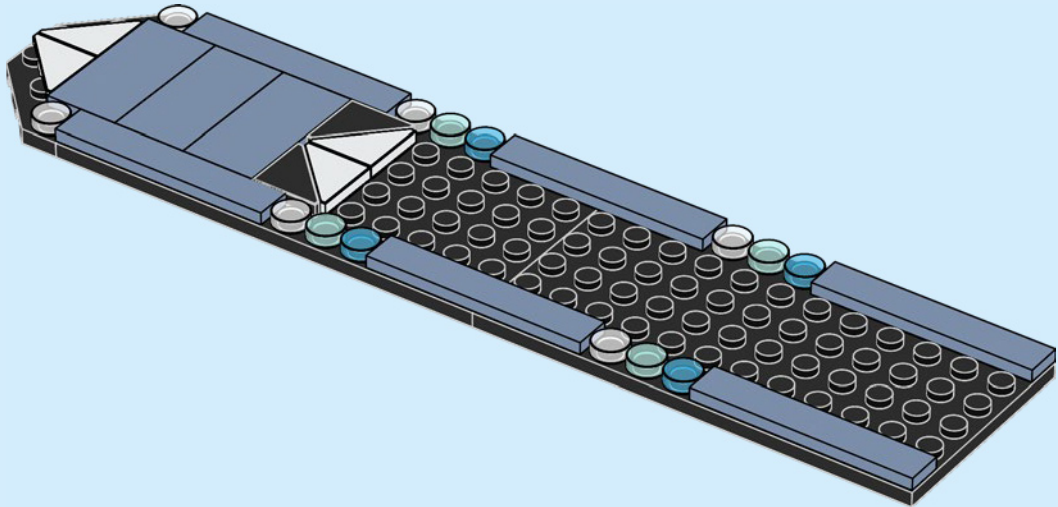

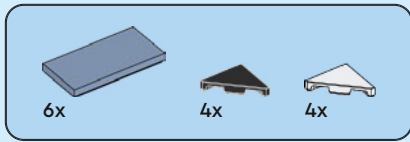

21

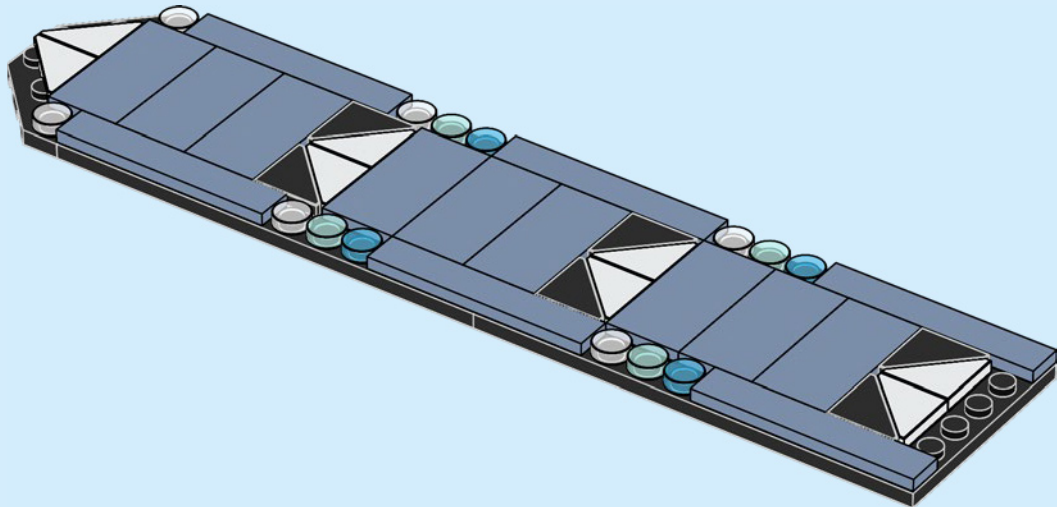



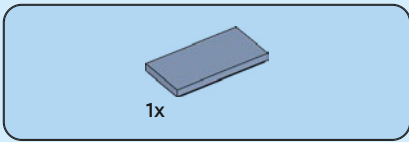

22

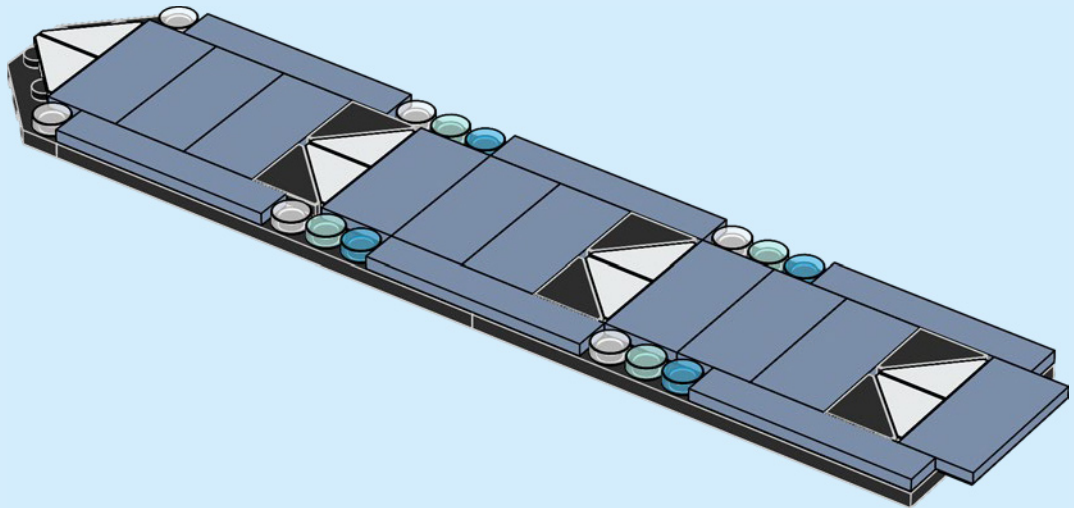

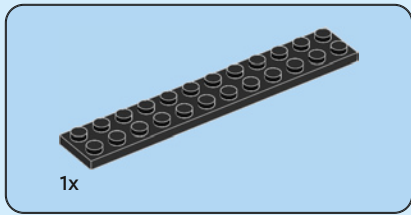

23

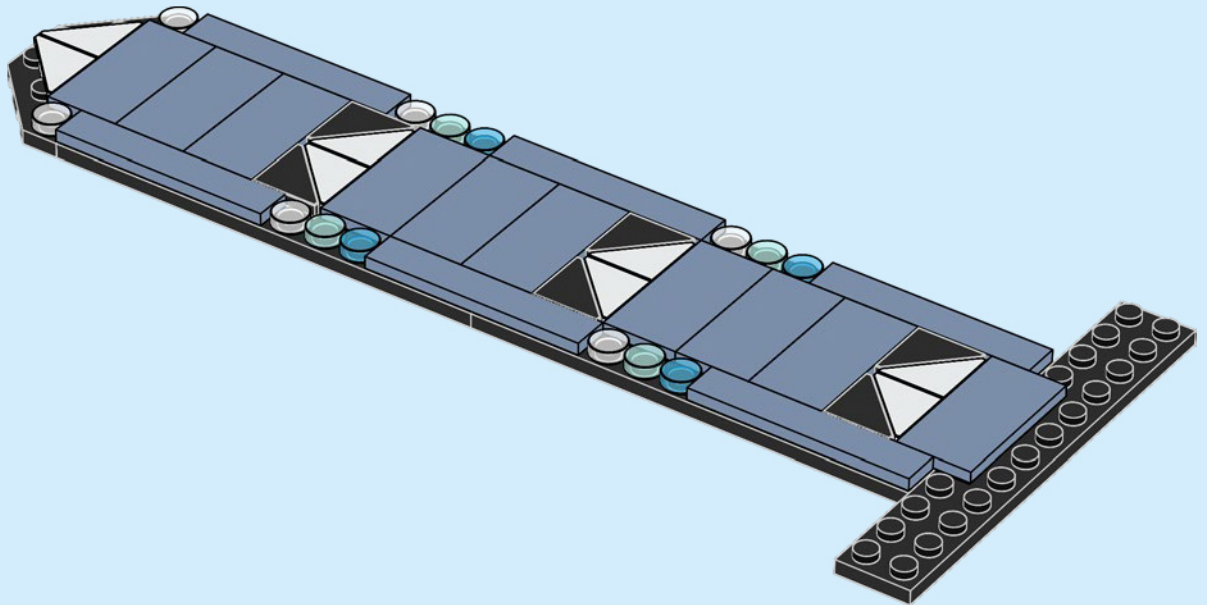



2x

24

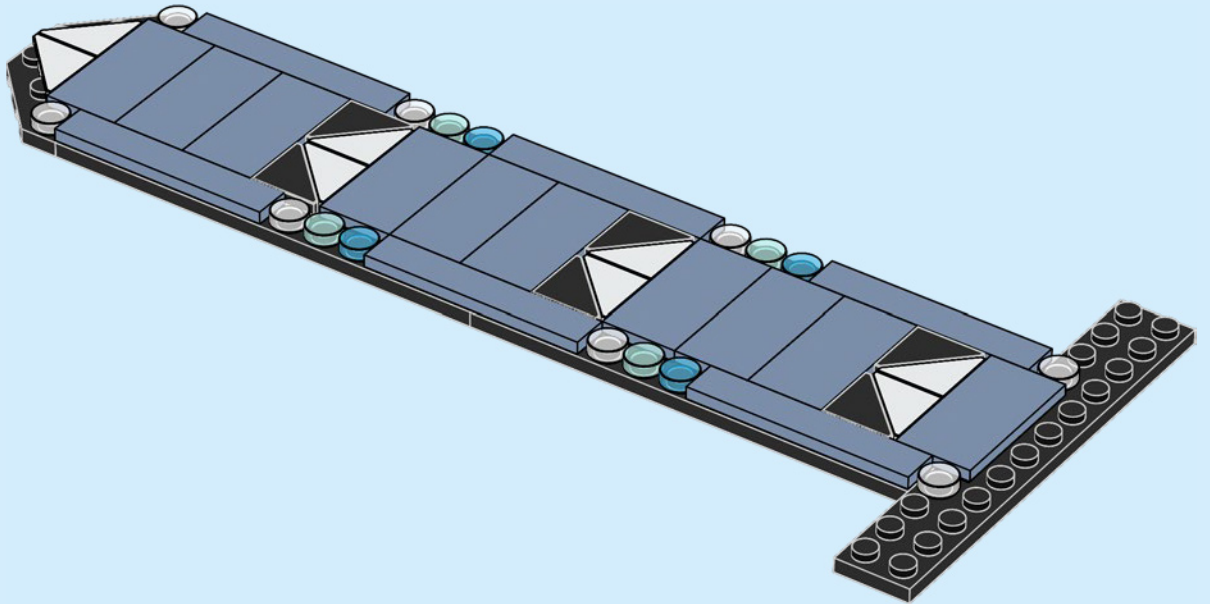

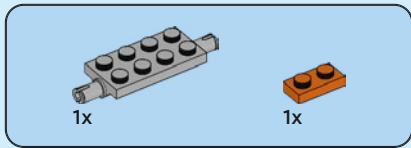

25

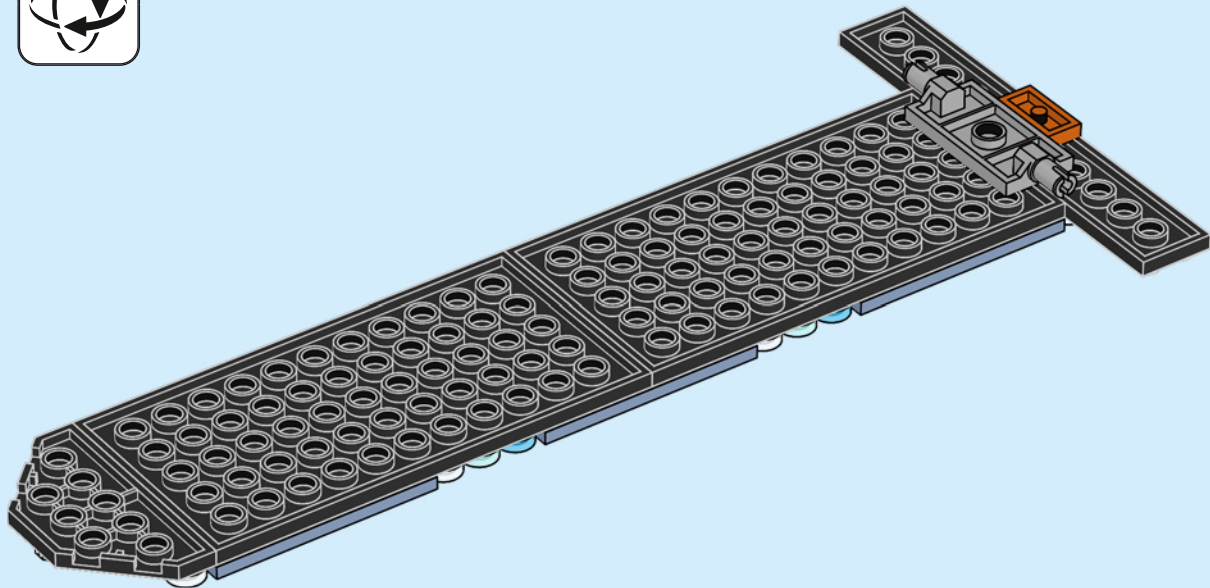

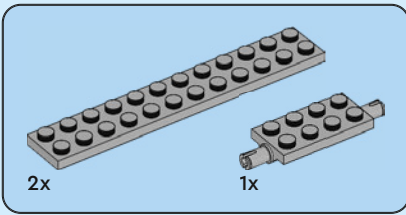

26

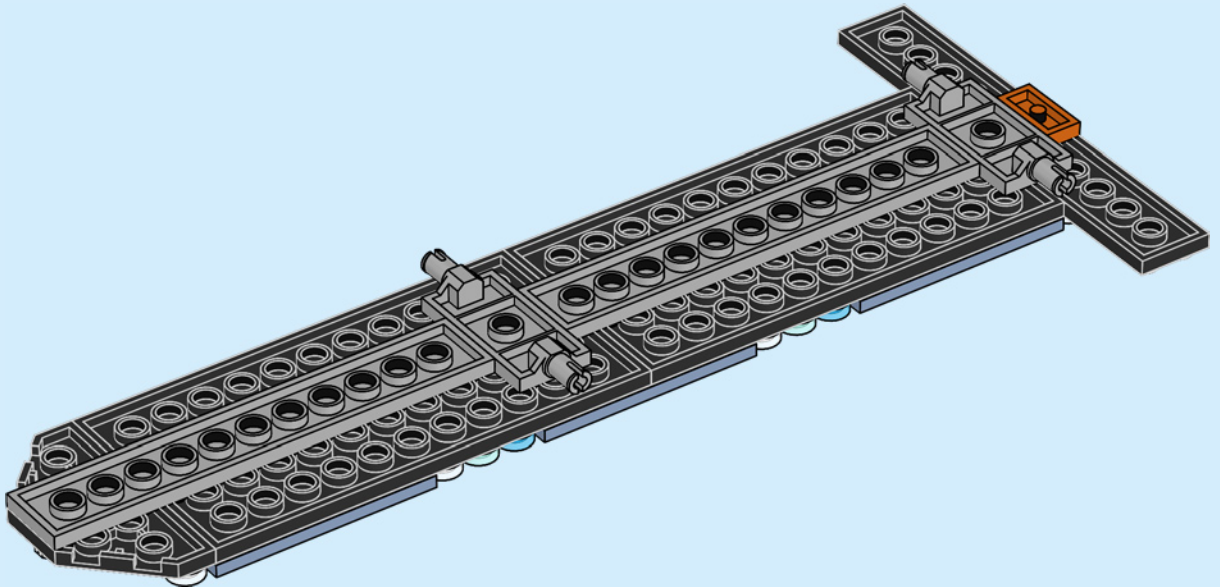



2x

27

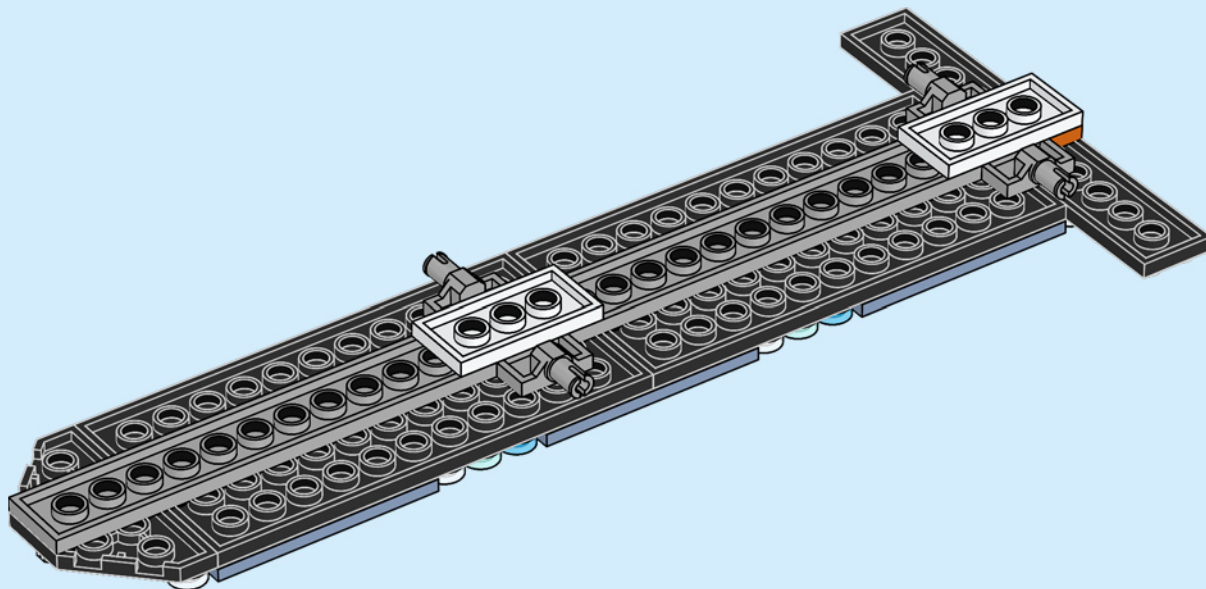

28

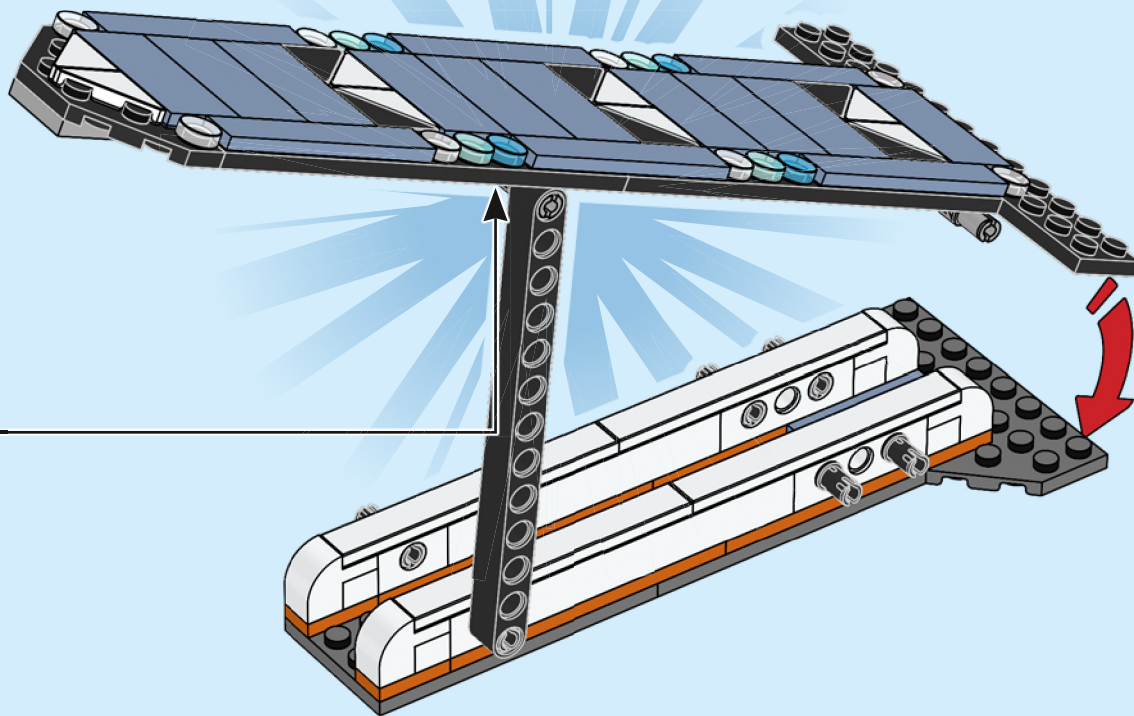

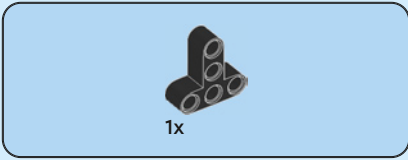

29

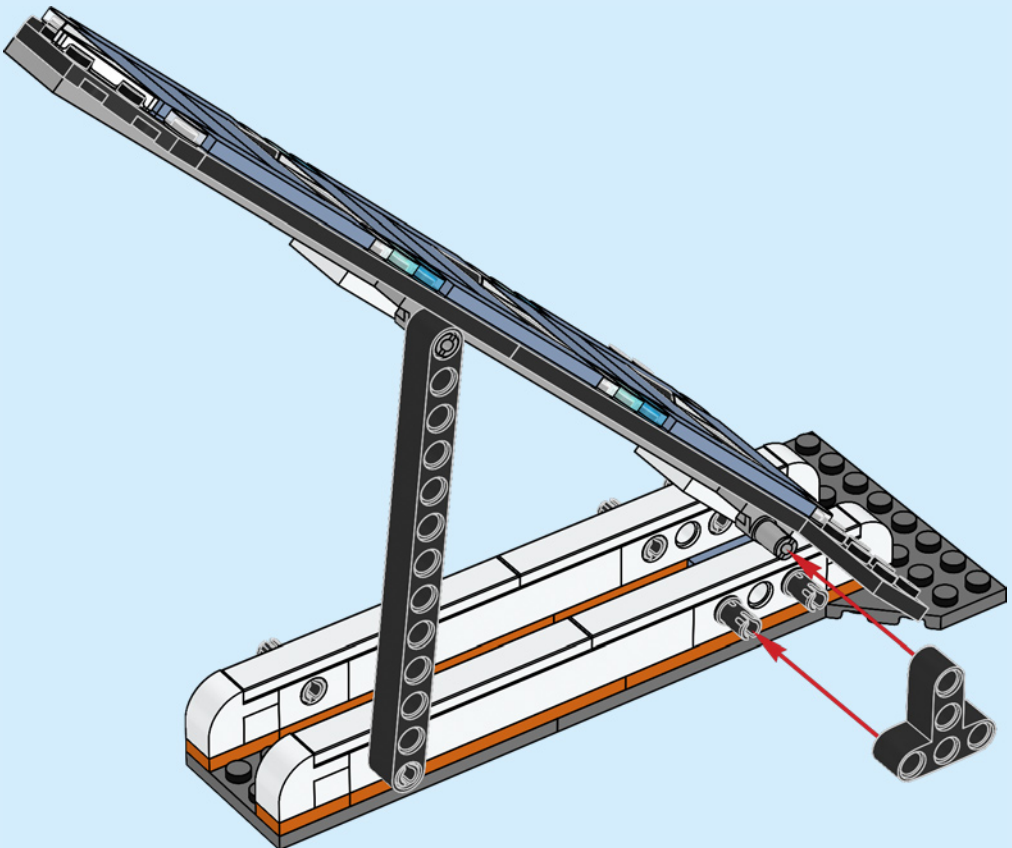



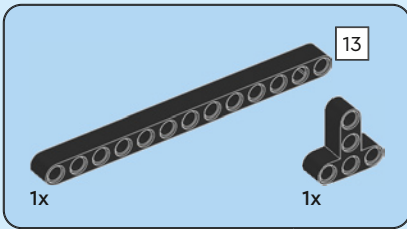

30

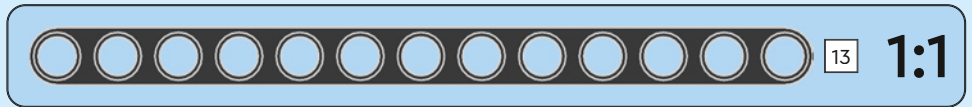
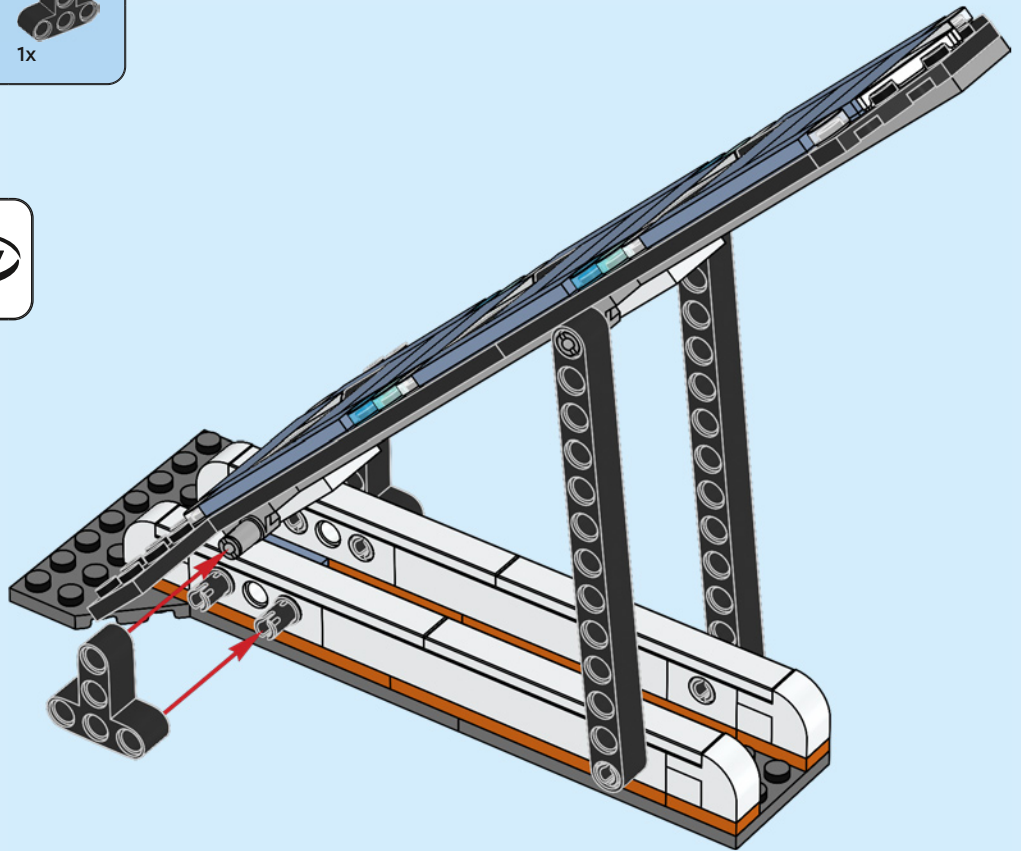

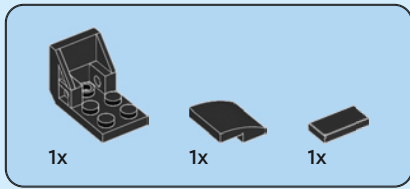

31

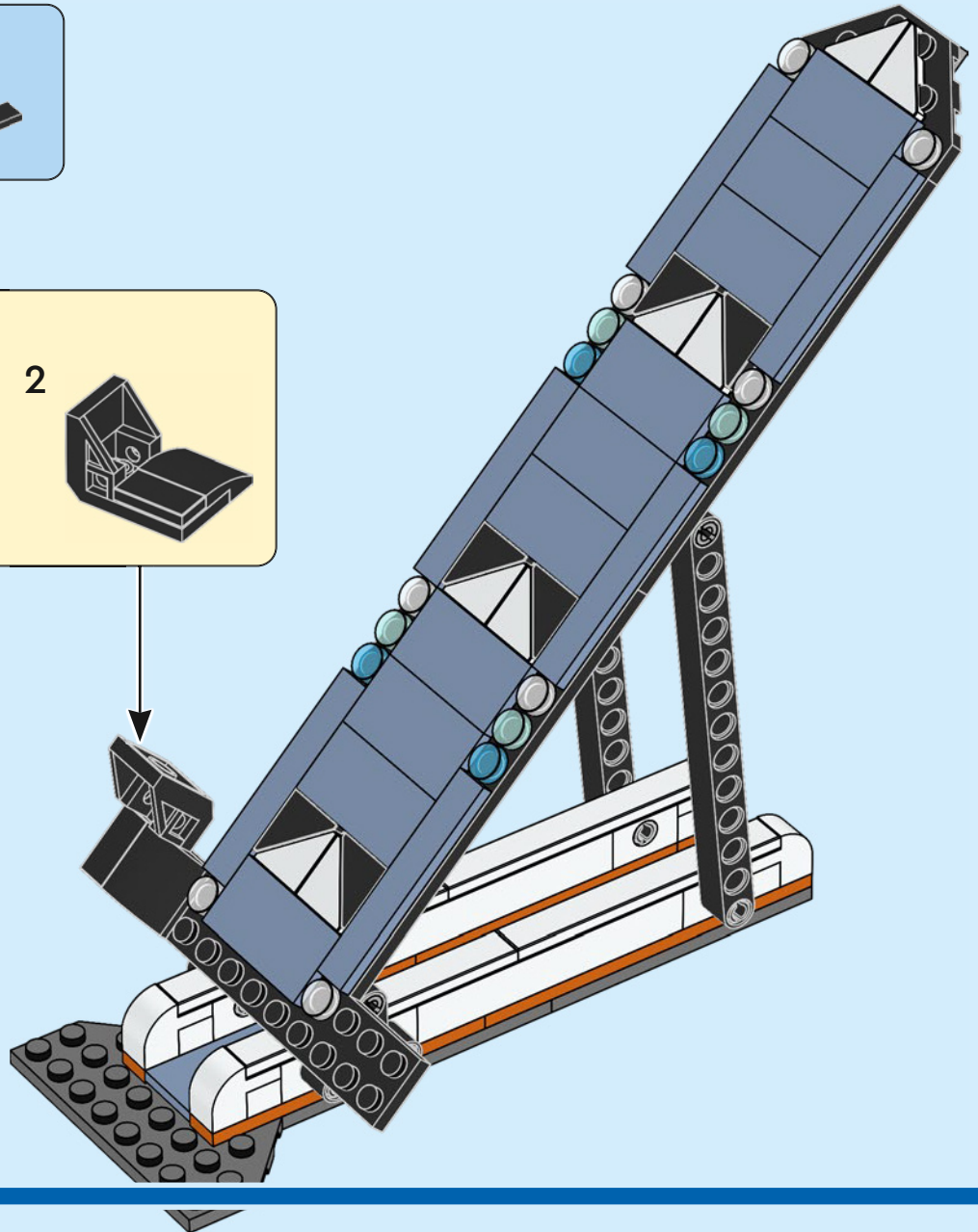
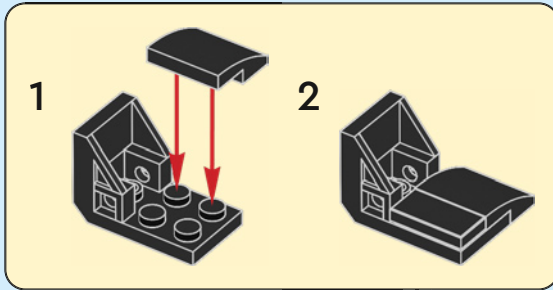

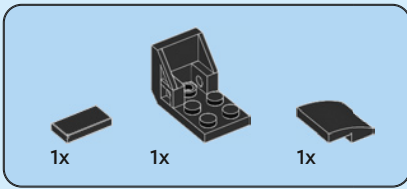

32

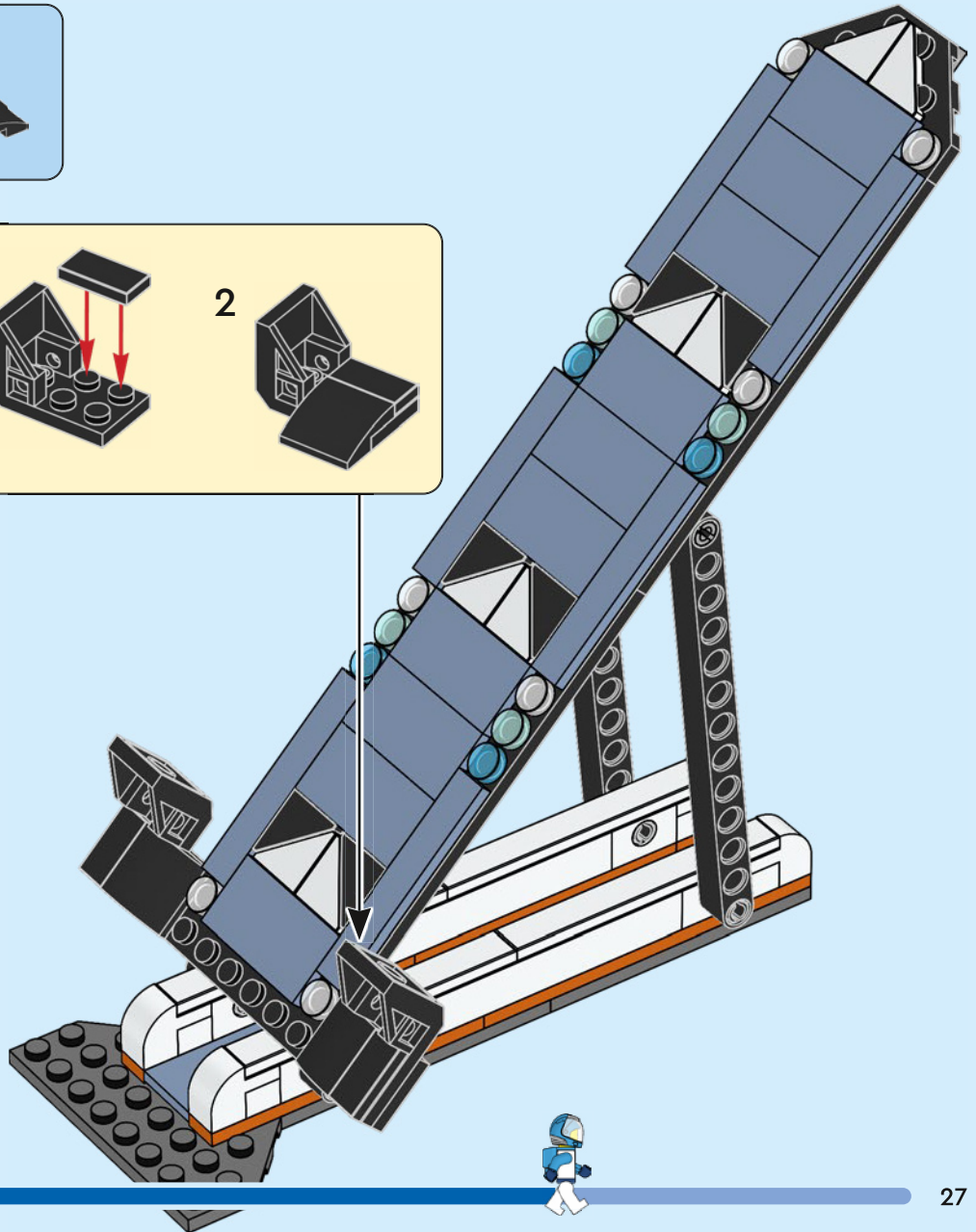
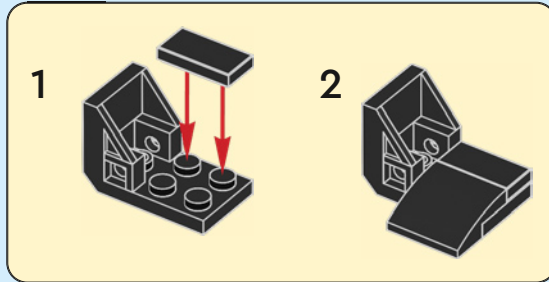

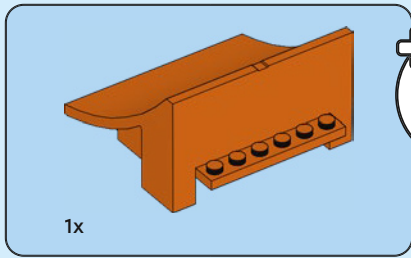

33

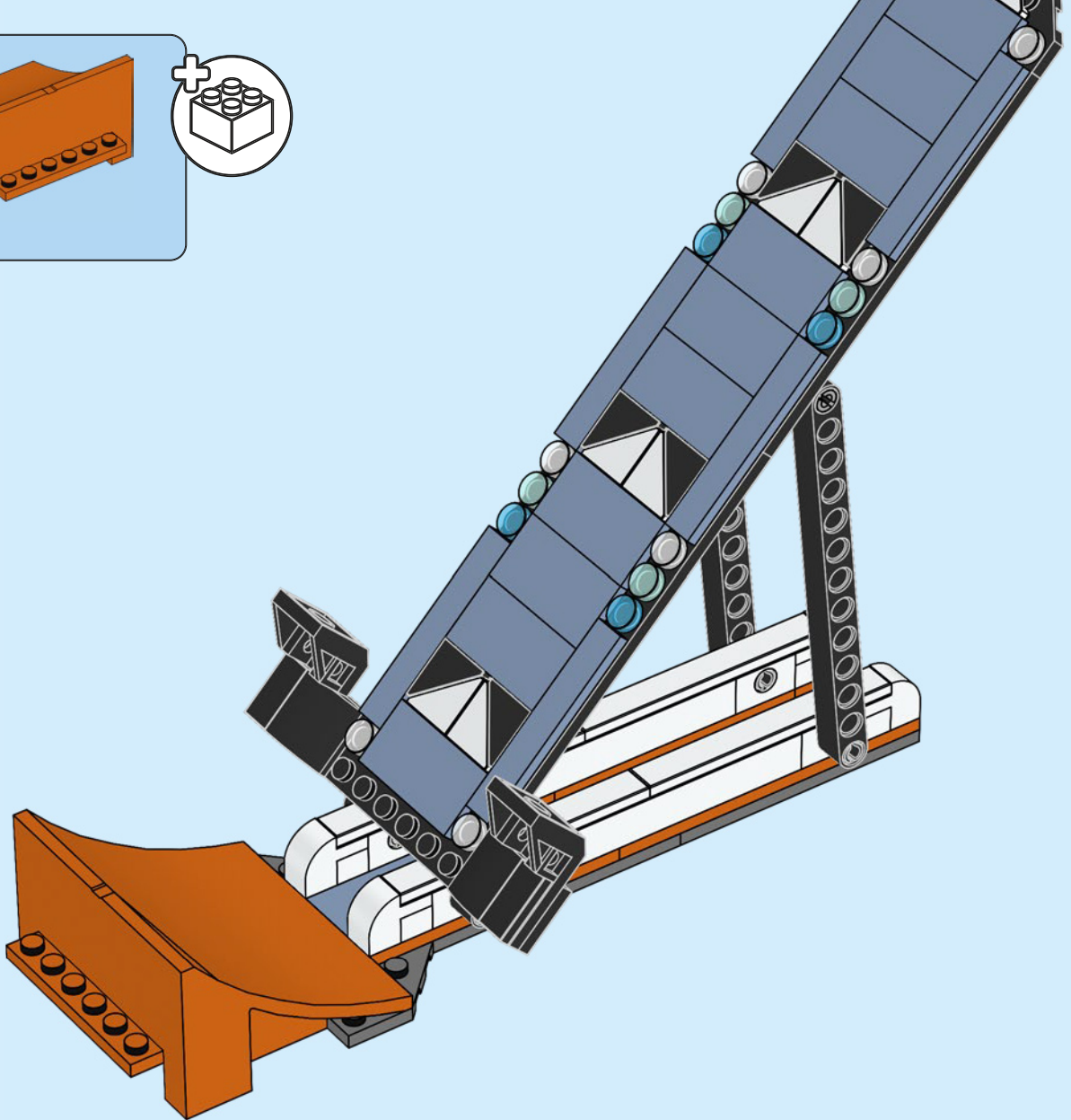



1x



2x

# 34

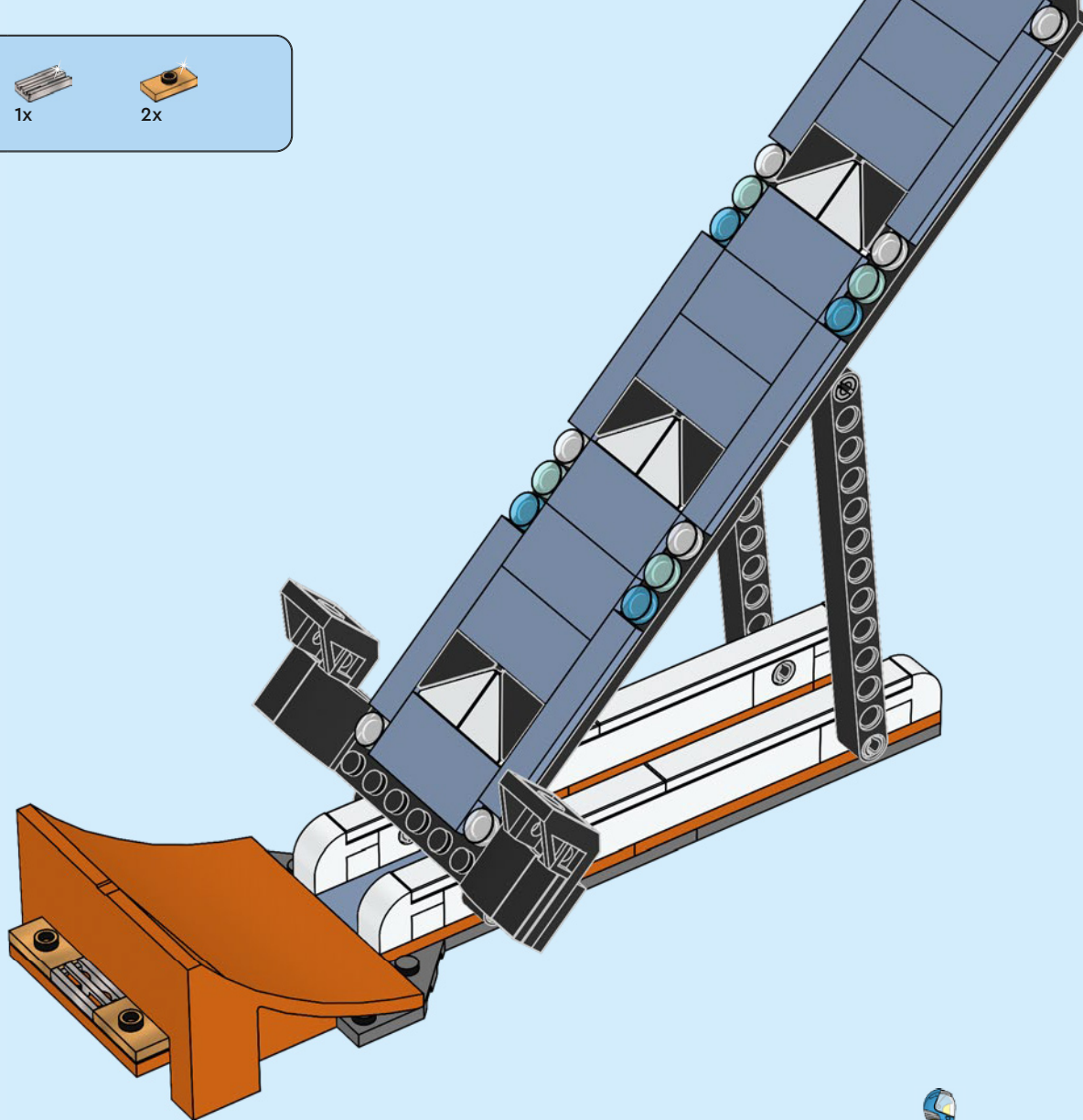

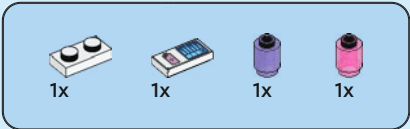

35

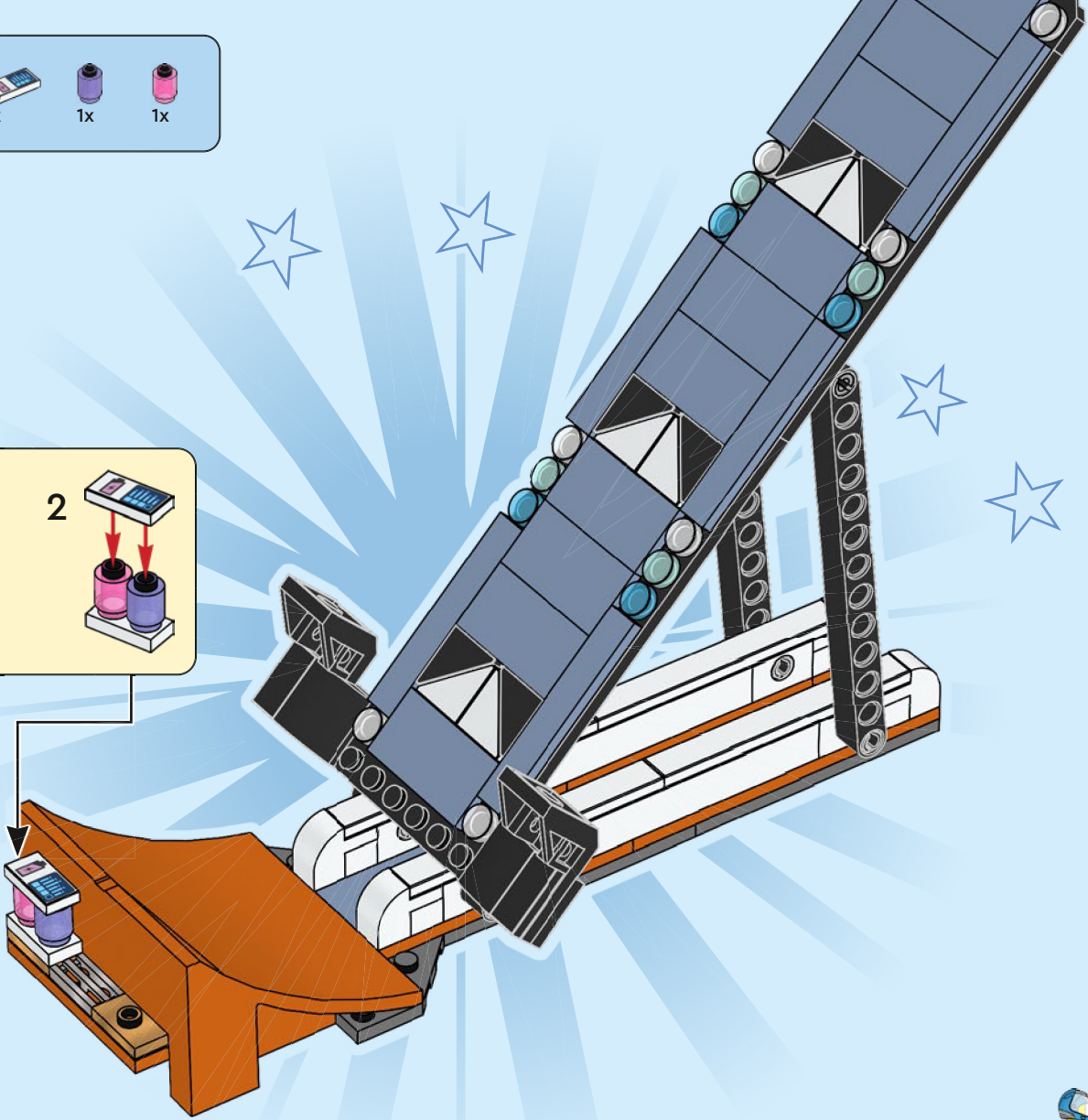
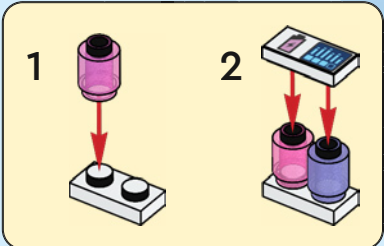



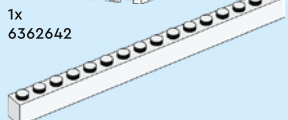
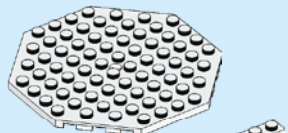

1x  
6362642

4x  
246501



2x  
362324



1x  
6361953



1x  
6419094



1x  
6384076



1x  
6311265



1x  
6174813



1x  
6429739



1x  
6465828



2x  
407024



1x  
389924



2x  
306924

32



2x  
6186675



2x  
6270027



1x  
6424674



8x  
407026



4x  
6187572



1x  
4177431



1x  
6252803



1x  
6104209



2x  
6420852



8x  
6195916



4x  
6210270



4x  
6157554



14x  
6279875



2x  
6143850



1x  
6057397



1x  
6010831



14x  
6347310



2x  
6465826



1x  
6138173



4x  
6313116



3x  
6092585



8x  
366526



4x  
302326



2x  
306926



1x  
393726



2x  
4121966



4x  
6275732



1x  
300426



2x  
6000650



18x  
6214807



6x  
4225201



3x  
300326



1x  
368026



4x  
6192346



16x  
6191630



7x  
302226



2x  
235726



2x  
306826



2x  
6053077



6x  
6458098



1x  
4124096



4x  
6370961



1x  
6425507



4x  
4515368



2x  
4552347



2x  
4558170



2x  
4251161



2x  
317626



3x  
6258209



3x  
6258214



2x  
6021678



3x  
6056234



2x  
329826



1x  
6162892



2x  
6350734



2x  
6018805



7x  
371026



2x  
6254045



2x  
6254045



2x  
4530589



3x  
301026



1x  
6254519



4x  
4619323



3x  
4515350



4x  
6358291



2x  
6170597



4x  
6434275



1x  
6168638



2x  
4560182



5x  
6438520



2x  
6174252



6x  
302026



1x  
6039194



1x  
617926



5x  
6315887



4x  
6112323

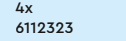

1x  
663626



2x  
366626



4x  
389426

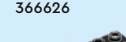

2x  
4160393

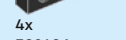

2x  
6391342



5x  
4517986



1x  
6058118

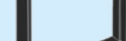

2x  
617926

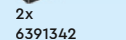

4x  
6458165





1x  
6173121

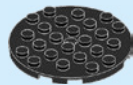

1x  
6187587



7x  
379526

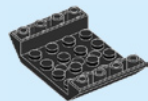

1x  
4541984

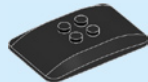

1x  
6288408



3x  
346026



1x  
303226

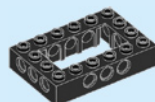

1x  
6456527

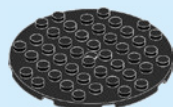

2x  
6393938



4x  
447726



3x  
383226



1x  
303626

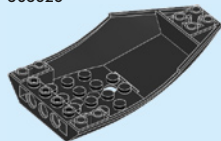

1x  
4209683



1x  
244526

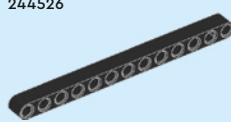

2x  
4522933

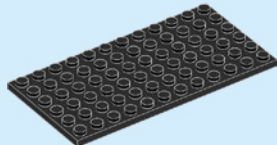

2x  
302826

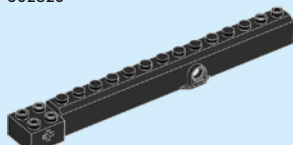

1x  
6443861



1x  
6172375



2x  
6469876



1x  
6195258



2x  
6474250



1x  
6254484



4x  
6104342



1x  
6475181



4x  
6069259



2x  
6325922



2x  
6263221



1x  
6384069



8x  
6274738



4x  
6244787



1x  
6469829



5x  
6465624



25x  
6274739



1x  
6254256



4x  
6292200



1x  
6469015



1x  
6248908



1x  
6246890



4x  
6273627



4x  
6173925



1x  
6265128



3x  
4121739



4x  
6213782

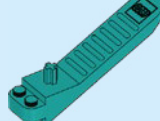

1x  
6254100



2x  
6190251



2x  
6465831



2x  
6474136



1x  
6286831



1x  
6248970



3x  
6459341



4x  
6142505



4x  
6179812



6x  
6306726



11x  
6124349



10x  
6262030



4x  
6475598



2x  
6468983



2x  
4521914



1x  
4255416



3x  
6184880



4x  
6020847



1x  
4267874



1x  
6288246



4x  
6240227



2x  
6274747



14x  
6245265



8x  
6250584



1x  
6065504



1x  
6462019



2x  
6236454



2x  
6465625



4x  
6193972



2x  
6020181



1x  
6020147



4x  
6072668



2x  
6020073



2x  
6097509



5x  
6284071



2x  
6275844



4x  
4211415



1x  
6329583



2x  
6362975



4x  
6311384



1x  
4540203

13

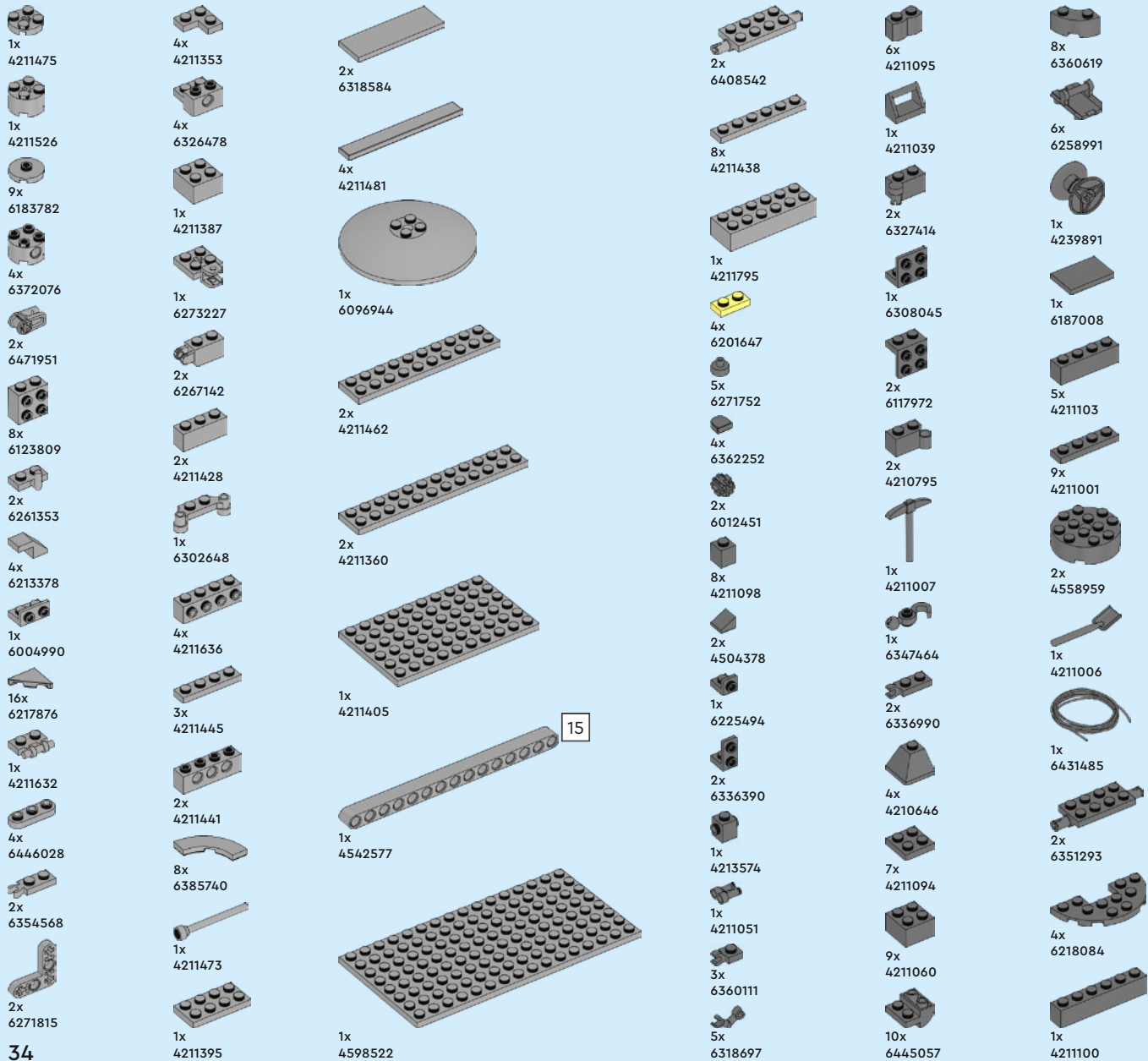

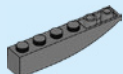

4x  
4210779



1x  
4211002

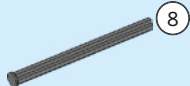

2x  
4499858



2x  
4210998

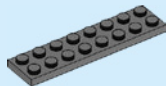

1x  
4210997



1x  
6311001



1x  
4211134



4x  
4257526



2x  
4211061



1x  
4210794

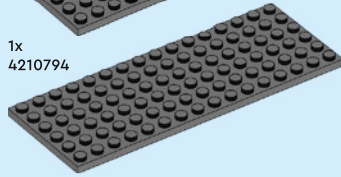

2x  
4226358



1x  
6466716



12x  
6190252



8x  
6060800



1x  
6342086



1x  
6472025



1x  
6306071



6x  
6092594



4x  
4490599



4x  
4585493



8x  
6468173



1x  
6441065



1x  
6214214



25x  
4619636



1x  
6168708



1x  
6197015



1x  
6475304



1x  
6223733



1x  
6151658



1x  
6469870



1x  
6471481



2x  
6126090



2x  
6473803



2x  
6442196



11x  
6464814



3x  
6442192



17x  
6469858



8x  
6467487



1x  
6468172



1x  
6468297



2x  
6471811



48x  
6466720



2x  
6468361



4x  
6466717



1x  
6467809

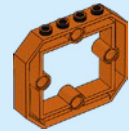

3x  
6468285



8x  
6467485

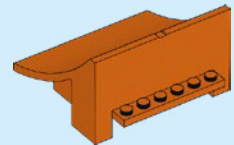

1x  
6467820



[LEGO.com/service](https://www.LEGO.com/service)

YOU COULD **WIN**



Scan this QR code or go to **LEGO.COM/PRODUCTFEEDBACK** and give us your short feedback about this LEGO® set for a chance to win a cool LEGO prize.

Terms and Conditions apply\*

**EN: YOU COULD WIN.** Terms and Conditions apply\* **DE: Du könntest GEWINNEN.** Es gelten die Teilnahmebedingungen\* **FR: Tu pourrais GAGNER.** Des conditions s'appliquent\* **IT: Potresti VINCERE tu.** Termini e condizioni sono applicabili\* **ES: Puedes GANAR.** Aplican términos y condiciones\* **PT: Poderá GANHAR.** Aplicam-se termos e condições\* **ZH: 轻松获奖. 条款和条件适用\*** **PL: Szansa na WYGRANĄ.** Obowiązują warunki korzystania\* **CS: Máte šanci VYHRÁT.** Platí všeobecné smluvní podmínky\* **SK: Máte šancu VYHRAŤ.** Platia všeobecné zmluvné podmienky\* **HU: TE IS NYERHETSZ.** Felhasználási feltételek érvényesek\* **RO: Ai putea CÂȘTIGA.** Se aplică termeni și condiții\* **BG: Можете да СПЕЧЕЛИТЕ.** Има определени правила и условия\* **LV: Tu vari LAIMĒT.** Ir spēkā noteikumi un nosacījumi.\* **ET: Sul on võimalus VÕITA.** Kehtivad tingimused\* **LT: Jūs galite LAIMĖTI.** Taikomos sąlygos\*

\*[LEGO.com/productfeedback-terms](https://www.lego.com/productfeedback-terms)

LEGO and the LEGO logo are trademarks of the LEGO Group. ©2024 The LEGO Group.