

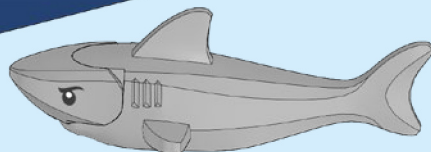

CITY

60419

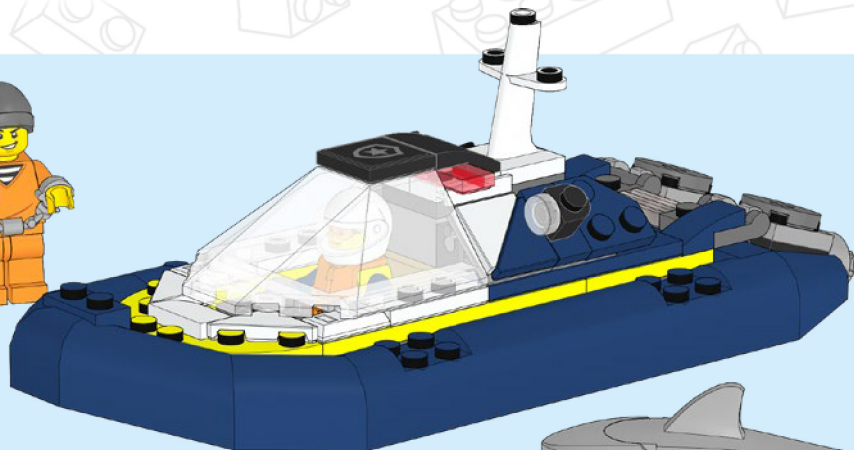

1



LEGO.com/sustainable-packaging



 ^{FR} **DONNEZ
OU
RECYCLEZ**  OU  OU 
ASSOCIATION MAGASIN DÉCHÈTERIE

Adresses sur quefairedemesdechets.fr

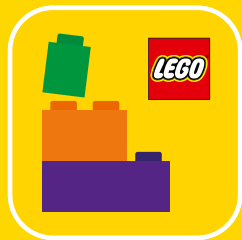

Q LEGO® Builder

BUILDER



Apple and the Apple logo are trademarks of Apple Inc., registered in the U.S. and other countries and regions. App Store is a service mark of Apple Inc. Google Play and the Google Play logo are trademarks of Google LLC. Tencent and the Tencent logo are trademarks of Tencent Inc.

Q [LEGO.com/devicecheck](https://lego.com/devicecheck)

EN Ask parents' permission before going online | **DE** Eltern um Erlaubnis bitten, bevor du online gehst | **FR** Demande l'autorisation d'un parent avant d'aller en ligne | **IT** Chiedi il permesso ai tuoi genitori prima di andare online | **ES** Pídeles permiso a tus papás antes de conectarte a Internet | **PT** Pede autorização aos pais antes de acederes online | **ZH** 上网前应先征得父母的同意 | **PL** Poproś rodziców o zgodę, zanim wejdiesz do Internetu | **CS** Než půjdeš na internet, požádej rodiče o svolení | **SK** Skôr než pôjdeš na internet, vypýtaj si povolenie od rodičov | **HU** Kérj szülői engedélyt, mielőtt online csatlakoznál! | **RO** Cere permisiunea părinților înainte de a te conecta online | **BG** Поискайте разрешение от родител, преди да влезете онлайн | **LV** Pirms došanās tiešsaistē palūdz atļauju vecākiem | **ET** Enne Interneti kasutamist küsi vanematelt luba | **LT** Prieš prisijungdami prie interneto, atsiklauskite tėvų

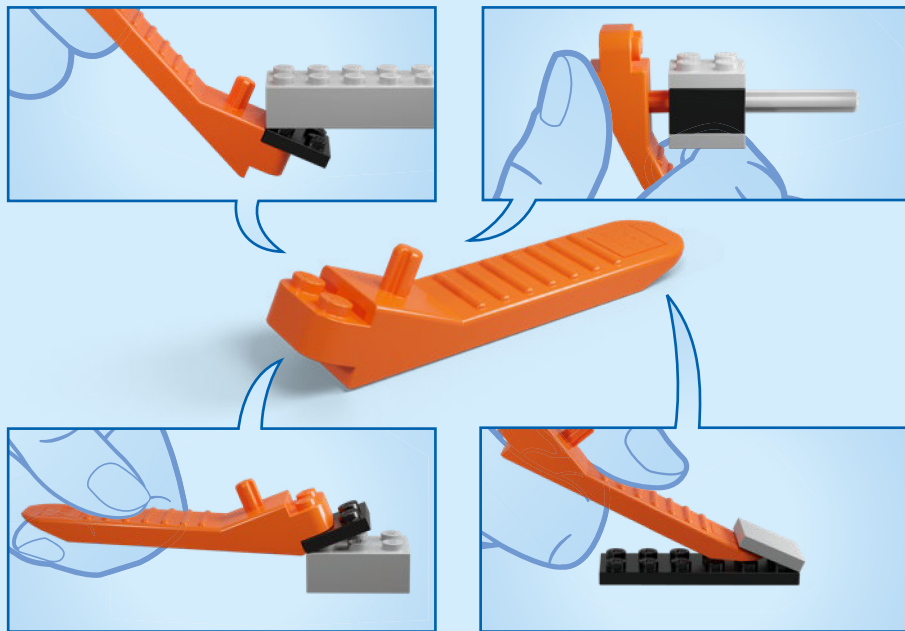

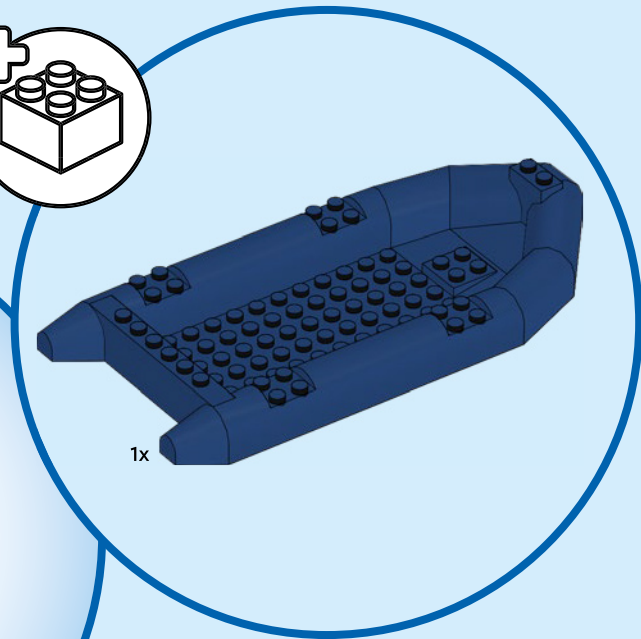
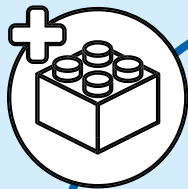
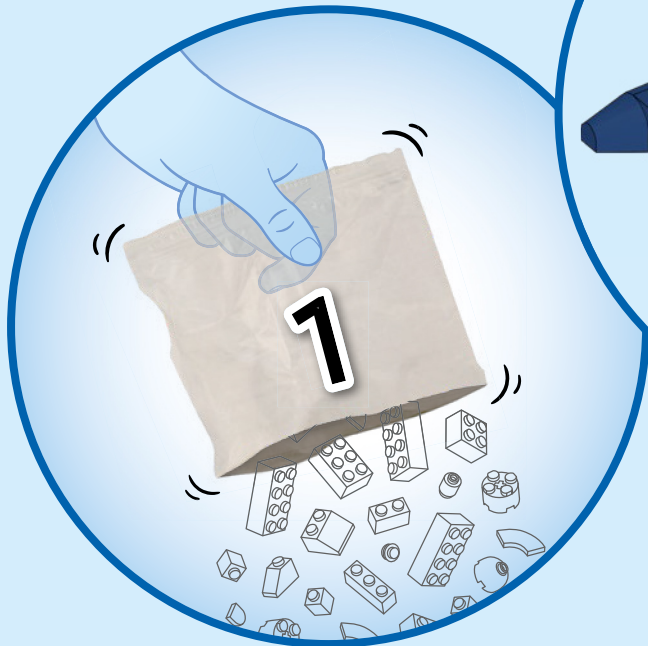

1x

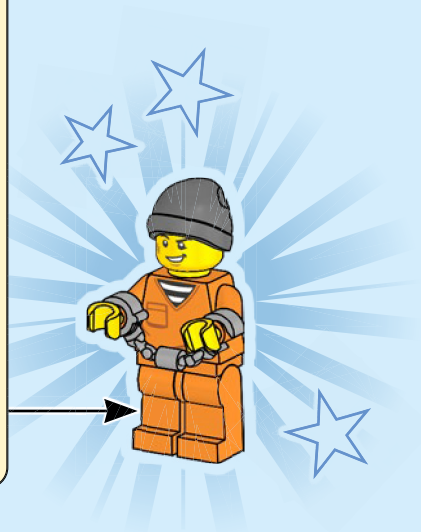
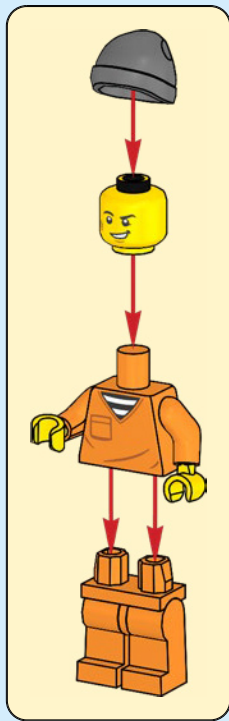
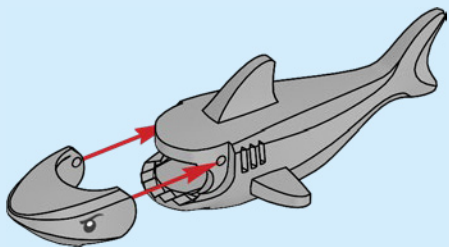

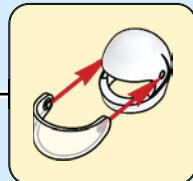
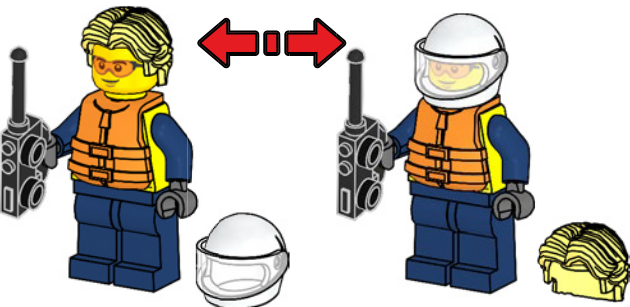
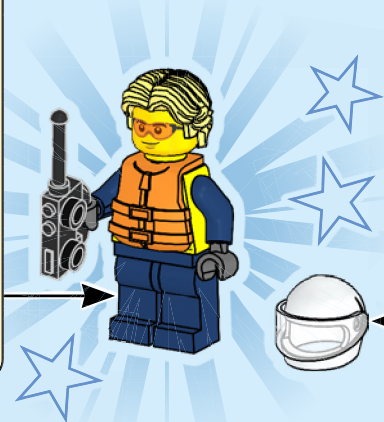
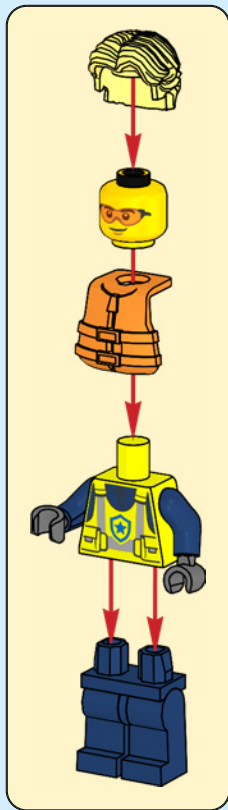

1

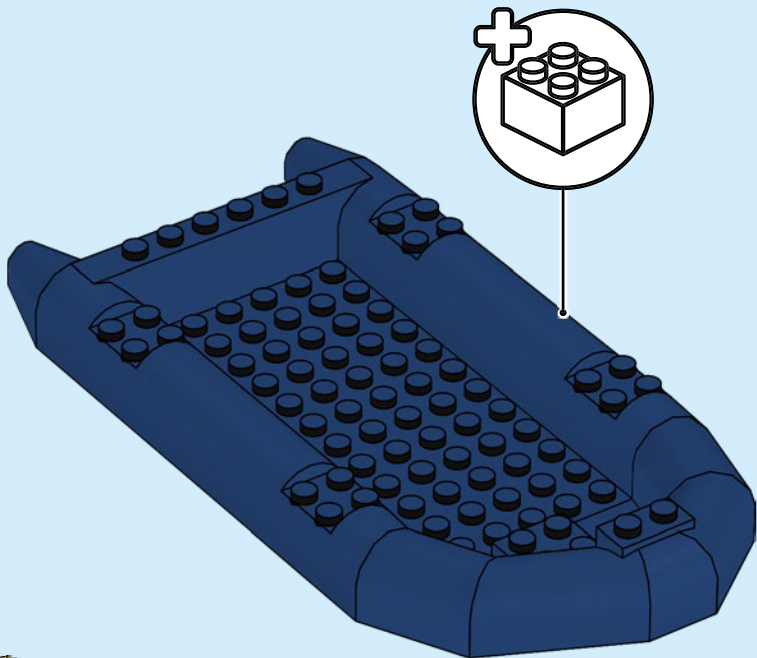



2x



2x

2

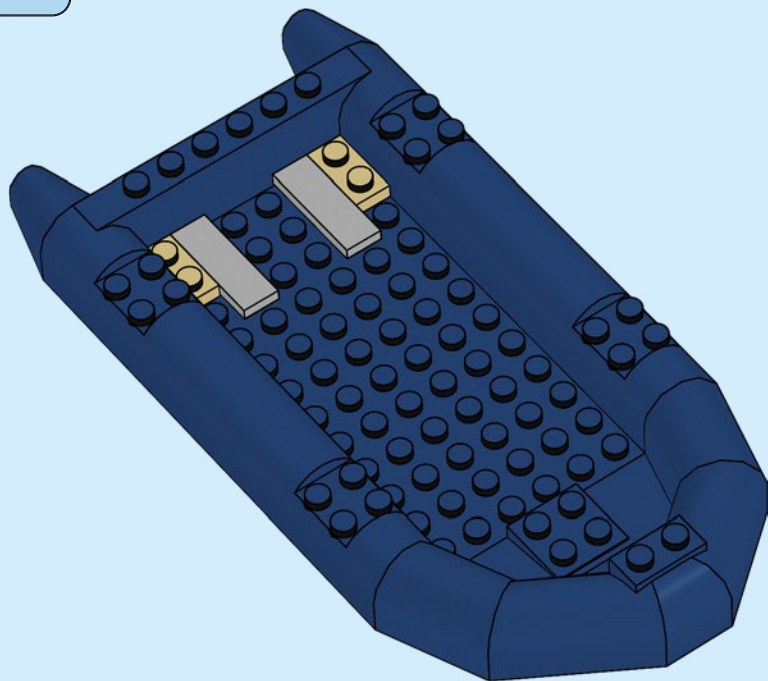

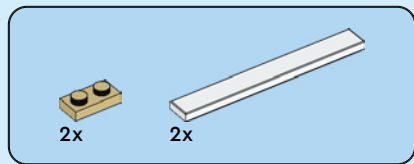

3

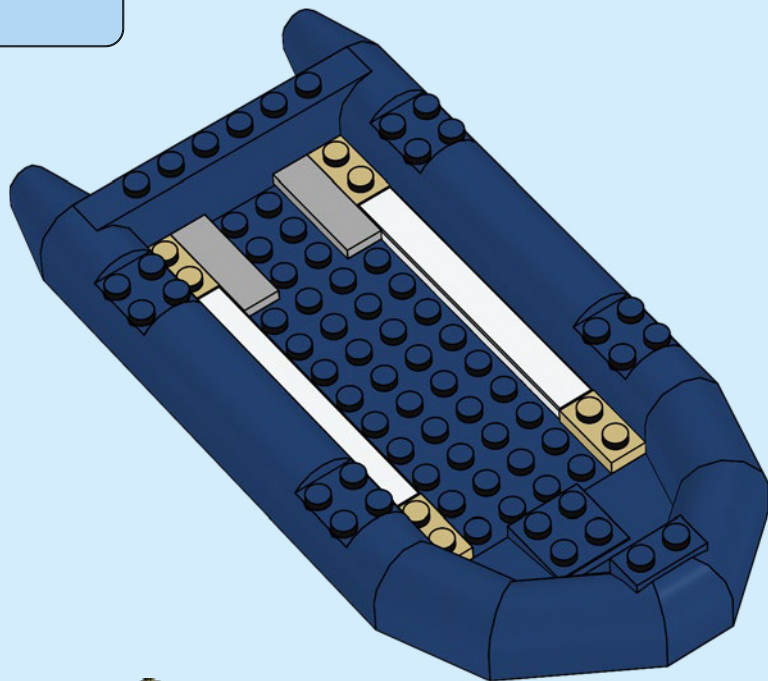



1x

4

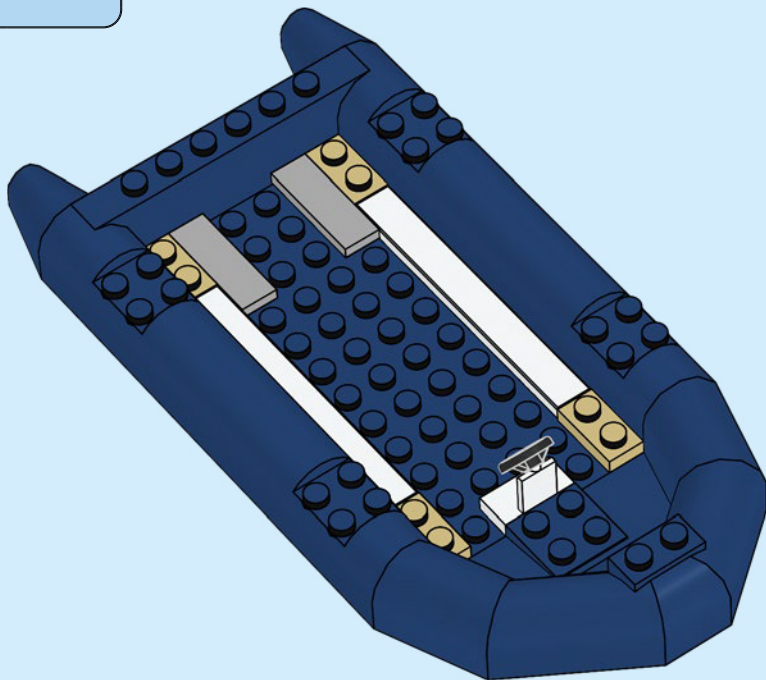

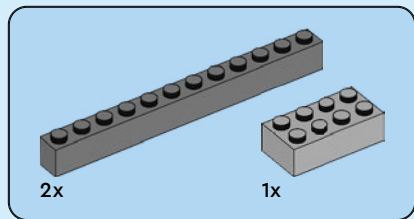

5

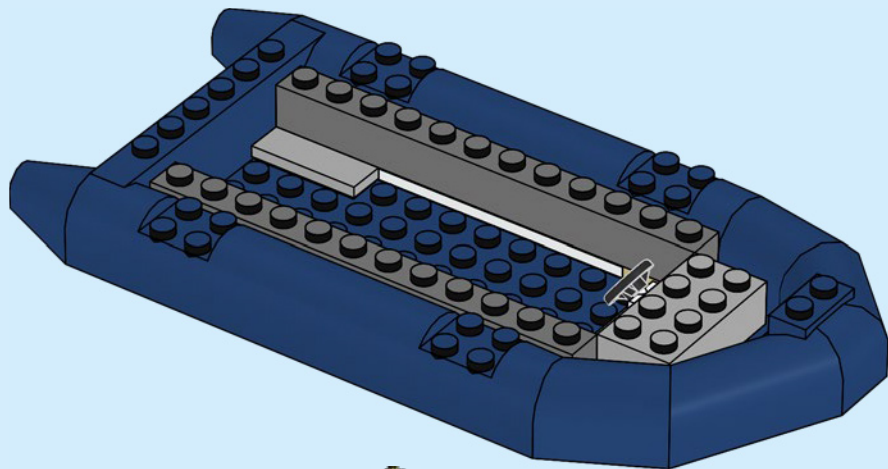

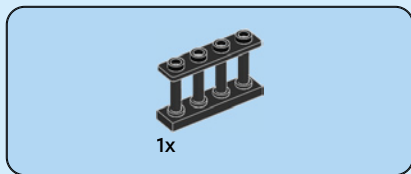

6

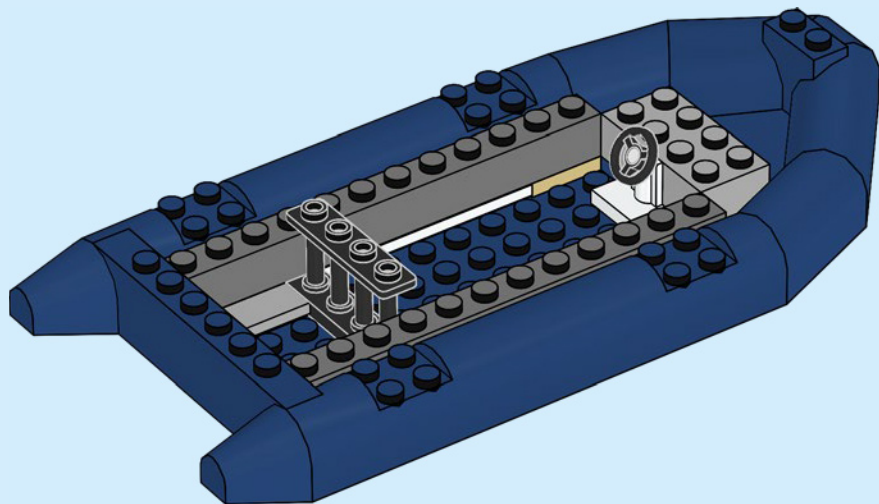

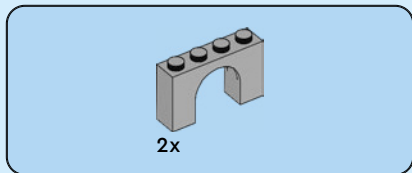

7

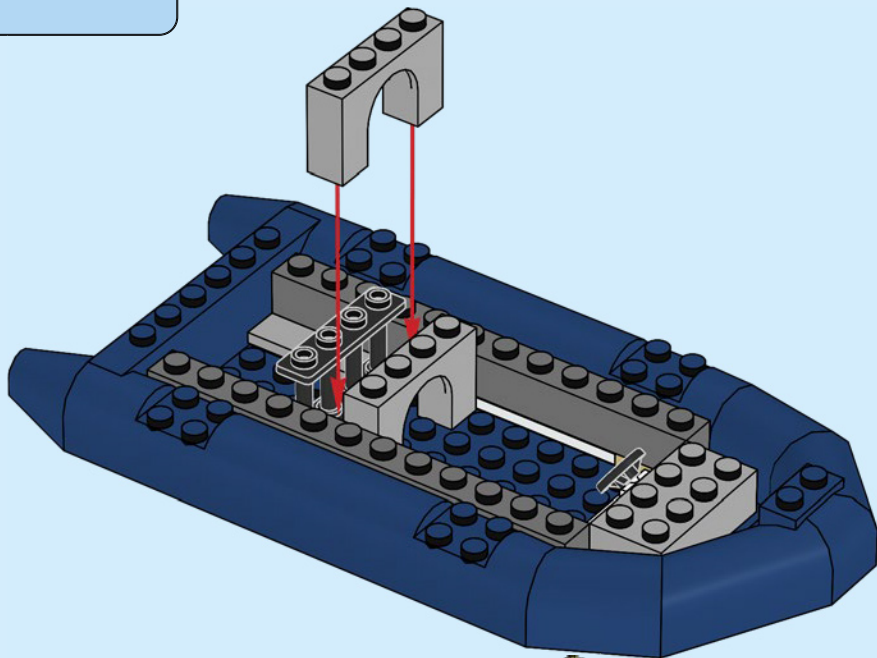

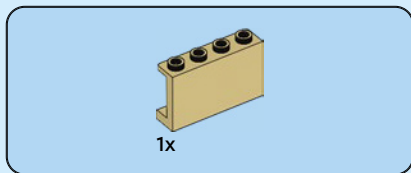

8

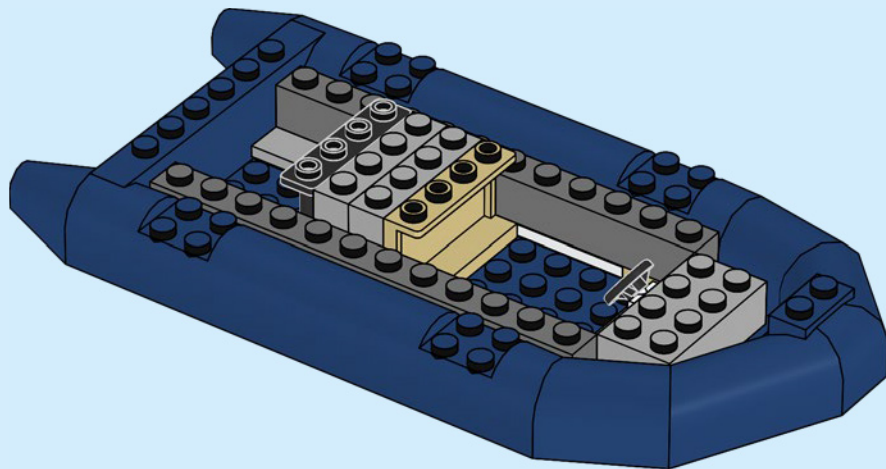

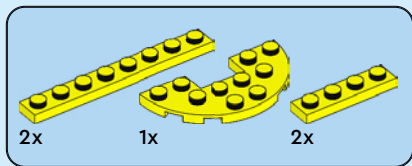

9

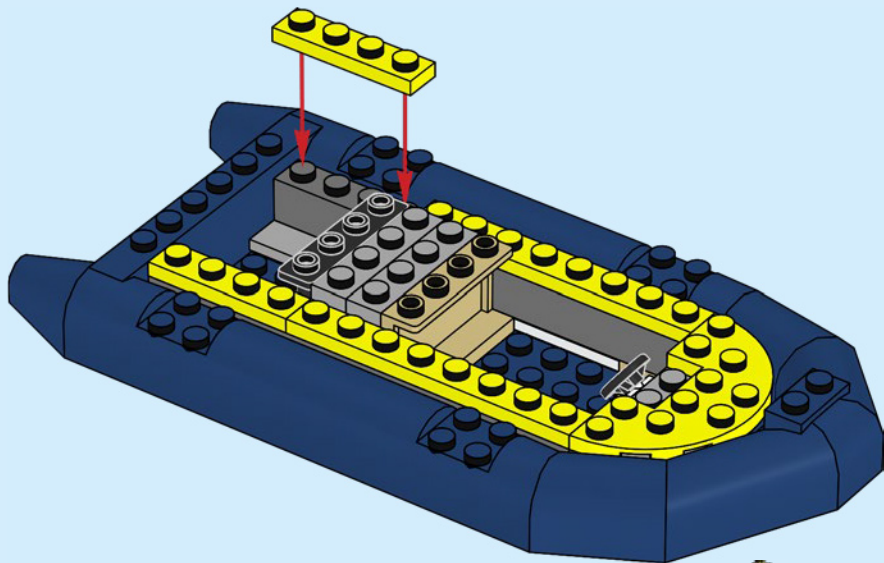



1x



2x

10

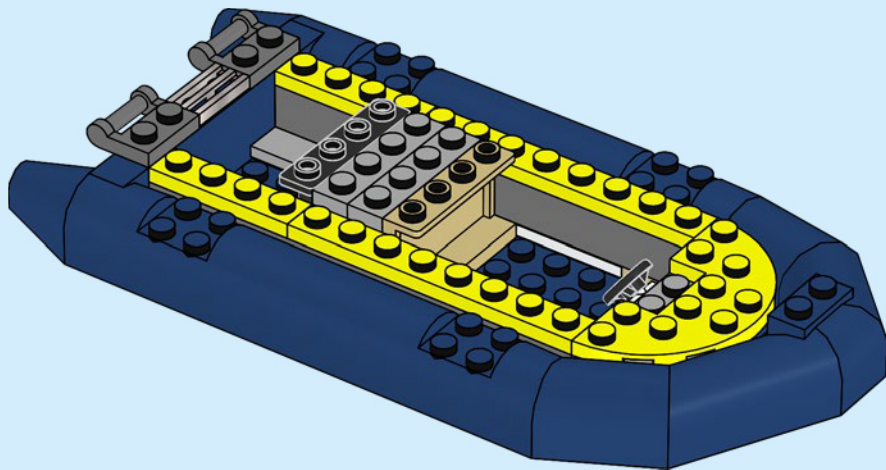

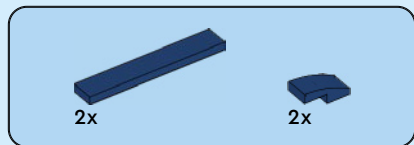

11

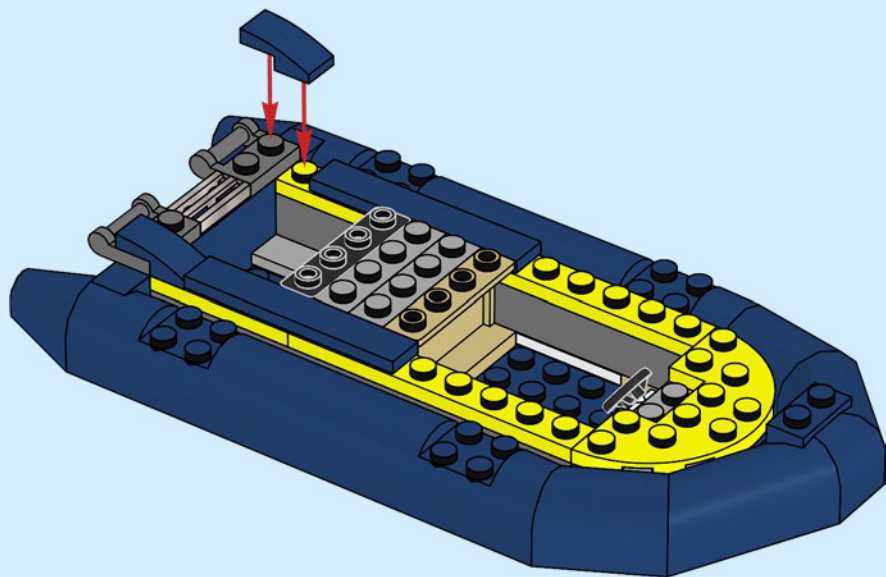



1x

12

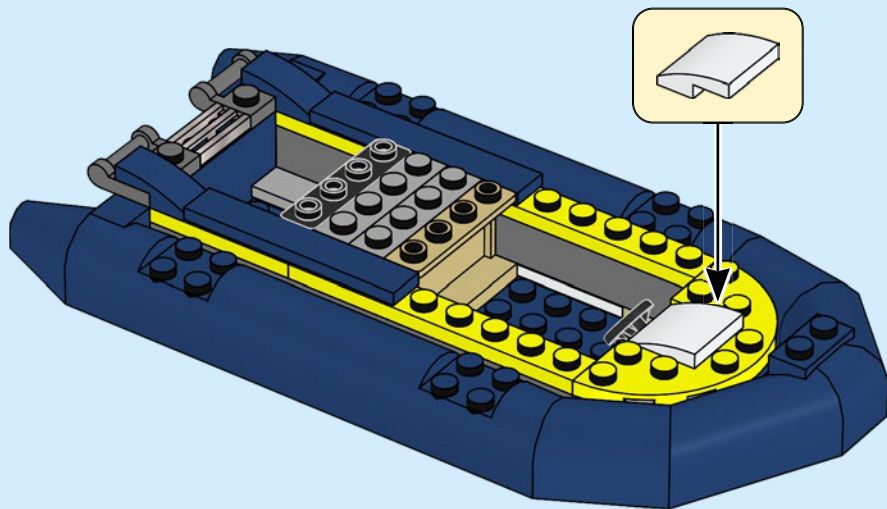



2x



2x



2x

13

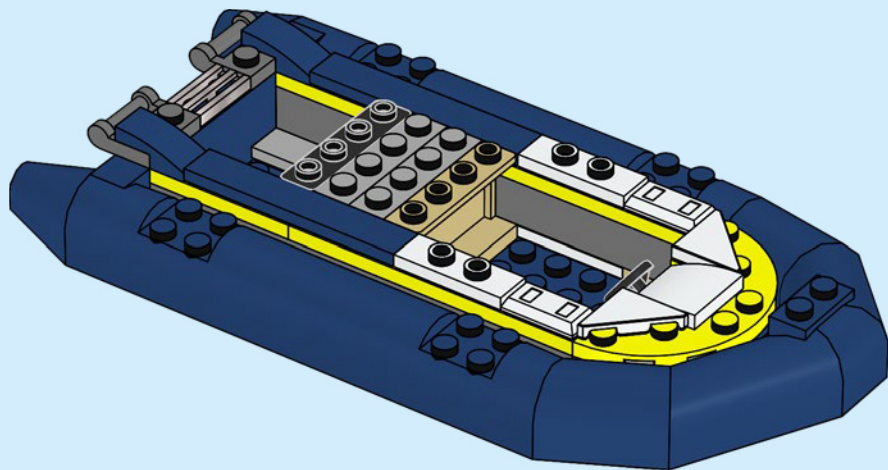

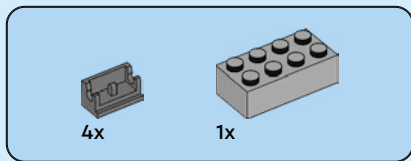

14

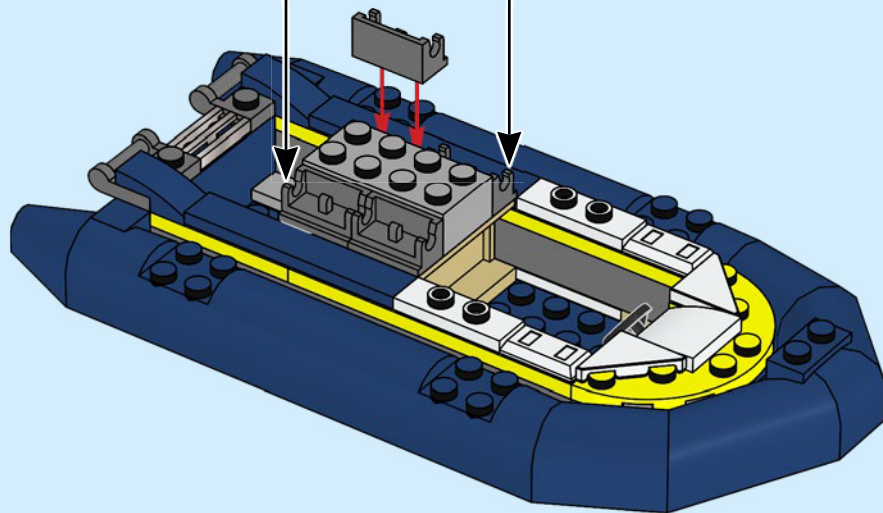



4x

15

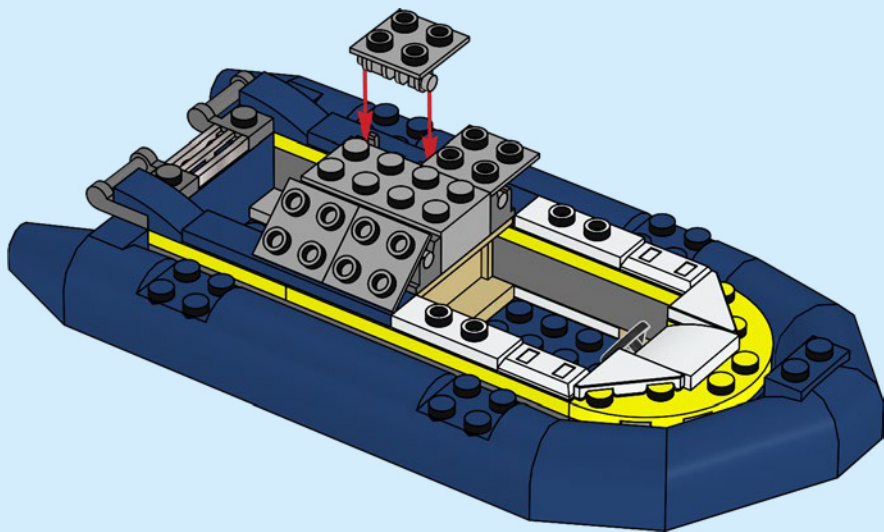



2x



2x

16

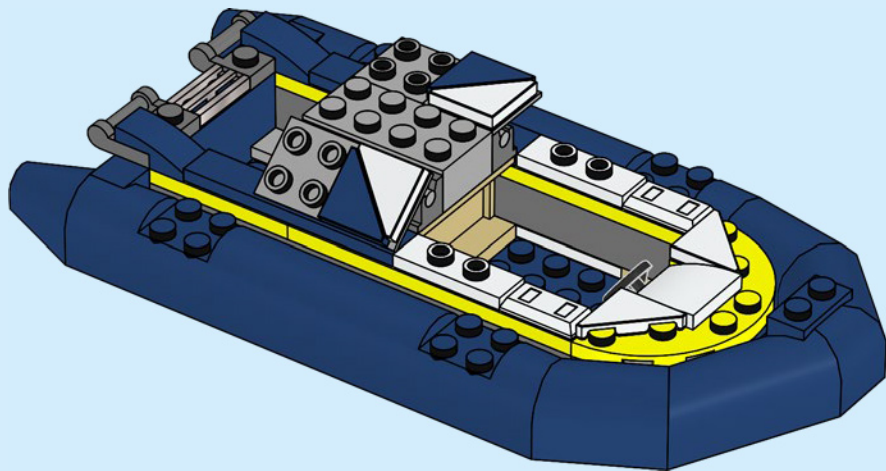



2x



2x

17

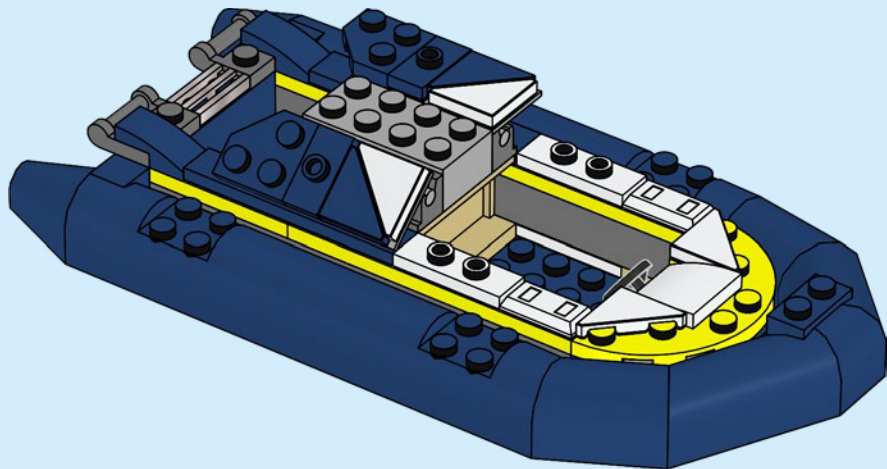

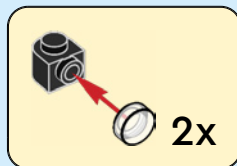
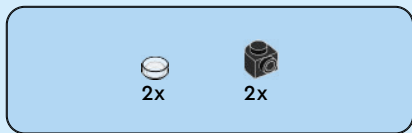

18

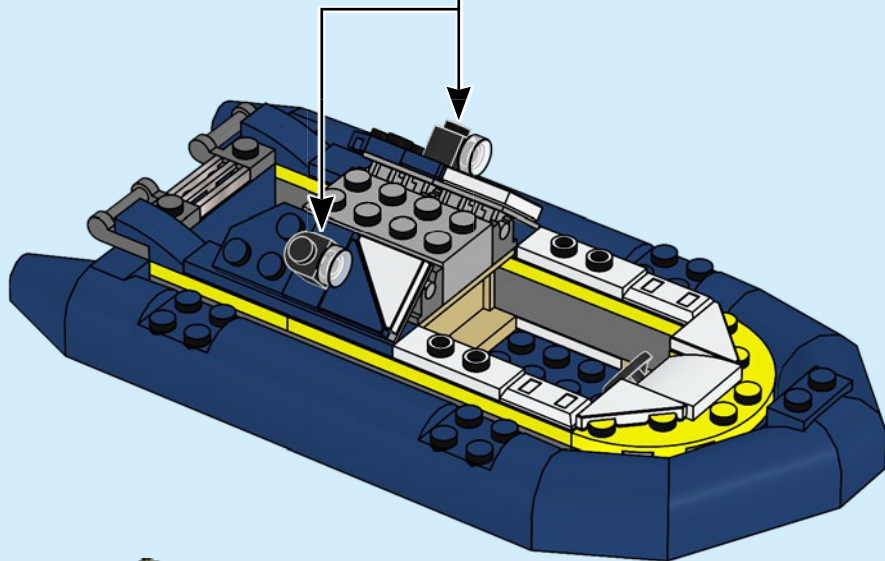



1x

19

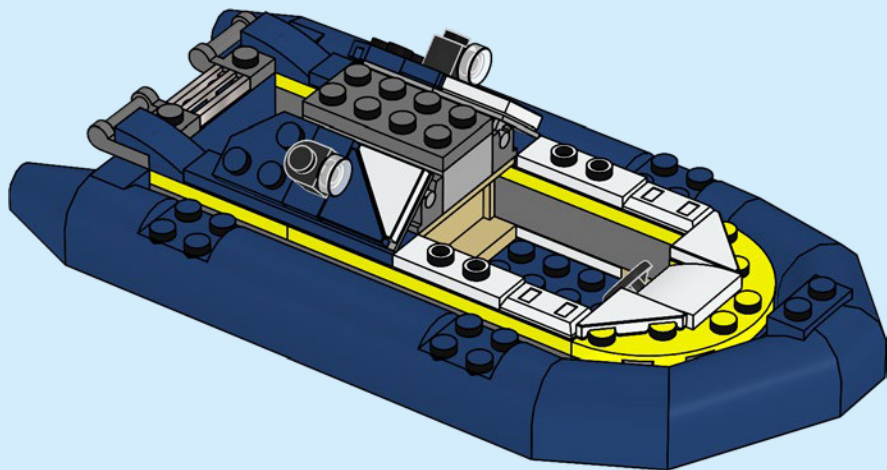



2x

20

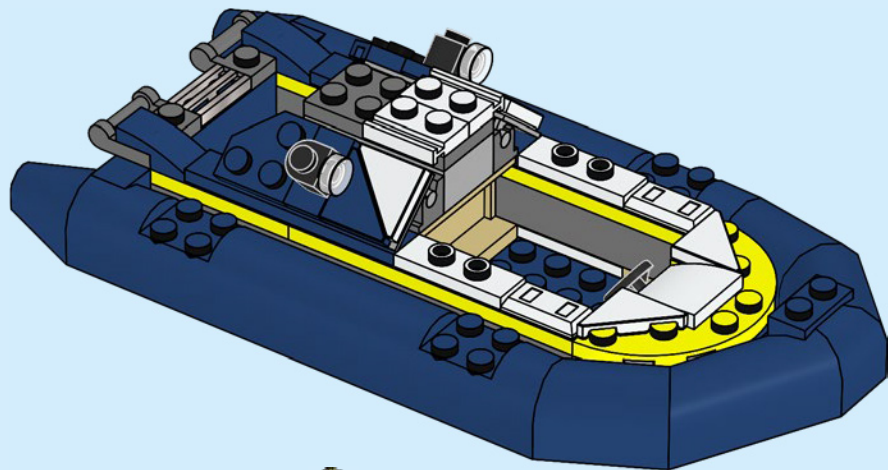

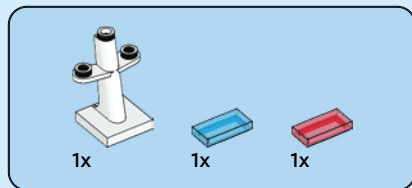

21

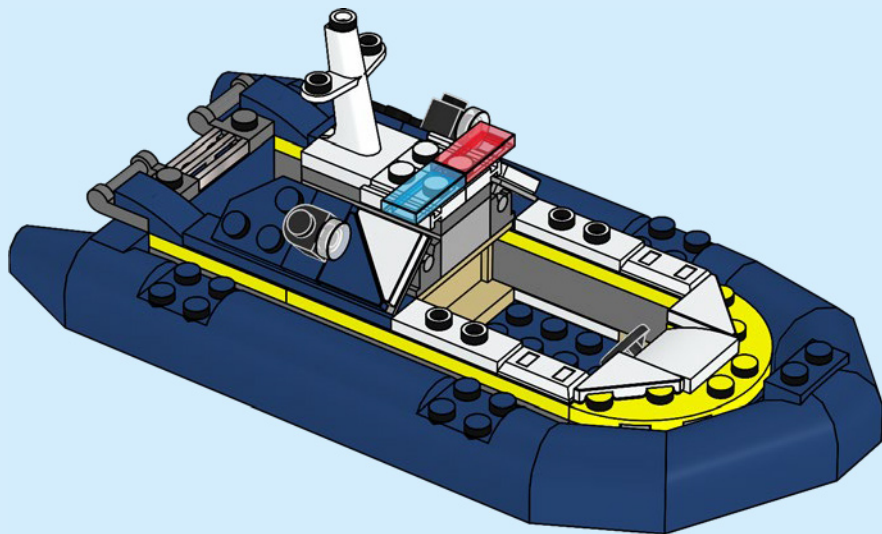



1x

22

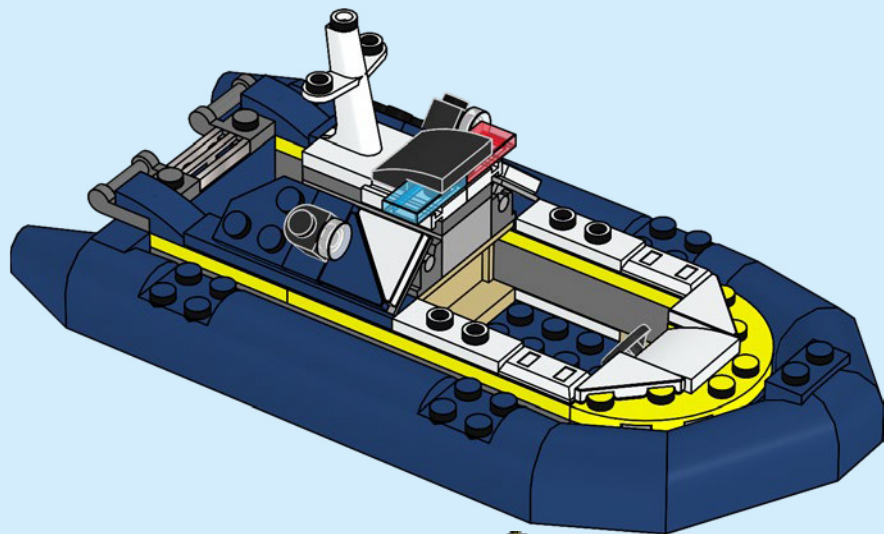



2x



2x



2x



2x



4x



2x

23

1

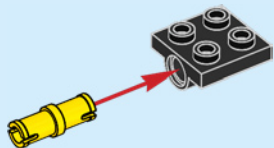

2

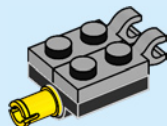

3

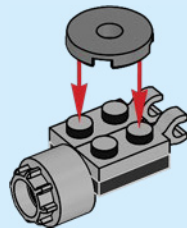

2x

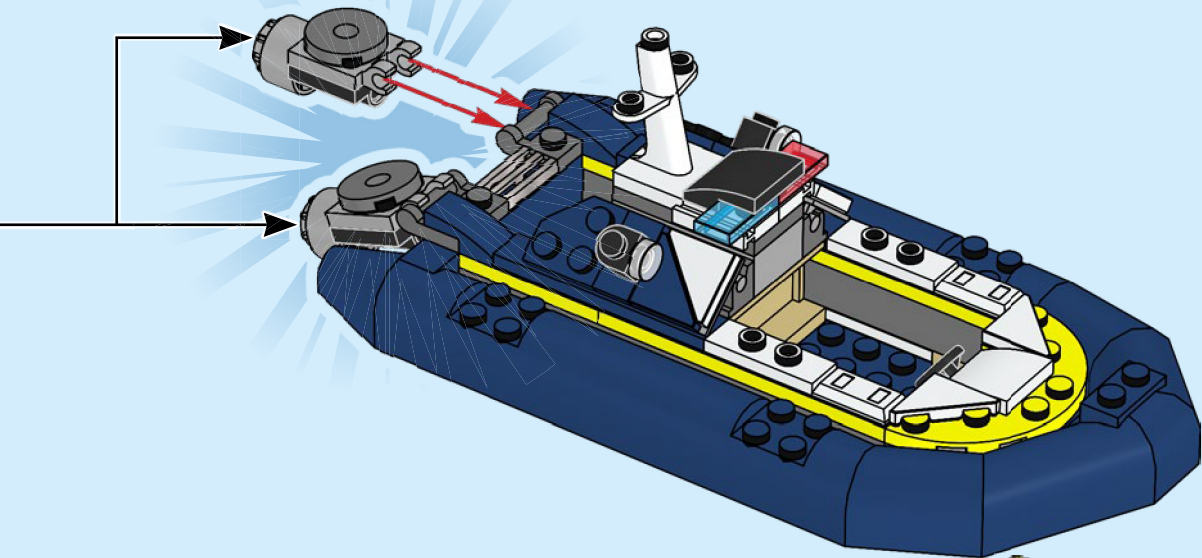

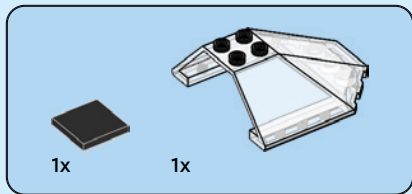

24

1

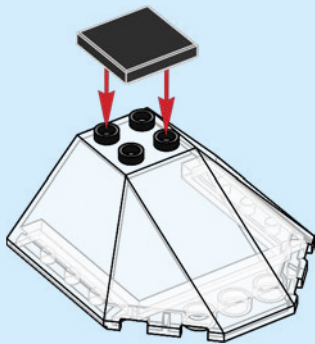

2

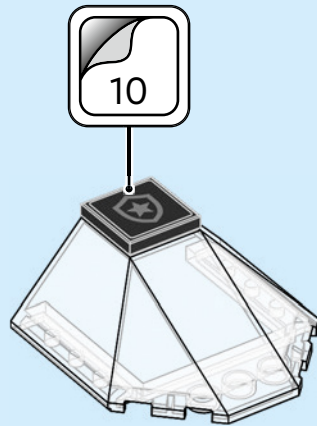

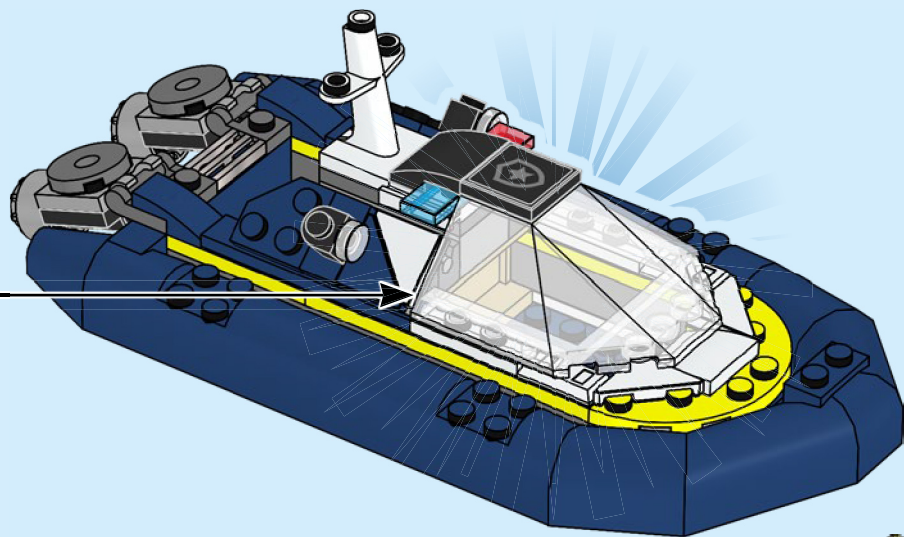

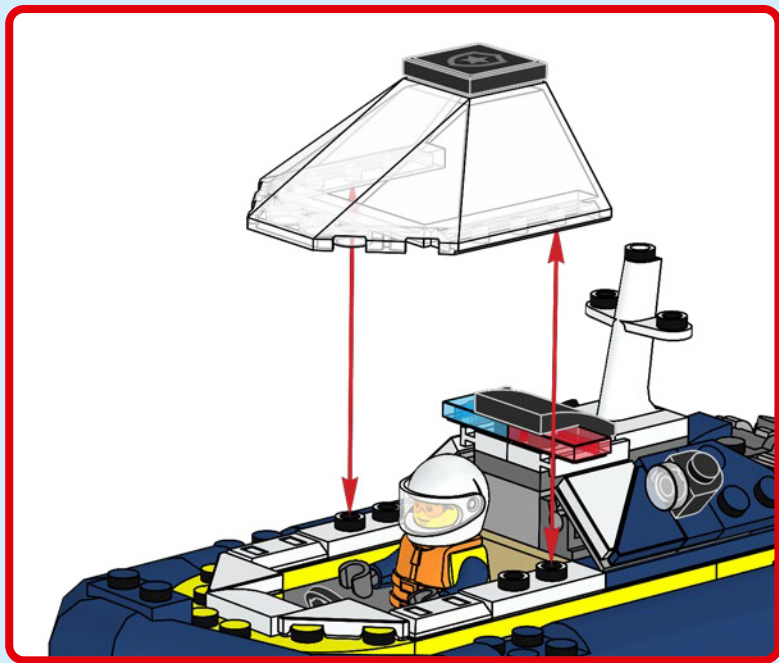

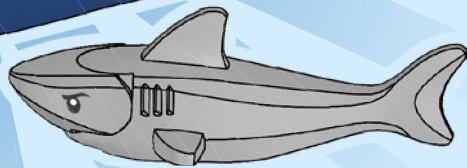
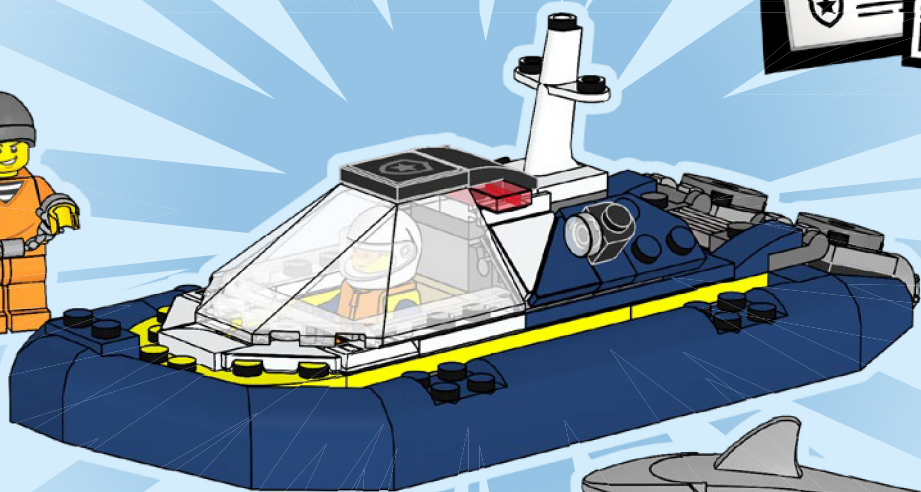



Rebuild
the
world™

