

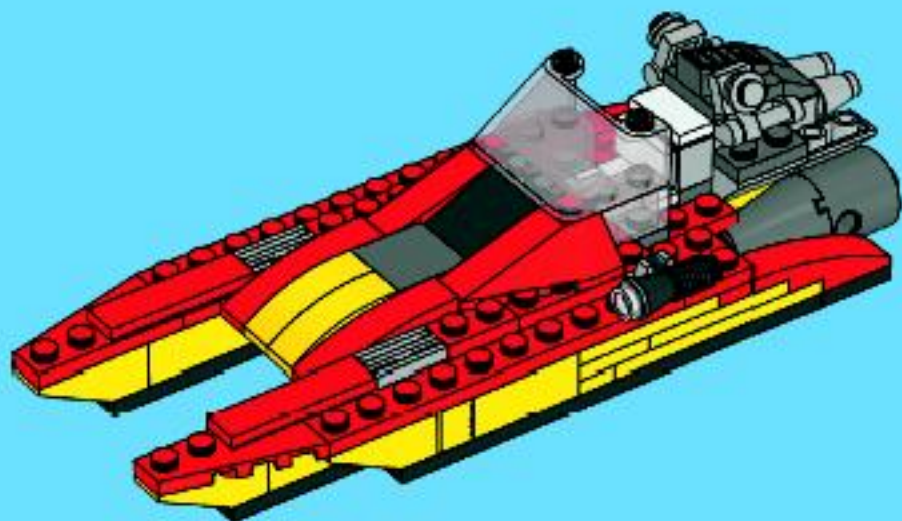

# CREATOR

5866

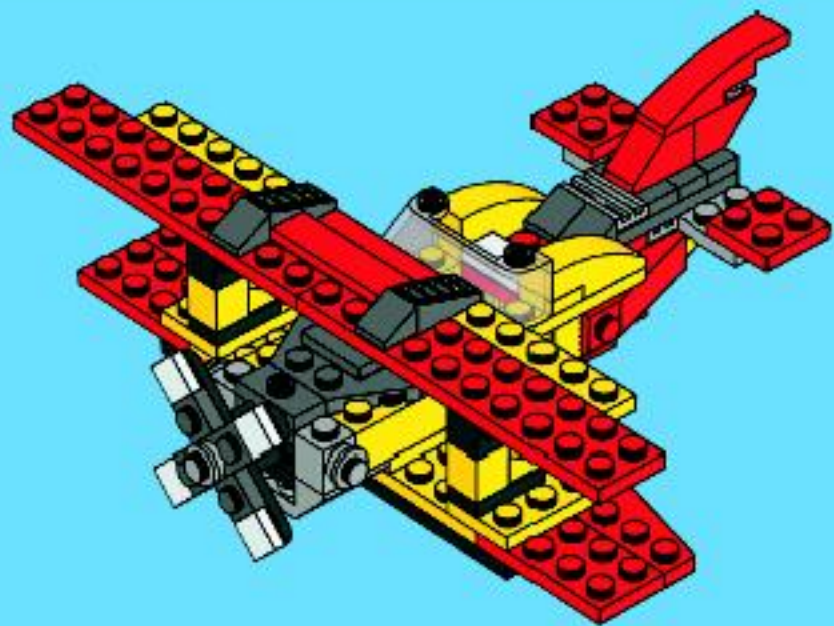



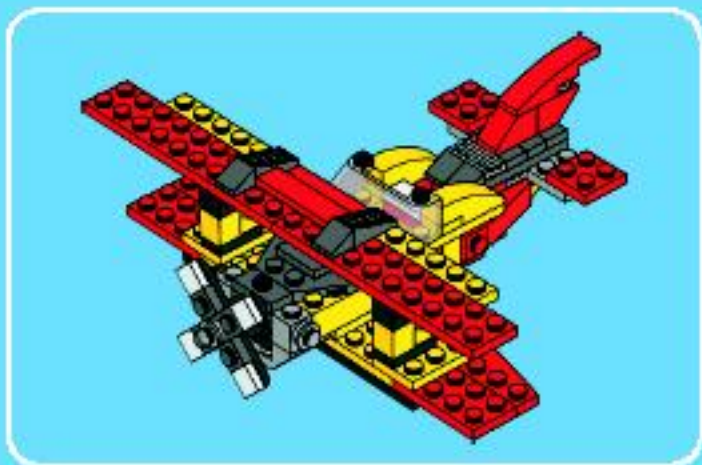

1



2

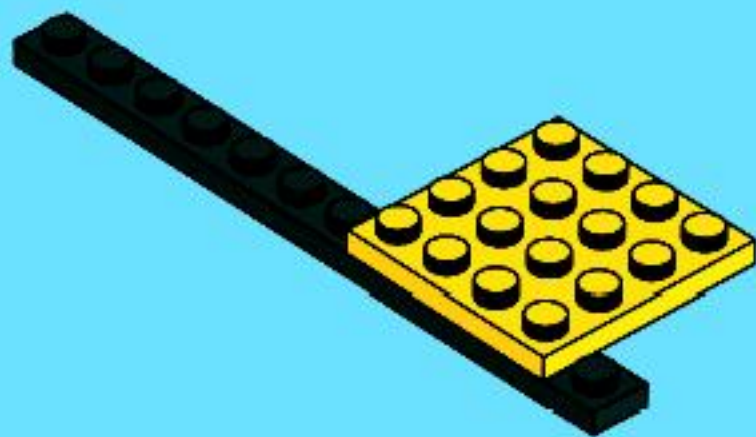



3x

3

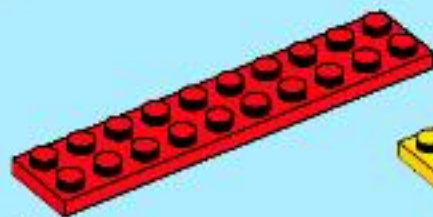
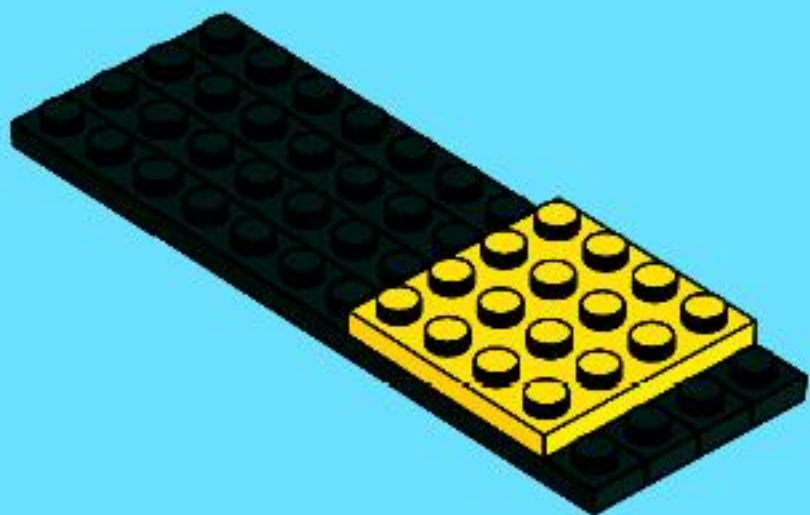

1x



1x

4

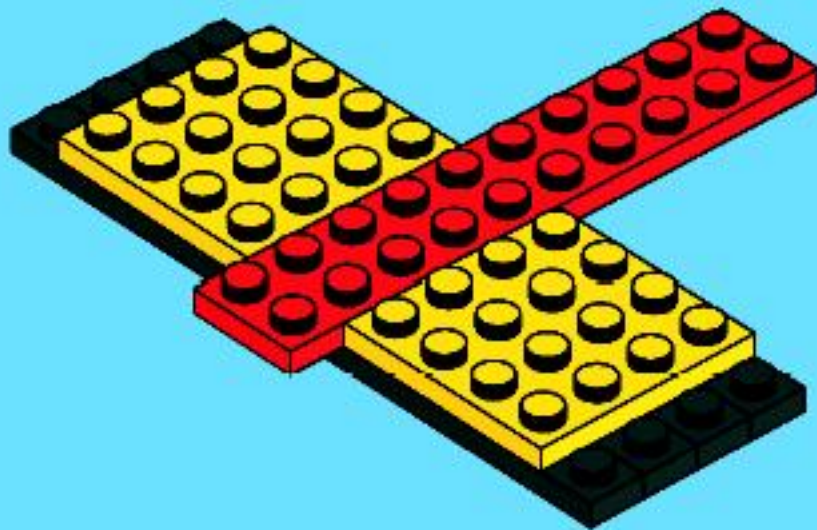



1x



1x



2x

5

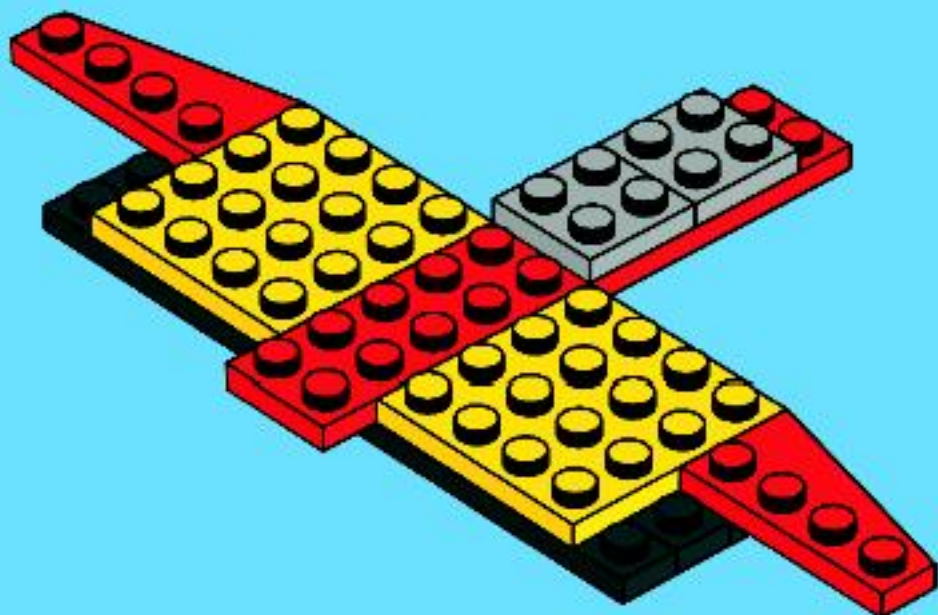

1x



2x



2x

6

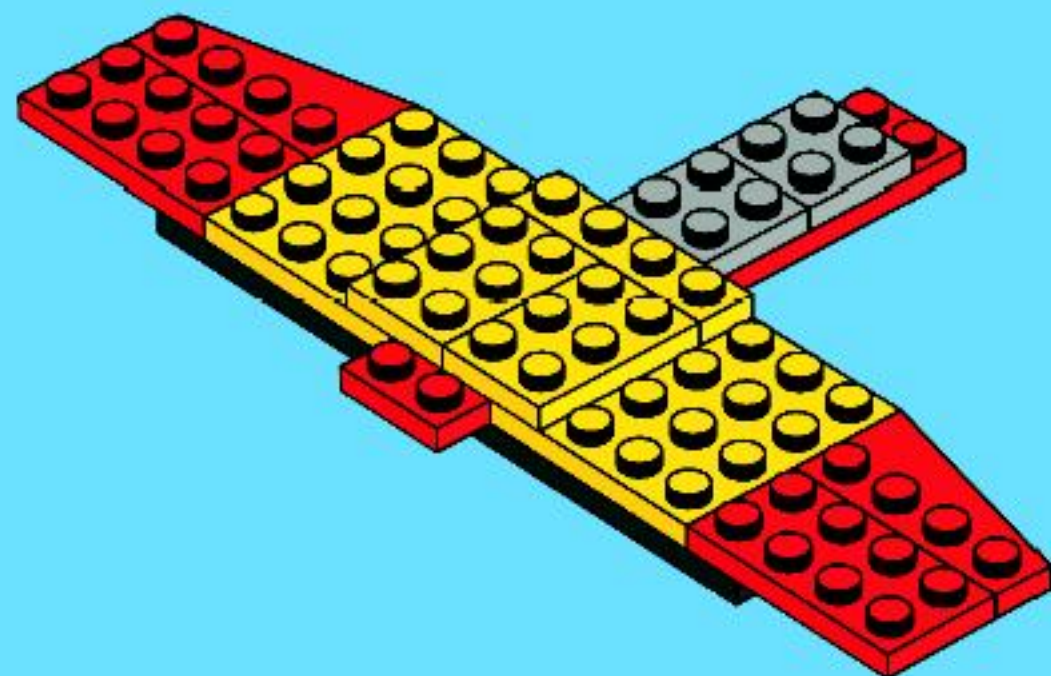



2x

7

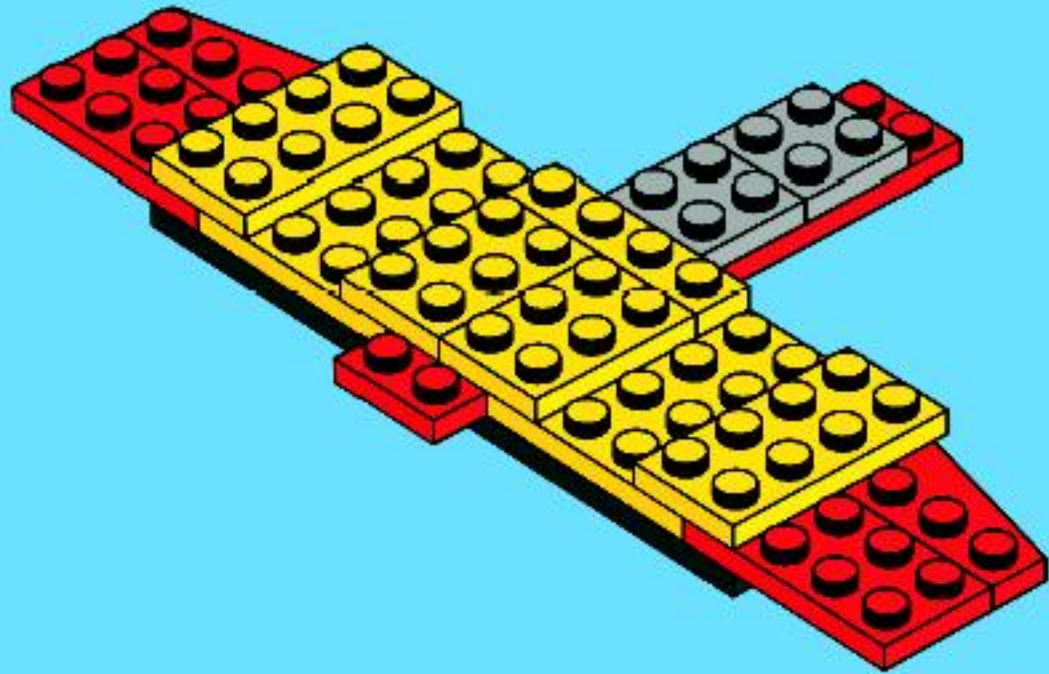

6

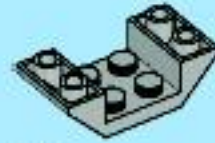

2x



1x

8

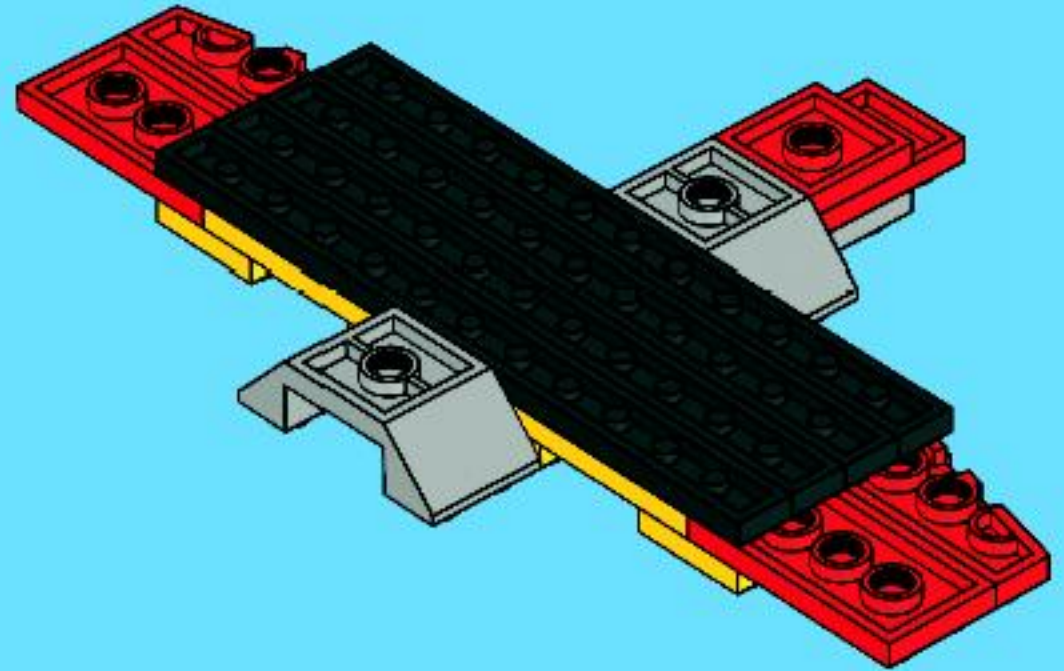



2x

9

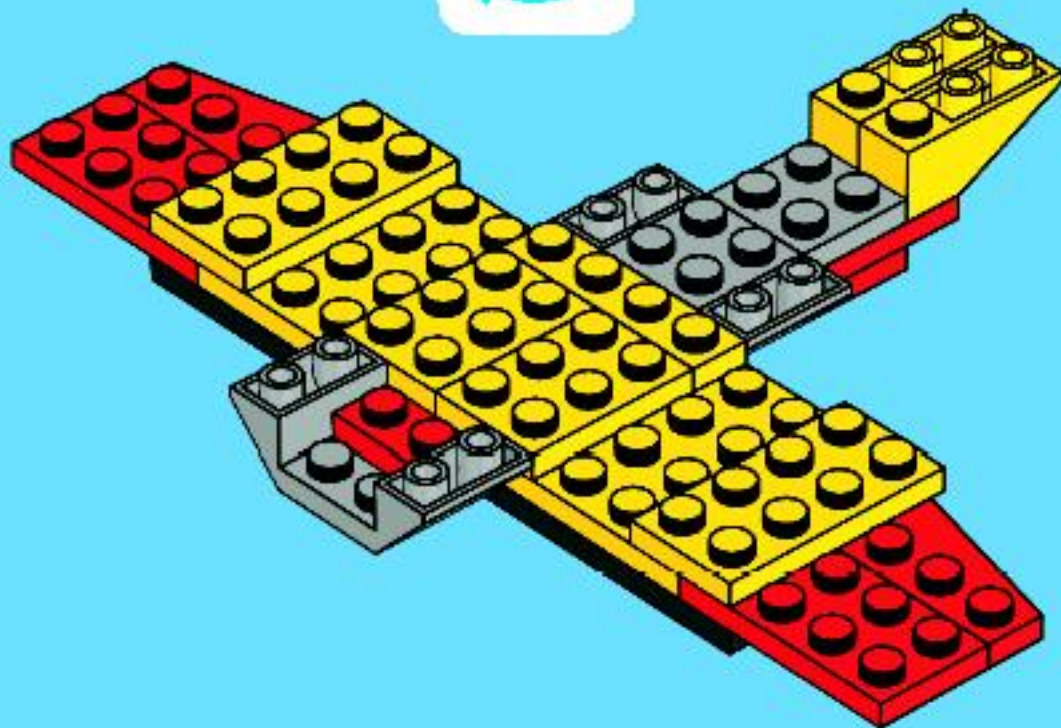



4x



1x

10

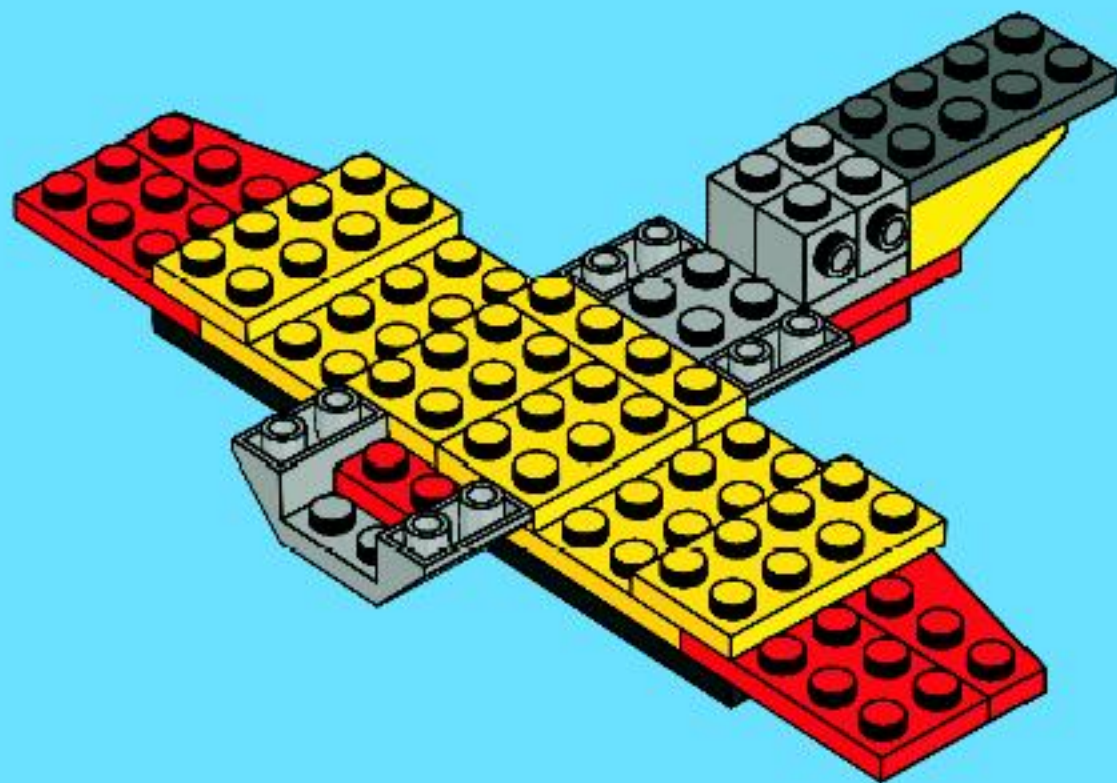





11

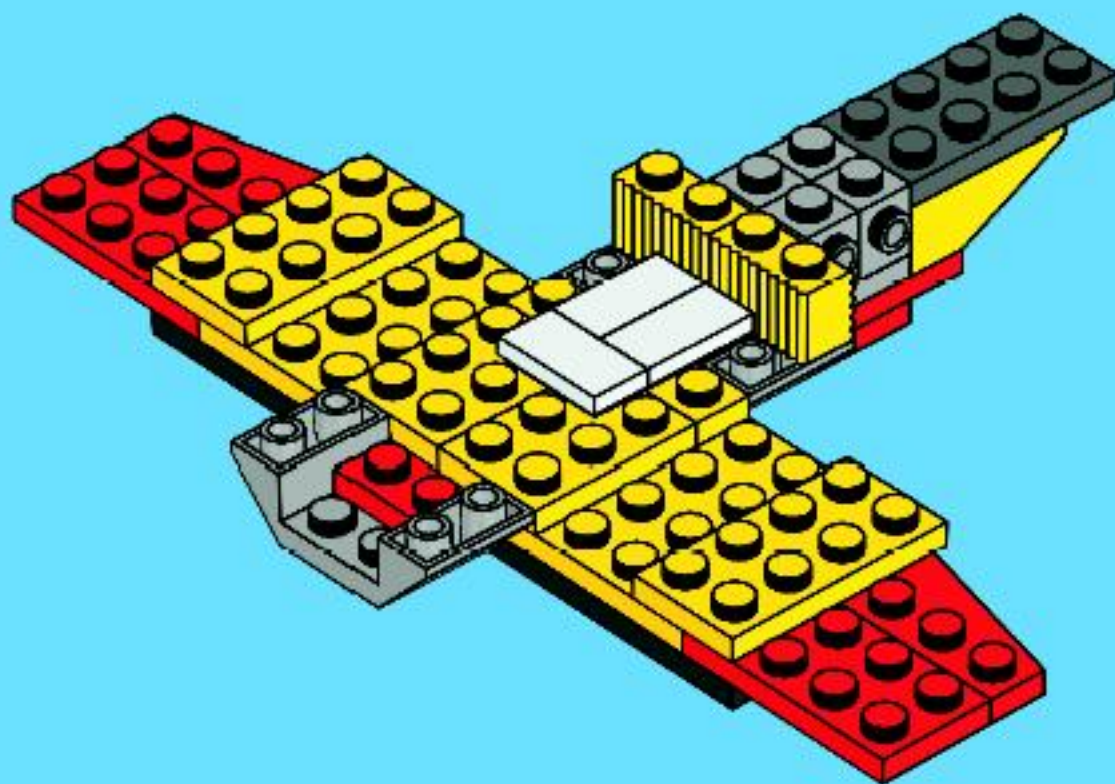



2x



2x

12

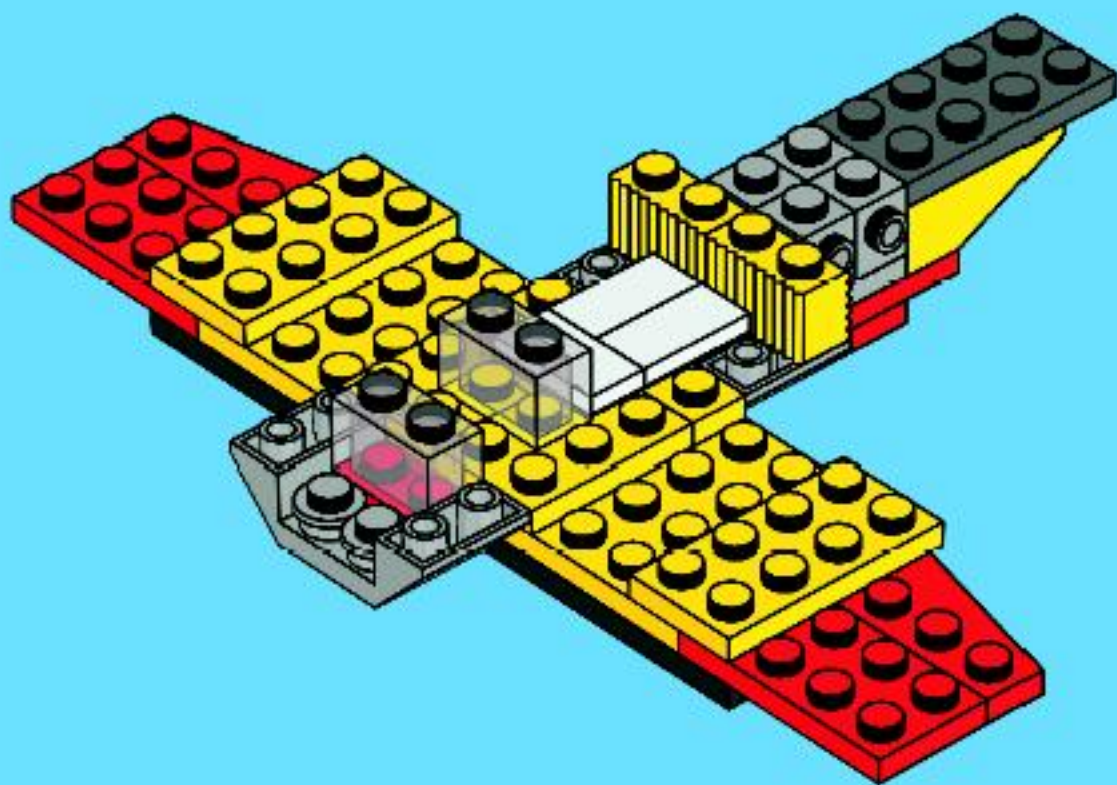



3x

13

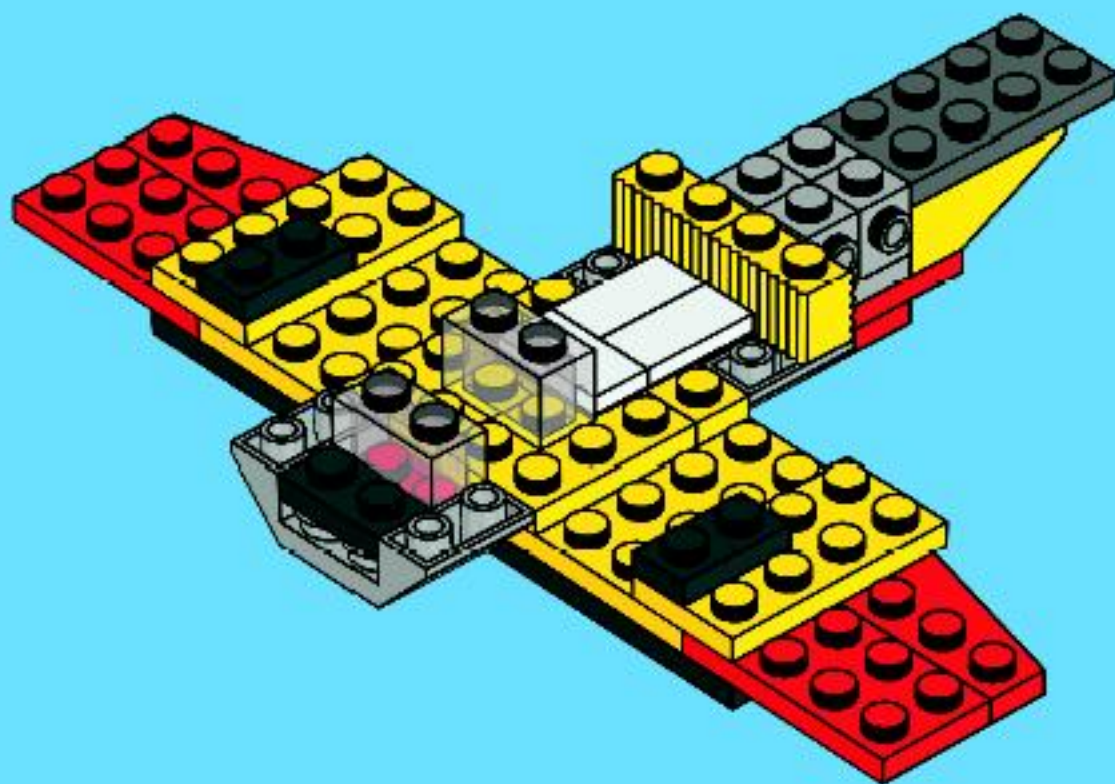



1x



1x



2x



2x

# 14

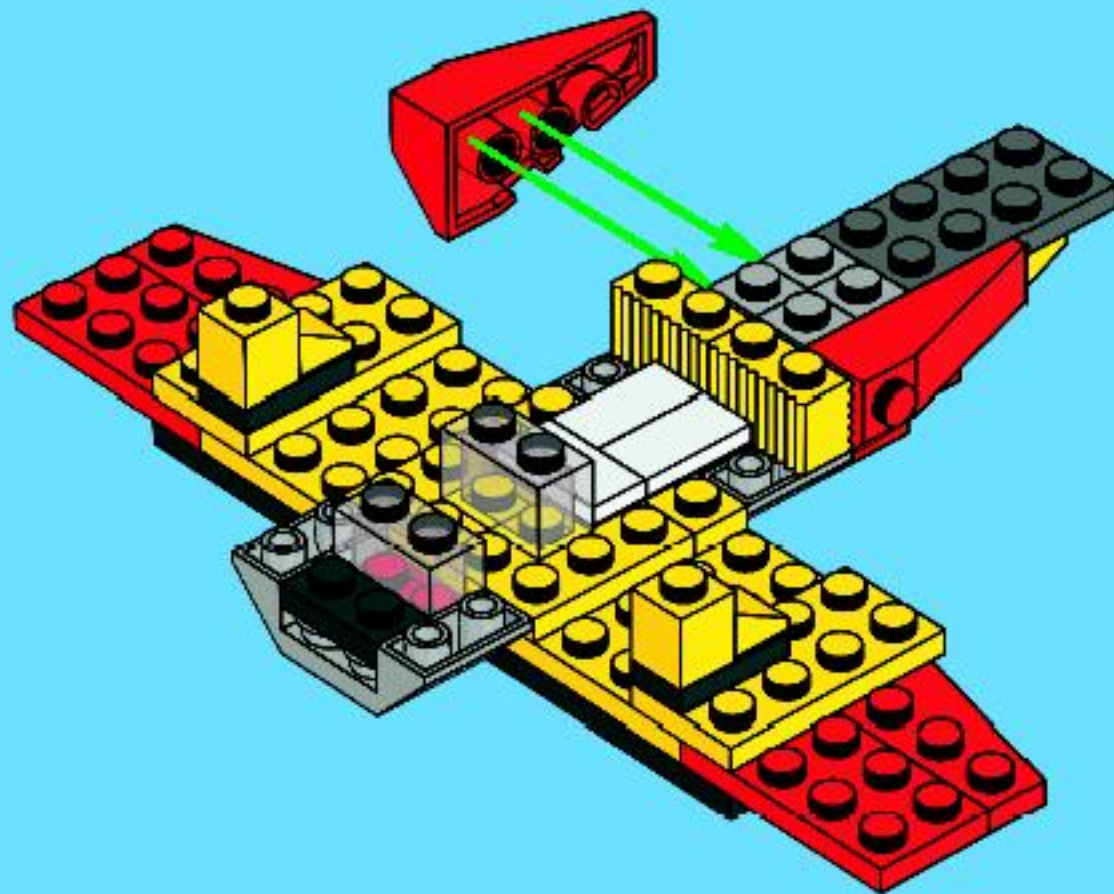



1x



4x

15

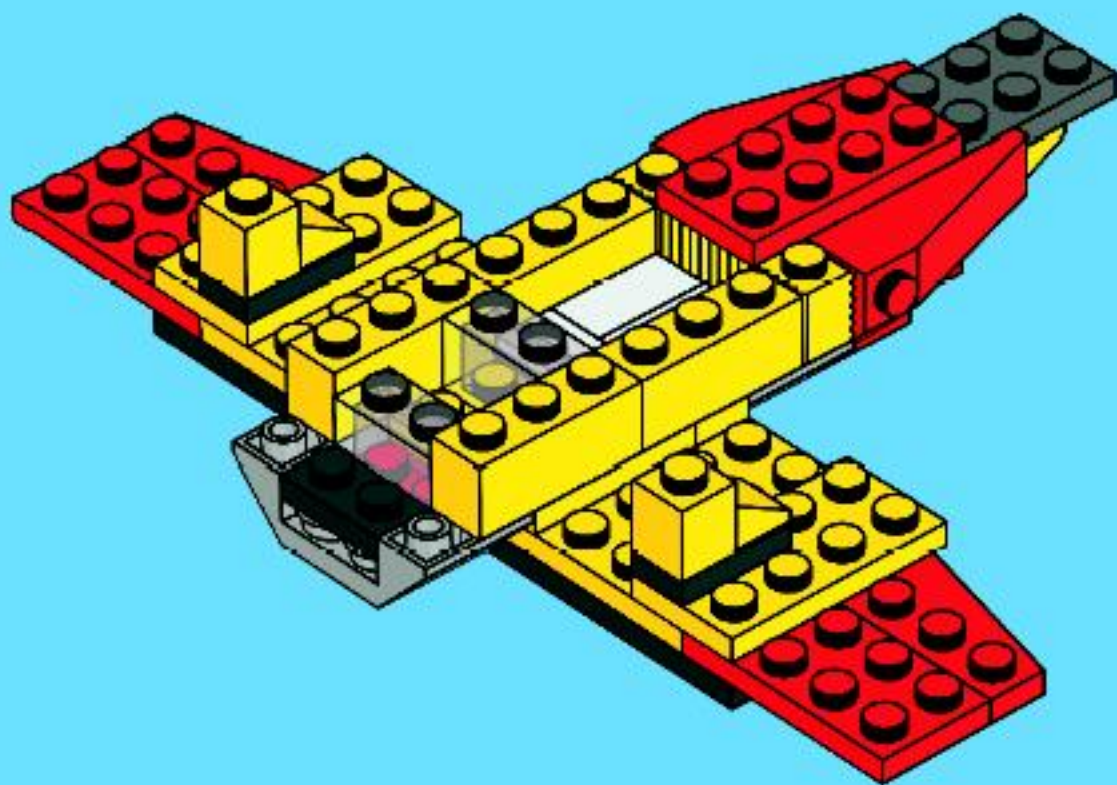



1x



1x



1x

# 16

1

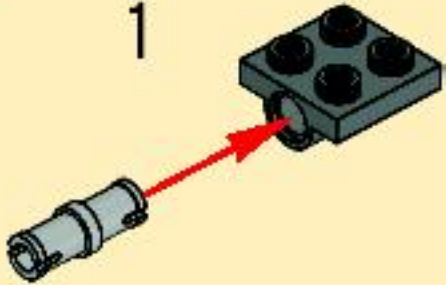

2

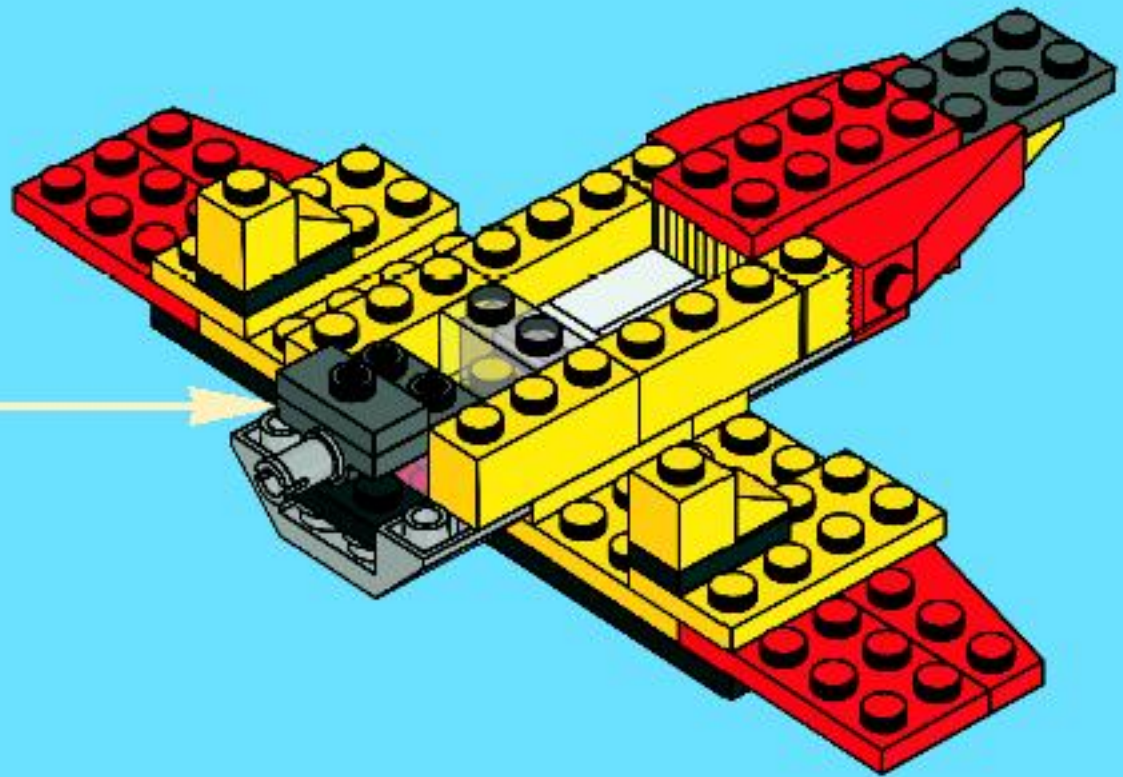



2x



2x

17

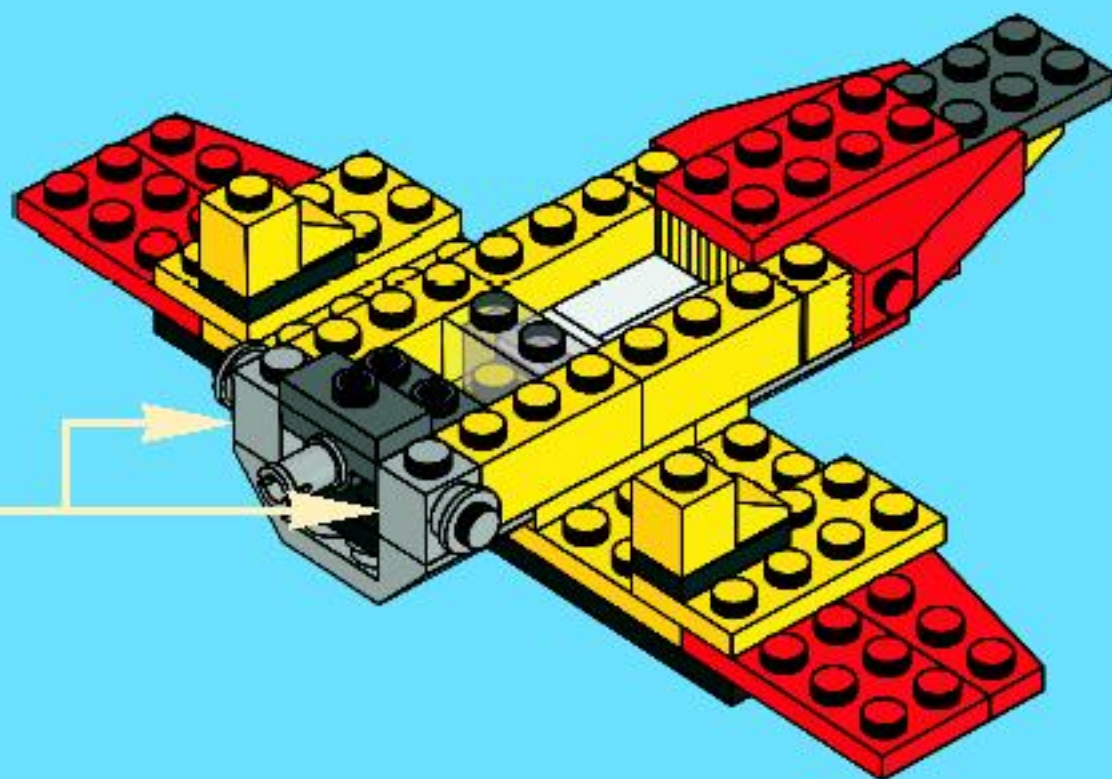
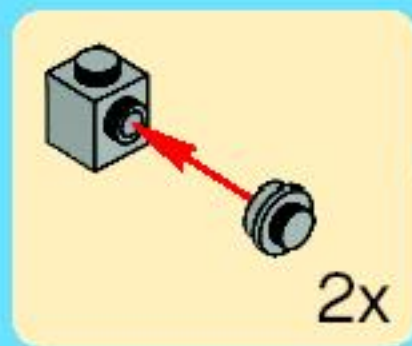



2x



1x

# 18

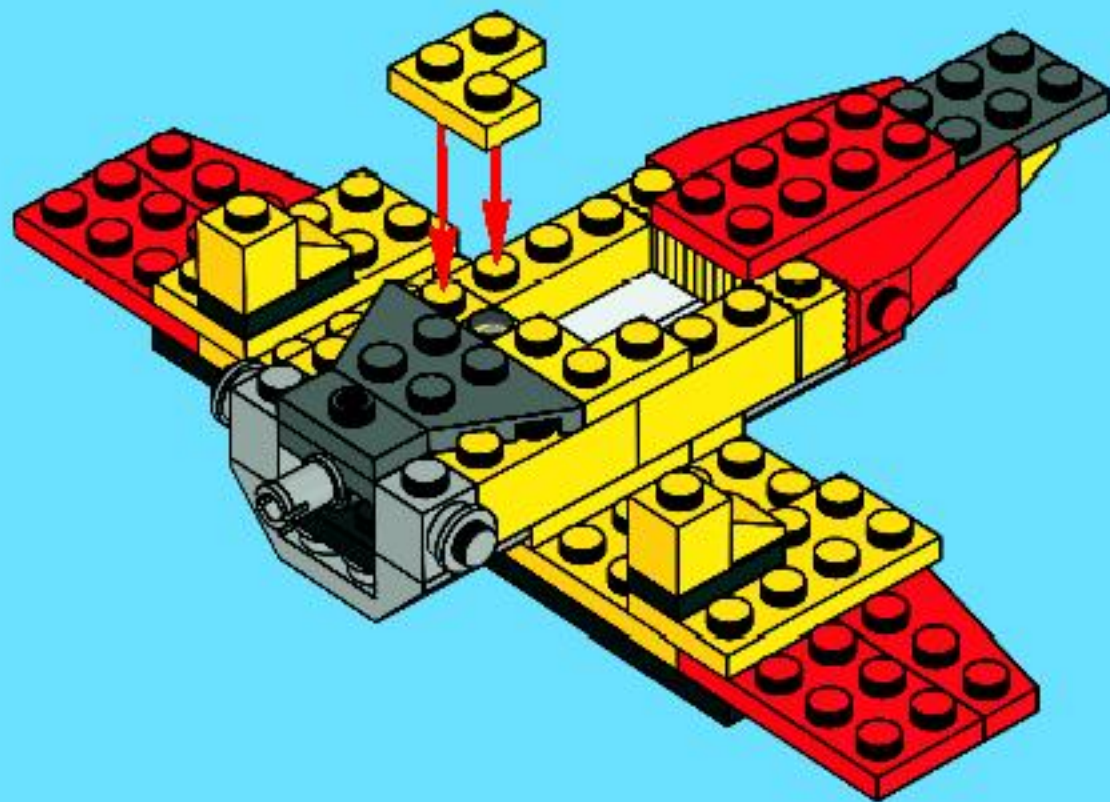





2x



2x

# 19

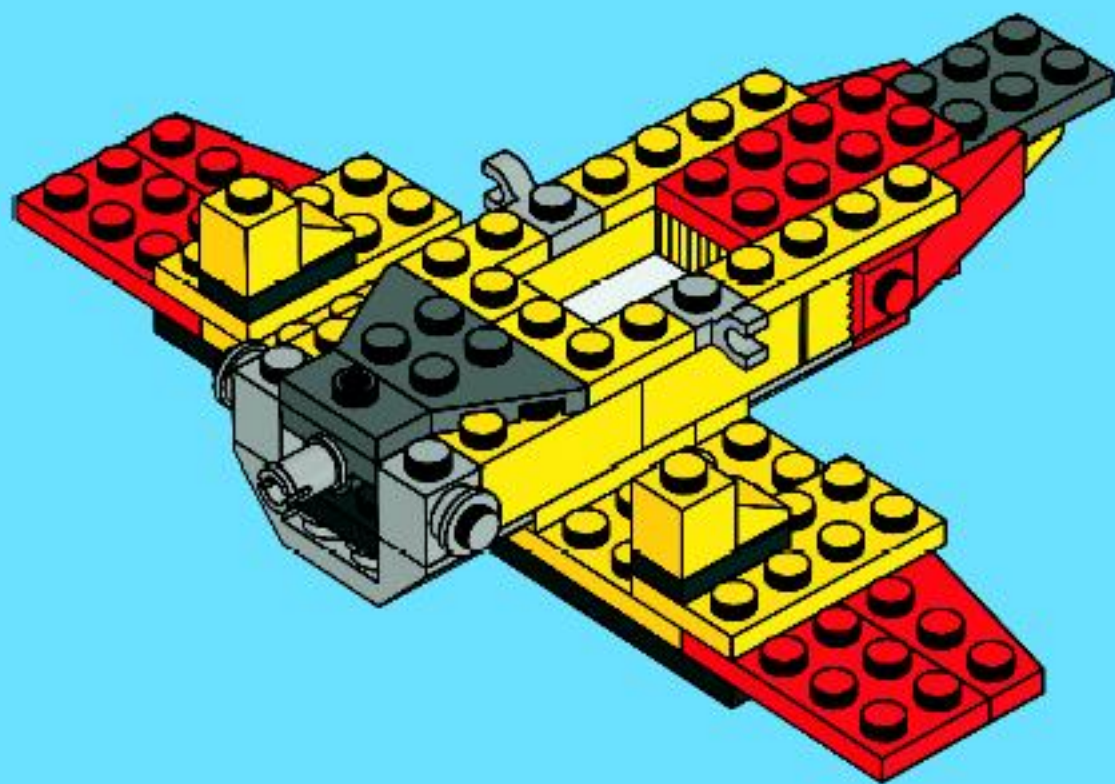



1x

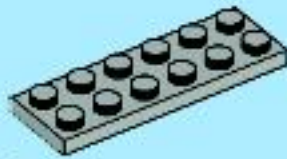

1x

20

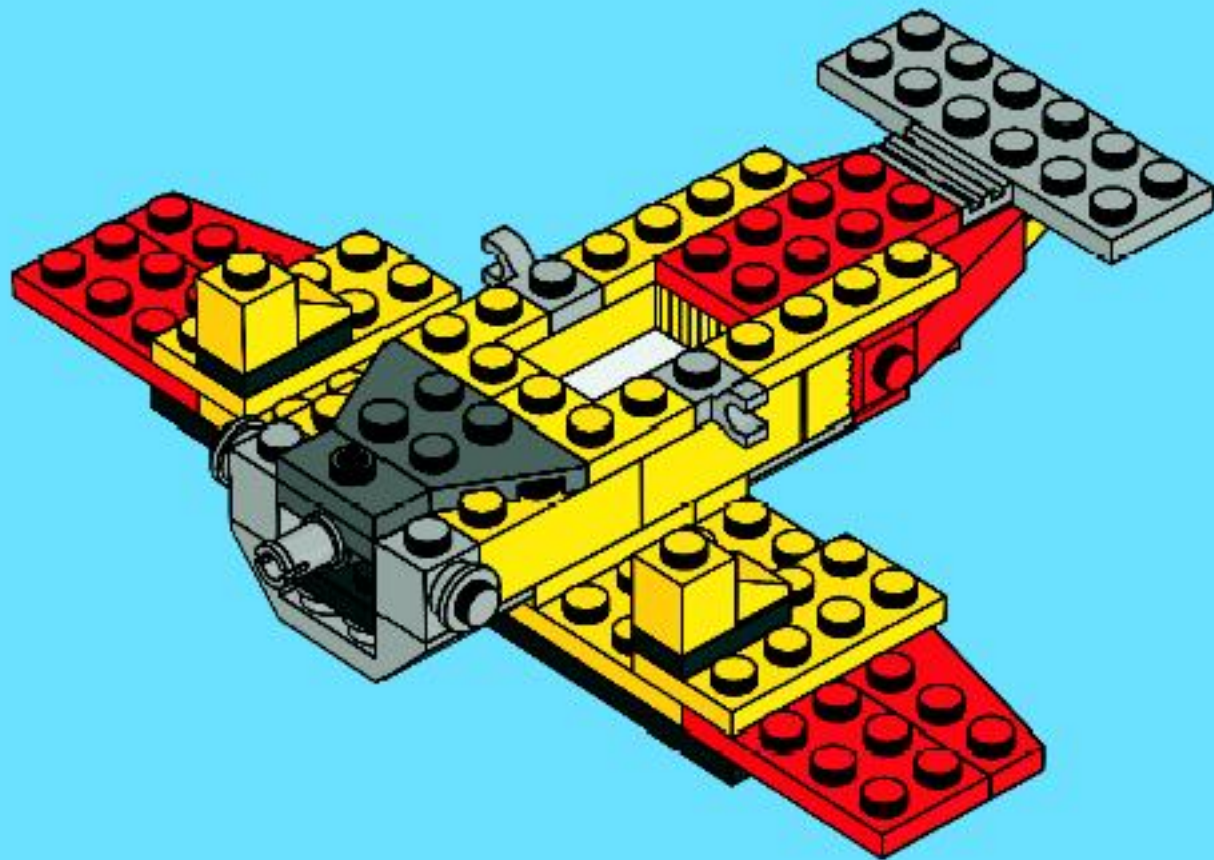



1x



1x



2x

# 21

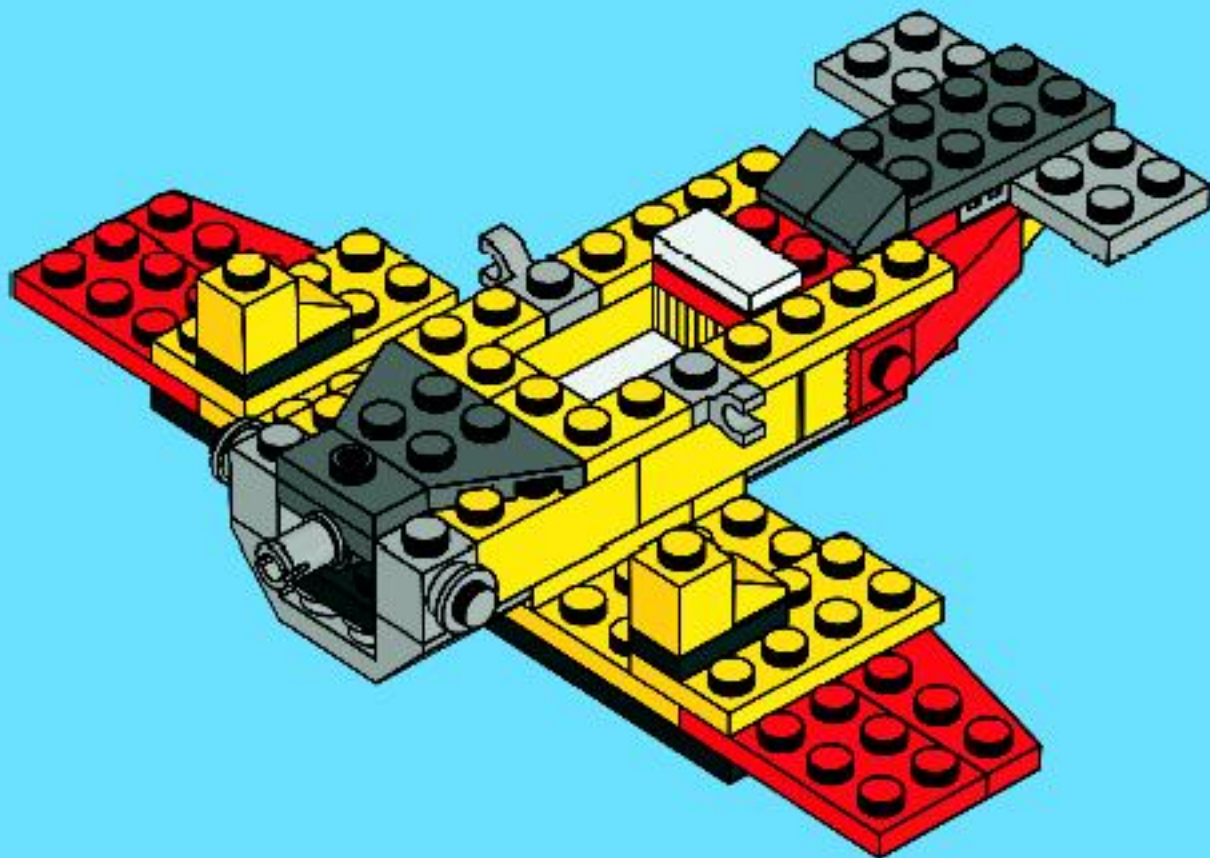



3x



1x

22

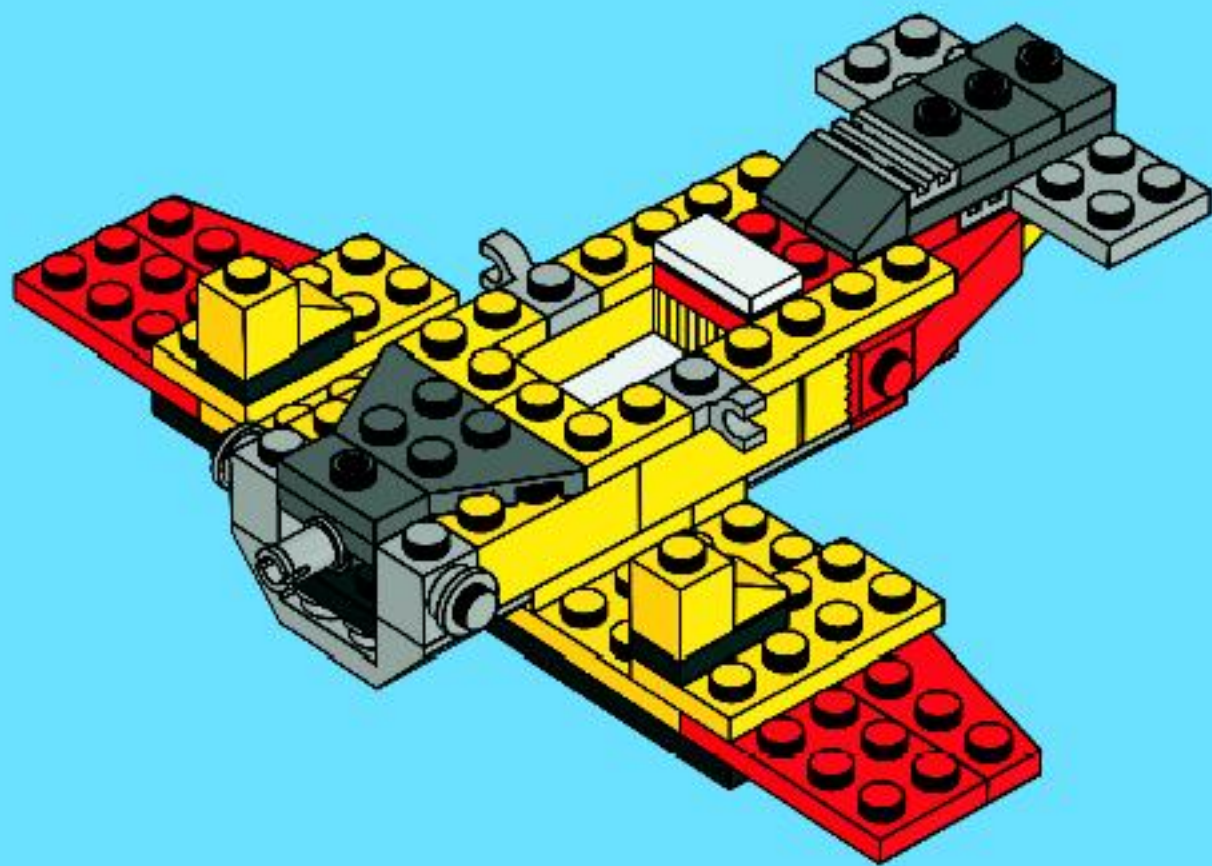

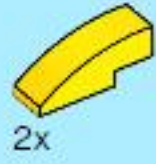

23

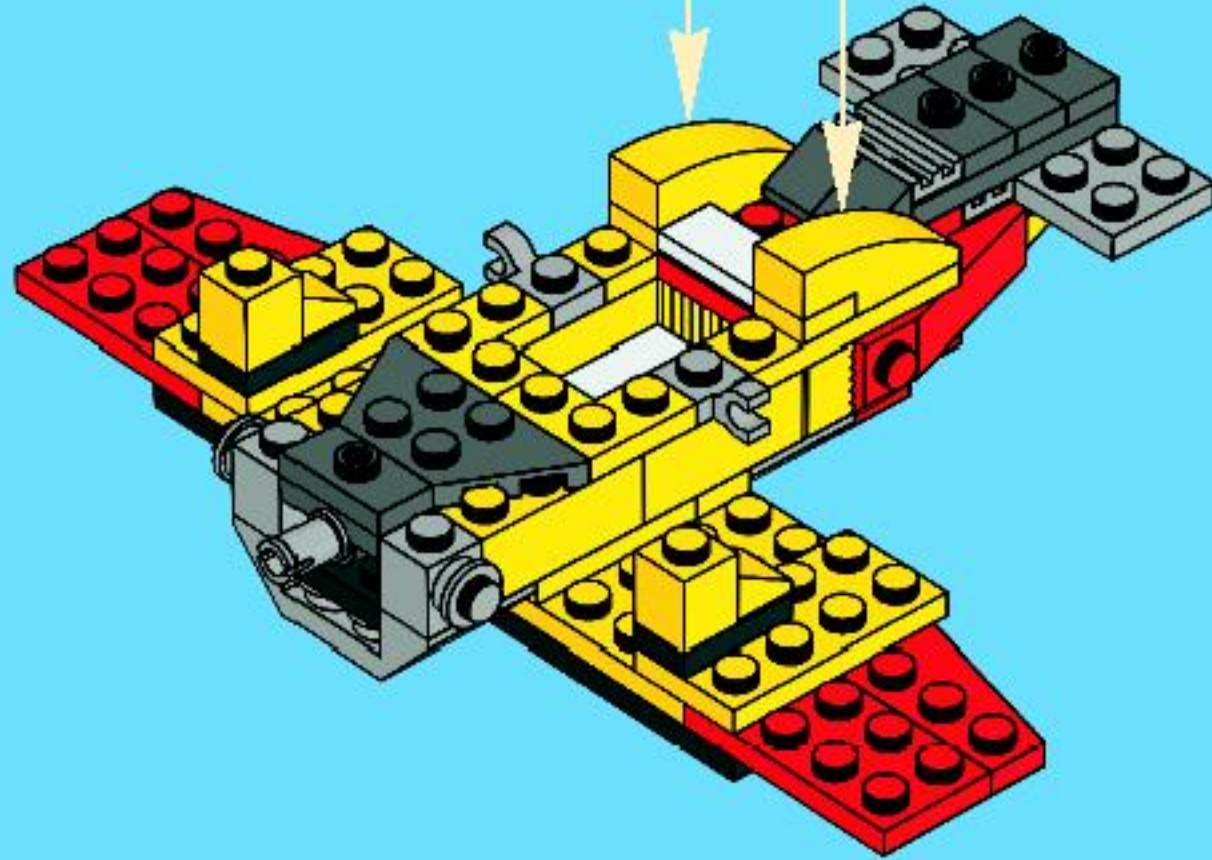
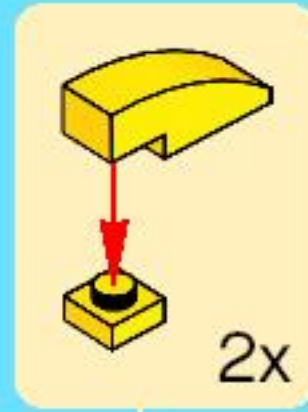



1x



2x



1x

# 24

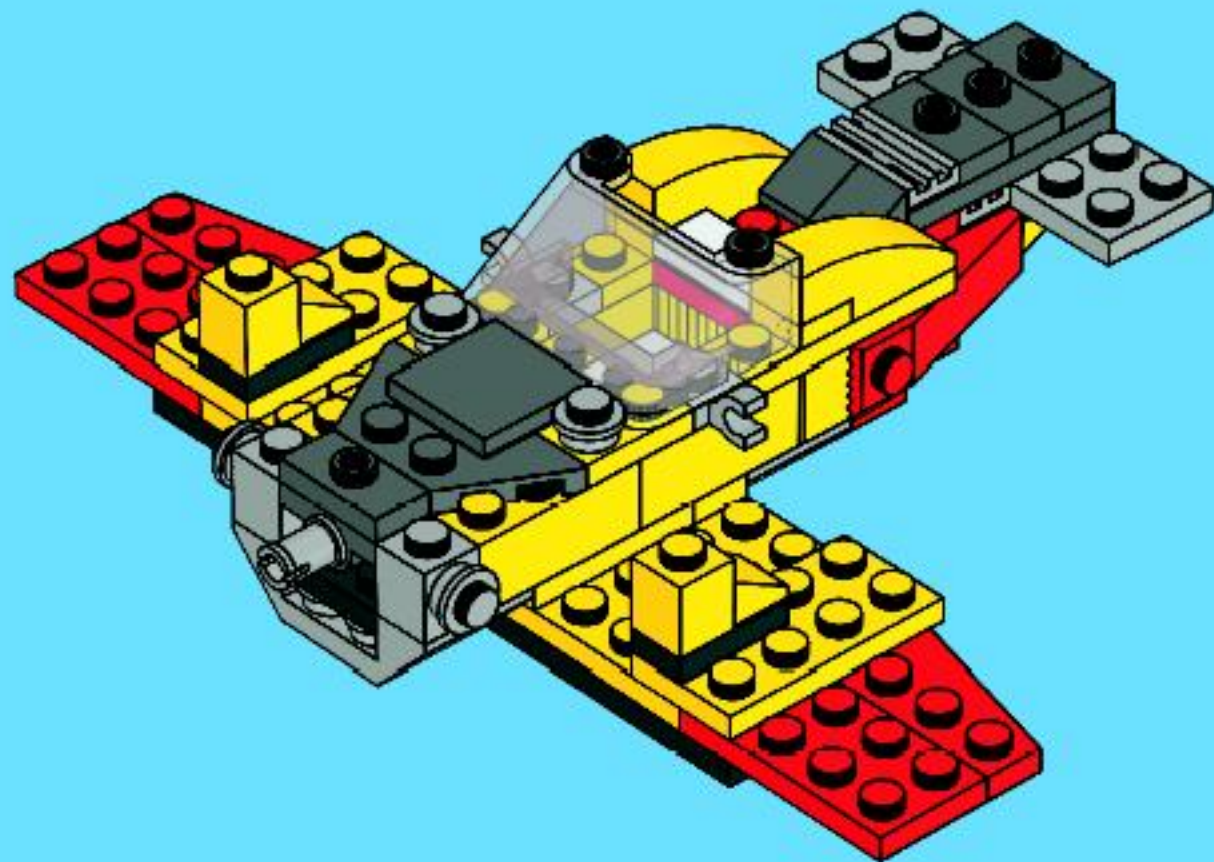



2x



2x

# 25

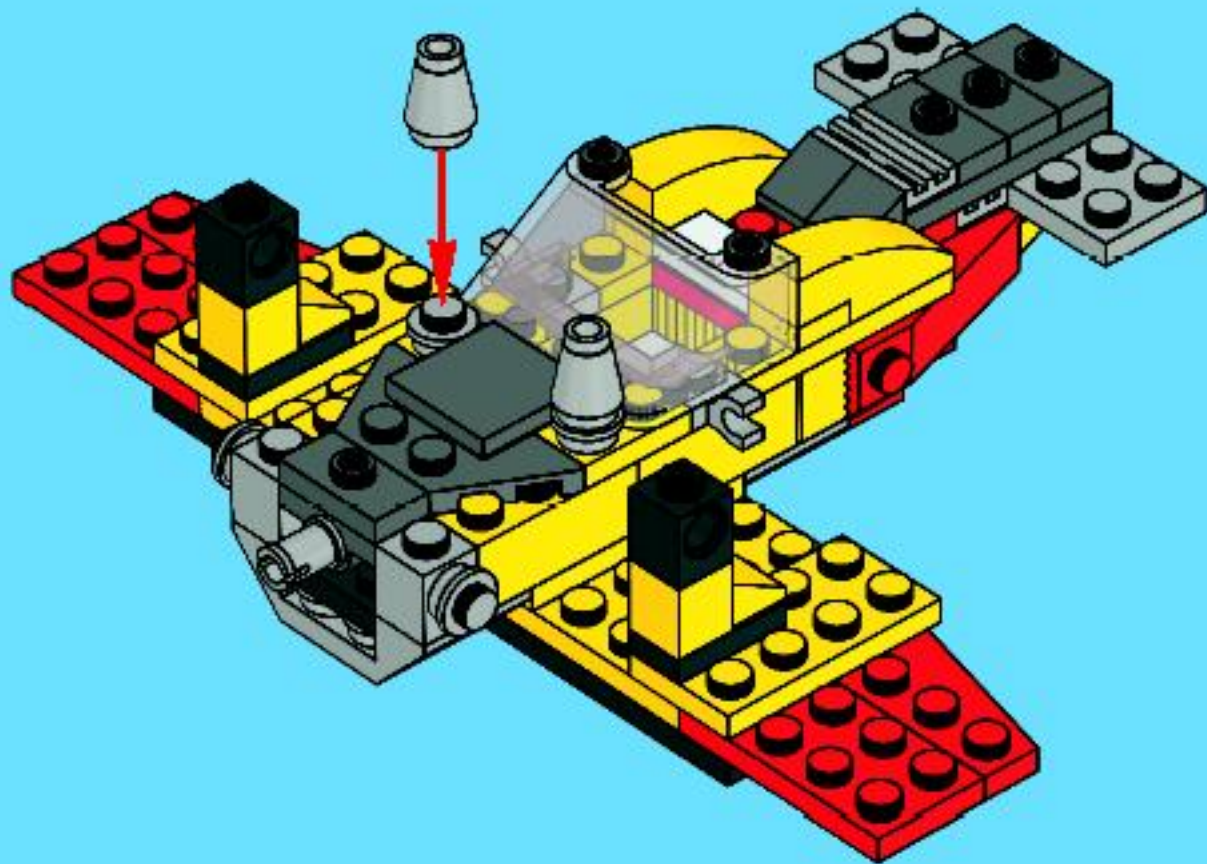



1x



1x



2x

# 26

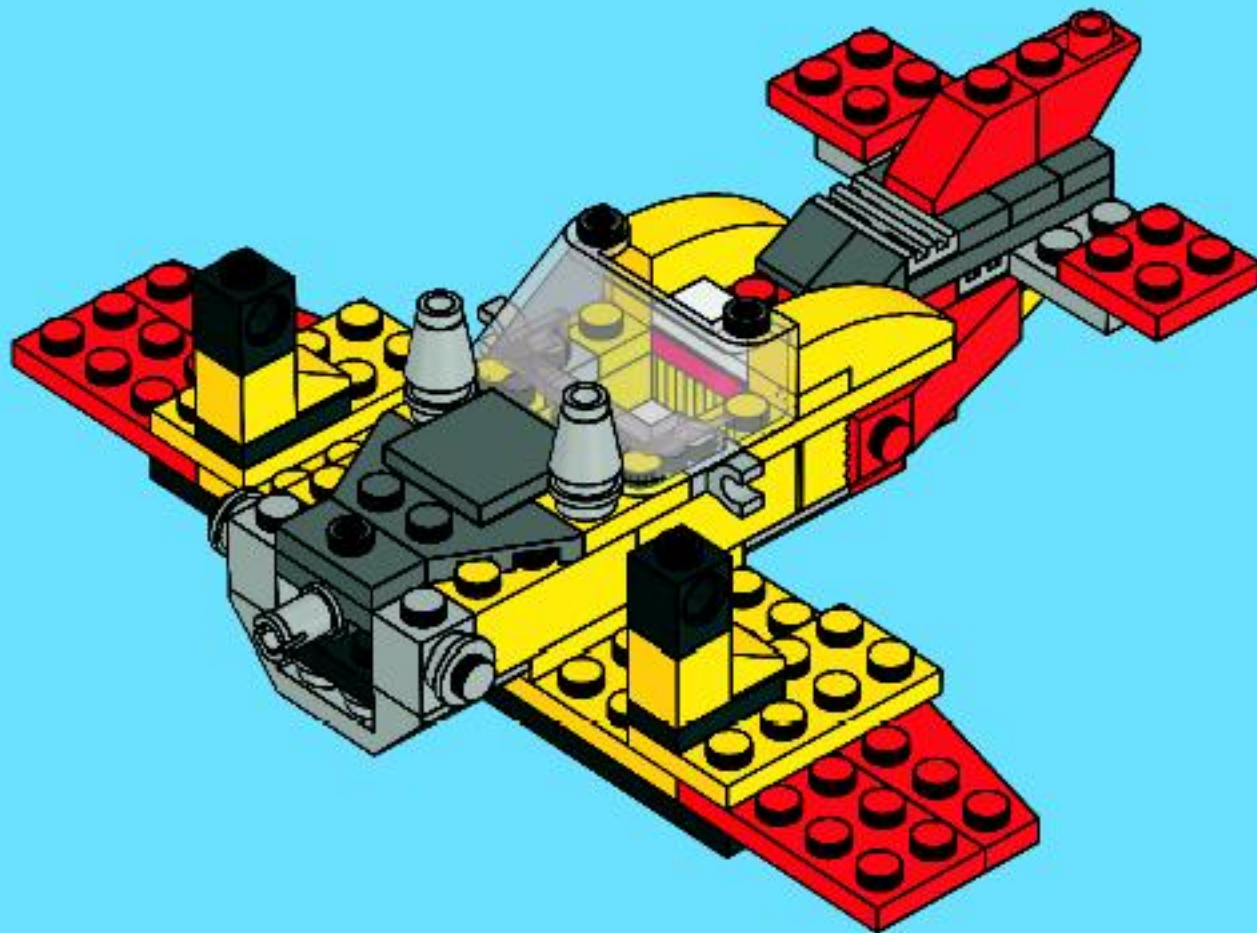





1x



1x



2x

27

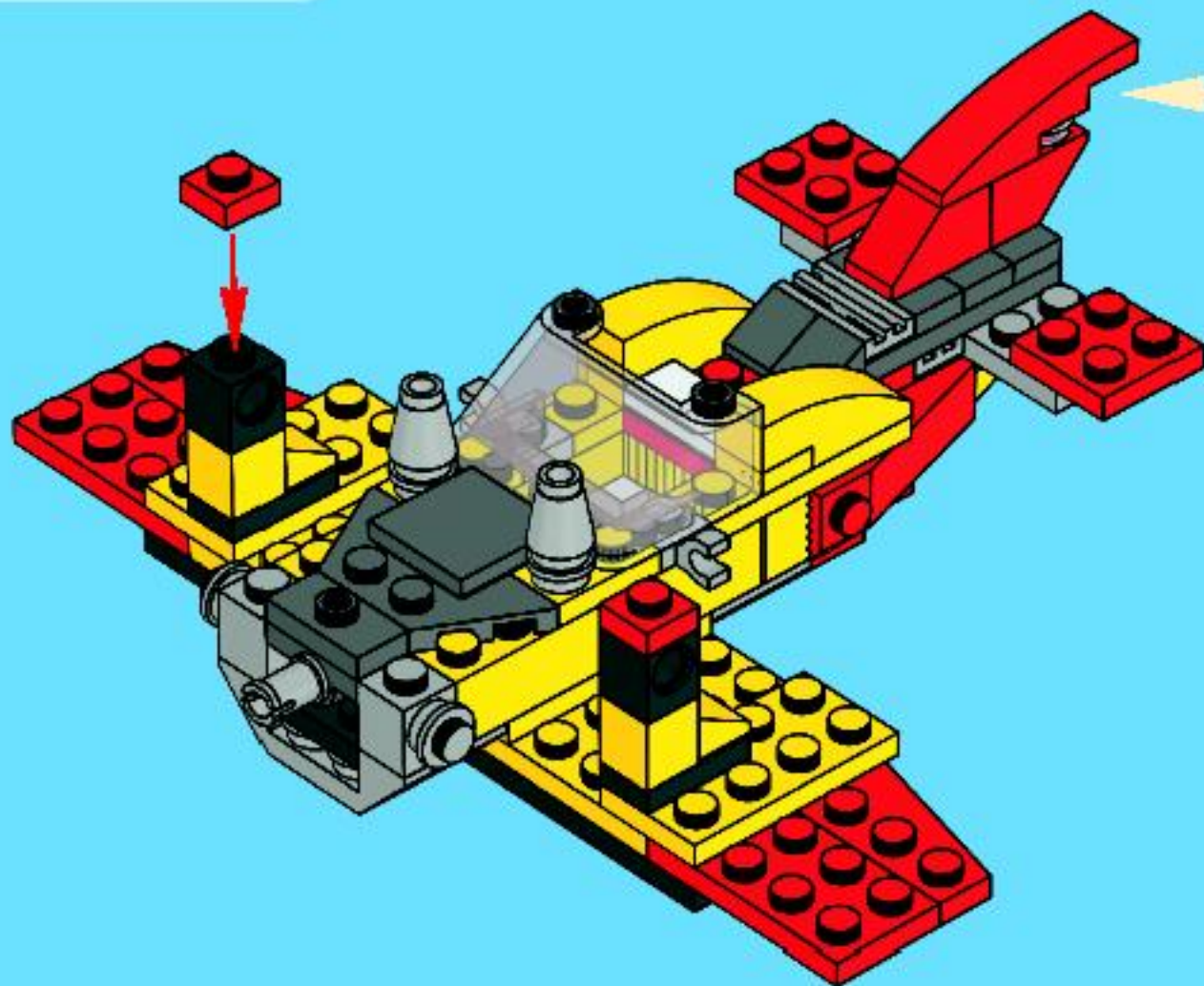

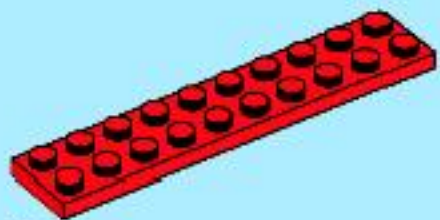

1x

28

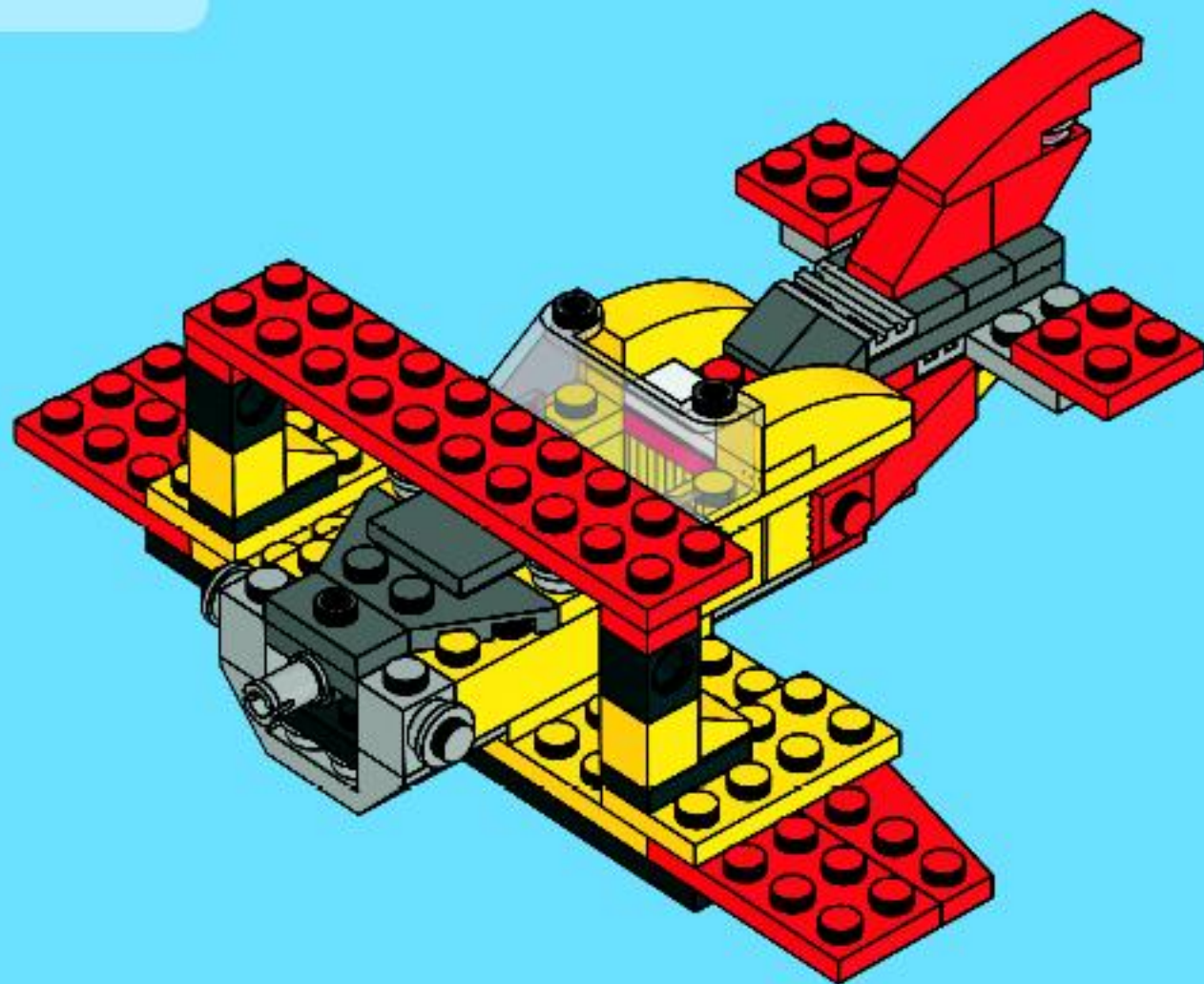



1x



2x

29

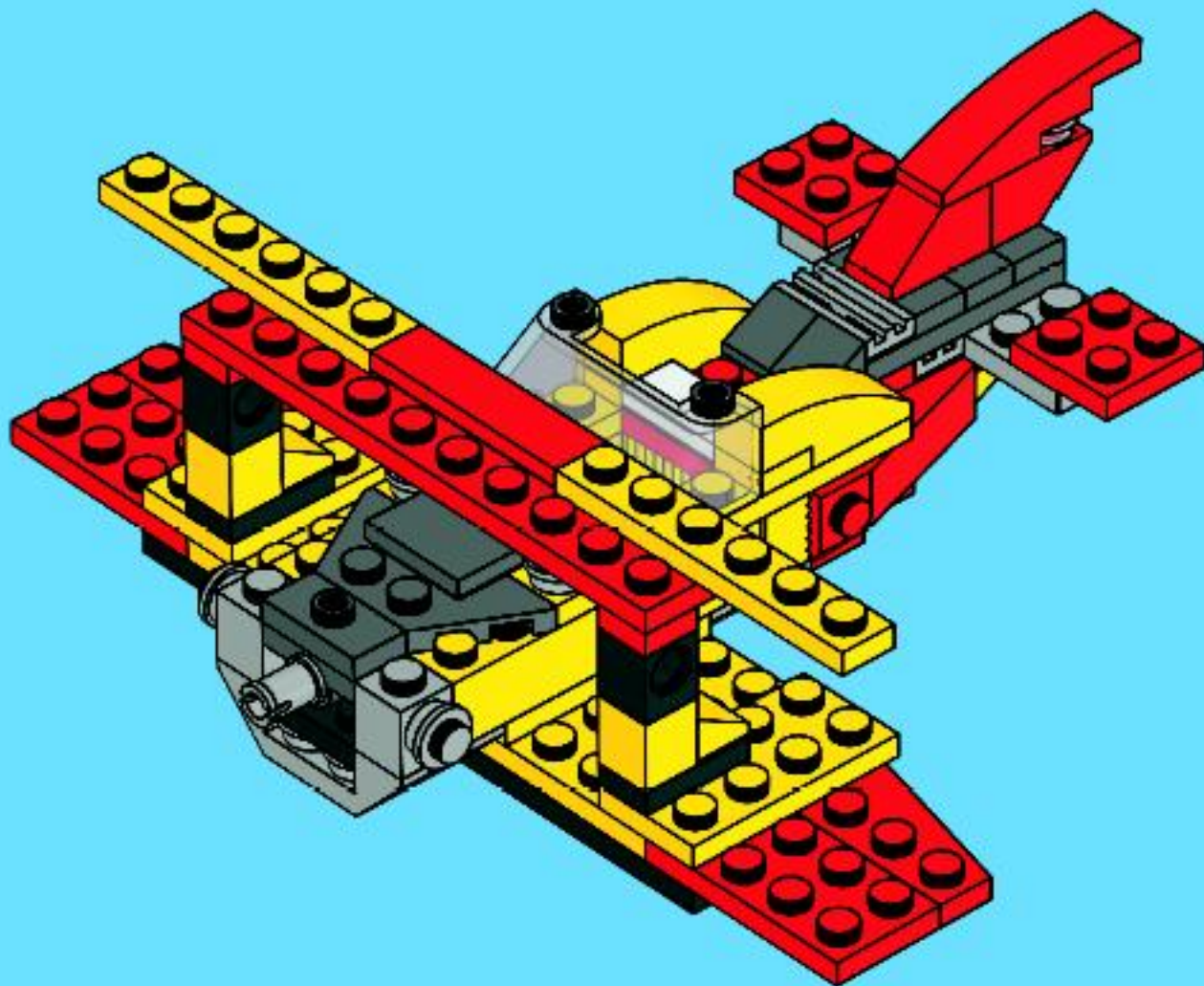

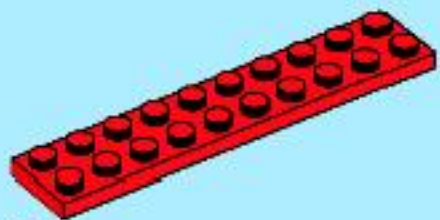

2x

30

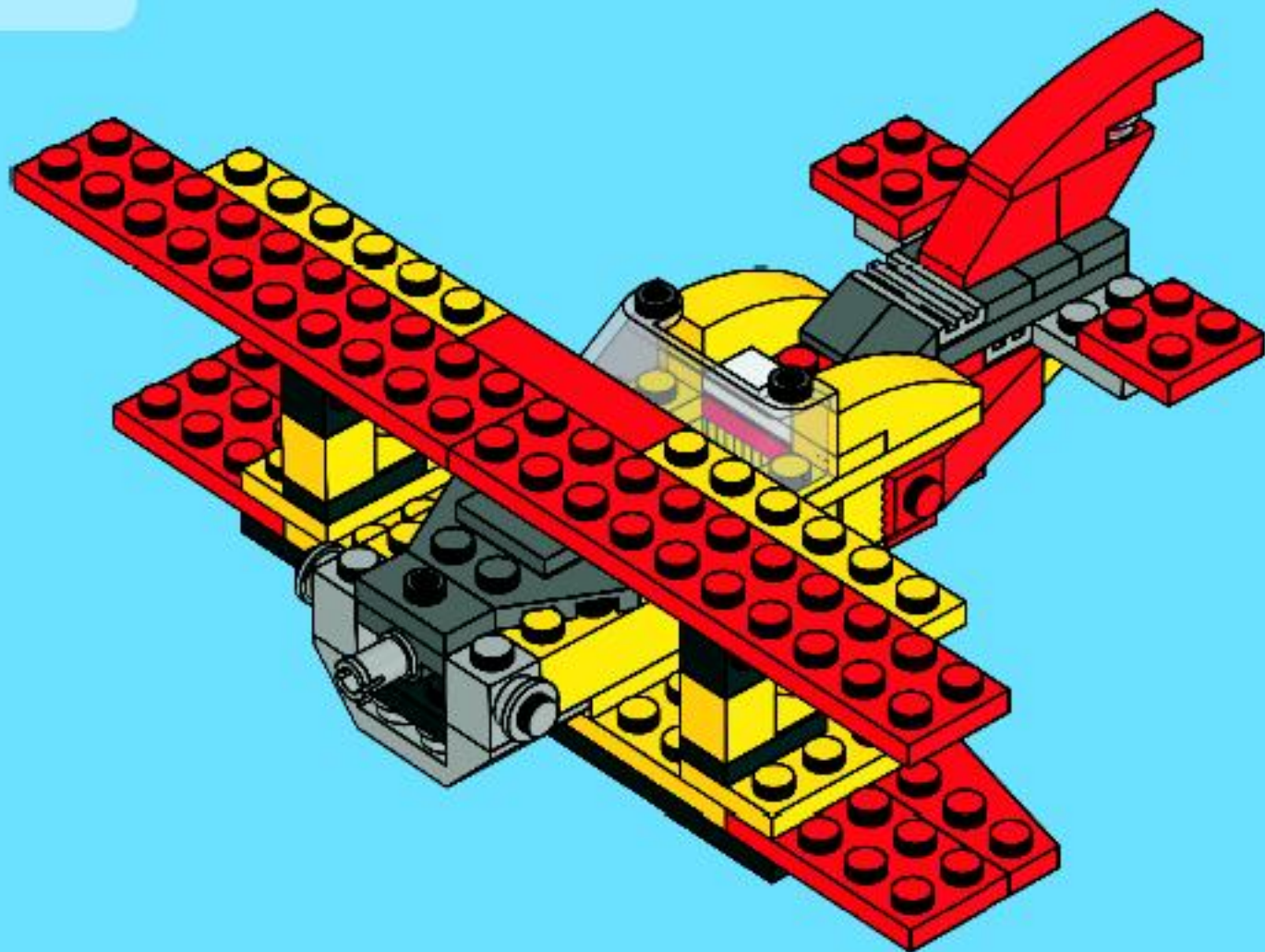



1x



2x



2x

31

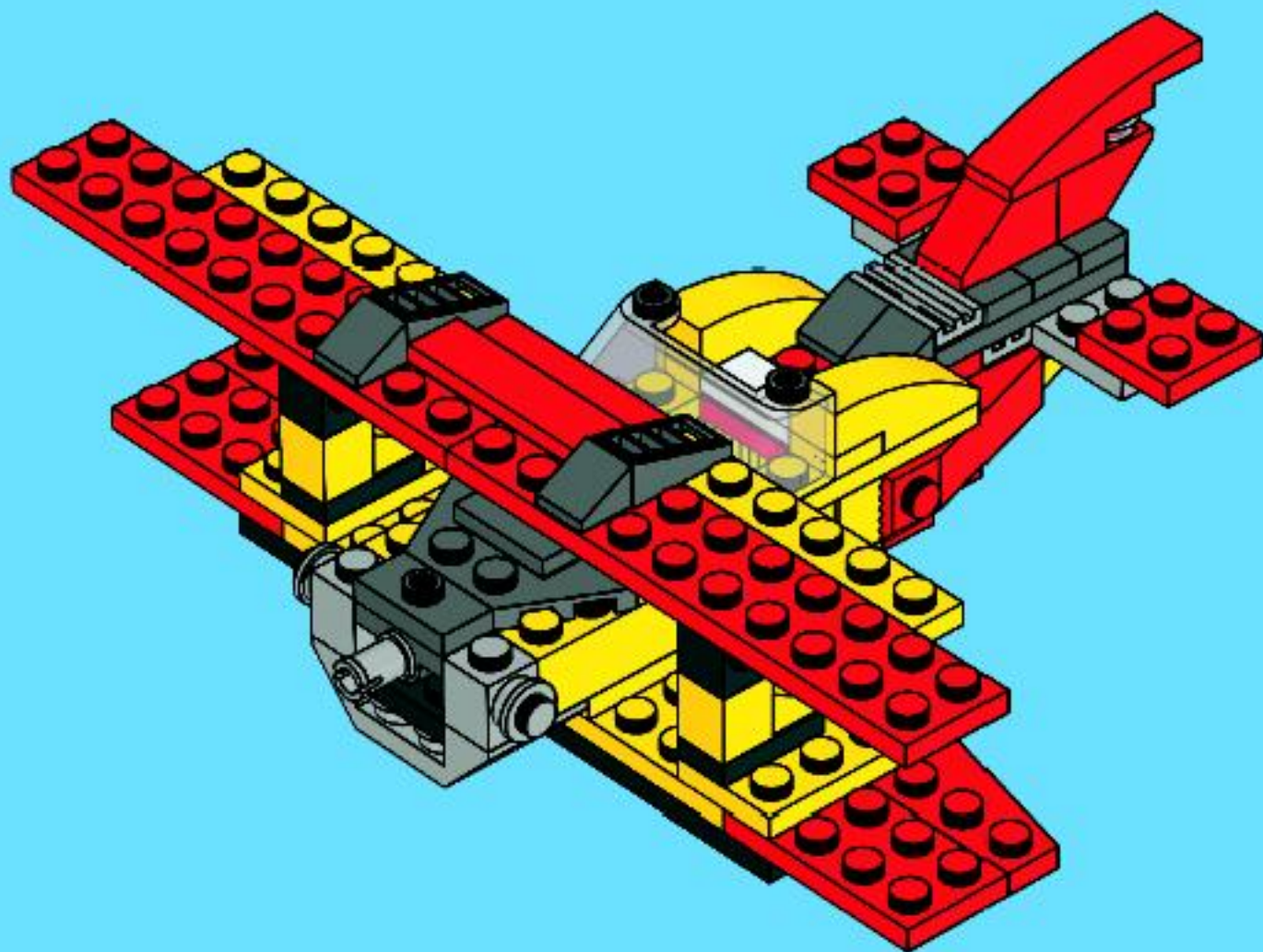



1x



1x



4x



2x



1x

32

1



2



3



4

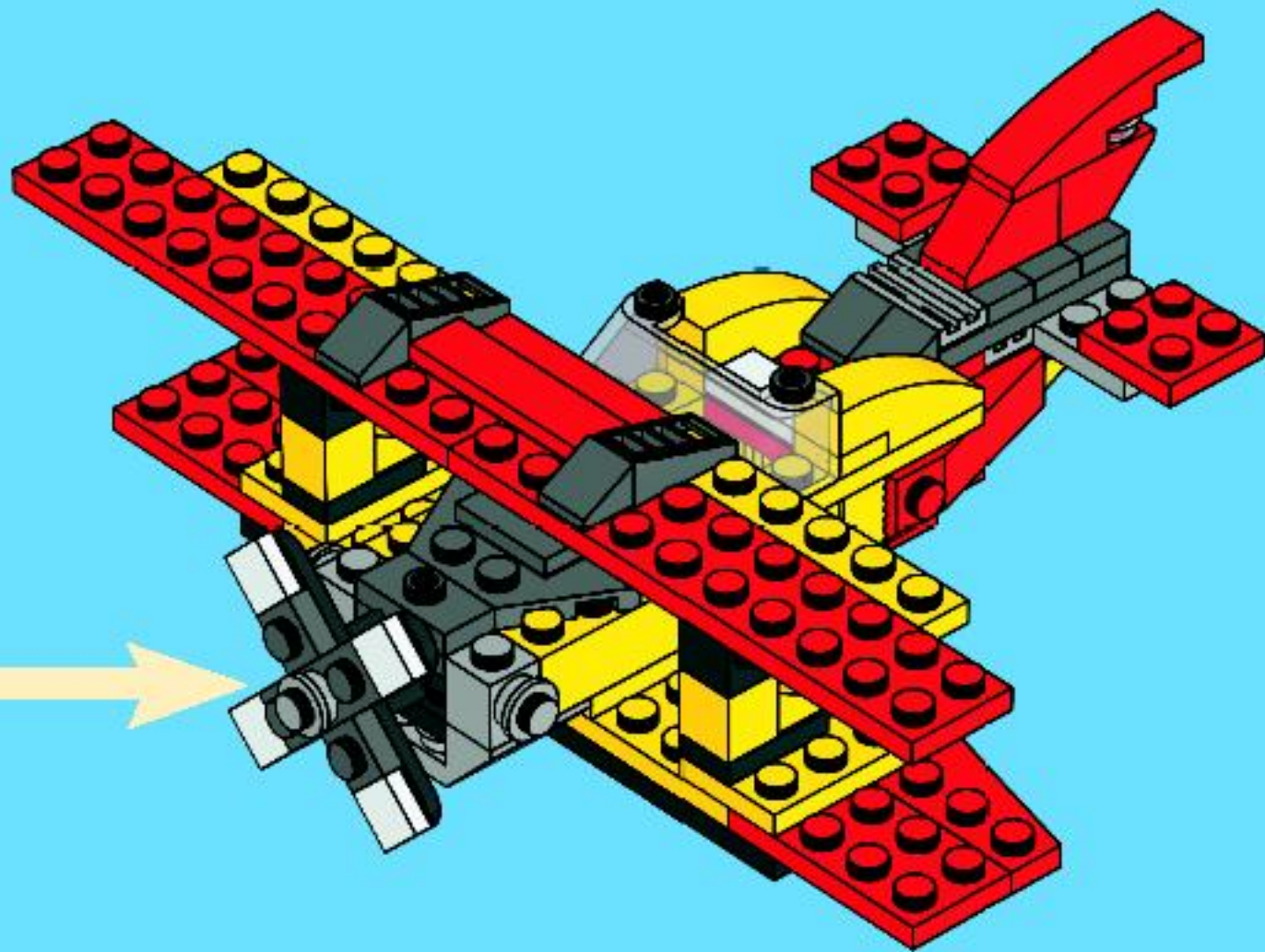
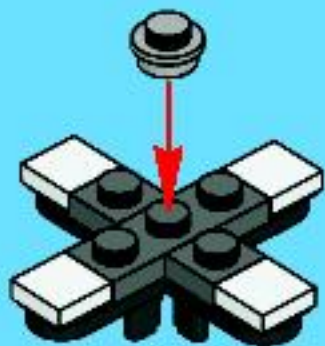

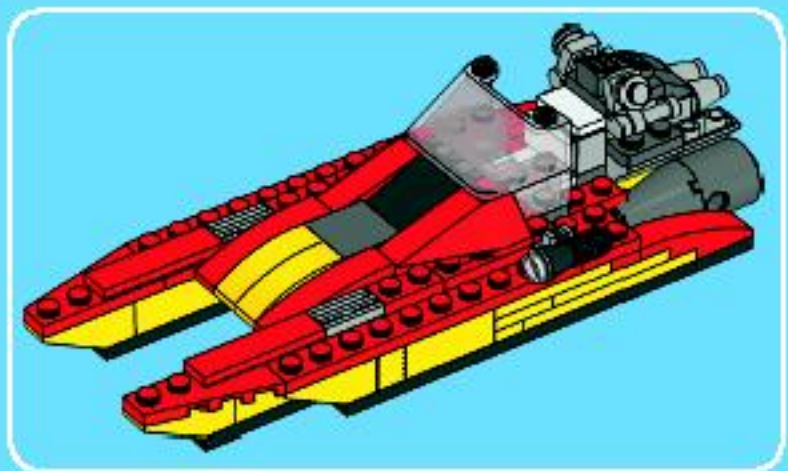

1

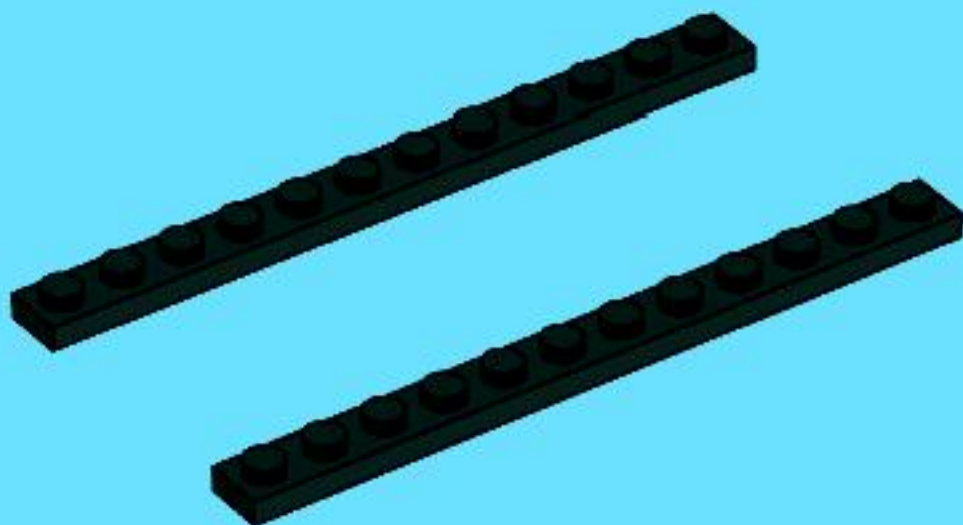



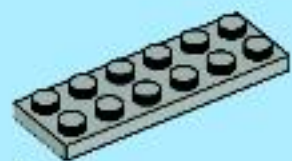

1x

2

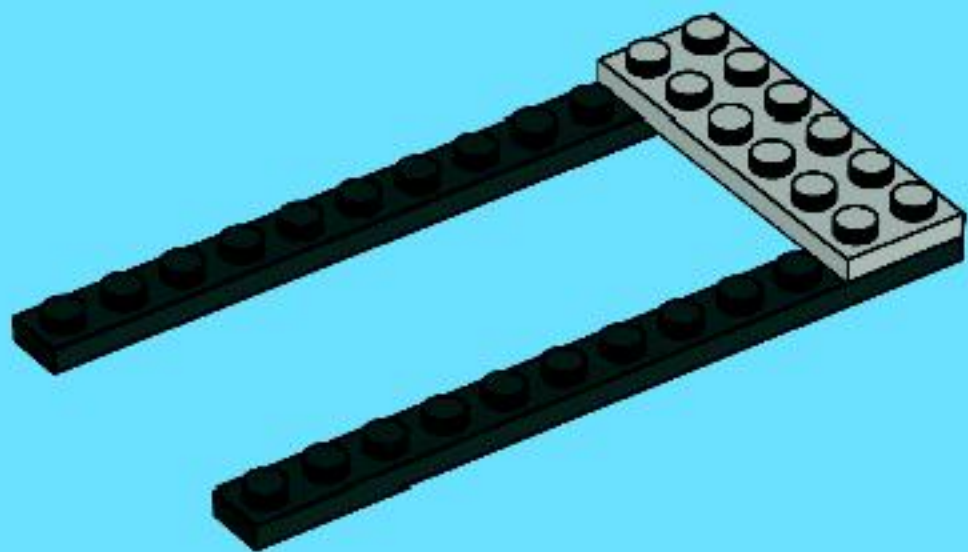

1x



2x

3

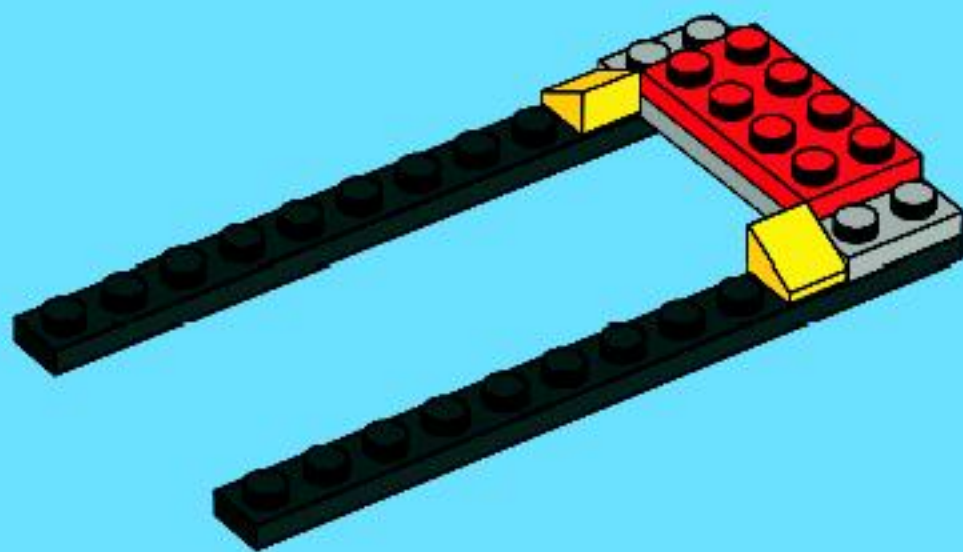



2x



2x

4

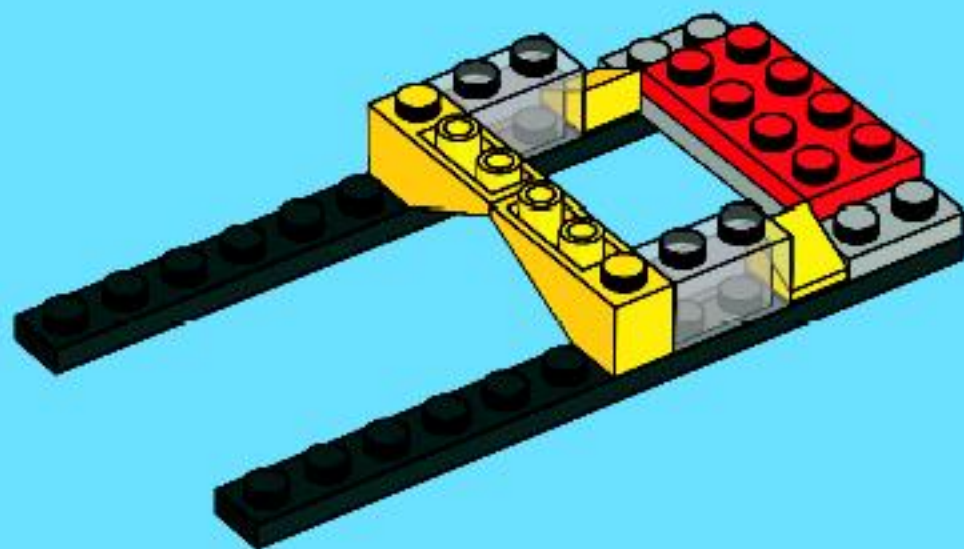



5

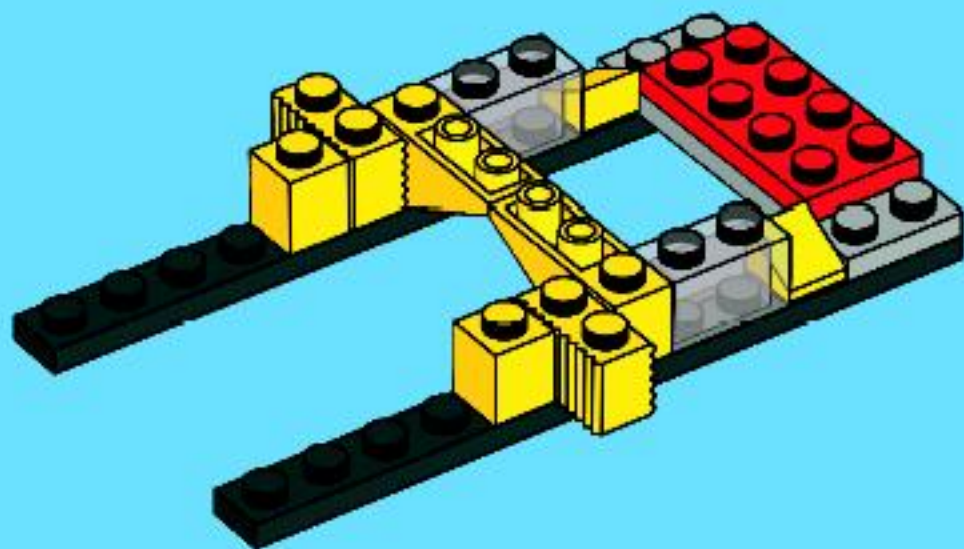

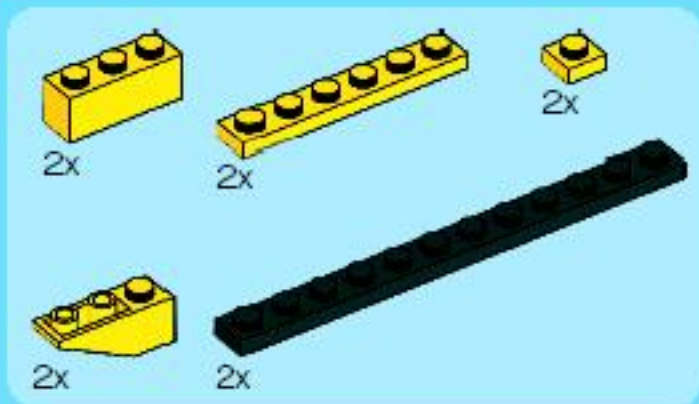

6

1

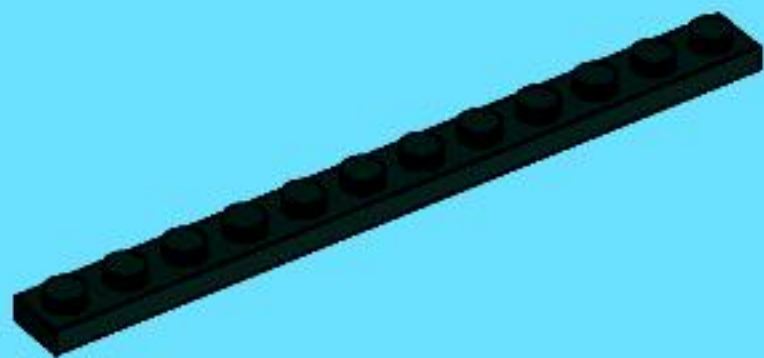

2

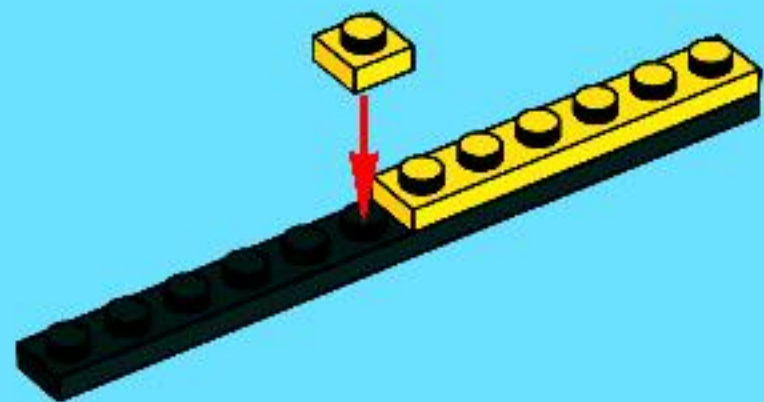

3

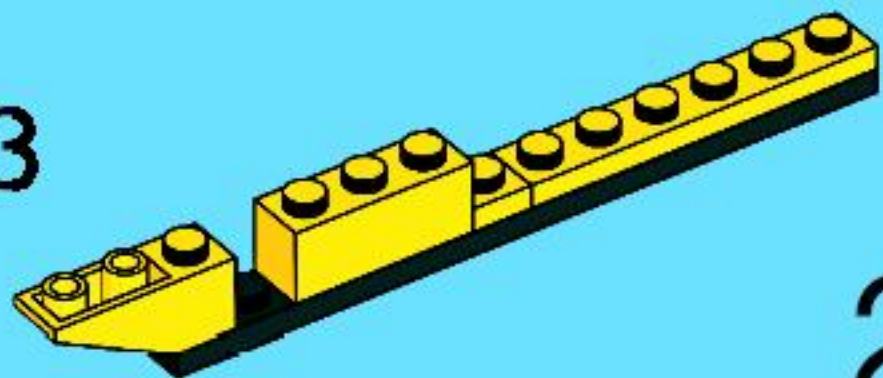

2x

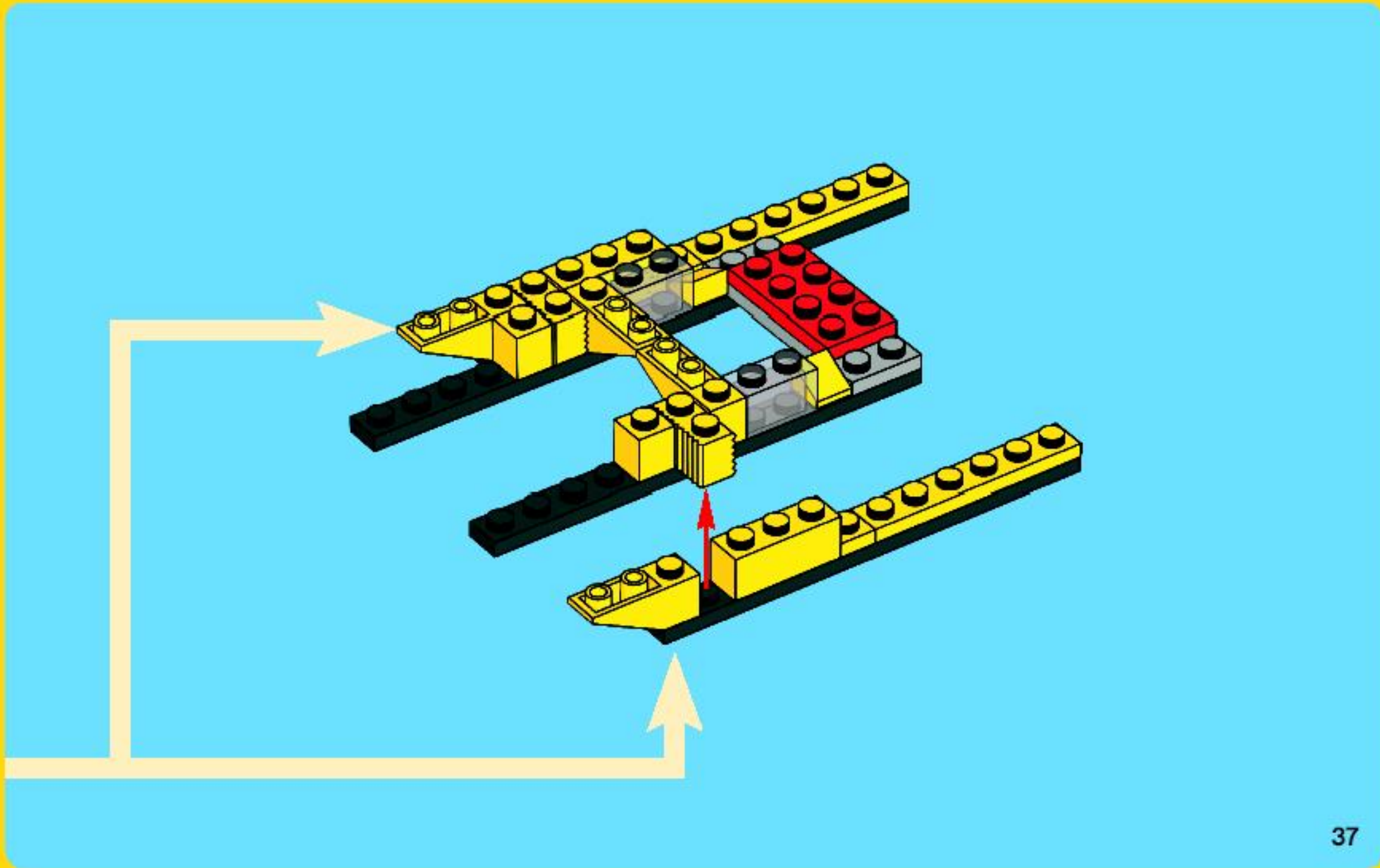



2x



2x

7

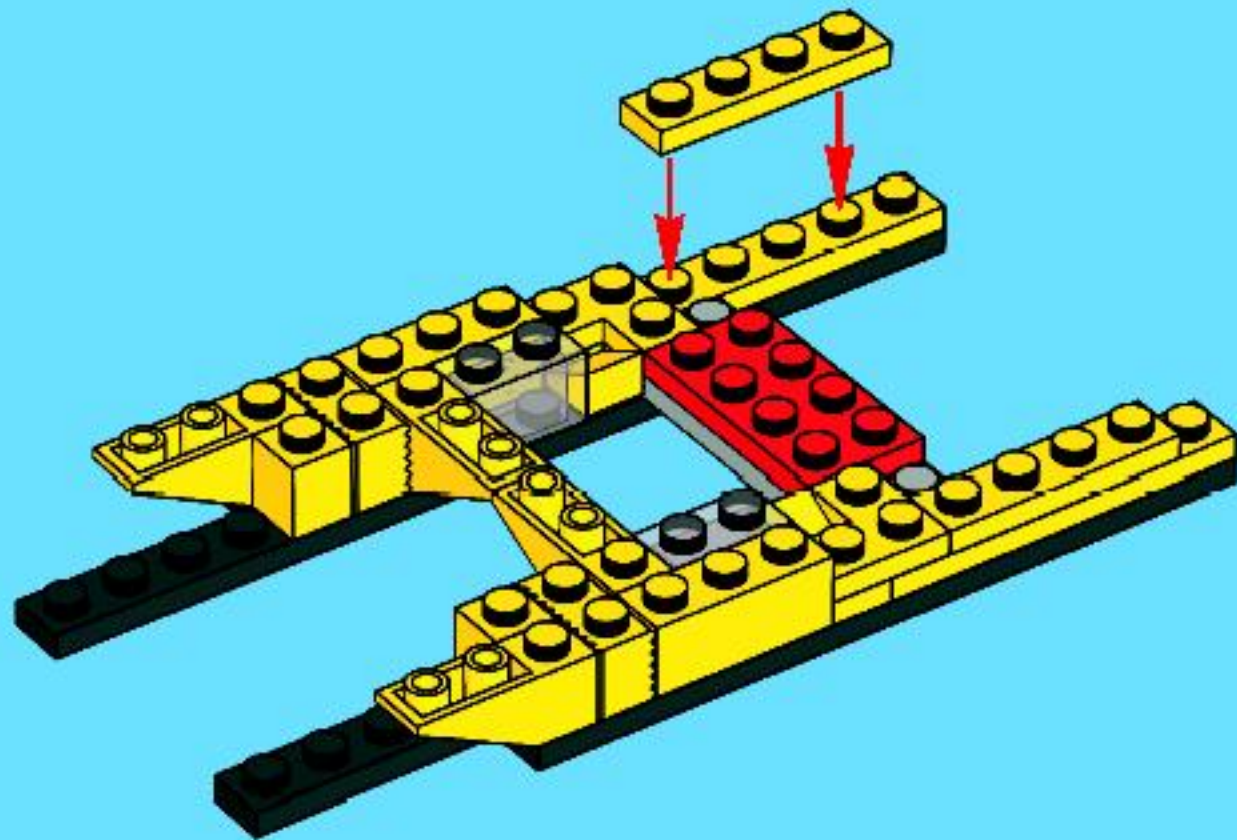



2x



2x

8

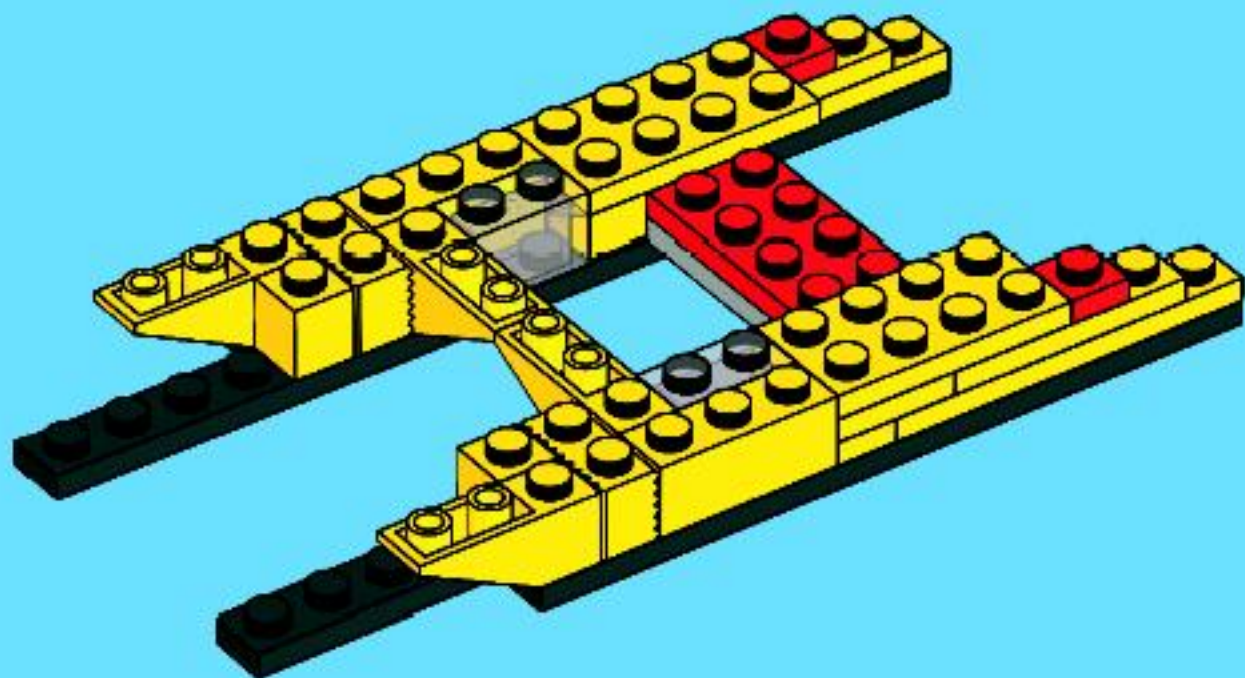



2x

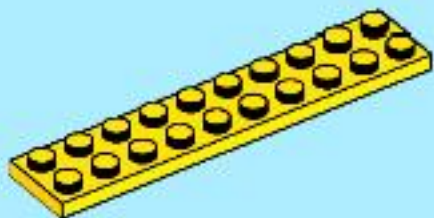

1x

9

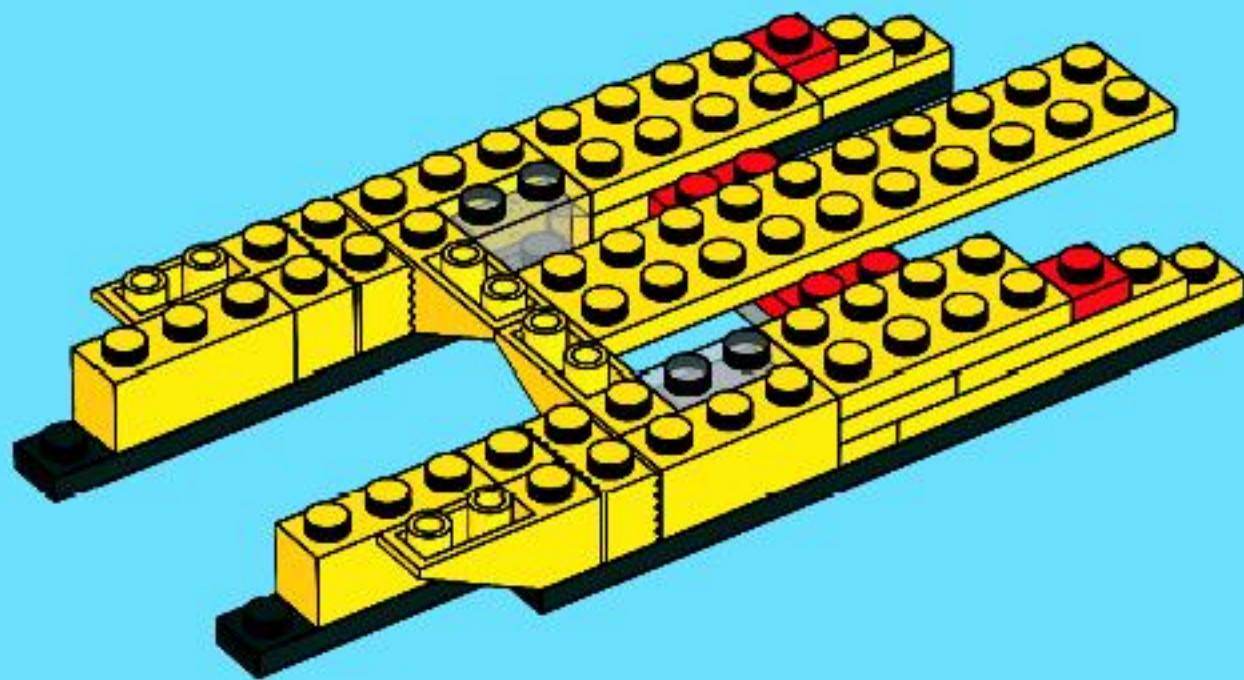





1x

10

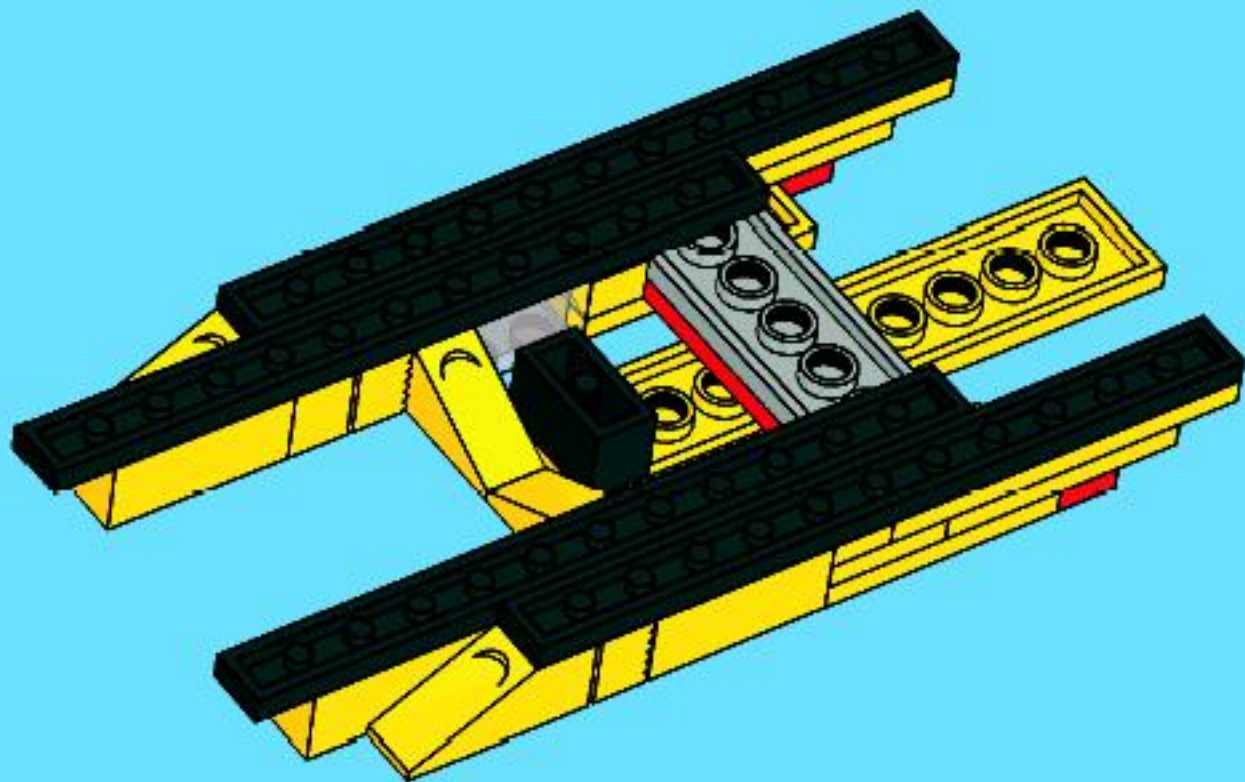



11

1

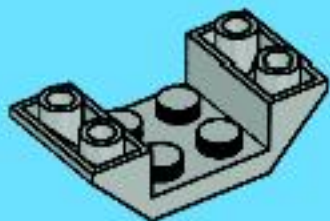

2

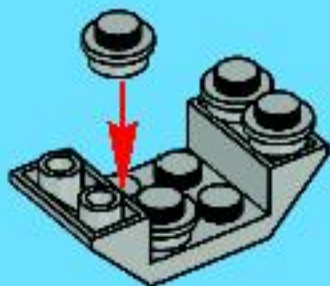

3

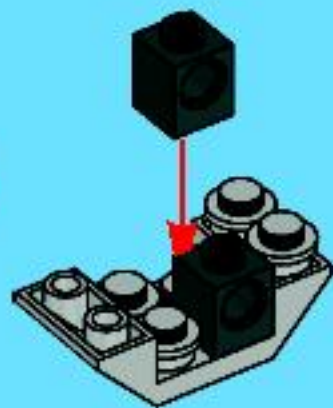

4

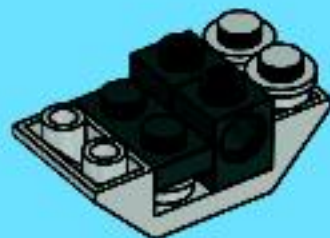

5



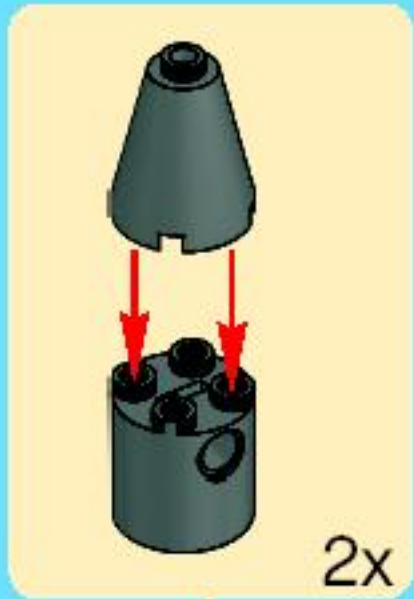

2x

6

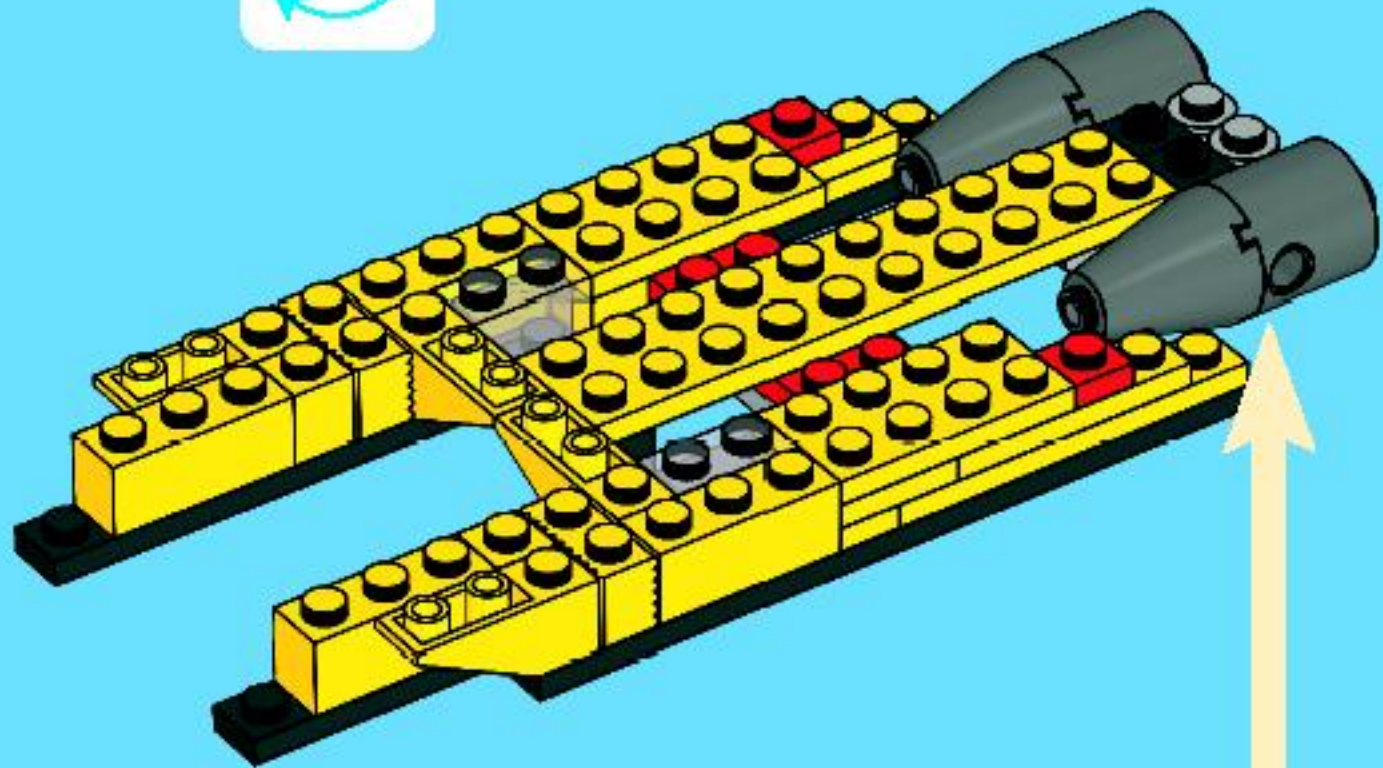
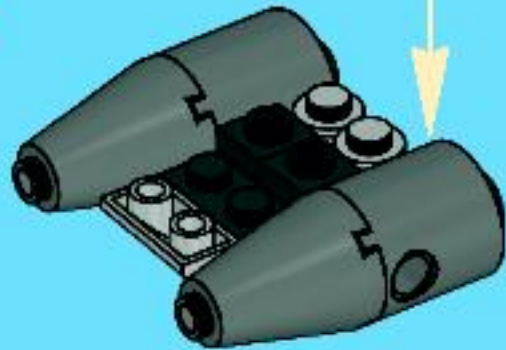

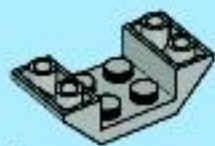

1x

12

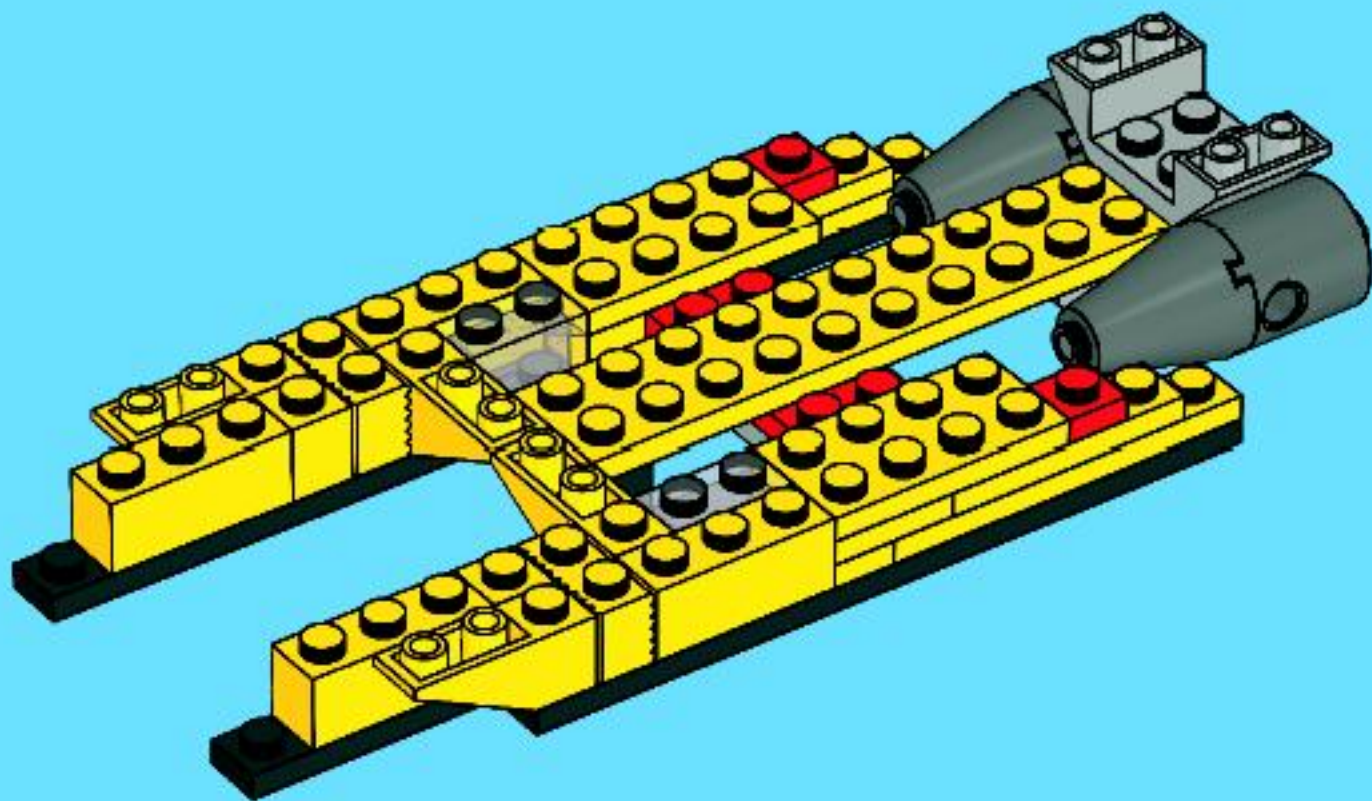



2x



2x



2x

13

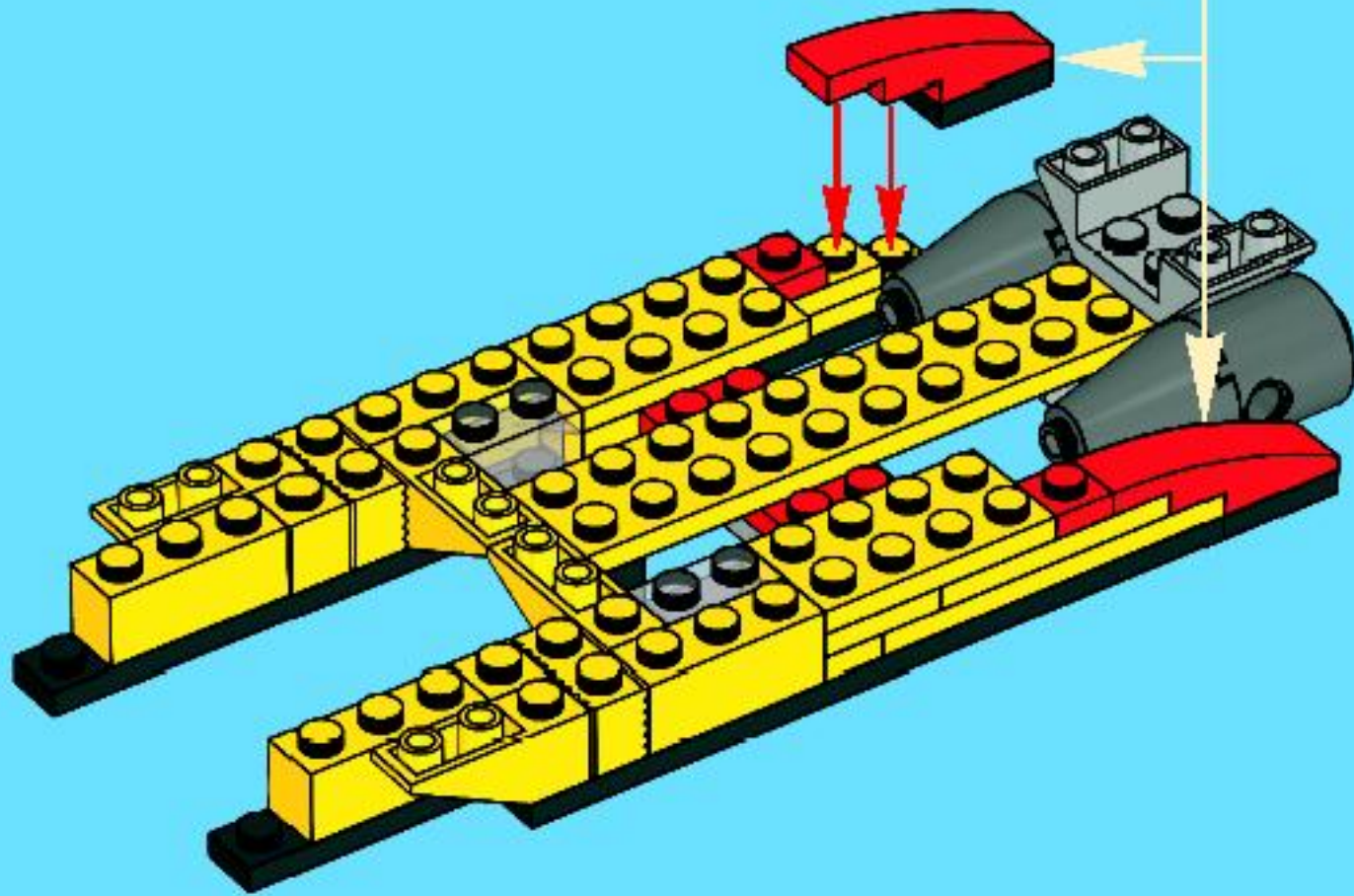

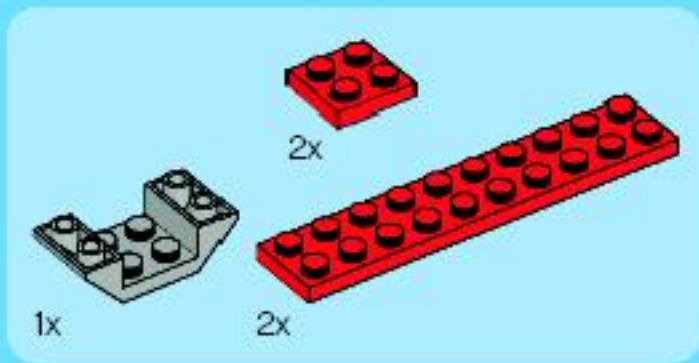

14

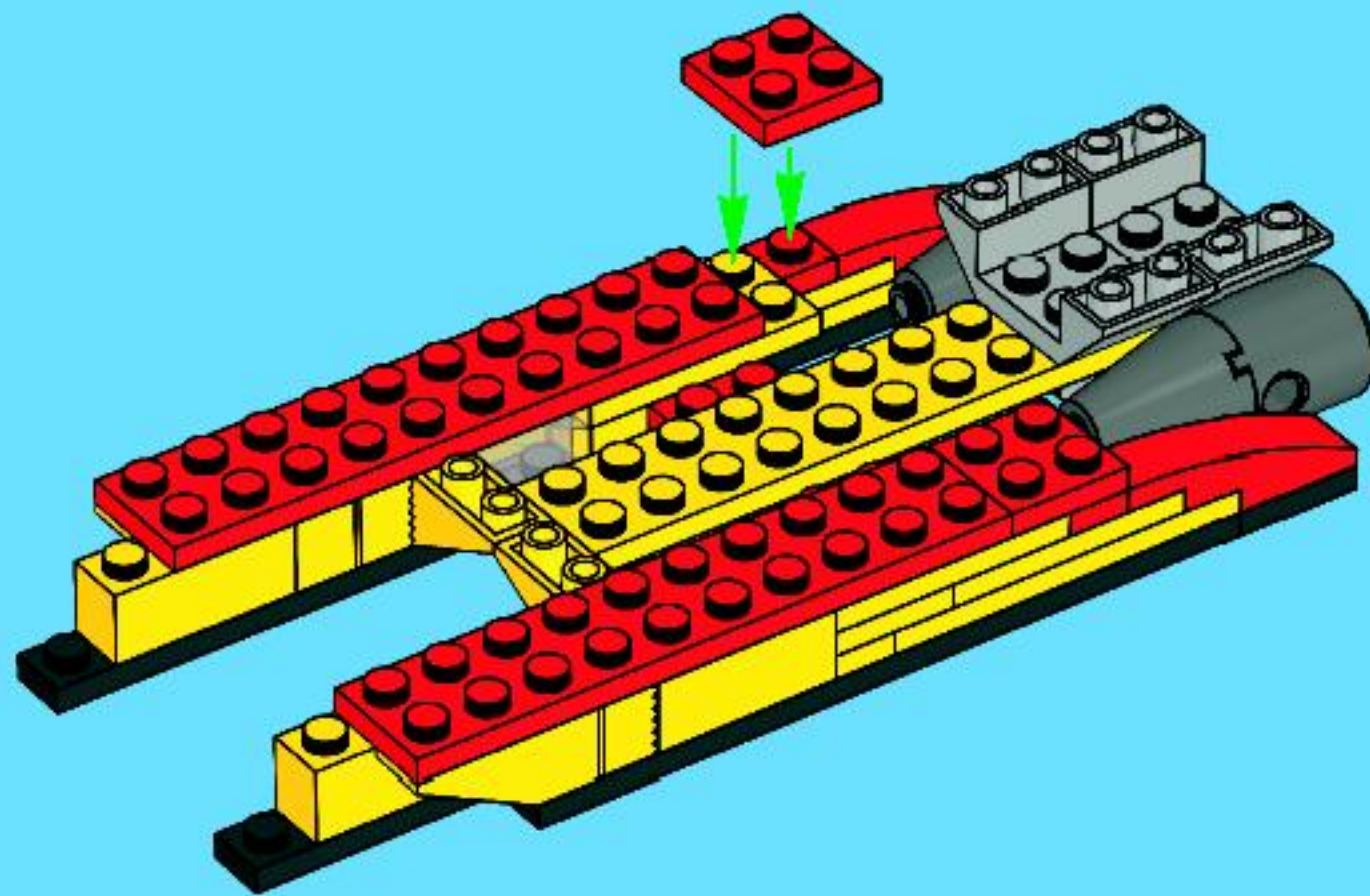

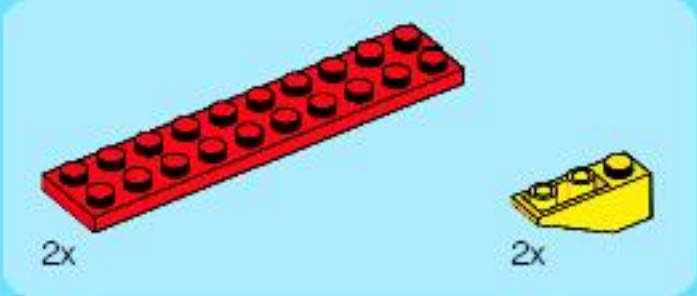

15

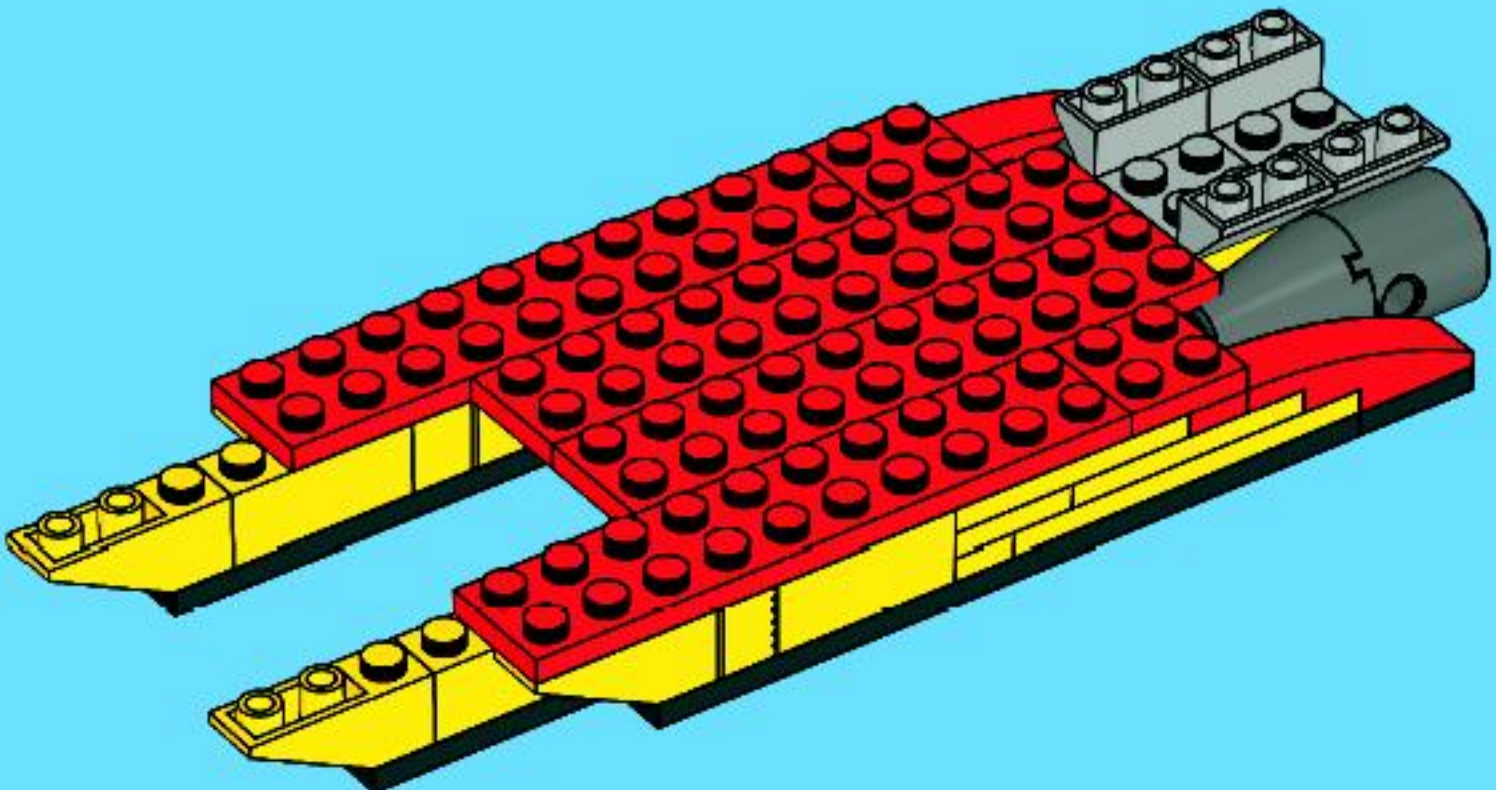

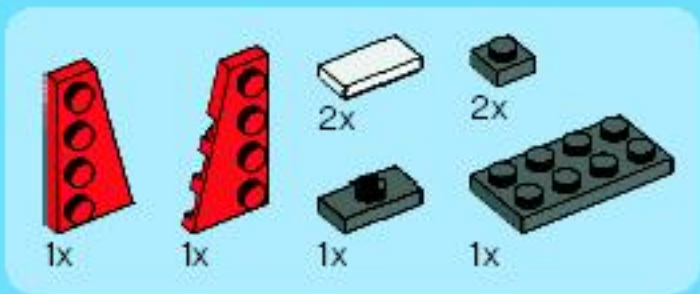

16

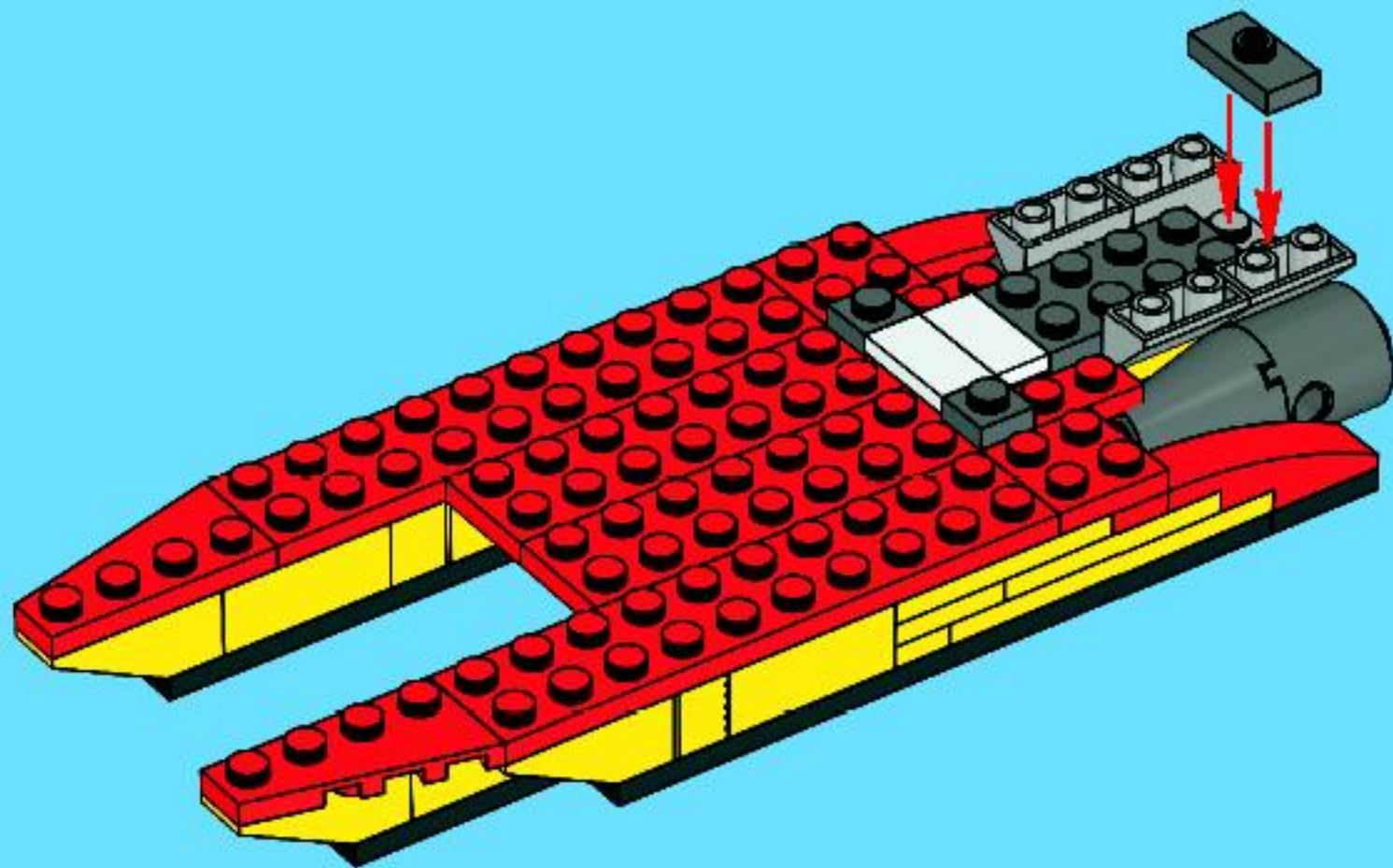





2x



1x



2x



2x



2x

1

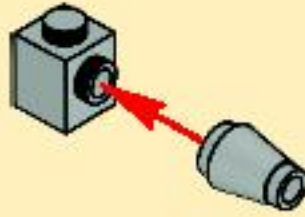

2

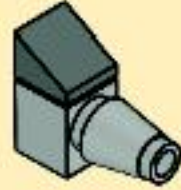

2x

17

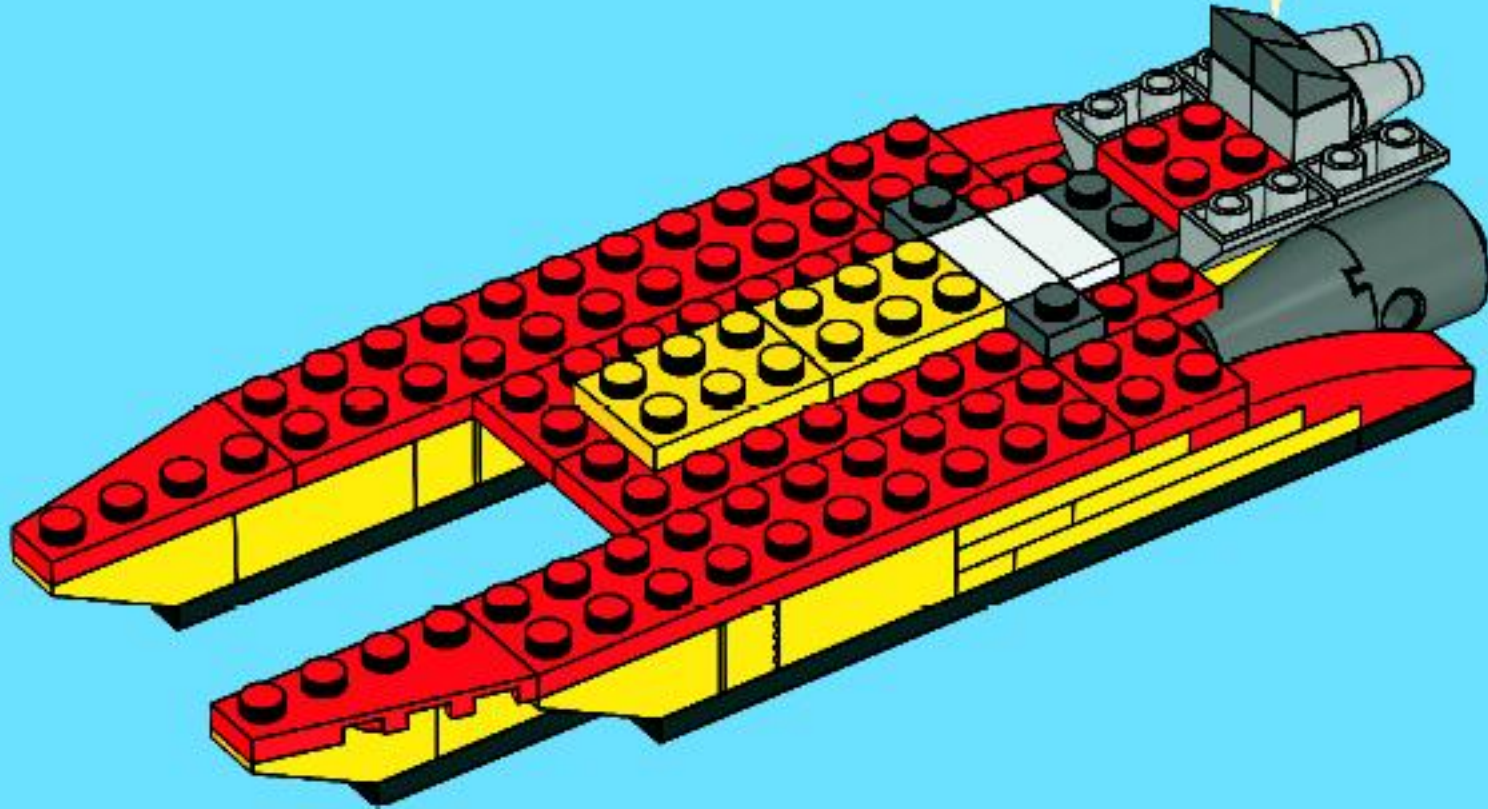

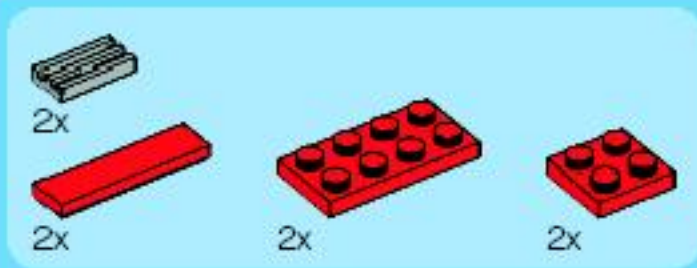

18

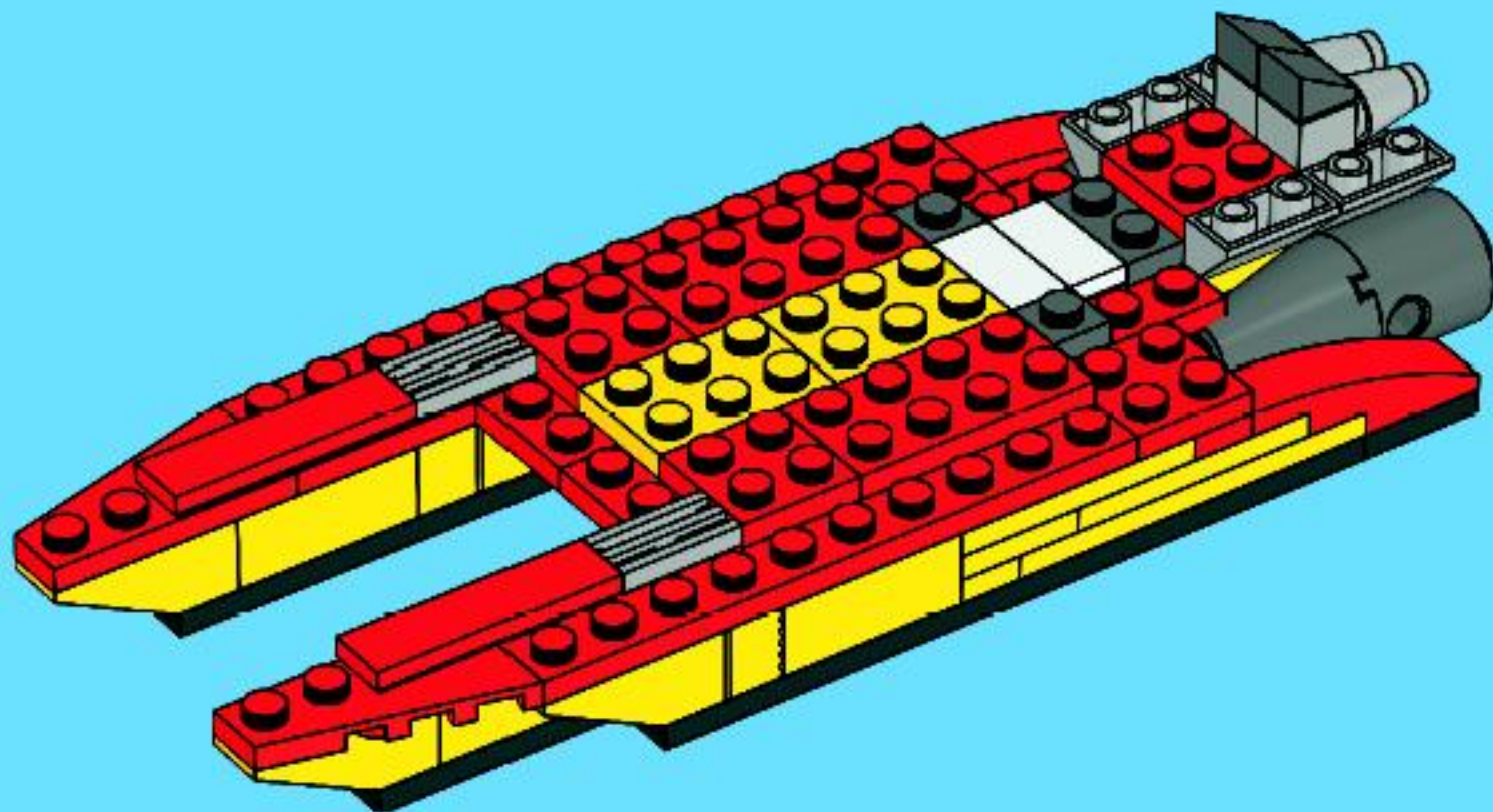

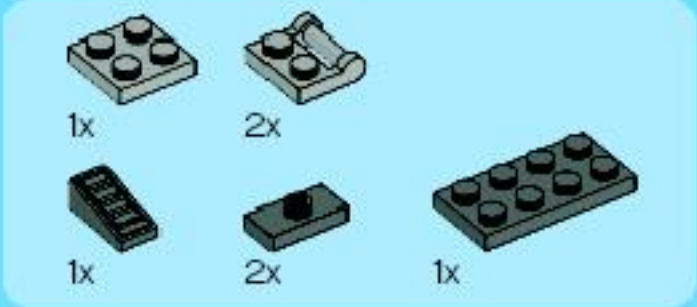

# 19

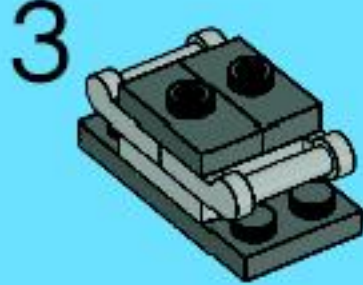
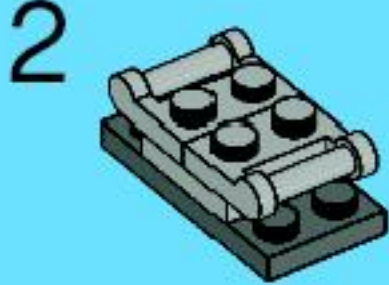

4

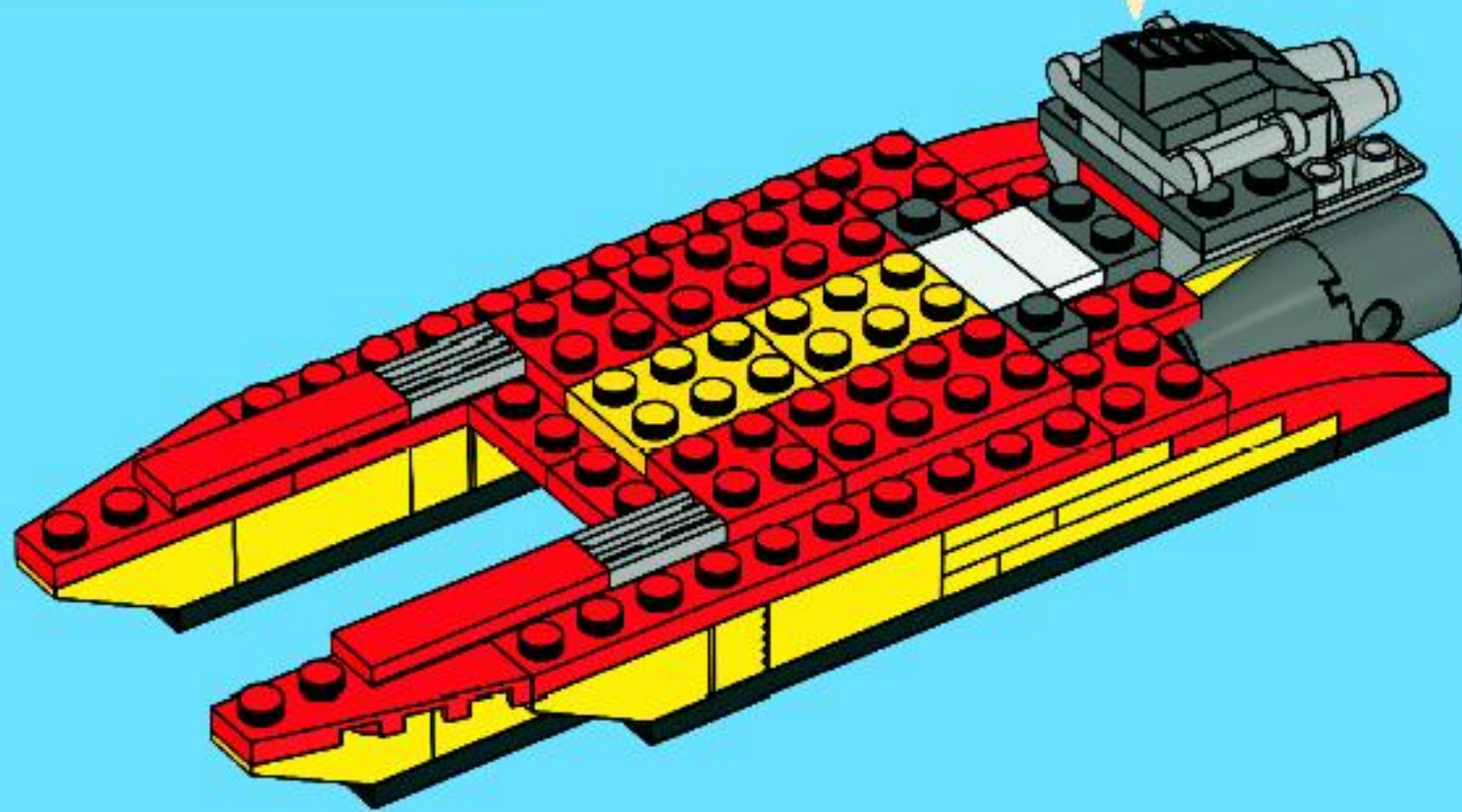
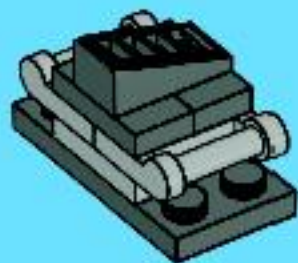



2x



1x

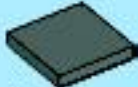

1x



2x

# 20

1

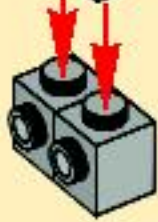

2

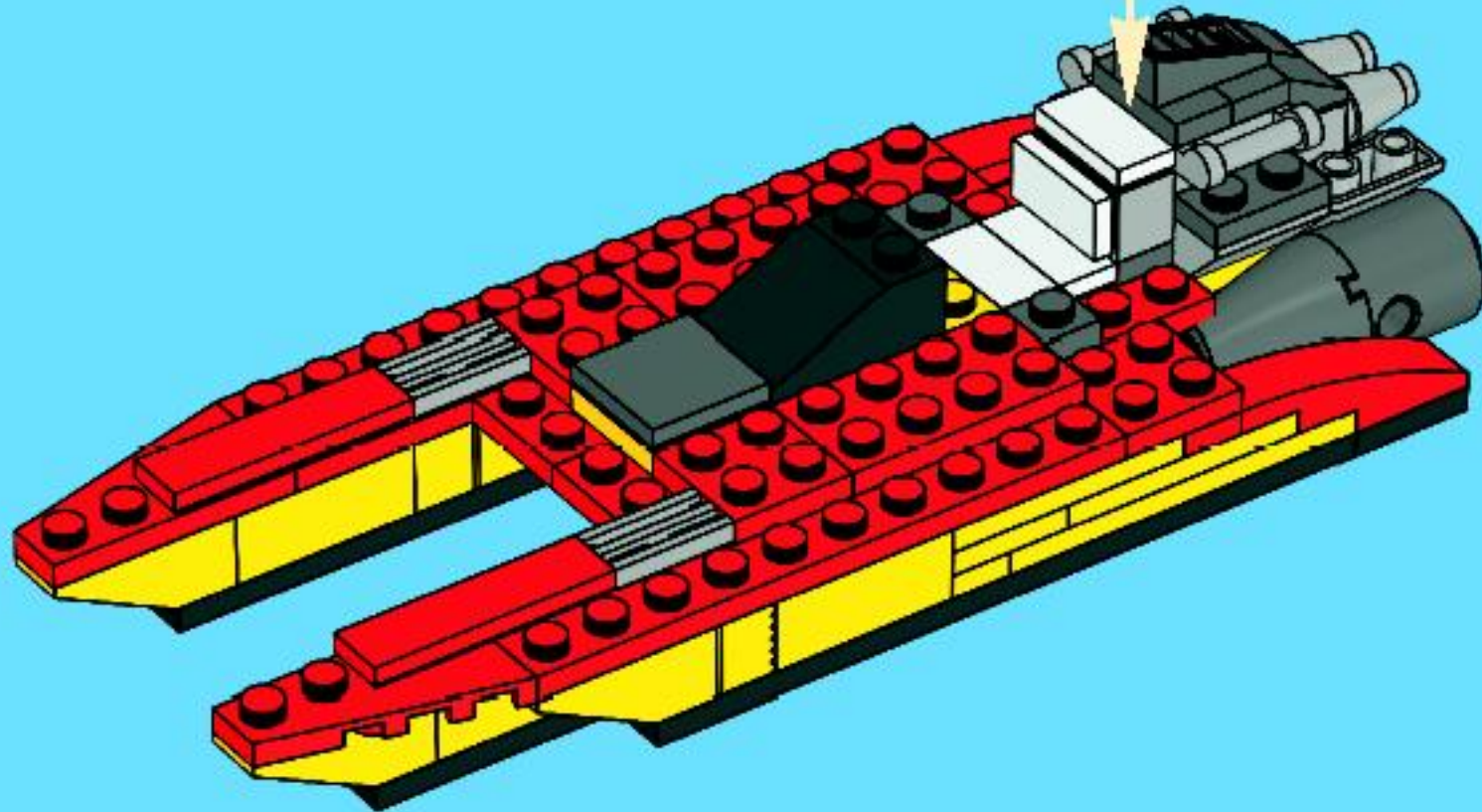
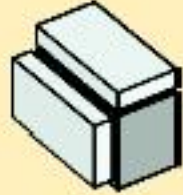



1x



2x



2x



2x

# 21

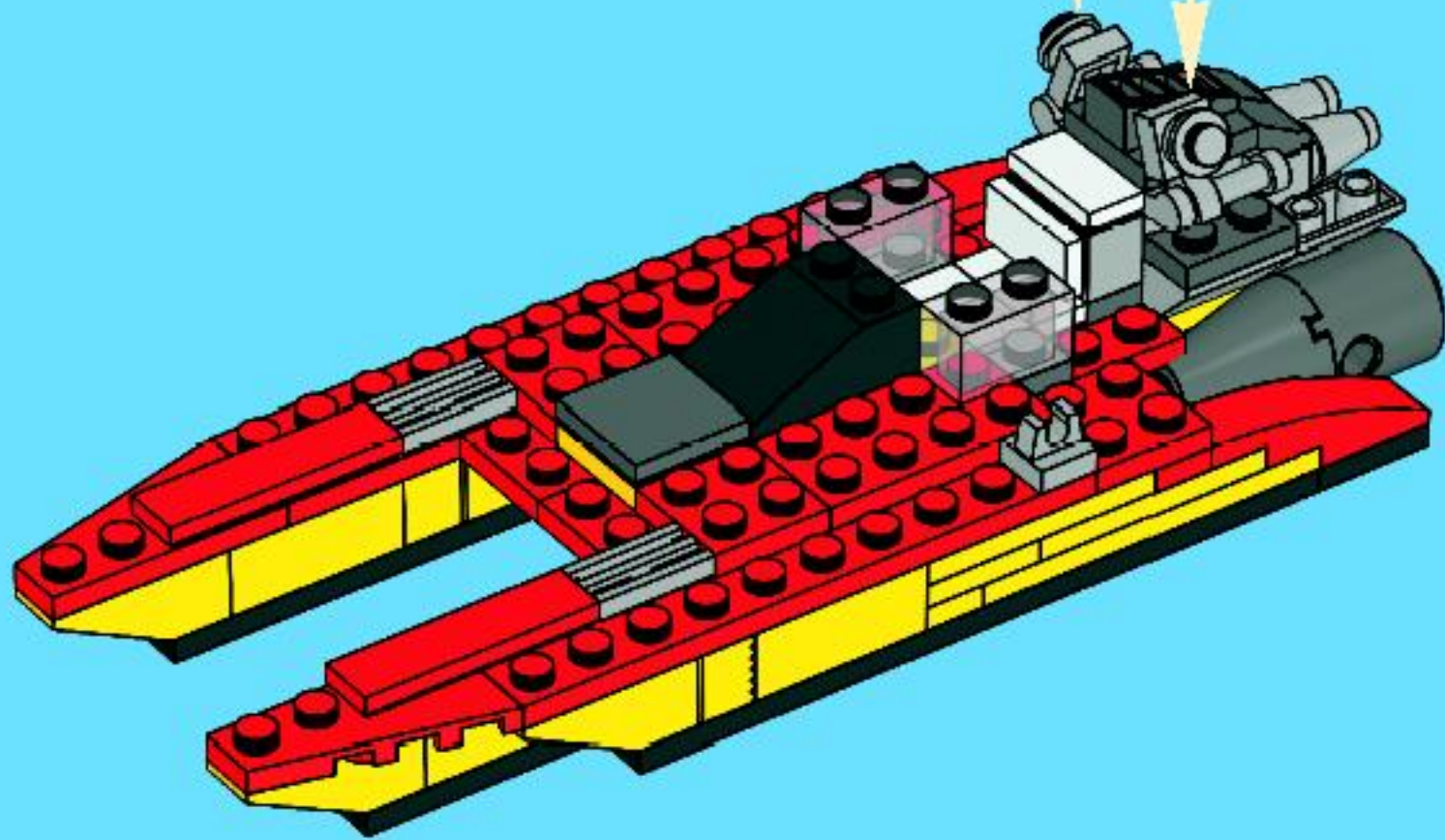
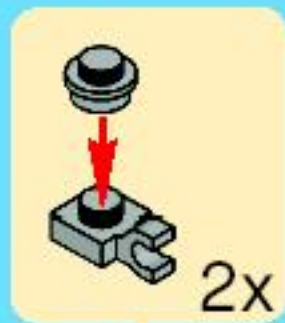



2x



2x



1x



1x

22

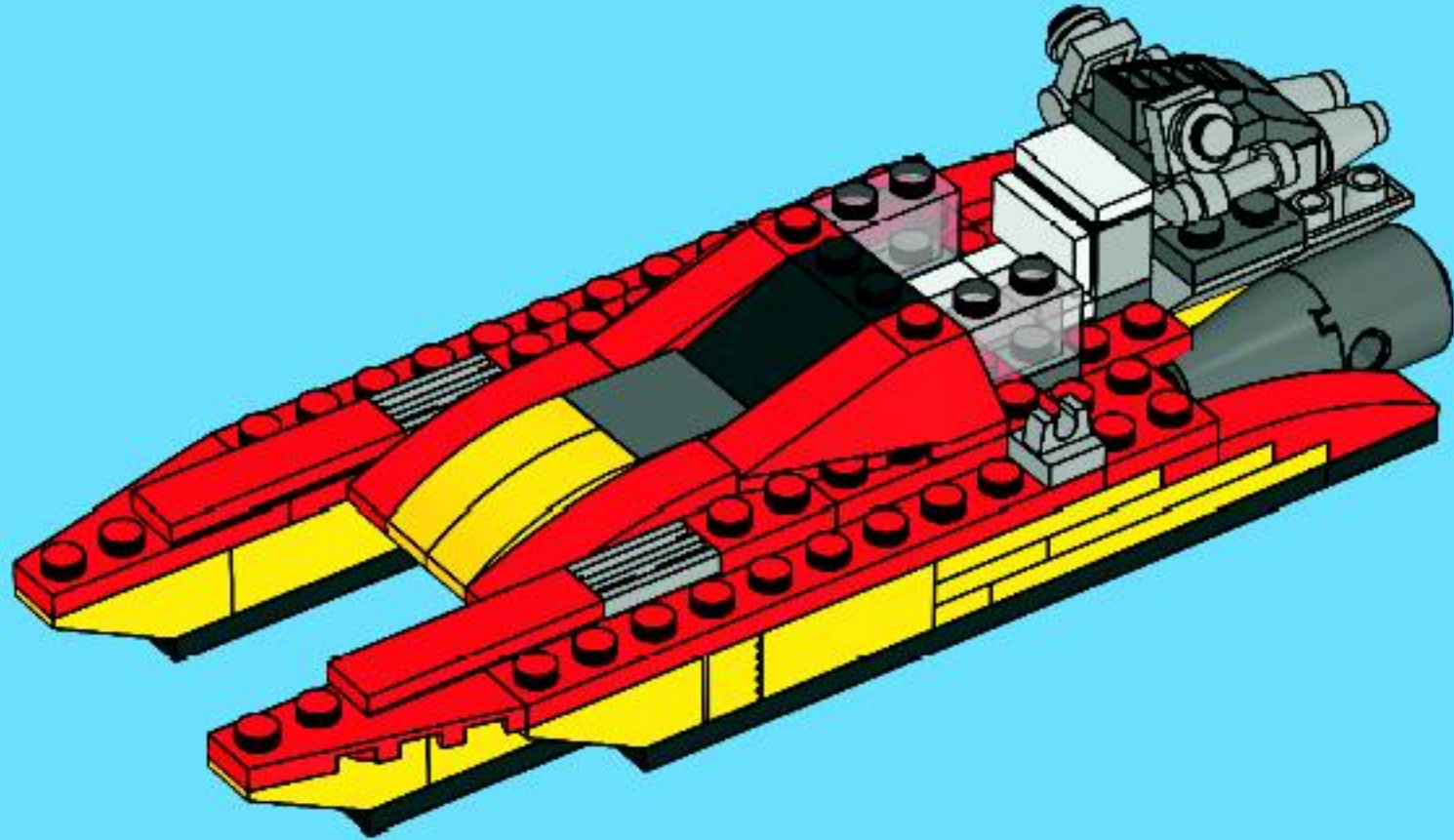



23

