



Mixels™

41548



DRIBBAL



 LEGO.com

6126533

1

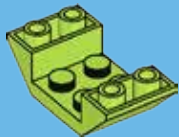

2

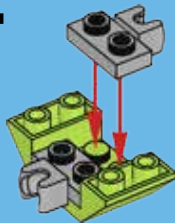

3

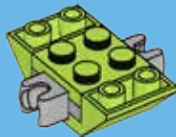

4

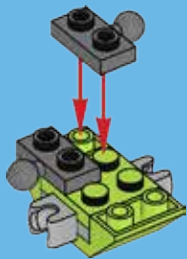

5

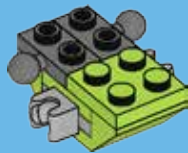

6



7

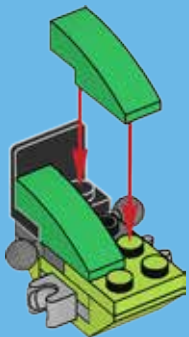

8



1

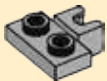

2

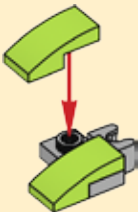

3



9

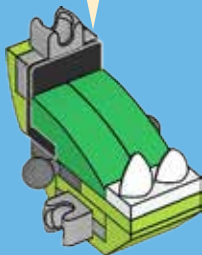

1

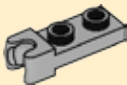

2

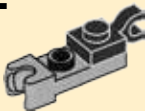

3

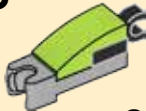

2x

10

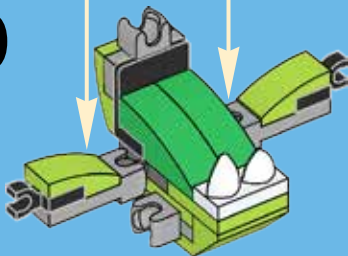

1



2

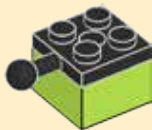

3



2x

11

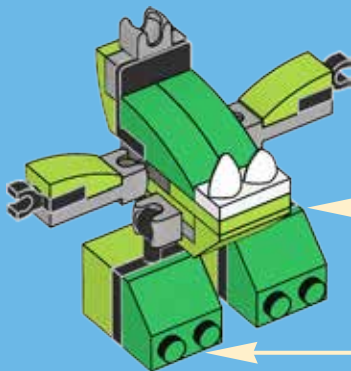



12

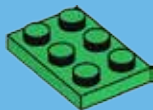

13



14

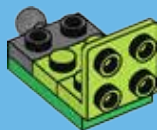

15

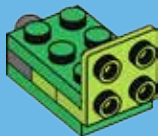

16

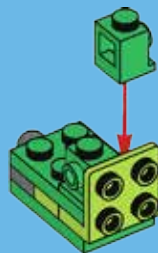

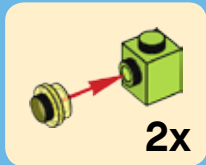

17

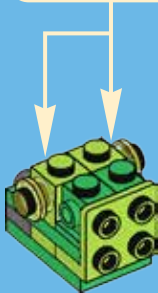

18

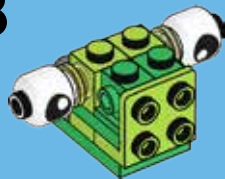



19



20

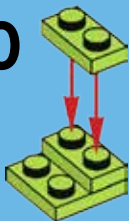

21



22

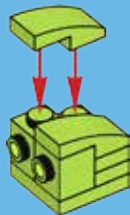

23

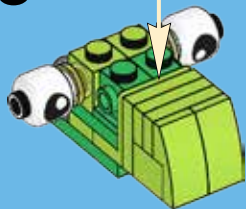

24

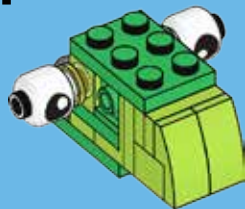

25

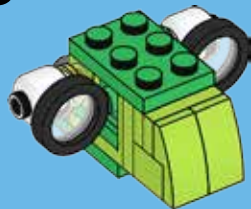

26

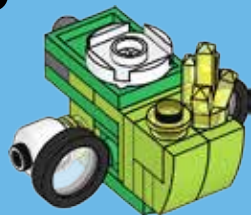

27



28

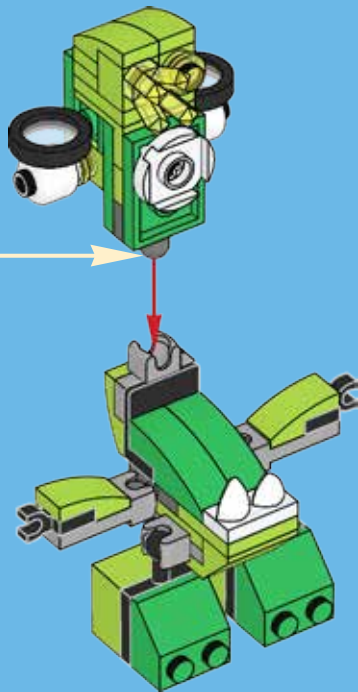

29

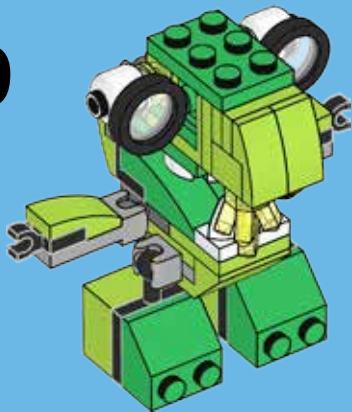



3x
6043656



4x
6073026



6x
6069006



1x
403201



2x
4187334



2x
6043639



2x
4220632



3x
4164037



2x
6060802



2x
303928



3x
6039479



1x
6110067



3x
4537937



1x
6046384



2x
6039946



3x
302128



Customer Service

Kundenservice

Service Consommateurs

Servicio Al Consumidor

LEGO.com/service or dial



00800 5346 5555 :



1-800-422-5346 :



1x
6094031



2x
4517925



1x
6000650



2x
6051038



2x
6012466



3x
3005749



1x
4540417



**DRIBBAL
41548**



**GLORP CORP
MAX!**



**GURGGLE
41549**



**SLUSHO
41550**



LEGO.com/mixels





Mixels™

SERIES
6



41545
KRAMM



41546
FORX



41547
WUZZO



41548
DRIBBAL



41549
GURGGLE



41550
SLUSHO



41551
SNAX



41552
BERP



41553
VAKA-WAKA



LEGO.com/mixels



Mixels RUSH



**YOU CAN
BUY THE
GAME!**

D R O O 1 D R A W 1

IN GAME CODE!



Apple, the Apple logo, iPad, iPhone and iPod touch are trademarks of Apple Inc., registered in the U.S. and other countries. App Store is a service mark of Apple Inc. Google Play is a trademark of Google Inc.