





[LEGO.com/sustainable-packaging](https://LEGO.com/sustainable-packaging)



# LEGO® VIP

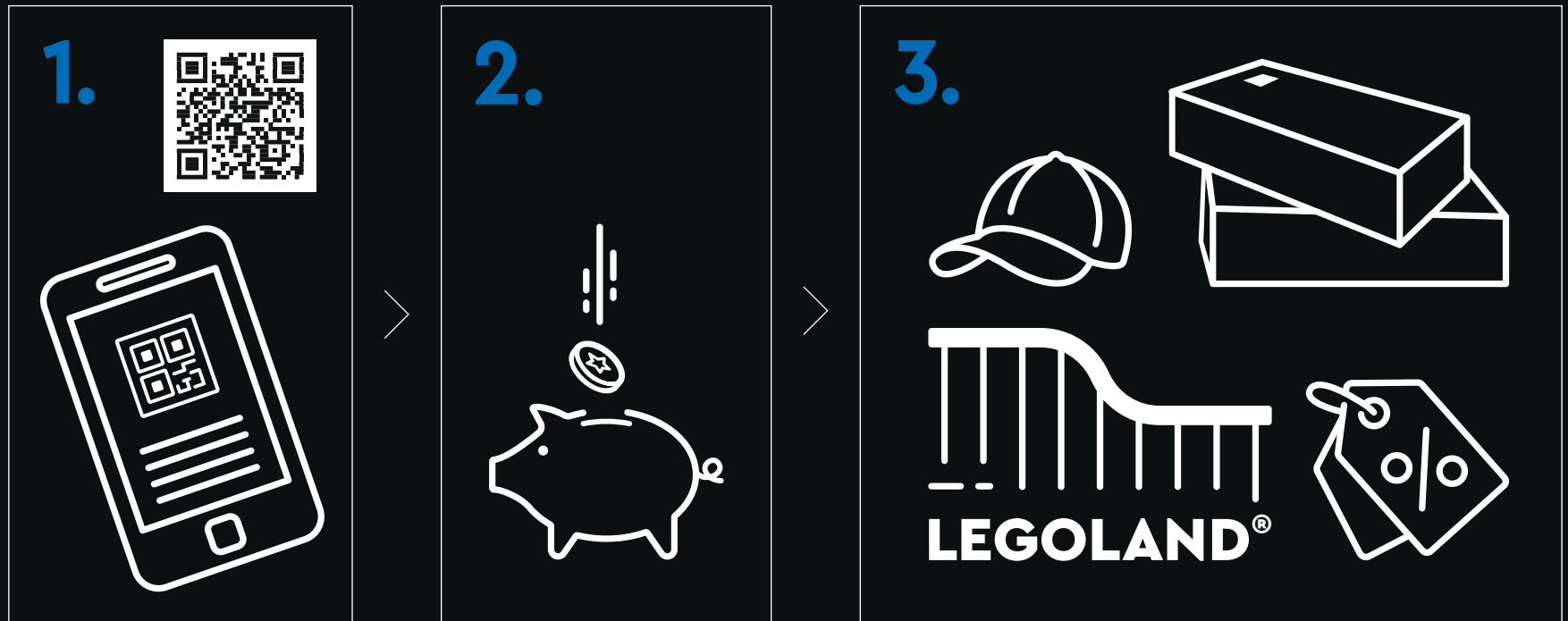

**1.** Sign up **2.** Earn points for purchases **3.** Redeem points for rewards, experiences, discounts & more | **1.** Melde dich an **2.** Sammle Punkte bei jedem Kauf **3.** Löse die Punkte für Belohnungen, Erlebnisse, Rabatte und Ähnliches ein | **1.** Inscrivez-vous **2.** Gagnez des points lors de vos achats **3.** Échangez vos points contre des récompenses, des expériences, des remises et bien plus encore | **1.** Iscriviti **2.** Guadagna punti con i tuoi acquisti **3.** Riscatta punti per premi, esperienze, sconti e altro ancora | **1.** Regístrate **2.** Gana puntos por tus compras **3.** Canjea puntos por recompensas, experiencias, descuentos y mucho más | **1.** Registe-se **2.** Ganhe pontos em compras **3.** Troque os pontos para prémios, experiências, descontos e muito mais | **1.** 注册 **2.** 购物赚积分 **3.** 用积分兑换奖励、体验、折扣等 | **1.** Zarejestruj się **2.** Zdobywaj punkty za zakupy **3.** Wymieniaj punkty na rabaty, przygody i inne nagrody | **1.** Zaregistrujte se **2.** Sbírejte body za nákupy **3.** Vyměňujte body za odměny, zážitky, slevy a spoustu dalšího | **1.** Zaregistrujte se **2.** Získavajte body za nákupy **3.** Uplatnite si body a získajte odmeny, rôzne zážitky, zľavy a ešte viac | **1.** Regisztrálj **2.** Szerezz pontokat minden vásárlással **3.** Váltsd be pontjaidat jutalmakra, élményekre, kedvezményekre és egyebekre | **1.** Înscric-te **2.** Câștigă puncte pentru achiziții **3.** Valorifică puncte pentru recompense, experiențe, reduceri și multe altele | **1.** Регистрируйте се **2.** Получайте точки за покупки **3.** Используйте точки за награды, услуги, отстъпки и т.н. | **1.** Reģistrējies **2.** Pelni punktus par pirkumiem **3.** Izmanto punktus, lai saņemtu balvas, izklaides iespējas, atlaides un daudz ko citu | **1.** Registreeru **2.** Teeni ostude eest punkte **3.** Lunasta punktide eest preemiad, elamused, allahindlused ja muu | **1.** Užsiregistruokite **2.** Pelnykite taškų už pirkinius **3.** Panaudokite taškus atlygiui, funkcijoms, nuolaidoms ir ne tik





**INCONTRIAMO  
IL FAN DESIGNER**



E

Il regista e sceneggiatore francese Thomas Lajon (nome LEGO® Ideas LEt.sGO) ha ricevuto il suo primo set LEGO all'età di quattro anni e gli piace ancora costruire. Oggi condivide la sua passione (e i mattoncini) LEGO con le persone che ama di più.

“Sono sempre stato un grande appassionato di locomotive e, se potessi viaggiare indietro nel tempo (e potessi permettermi il biglietto), prenderei sicuramente l'*Orient Express*! È quasi come se provenisse da un altro mondo e questo è un particolare che adoro. Questo sontuoso treno ha trasportato i passeggeri in tutta Europa in carrozze di lusso per quasi un secolo ed è ancora oggetto di molte storie e leggende. E personalmente, poiché vengo dal mondo delle sceneggiature e dal cinema, l'*Orient Express* ispira racconti d'avventura e mi invita a viaggiare. L'*Orient Express* è il

treno dei sogni con le sue magnifiche carrozze realizzate da grandi artigiani e designer. Ha un'aria di inaccessibilità che alimenta le nostre fantasie. È al centro di storie favolose, letteratura, canzoni e film.

Questo modello è il mio primissimo progetto LEGO Ideas e ha richiesto ore, giorni e notti di preparazione, progettazione e pazienza! Ho costruito il mio modello studiando le immagini della locomotiva Pacific 231 K 8 e centinaia di foto sia degli esterni sia degli interni delle carrozze. Il set finale è molto bello e il team di designer LEGO ha fatto un lavoro fantastico dando vita a questo mio sogno. Il mio dettaglio preferito è lo specchio convesso che riflette l'interno del vagone letto. Per me, è la ciliegina sulla torta. E desidero ringraziare ciascuno dei 10.000 sostenitori di LEGO Ideas che hanno reso questo momento di felicità una realtà!”



Il modello originale di Thomas

# POSARE I BINARI VERSO UN NUOVO MONDO



Durante la Rivoluzione Industriale, i treni e le ferrovie divennero un simbolo del progresso tecnologico e del potere politico. Migliaia di chilometri di nuovi binari furono posati tra le regioni, trascendendo i confini e portando con sé una nuova vita. Le nuove ferrovie facilitarono il trasporto delle merci, creando nuovi posti di lavoro e generando crescita economica e nuove opportunità di viaggio esotiche per milioni di persone in tutto il mondo. Il trasporto internazionale di passeggeri era ancora agli

albori, con un coordinamento e un'efficienza limitati a livello transfrontaliero. Con le tensioni politiche che attanagliavano l'intera Europa, lo status di neutralità del Belgio avrebbe giocato un ruolo importante nel gettare le basi per il progresso globale, in quanto la nazione riuscì a stabilire collegamenti ferroviari strategicamente importanti verso e attraverso gran parte del continente e delle colonie.



# UNA SVOLTA DIPLOMATICA

- Nel 1876, il visionario ingegnere e imprenditore belga Georges Nagelmackers istituì la Compagnie Internationale des Wagons-Lits (CIWL). Aveva compreso il potenziale insito nei viaggi di lusso per le classi sociali più abbienti. Ispirandosi ai vagoni ristorante e ai vagoni letto che si stavano diffondendo negli Stati Uniti, fondò la prima catena di treni di lusso che avrebbe poi conquistato tutto il mondo. Grazie a lunghe trattative diplomatiche e, indubbiamente, a una perseveranza e a un ottimismo senza eguali, Nagelmackers ottenne i permessi e i contratti necessari con gli stati vicini per consentire ai suoi treni di attraversare senza ostacoli tutta l'Europa, da Parigi a Costantinopoli. La progettazione, la costruzione e la manutenzione trasudavano qualità, perfezione e innovazione, grazie anche alla supervisione di uomini e di donne di gran talento di tutto il mondo. E soprattutto, i nuovi treni portarono tanti affascinanti e romantici orizzonti più vicini a noi, dando vita a sogni inediti e aprendo le porte a mondi sconosciuti.



E



# PORTA D'ACCESSO VERSO L'AVVENTURA

- La capitale dell'Impero Ottomano era diventata una nuova e popolare destinazione e fonte di ispirazione per artisti e scrittori europei, in quanto vera porta d'accesso al mistero e al fascino dell'Estremo Oriente. Primo treno transcontinentale europeo, l'*Orient Express* mantenne la sua promessa originale: quella di offrire viaggi avventurosi in terre lontane. Il treno stesso era una pubblicità itinerante per la nuova società di Nagelmackers, e le campagne pubblicitarie erano caratterizzate da manifesti colorati, cartoline e oggetti da collezione. Queste pubblicità includevano spesso immagini di monumenti e simboli ottomani, composizioni color sabbia o modelli che indossavano abiti di ispirazione egizia o araba. La rivista ufficiale della compagnia, *Wagons-Lits*, promuoveva sia i servizi sia gli itinerari e gli articoli di intrattenimento, ma conteneva anche fotografie di celebrità immerse nel lusso più sfrenato: dalle squisite carrozze ristorante e carrozze letto ai facchini e ai conduttori vestiti in modo impeccabile, perpetuando il fascino, il mito e l'esclusività dell'*Orient Express*.

S



# SE QUESTE CARROZZE POTESSERO PARLARE...



Dopo il successo del viaggio inaugurale dell'*Orient Express* nell'ottobre 1883, la CIWL aggiunse continuamente nuove rotte ai suoi servizi nei decenni successivi e fino al XX secolo. Come Nagelmackers aveva previsto, le persone erano attratte dalla qualità, dal lusso e dalla promessa di avventura. Ma la svolta decisiva per l'*Orient Express* avvenne nel 1934. L'uscita del romanzo bestseller di Agatha

Christie *Assassinio sull'Orient Express* proiettò il treno sotto le affascinanti e misteriose luci della ribalta, trasformandolo in un fenomeno culturale del XX secolo. Era nata una leggenda moderna. Anche a distanza di quattro decenni, il primo adattamento cinematografico continua a catturare l'immaginazione di nuovi pubblici.

N

# L'ORIENT EXPRESS IN TEMPI MUTEVOLI

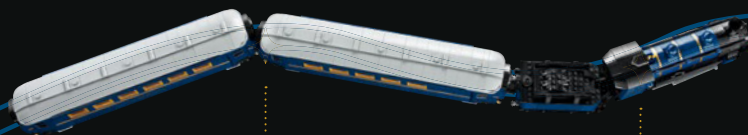

1867

In visita negli Stati Uniti, Georges Nagelmackers scopre i moderni vagoni ristorante e i vagoni letto e ne intuisce il potenziale per ridefinire il mondo dei viaggi.

1883

Il 4 ottobre l'*Orient Express* intraprende il suo viaggio inaugurale: partenza da Parigi con Costantinopoli come meta, e ritorno il 16 ottobre. Due dozzine di passeggeri sono invitati a partecipare a questo "viaggio per la stampa" fino alle rive del Mar Nero, dove l'ultima parte del viaggio viene completata su un battello a vapore.

1889

L'*Orient Express* collega ora Parigi a Costantinopoli via Budapest, Belgrado e Sofia in 67 ore e 46 minuti.

1918

La leggenda vuole che l'Armistizio del 1918 sia stato firmato a bordo dell'*Orient Express*. In realtà, fu firmato in una carrozza appartenente a un altro treno della compagnia: la carrozza ristorante n. 2419, nella radura di Rethondes, nella foresta di Compiègne.

1919

Inaugurazione del servizio *Simplon-Orient Express* da Londra a Parigi e Costantinopoli attraverso l'Italia. Iniziativa di collaborazione tra alleati, il percorso riflette la nuova situazione geopolitica dell'Europa dopo la Prima Guerra Mondiale.





Viaggia nel tempo e rivisita i momenti iconici della storia dell'*Orient Express*.

1922

Un gran numero di carrozze distrutte o confiscate durante la Prima Guerra Mondiale necessita di riparazioni o sostituzioni. Il teak sostituisce l'acciaio, ove necessario, e le carrozze vengono aggiornate con la caratteristica livrea blu notte.

1929

A causa di una forte tempesta di neve, l'*Orient Express* rimane bloccato nella città turca di Çerkezköy per diversi giorni. L'evento ispira il classico di Agatha Christie, *Assassinio sull'Orient Express* (pubblicato nel 1934).

1934

L'uscita del romanzo bestseller di Agatha Christie *Assassinio sull'Orient Express*, con protagonista l'immaginario detective belga Hercule Poirot, proietta il treno verso nuove vette di notorietà come icona culturale.

1946

Dopo la sua interruzione in tutta Europa a causa della Seconda Guerra Mondiale, il servizio per Istanbul viene finalmente ripristinato.

1974

Il primo film basato sull'*Assassinio sull'Orient Express* di Agatha Christie viene presentato in anteprima mondiale, diventando un classico moderno.

1977

A causa dell'agguerrita concorrenza degli aerei di lusso, l'*Orient Express* compie il suo ultimo viaggio verso Istanbul il 20 maggio.



## INCONTRIAMO I DESIGNER LEGO®

- “La proposta originale di Thomas era di altissimo livello in termini di accuratezza e dettagli: la sua passione per l’epoca del vapore è davvero evidente. Abbiamo fatto tutto il possibile per rappresentare l’esperienza originale di un viaggio di lusso di livello mondiale anche nel modello finale LEGO®. Abbiamo la carrozza ristorante e la carrozza letto e, dopo lunghe ricerche e consultazioni con esperti, siamo riusciti a ricreare interpretazioni LEGO di dettagli come i rivestimenti in legno e gli specchi in vetro tagliato presenti sul servizio originale. Mi auguro che i nostri fan dei treni LEGO trovino molti pezzi desiderabili realizzati per questo set; un nuovissimo elemento trave creato per le aste di accoppiamento della locomotiva, le penne utilizzate per i fischietti e un secchio utilizzato per il fumaio sono solo alcuni dei miei preferiti. Il modello è anche più grande dei tradizionali treni LEGO, il che significa che all’interno c’è più spazio per i dettagli e, naturalmente, per giocare!”

–Ollie Gregory,  
LEGO® Ideas Senior Model Designer

W



“Il modello di Thomas è stato un set davvero fantastico – e nostalgico – su cui lavorare! Mi sono piaciuti molto i pannelli in legno, il vetro, lo specchio convesso, lo specchio con gli uccelli e tutti i dettagli ispirati all'originale. Volevamo che le decorazioni dessero vita agli interni e aggiungessero un po' di DNA LEGO®. Tutti gli uccelli, i fiori e le foglie sono elementi LEGO, ma è stato comunque un vero rompicapo riuscire a trovare il corretto adattamento e la giusta combinazione di colori e dettagli, e abbiamo testato molti design e stampe, loghi e font di testo per ottenere il risultato giusto. Un'altra parte

sempre divertente, ma anche impegnativa, è la progettazione di nuove minifigure. *L'Orient Express* è un'icona della cultura popolare, quindi abbiamo un'affascinante cast di personaggi che è possibile utilizzare per creare le proprie storie, tra cui un nuovo cameriere e un giornalista, oltre a un conduttore, un pompiere, un concierge, un facchino, un'illustre duchessa, uno scienziato e altro ancora. Spero che il set stimoli davvero la vostra immaginazione”.

*Kjeld Walther Sørensen,*  
LEGO® Ideas Graphic Designer

S



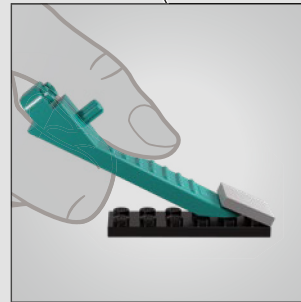
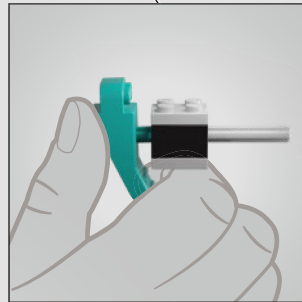
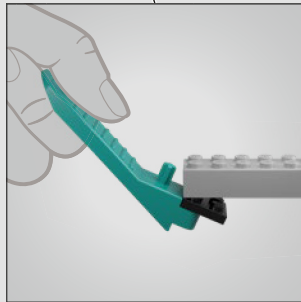
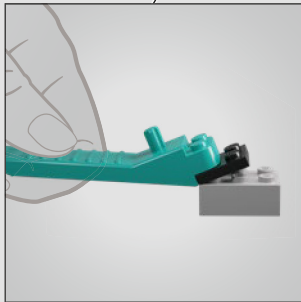
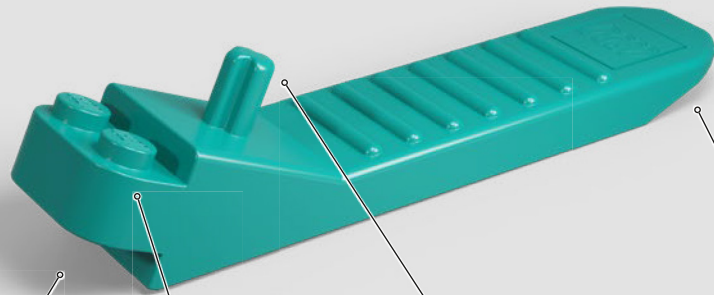

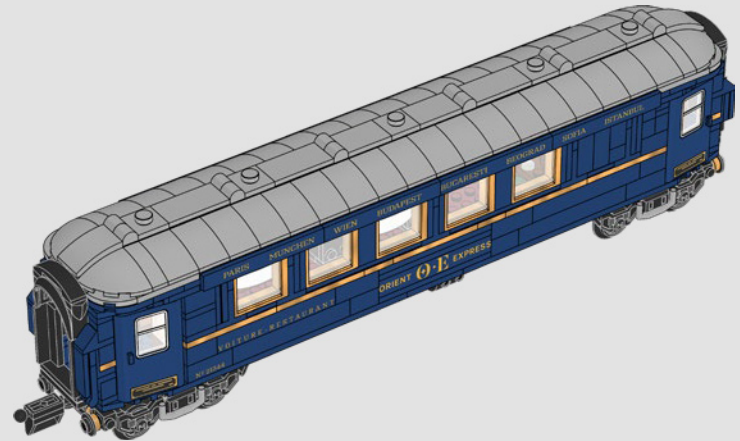
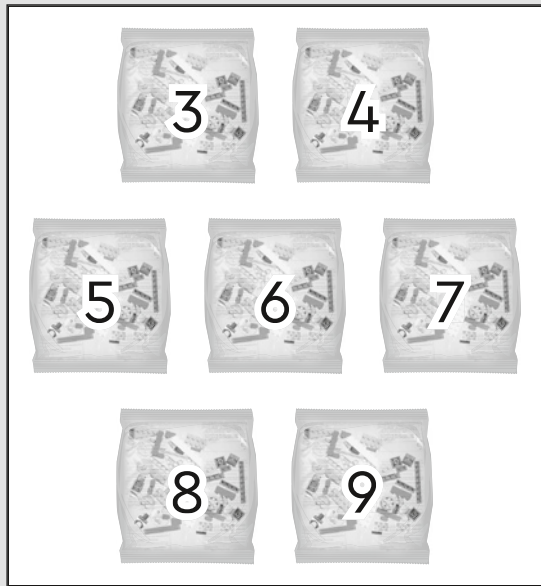
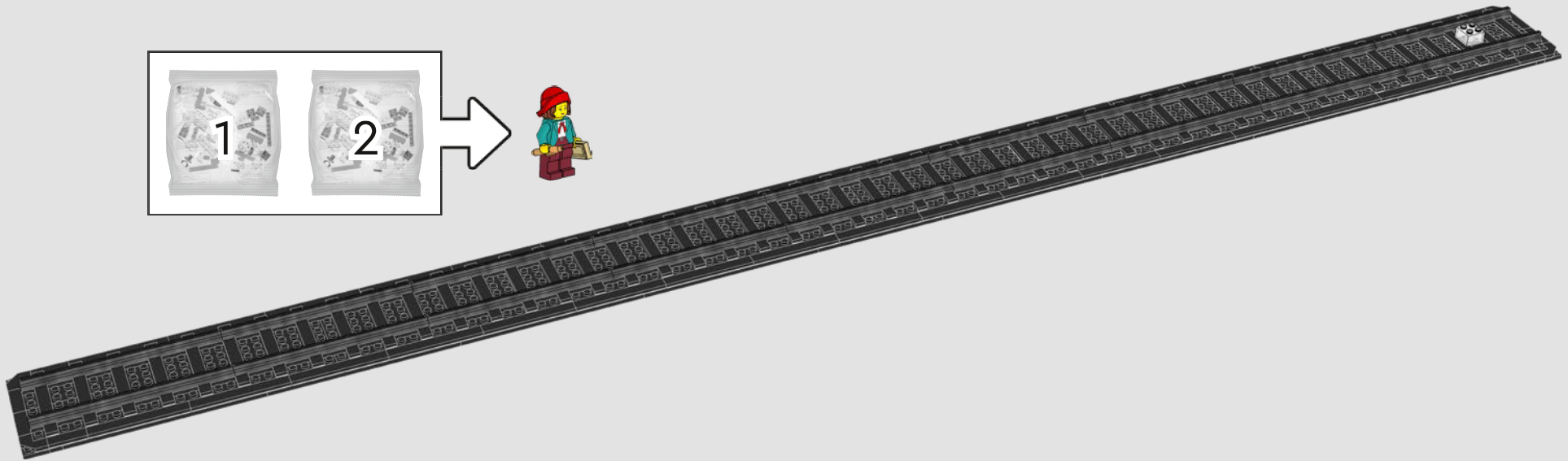
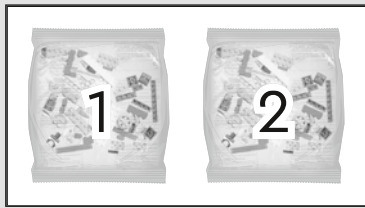

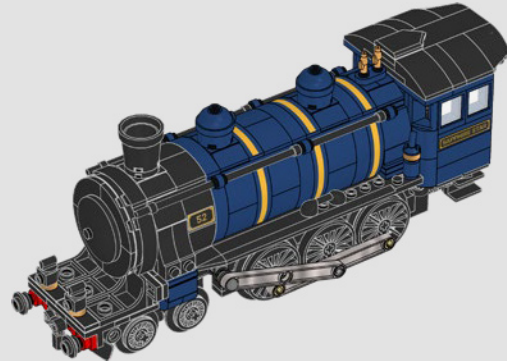
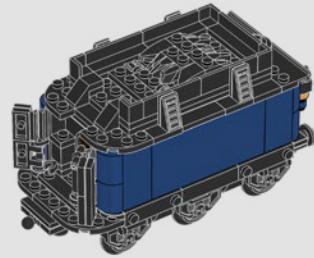
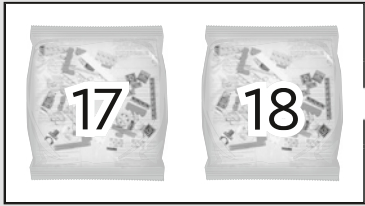
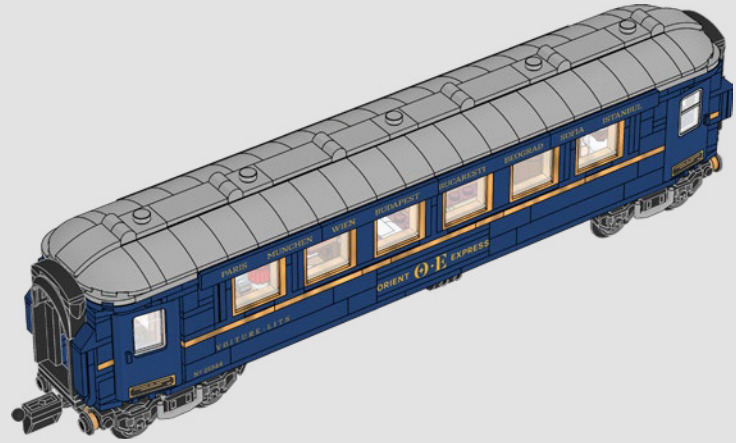
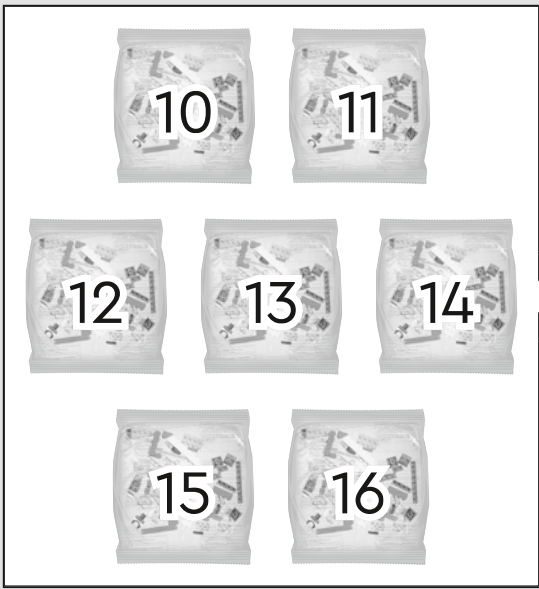



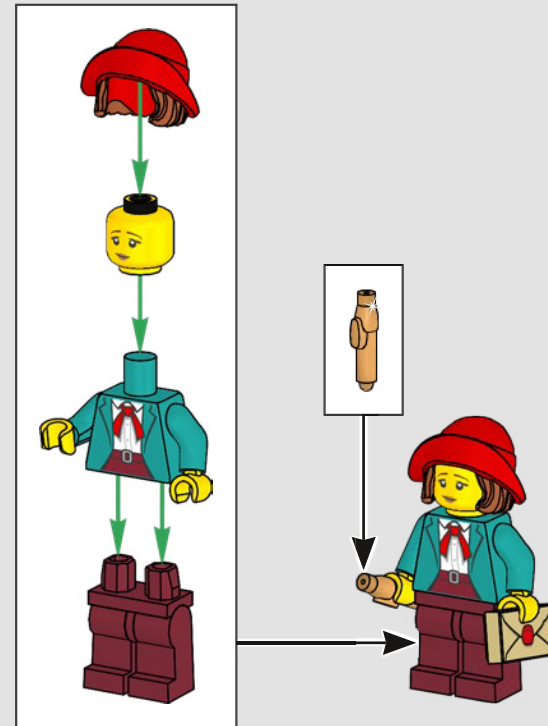
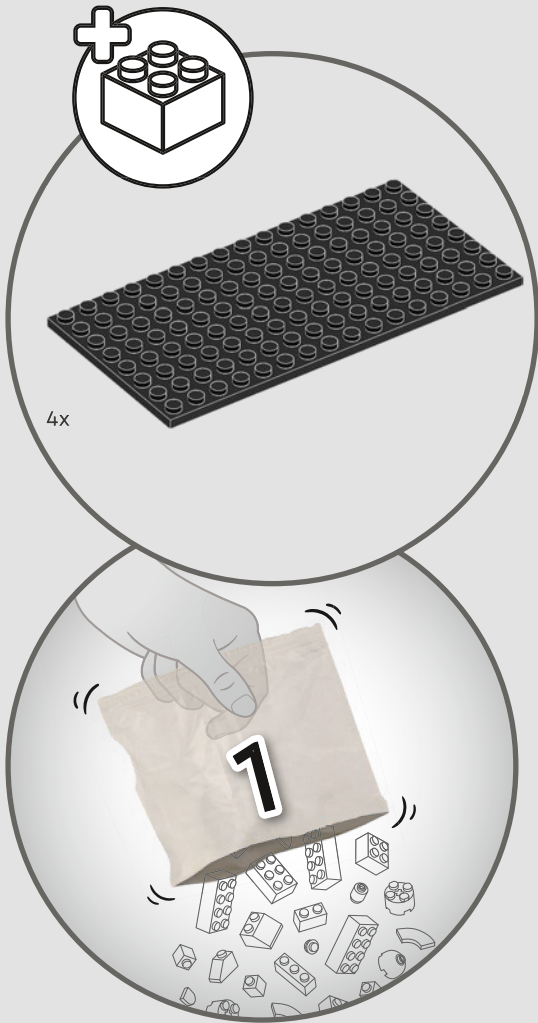

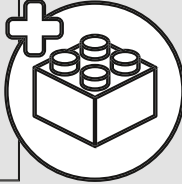
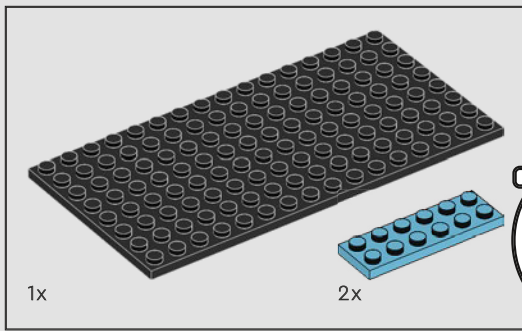

1

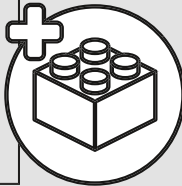
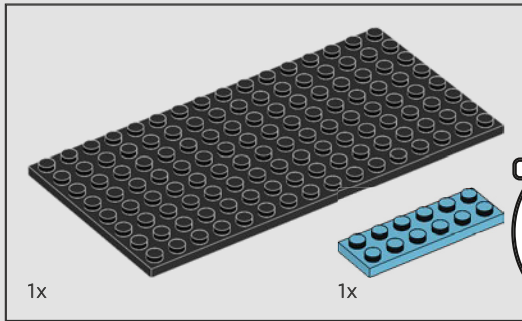
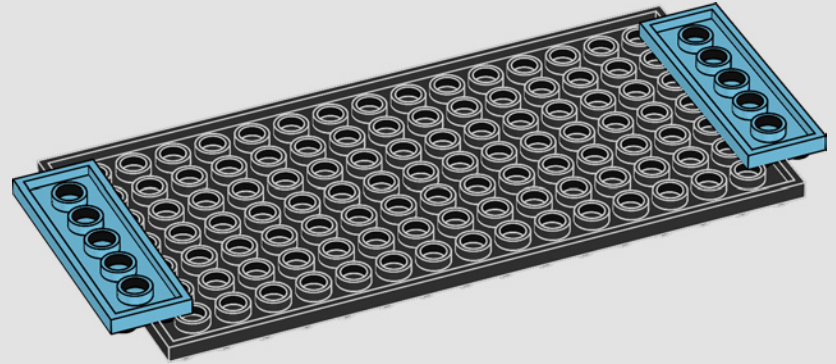

2

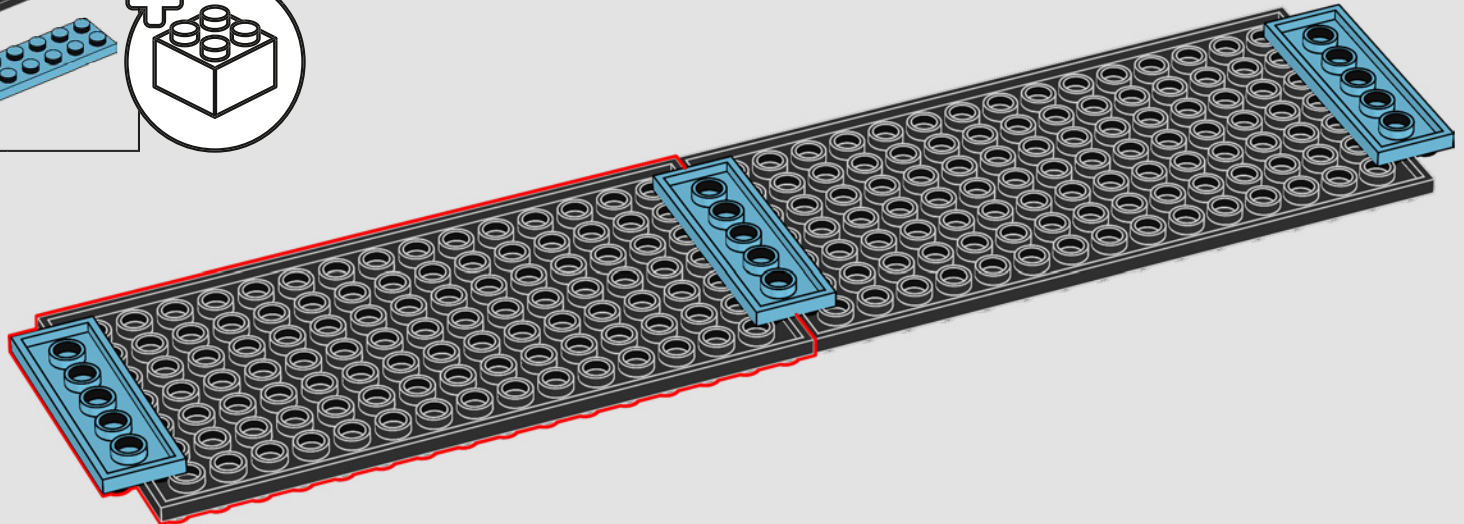

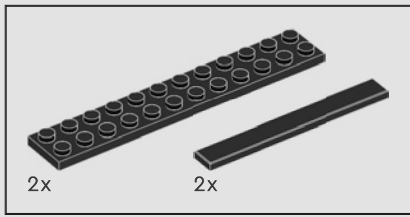

3

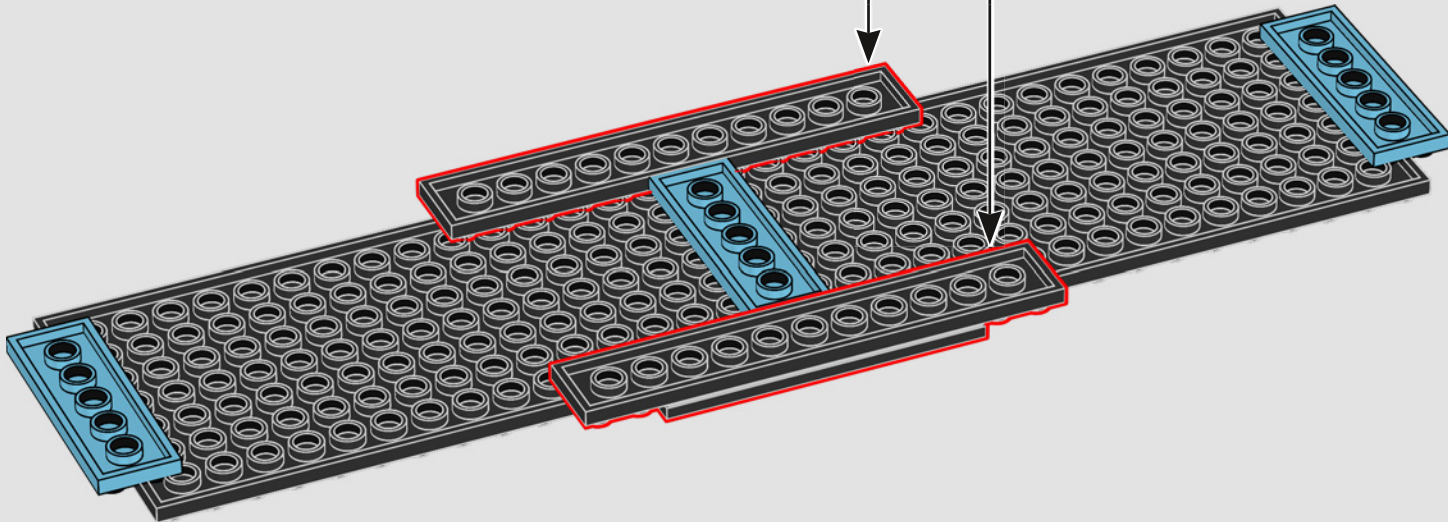
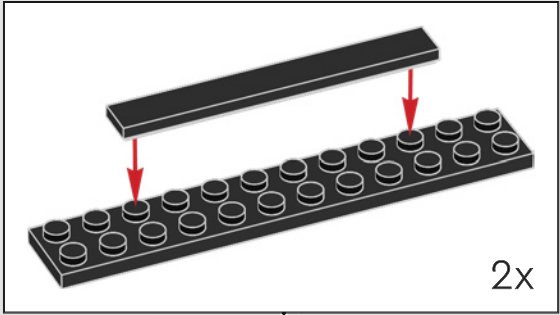



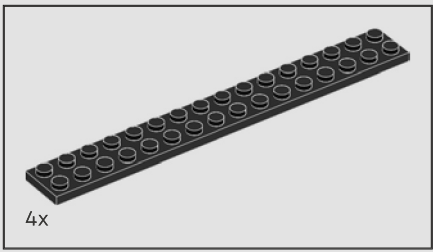

4

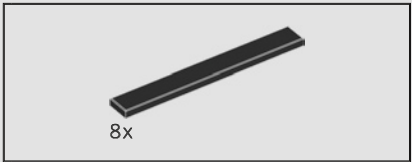
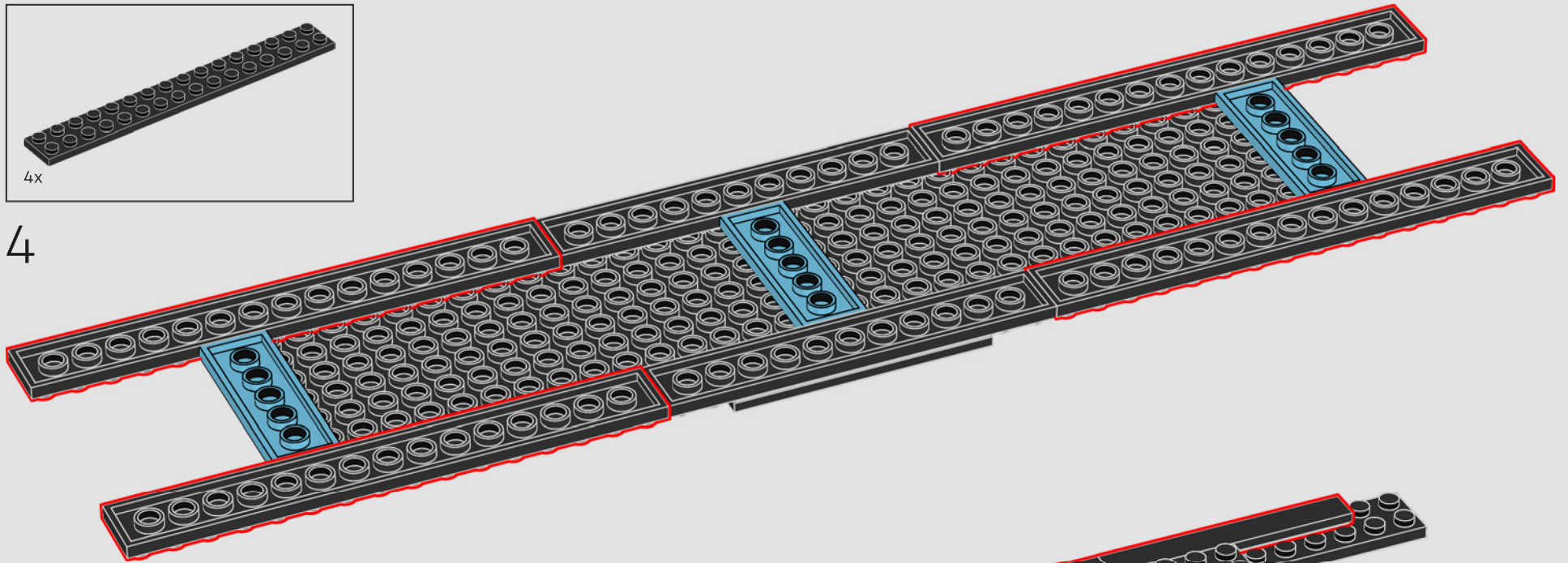

5

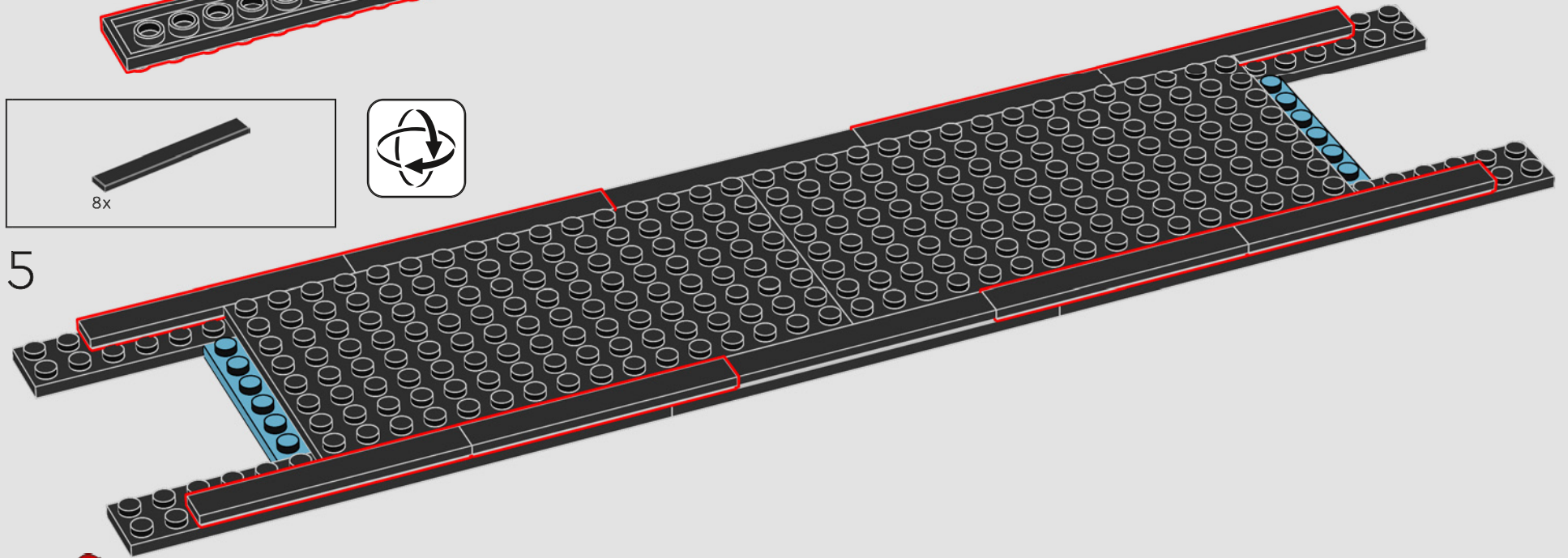

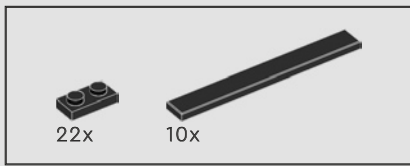

6

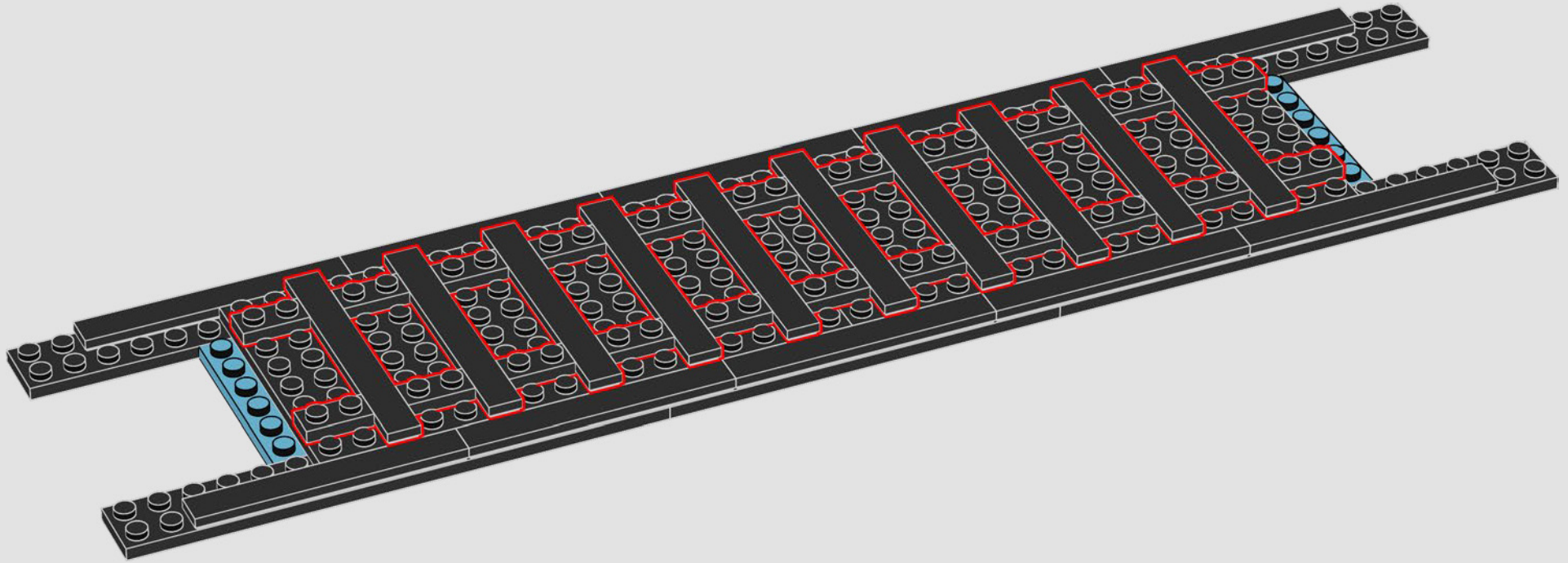





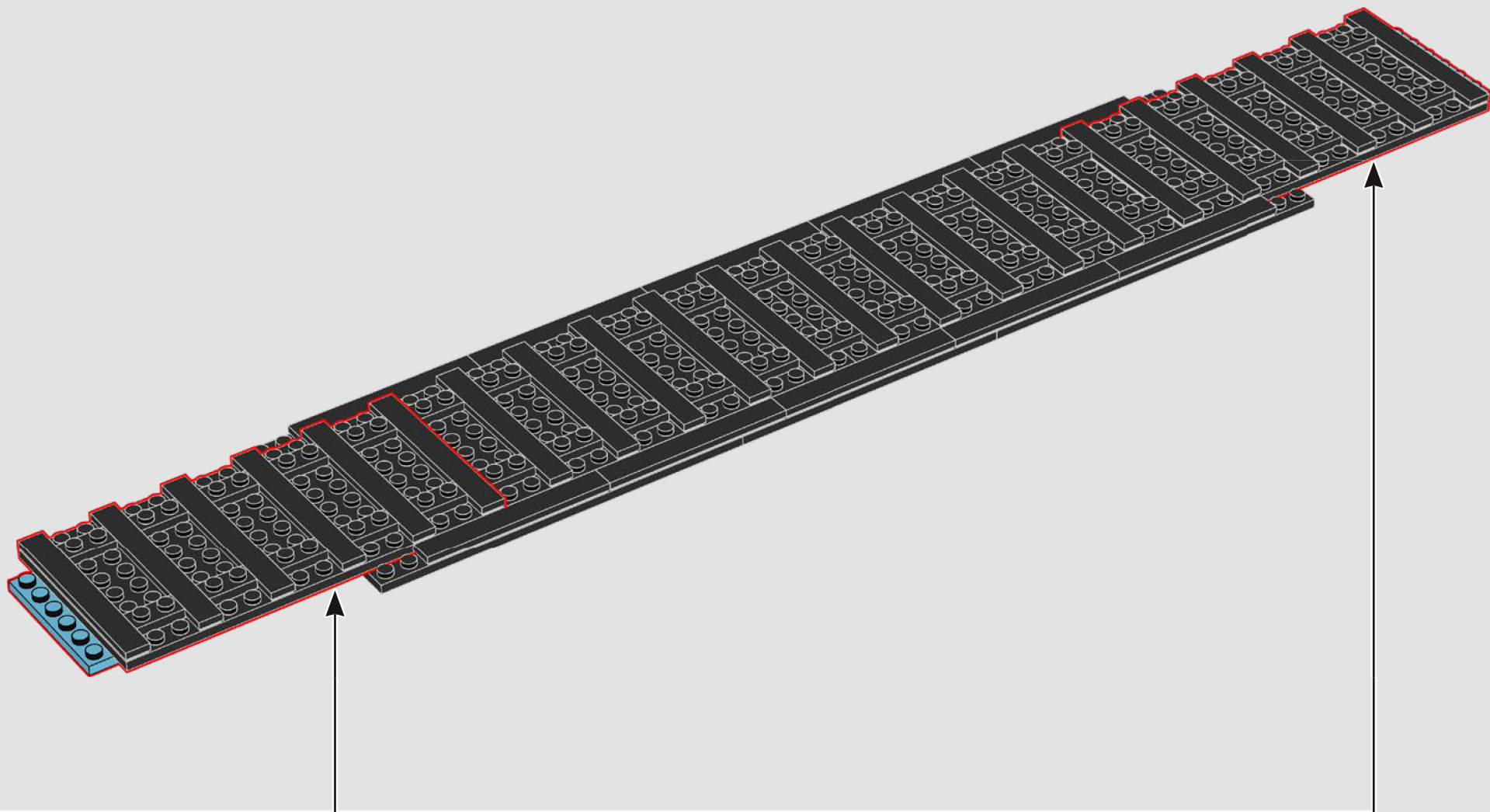

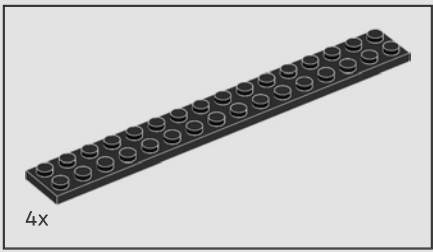

8

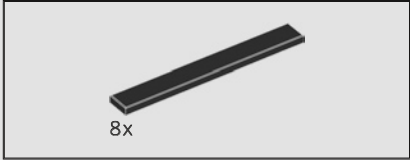
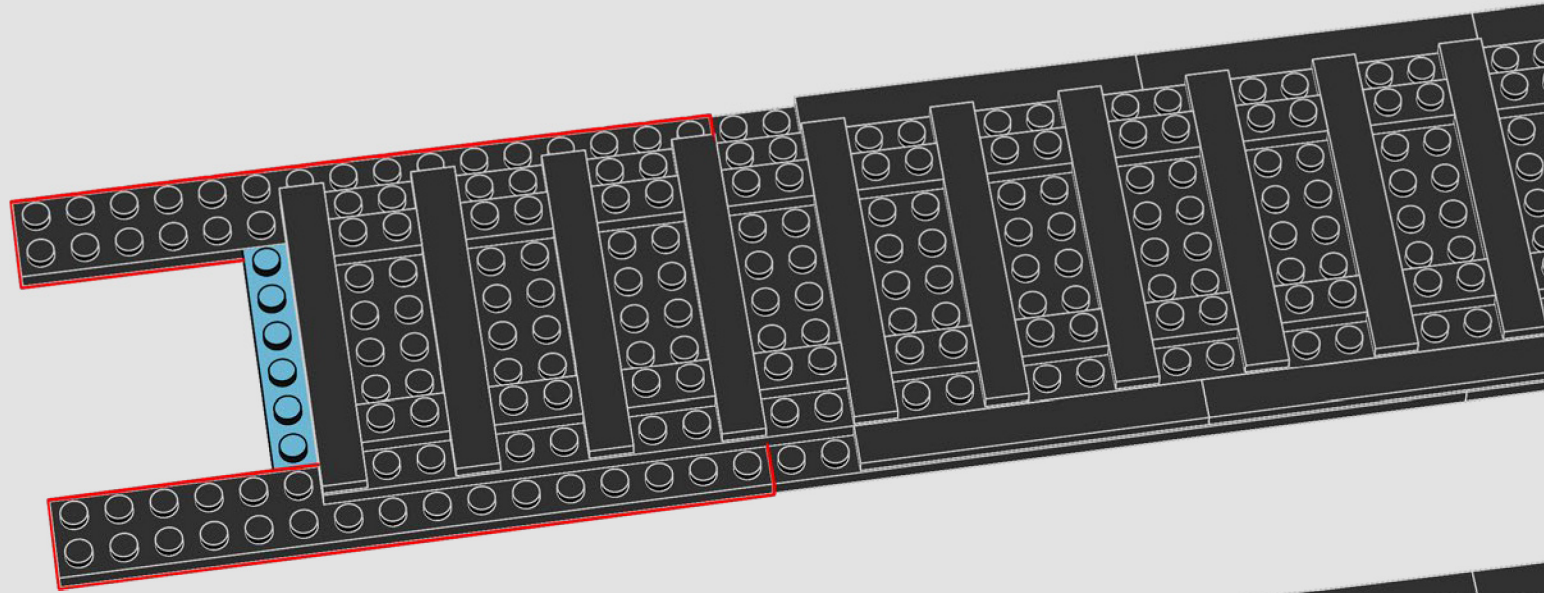

9

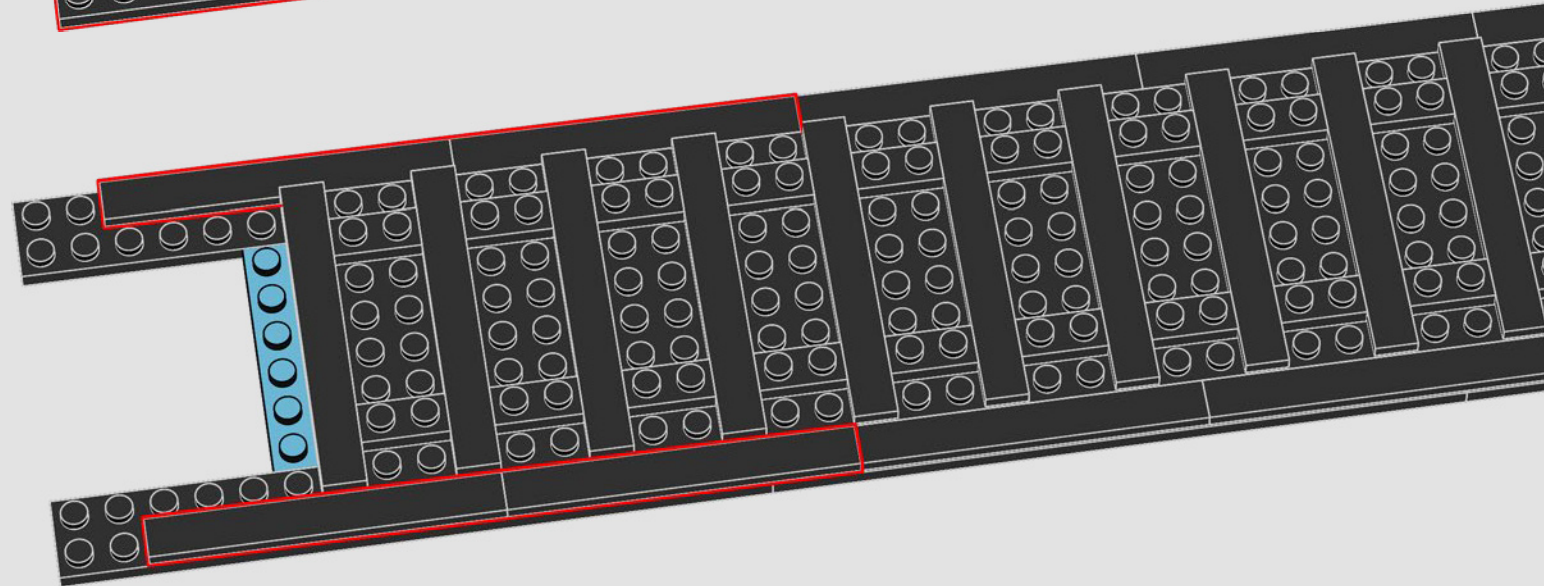



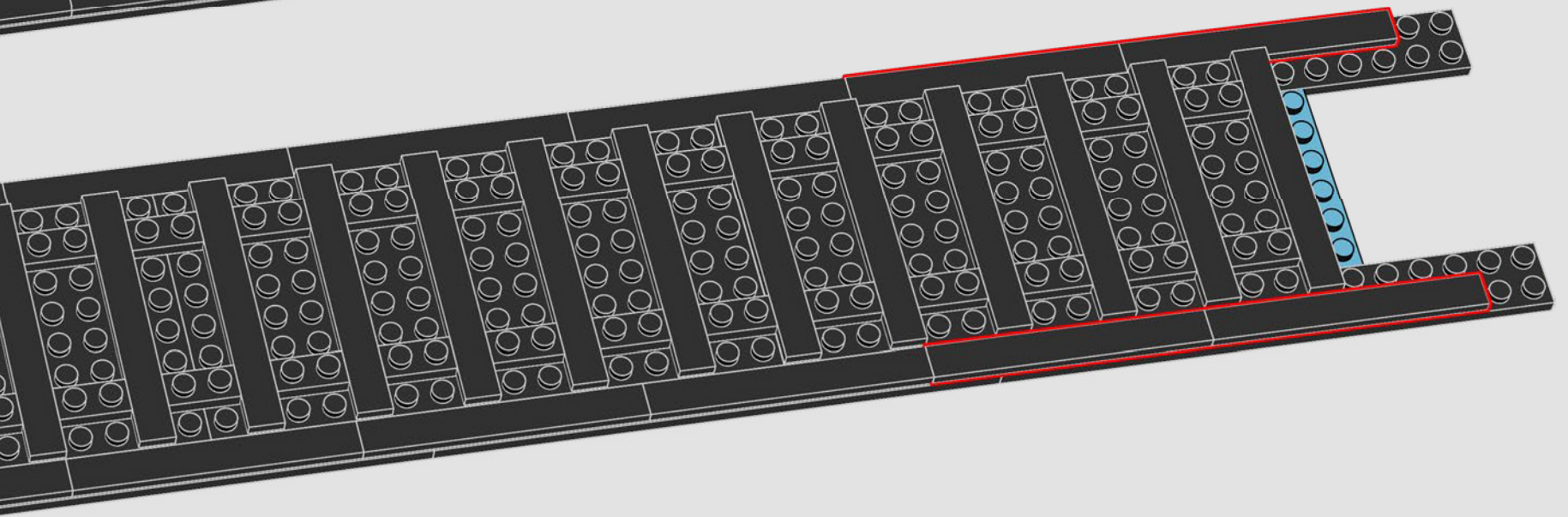
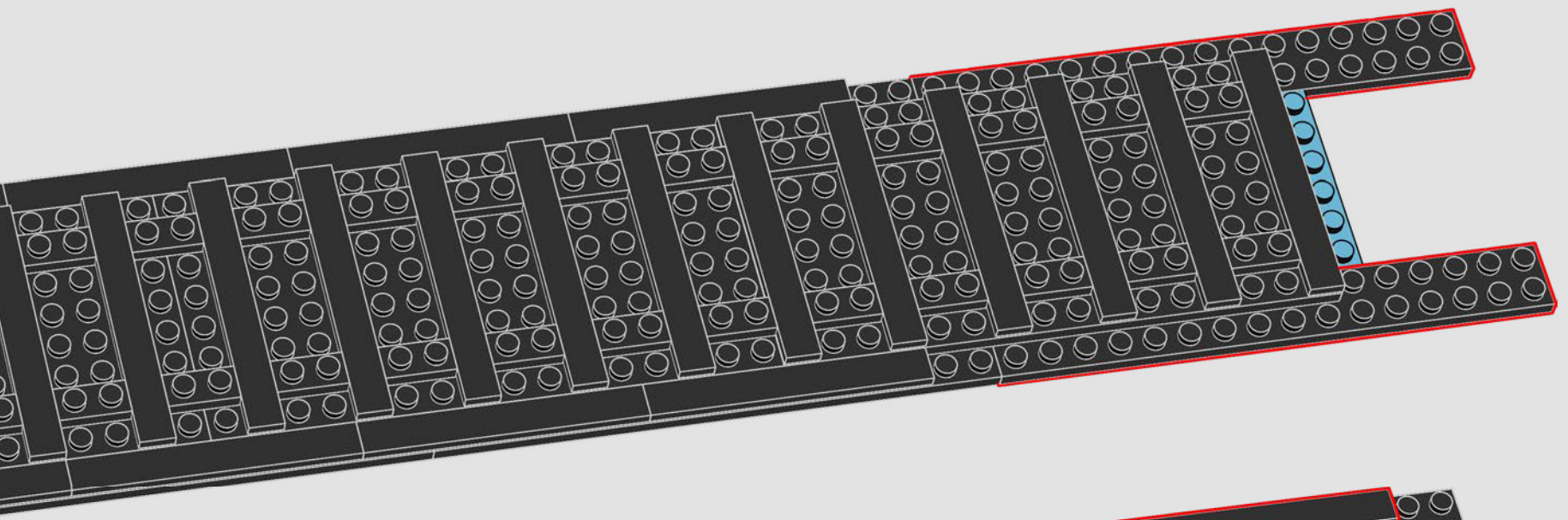



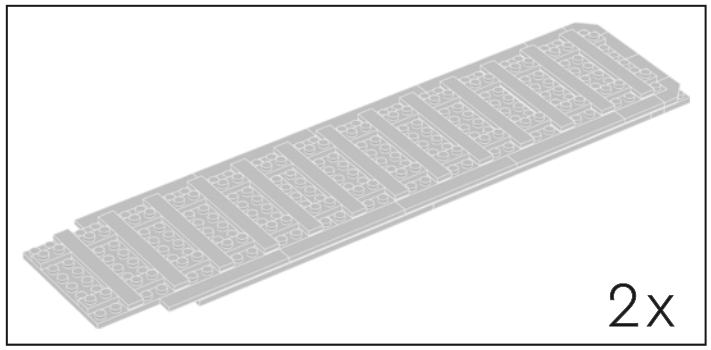
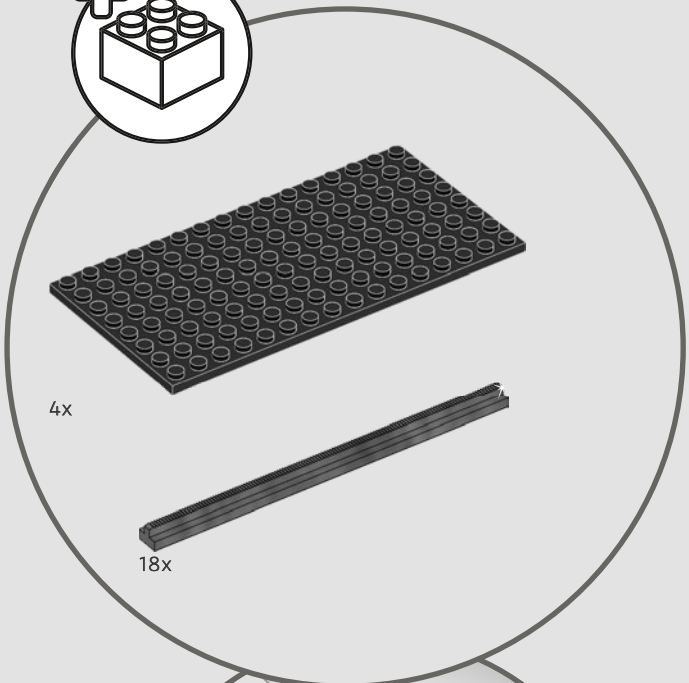
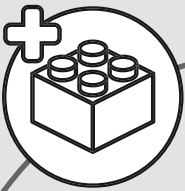

2x

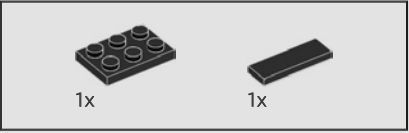

10

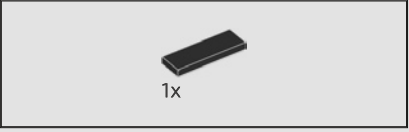
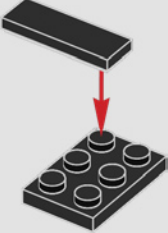

11

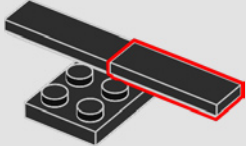

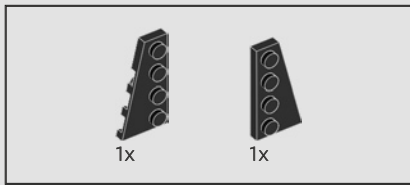

12

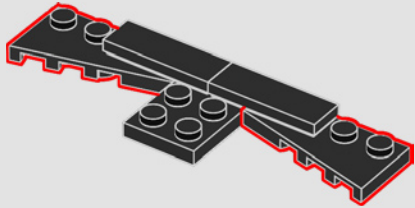

13

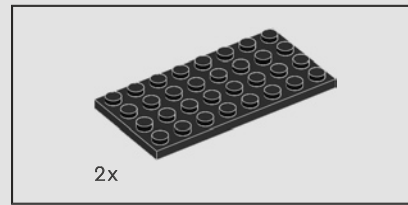
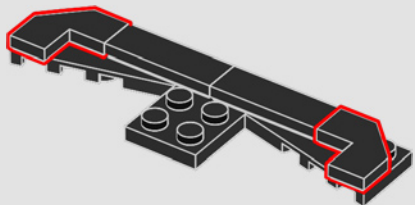

14

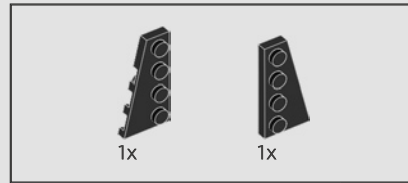
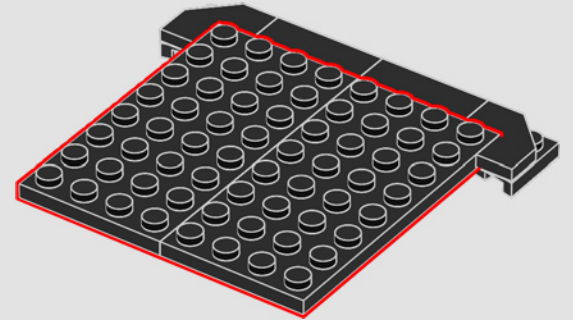

15

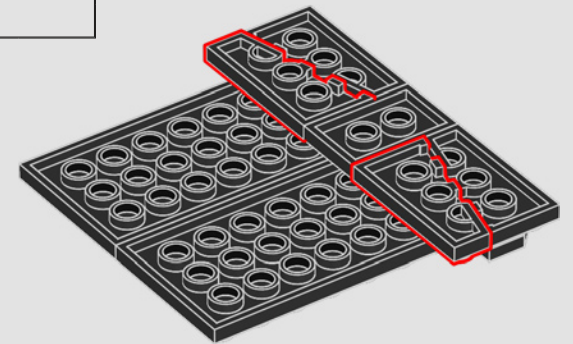

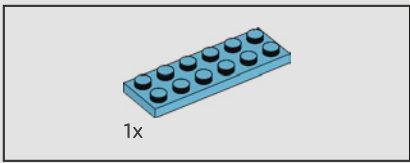

16

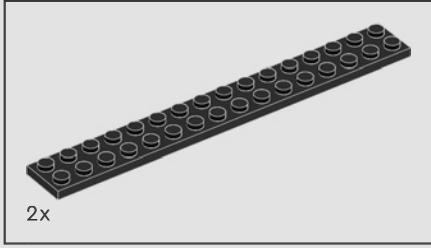
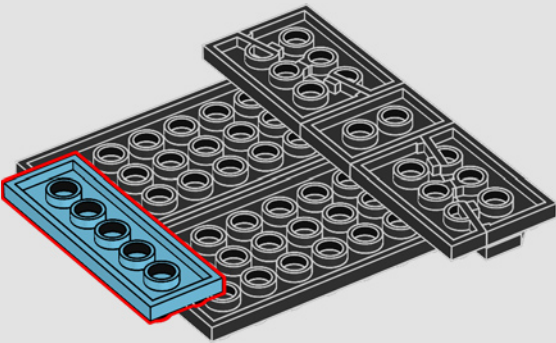

17

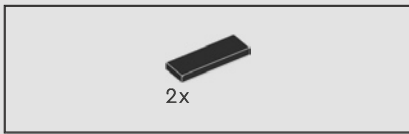
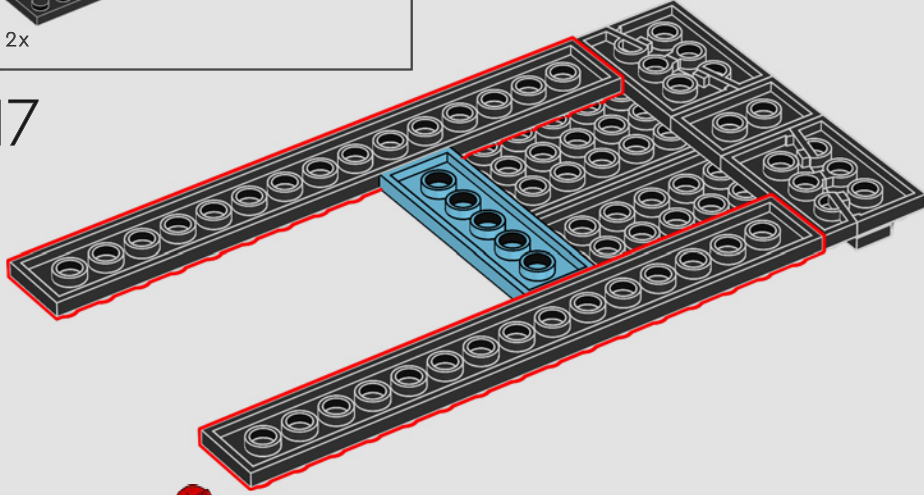

18

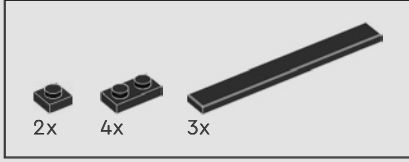
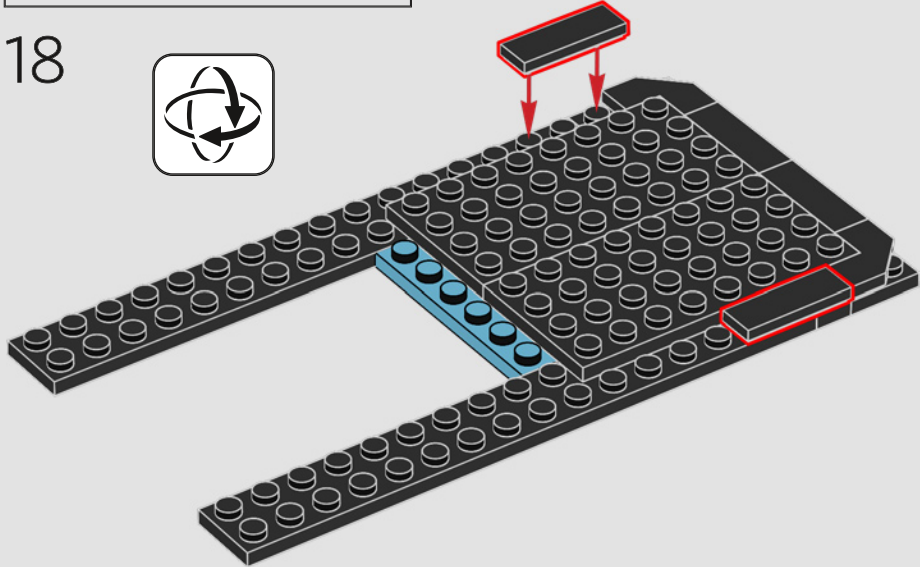

19

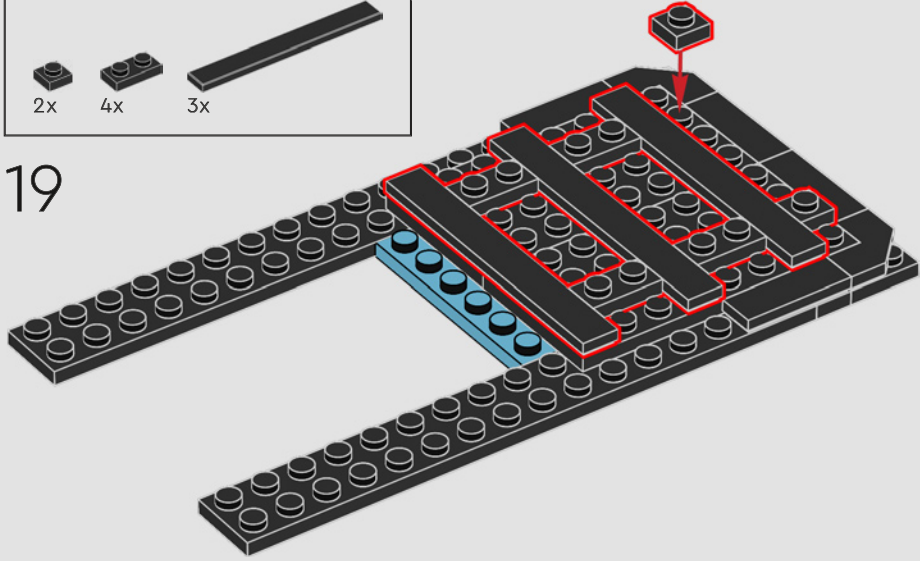



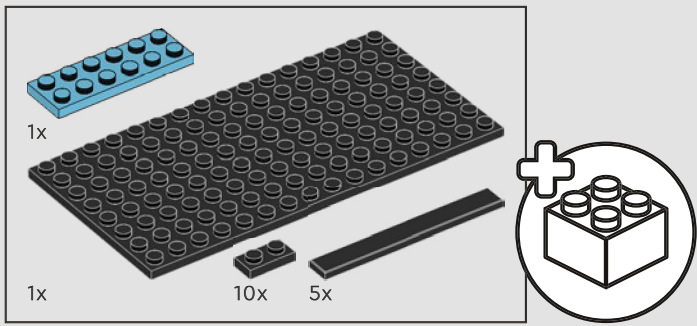

20

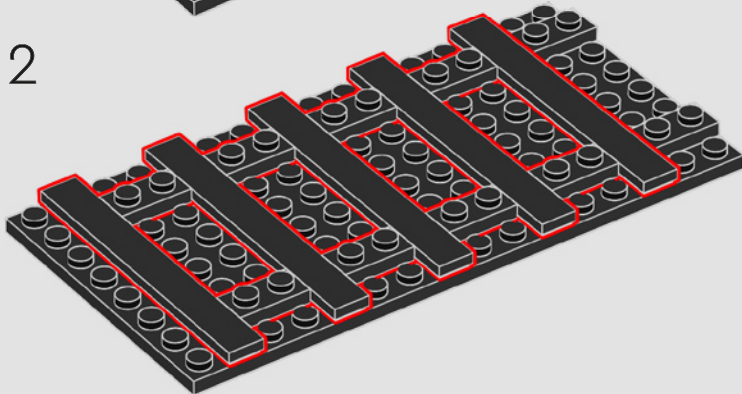
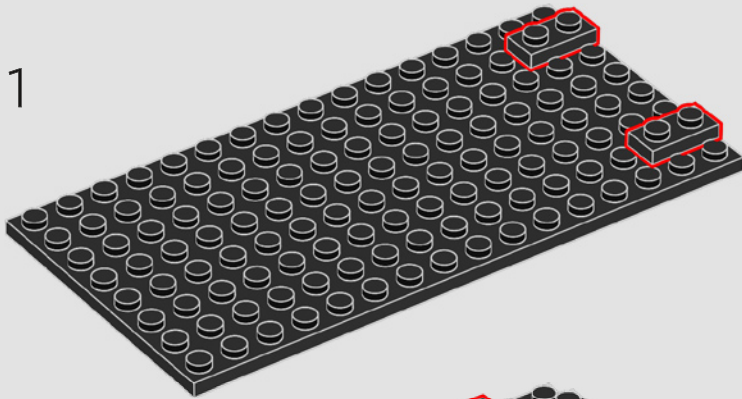

3

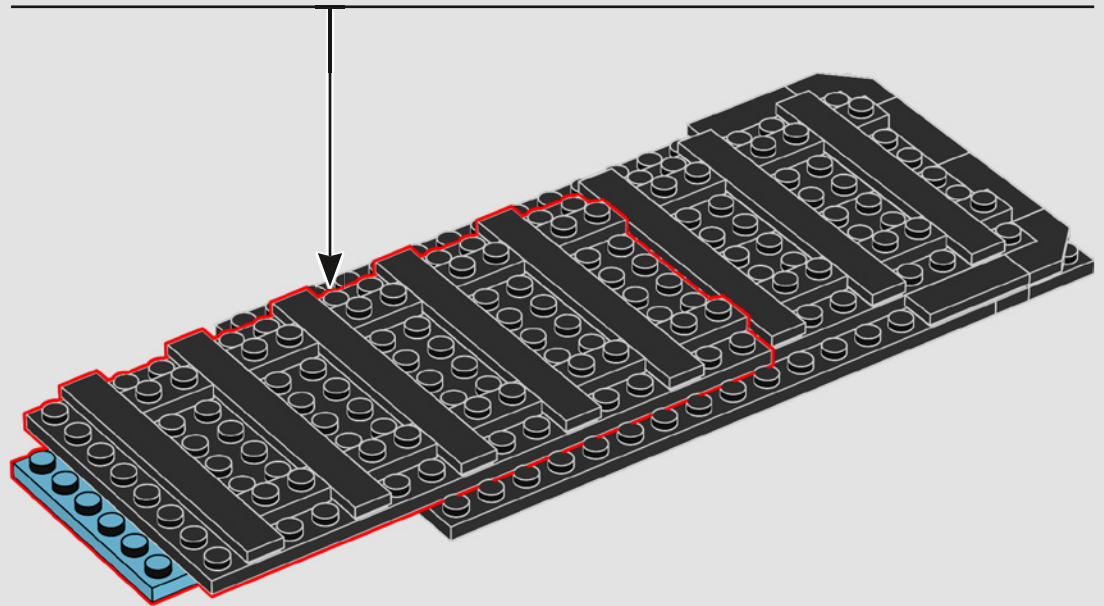
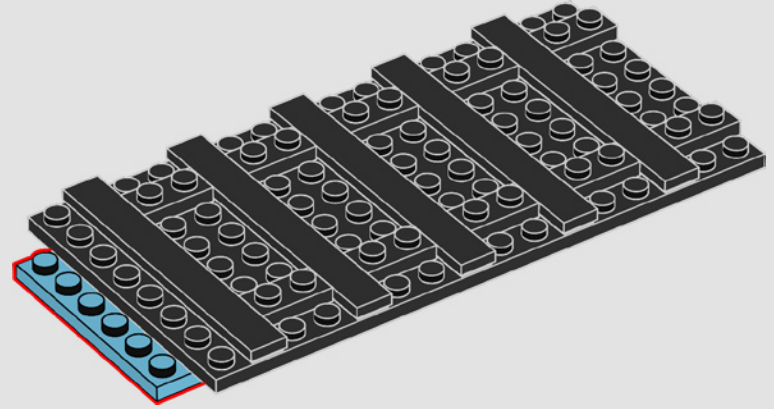

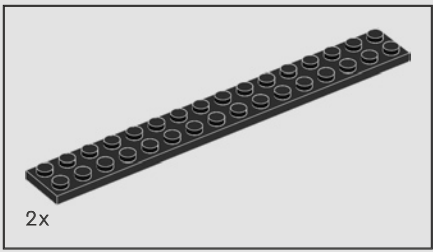

21

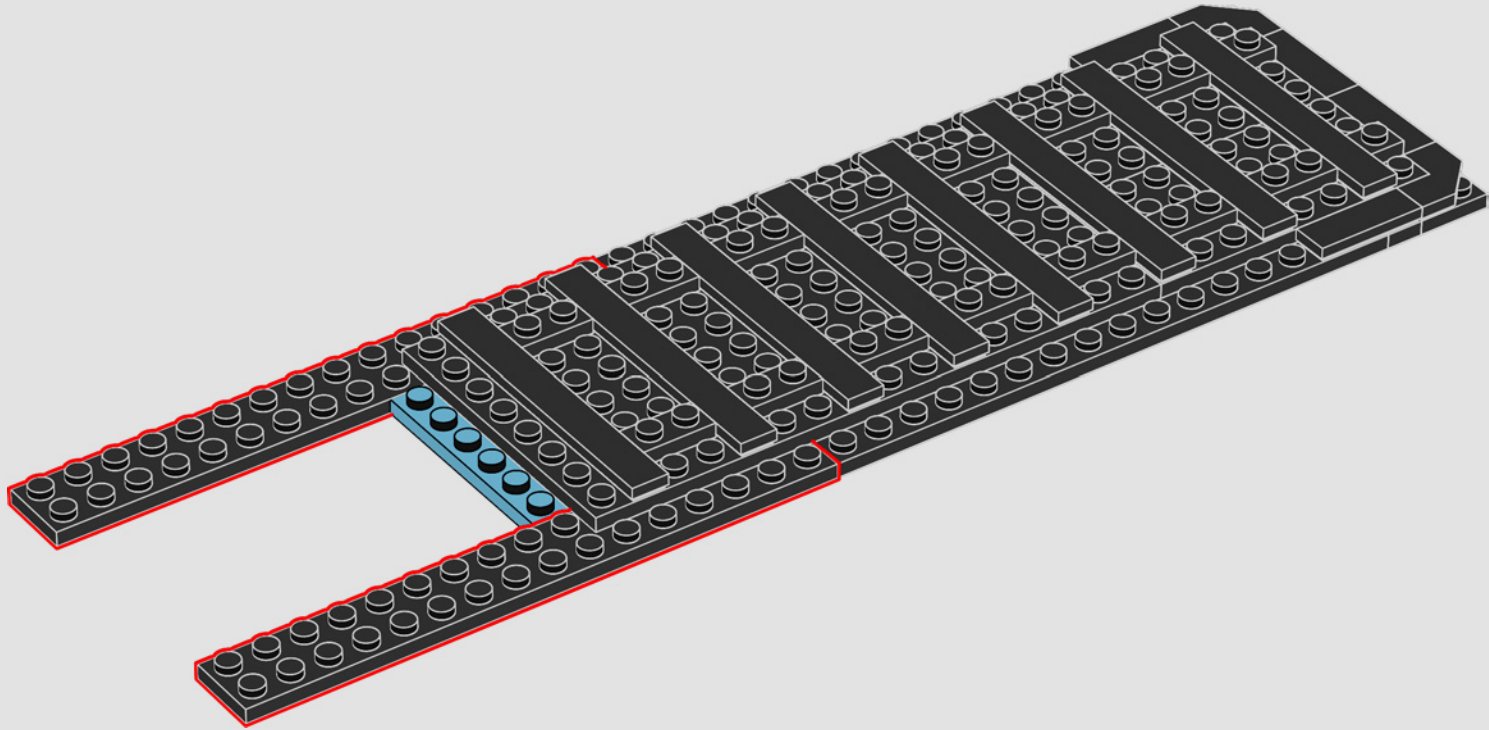

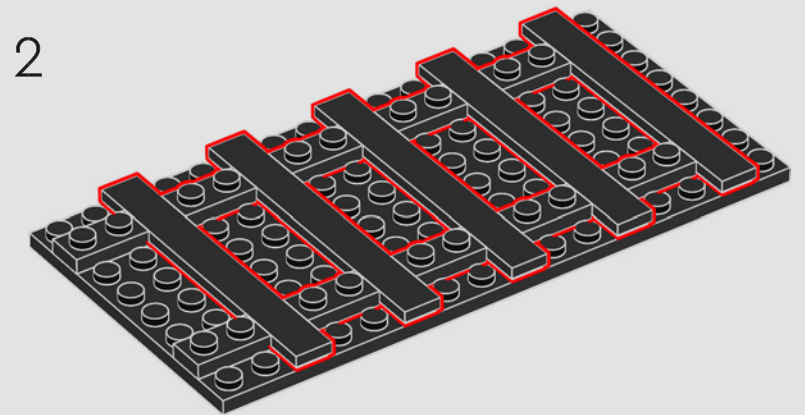
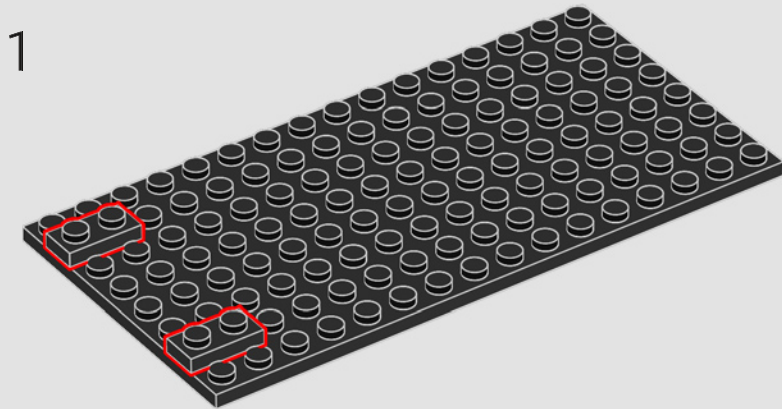
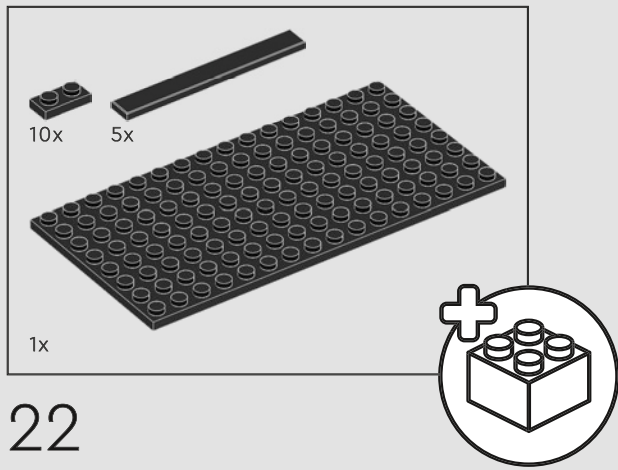



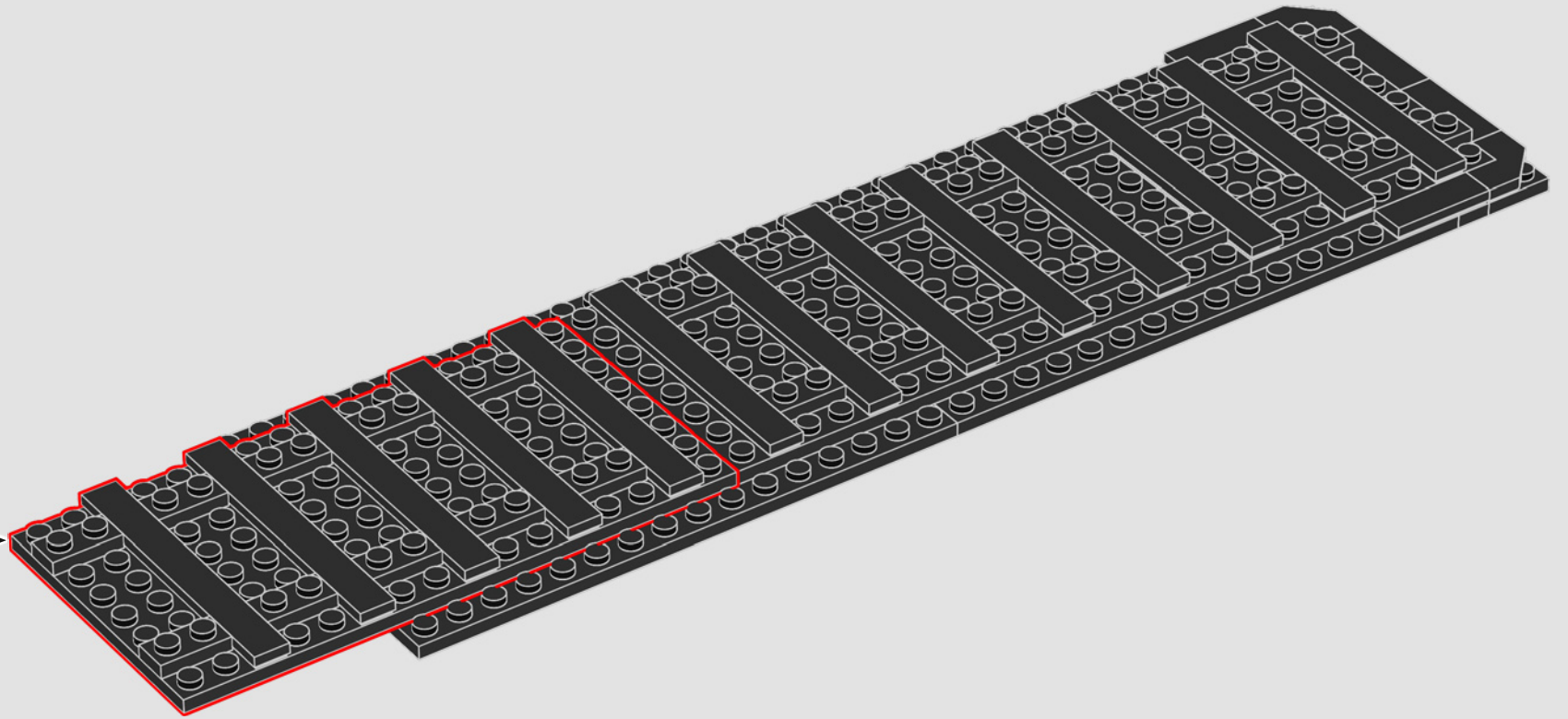

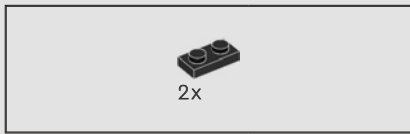

23

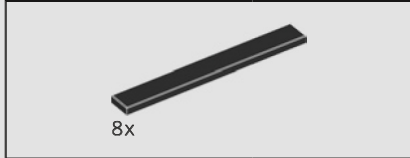
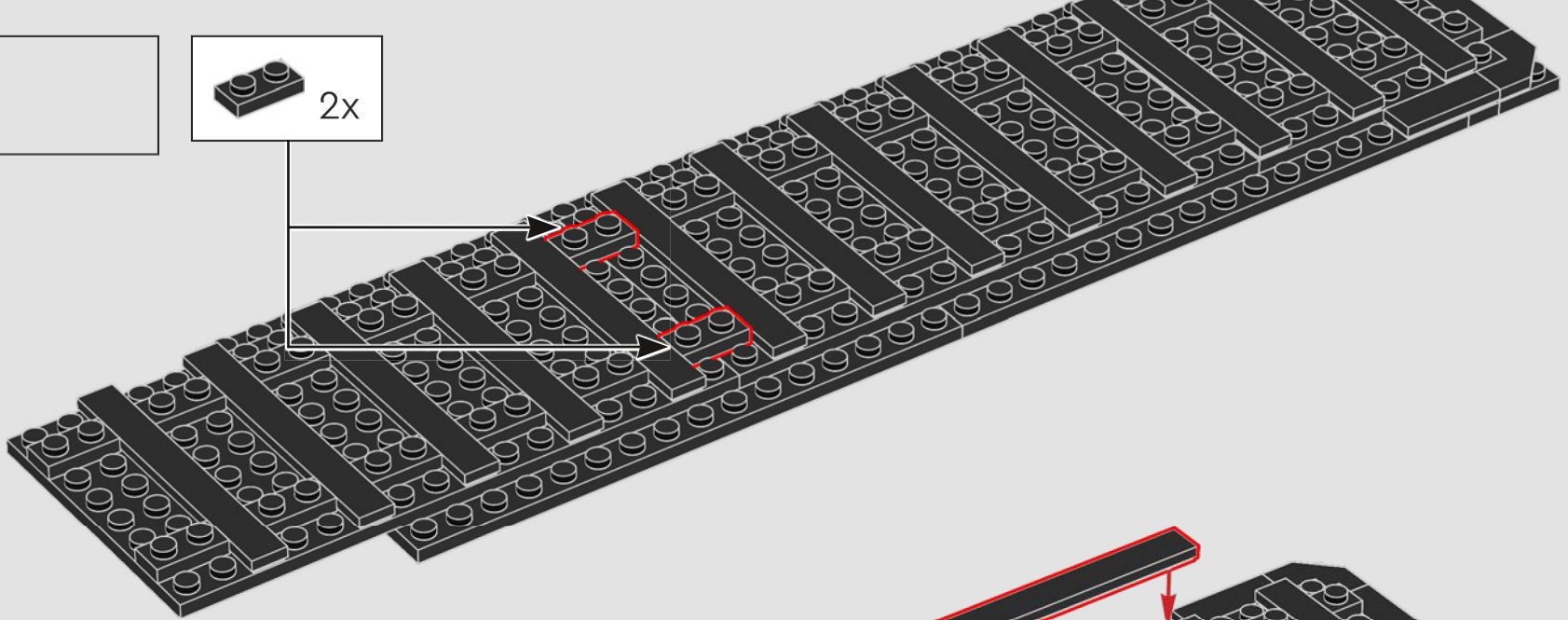

24

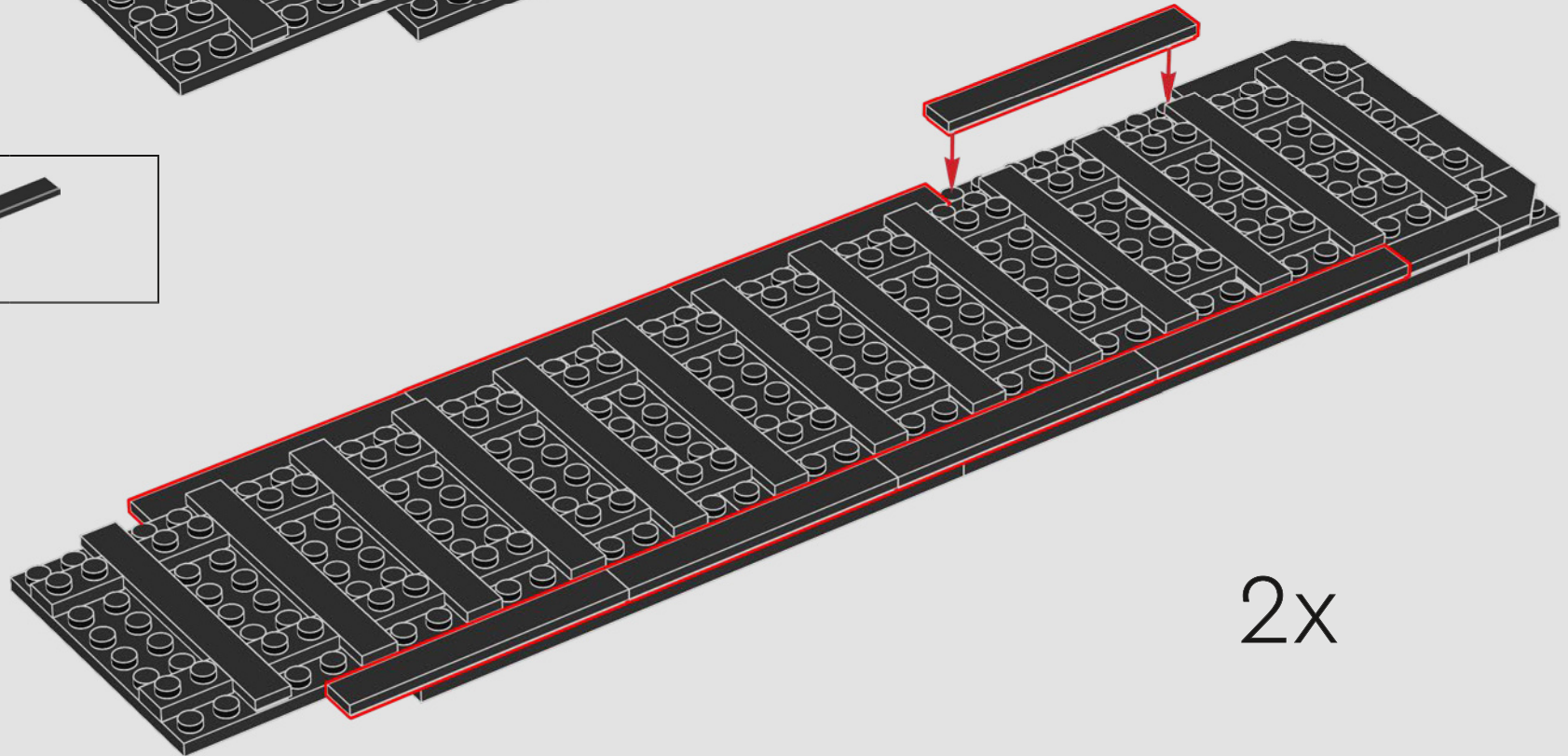

2x



2x

25

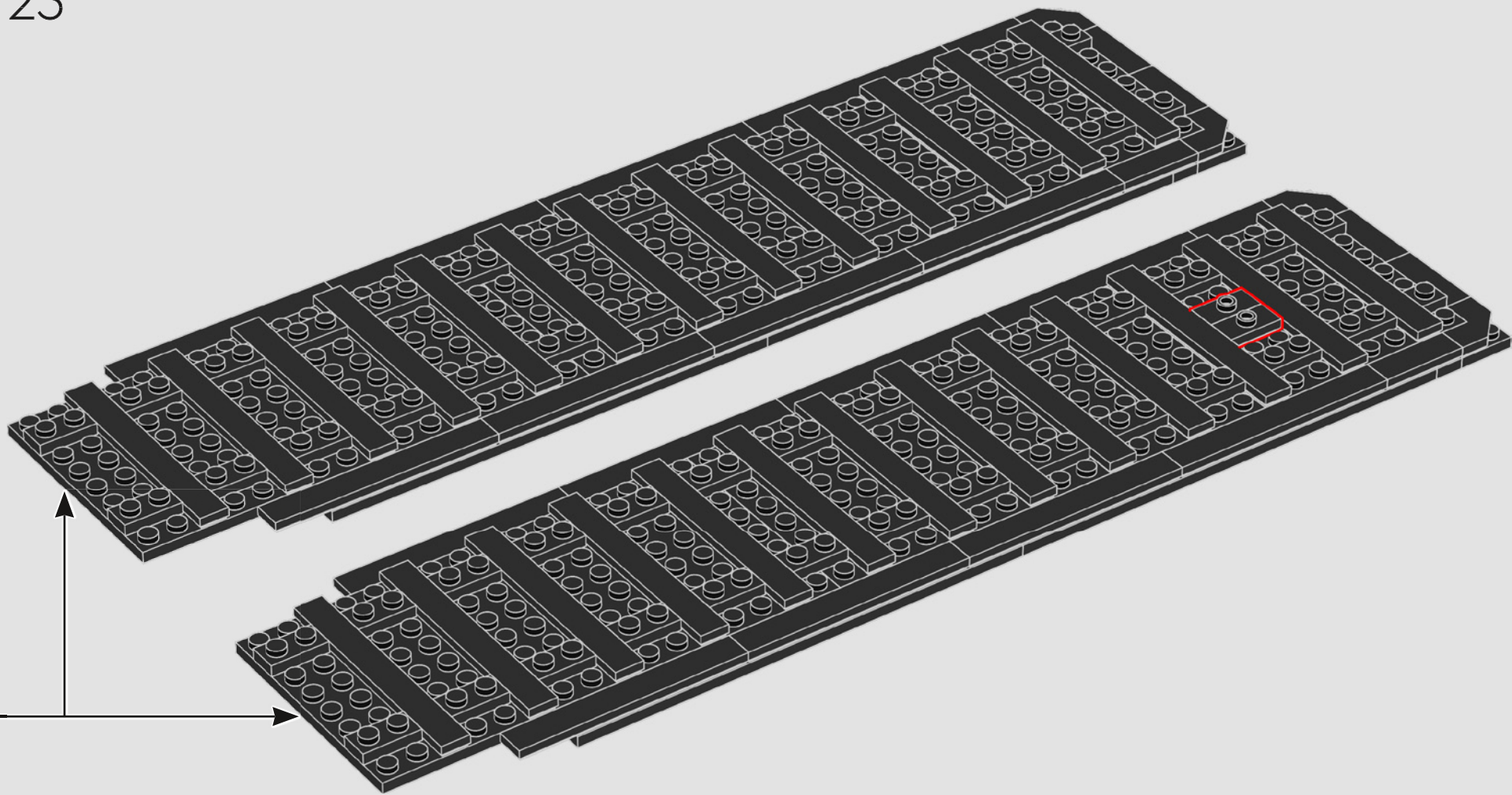





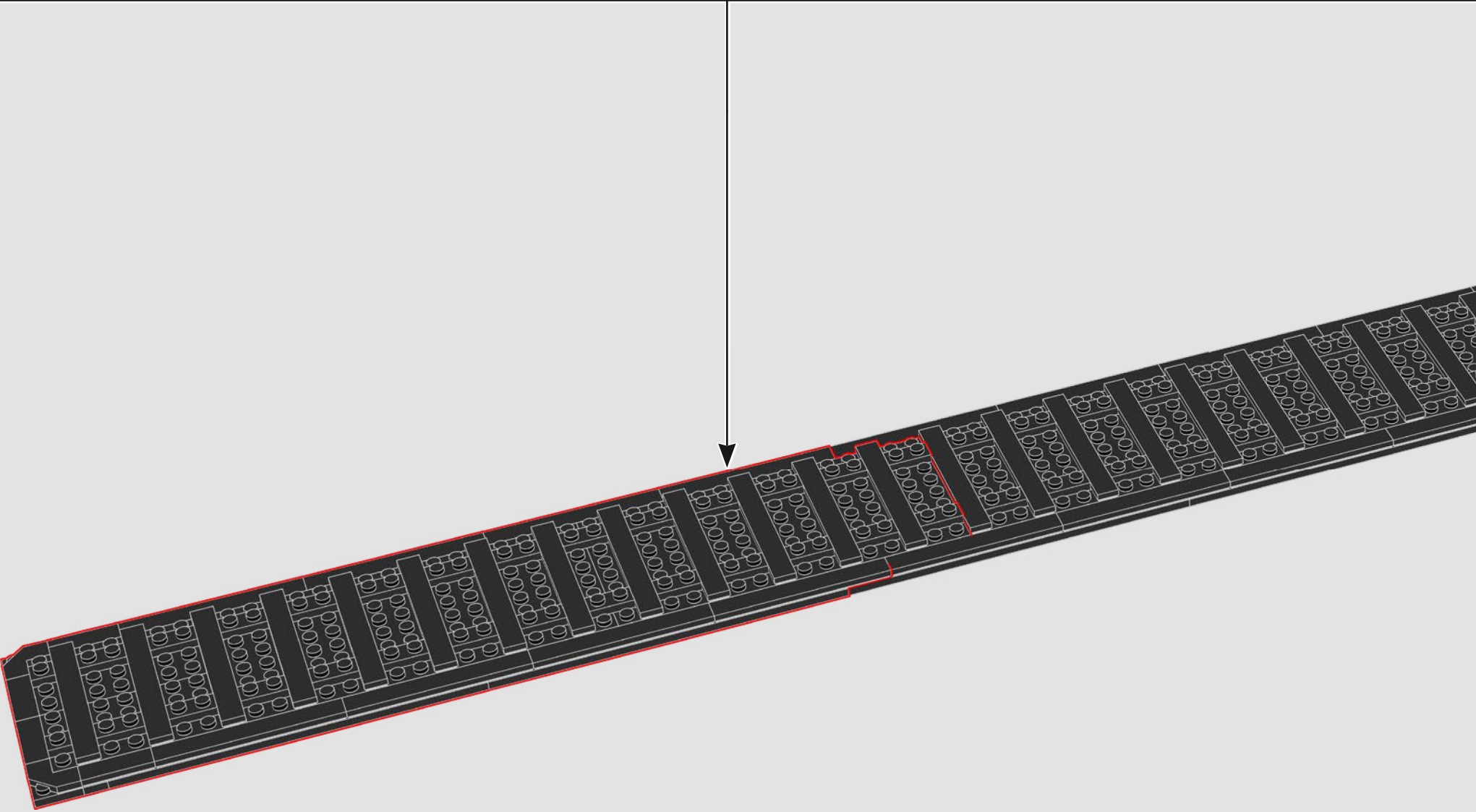

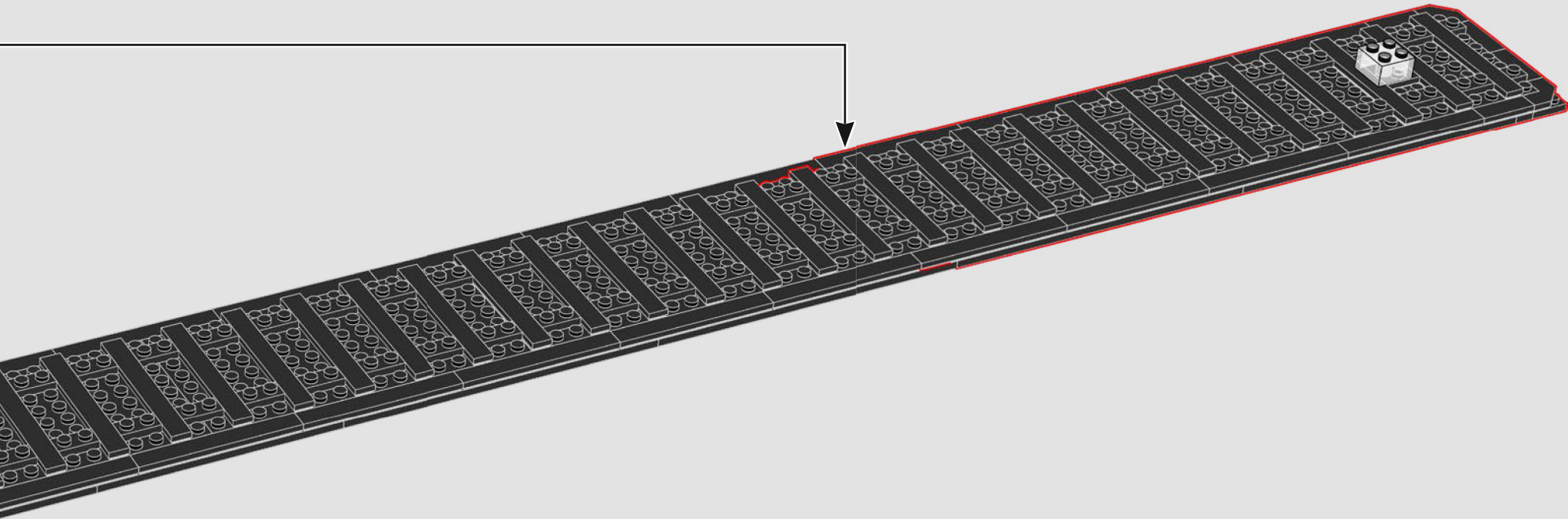



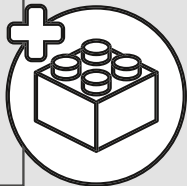
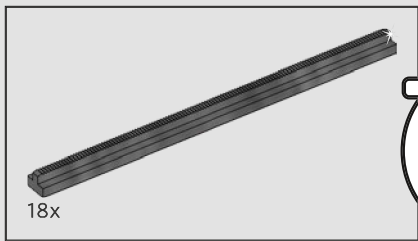

28

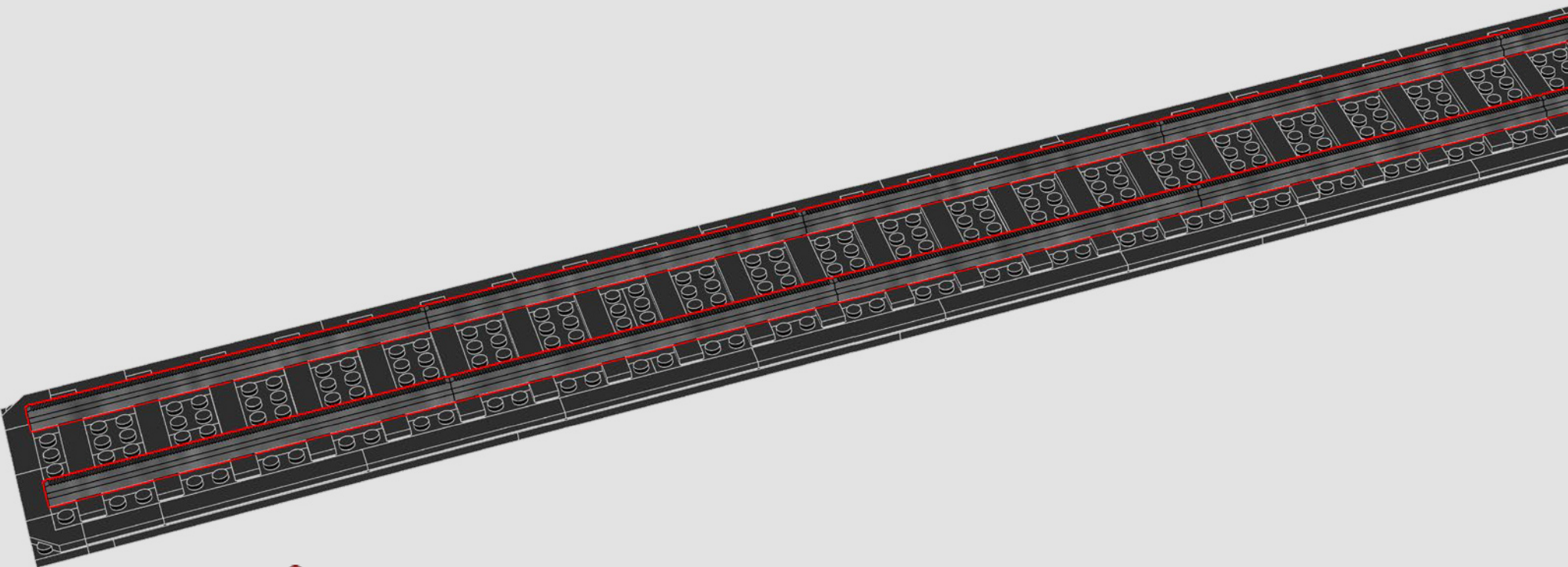

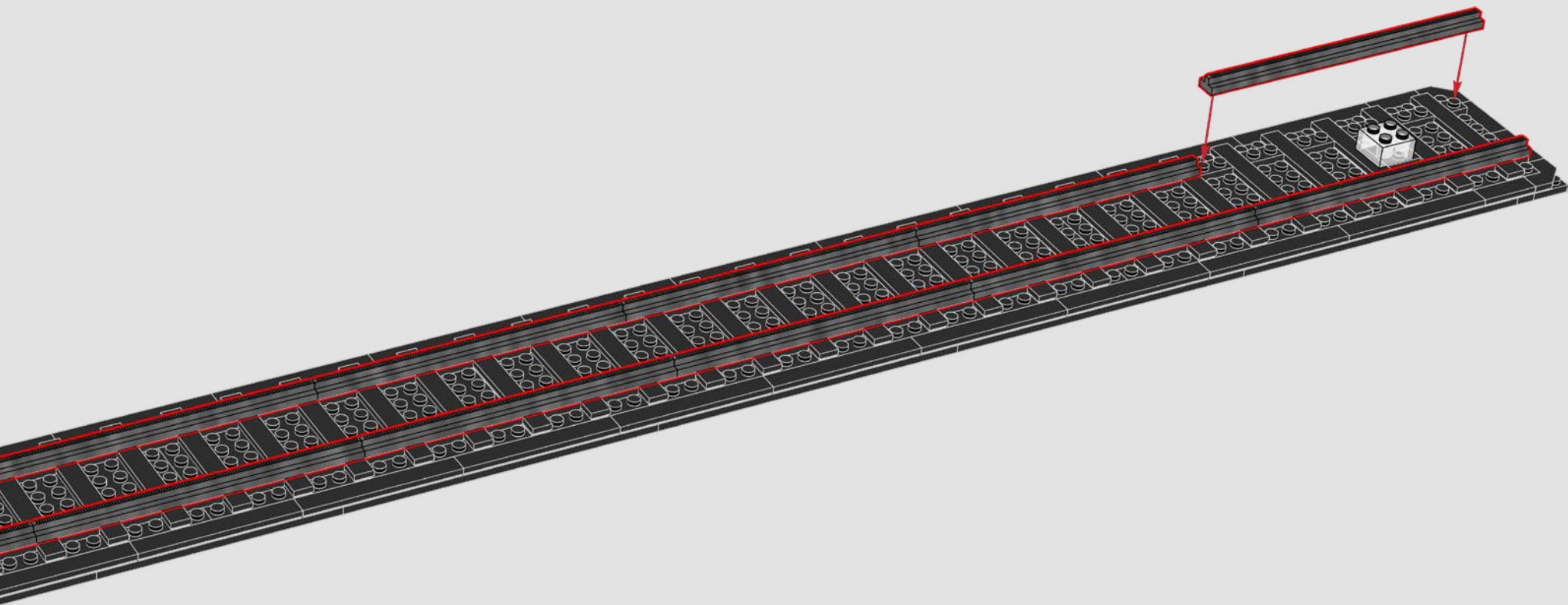

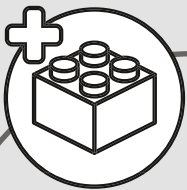

Partenza: PARIGI  
"Il viaggio è iniziato alla  
stazione Gare de l'Est...  
i passeggeri attendevano  
con ansia l'arrivo del treno".

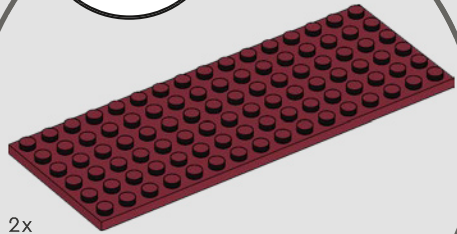

2x

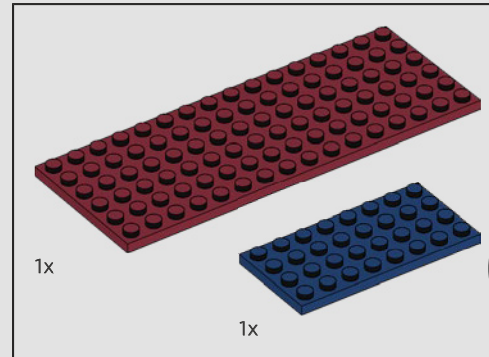
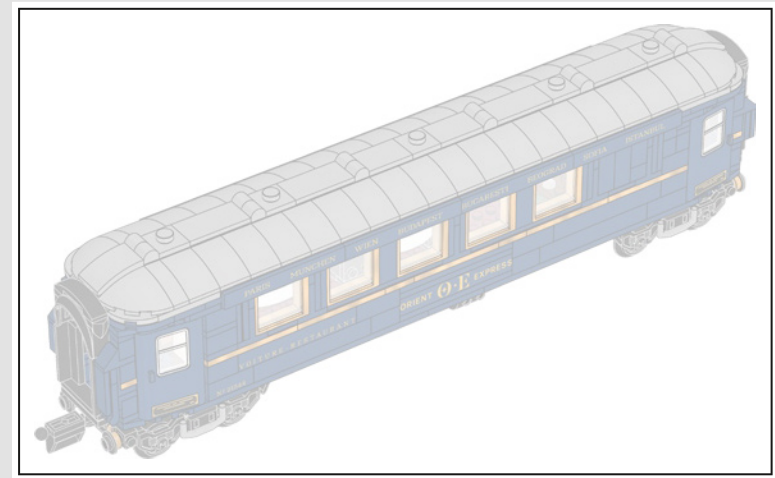
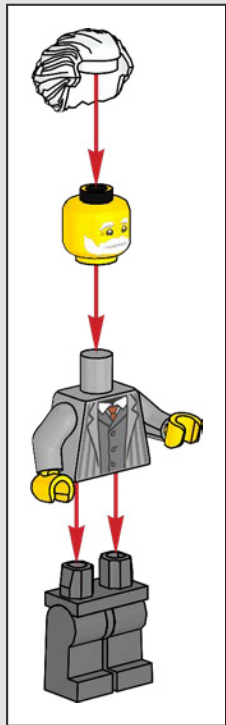

1x

1x

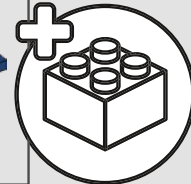

29

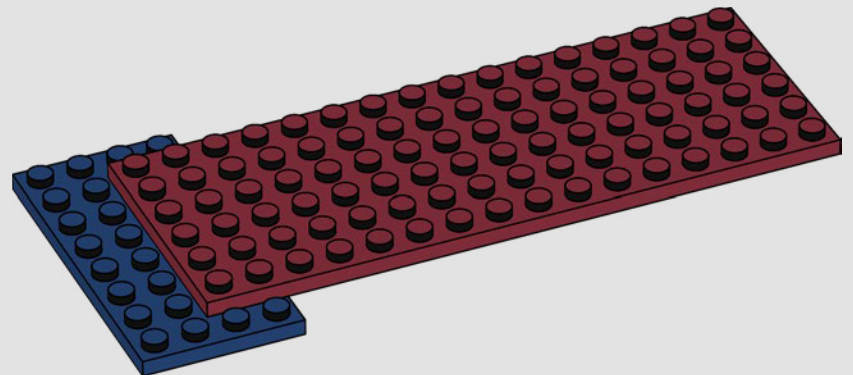



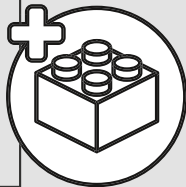
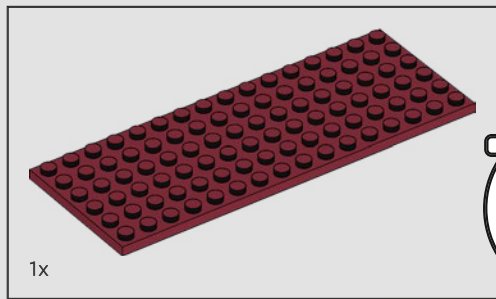

30

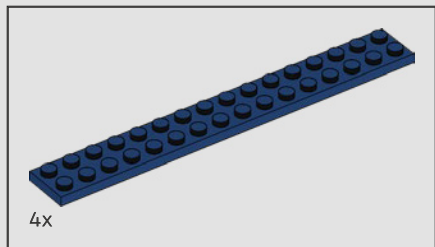
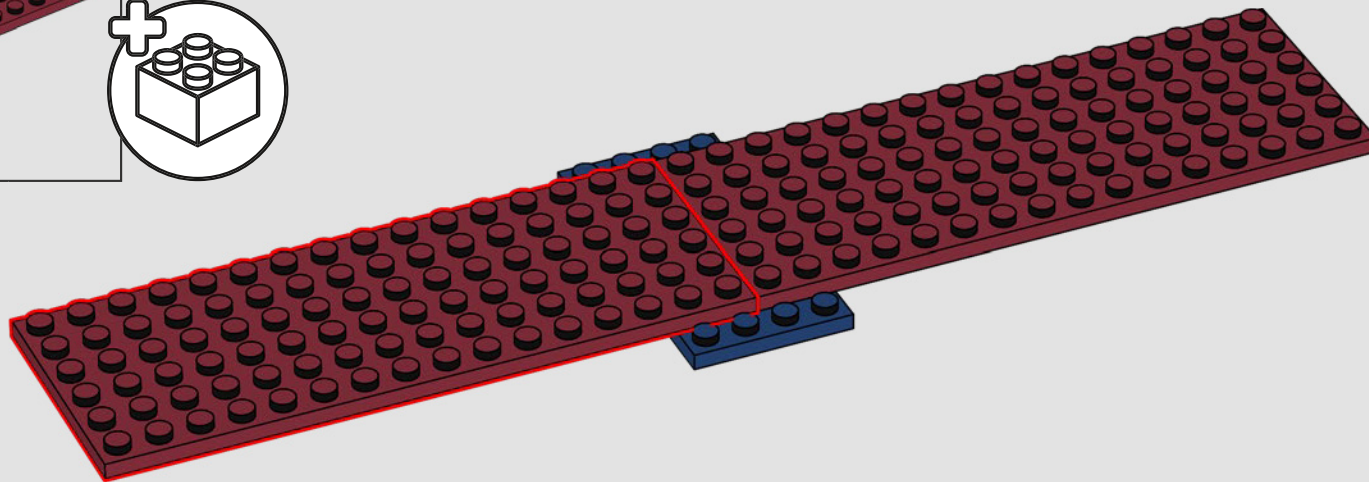

31

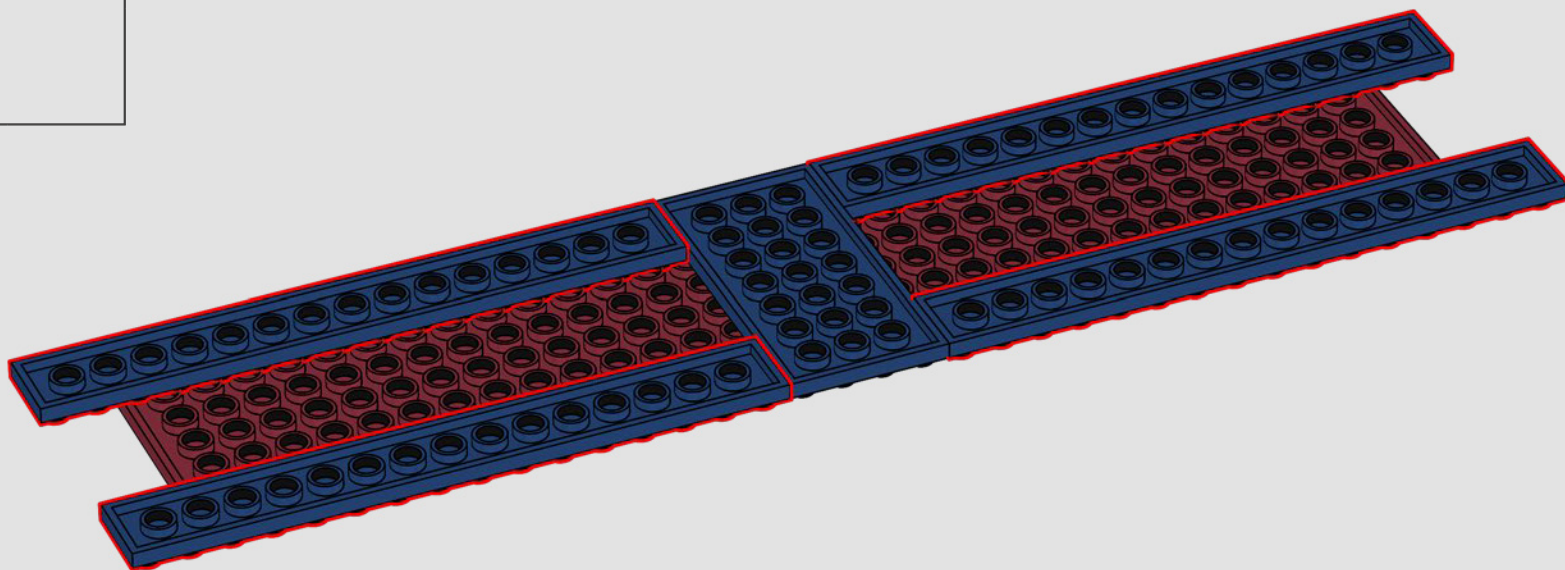

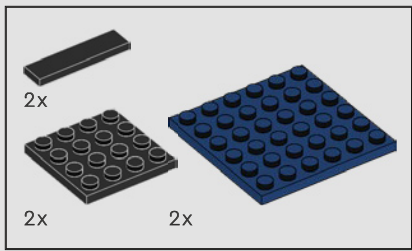

32

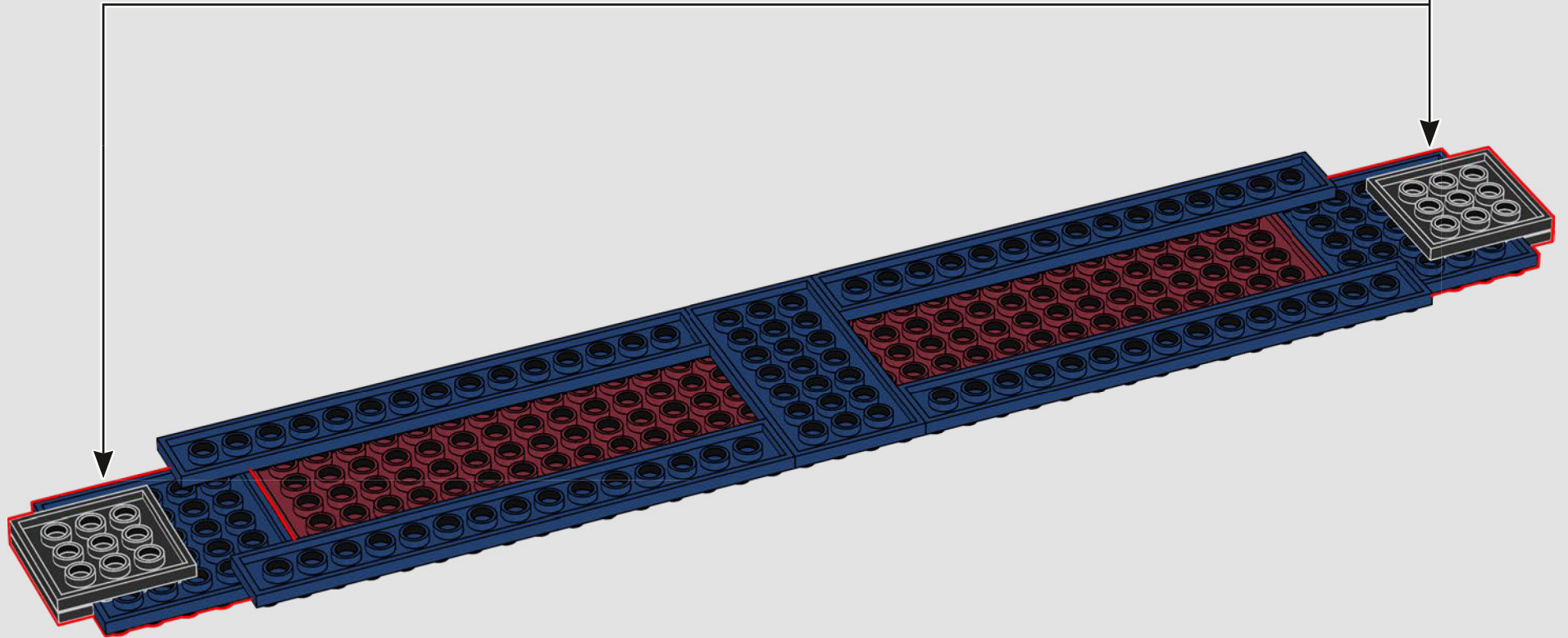
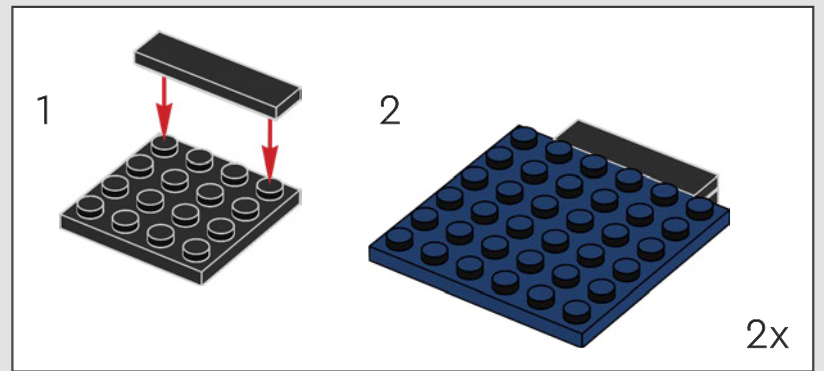



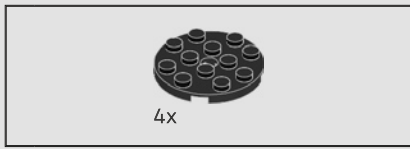

33

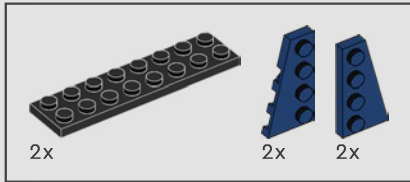
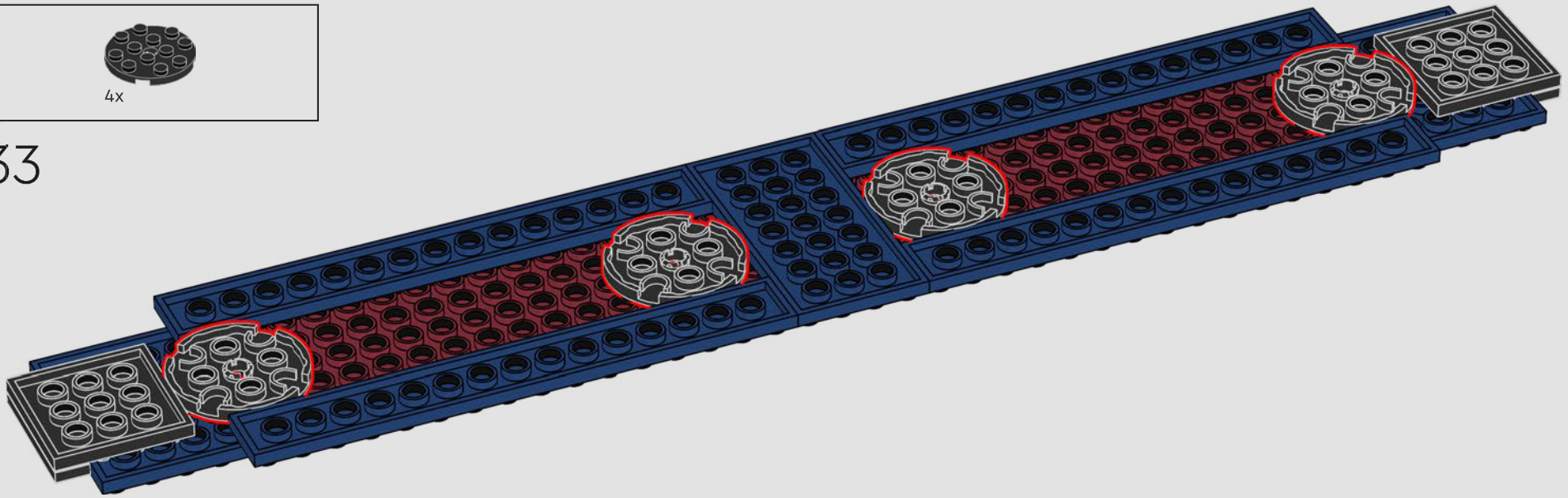

34







35

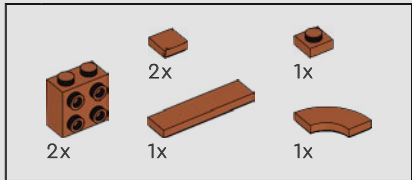
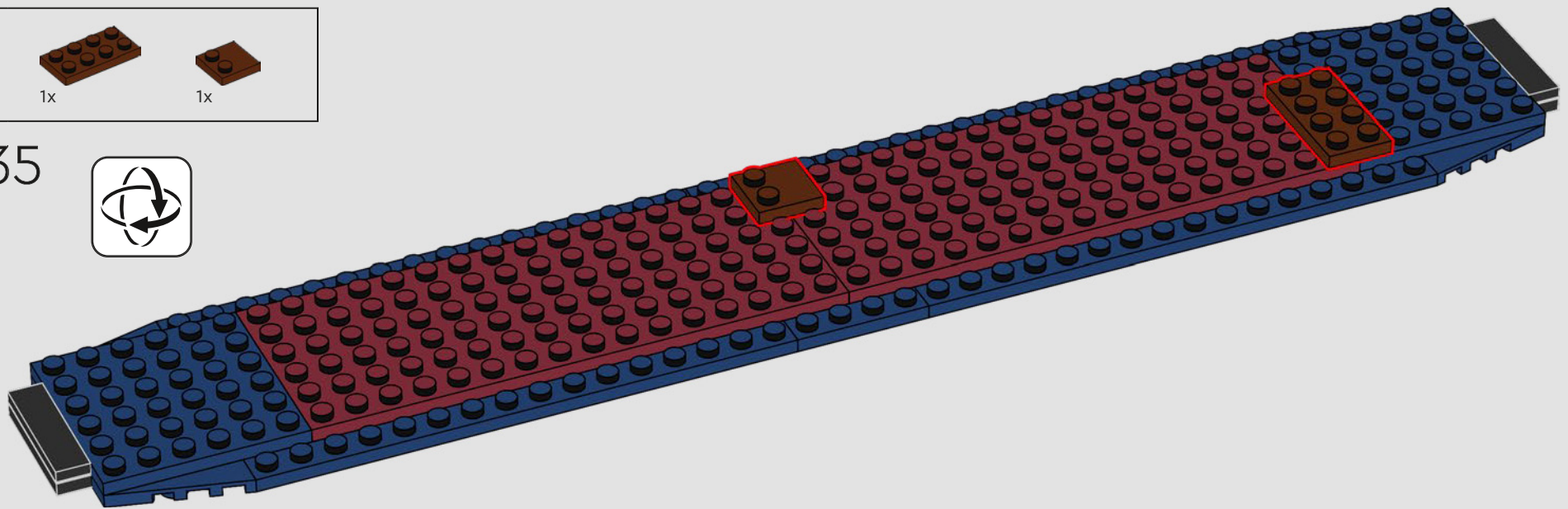

36

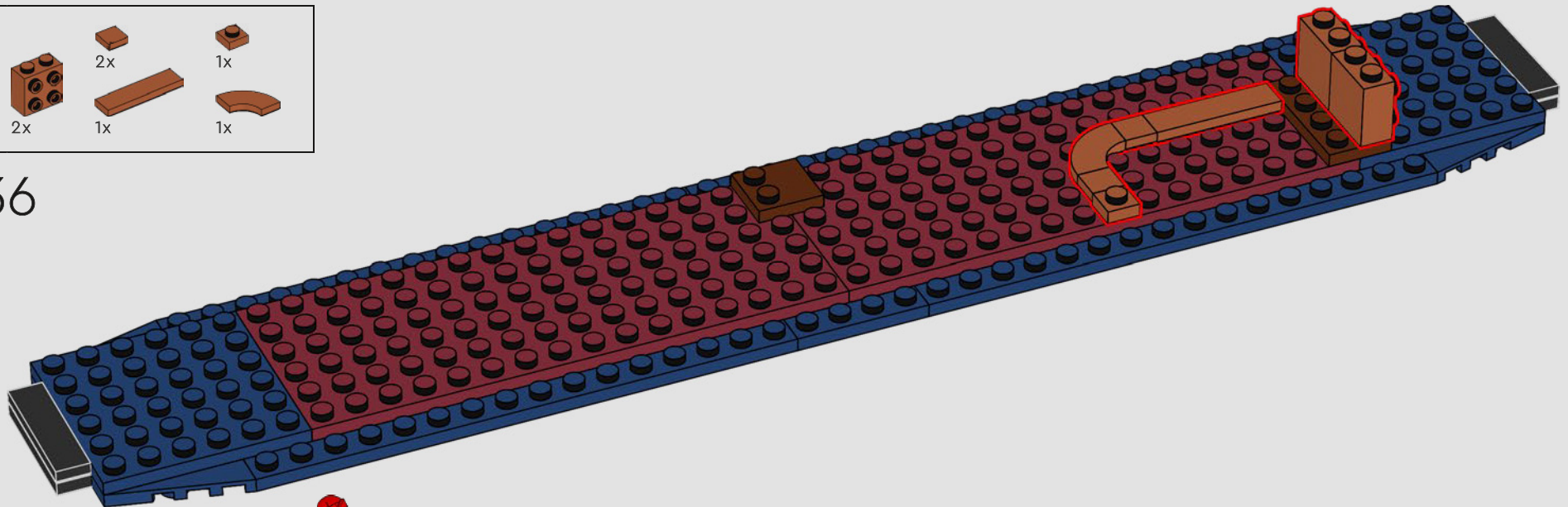





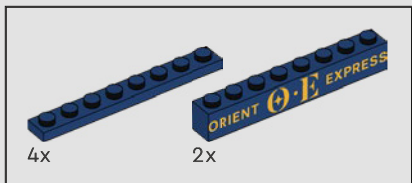

39

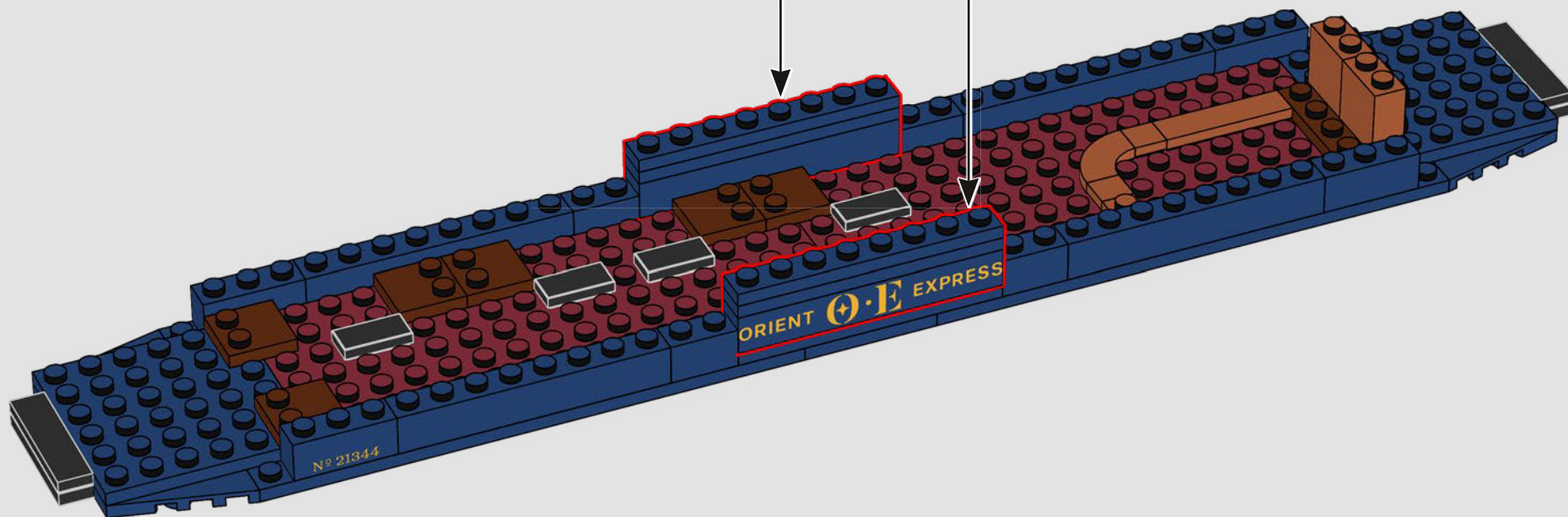
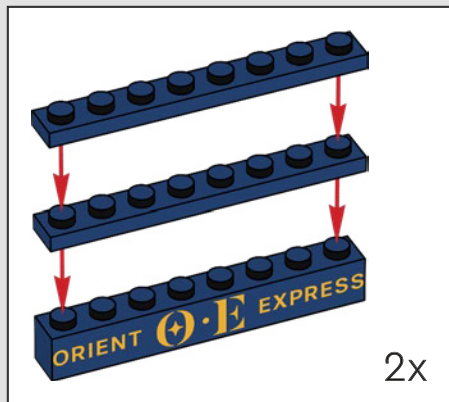



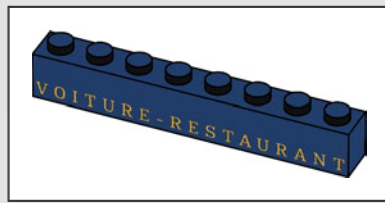
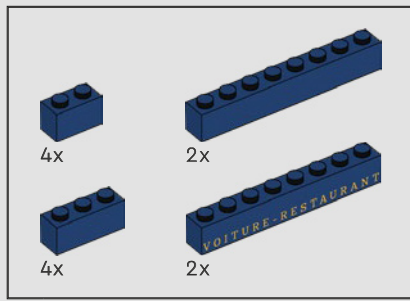

40

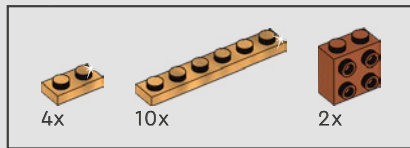
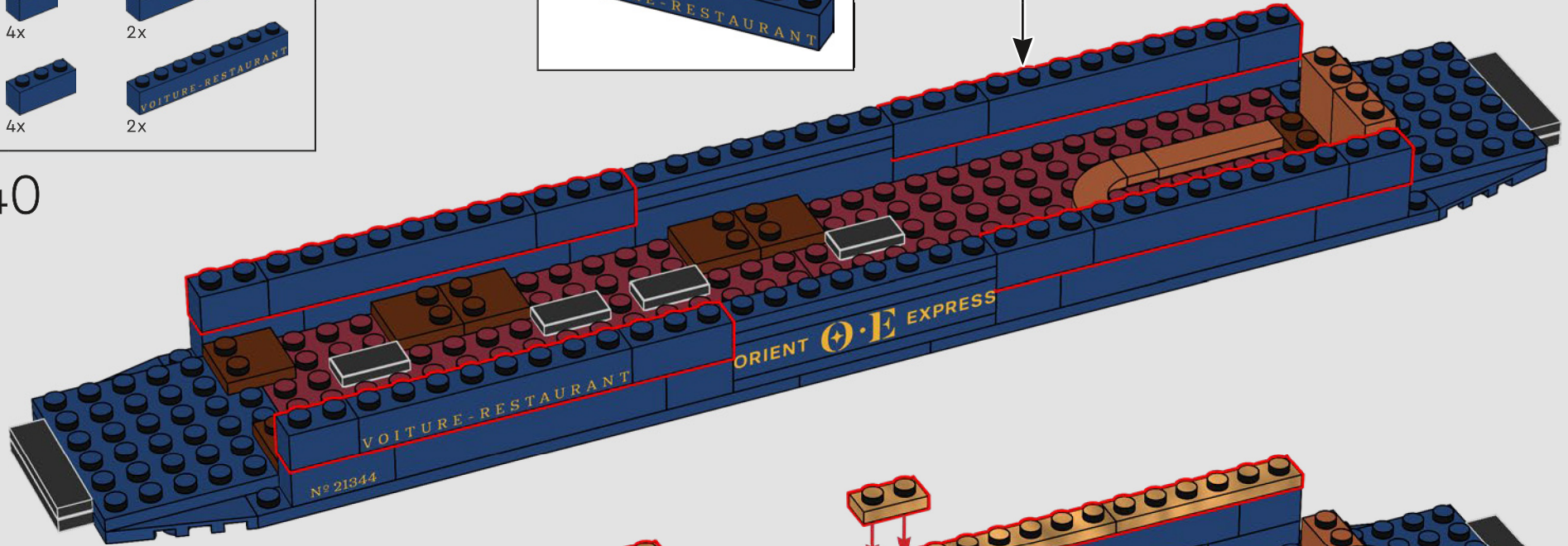

41

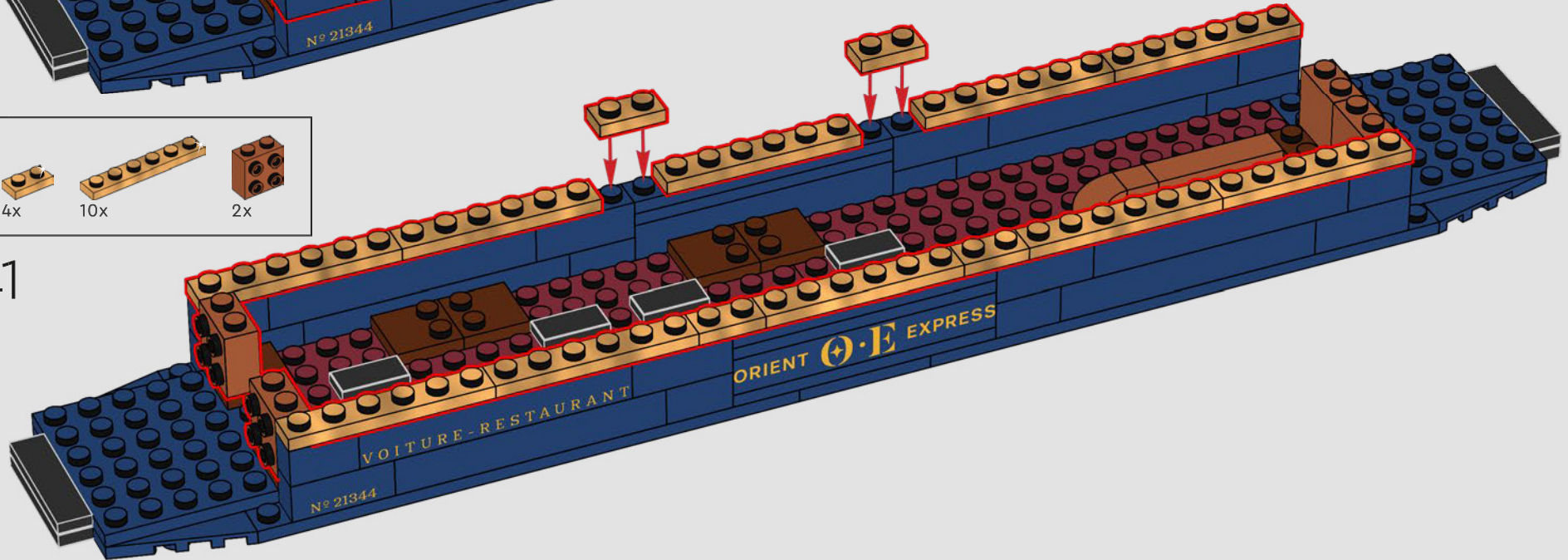



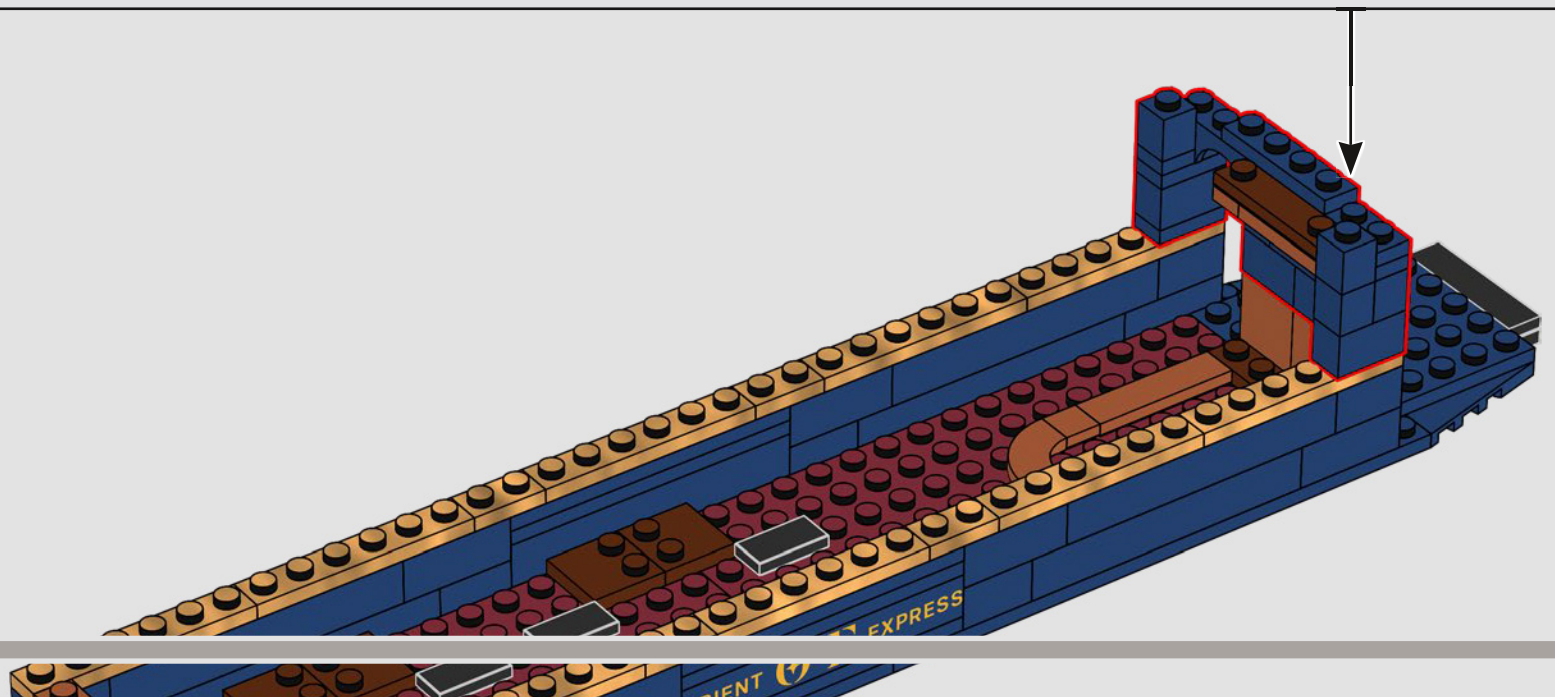
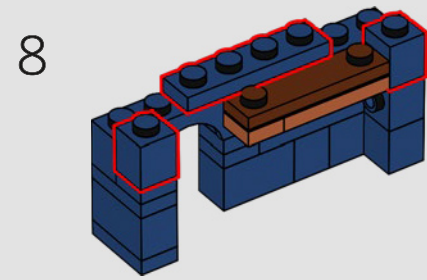
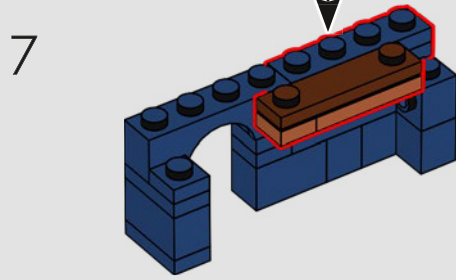
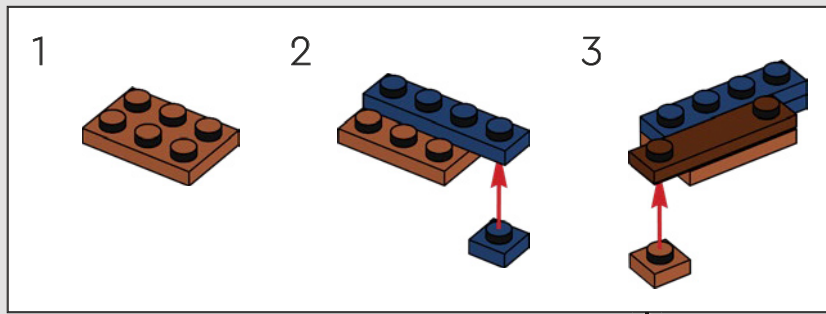



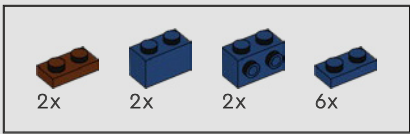

43

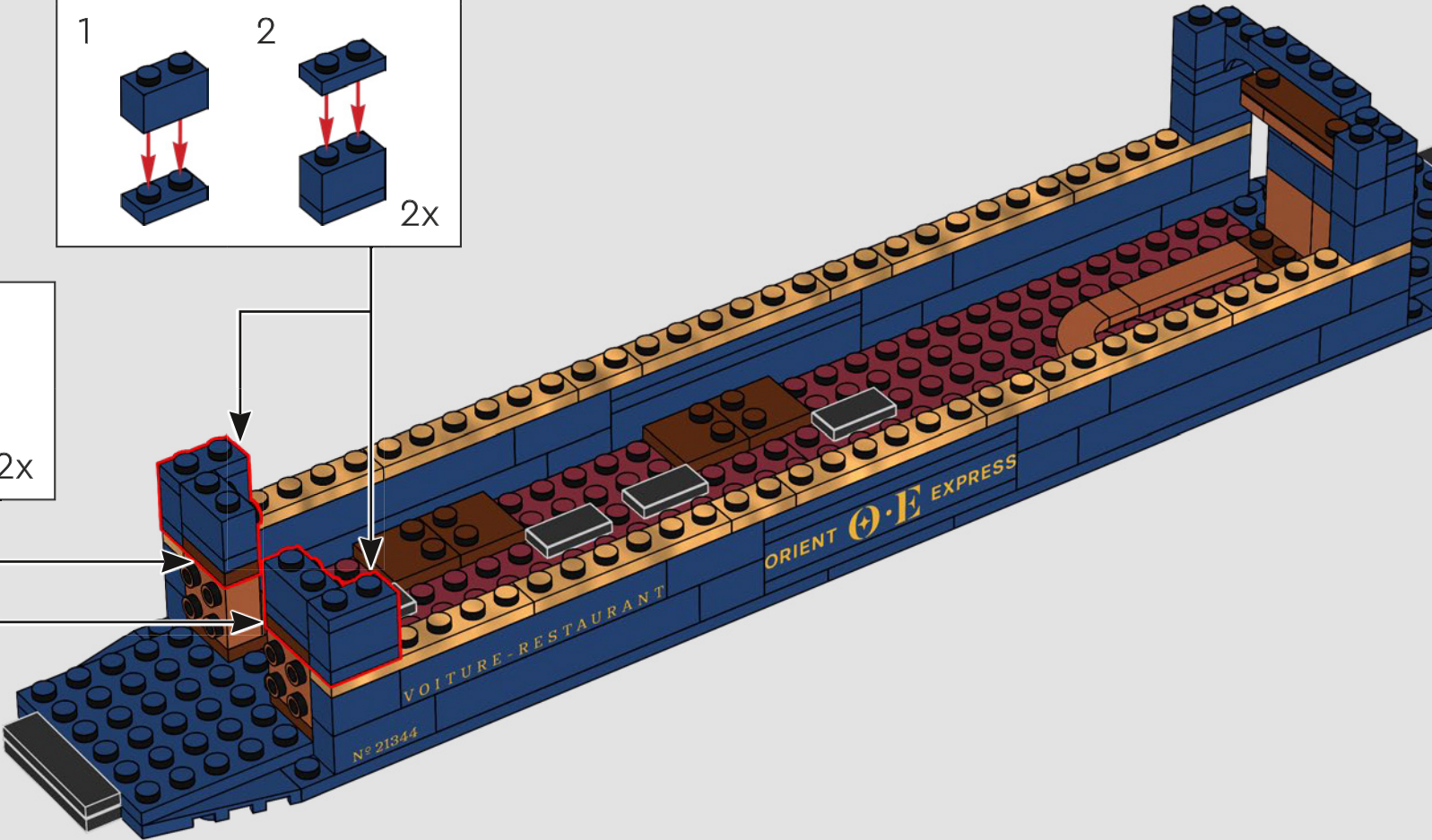
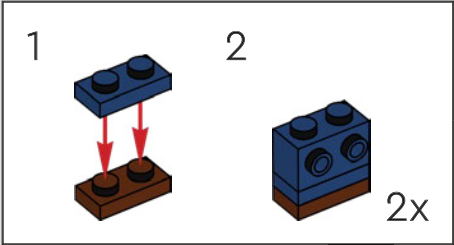
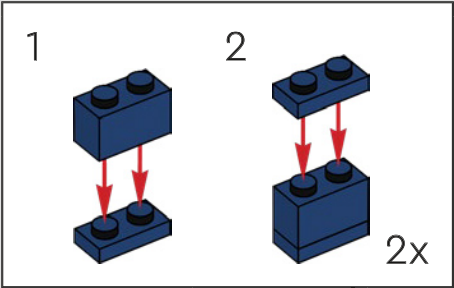

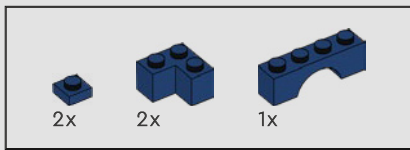

44

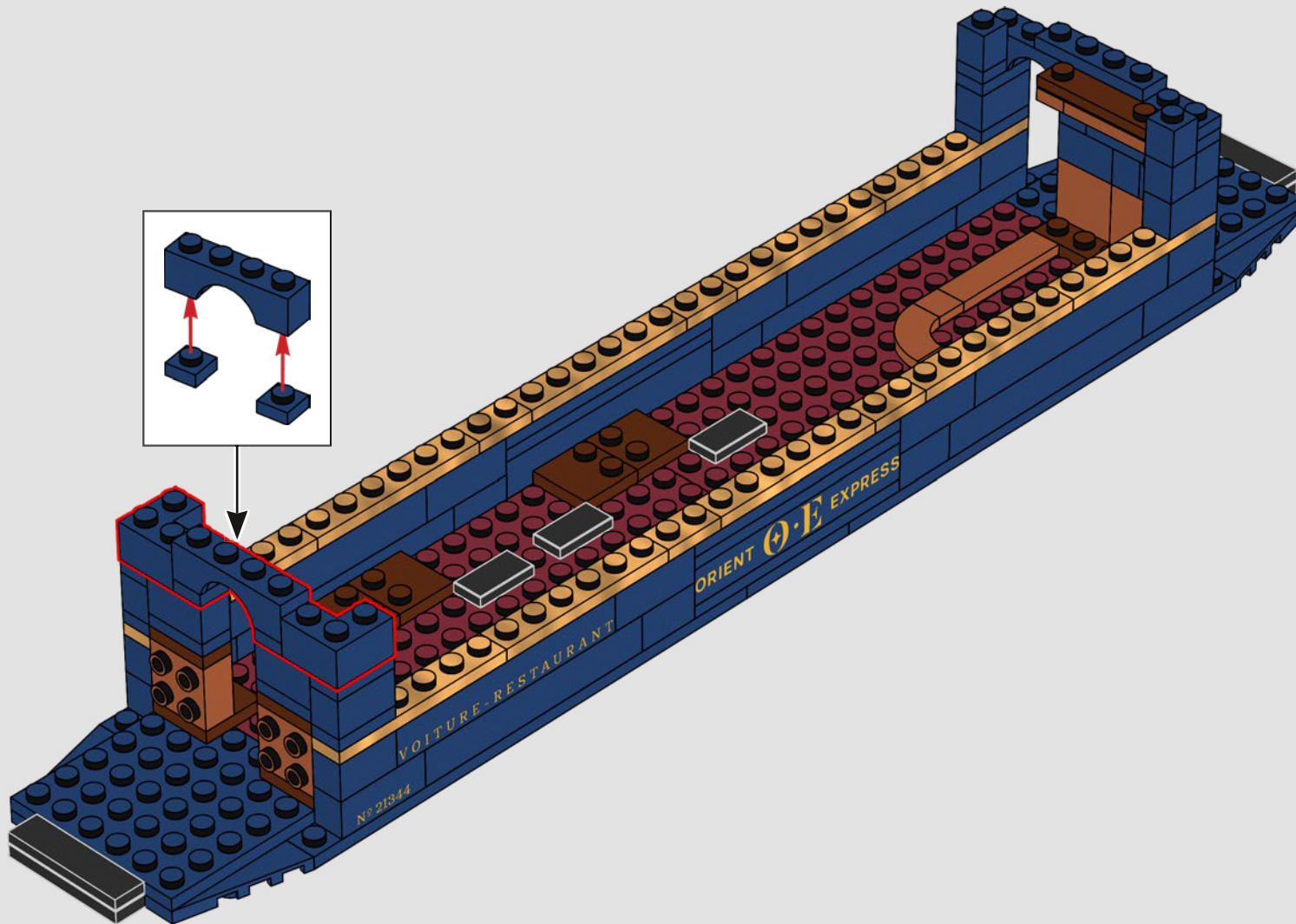

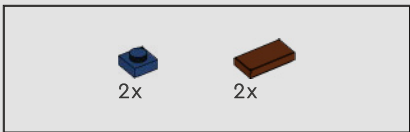

45

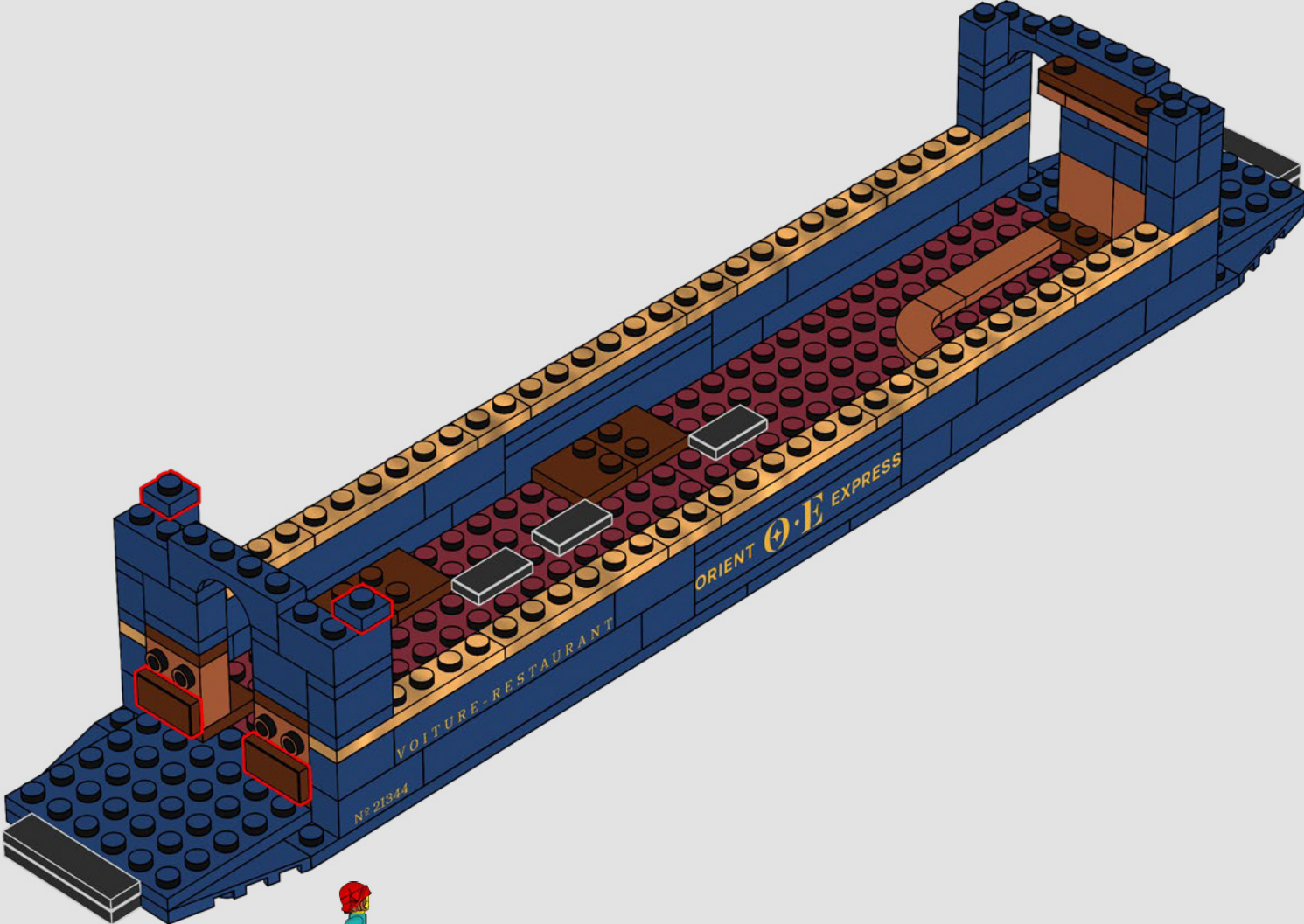



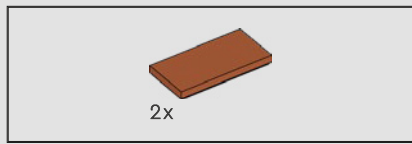

46

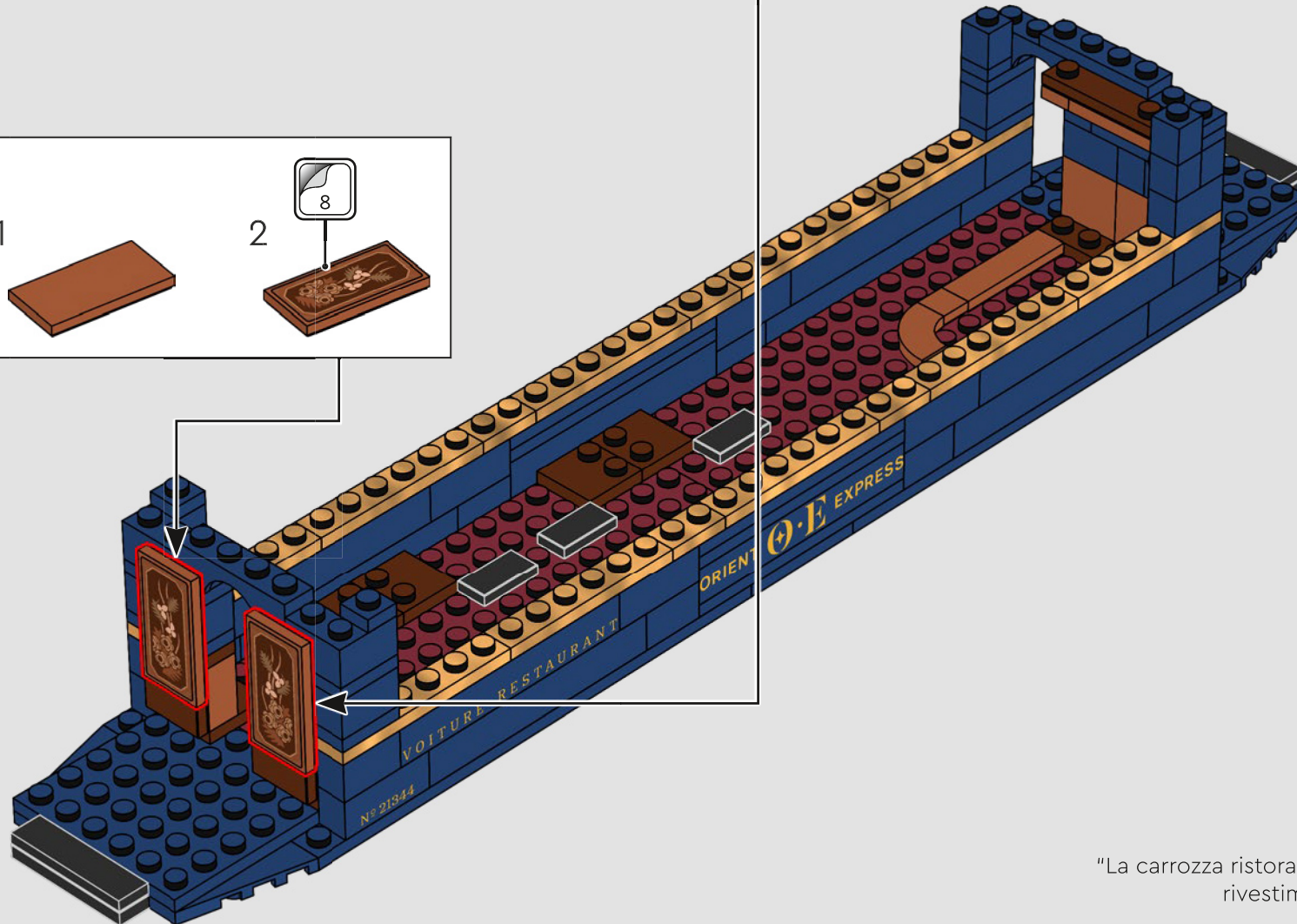
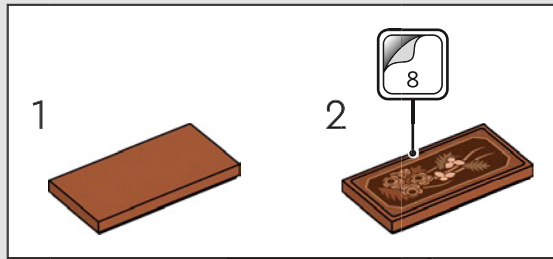
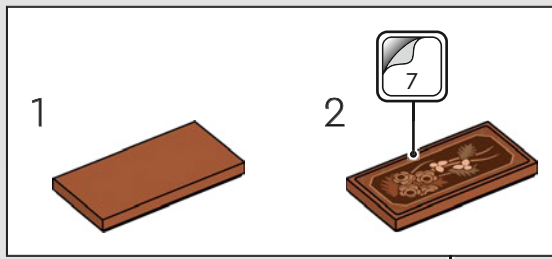

..... ●  
"La carrozza ristorante è decorata con splendidi rivestimenti in legno di fiori esotici".

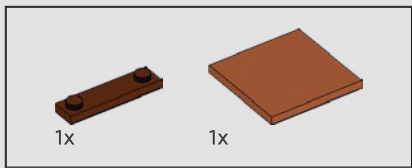

47

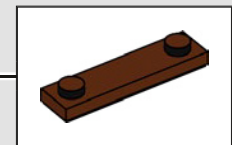
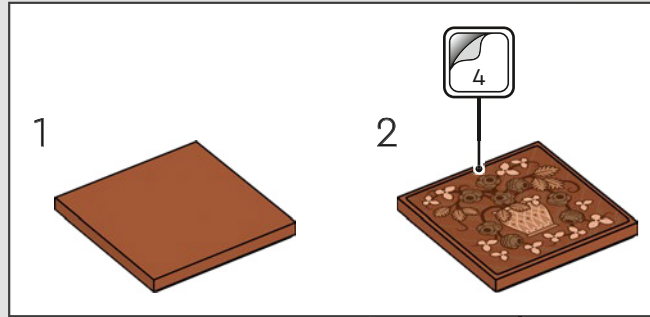
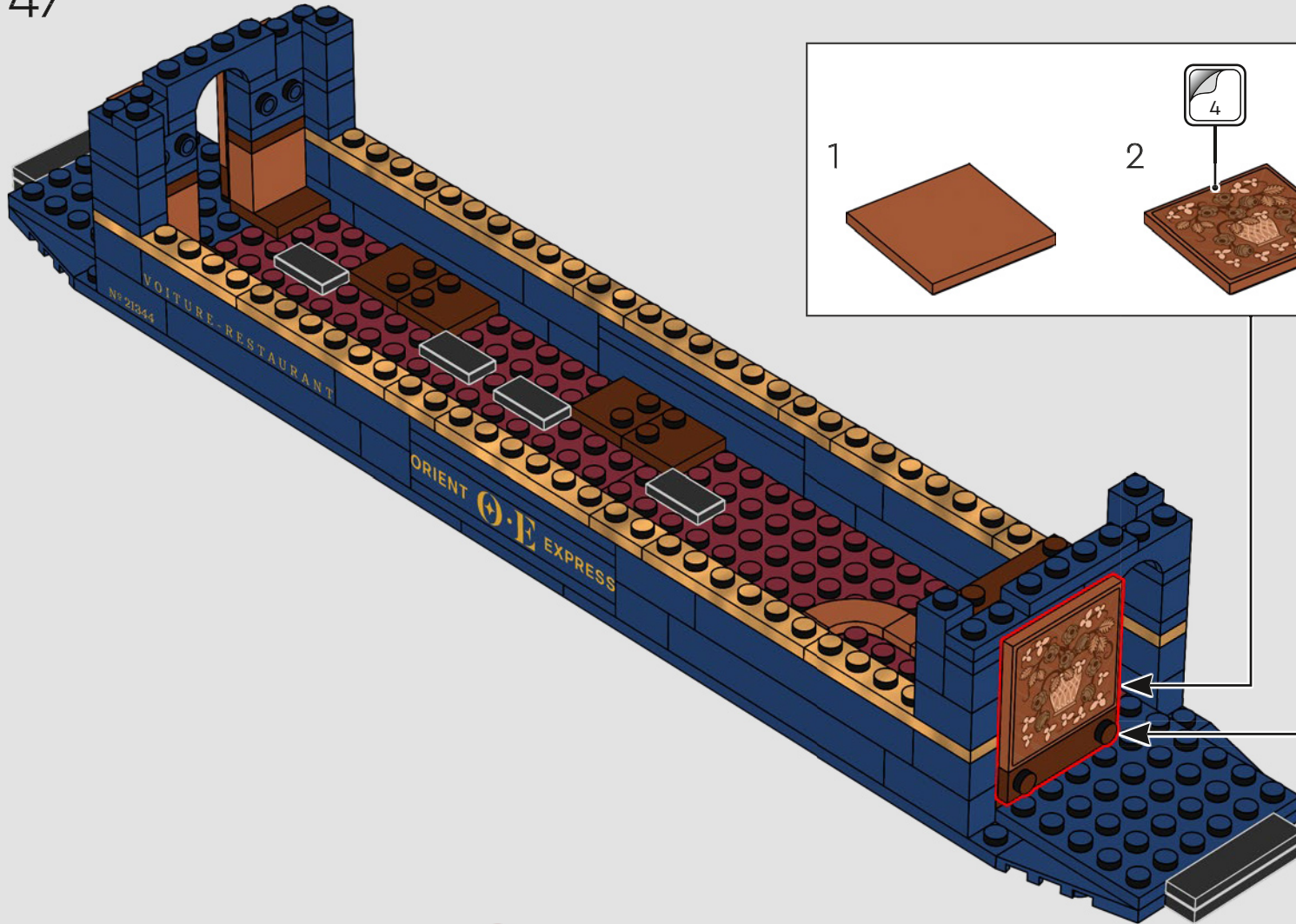





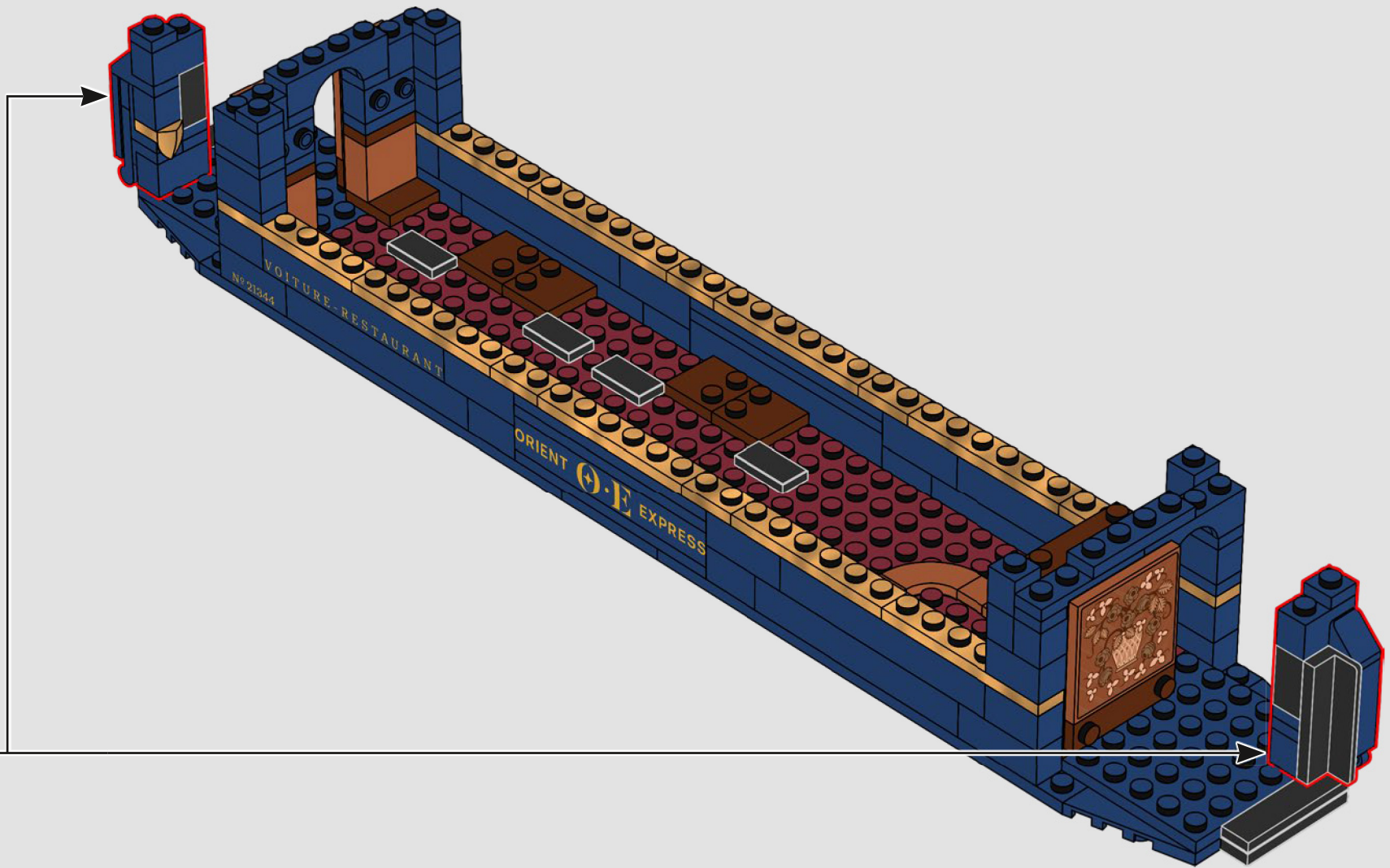

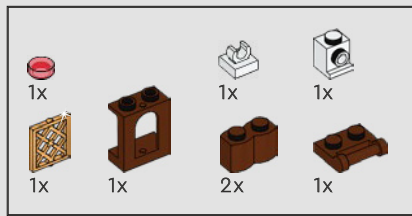

49

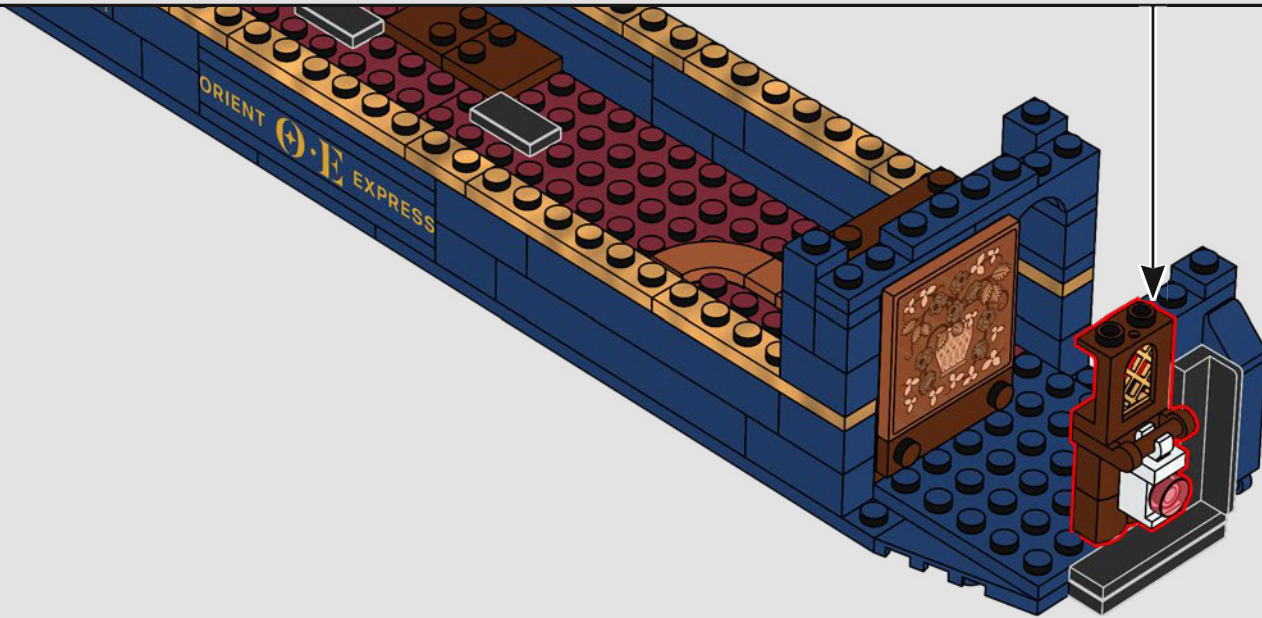
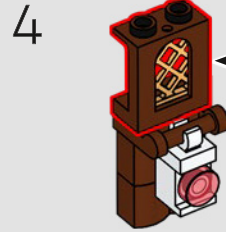
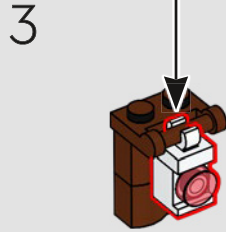
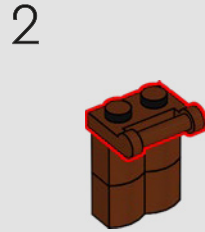
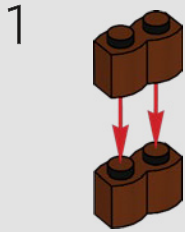
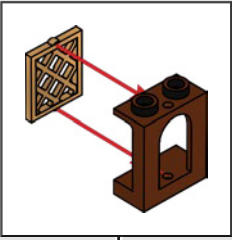
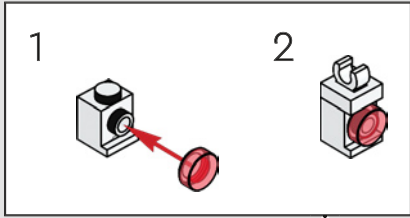



2x



2x



4x



2x



4x



2x



4x



2x



2x



2x



2x

50

1

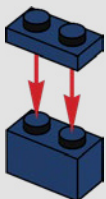

2

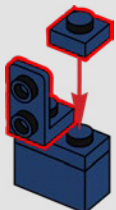

3



4

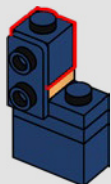

5

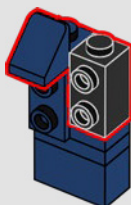

6

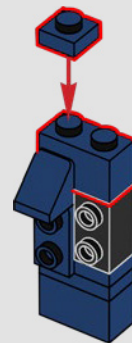

7

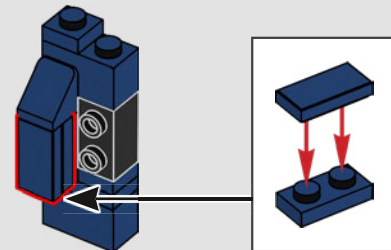

8

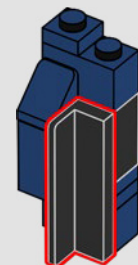

2x





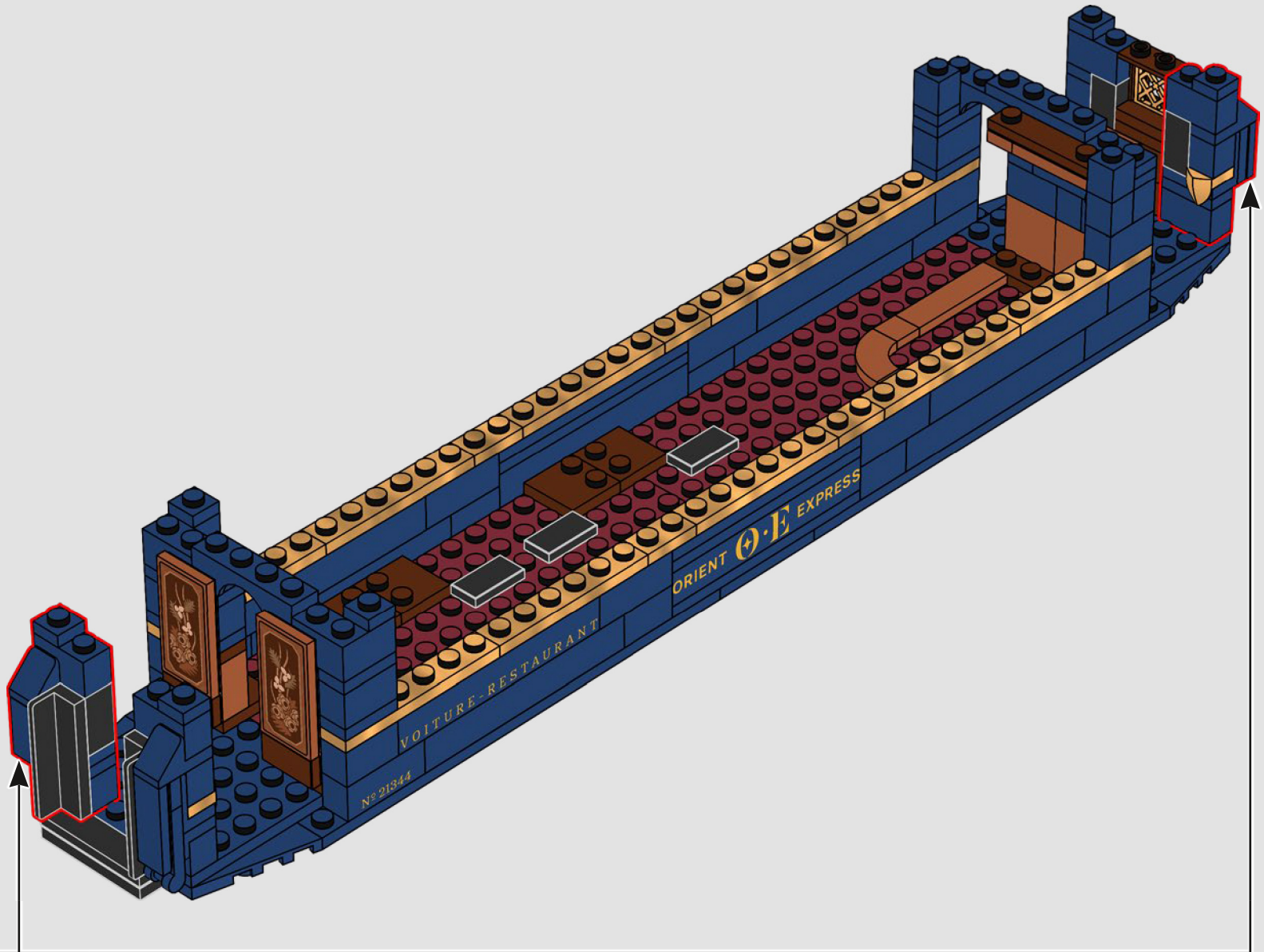

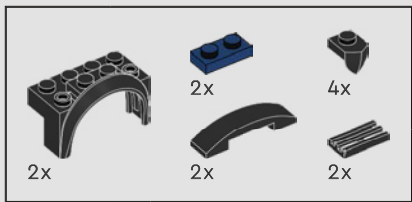

51

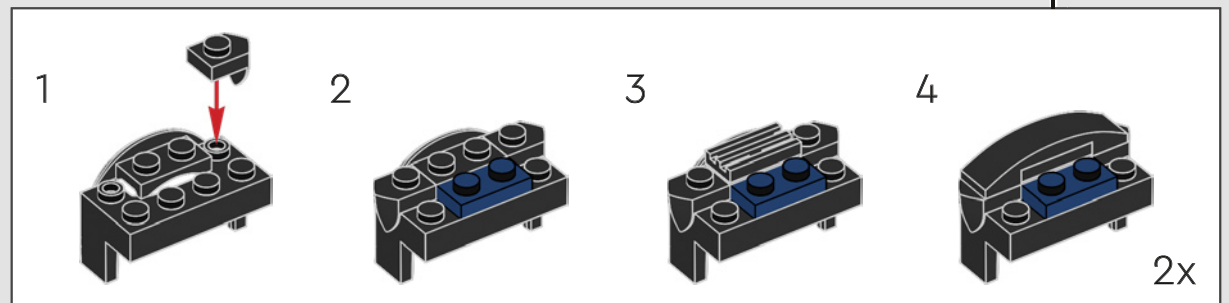
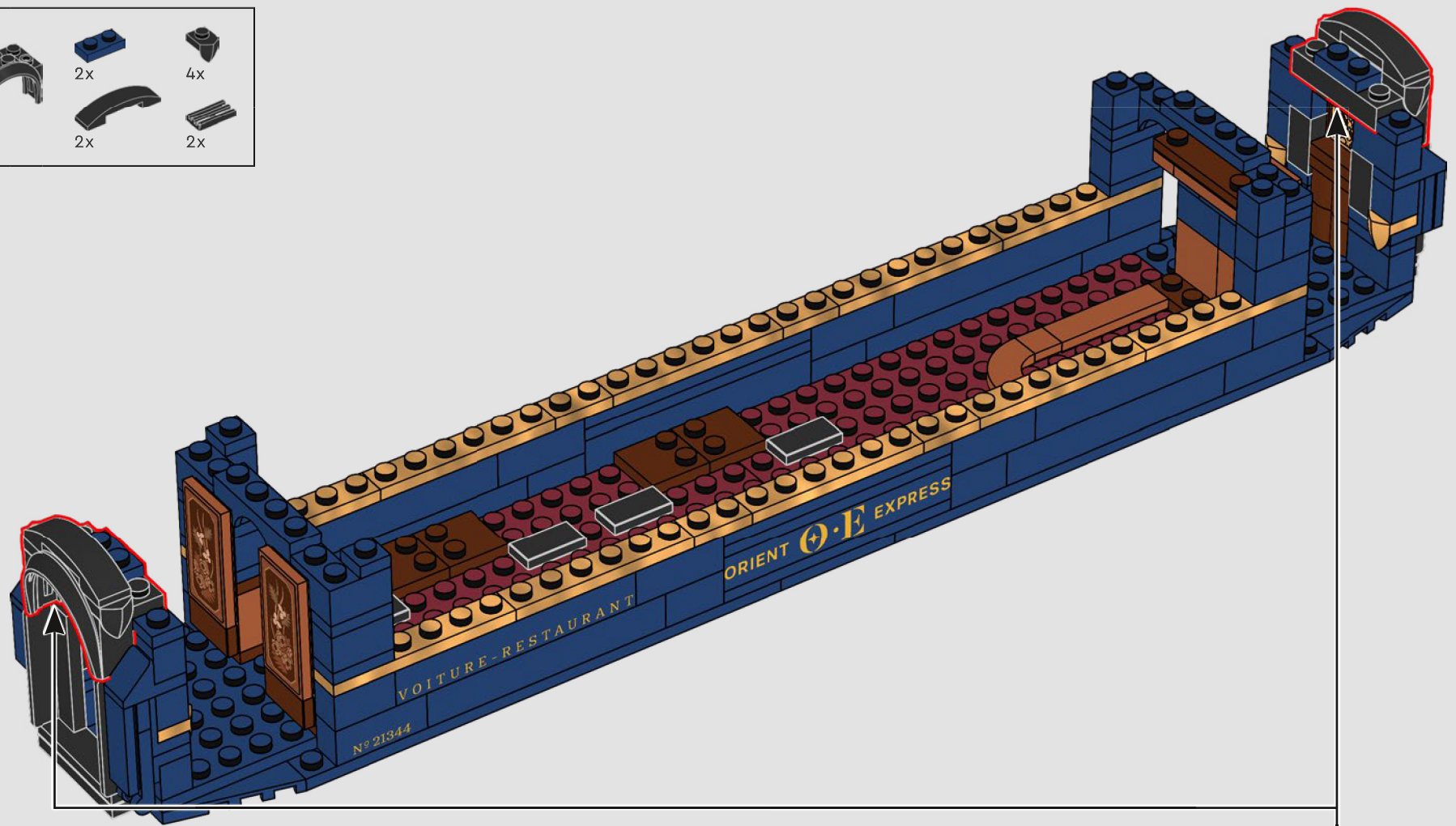



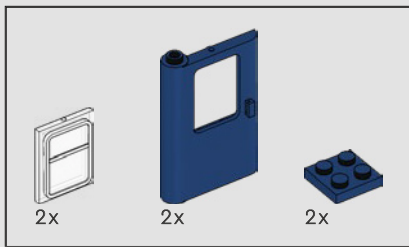

52

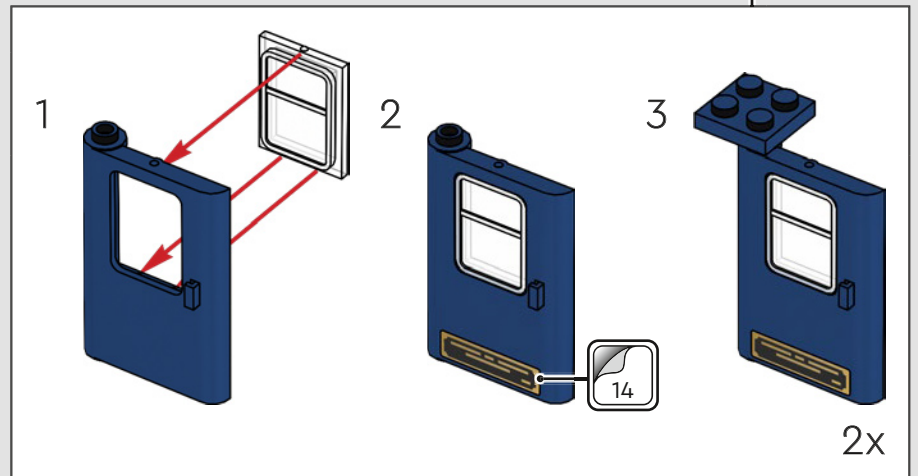
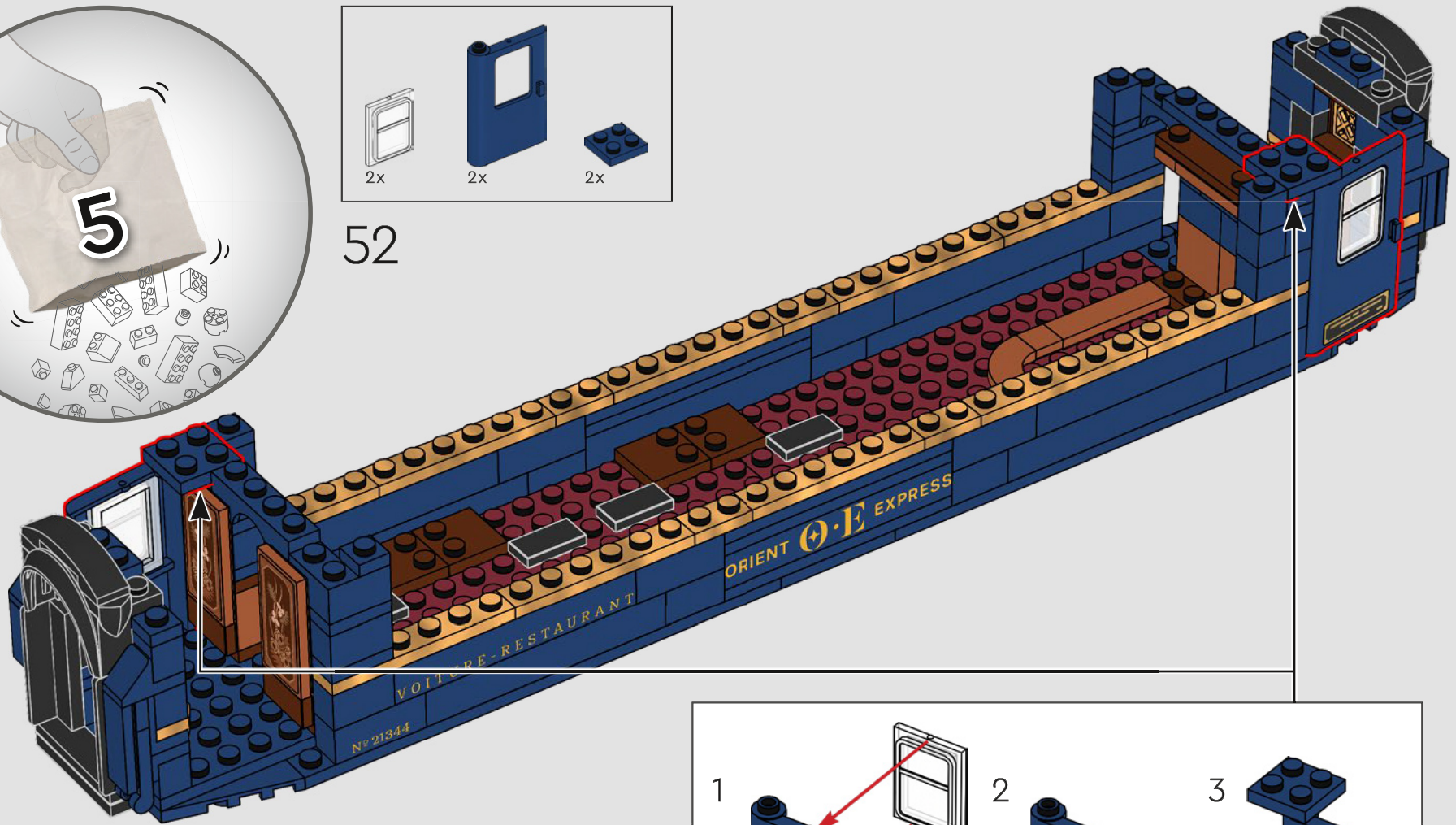



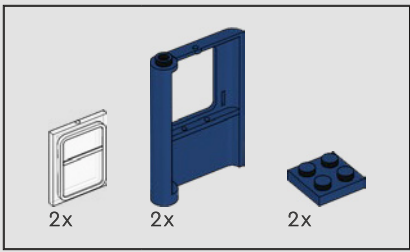

53

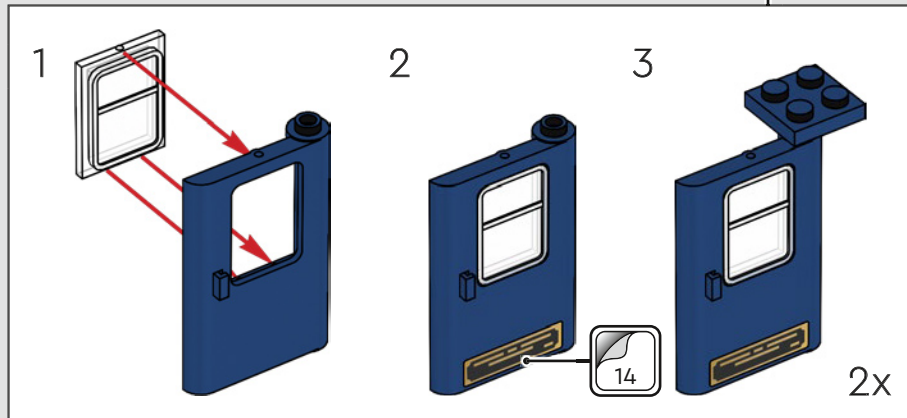
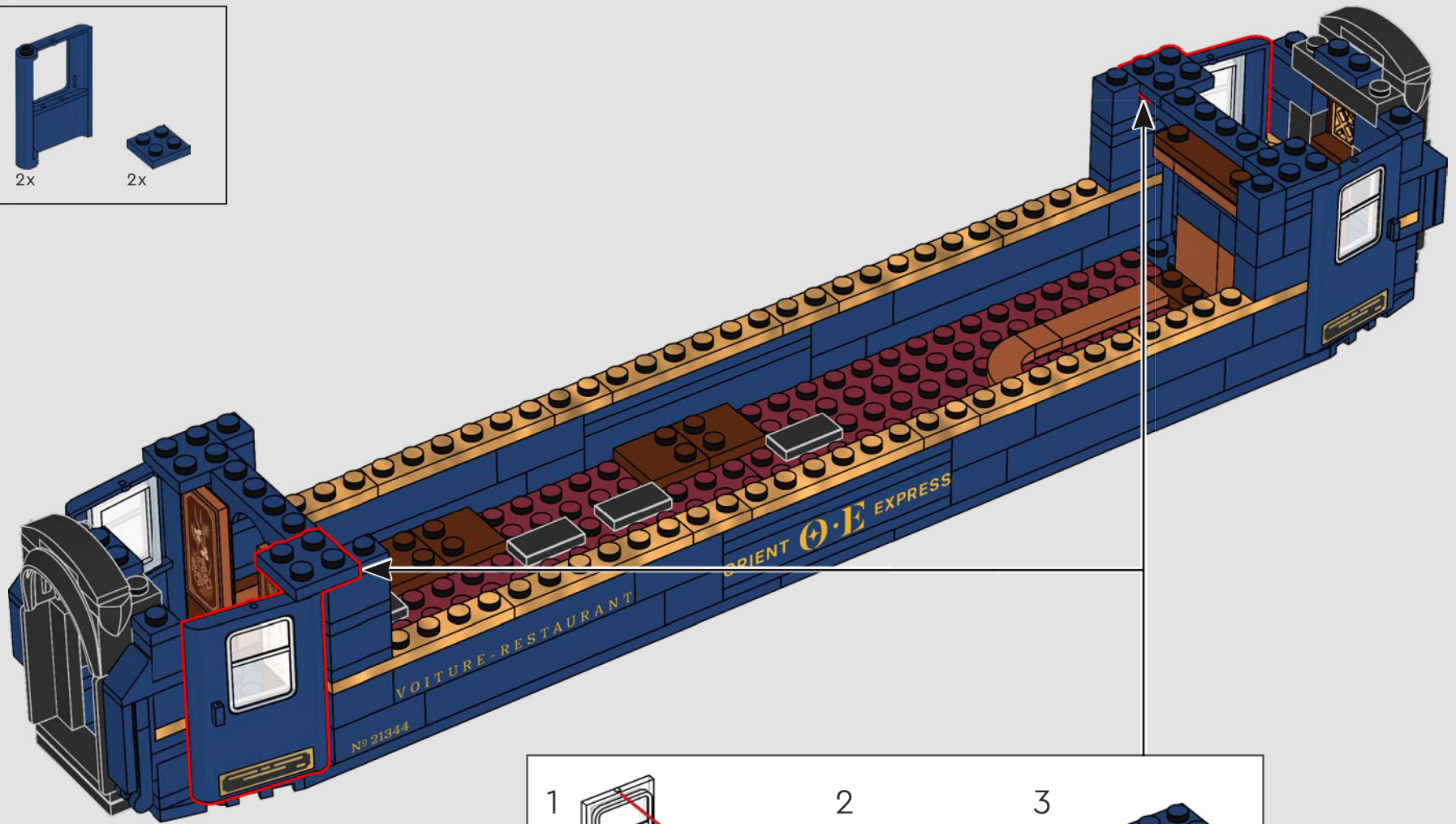

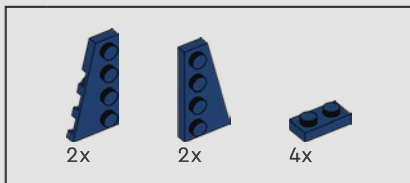

54

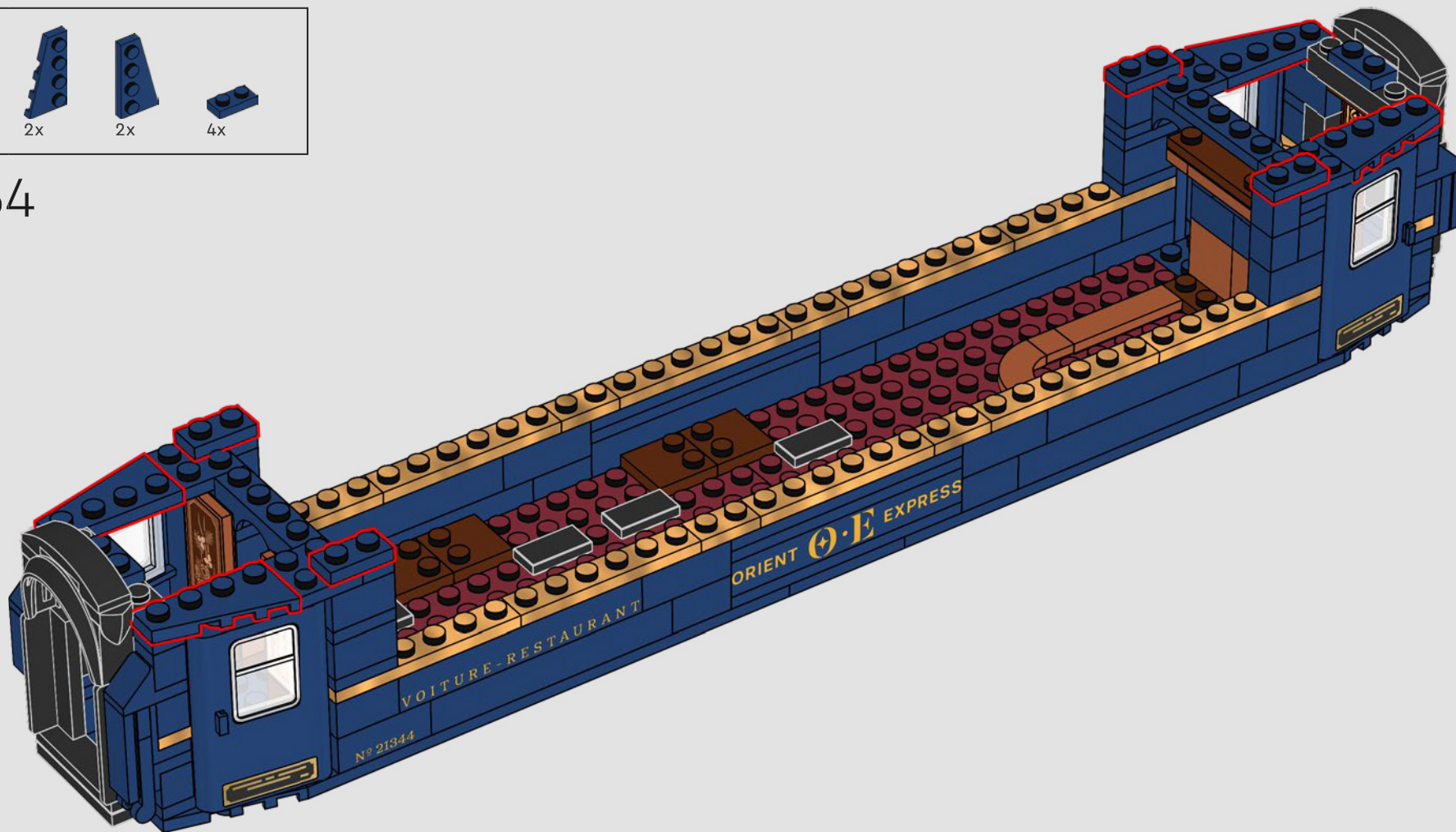

..... ●  
"Ogni porta presenta una targhetta in ottone  
del produttore, un segno di qualità!"

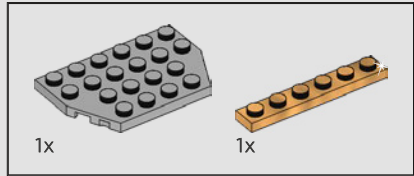
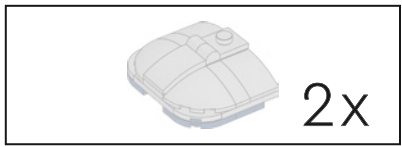

55

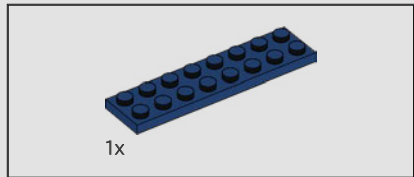
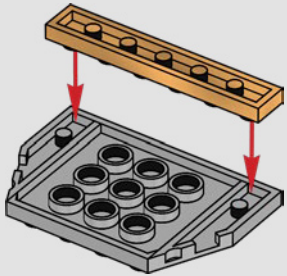

56

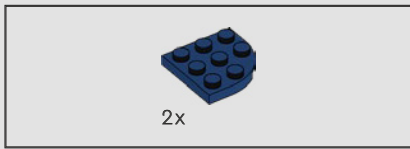
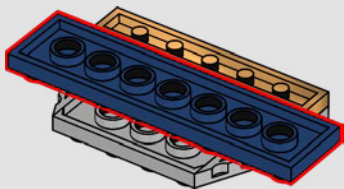

57

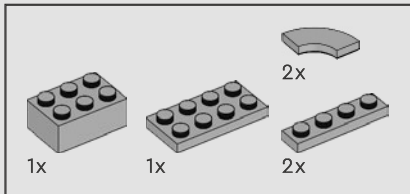
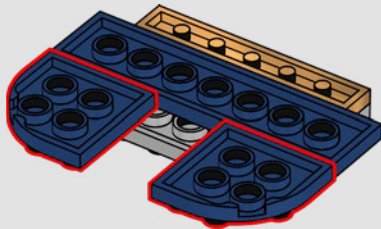

58

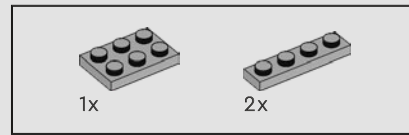
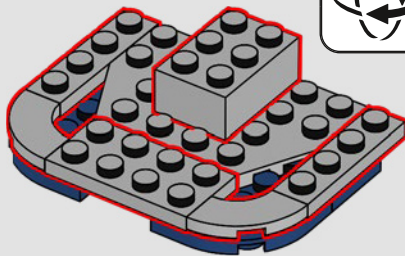

59

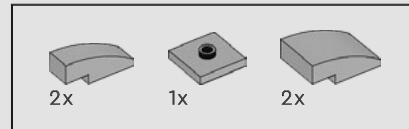
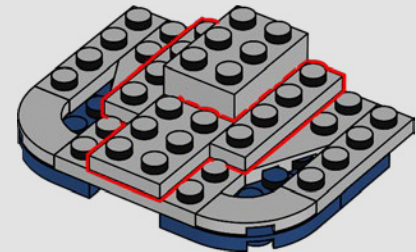

60

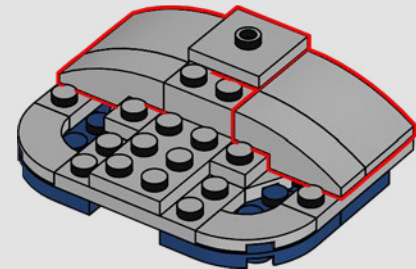



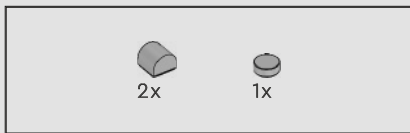

61

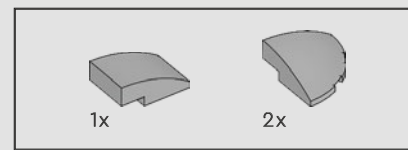
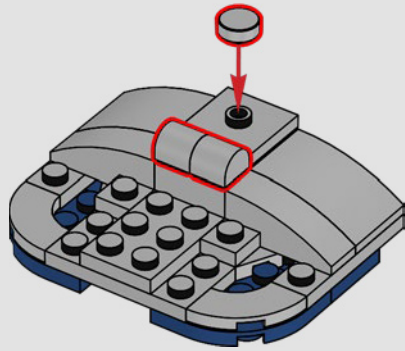

62

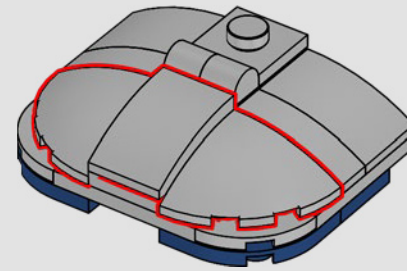

2x

63

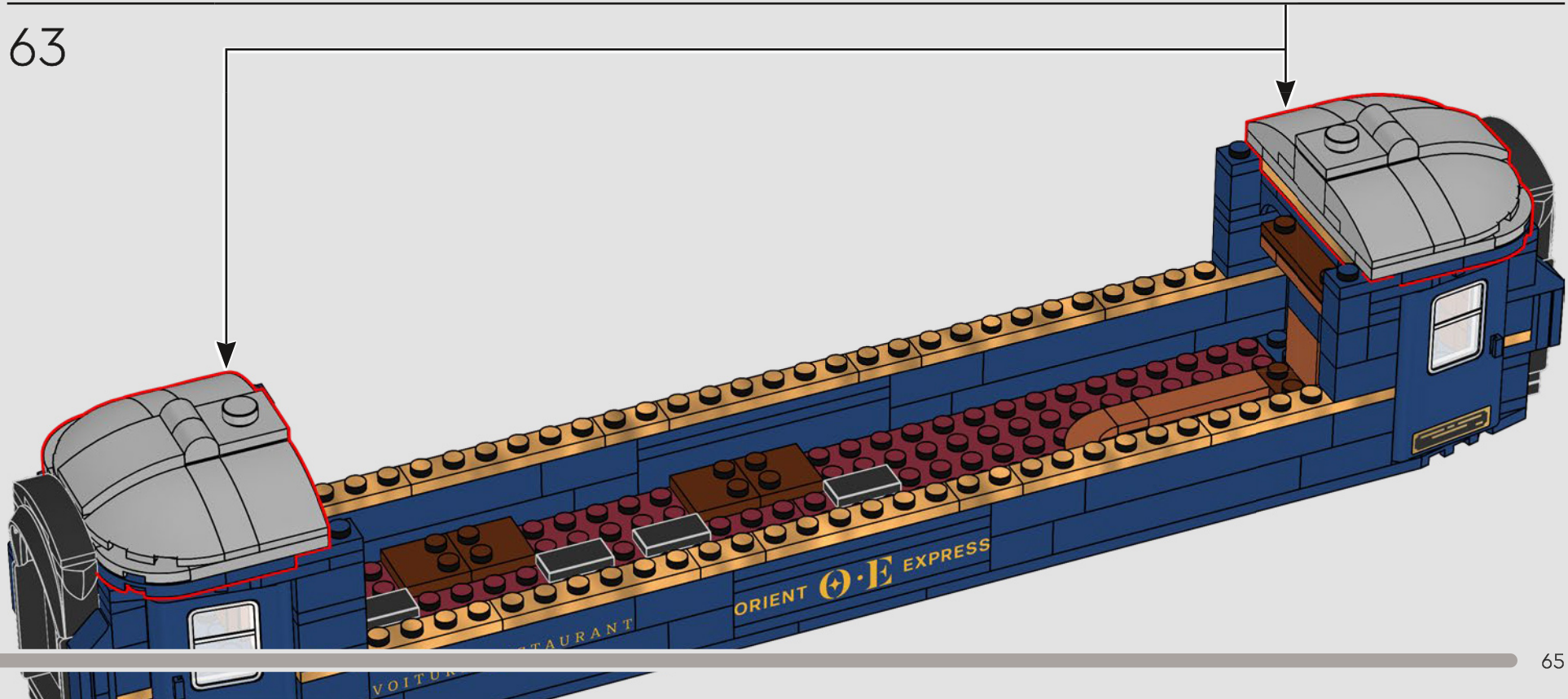

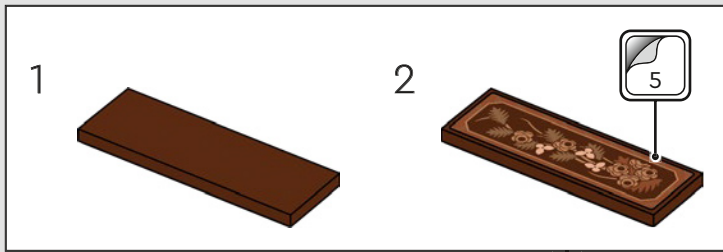
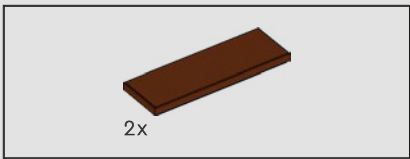

64

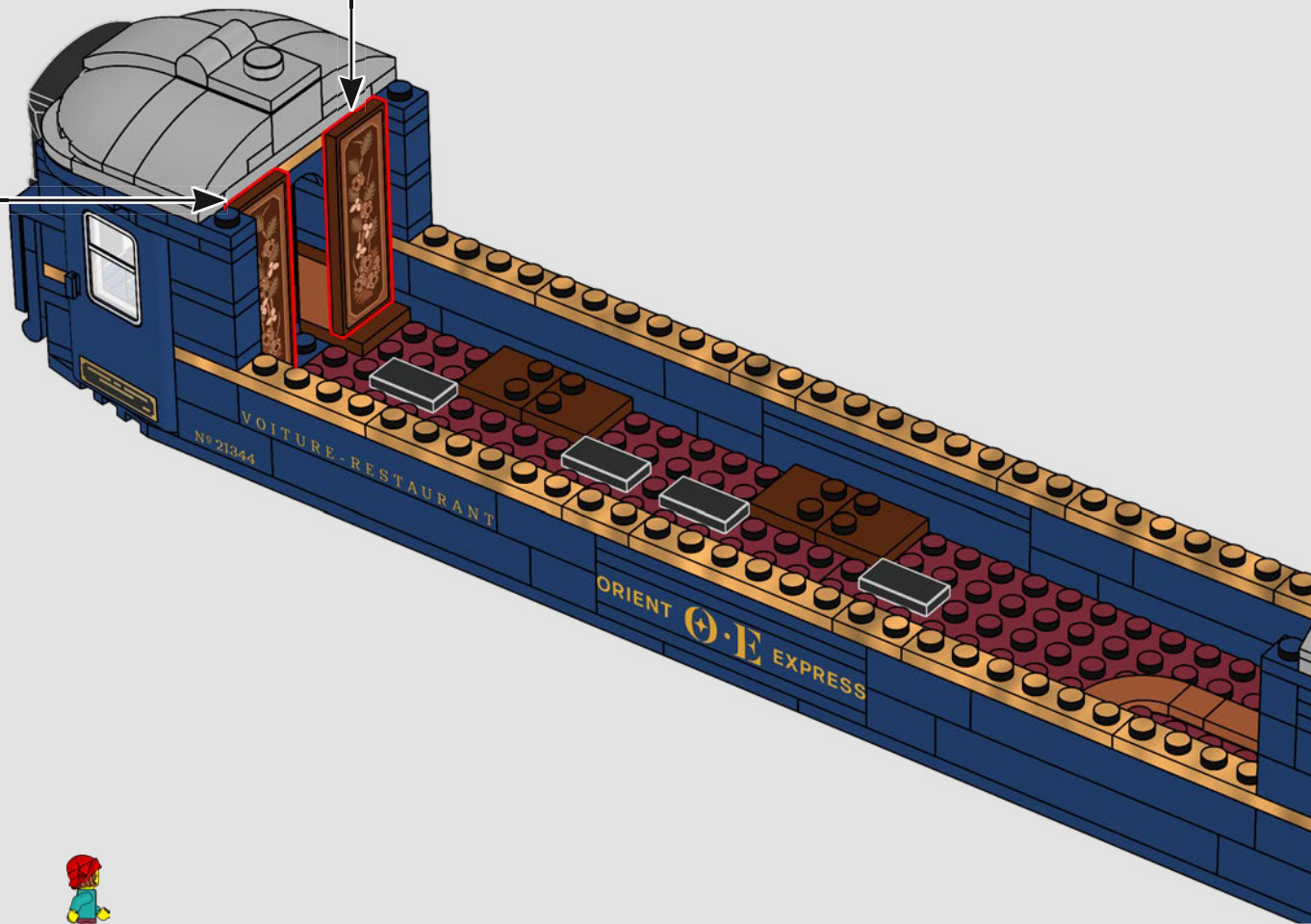
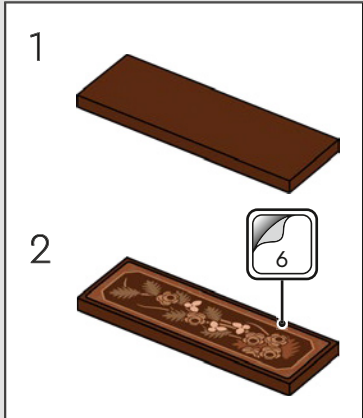





2



3

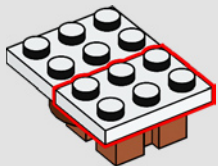

4

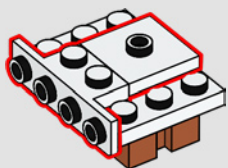

5

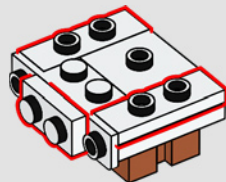

6

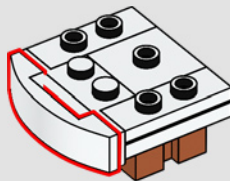

7

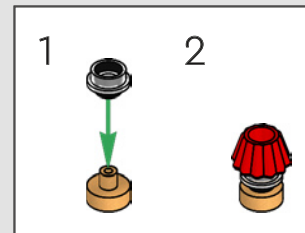
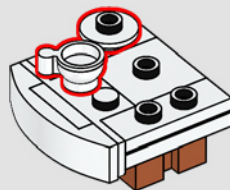

8



9

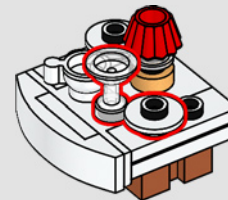

2x



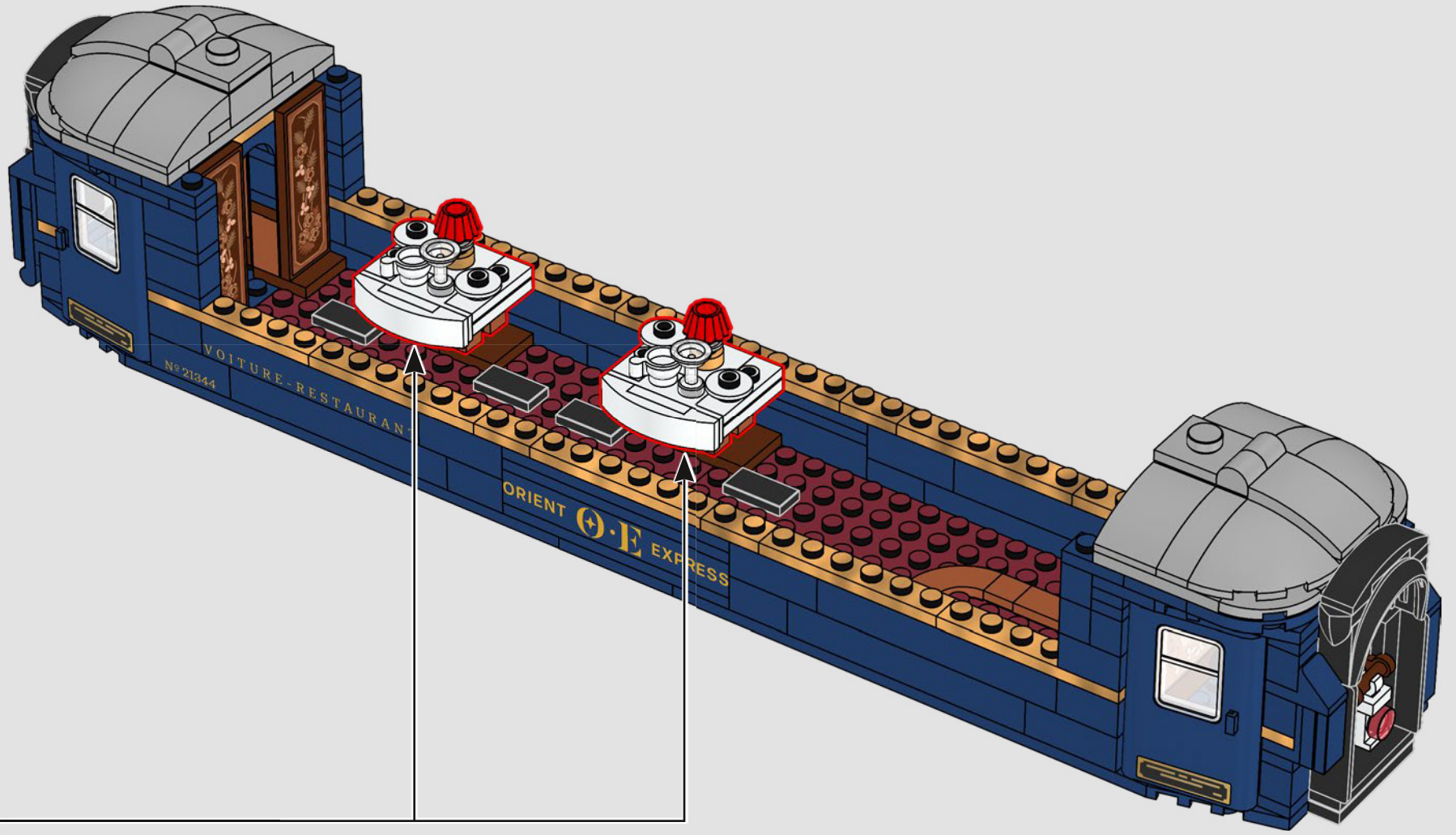

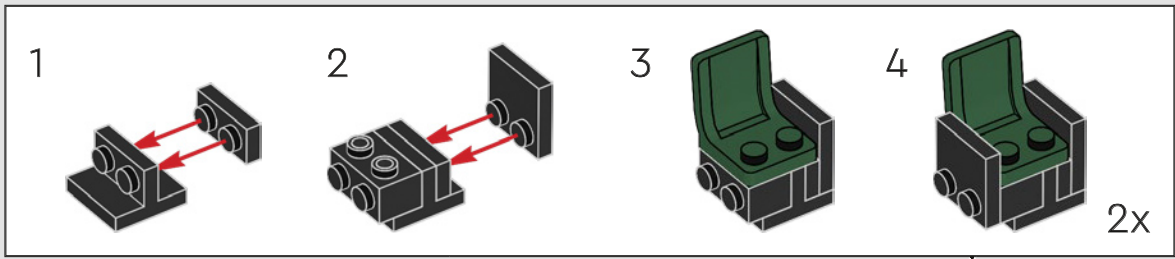
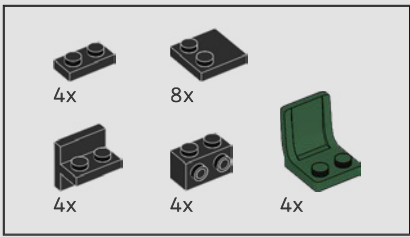

66

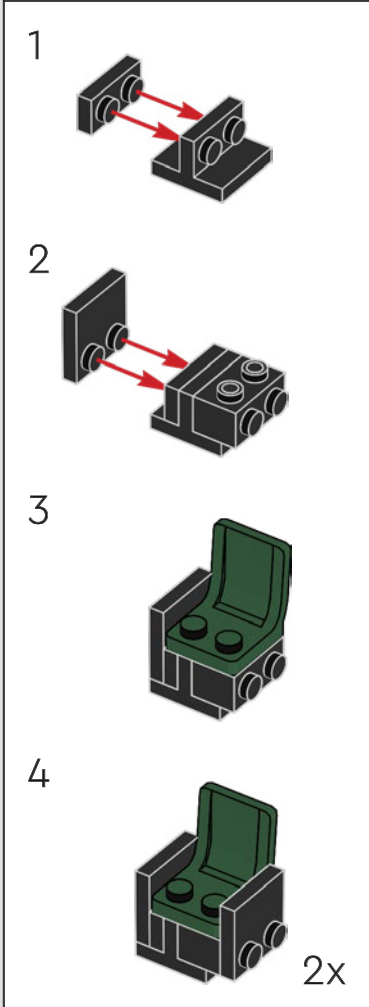



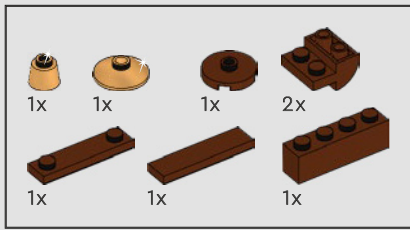

67

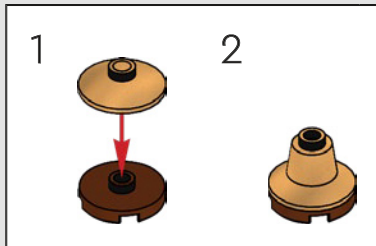
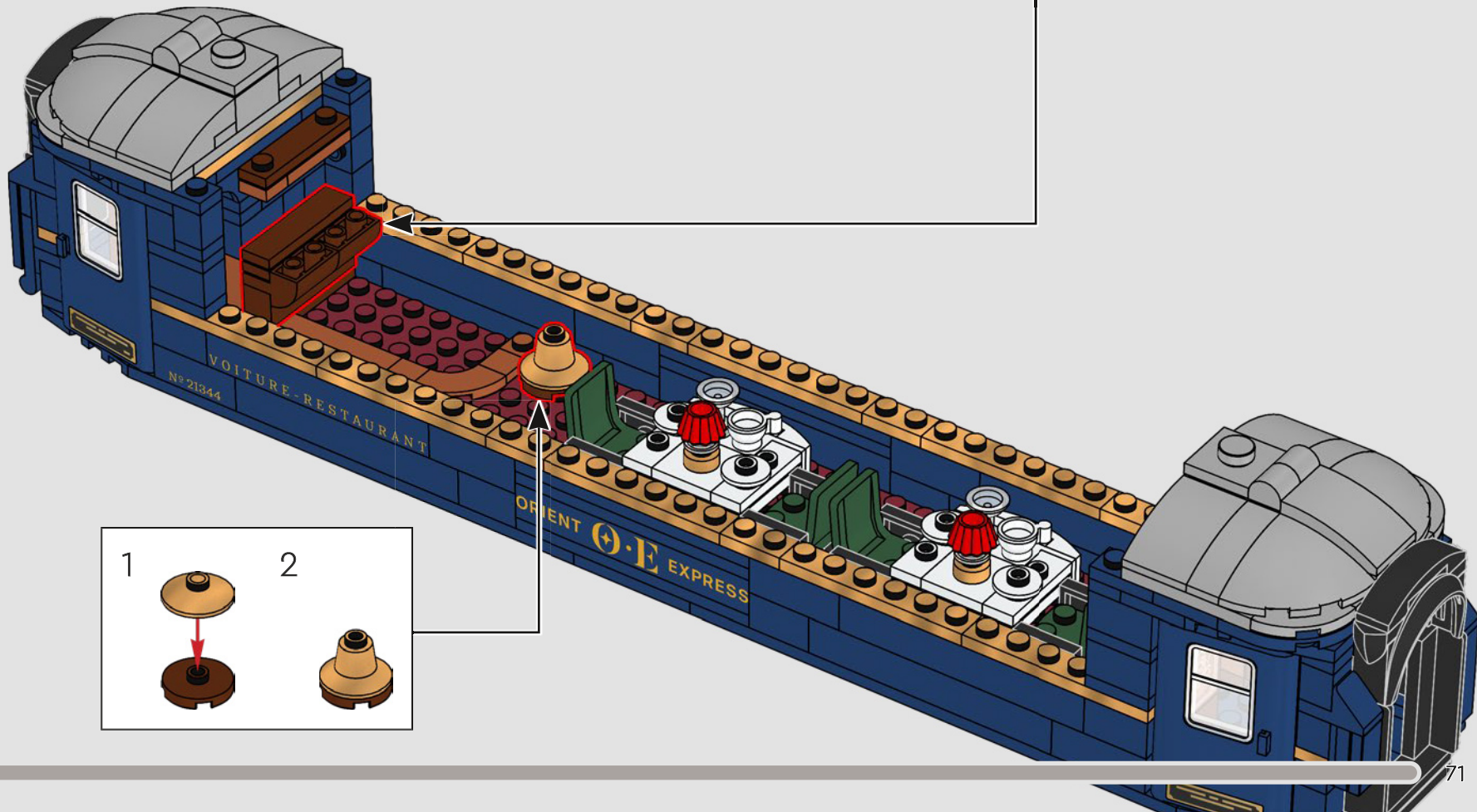
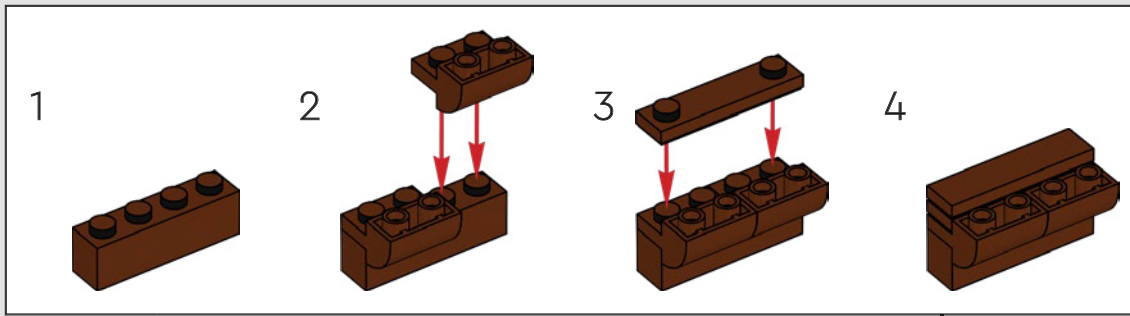

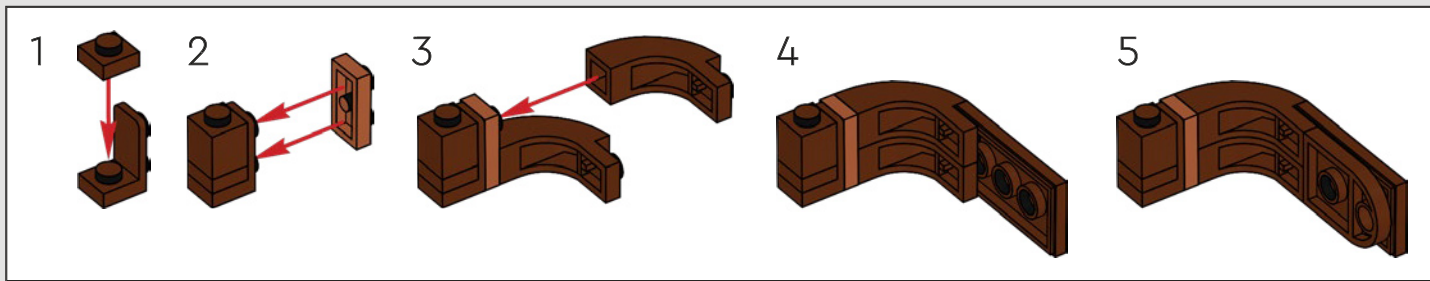
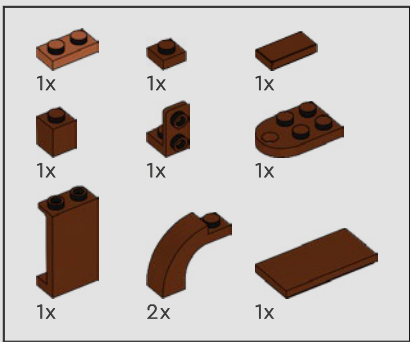

68

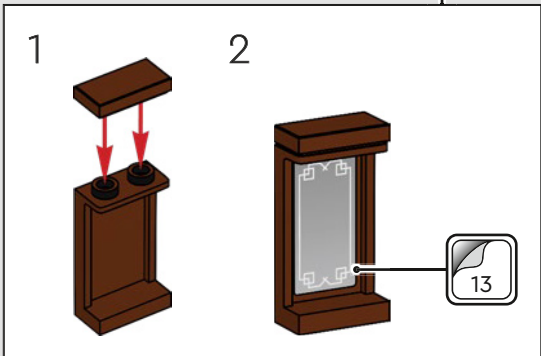
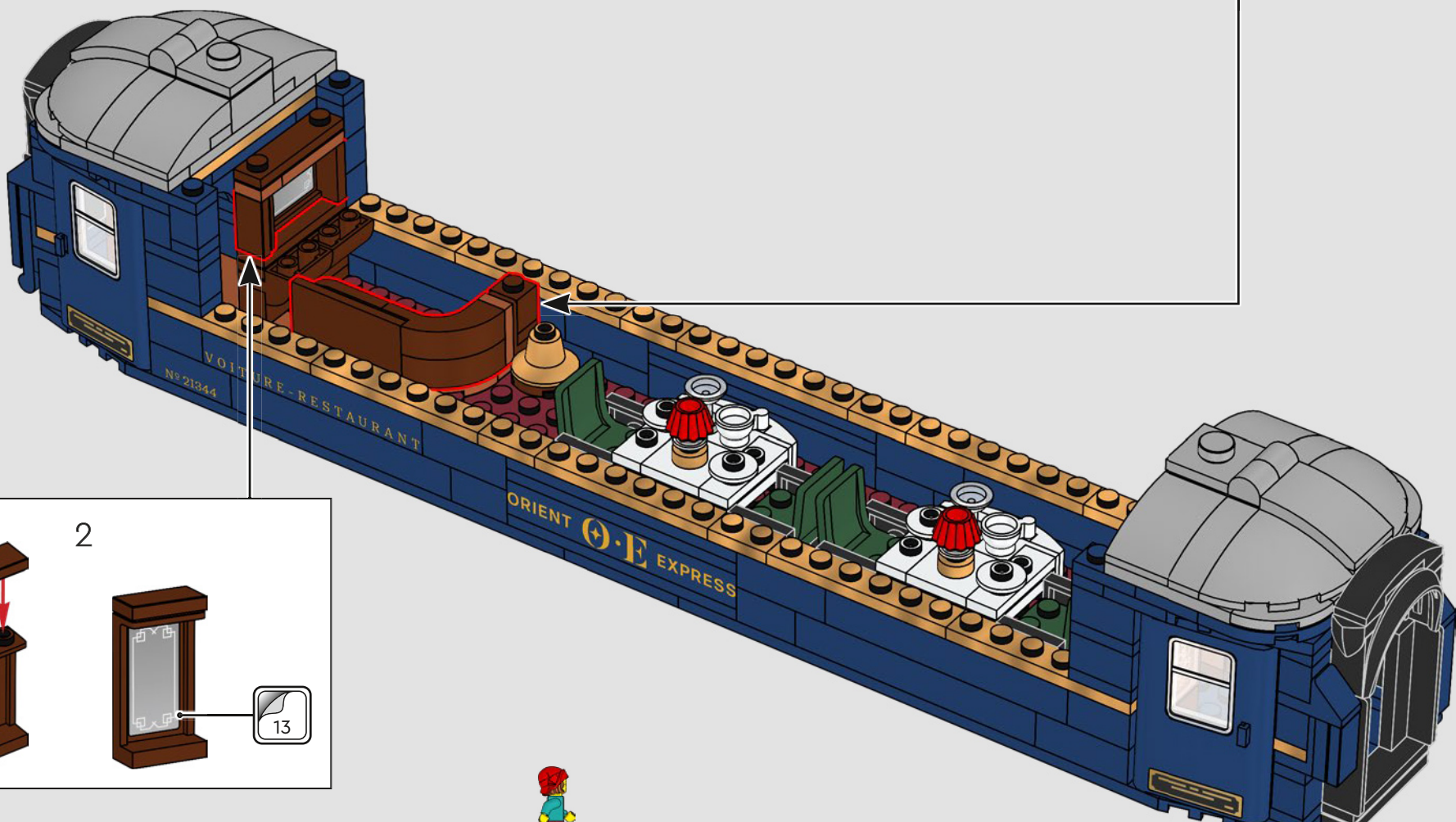





69

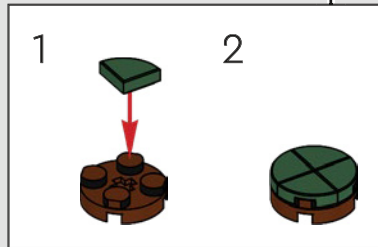
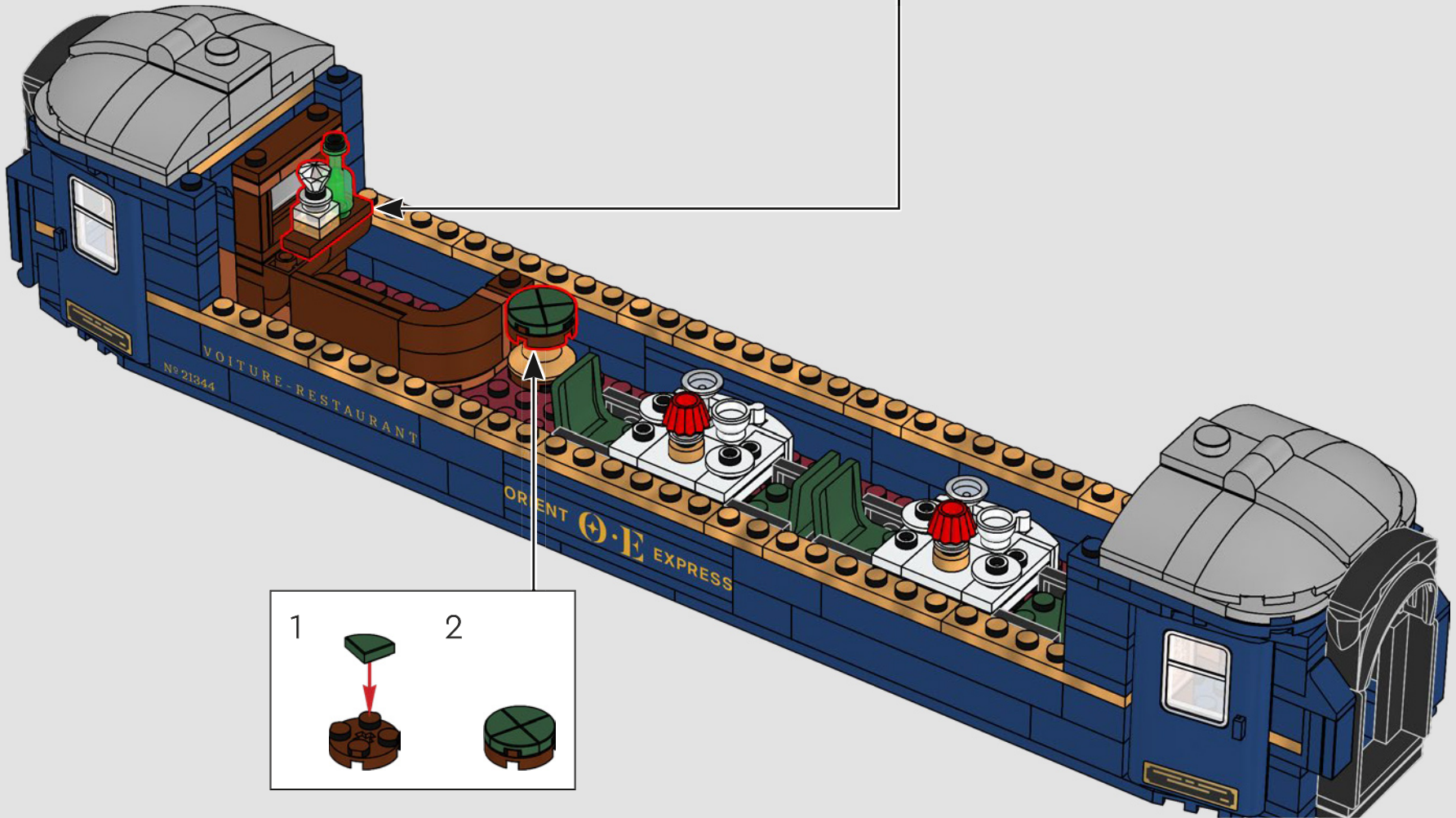
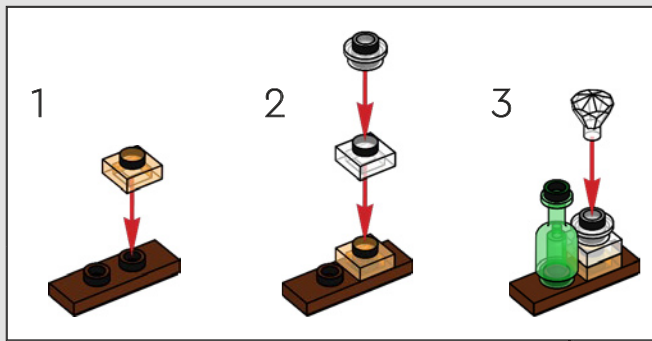



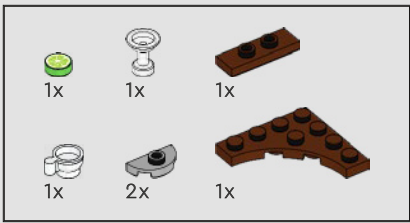

70

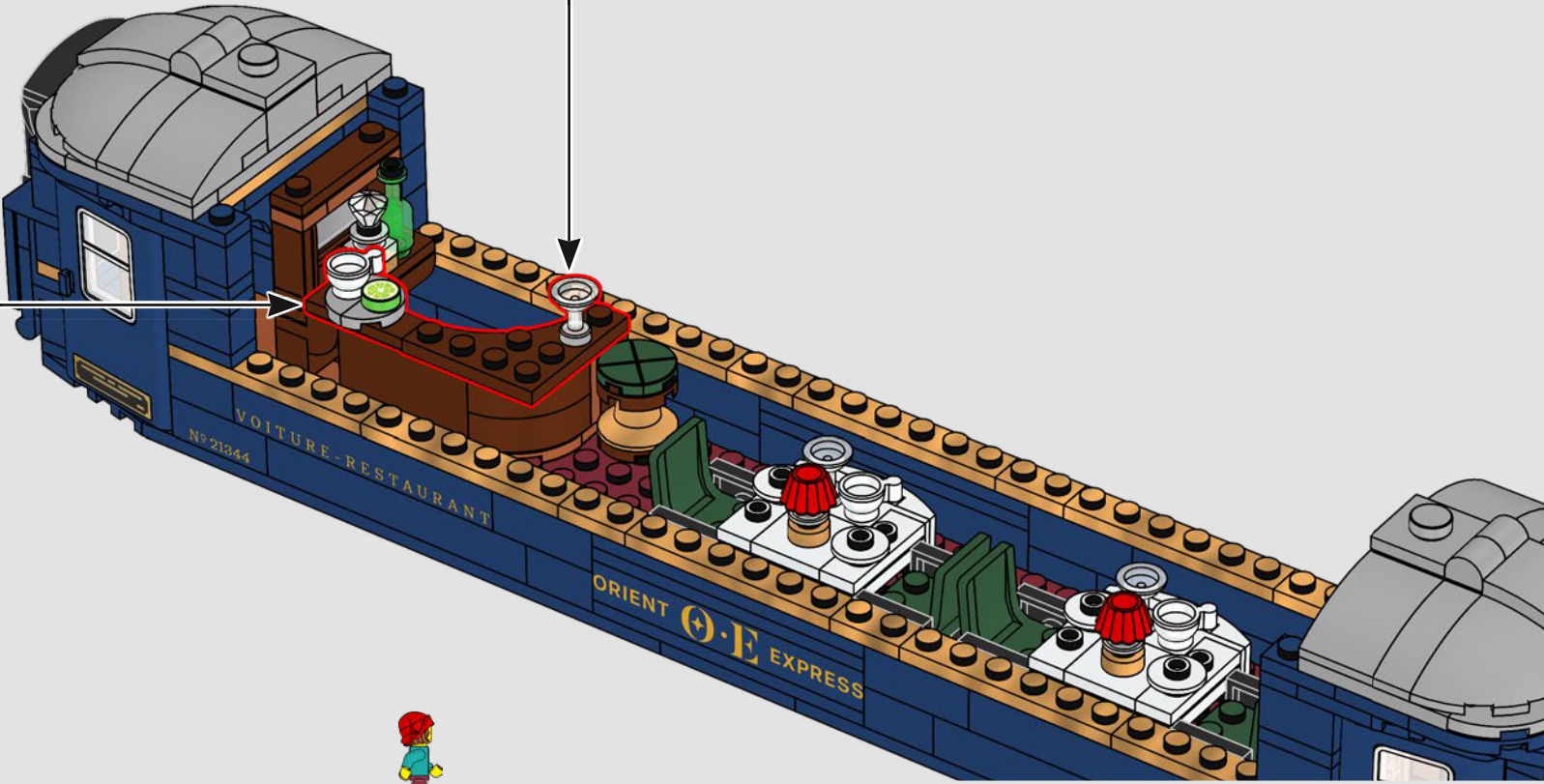
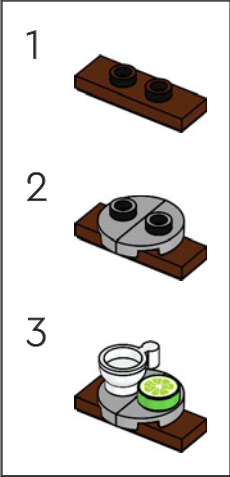
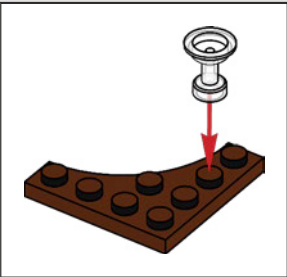

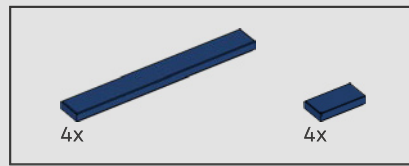

71



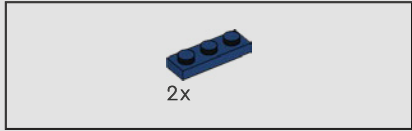
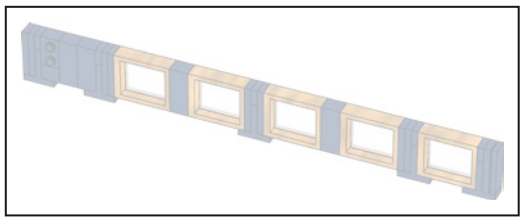

72

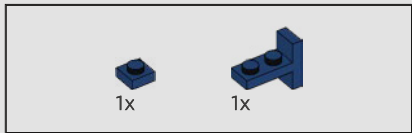
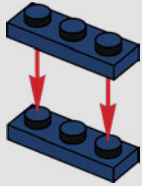

73

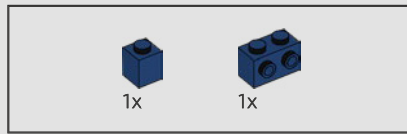
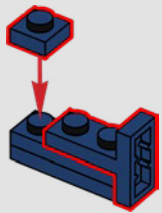

74

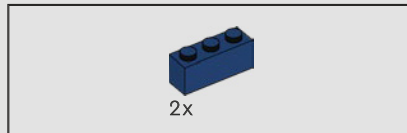
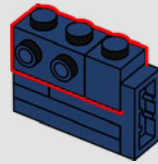

75

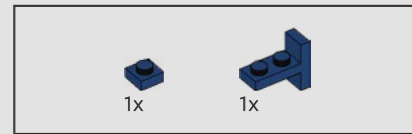
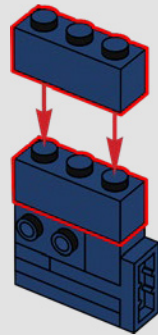

76

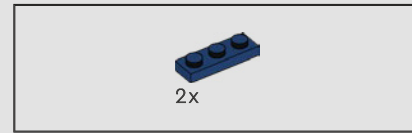
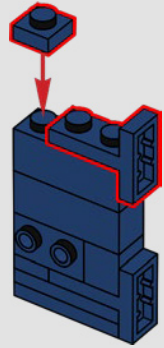

77

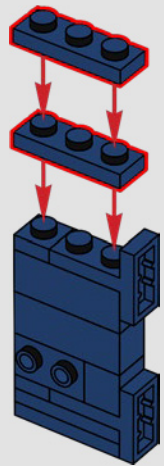



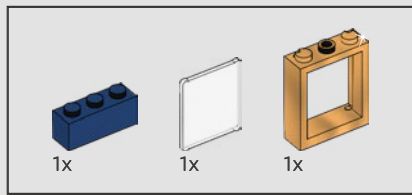

78

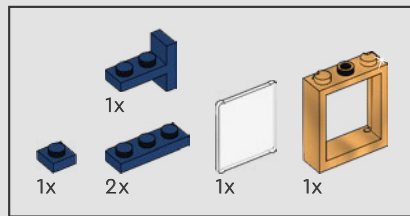
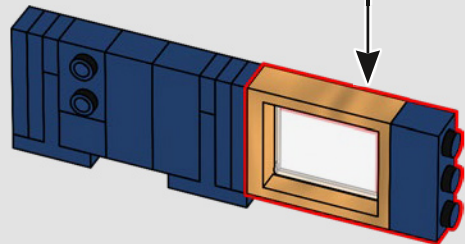
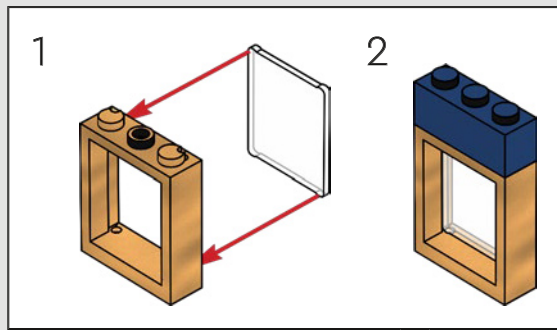

79

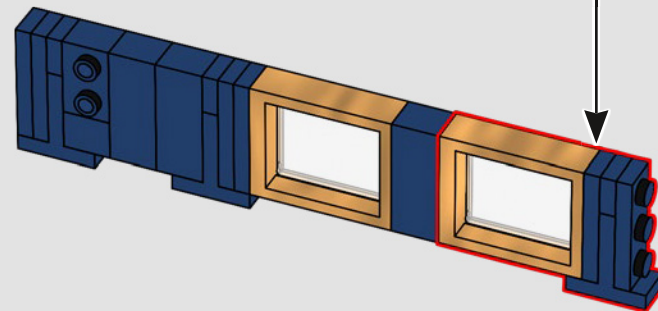
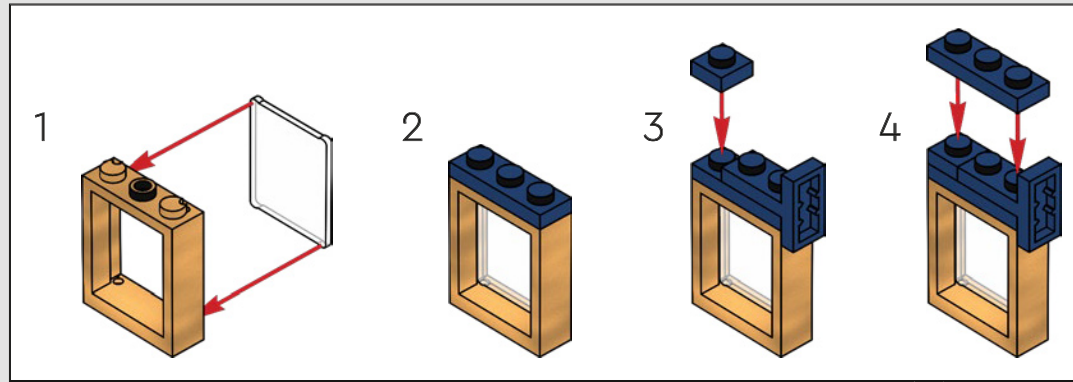

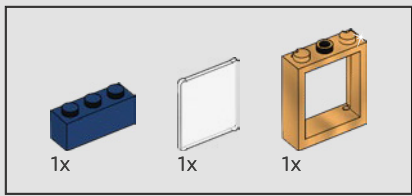

80

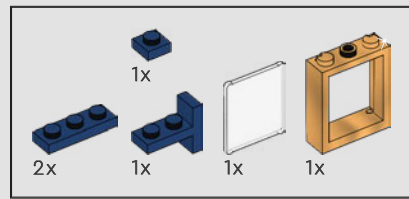
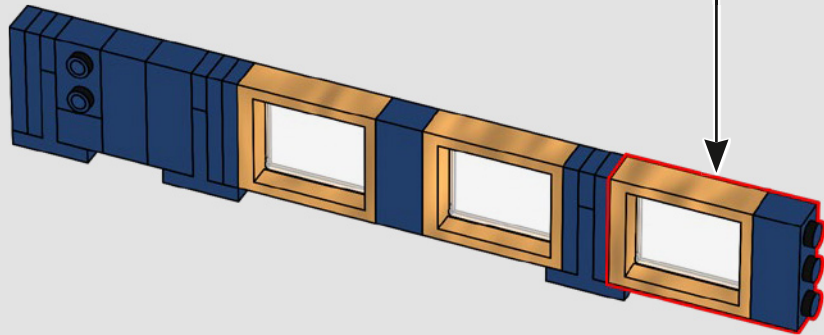
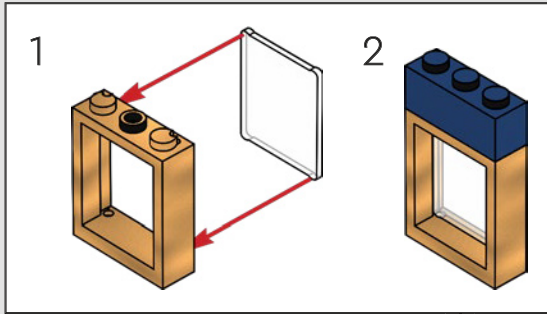

81

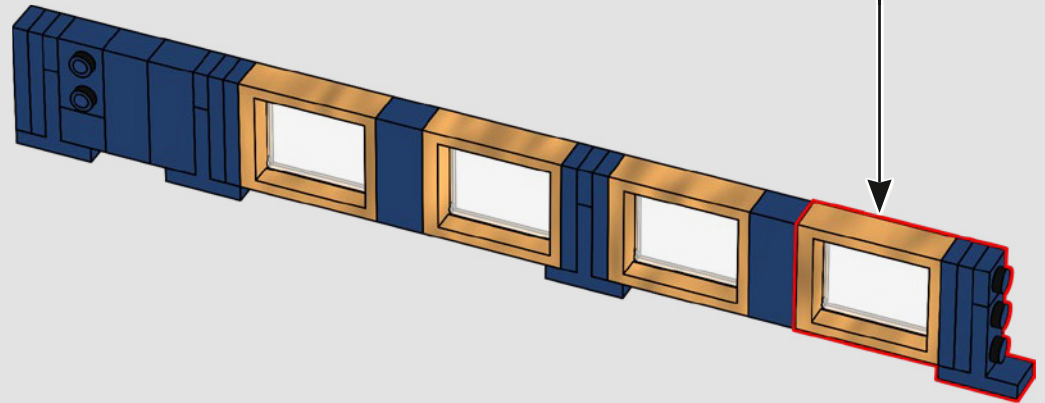
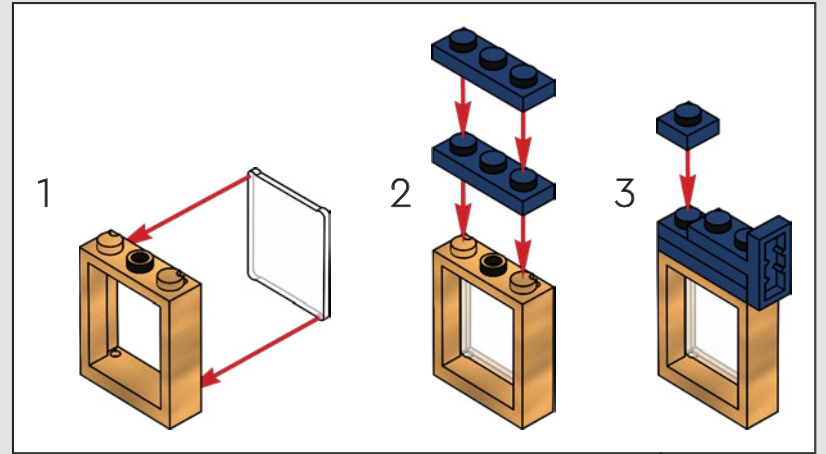

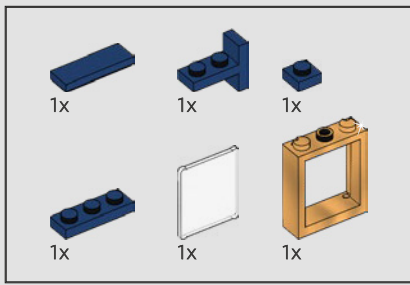

82

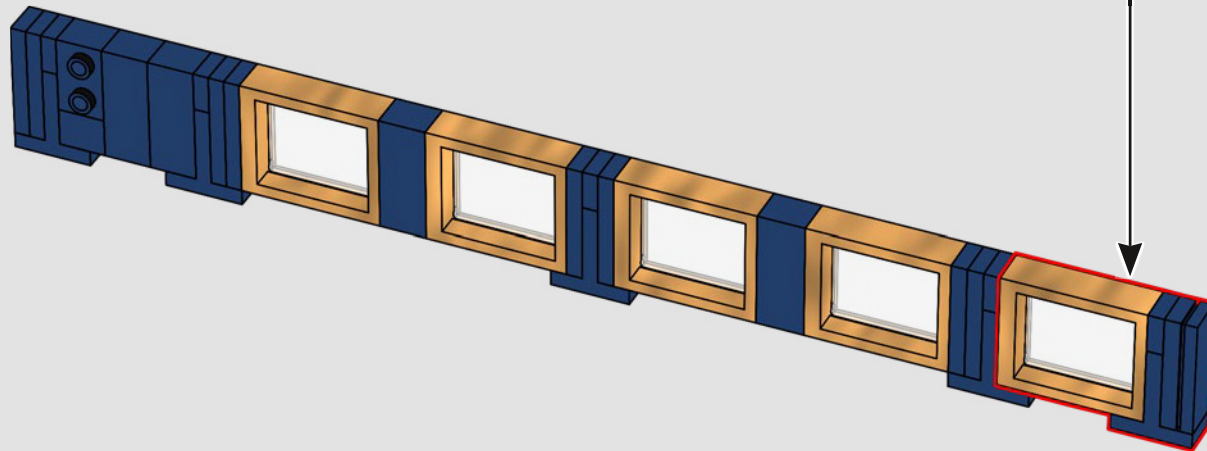
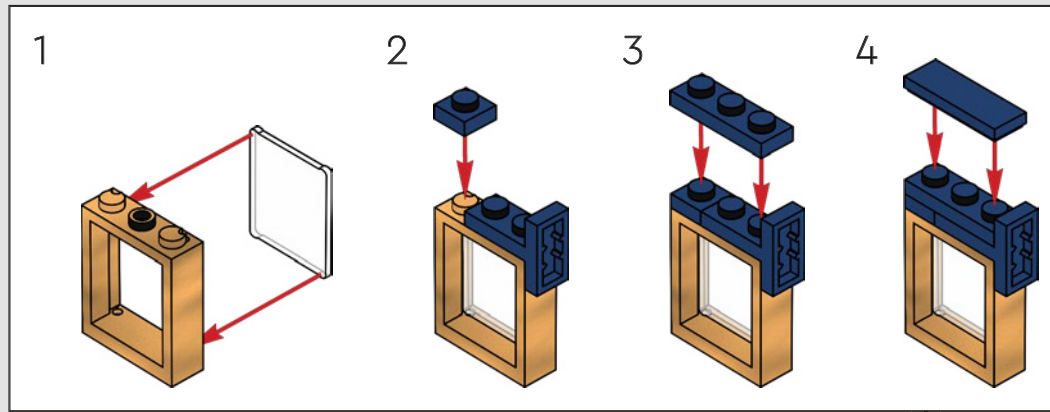



83

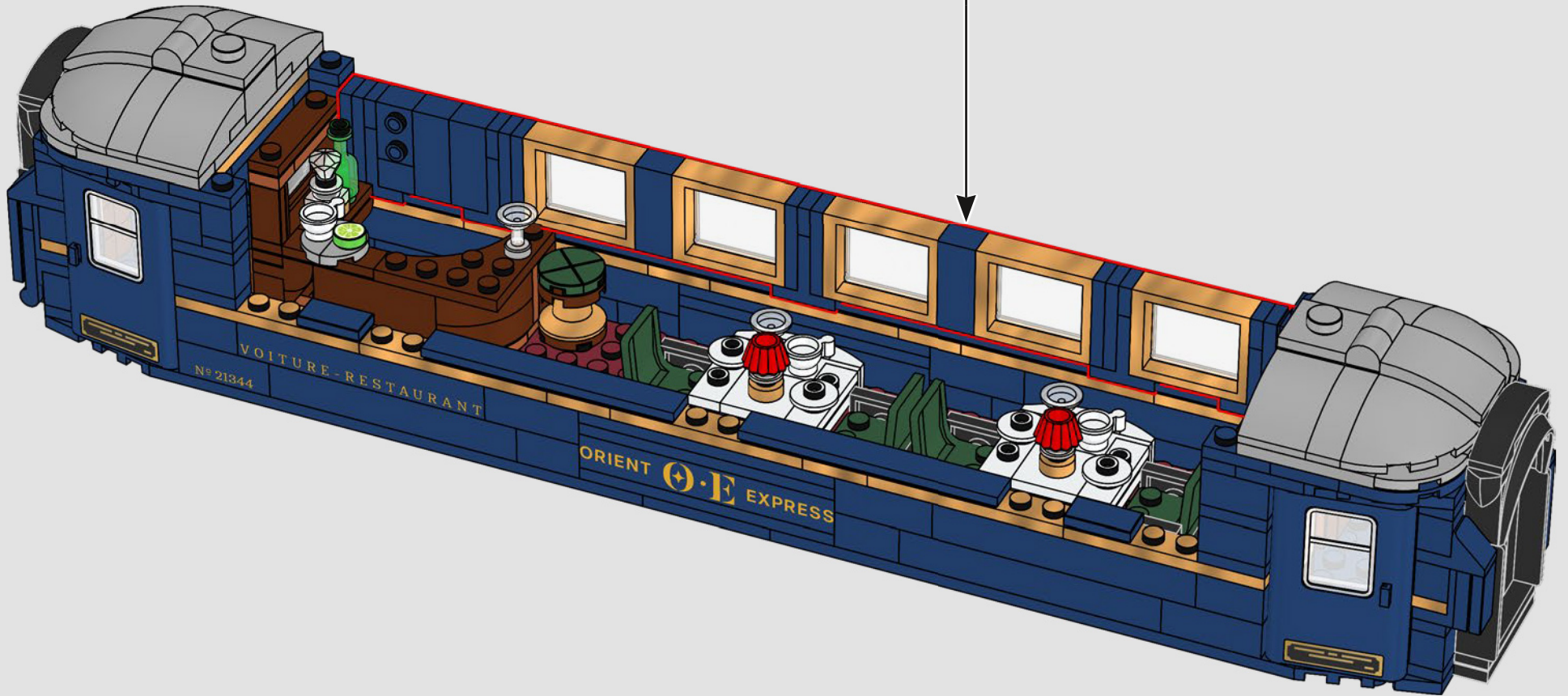

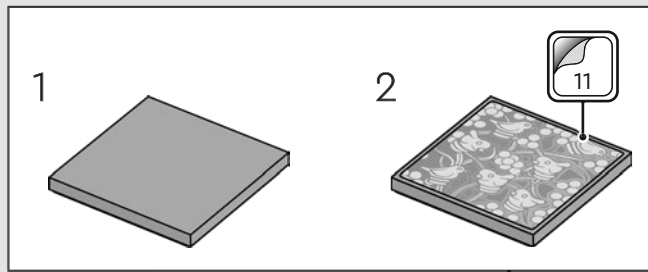
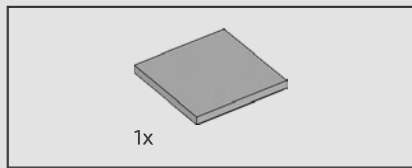

84

“Gli interni di questa carrozza sono impreziositi da raffinati specchi in vetro tagliato”.

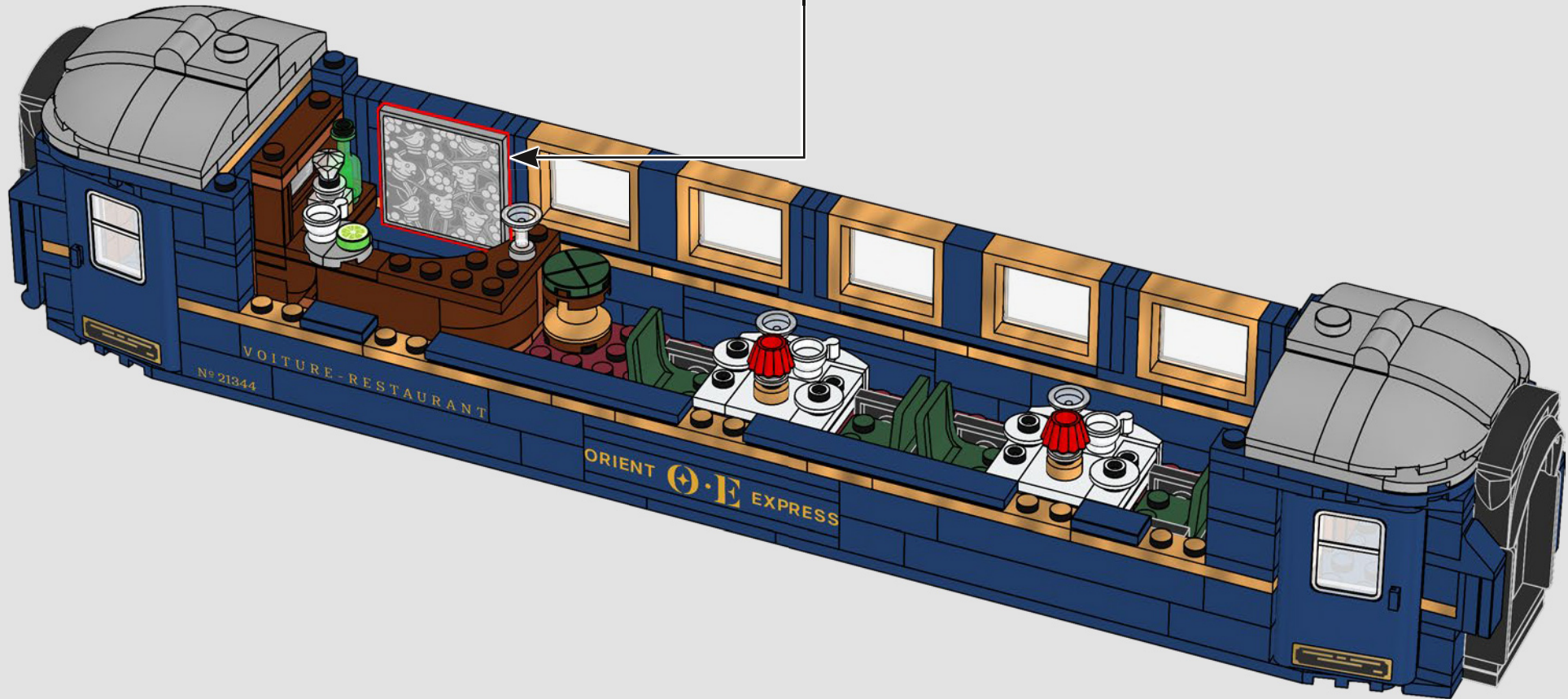





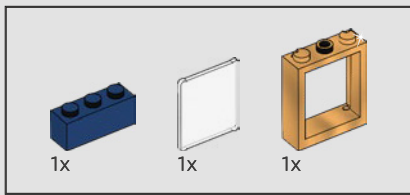

90

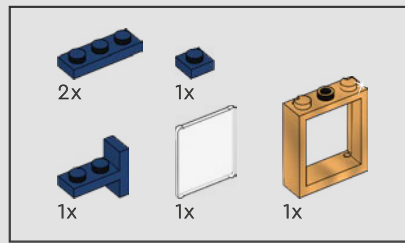
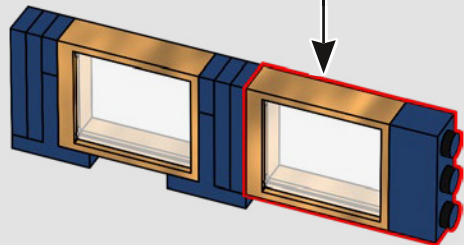
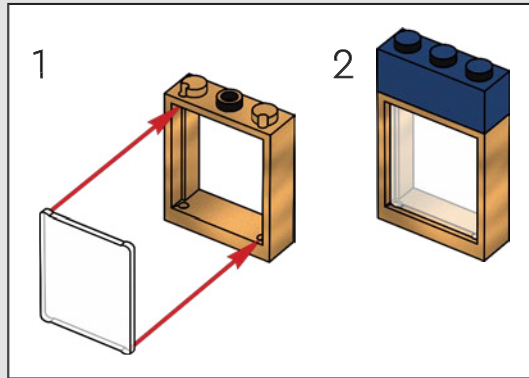

91

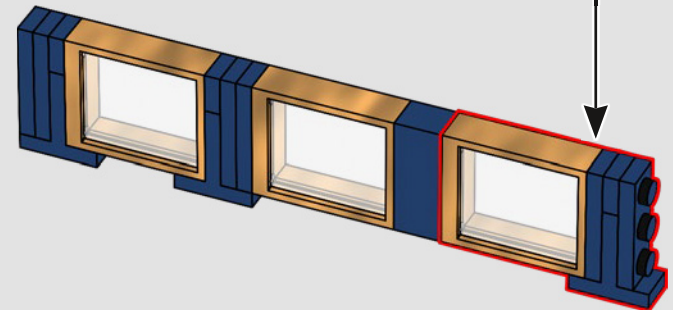
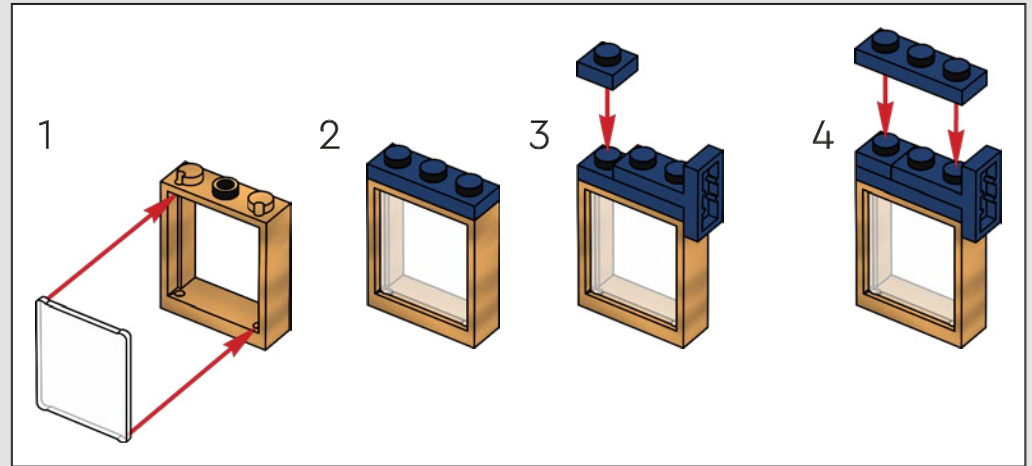

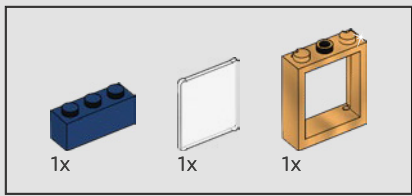

92

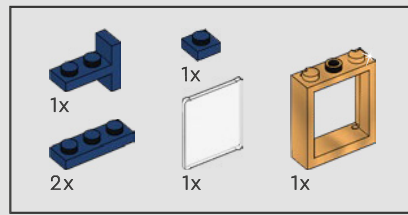
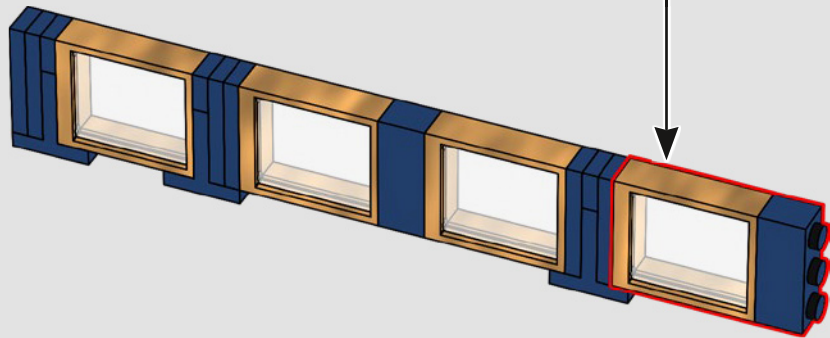
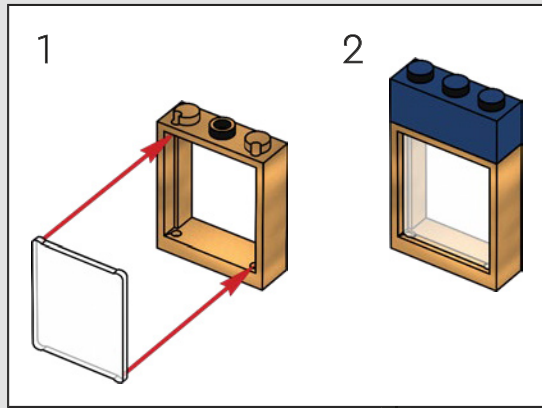

93

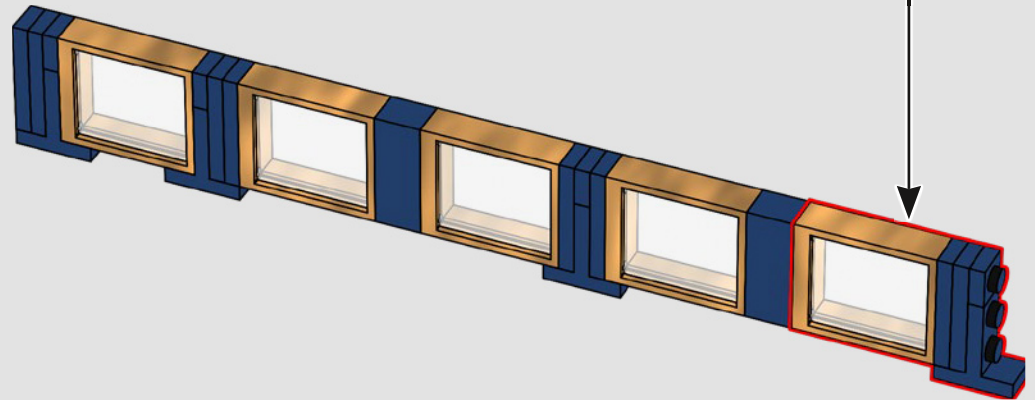
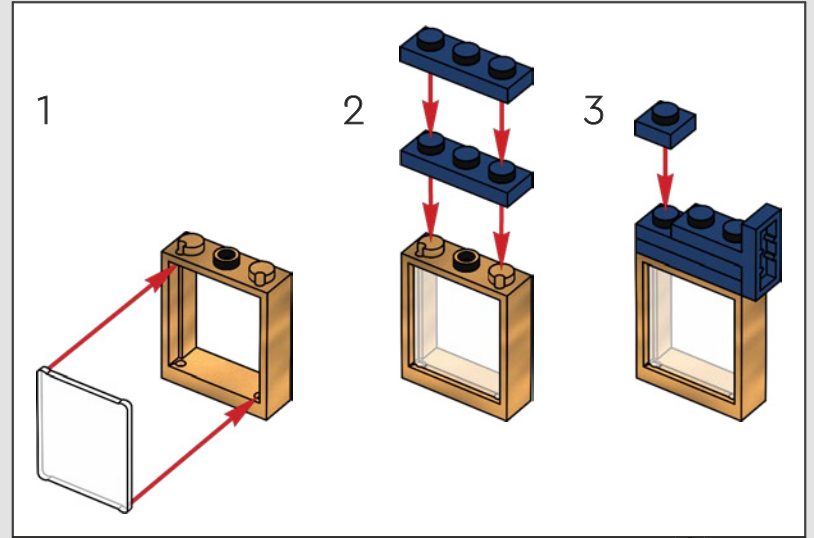

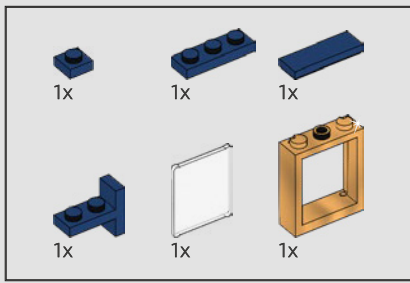

94

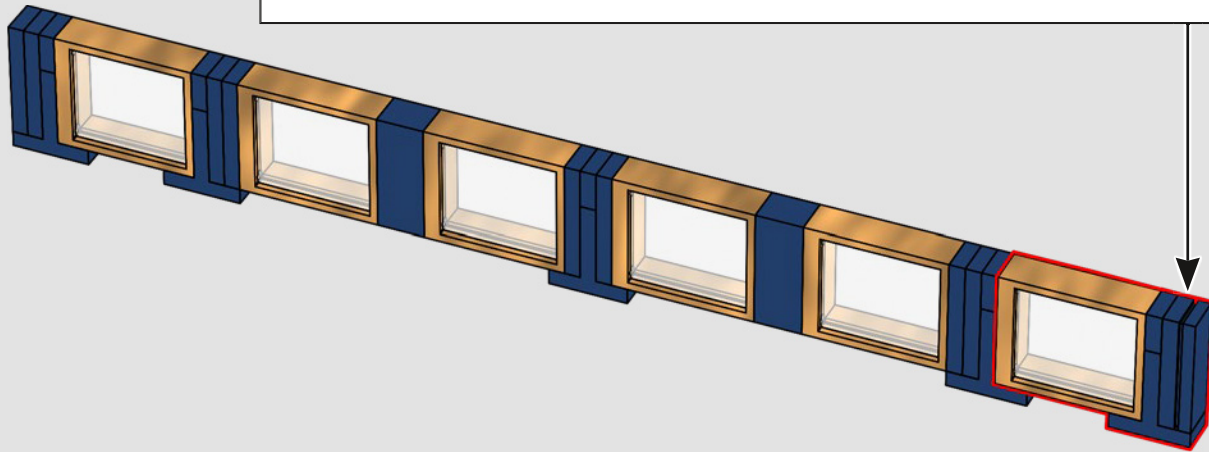
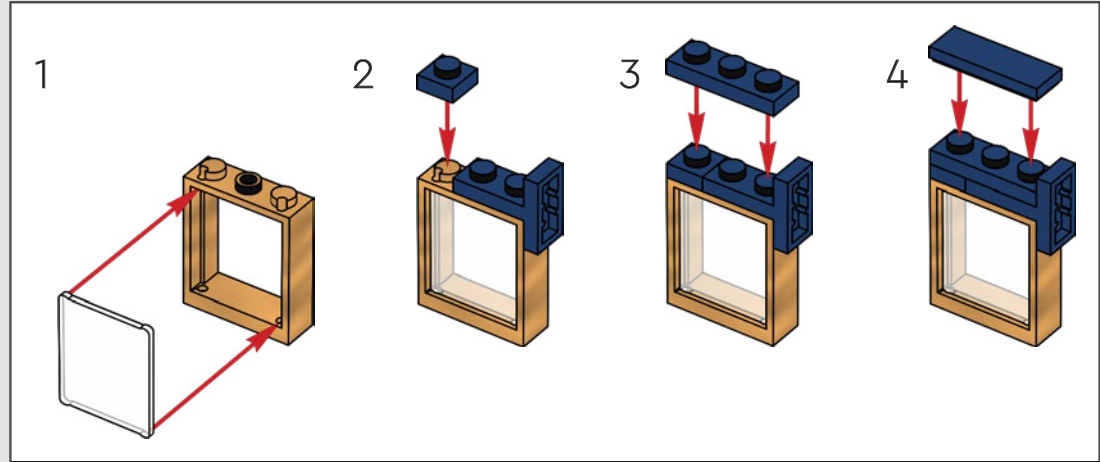





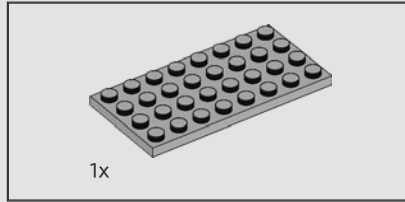
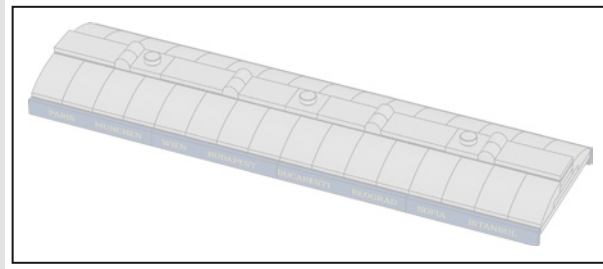

96

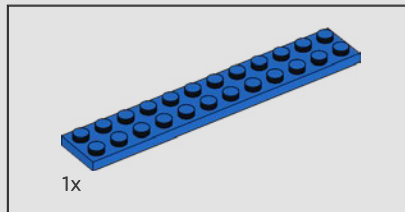
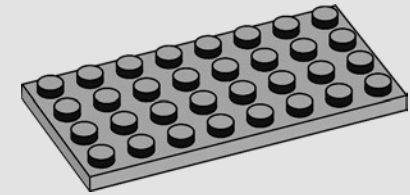

97

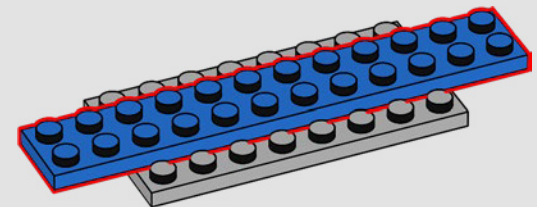

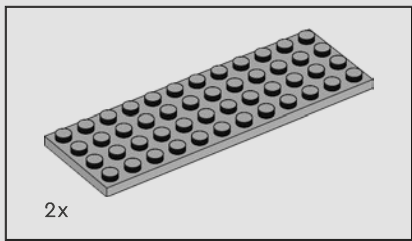

98

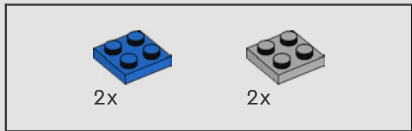
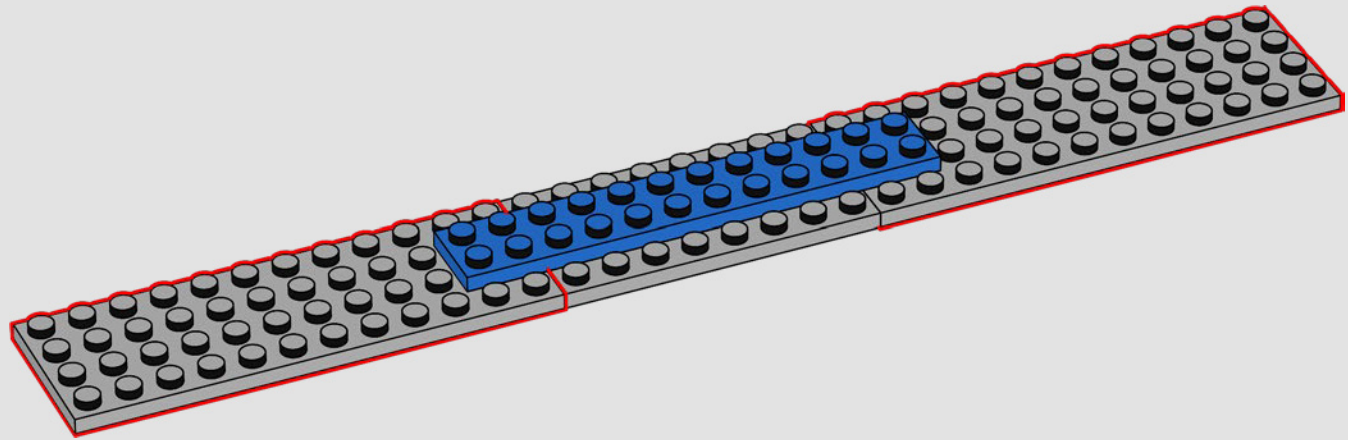

99

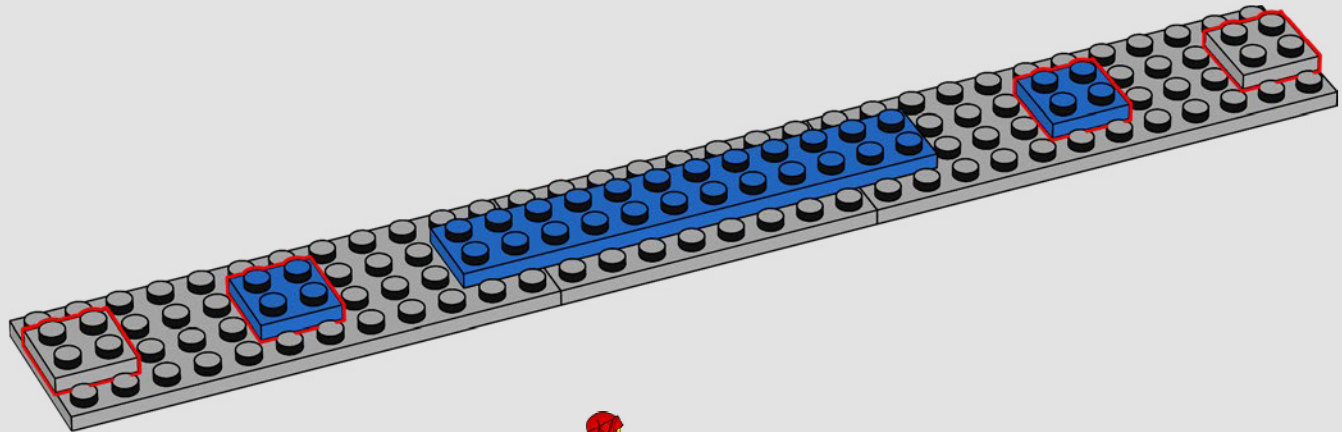



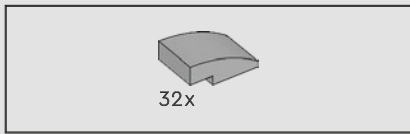

100

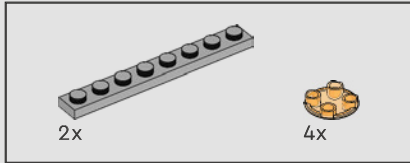
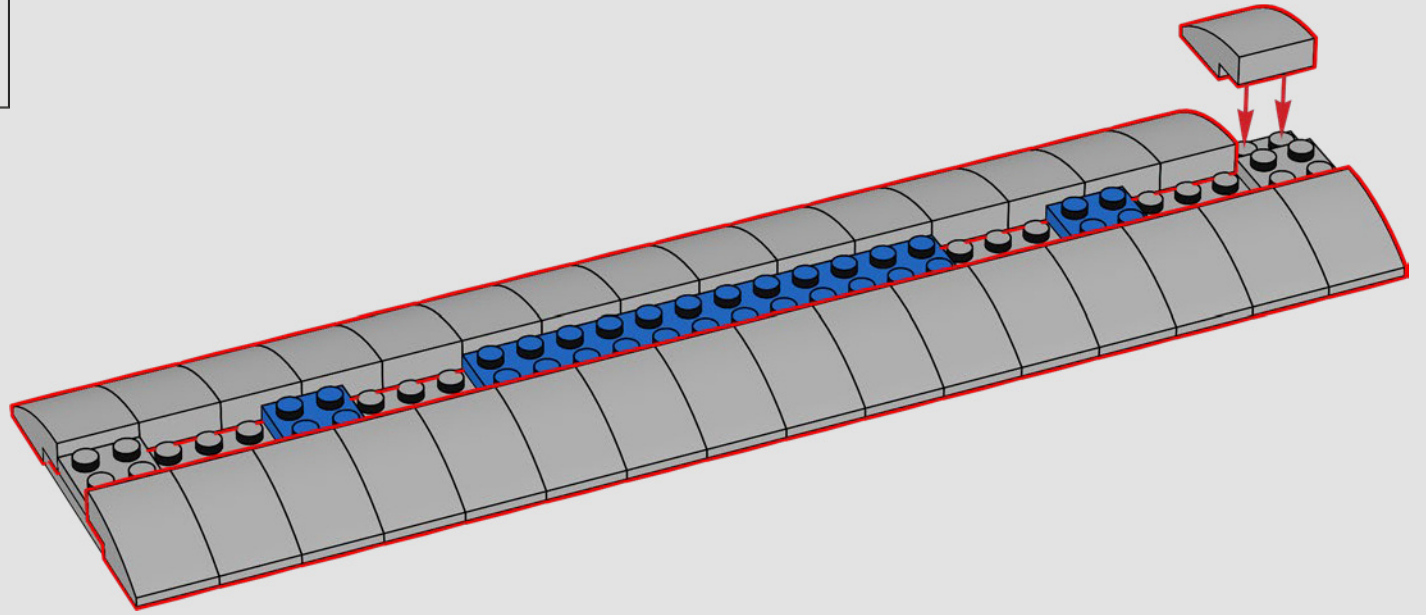

101

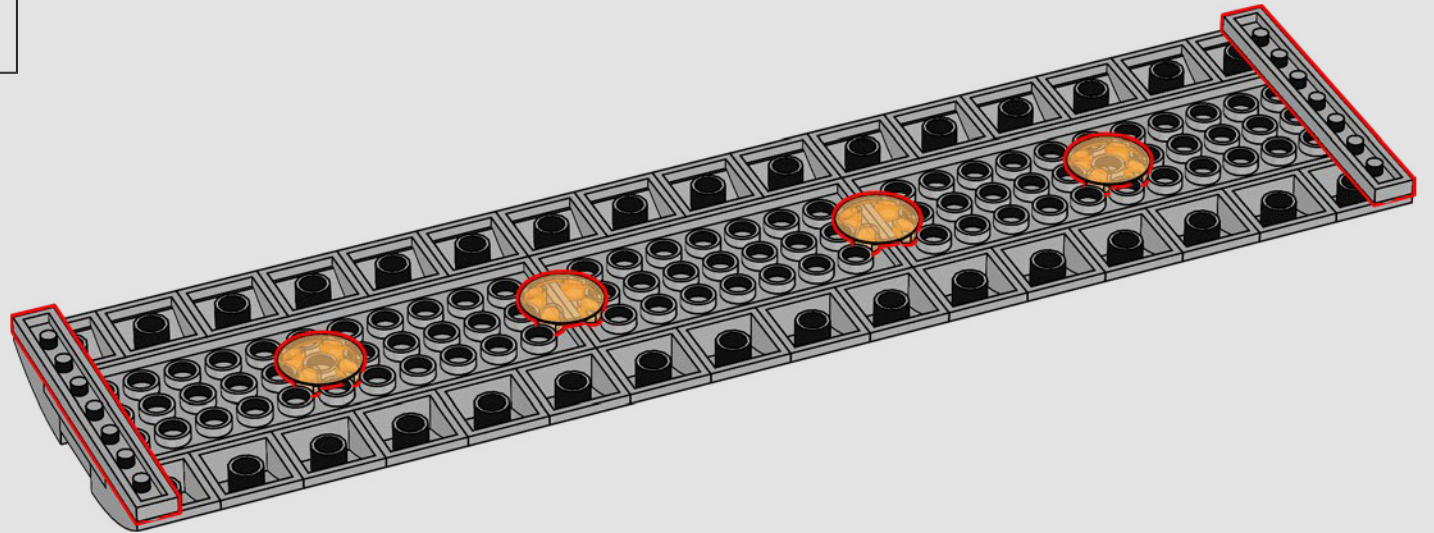

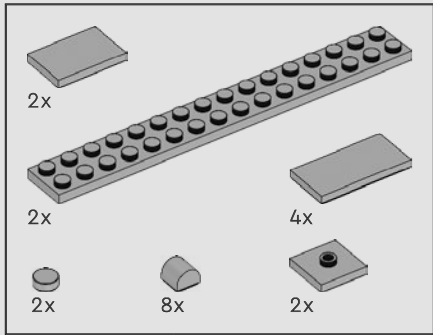
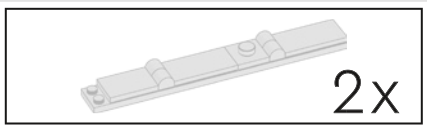

102

1

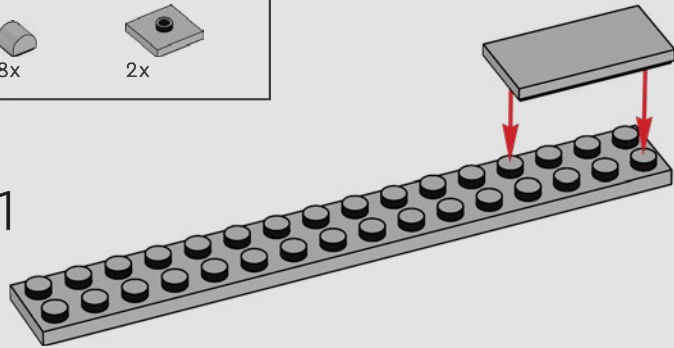

2

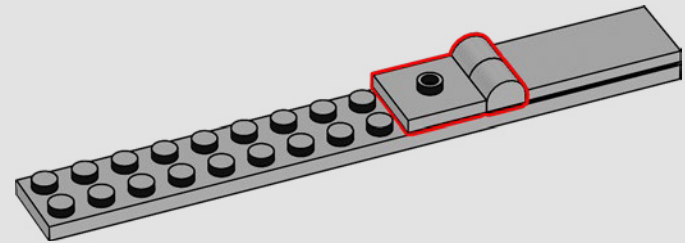

3

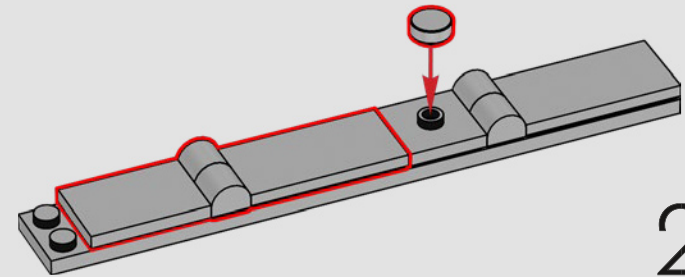

2x

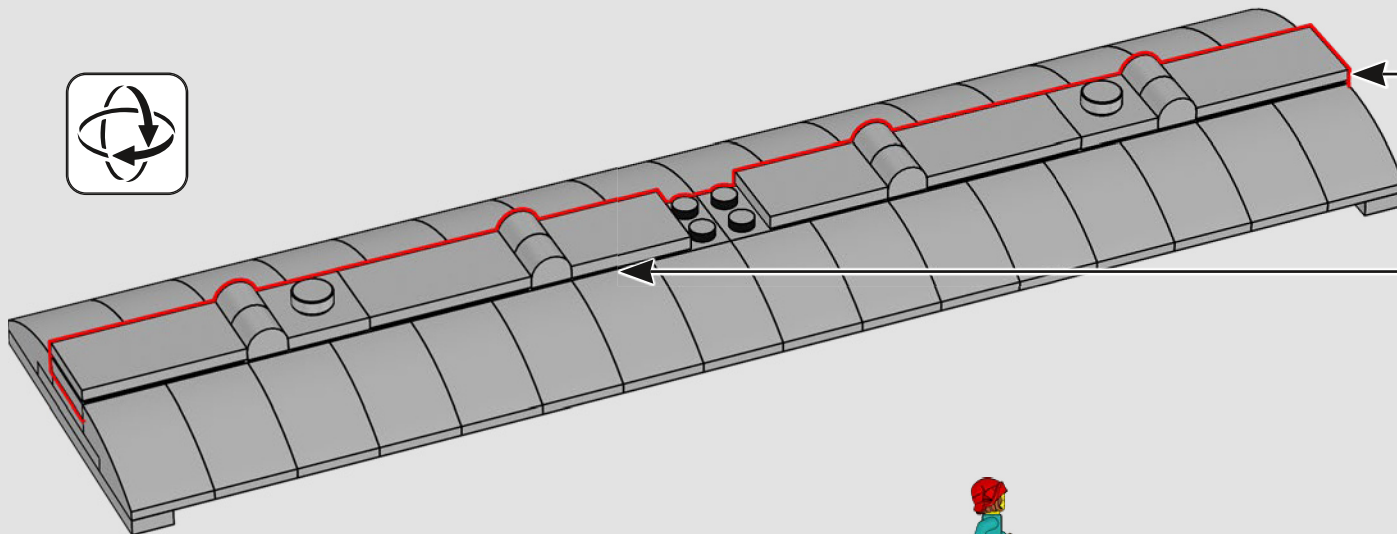

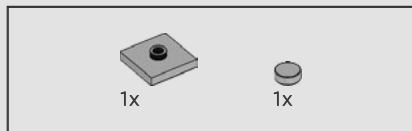

103

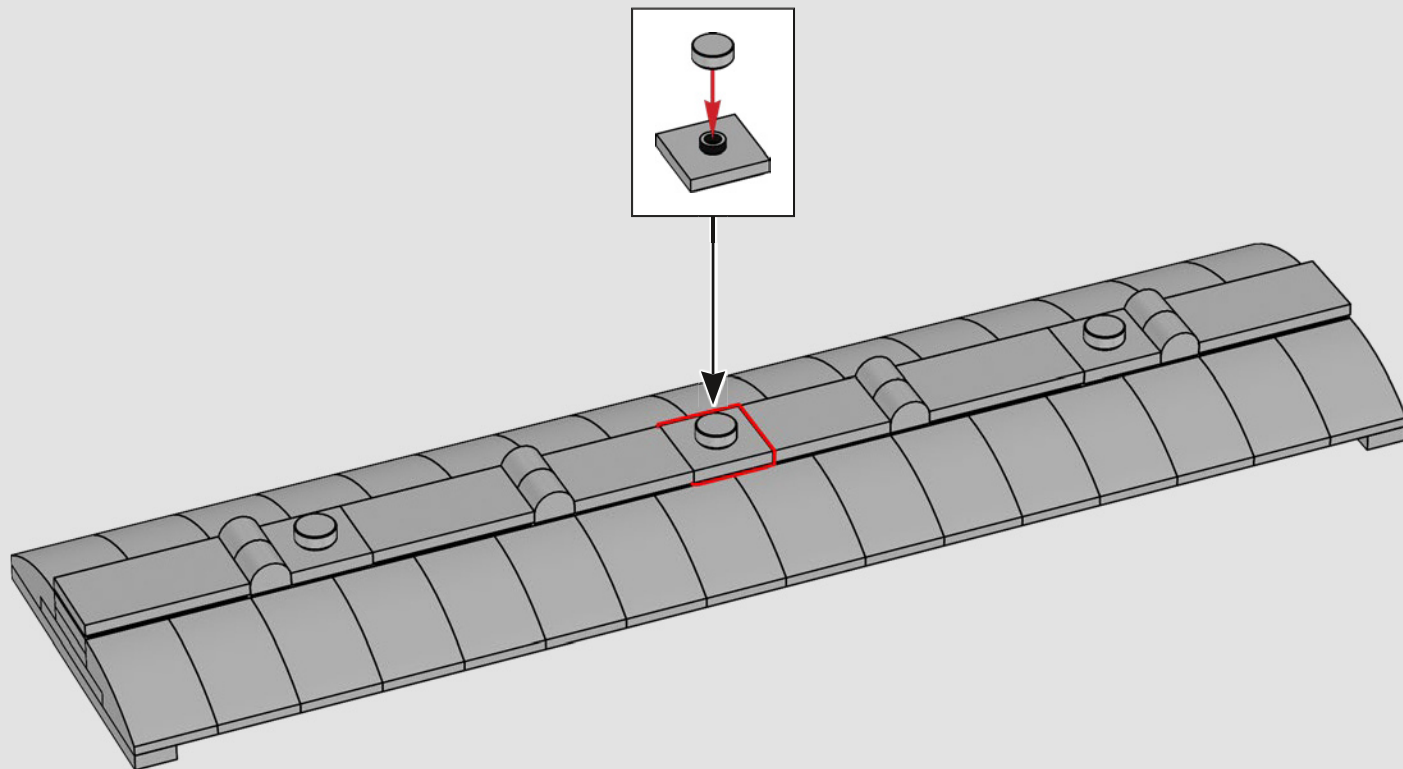



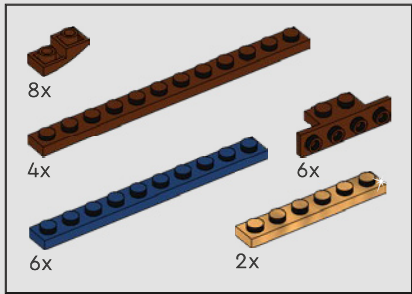
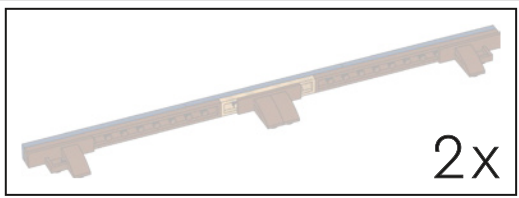

104

1

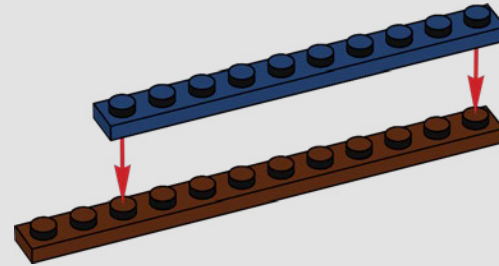

2

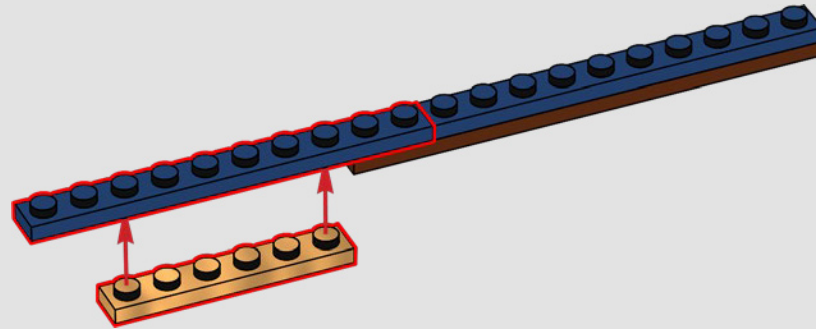

3

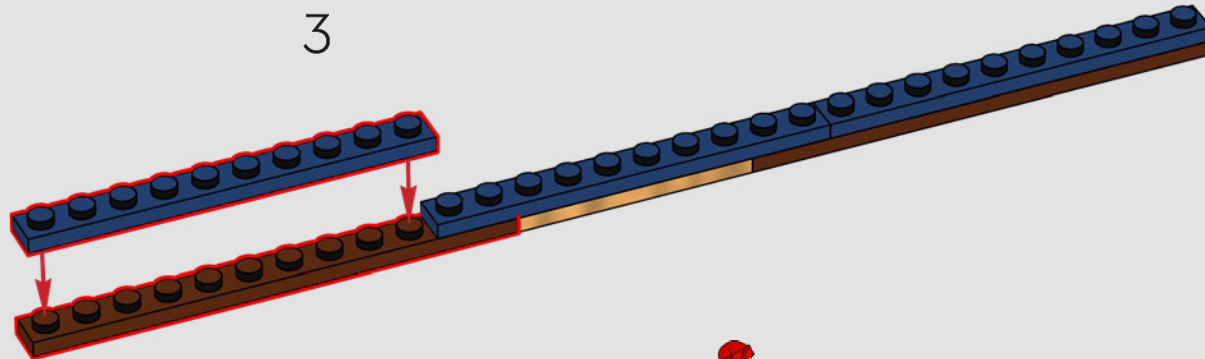

4

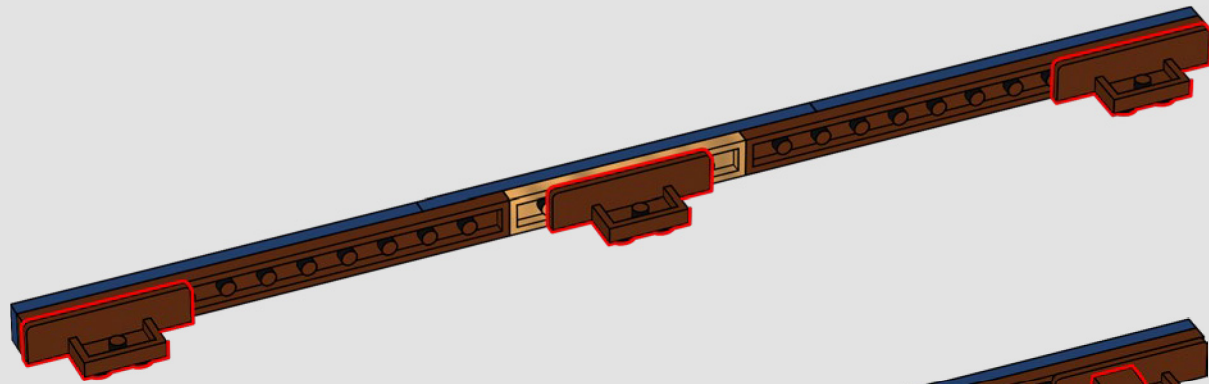

5

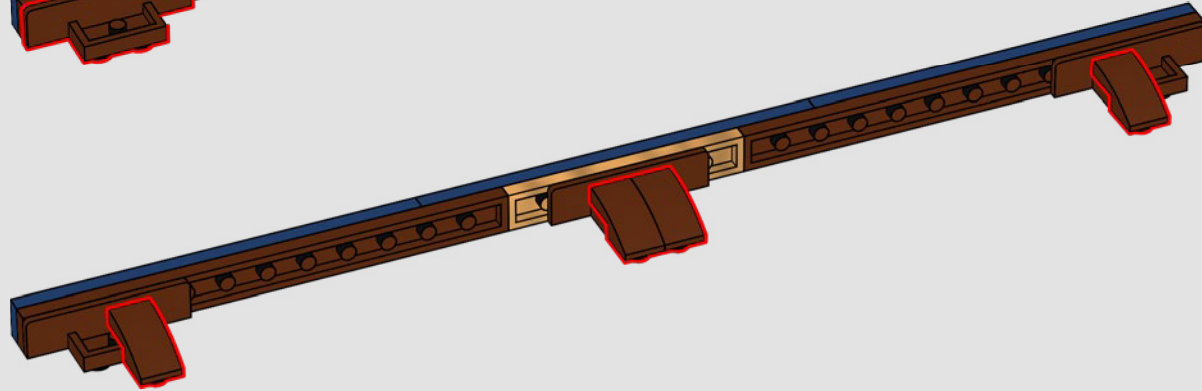

2x

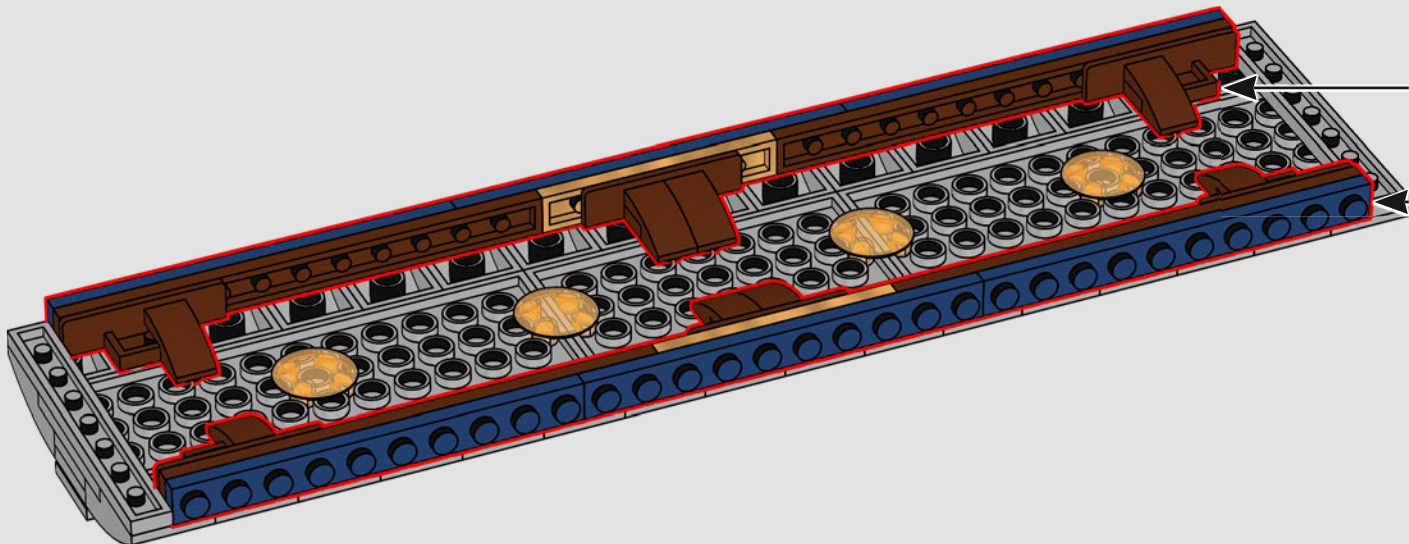

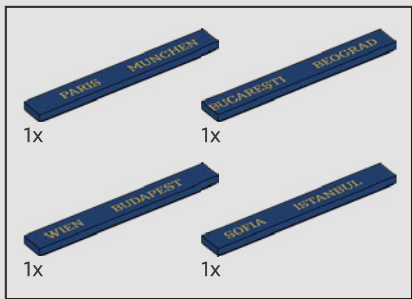

105

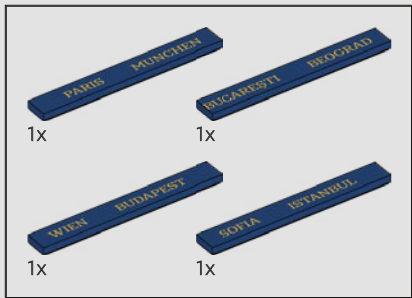
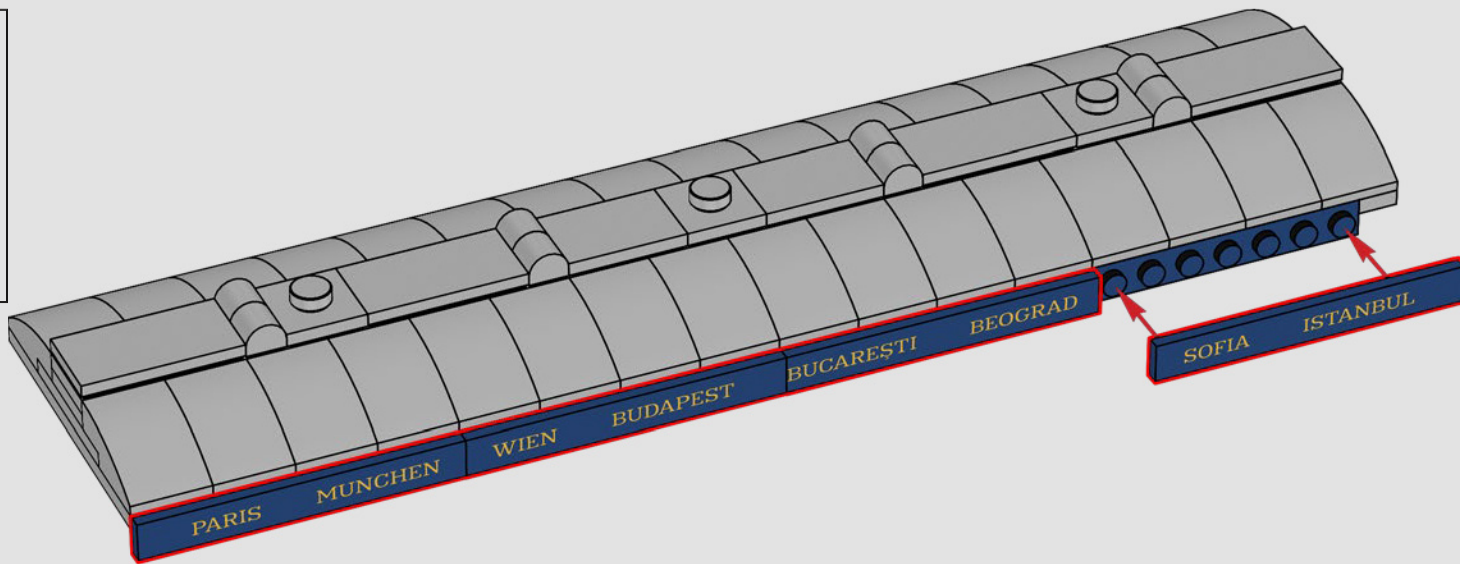
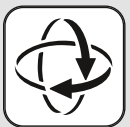

106

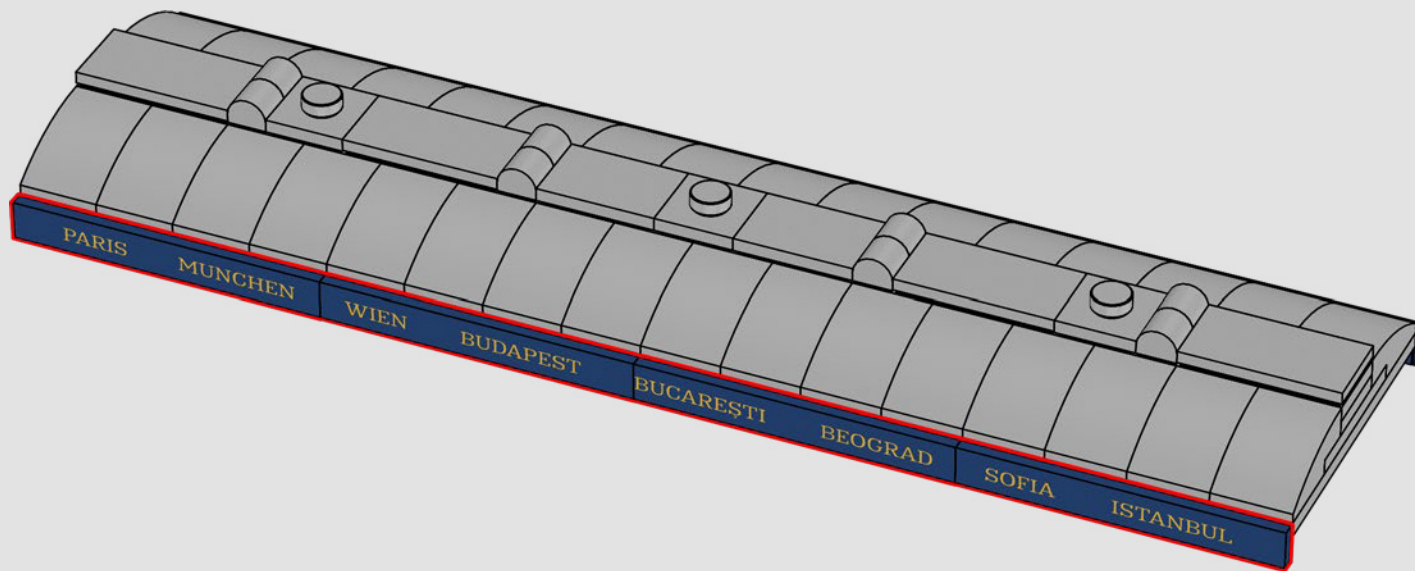



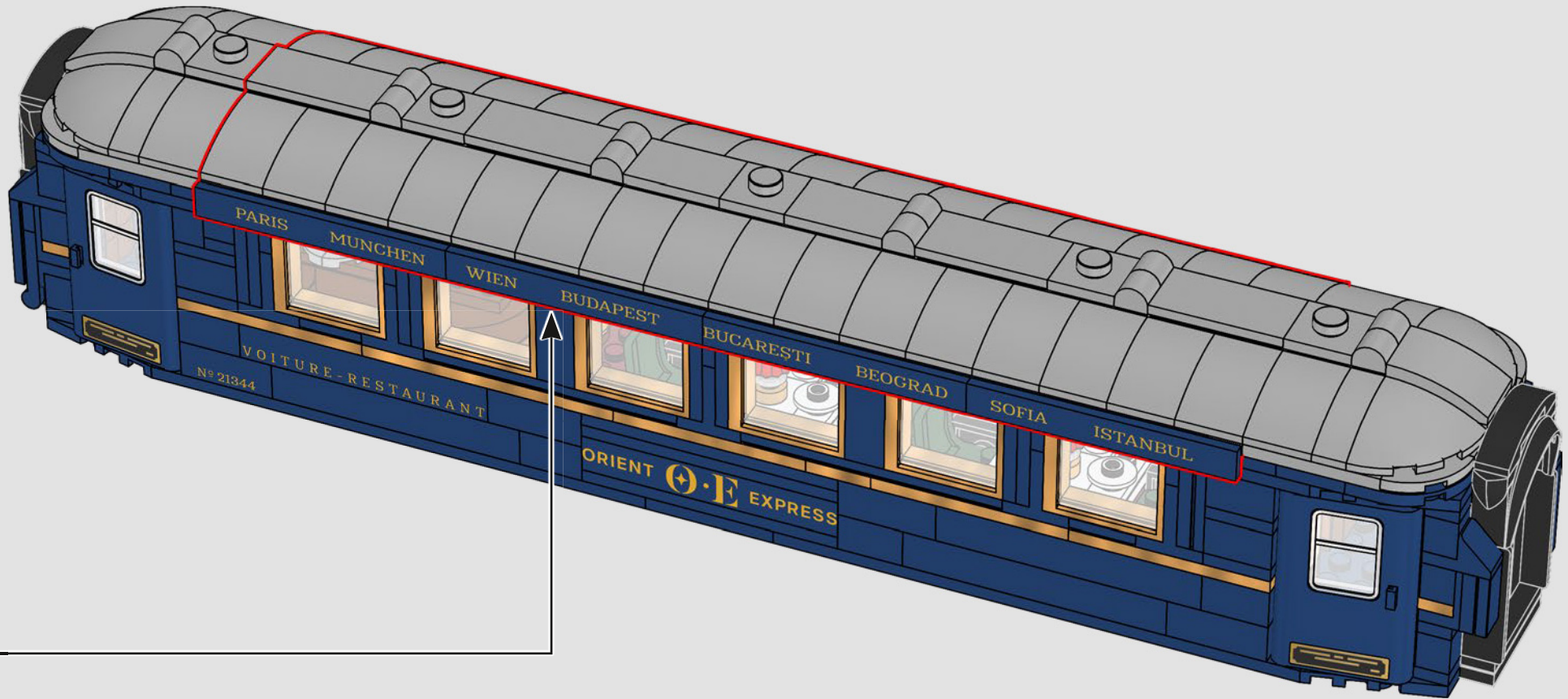

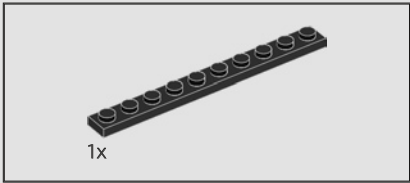
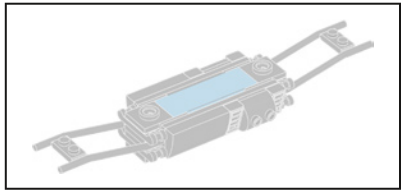

108

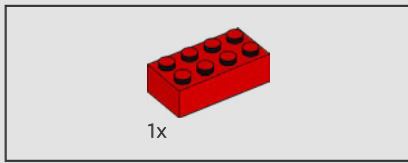
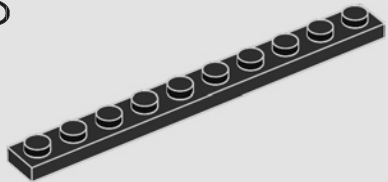

109

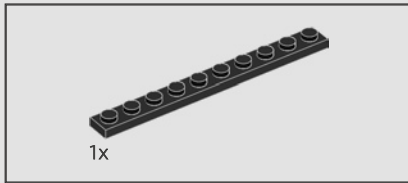
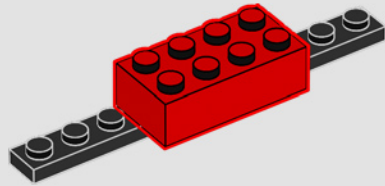

110

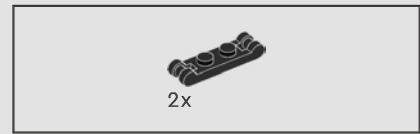
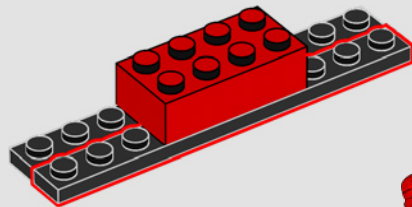

111

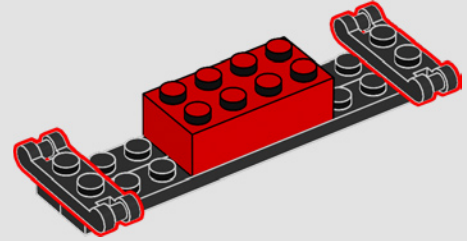

112

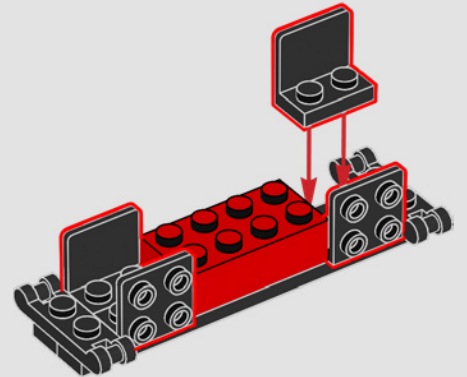

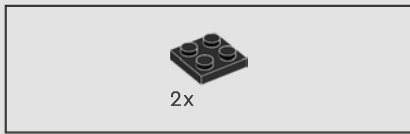

113

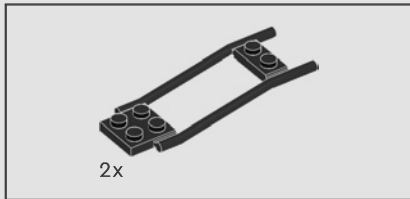
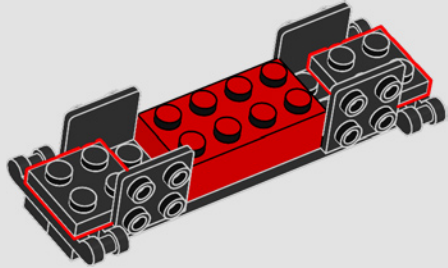

114

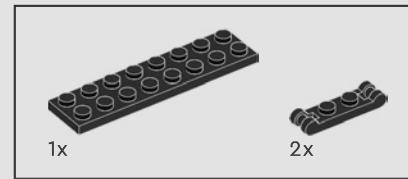
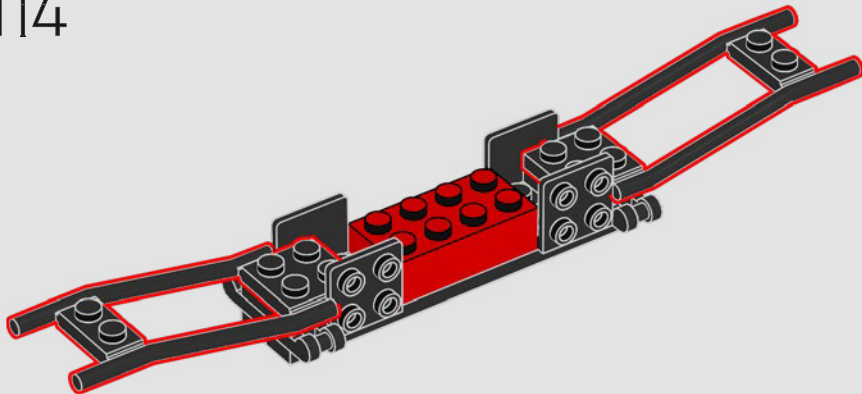

115

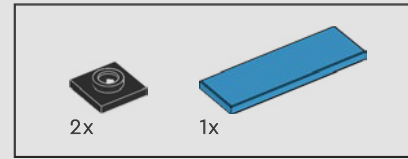
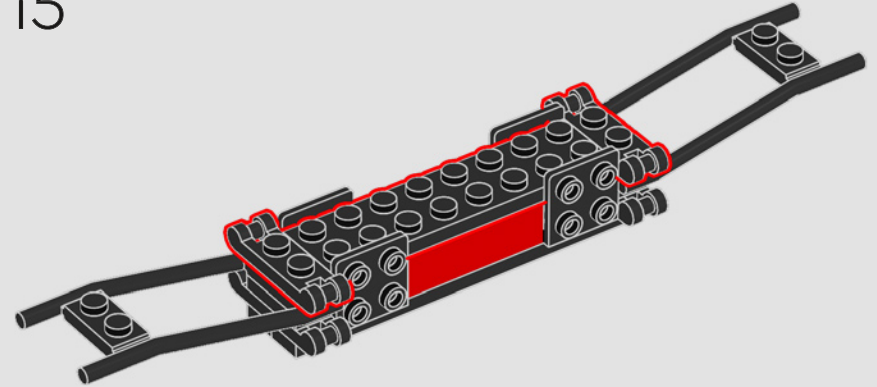

116

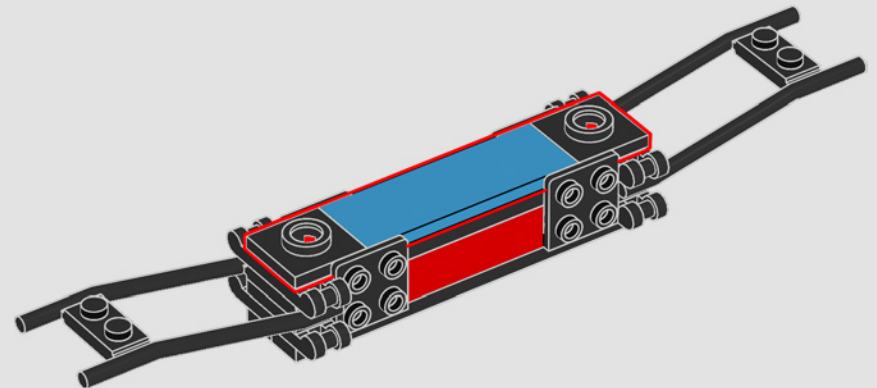



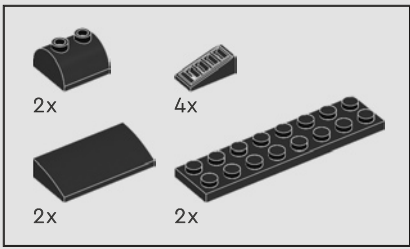

117

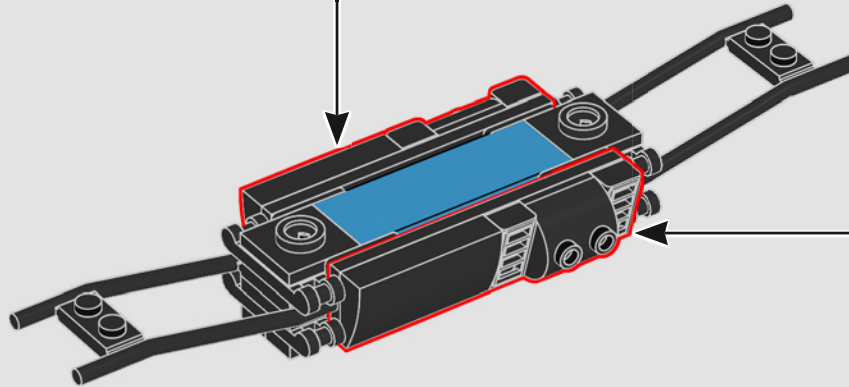
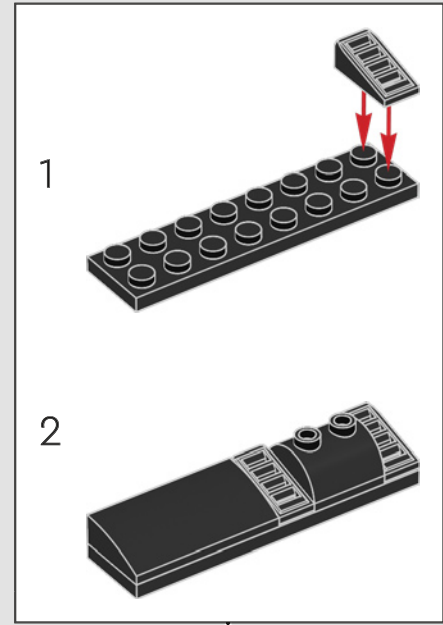
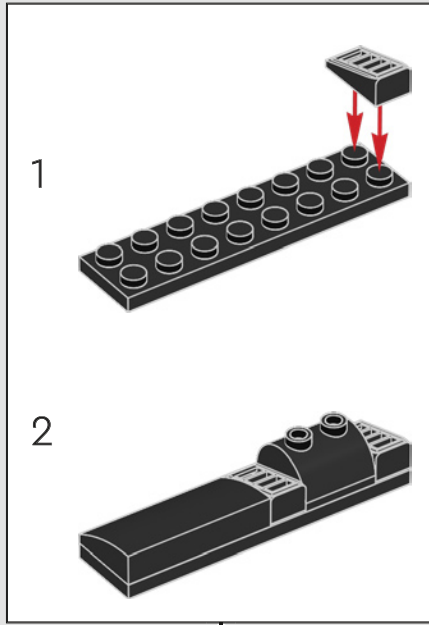

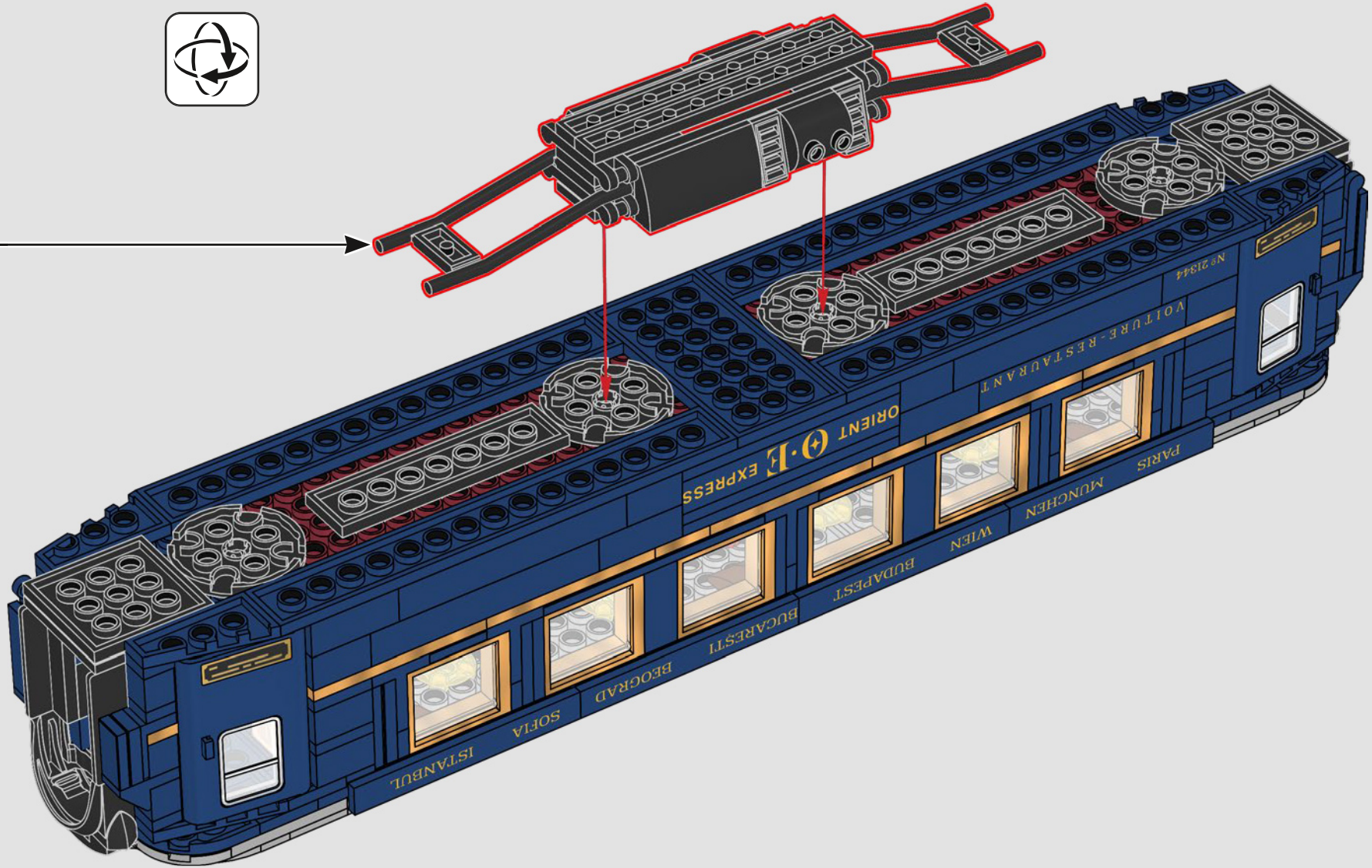

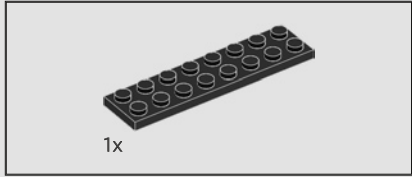
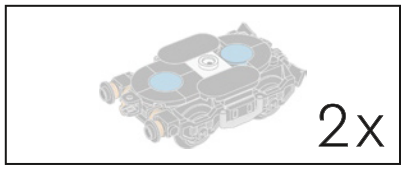

119

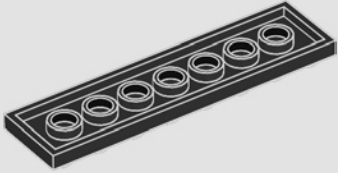

120

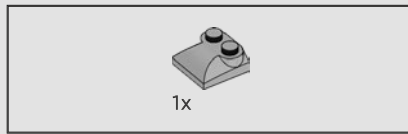
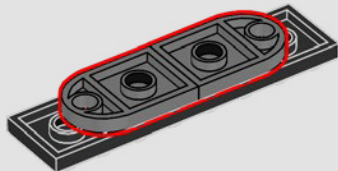

121

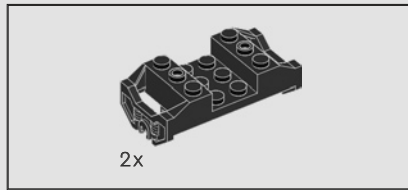
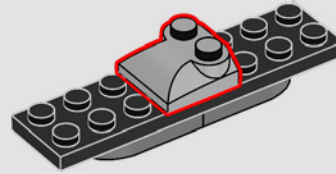

122

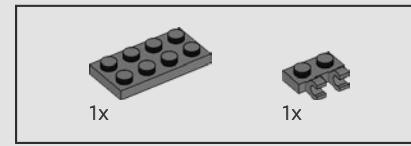
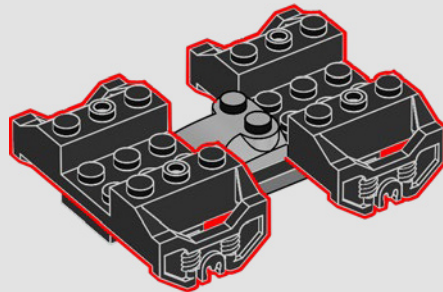

123

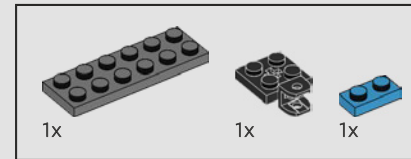
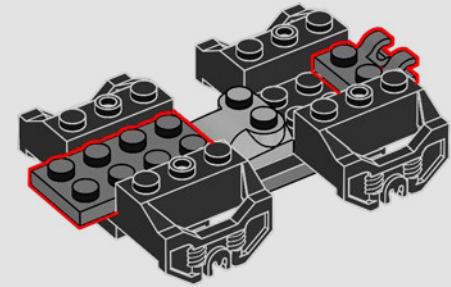

124

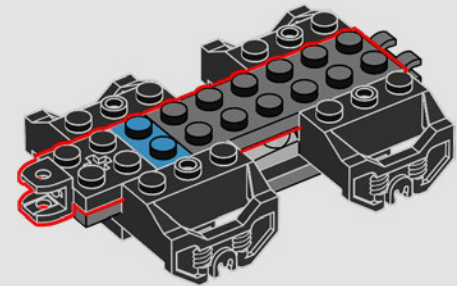



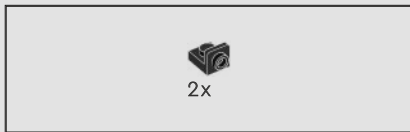

125

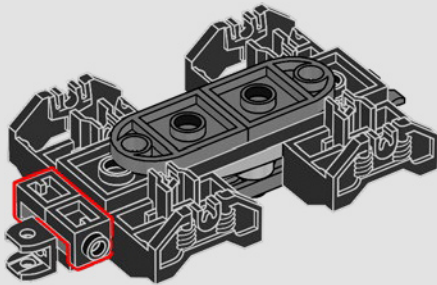

126

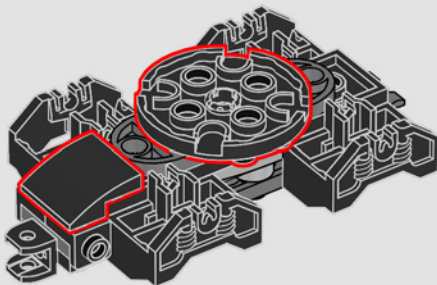

127

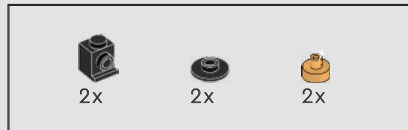
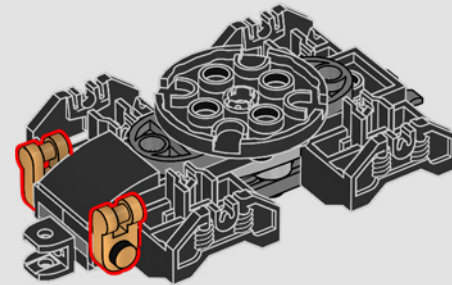

128

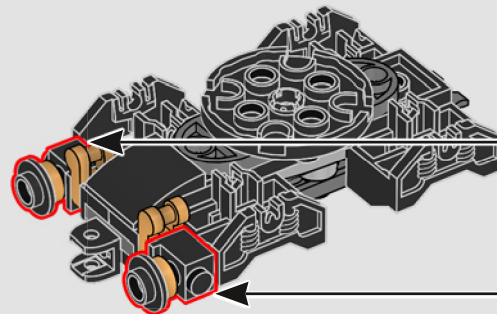
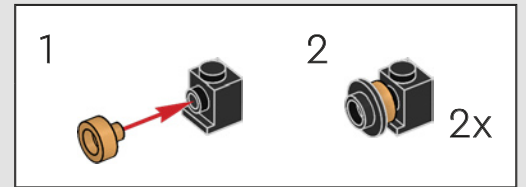

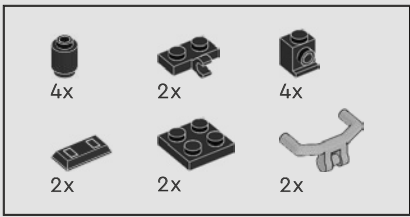

129

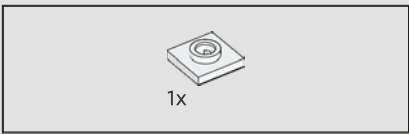
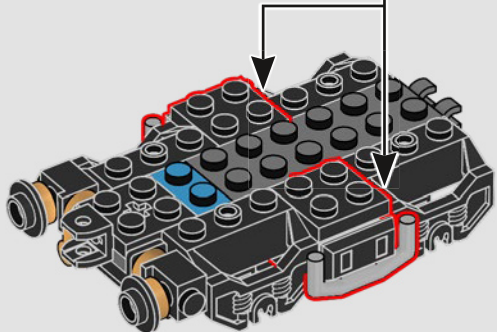
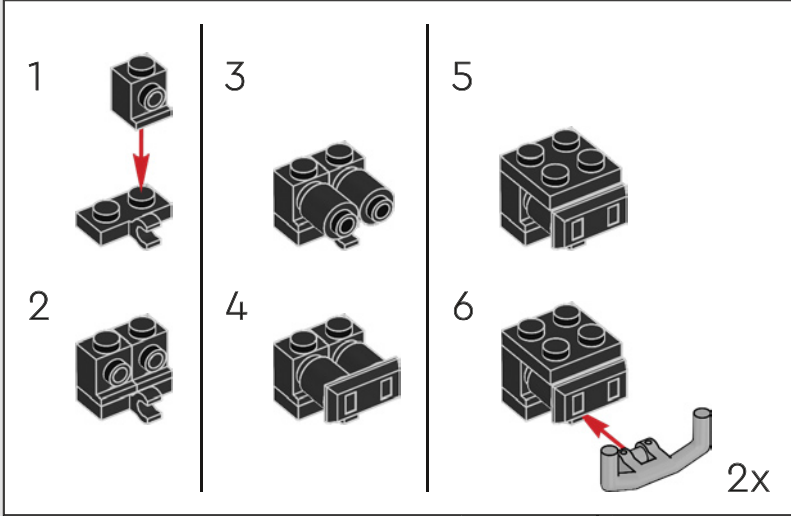

130

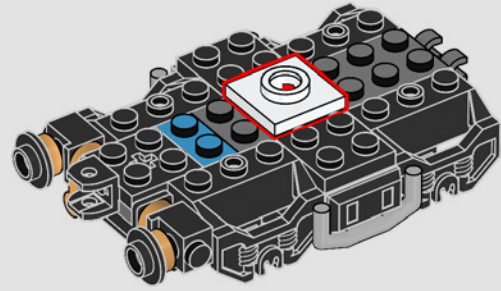

131

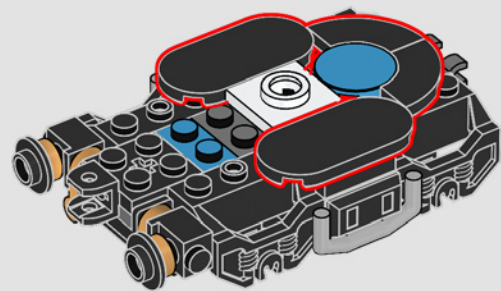



132

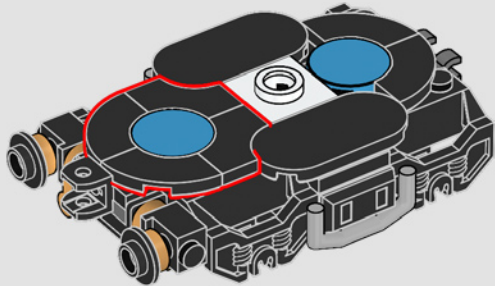

133

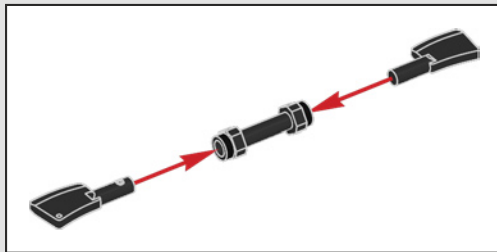
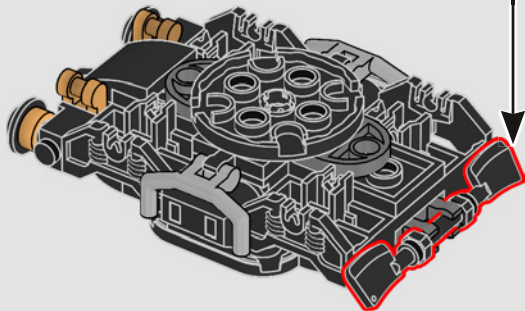

134

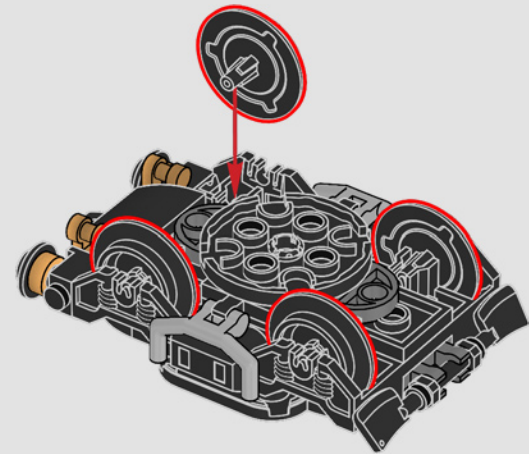

2x



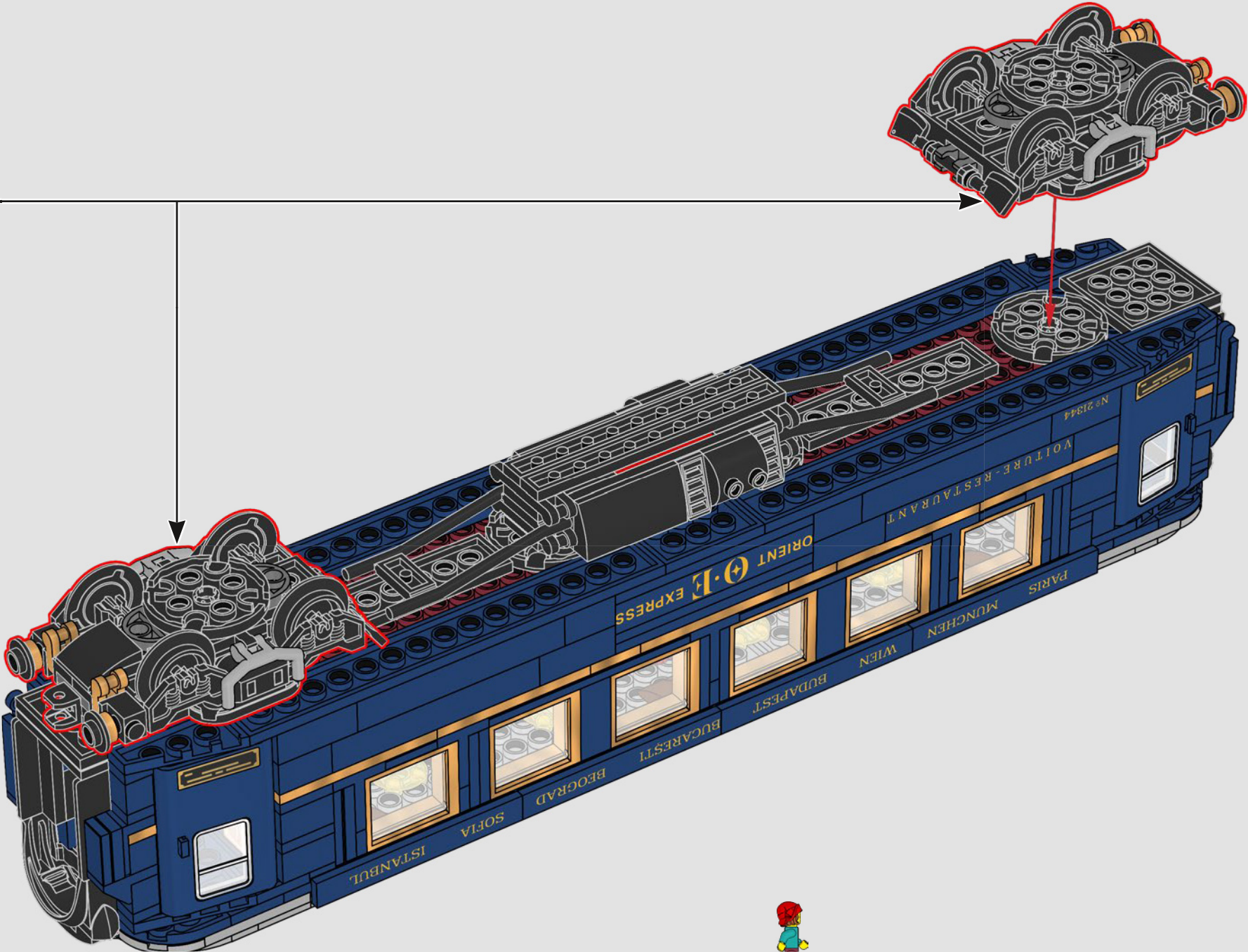

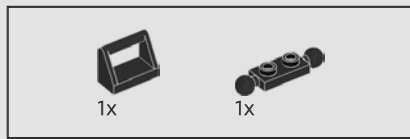

Fermata successiva: VIENNA

"Dopo una splendida cena a base di piatti raffinati, è arrivato il momento di ritirarsi nella carrozza letto".

136

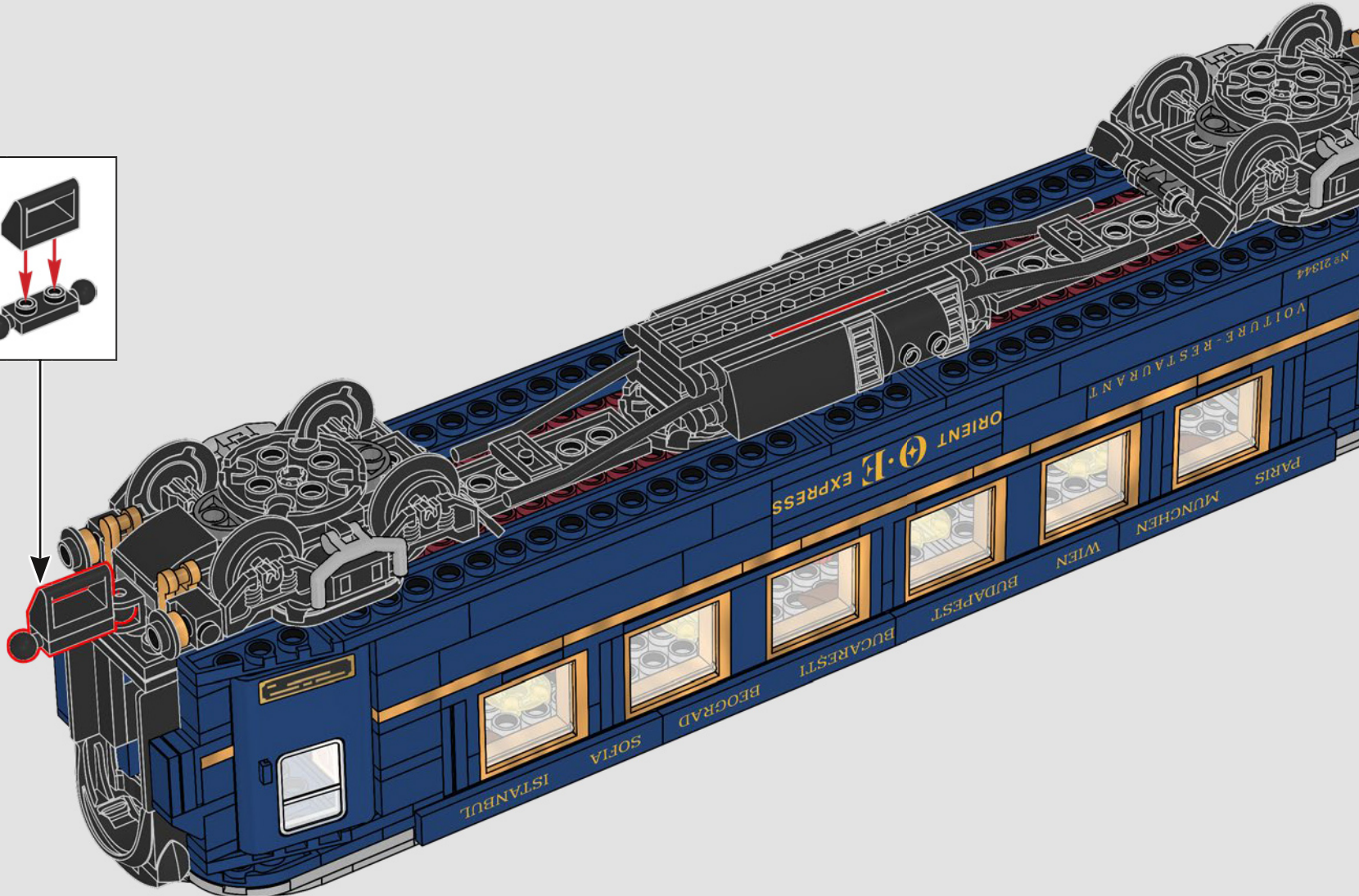
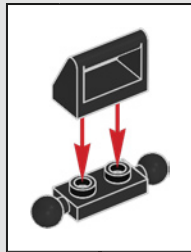



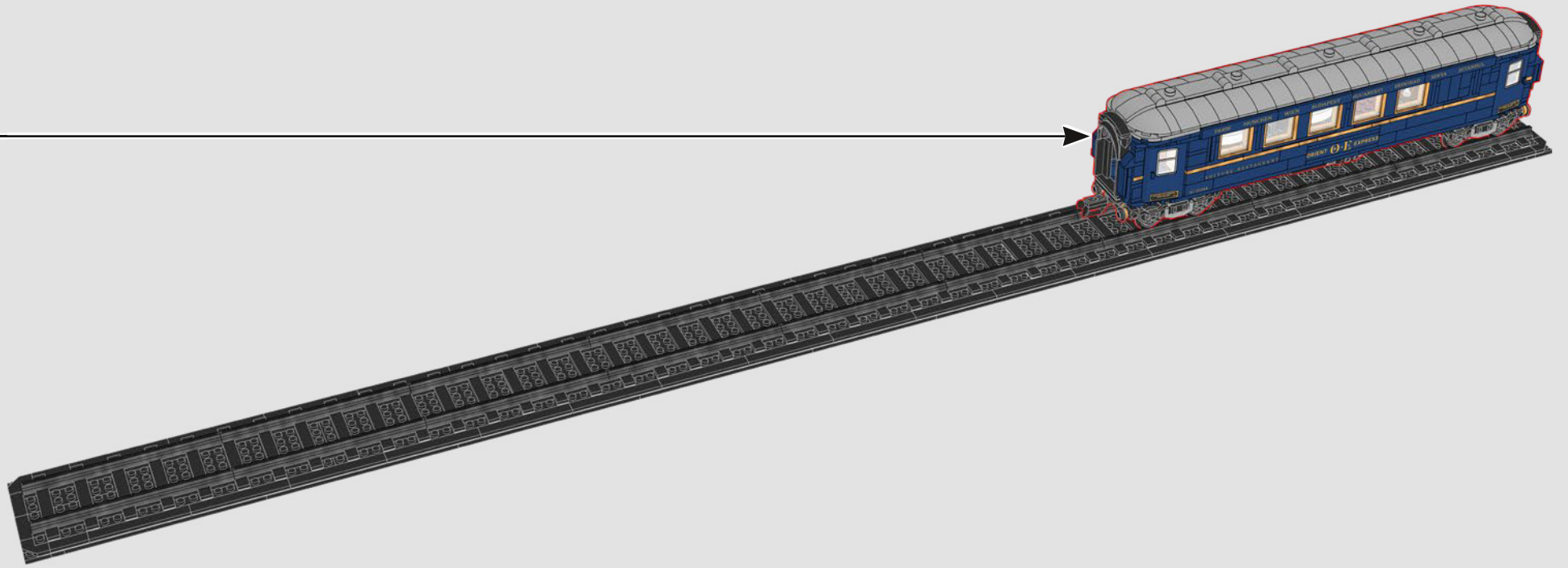





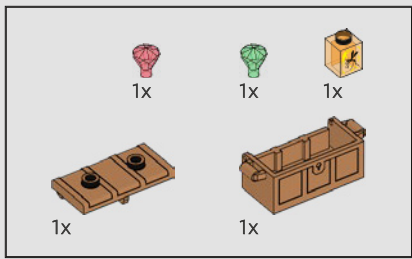

5

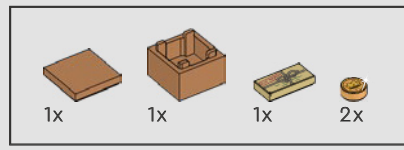
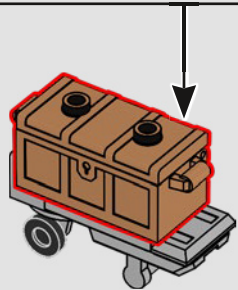
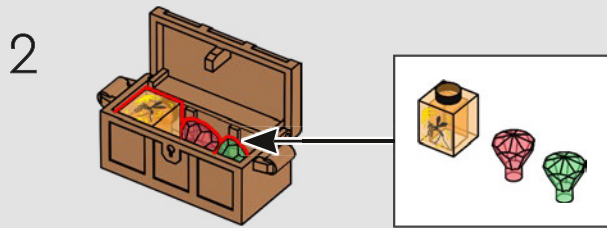
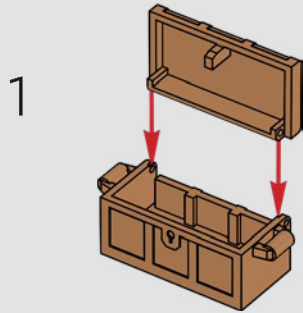

6

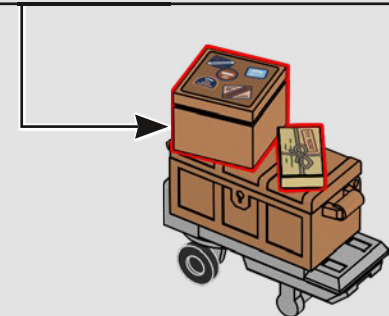
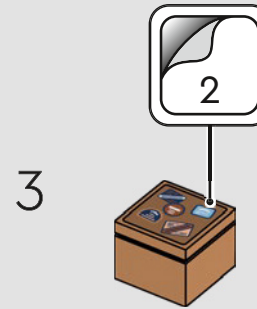
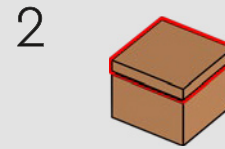
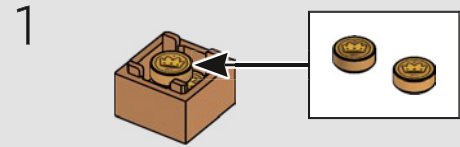

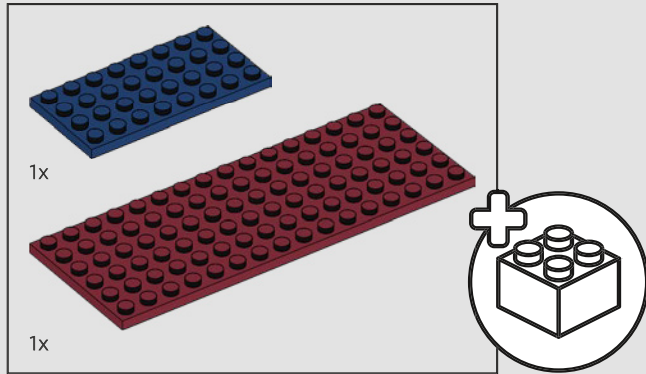
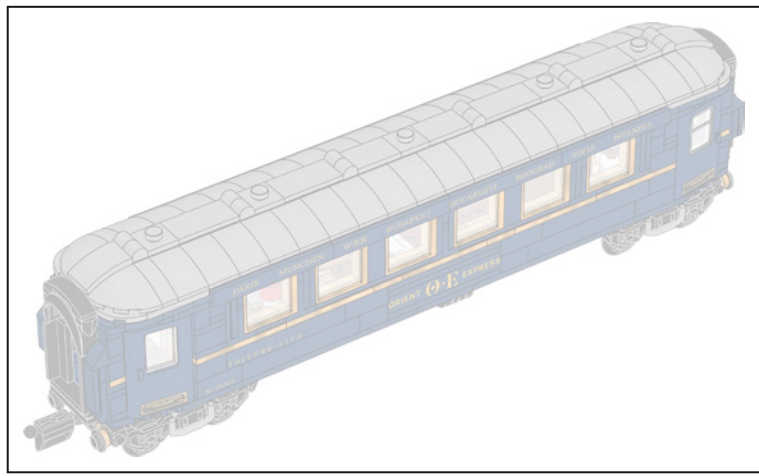

138

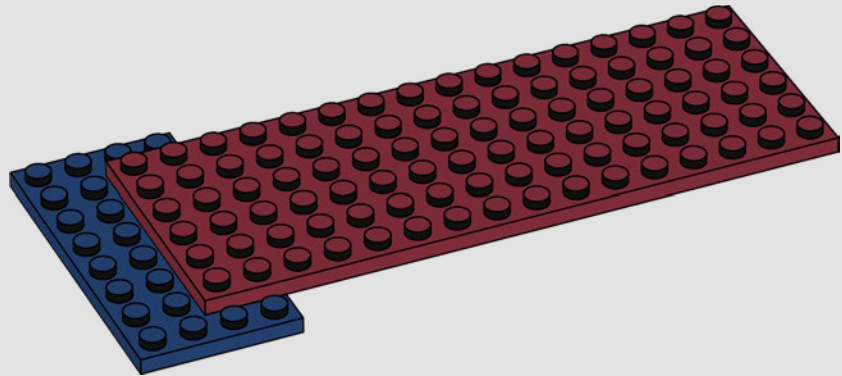



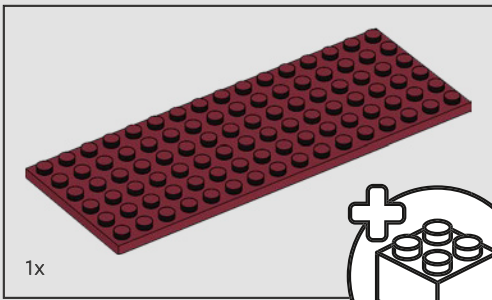

1x

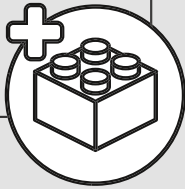

139

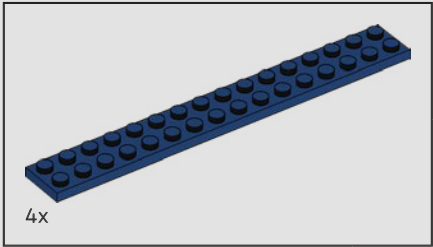
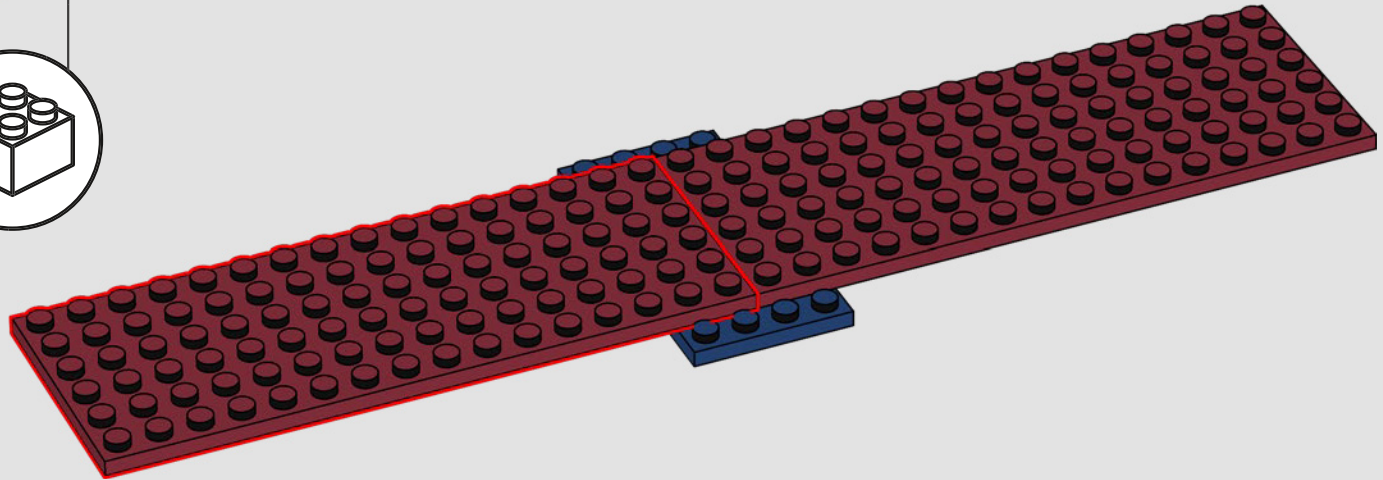

4x

140

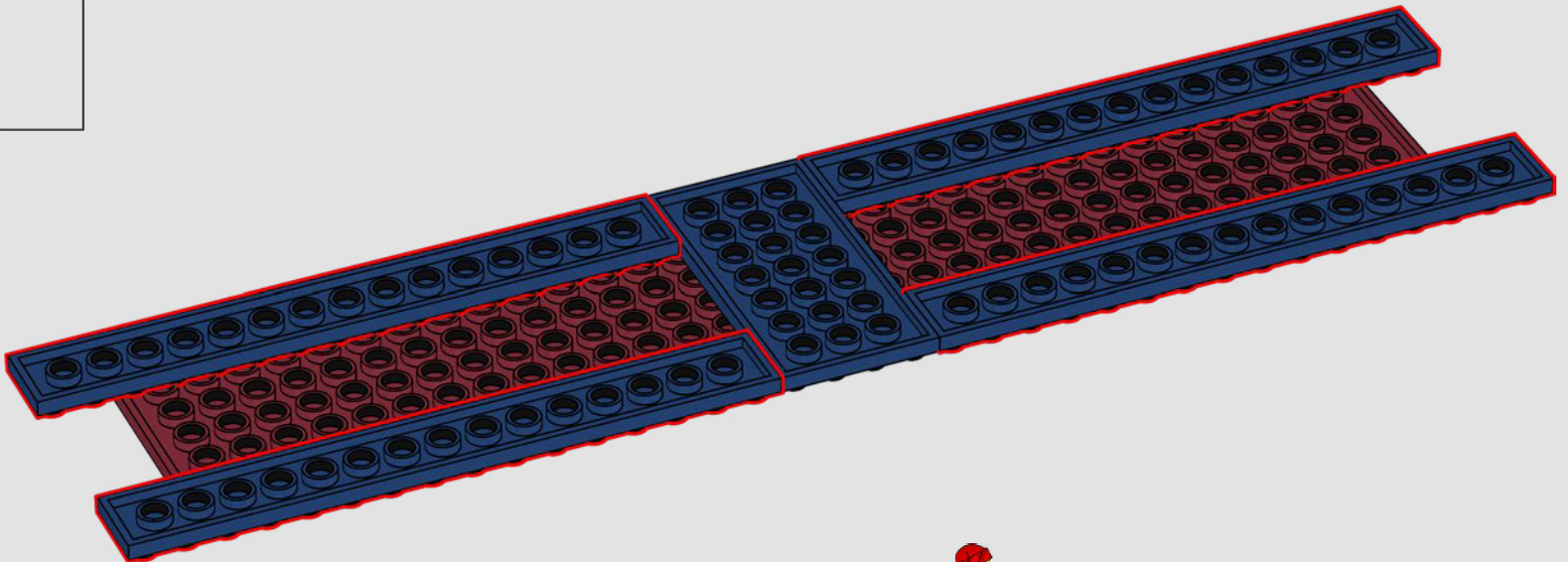

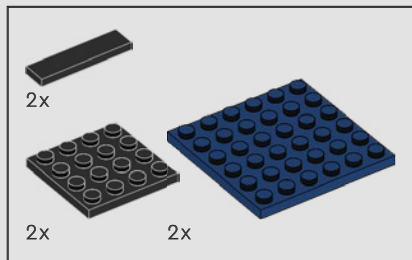

141

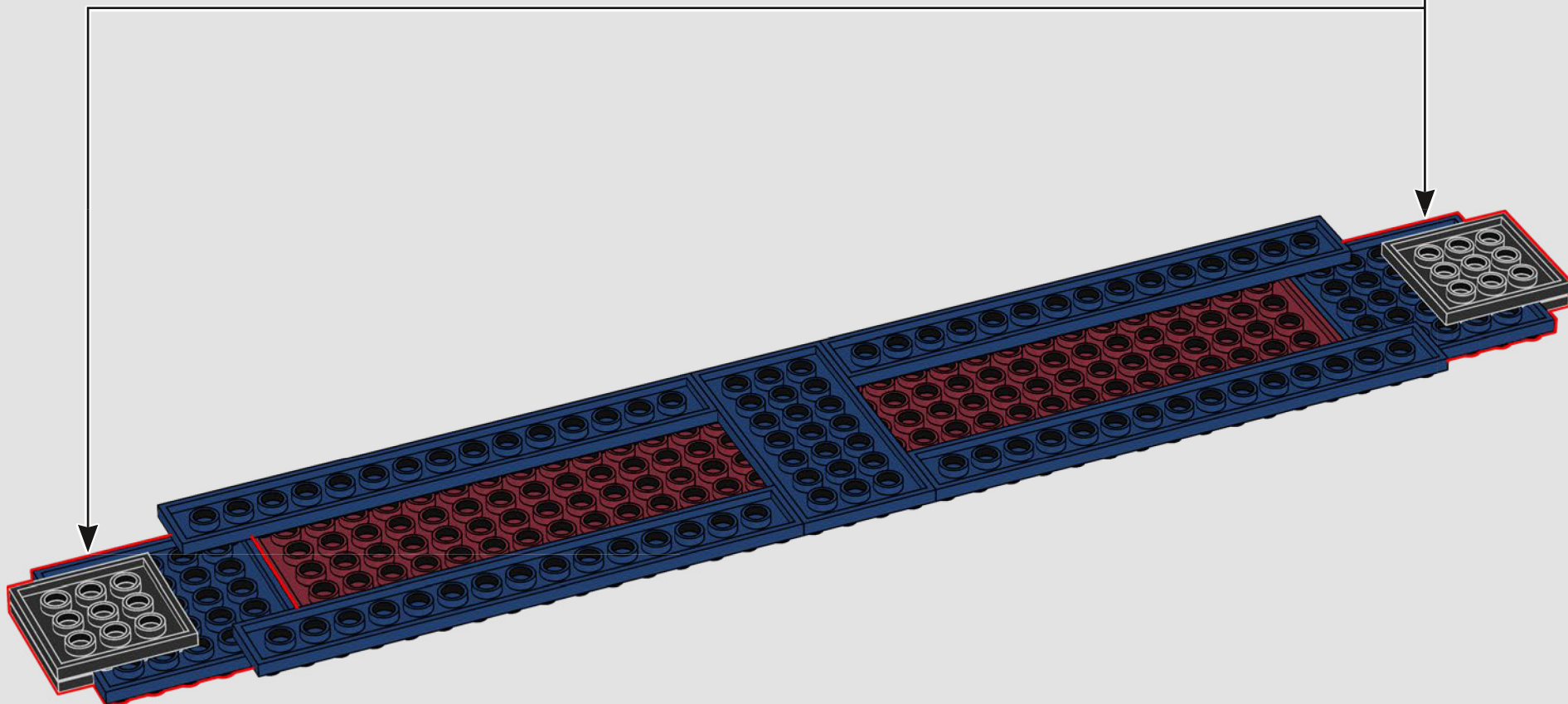
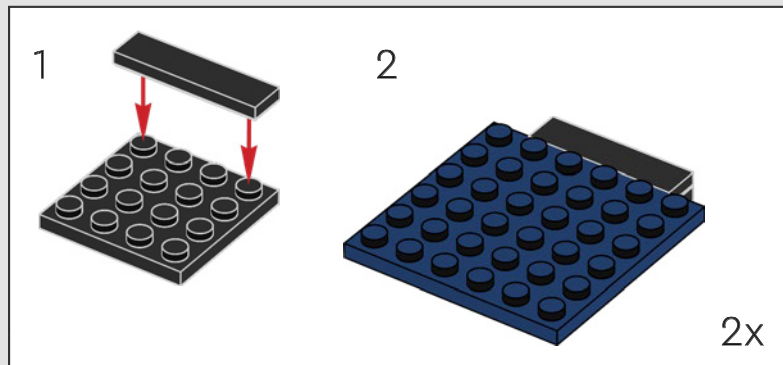



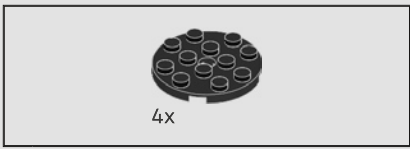

142

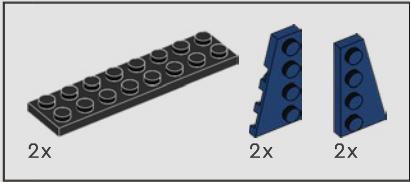
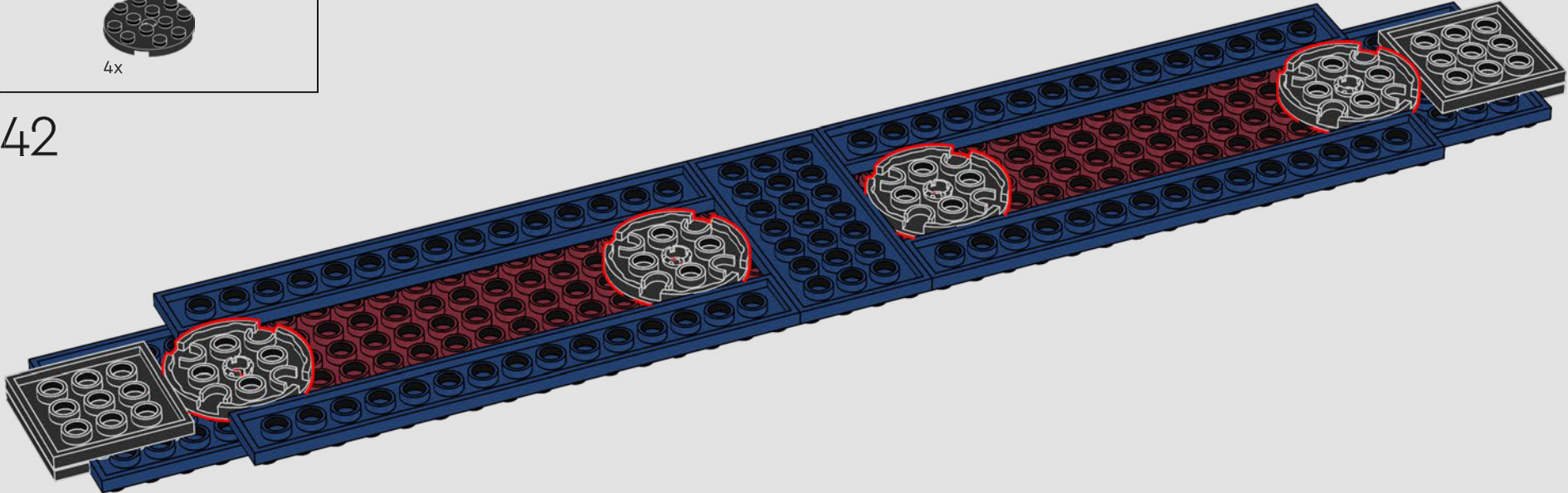

143

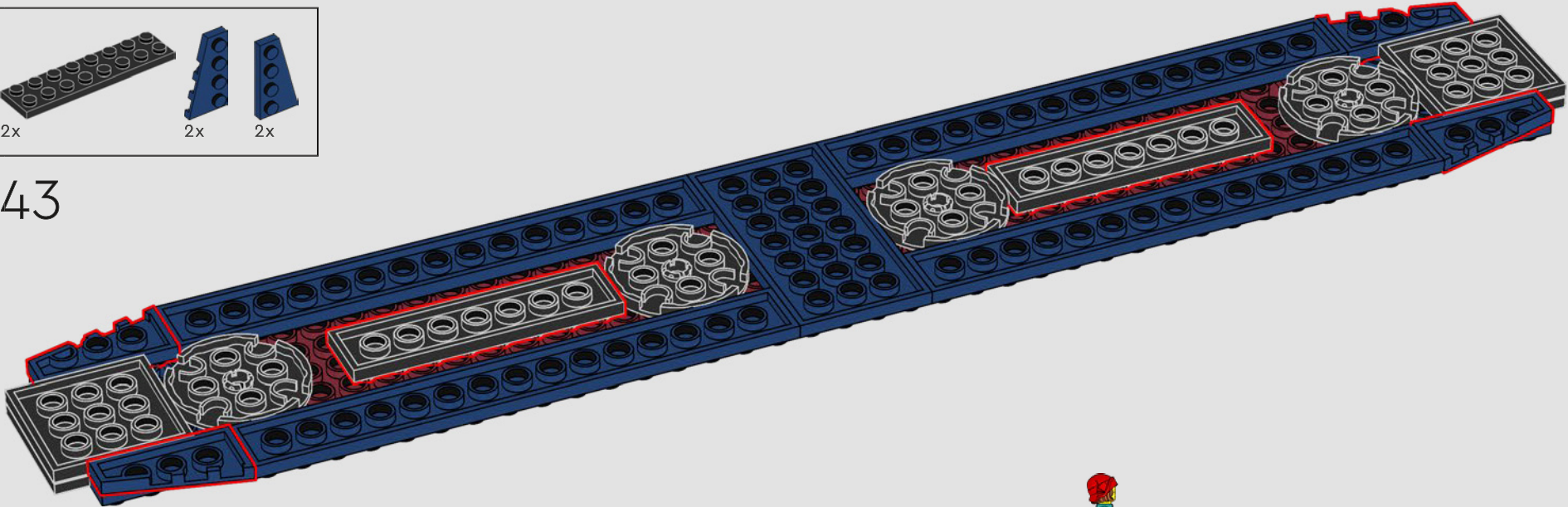





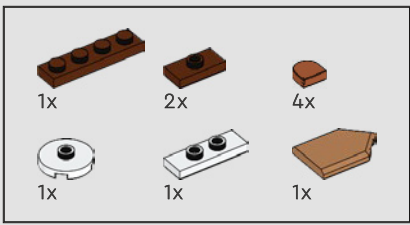

146

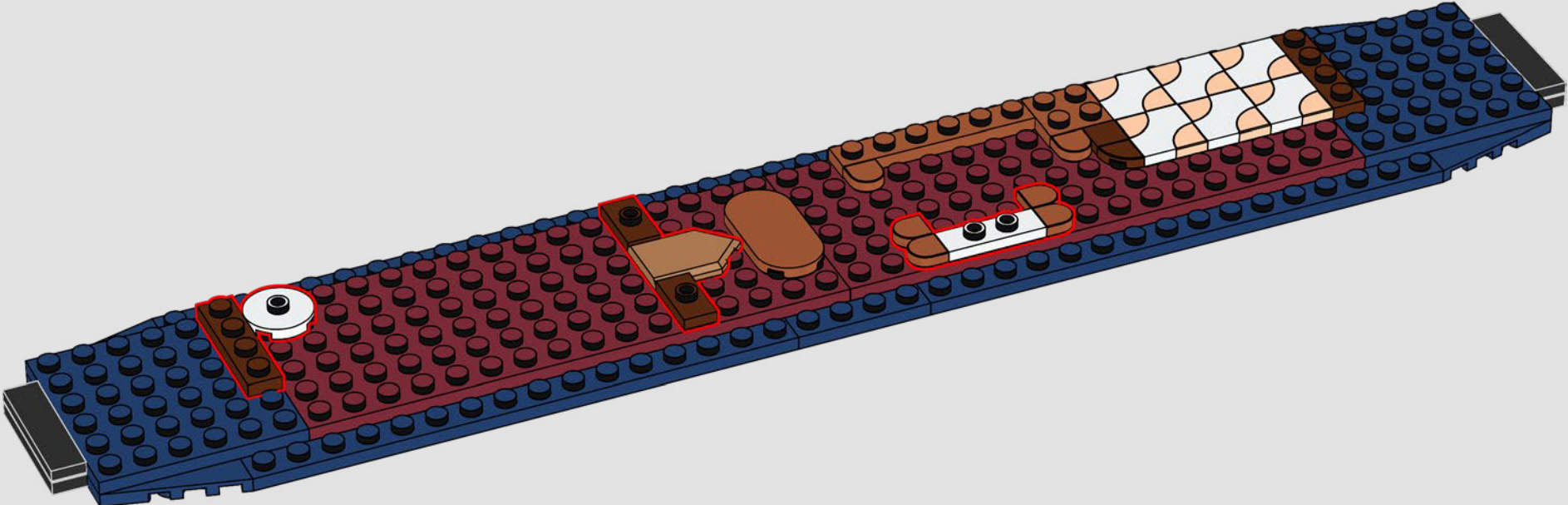

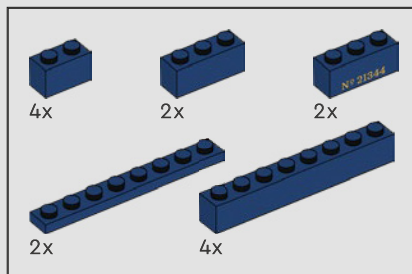

147

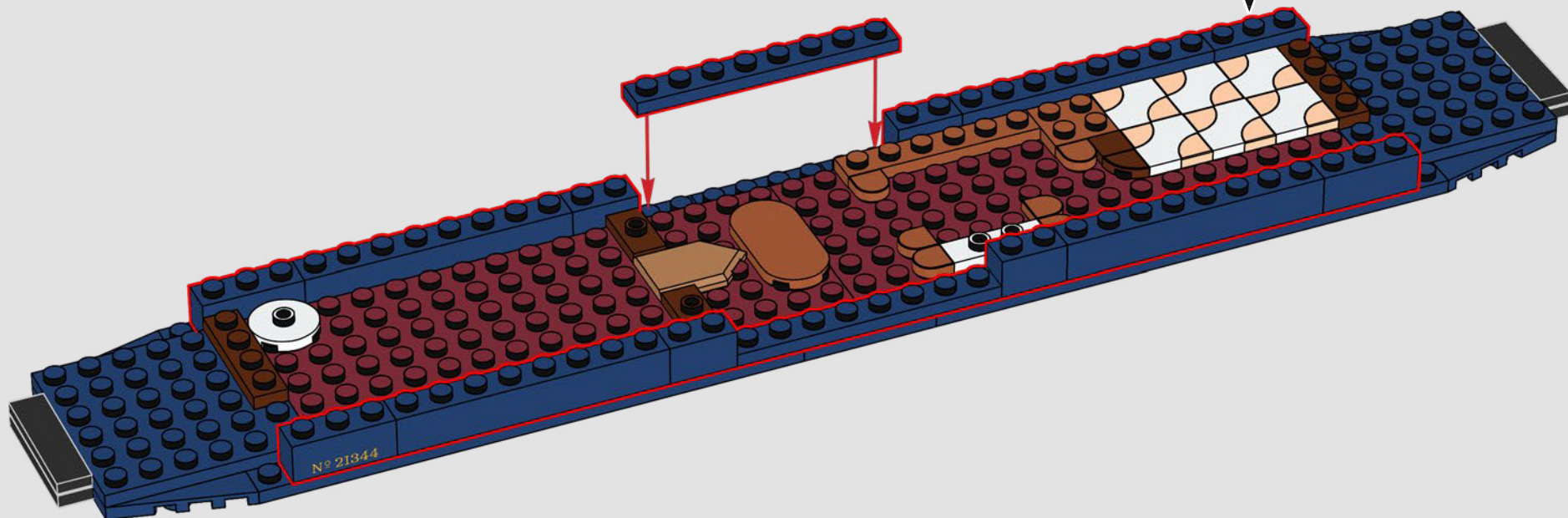



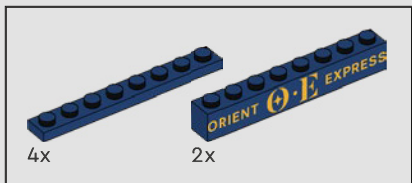

148

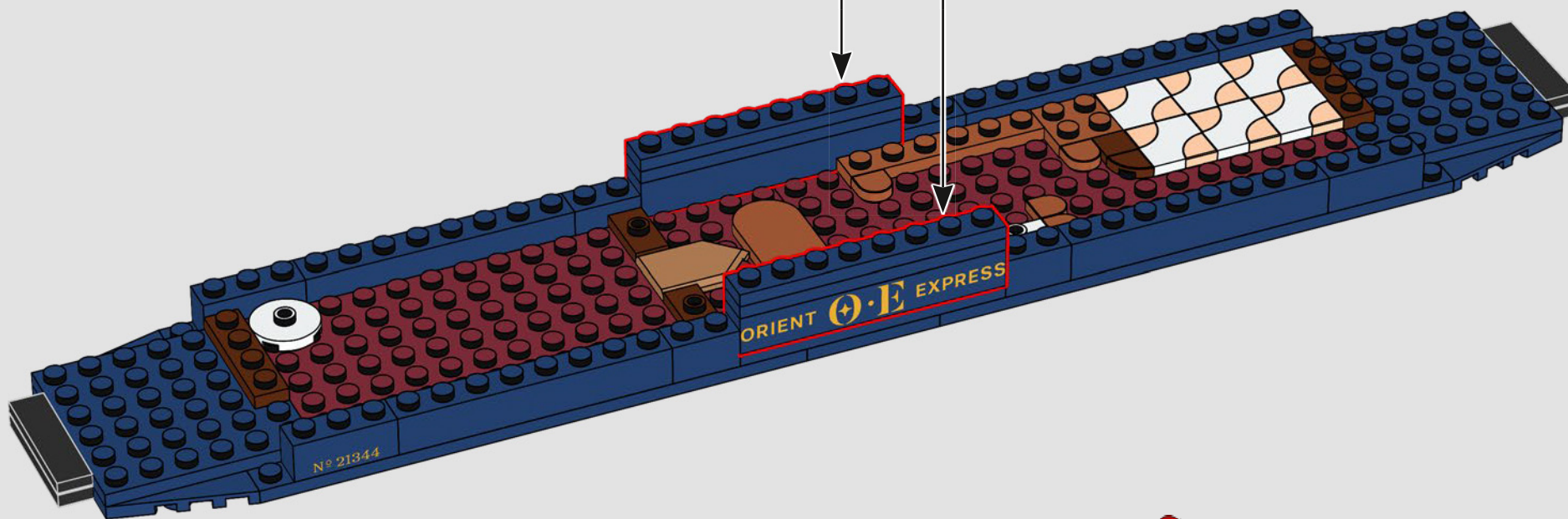
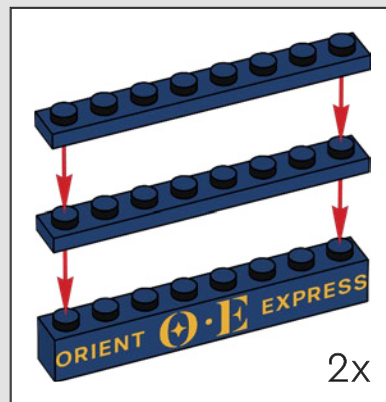

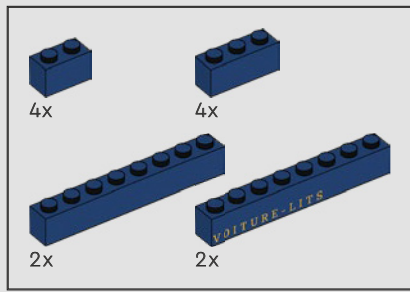

149

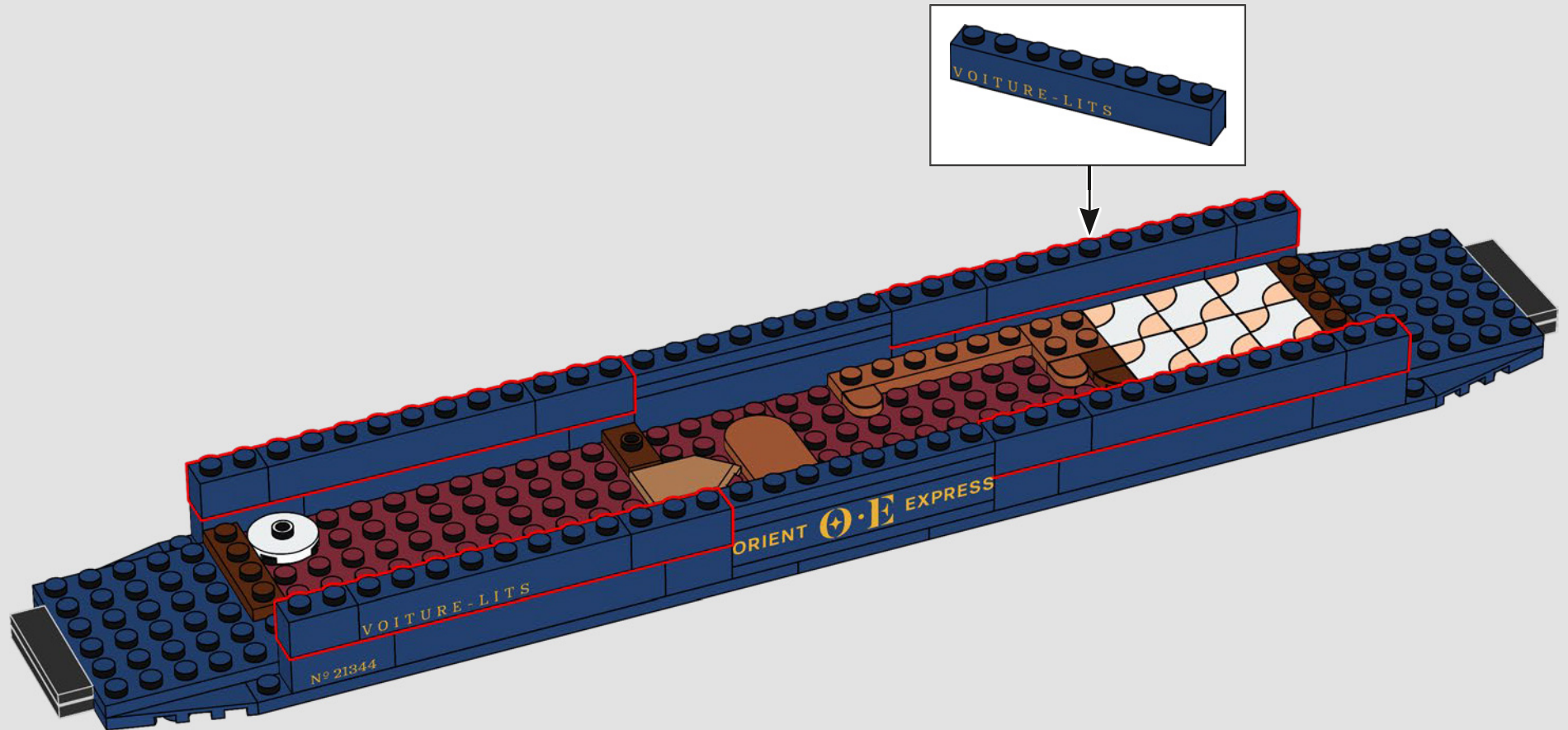

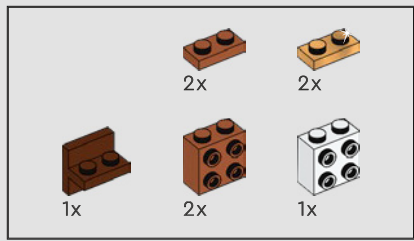

150

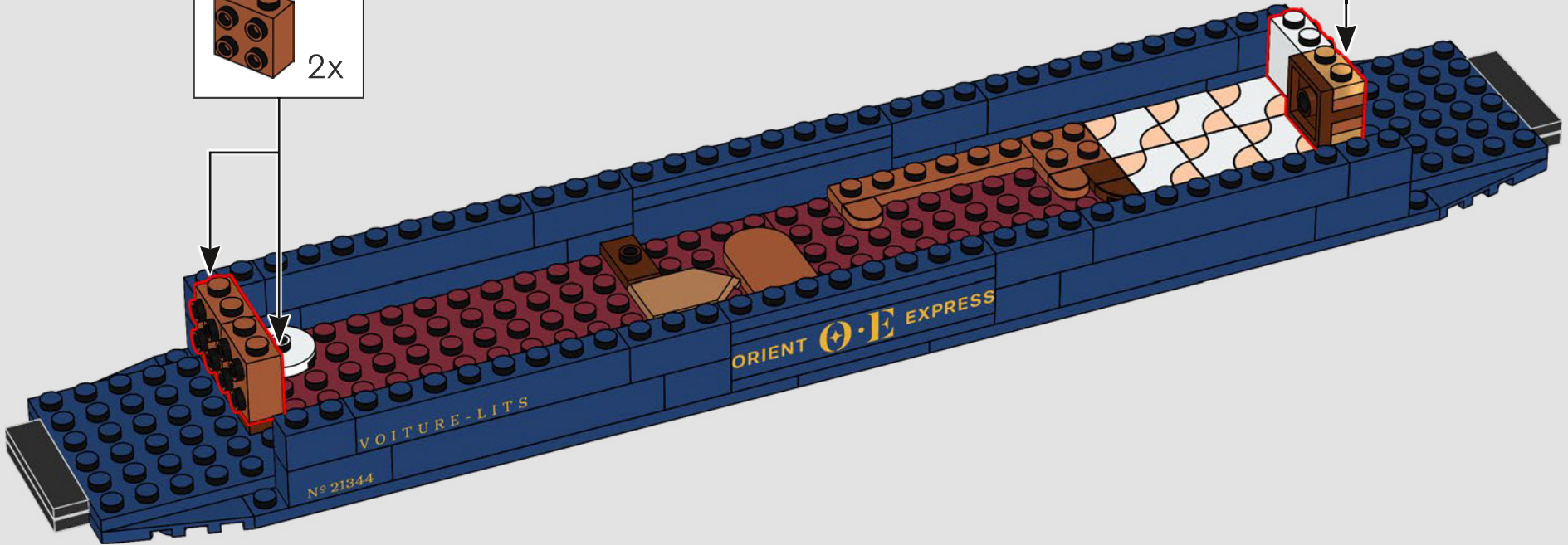
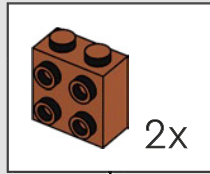
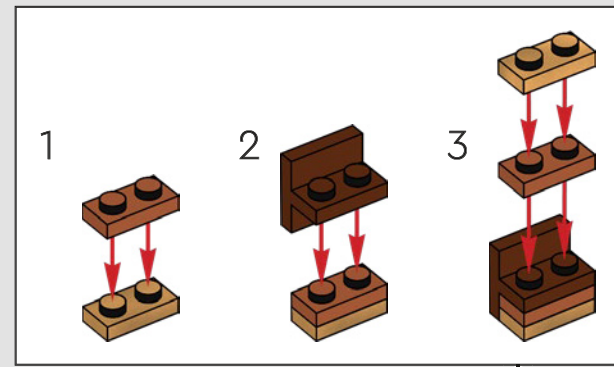



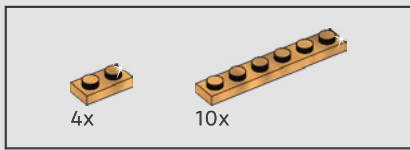

151

Fermata successiva: BUDAPEST  
"A tutto vapore lungo il Danubio in direzione  
Budapest... l'acqua brillava come l'oro".

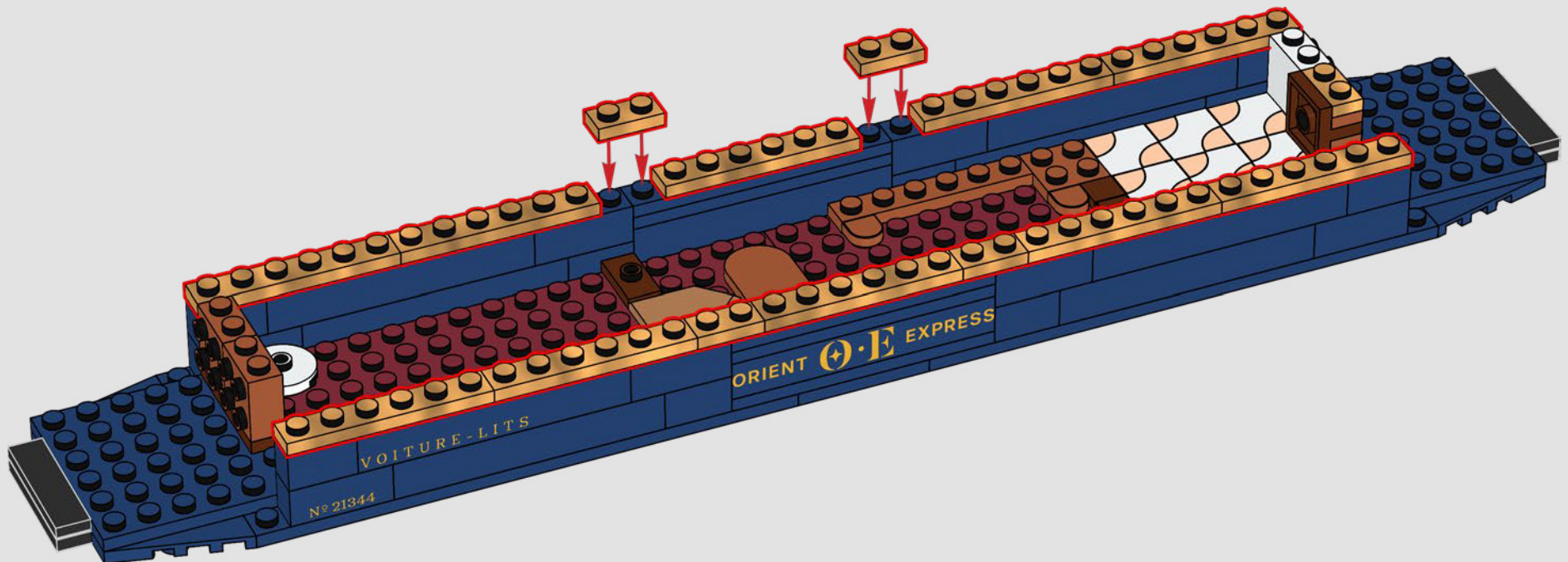

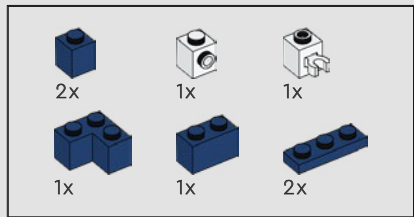

152

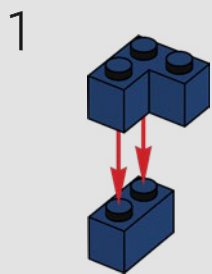

2

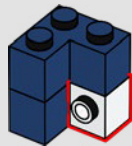

3

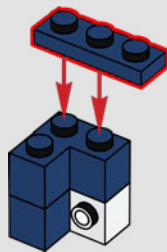

4

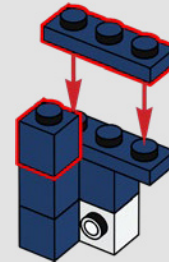

5

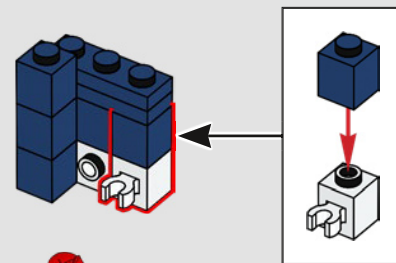

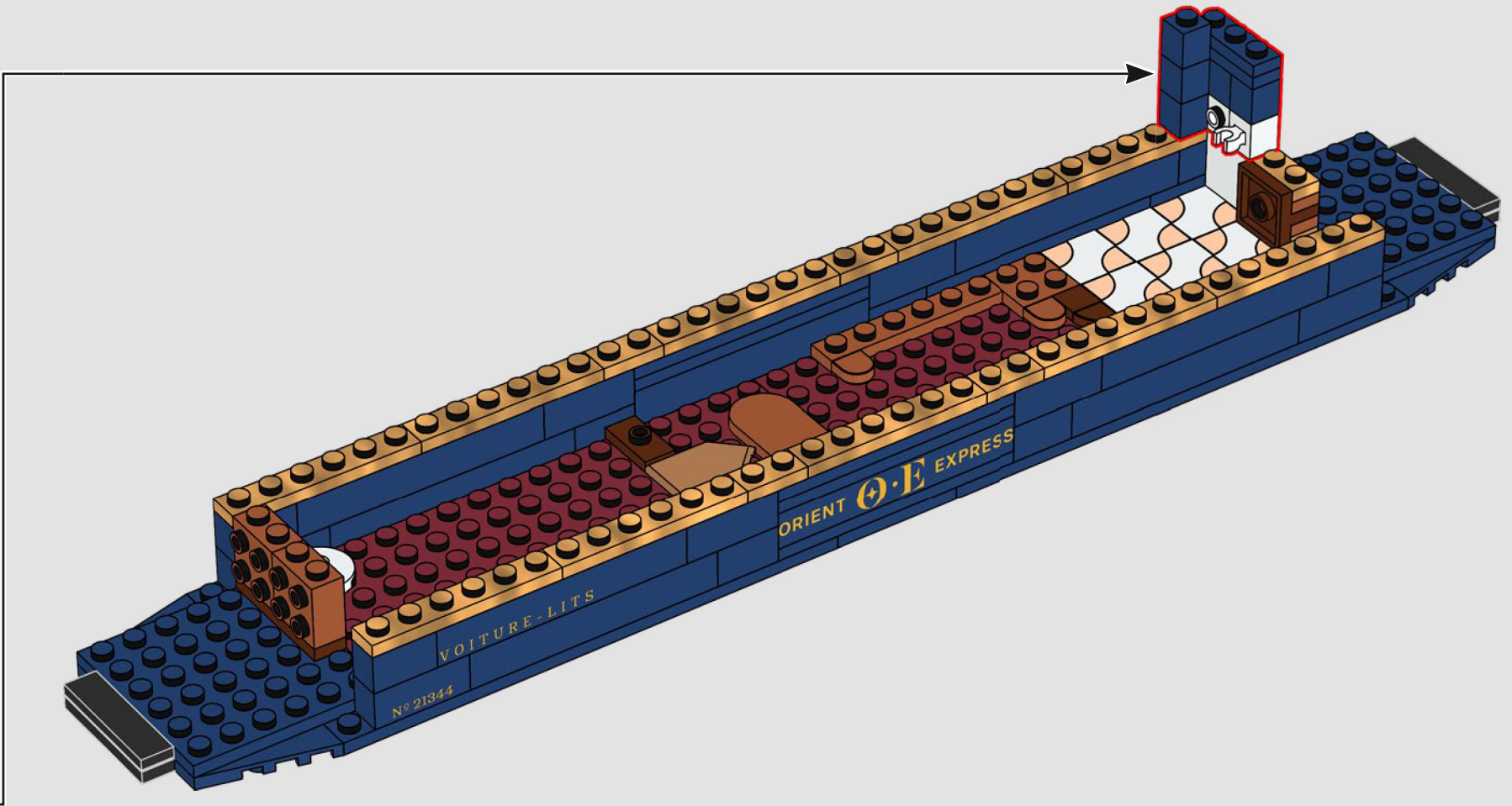



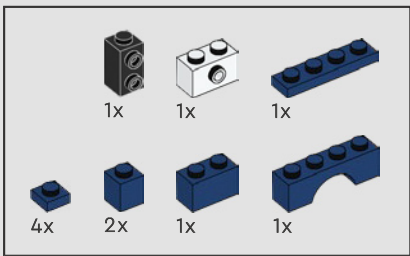

153

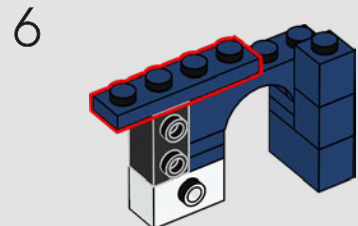
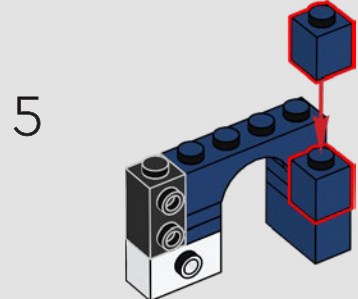
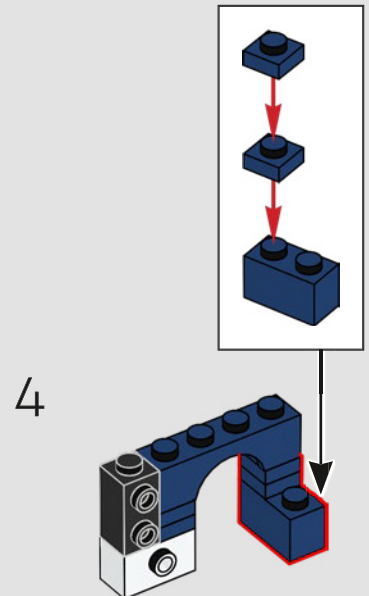
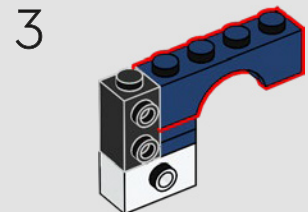
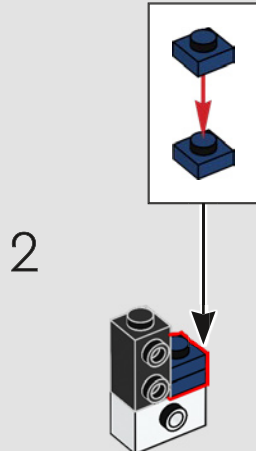
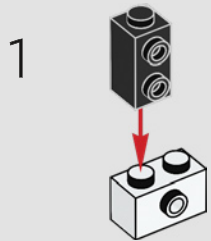

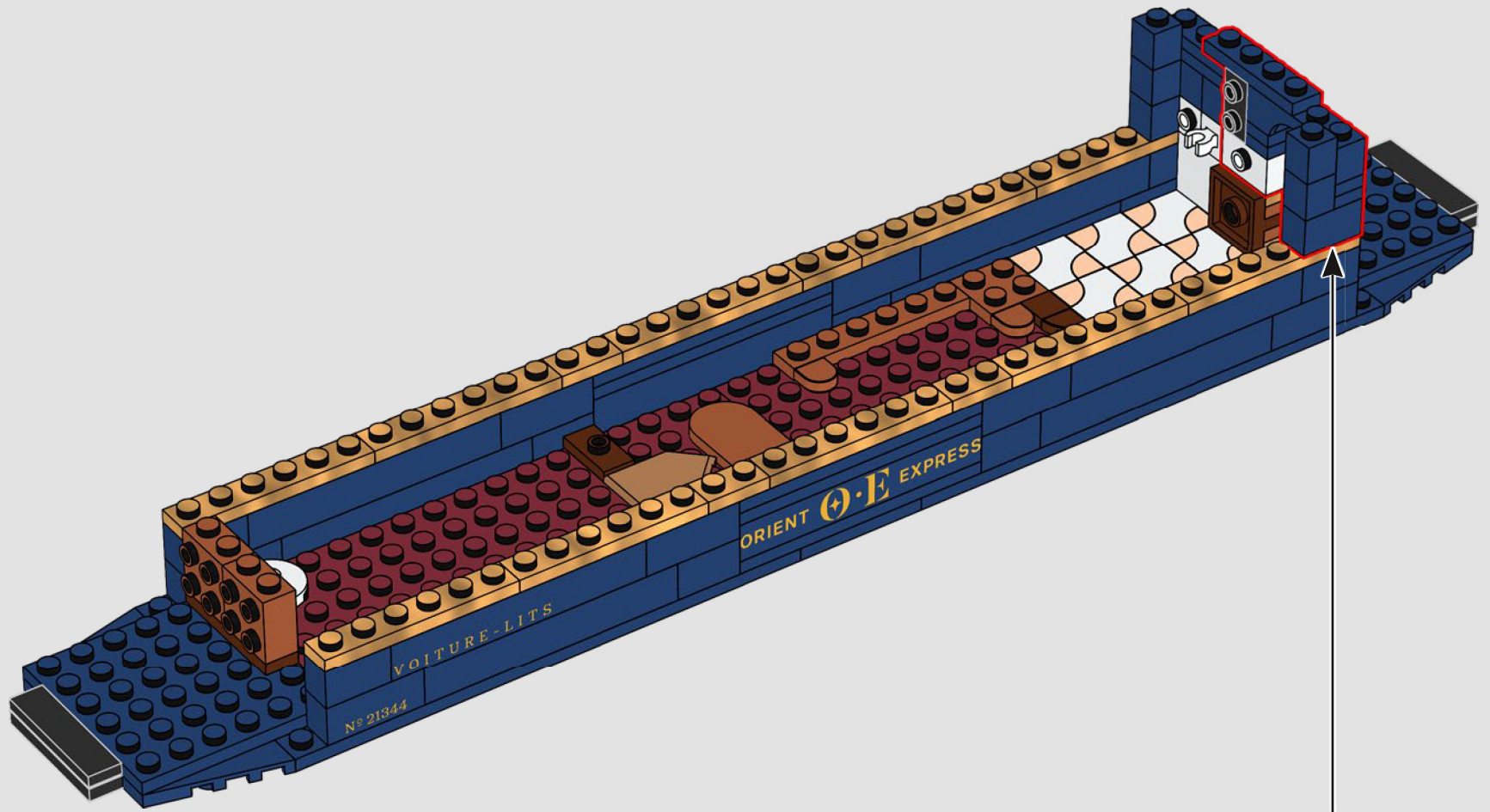

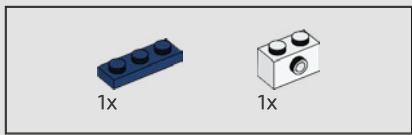

154

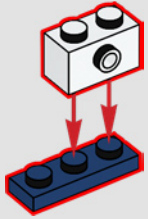

155

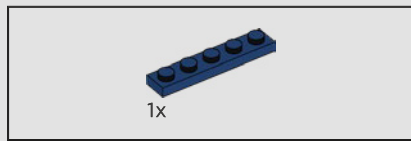
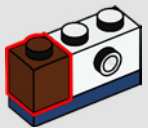

156

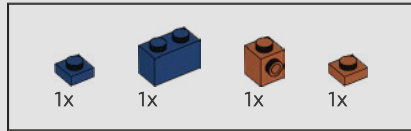
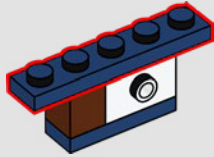

157

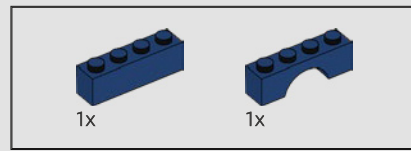
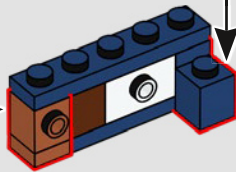
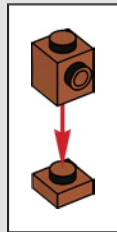
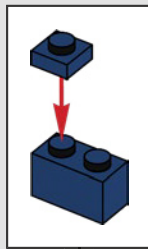

158

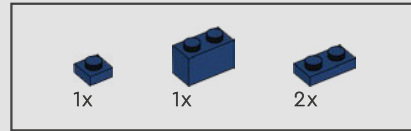
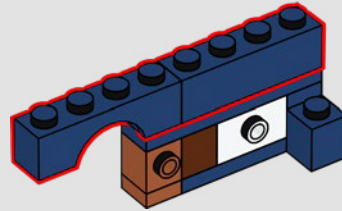

159

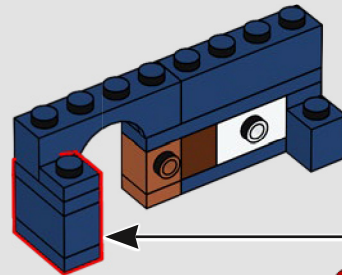
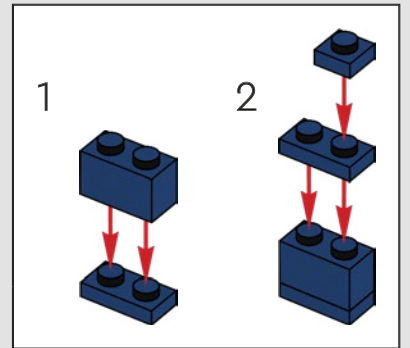



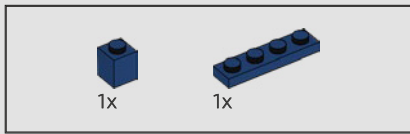

160

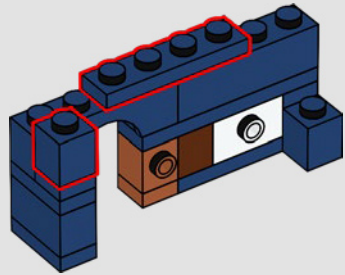

161

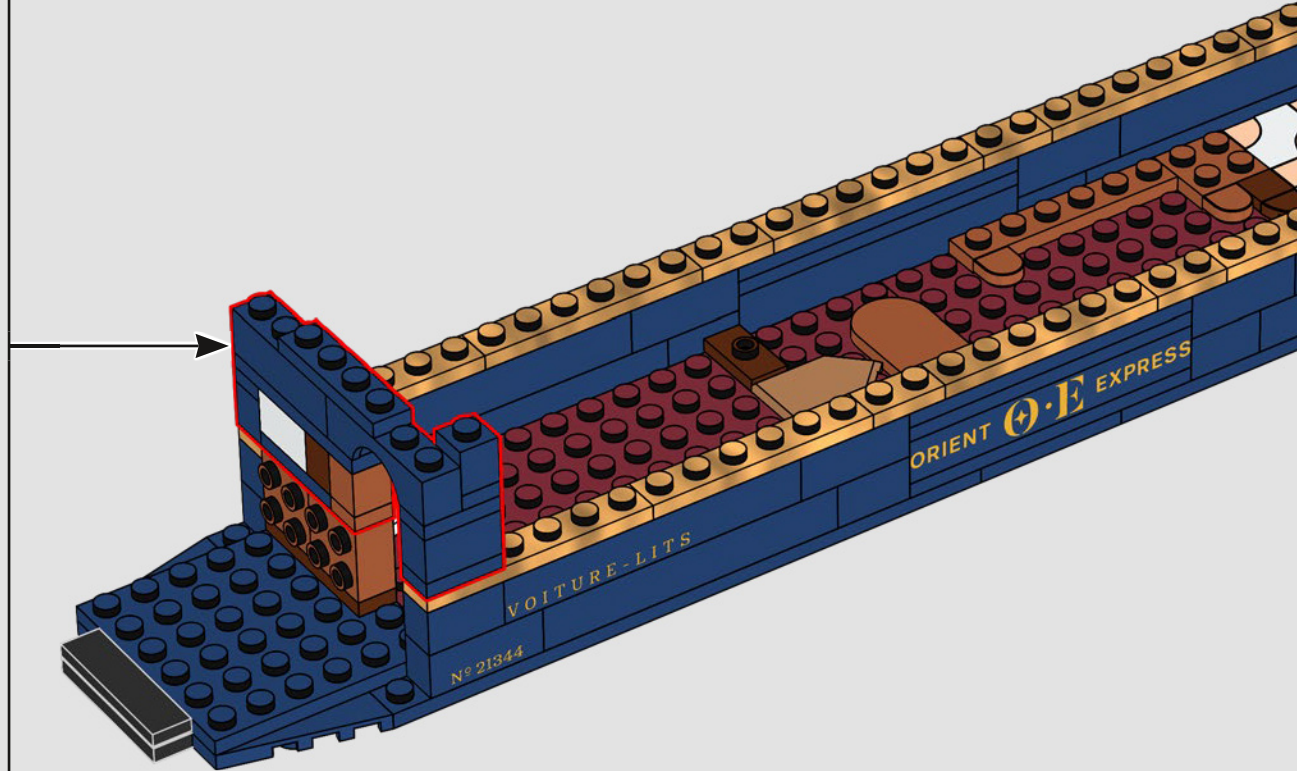

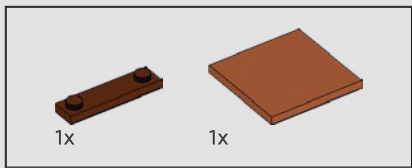

162

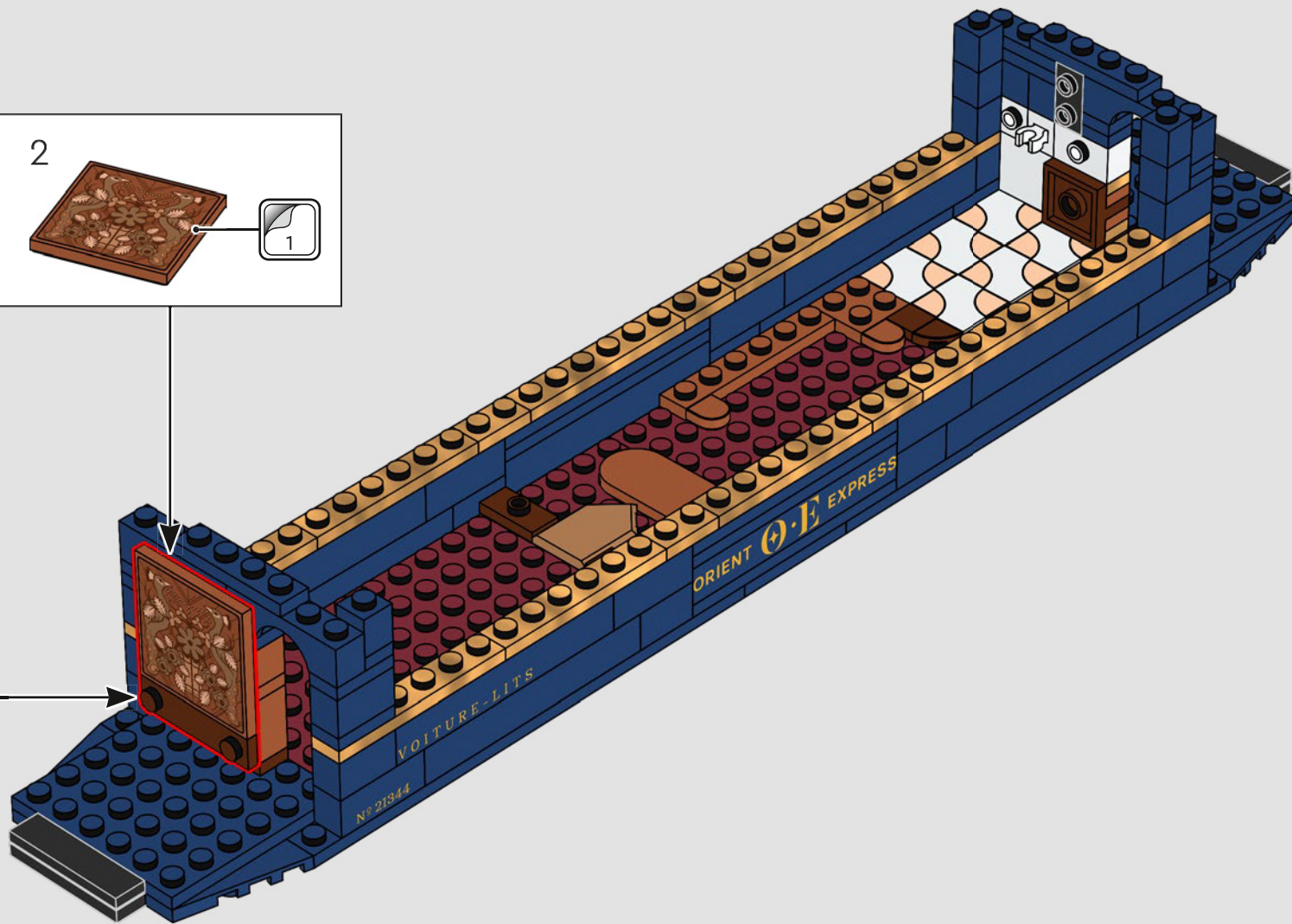
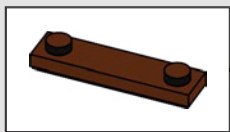

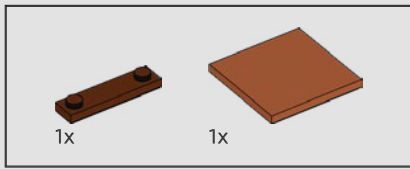

163

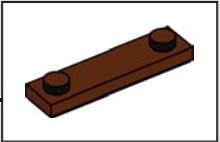
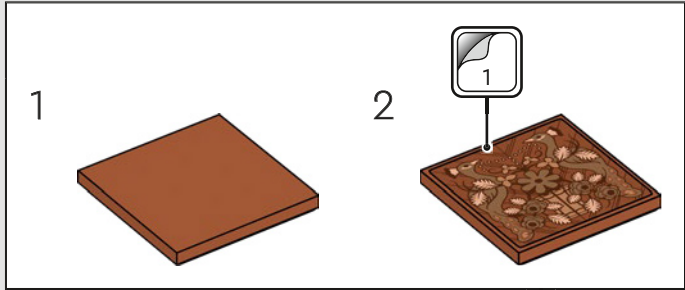
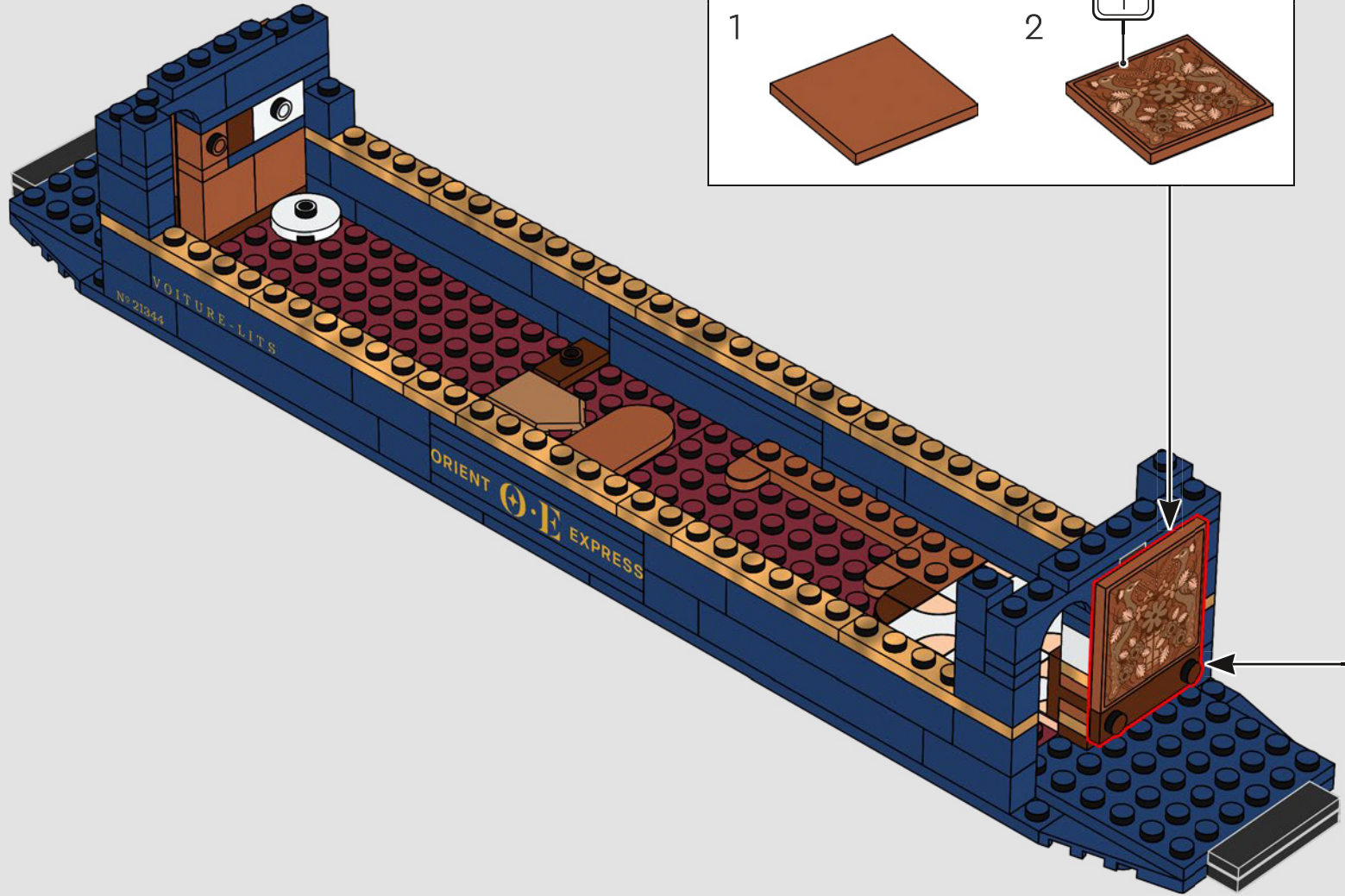





2x

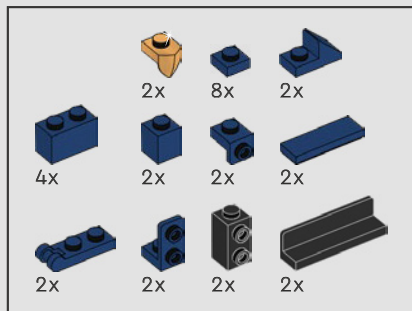

164

1

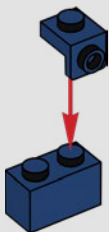

2

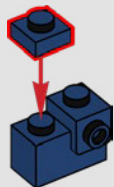

3

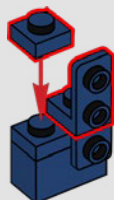

4

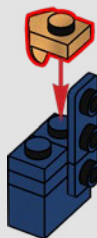

5

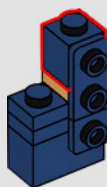

6

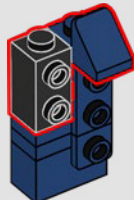

7

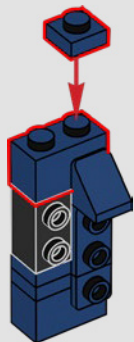

8

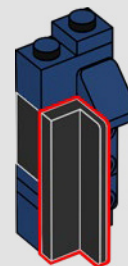

9

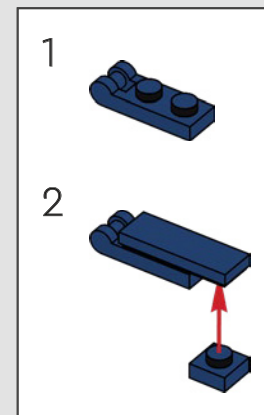

2x



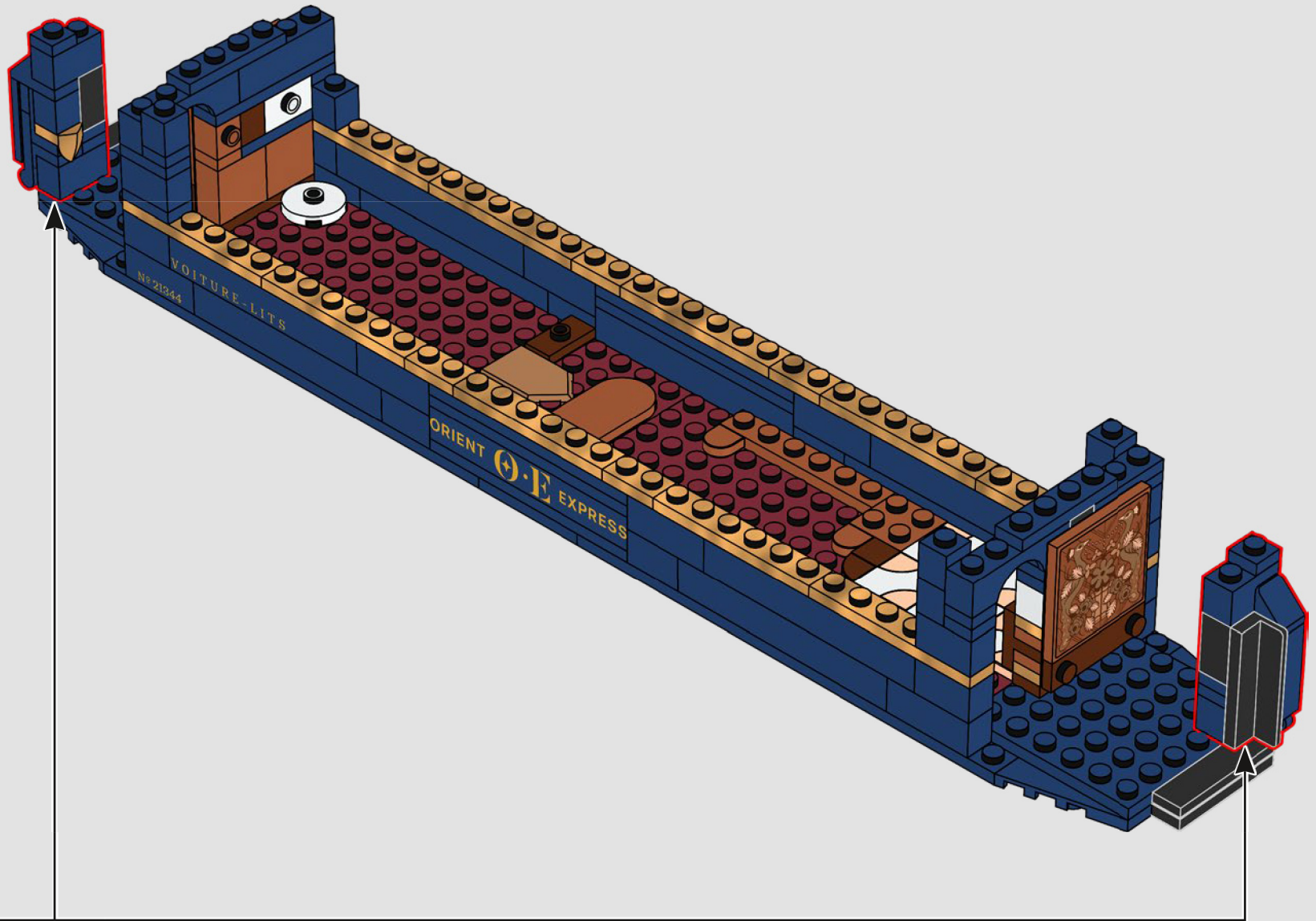



2x

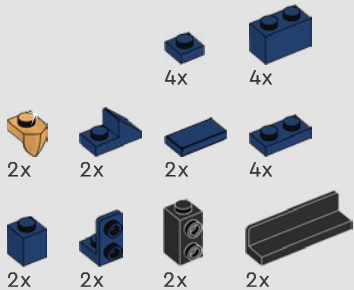

165

1

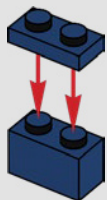

2

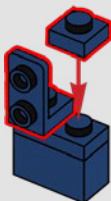

3

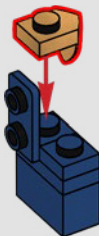

4

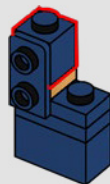

5

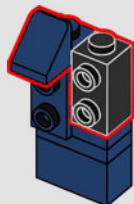

6

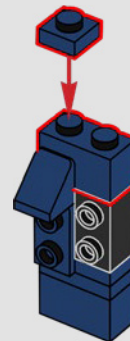

7

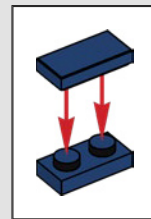

8

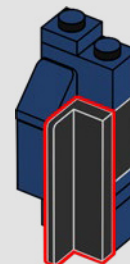

2x





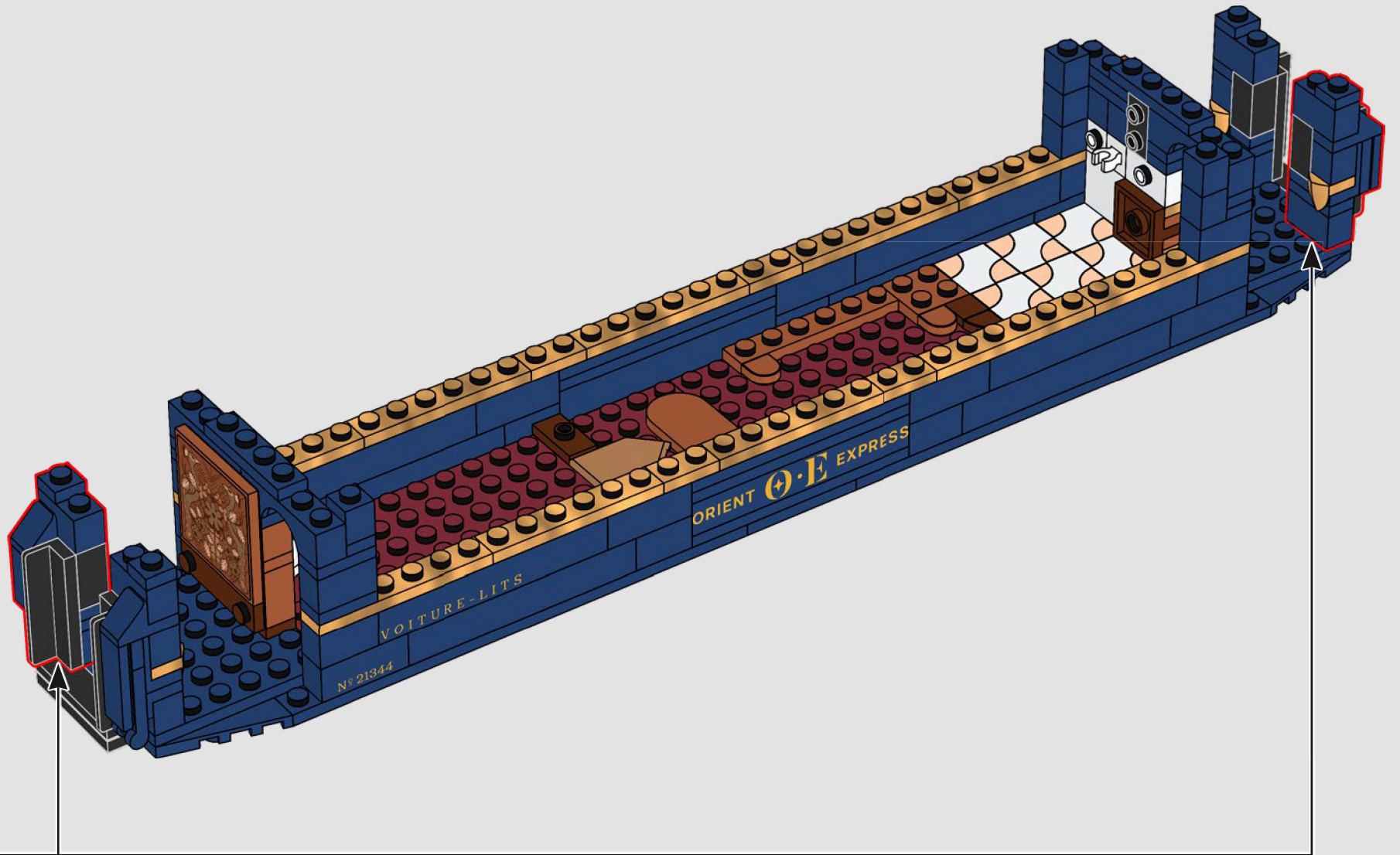

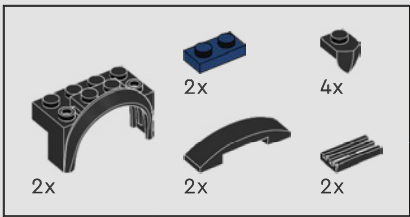

166

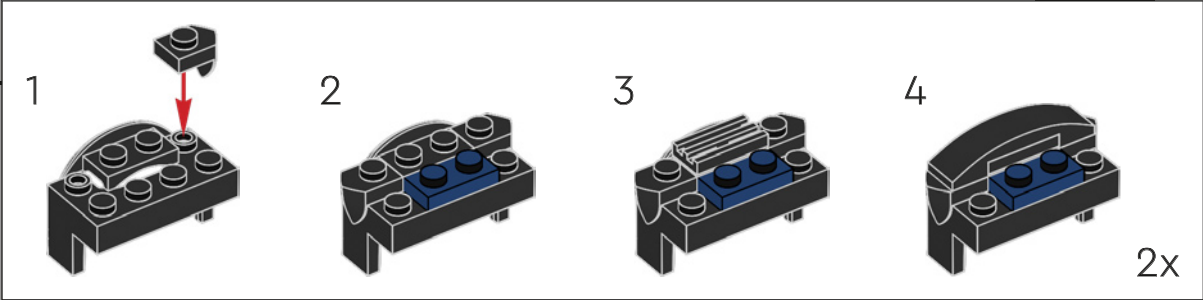
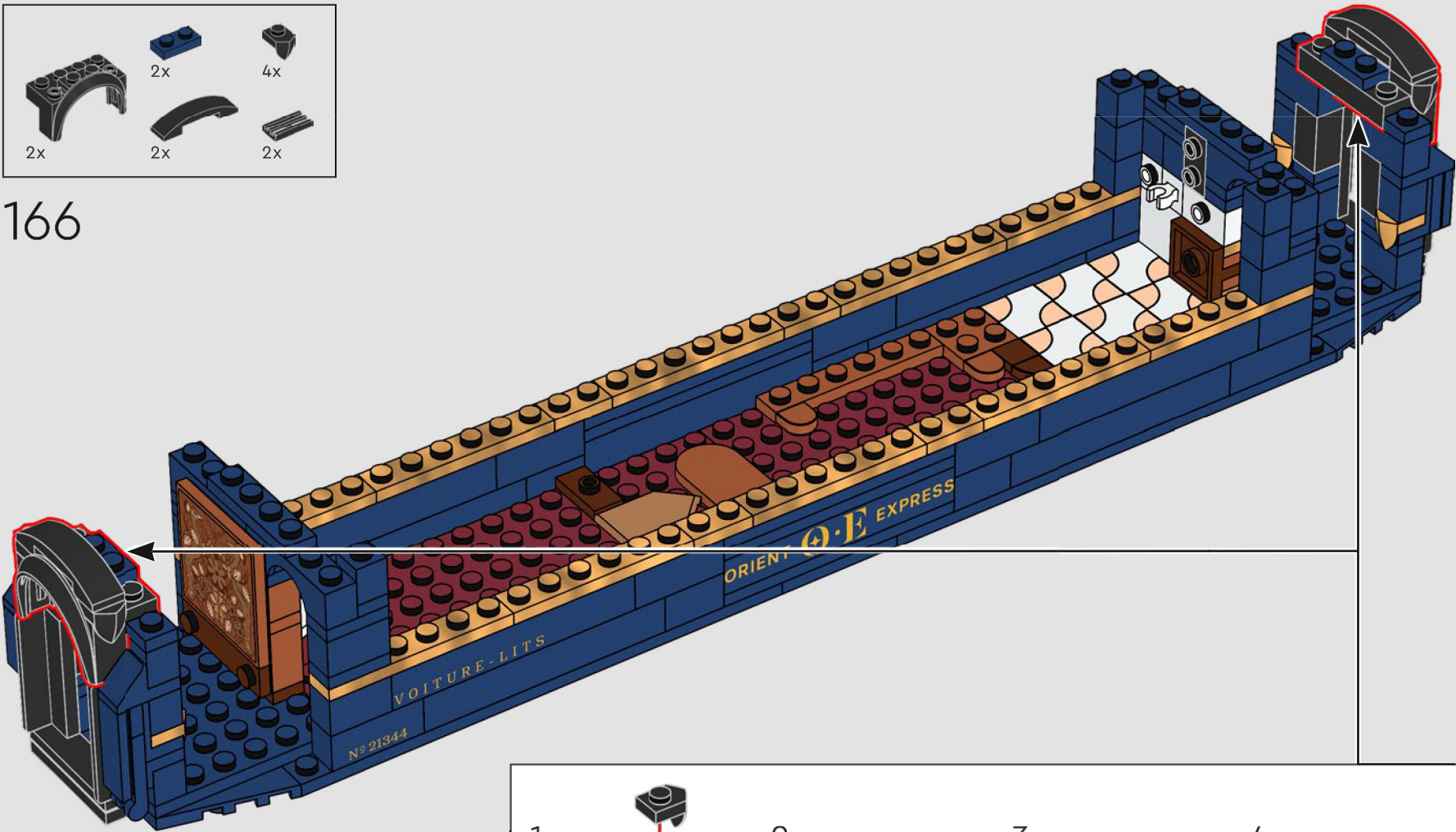

..... ●  
"Ogni carrozza letto ha un proprio maggiordomo pronto a soddisfare ogni nostra esigenza".

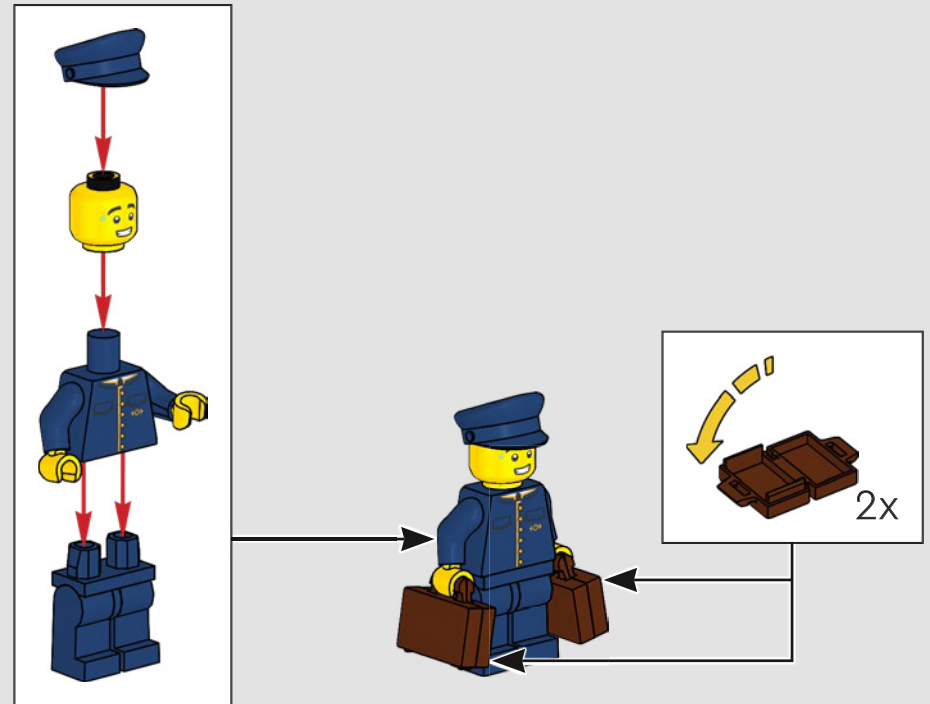



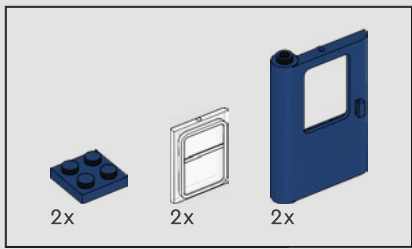

167

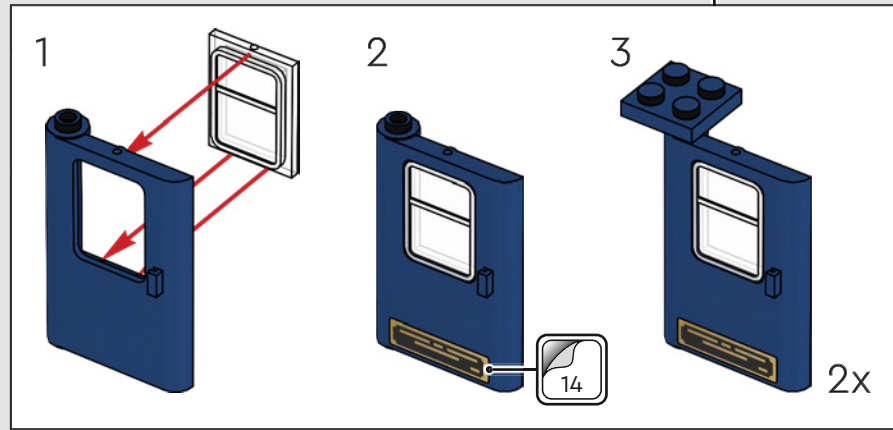
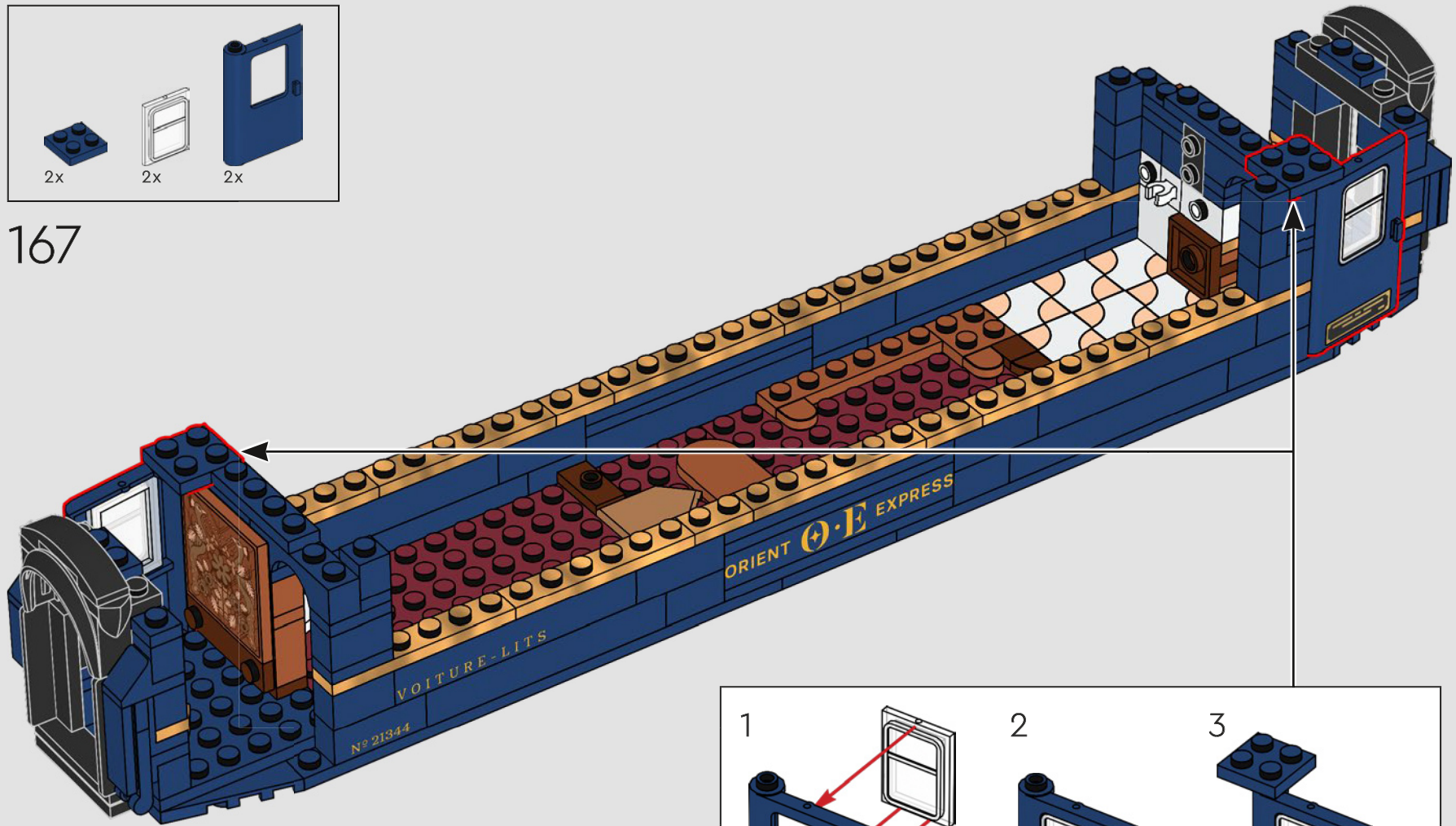

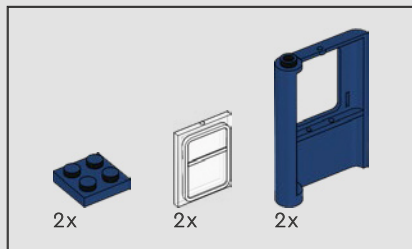

168

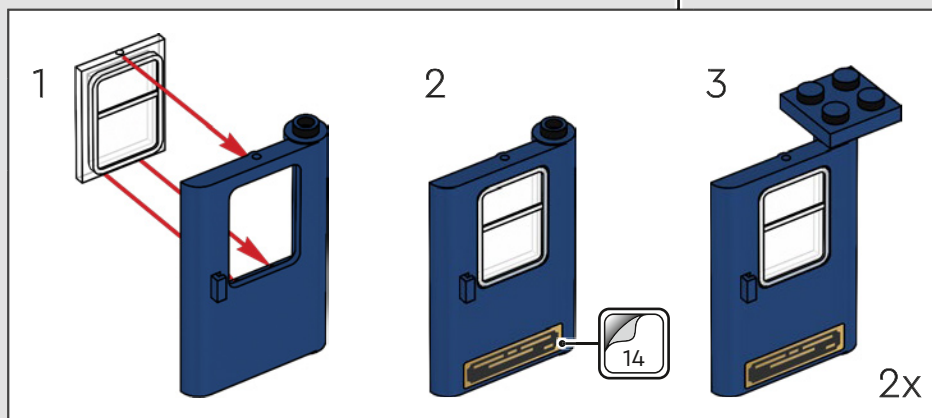
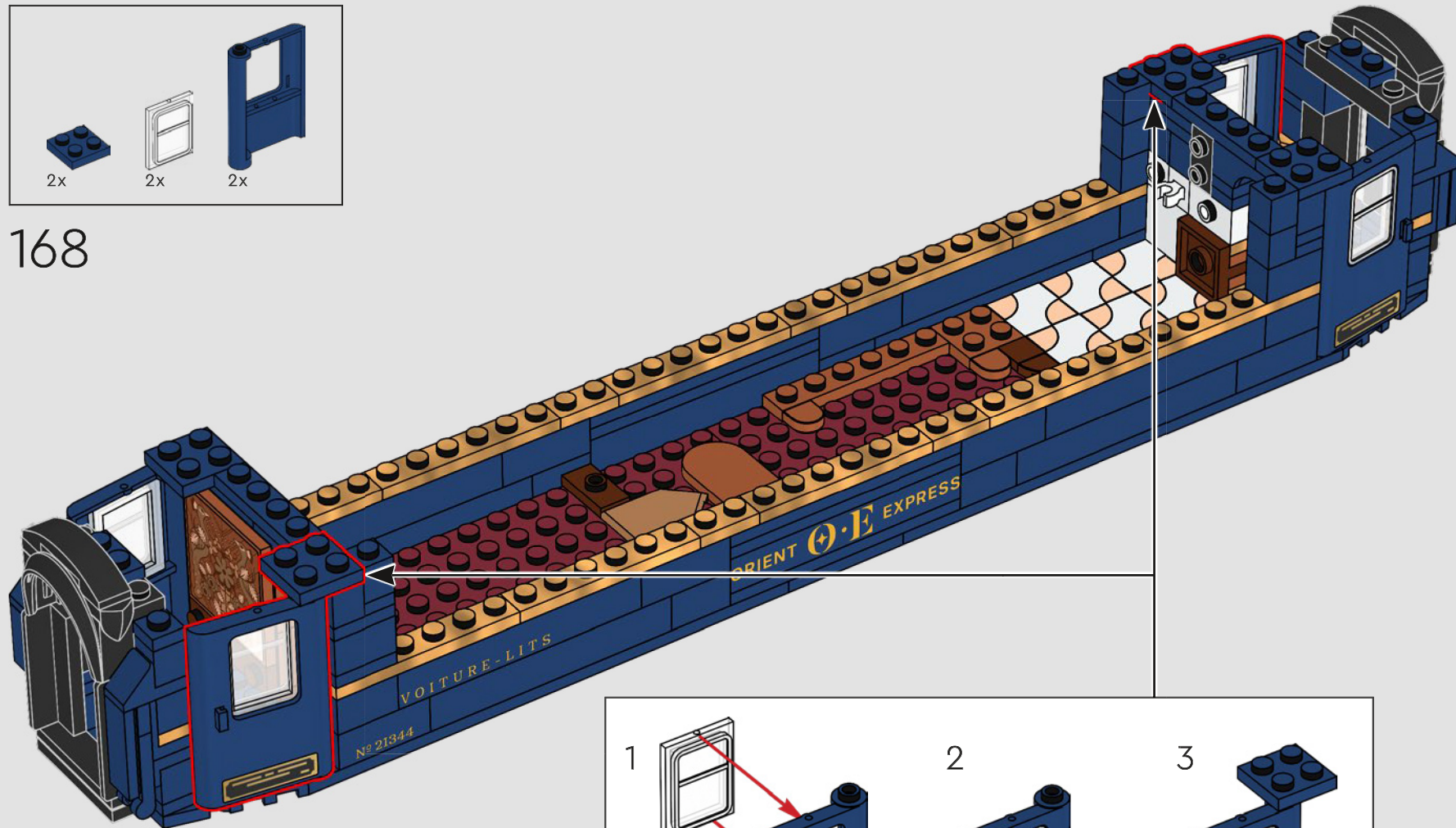



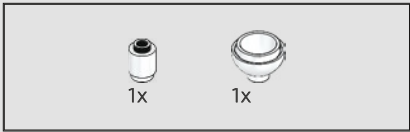

169

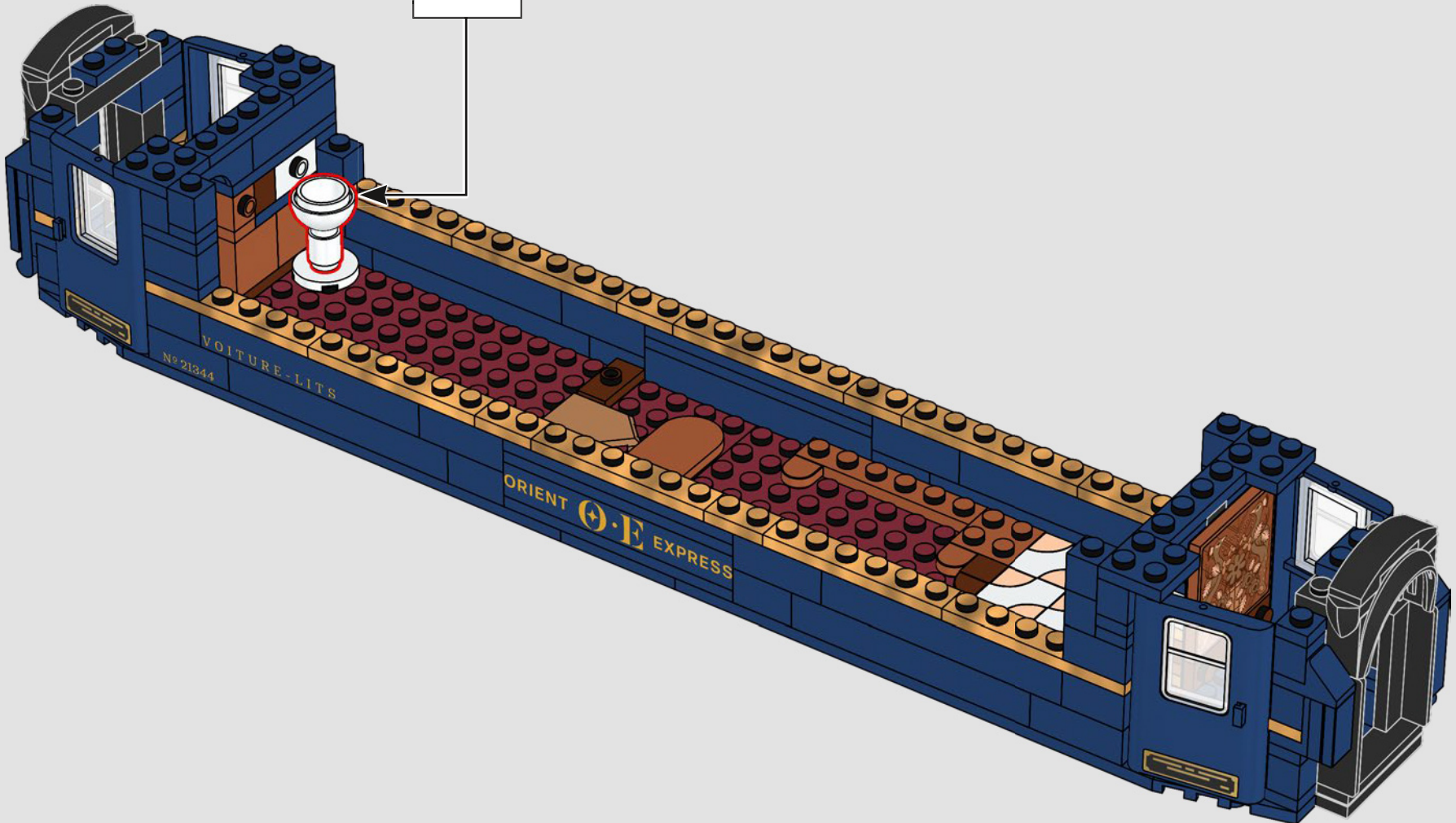





170

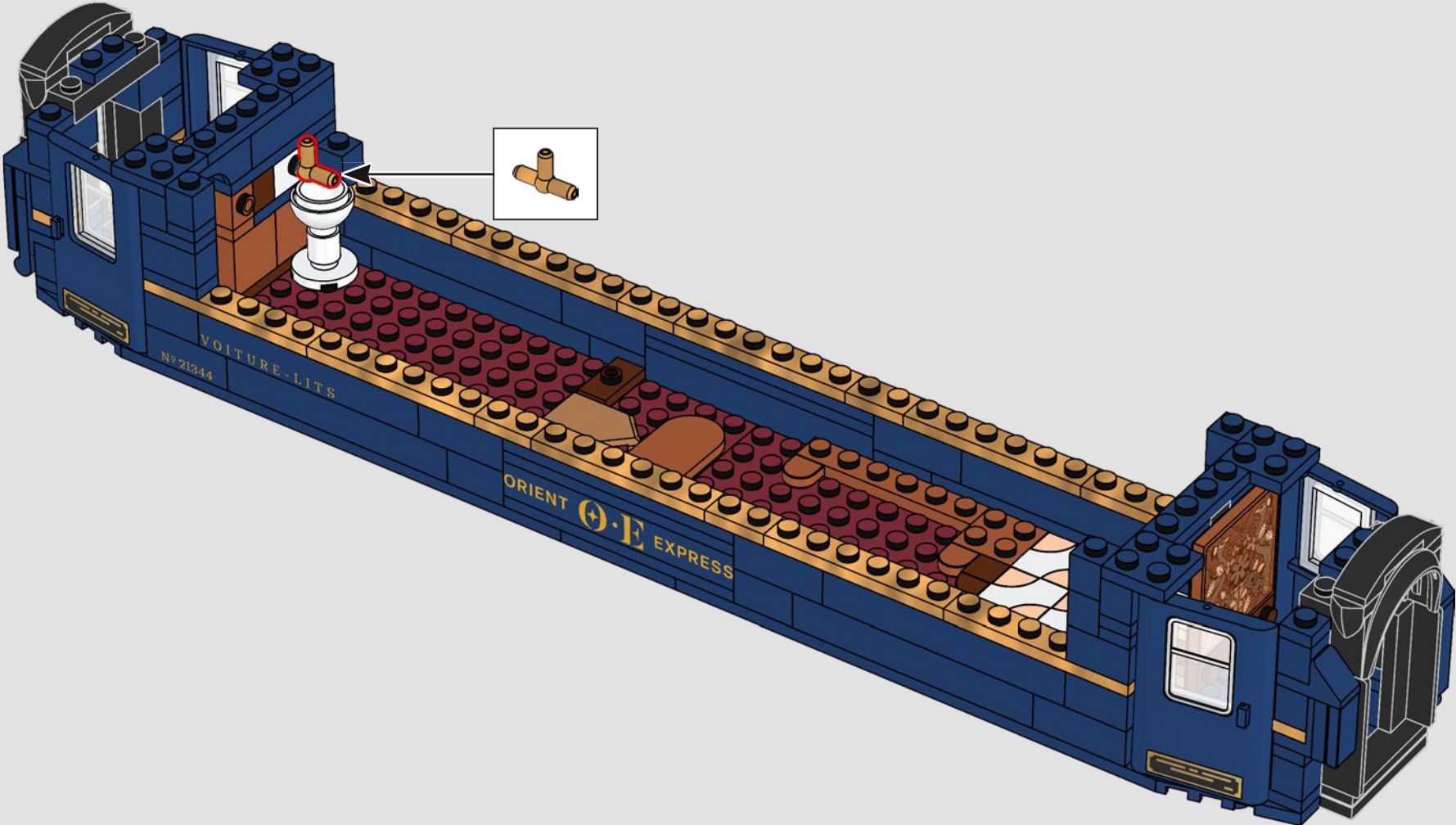



171

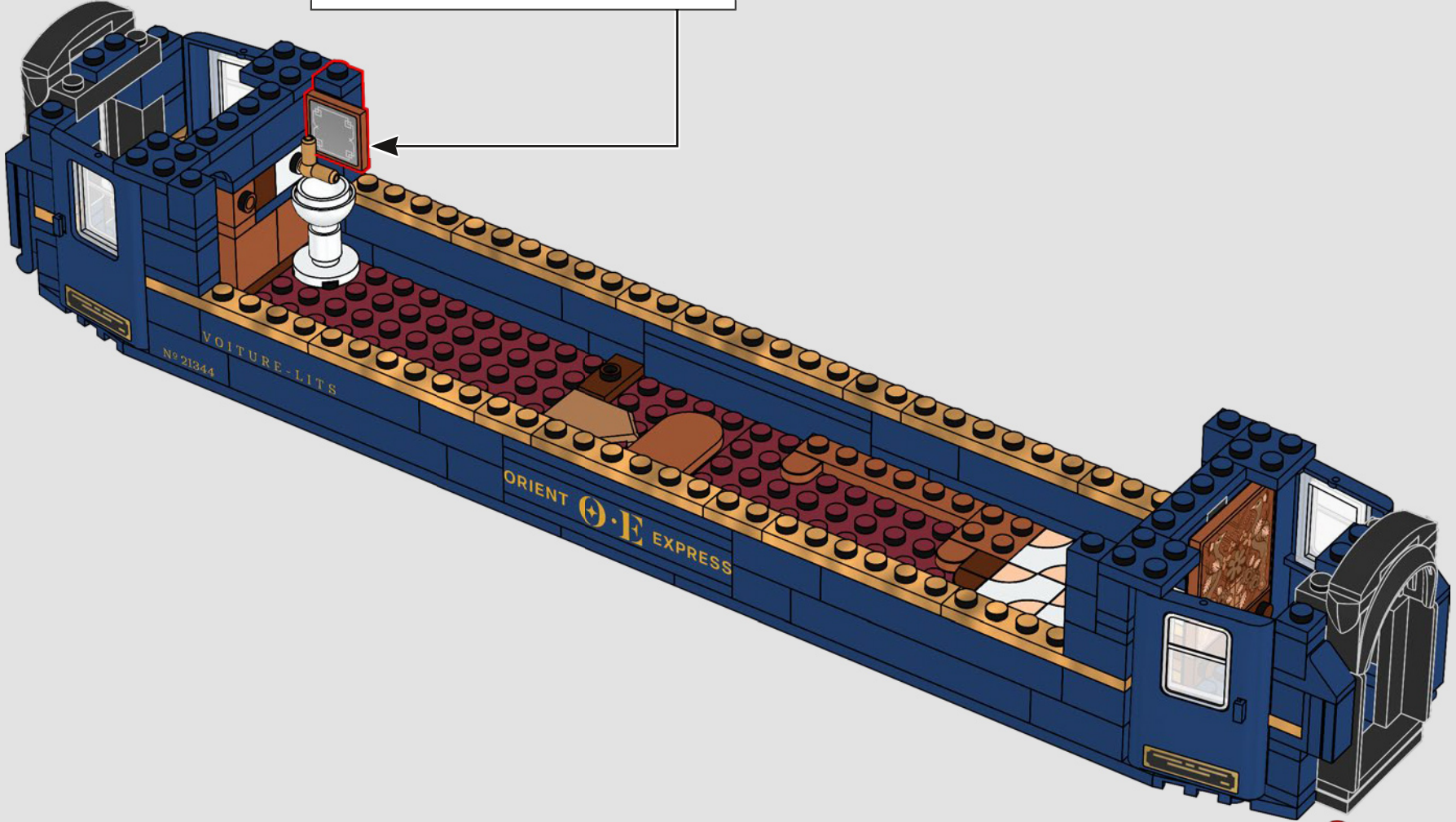
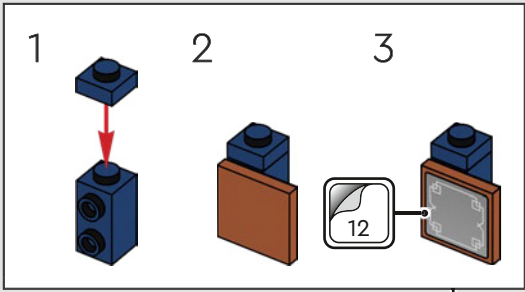

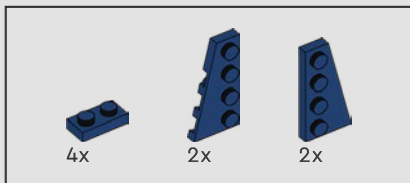

172

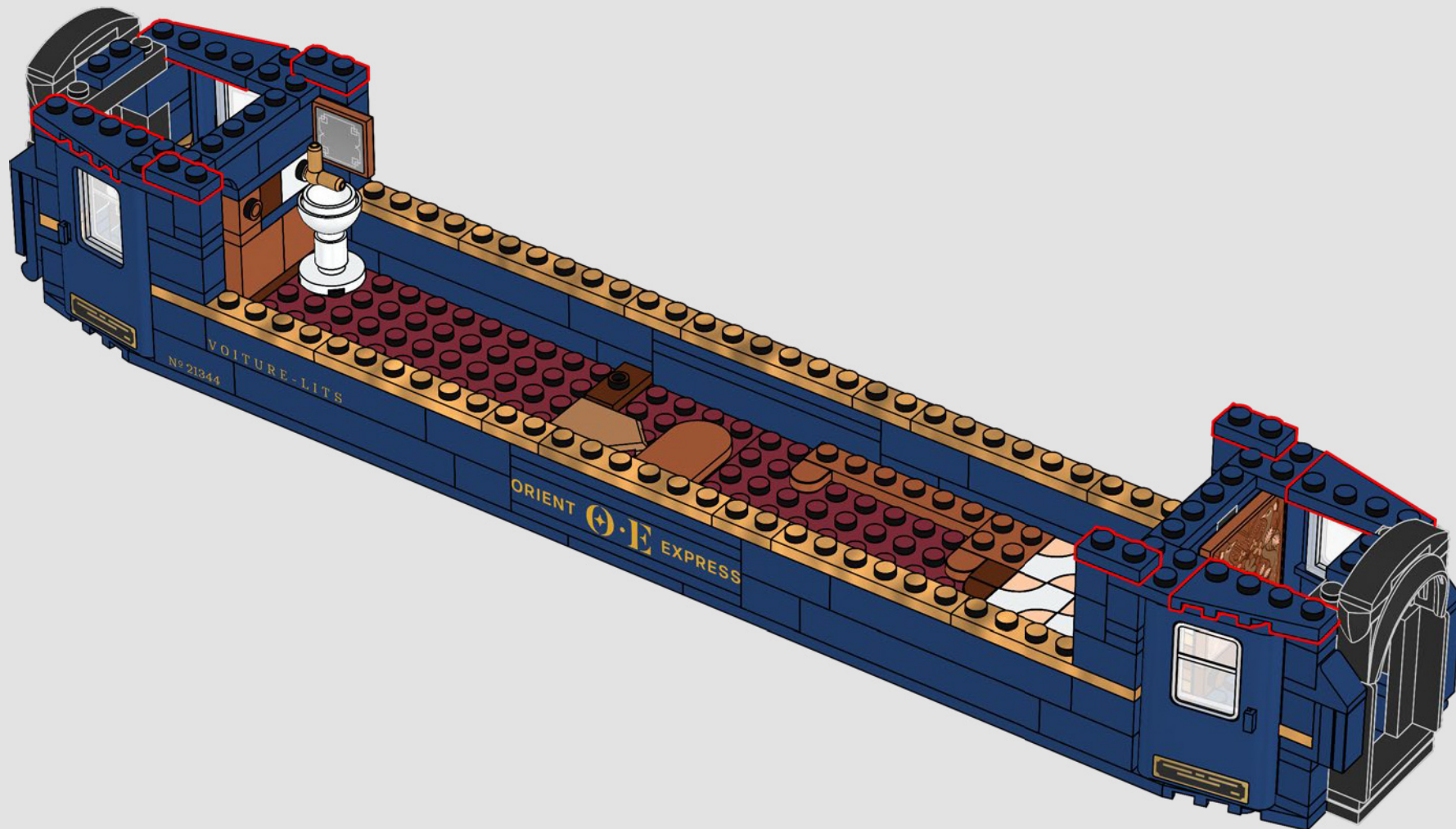



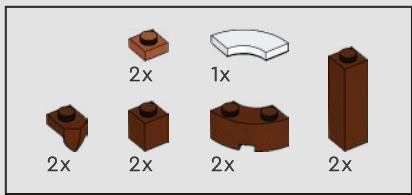

173

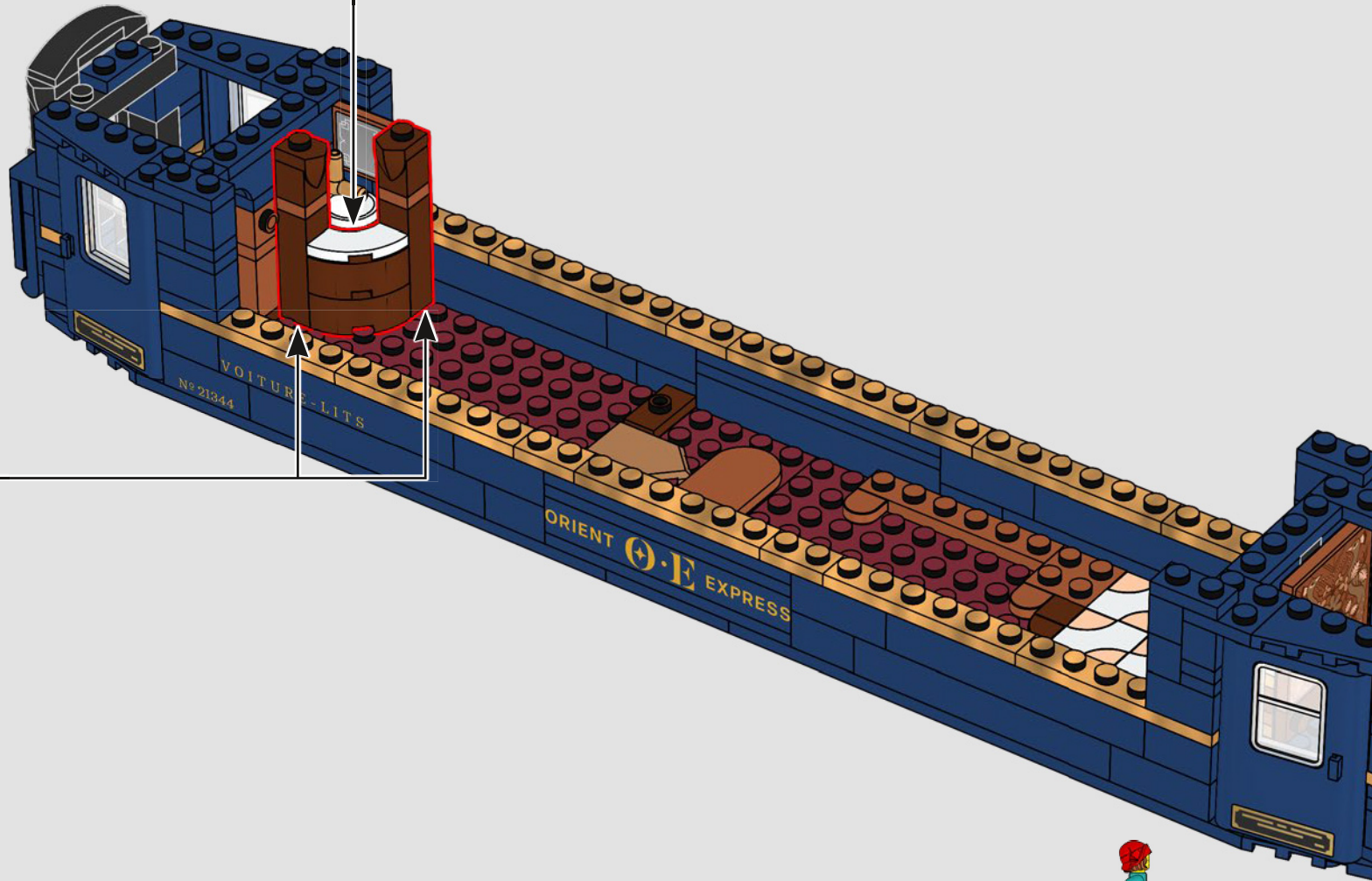
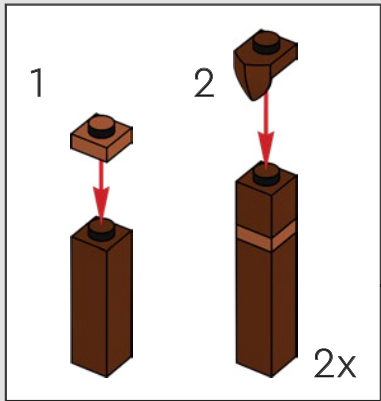
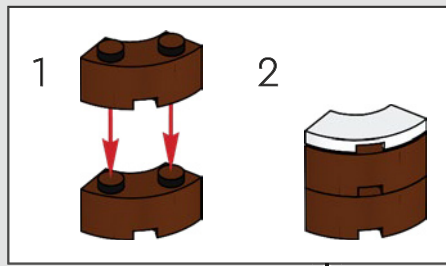

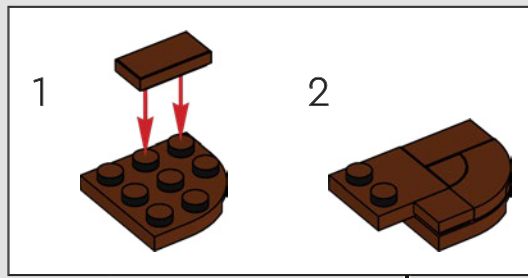
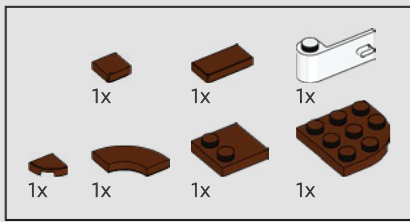

174

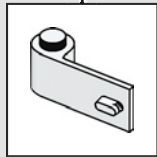
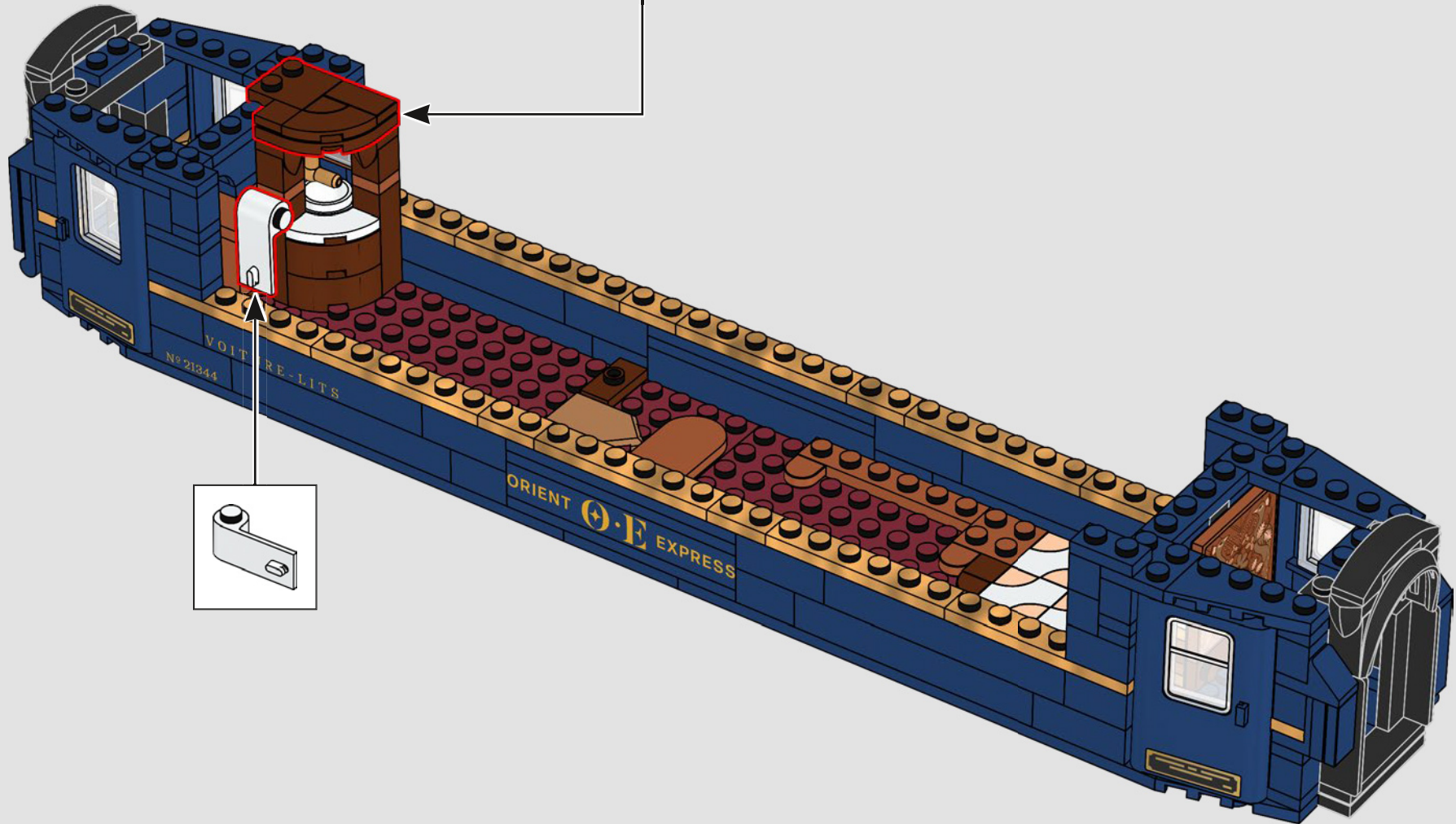



175

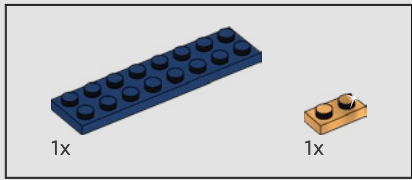
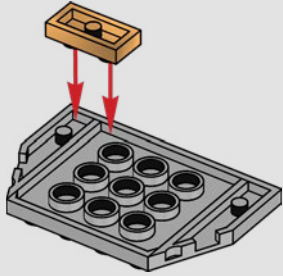

176

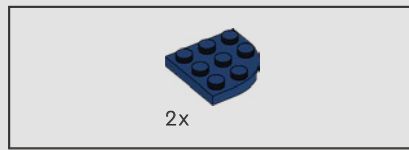
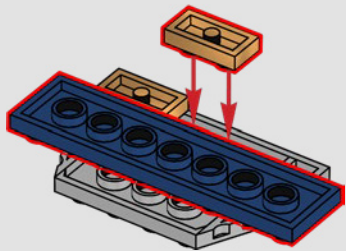

177

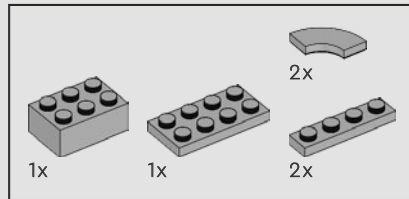
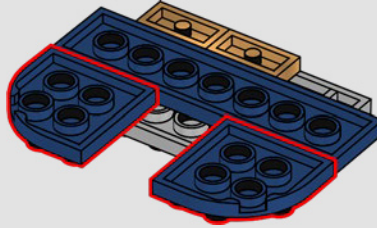

178

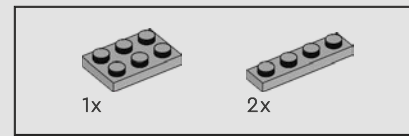
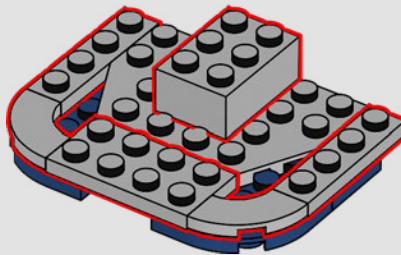

179

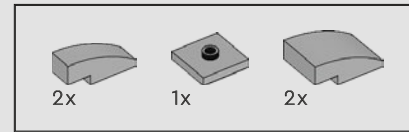
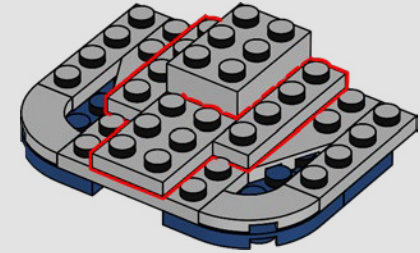

180

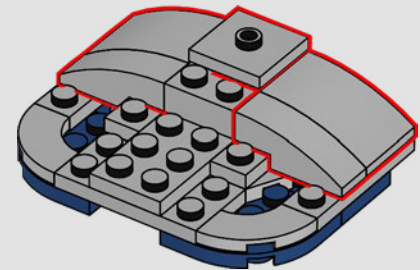



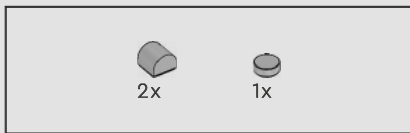

181

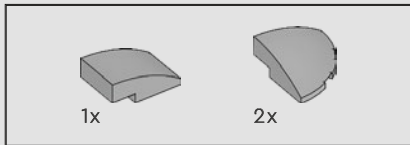
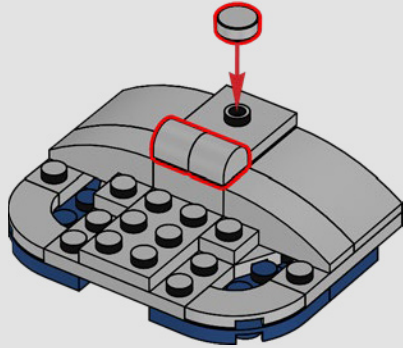

182

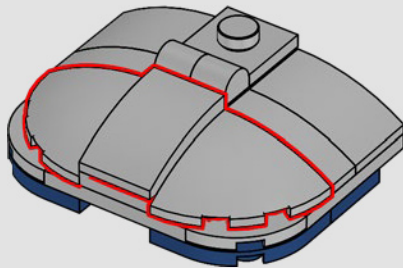

183

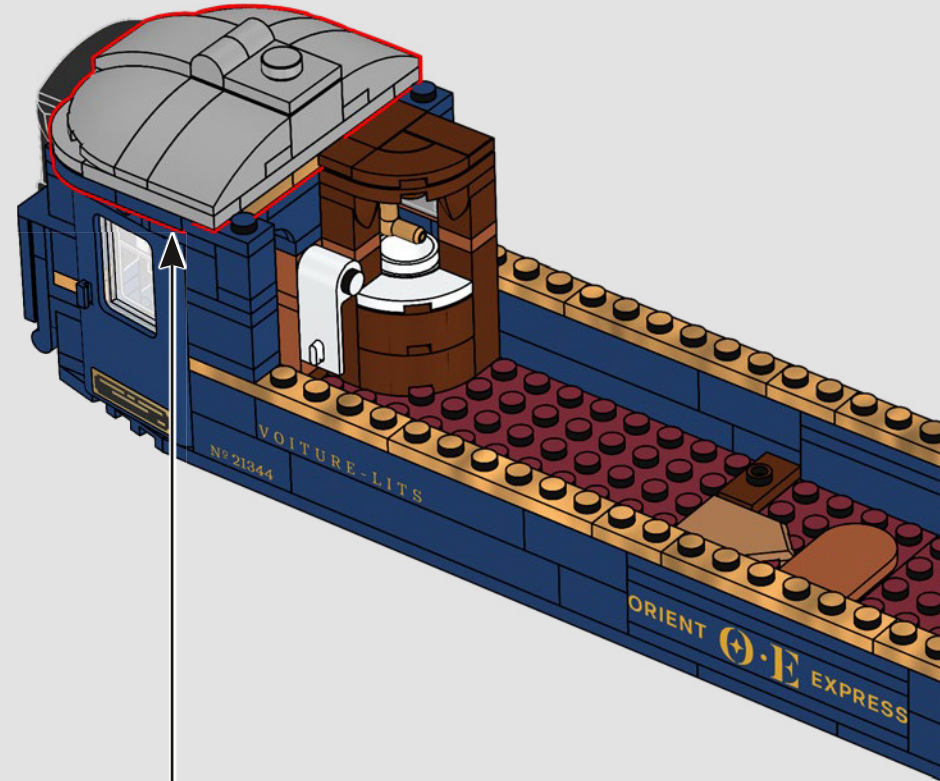

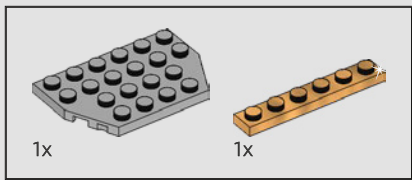

184

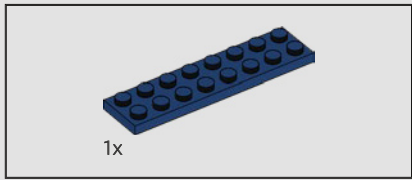
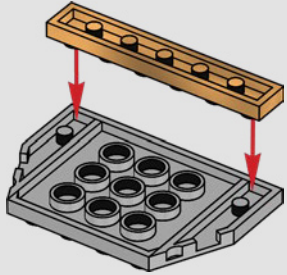

185

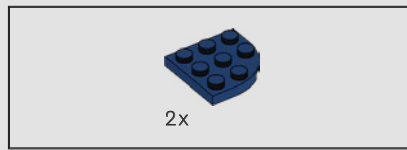
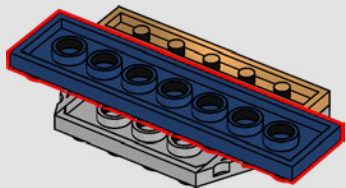

186

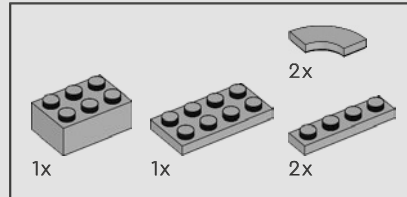
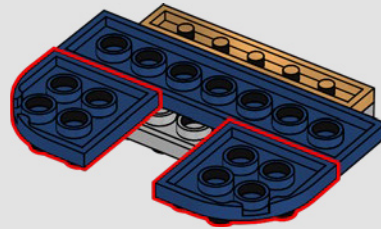

187

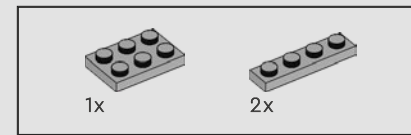
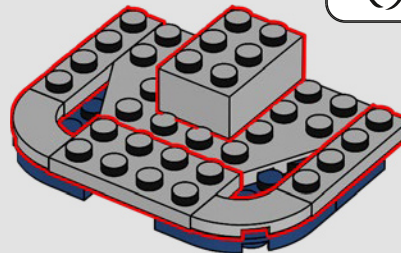

188

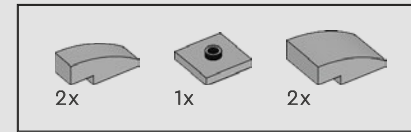
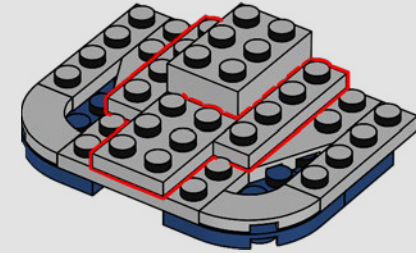

189

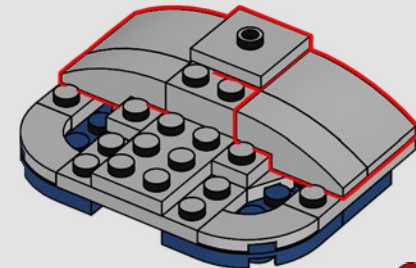

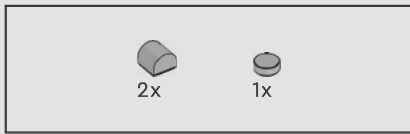

190

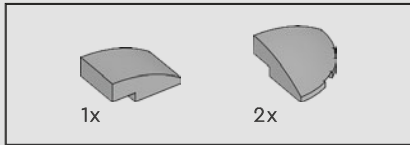
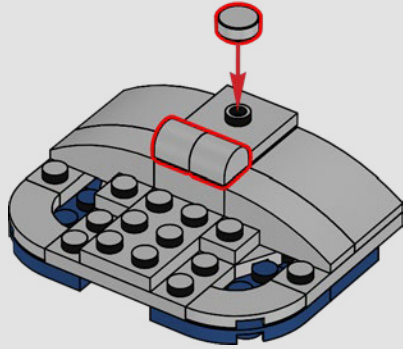

191

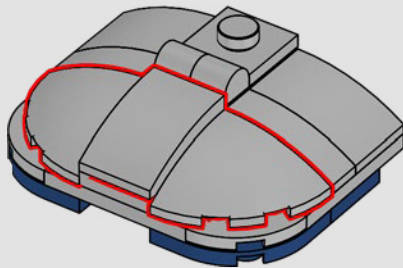

192

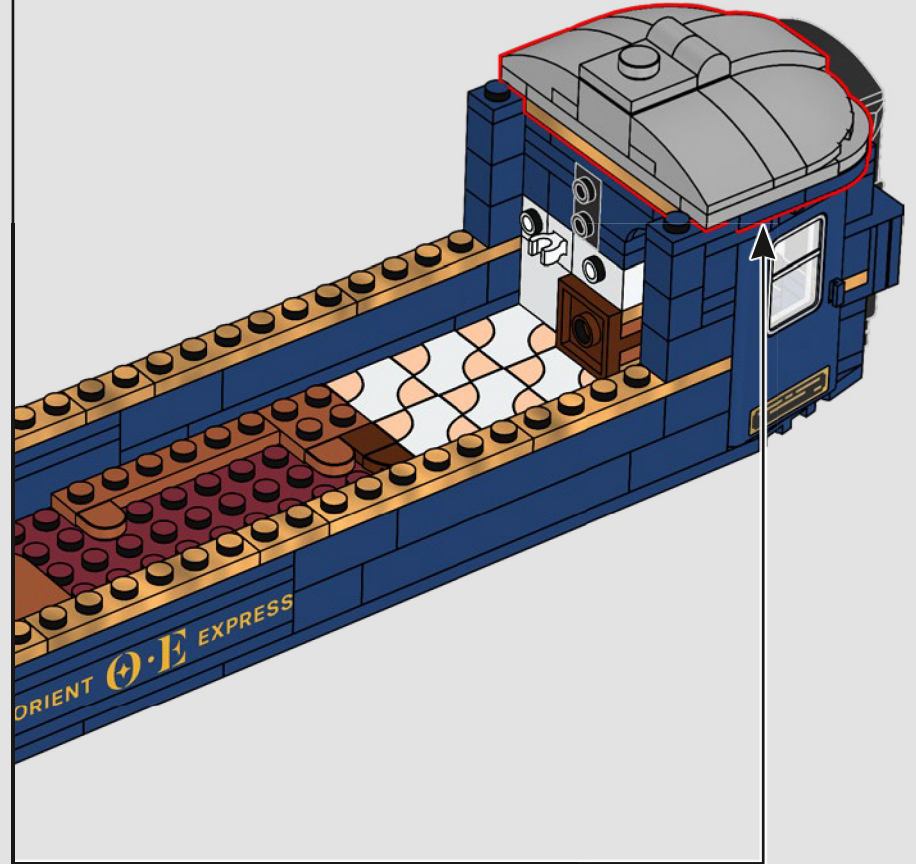



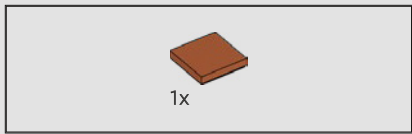

193

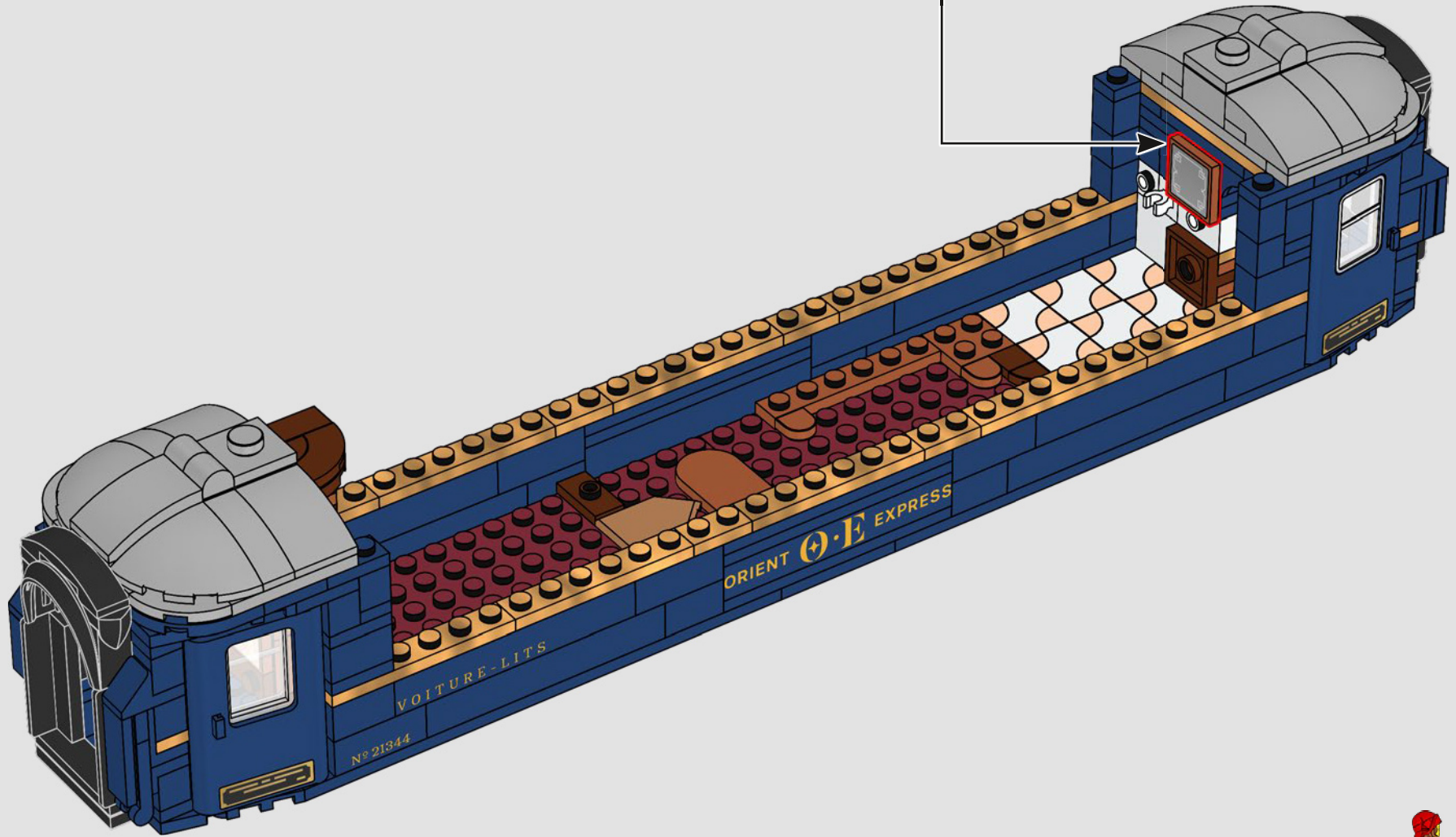
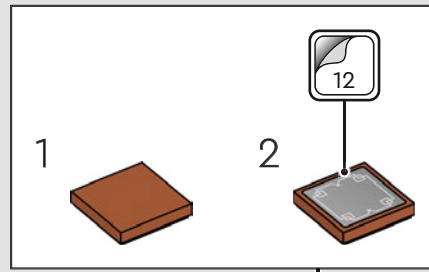

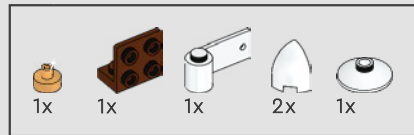

194

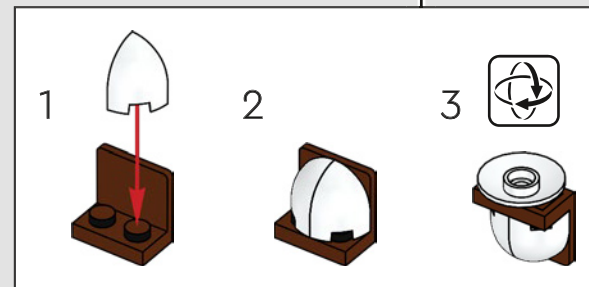
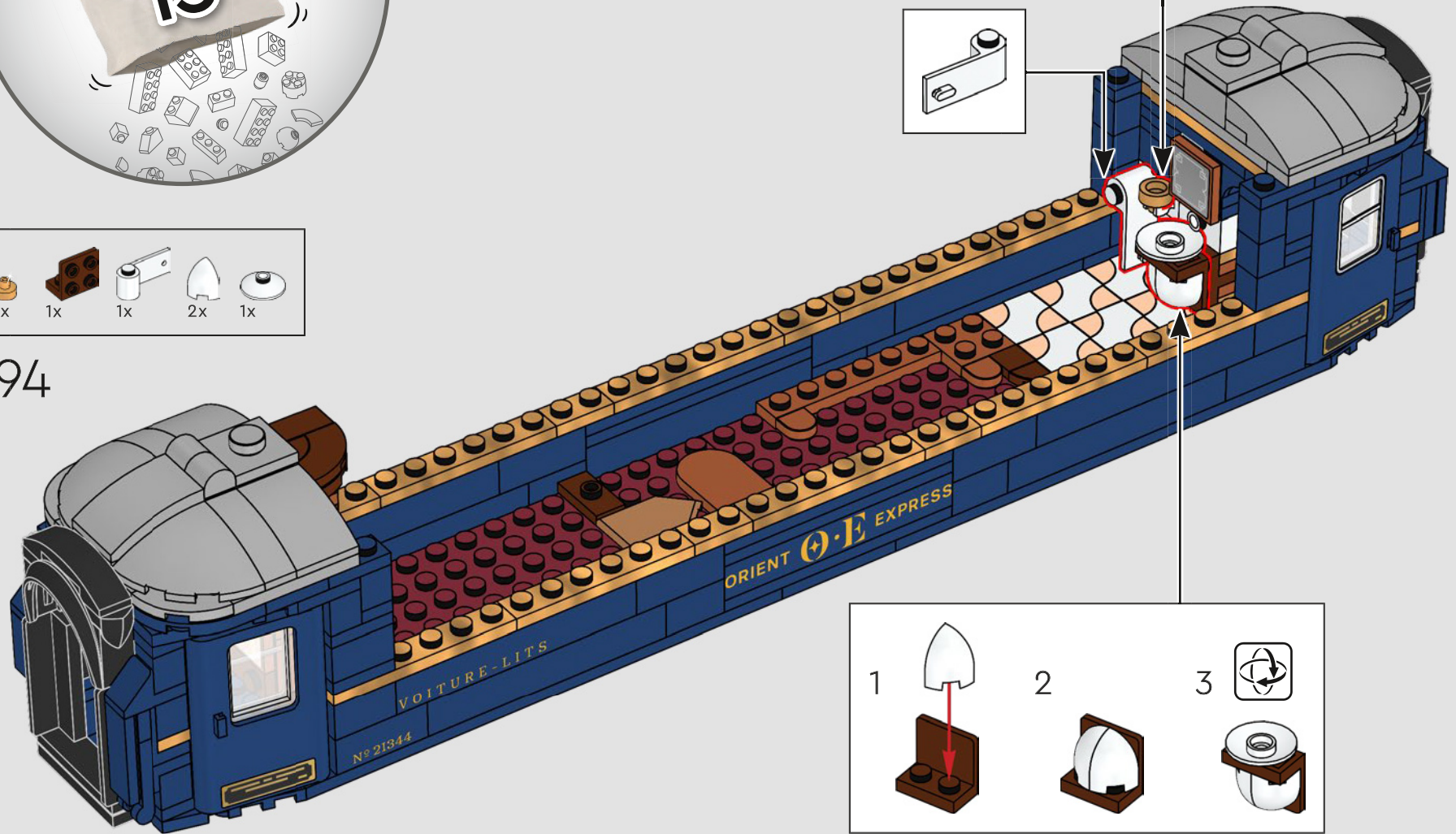



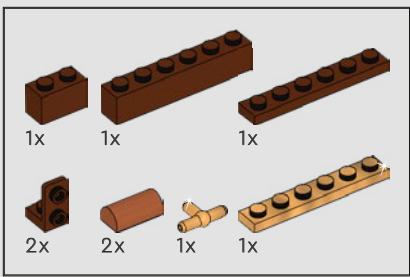

195

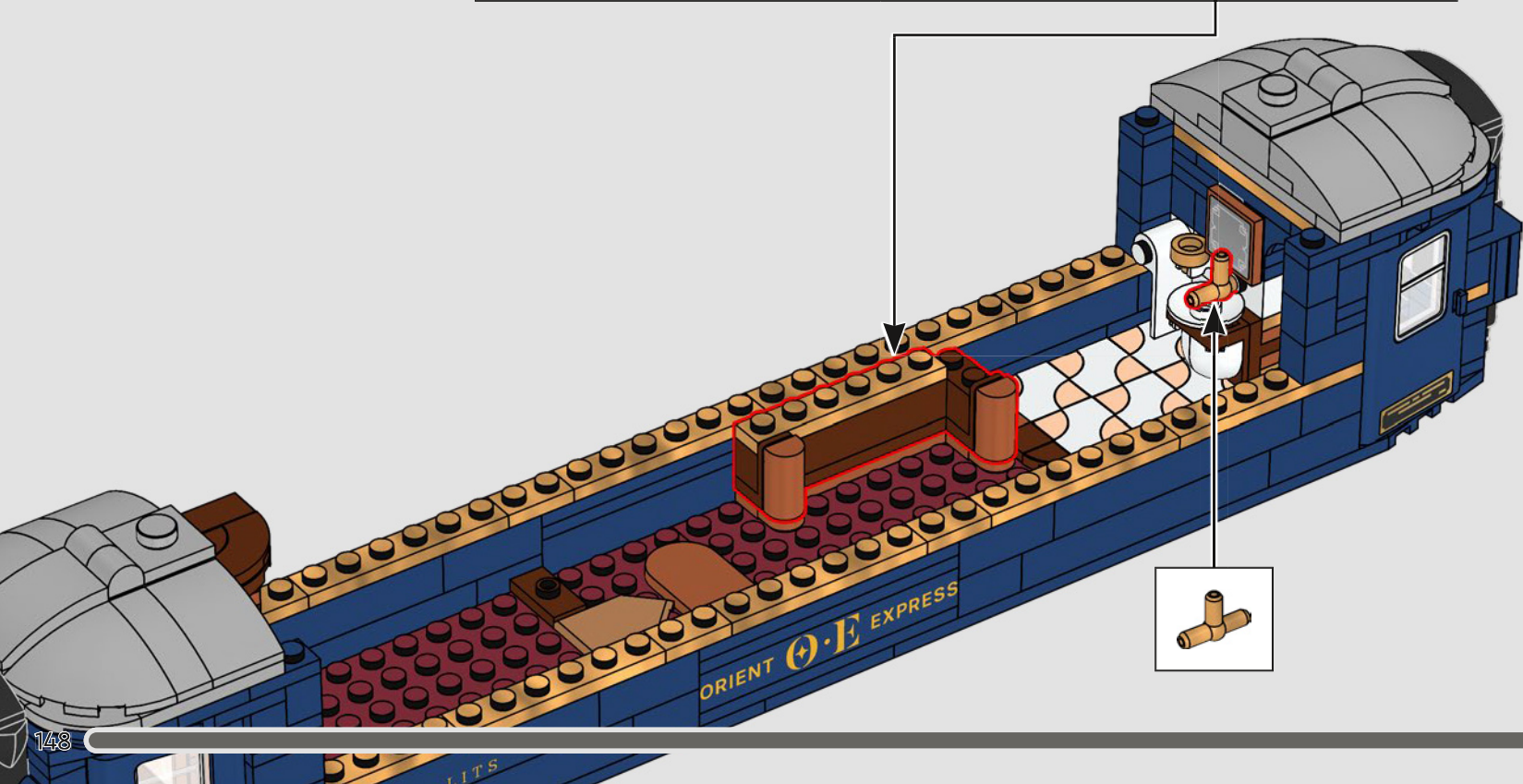
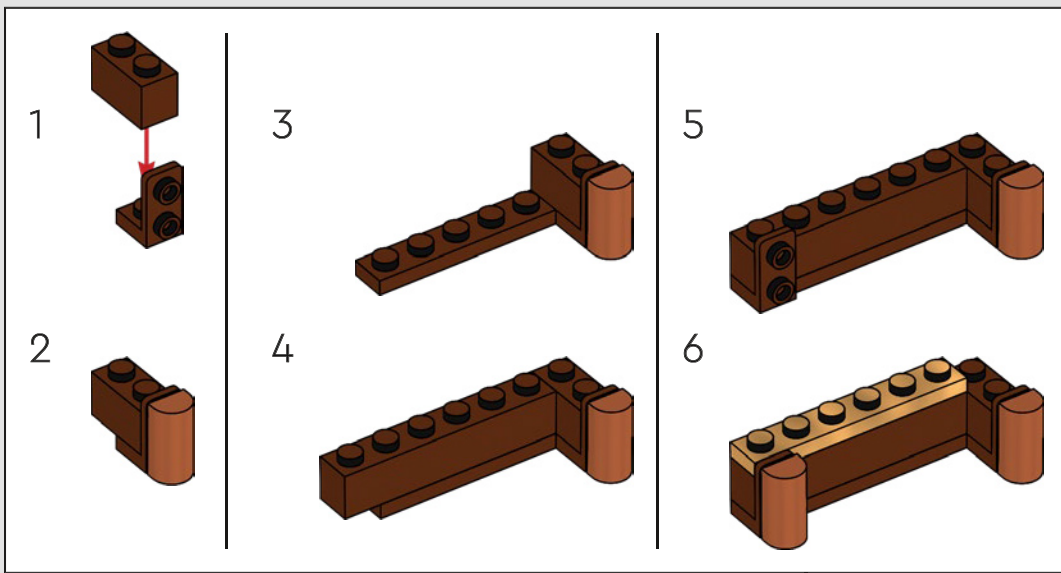



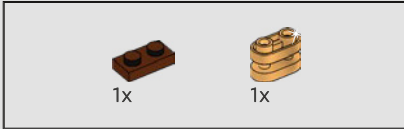
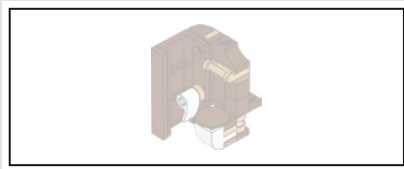

196

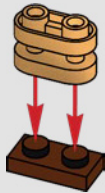

197



198

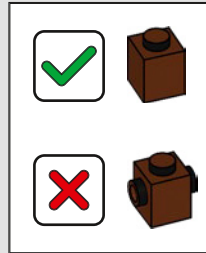

199

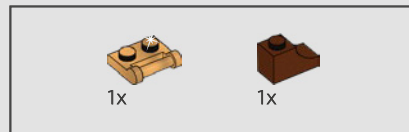

200

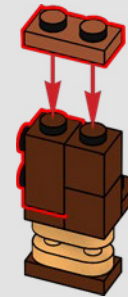
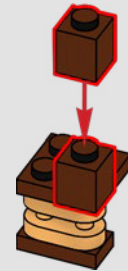

201

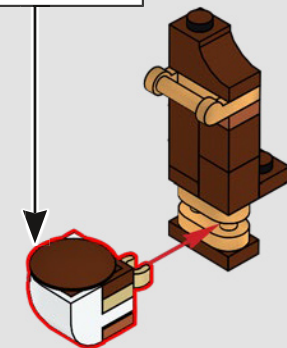
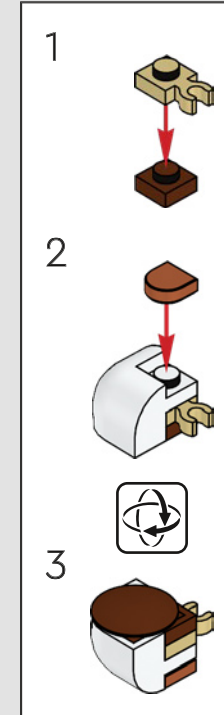

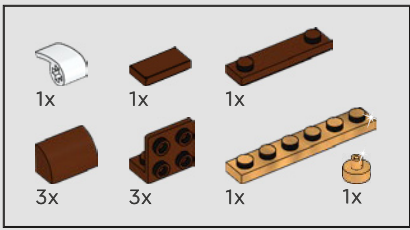

# 202

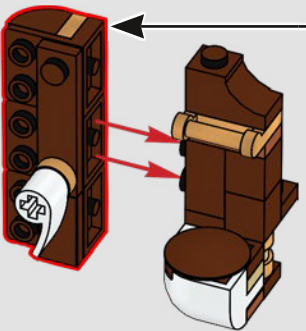
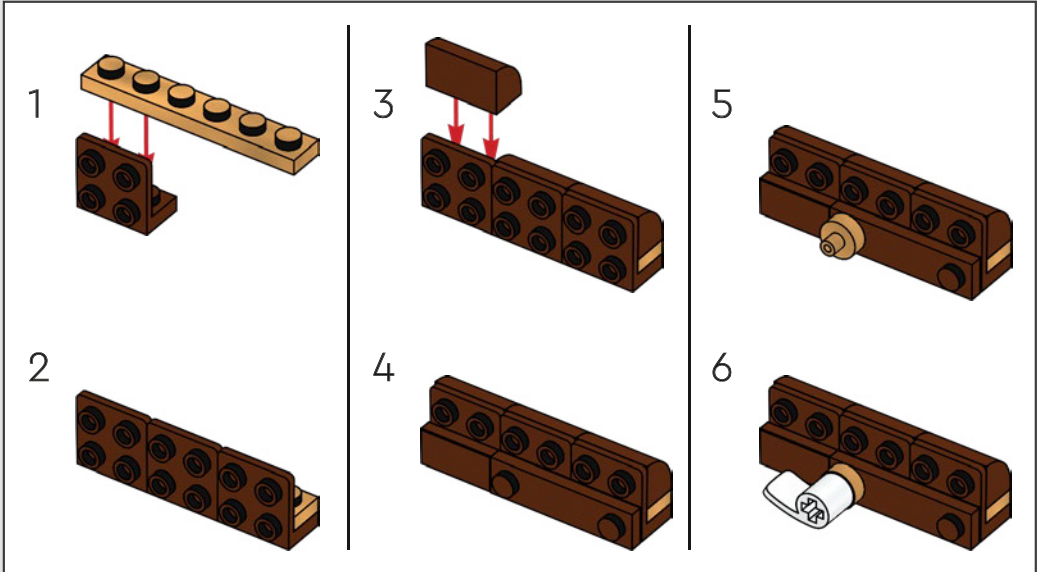

# 203

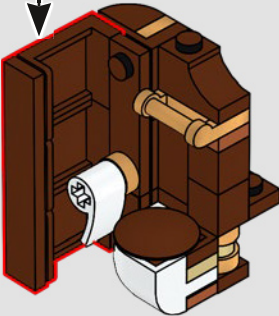
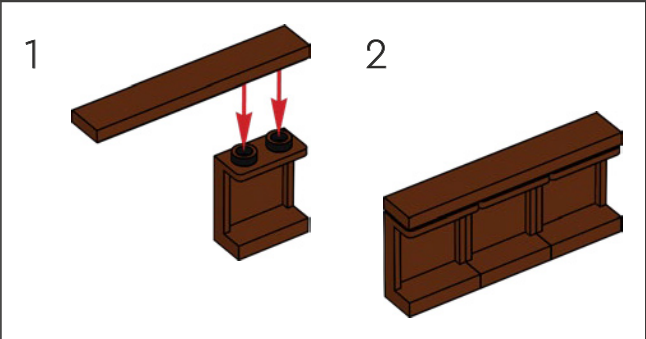

204

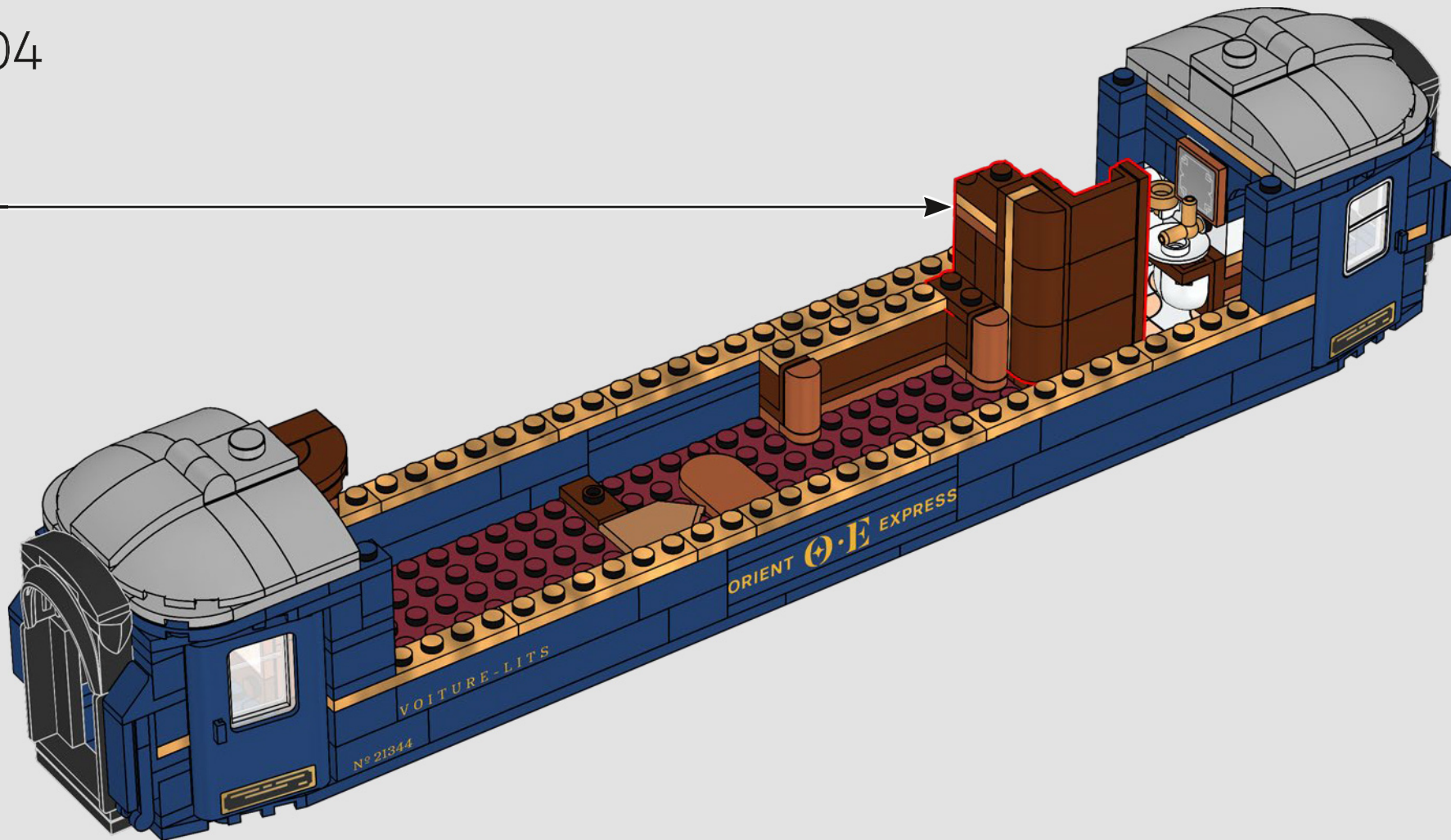

..... ●  
"Le cabine di prima classe dispongono di un bagno privato con stupende piastrelle".



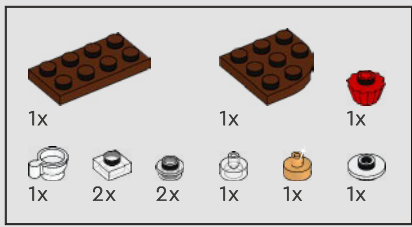

205

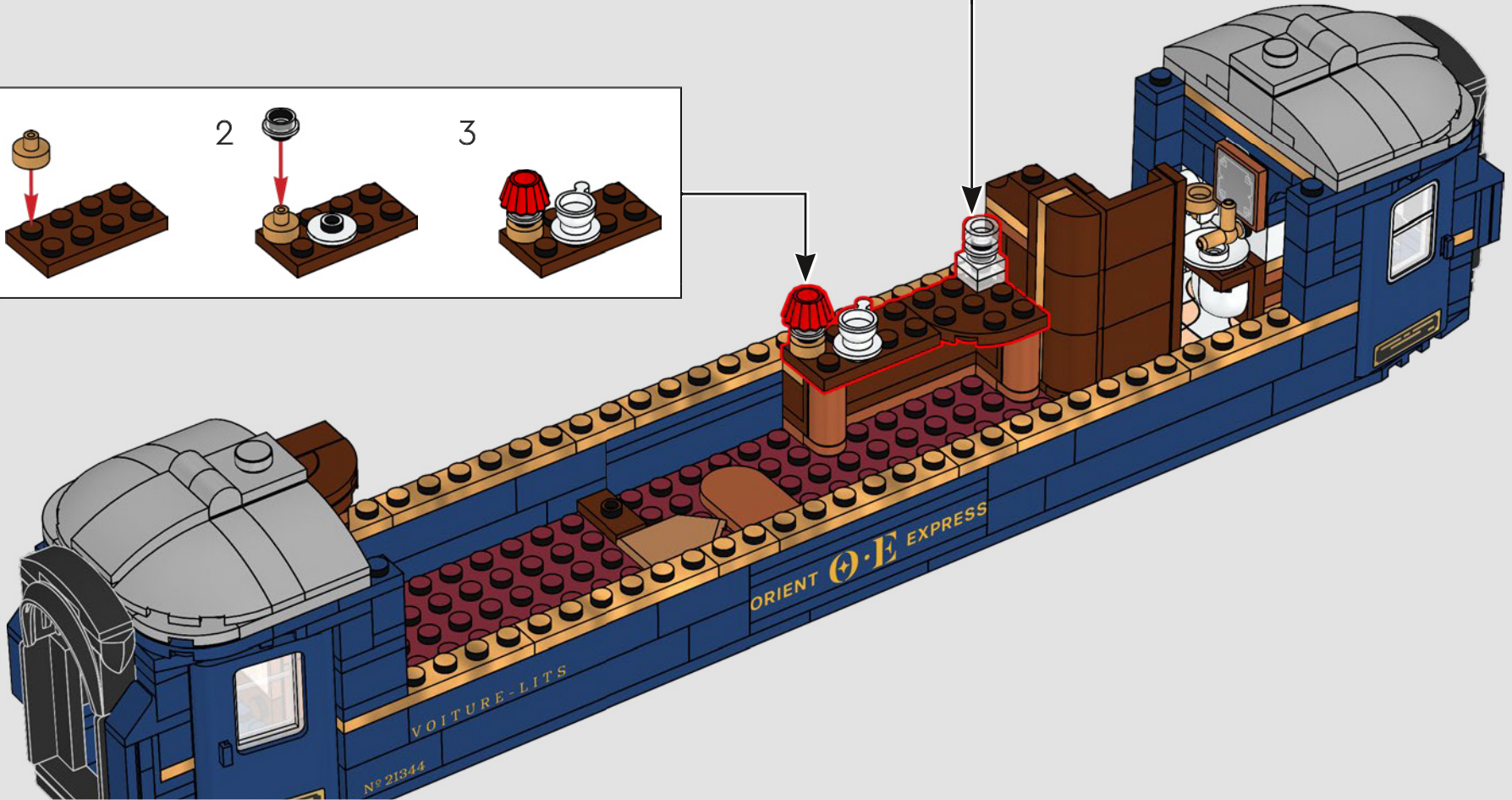
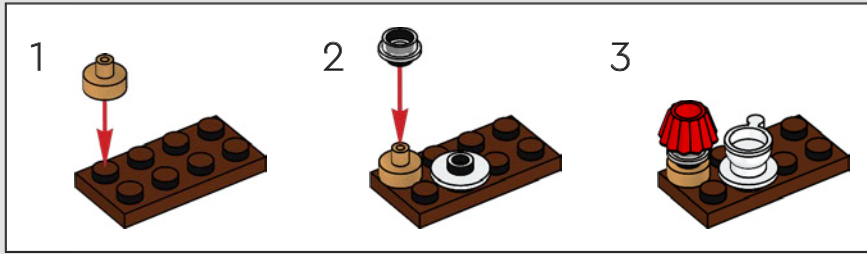
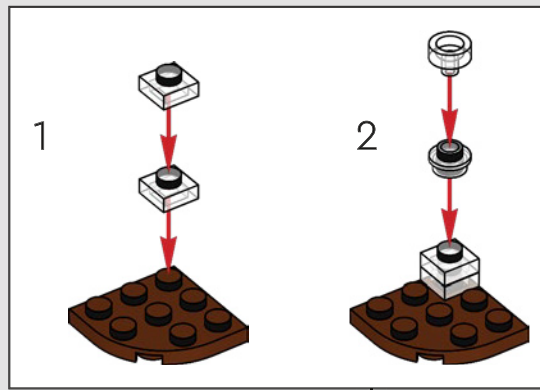

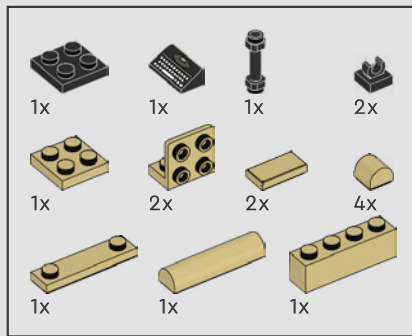

206

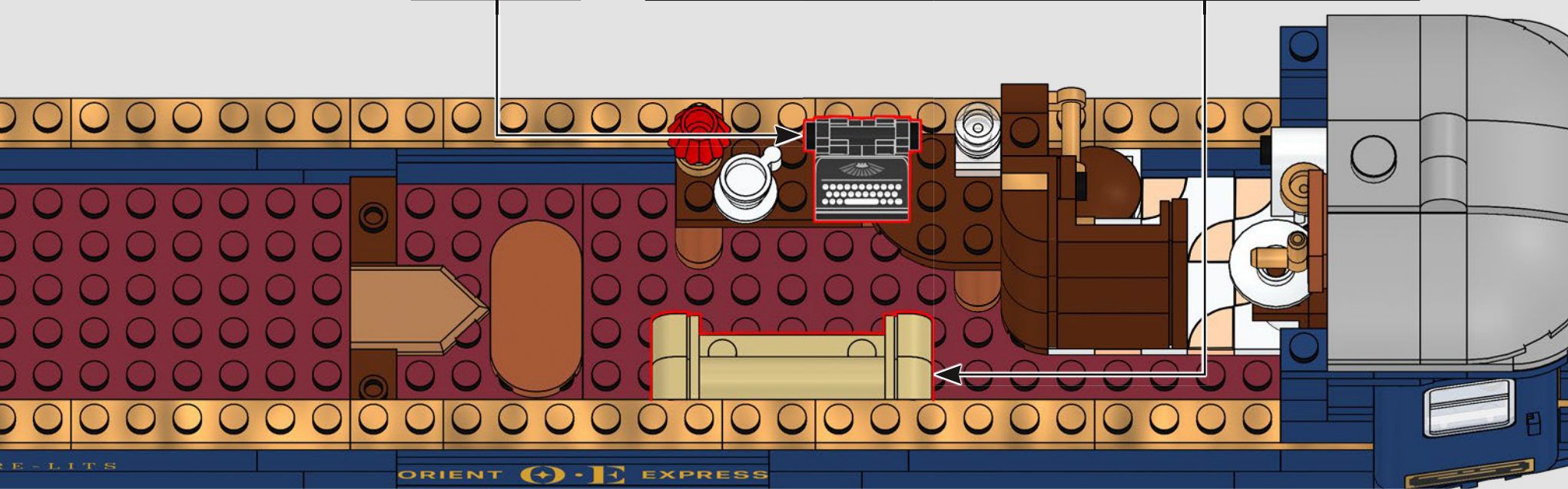
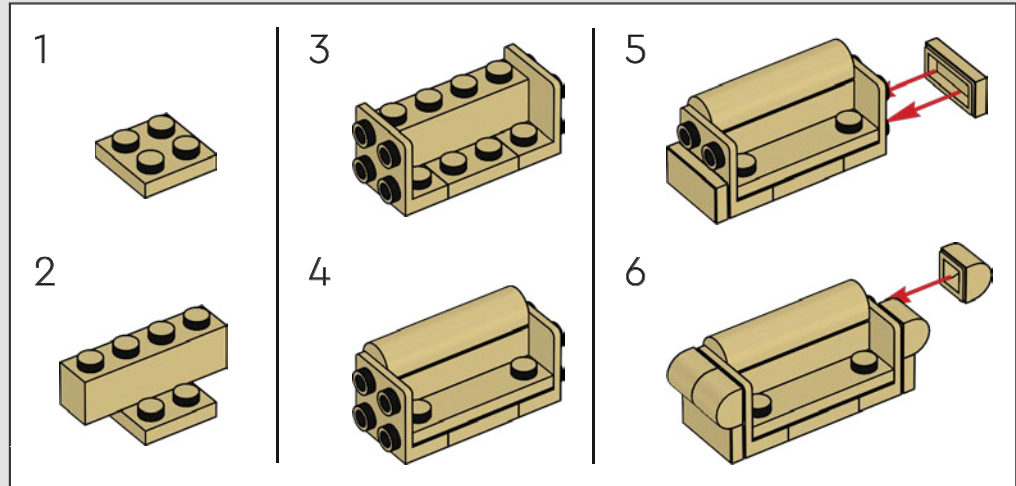
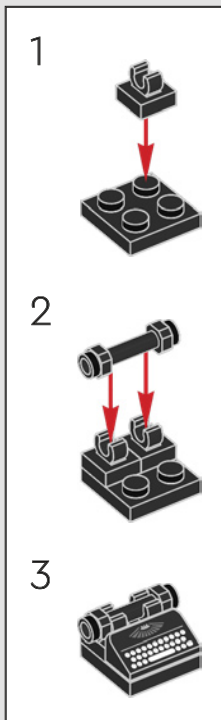

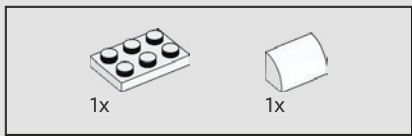

207

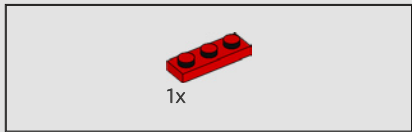
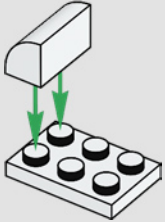

208

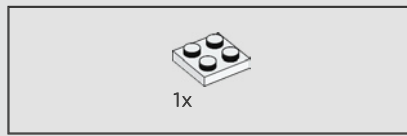
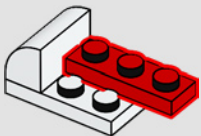

209

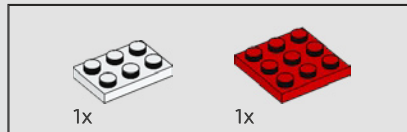
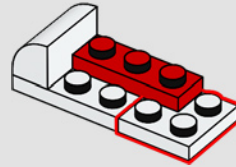

210

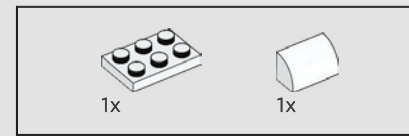
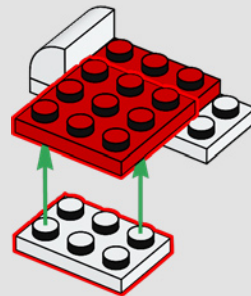

211

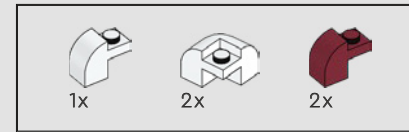
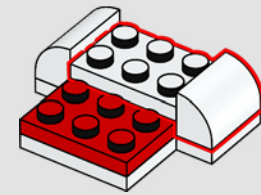

212

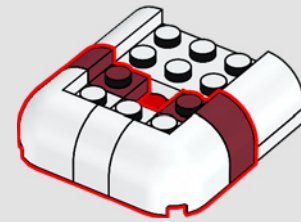



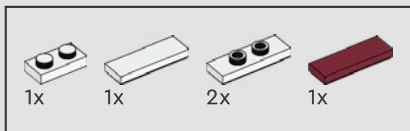

213

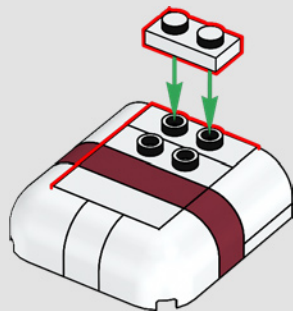

214

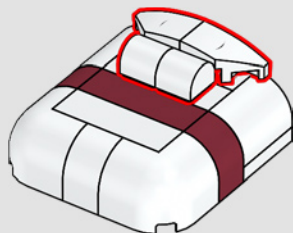

215

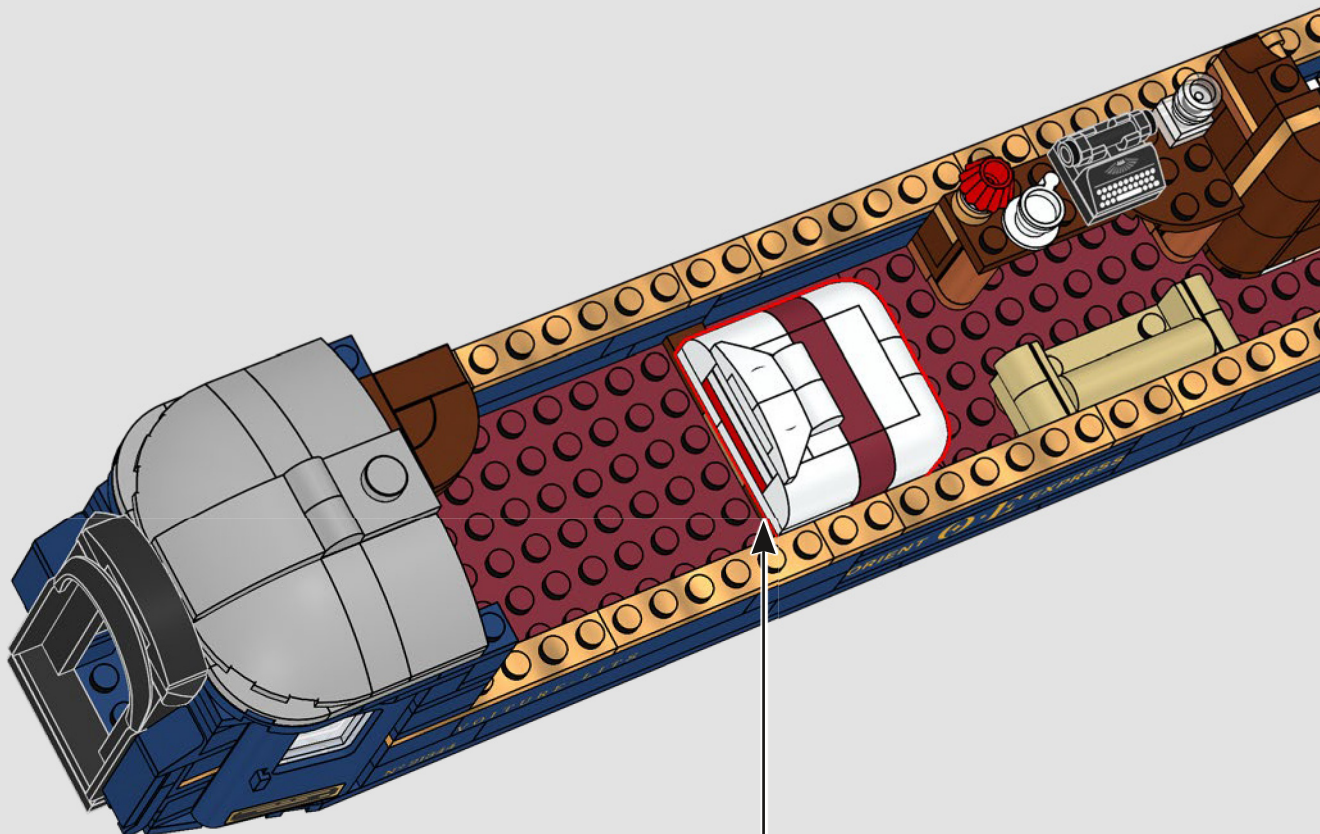

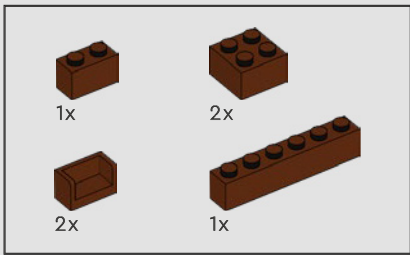

216

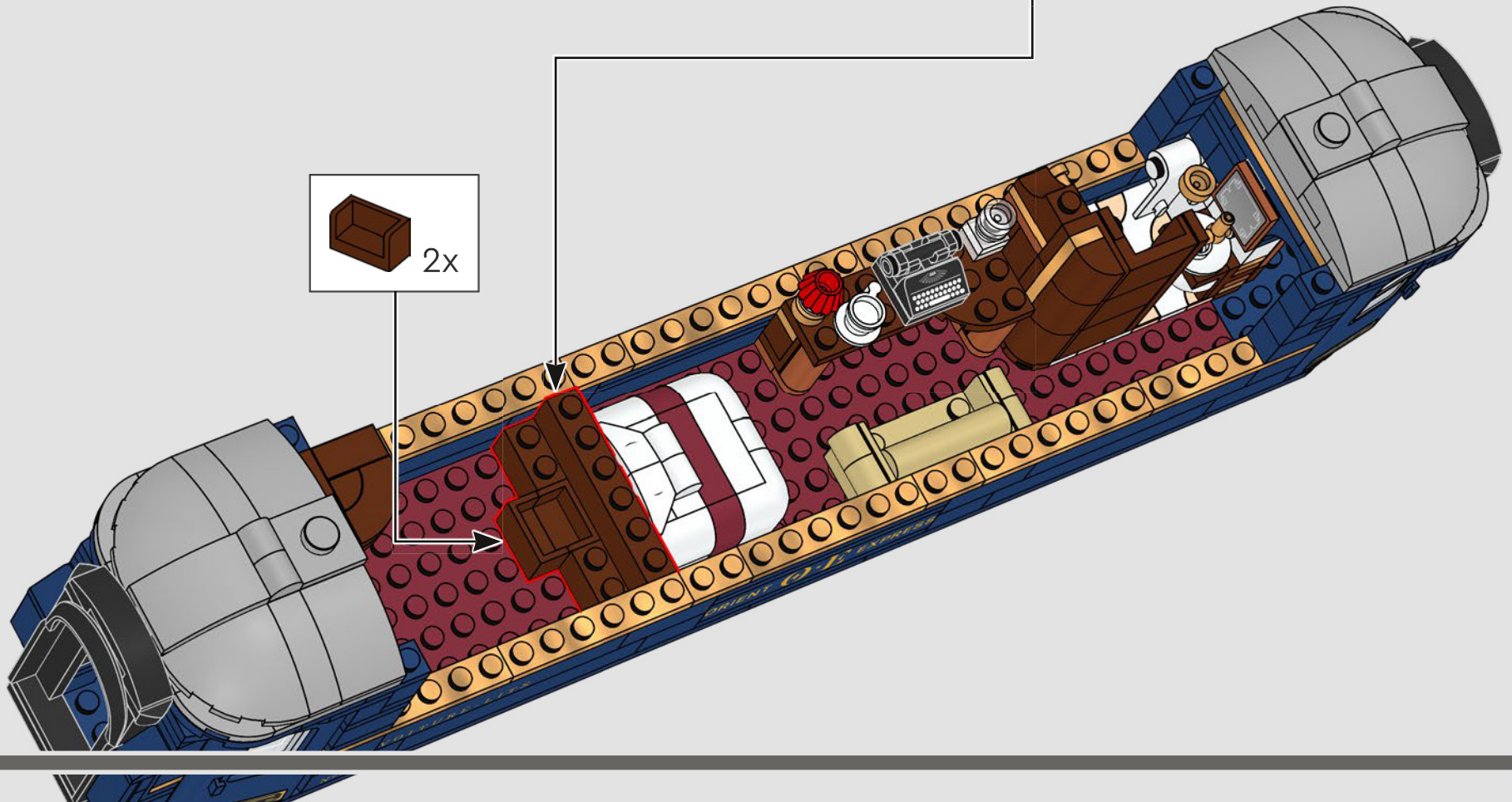
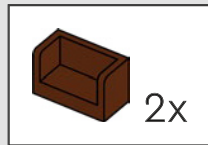
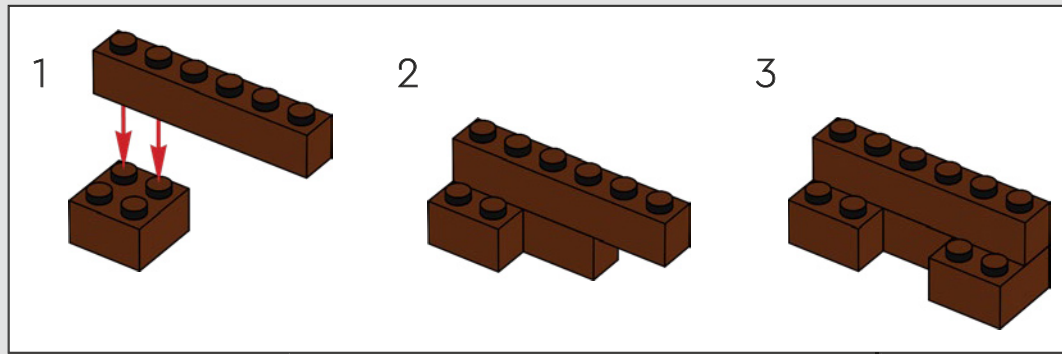



217

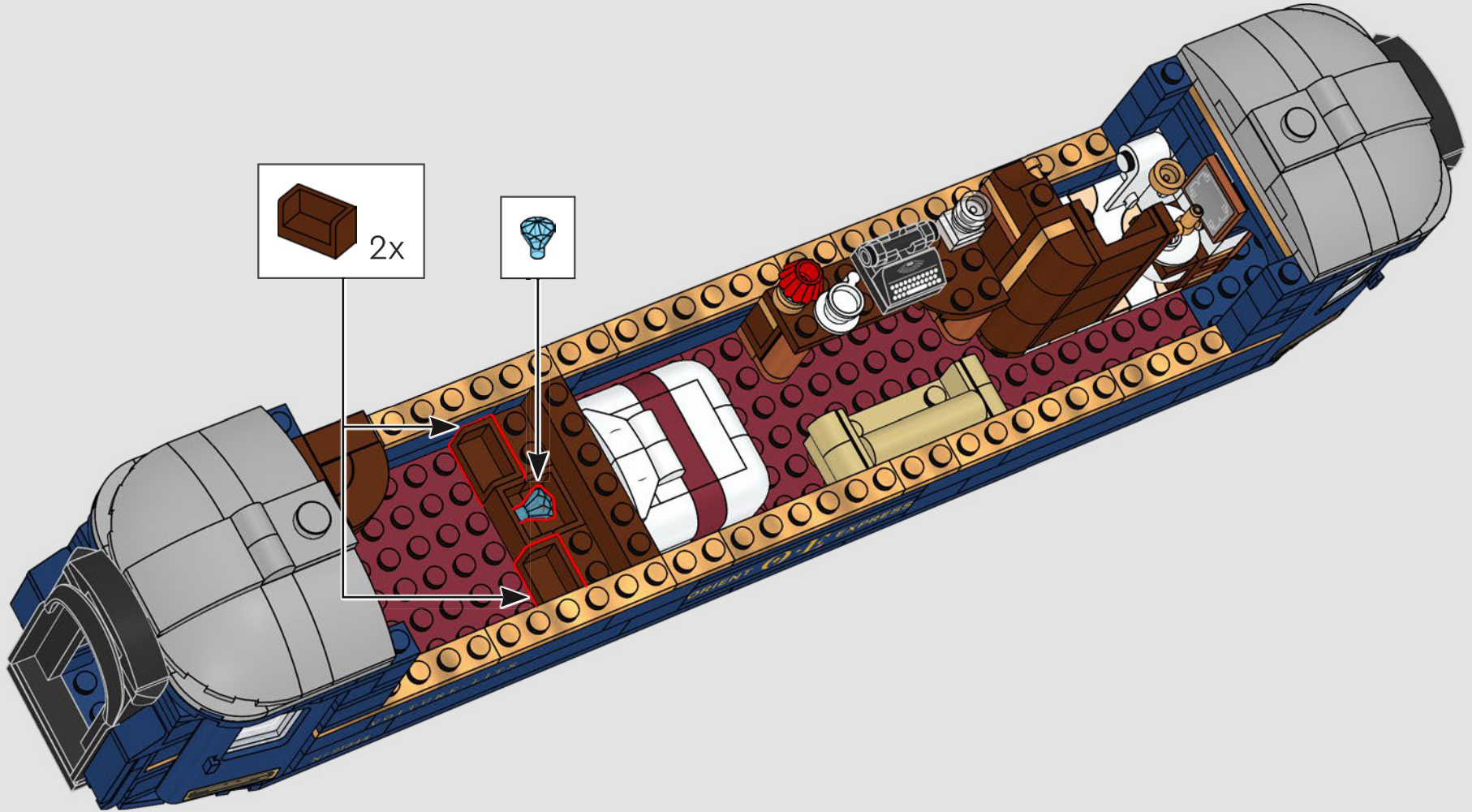



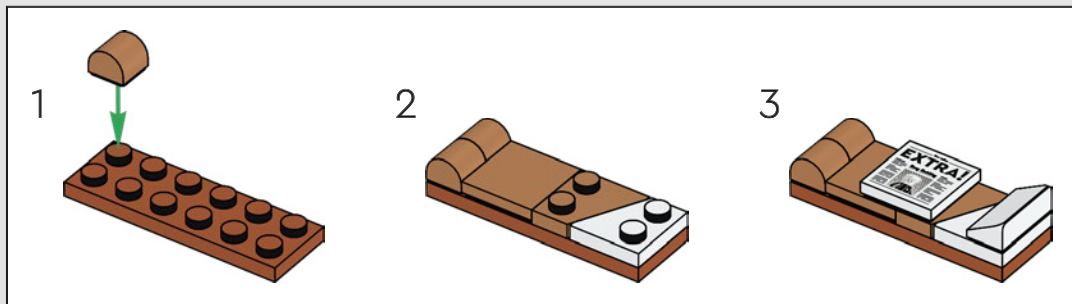
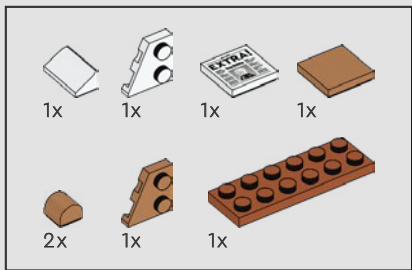

218

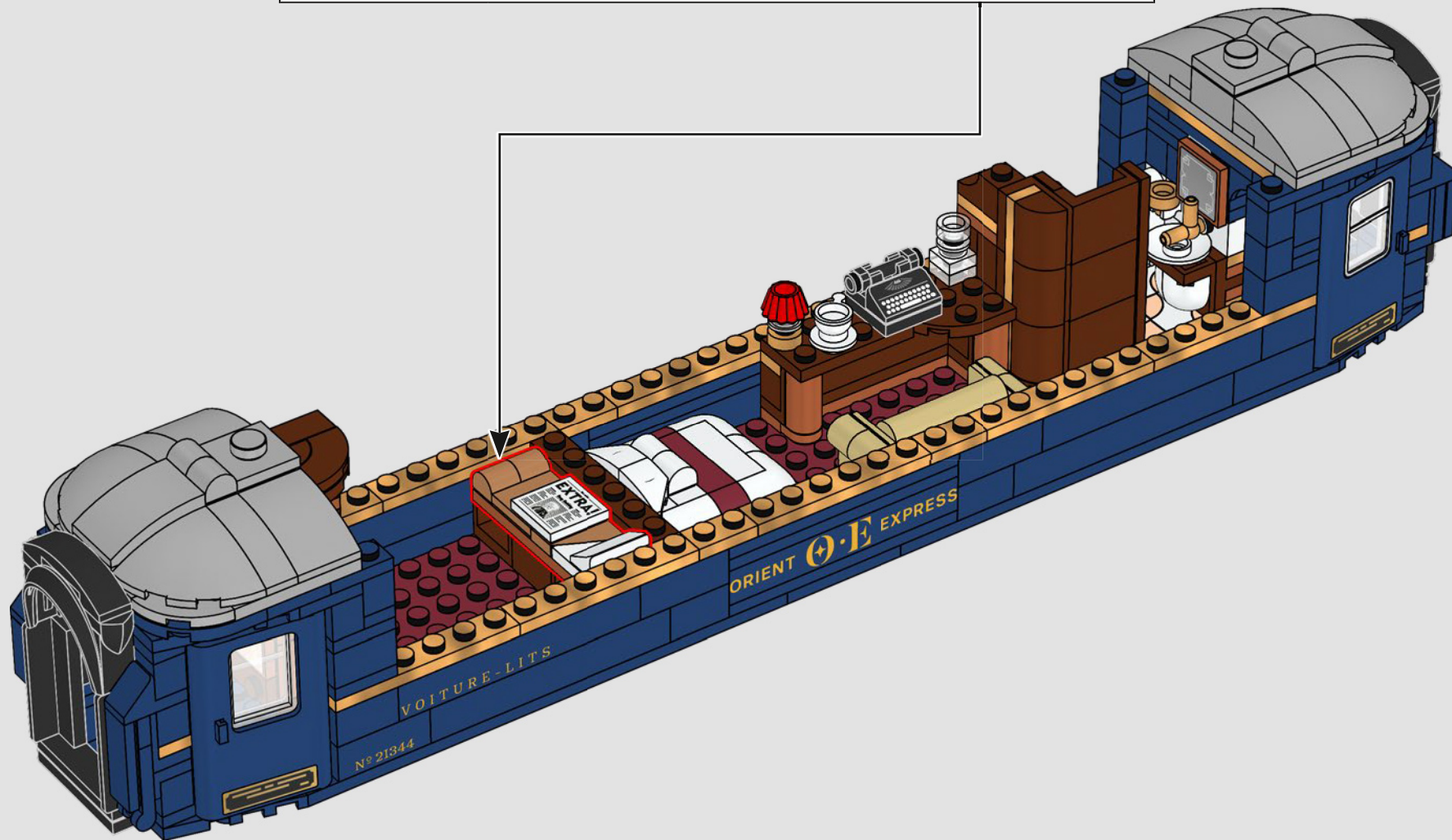



219

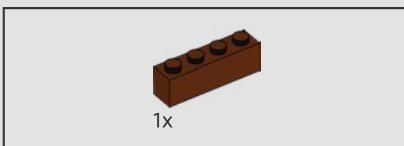
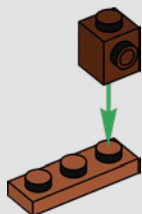

220

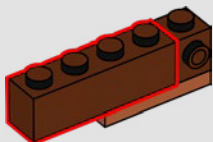

221

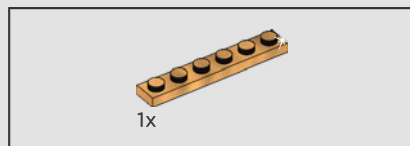
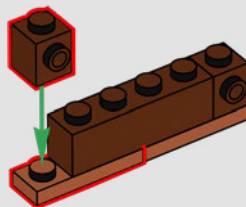

222

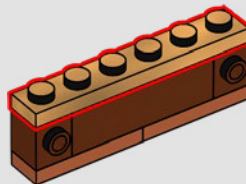

223

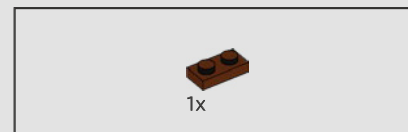
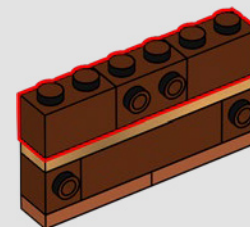

224

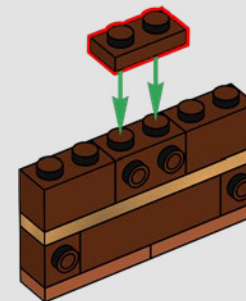



225

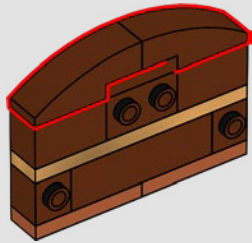

226

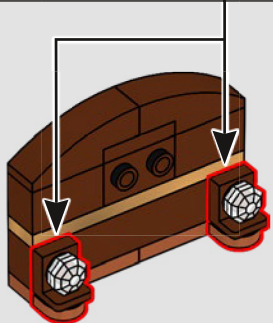
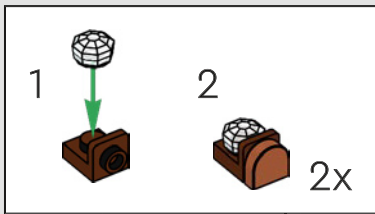

227

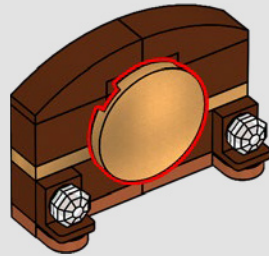

228

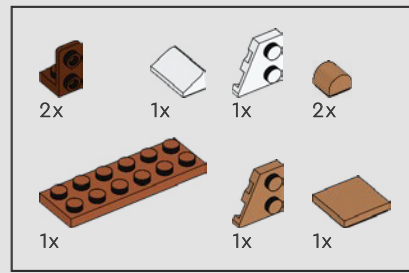
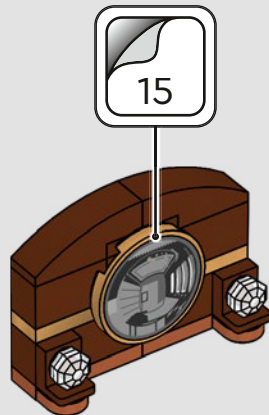

229

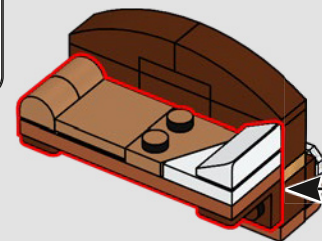
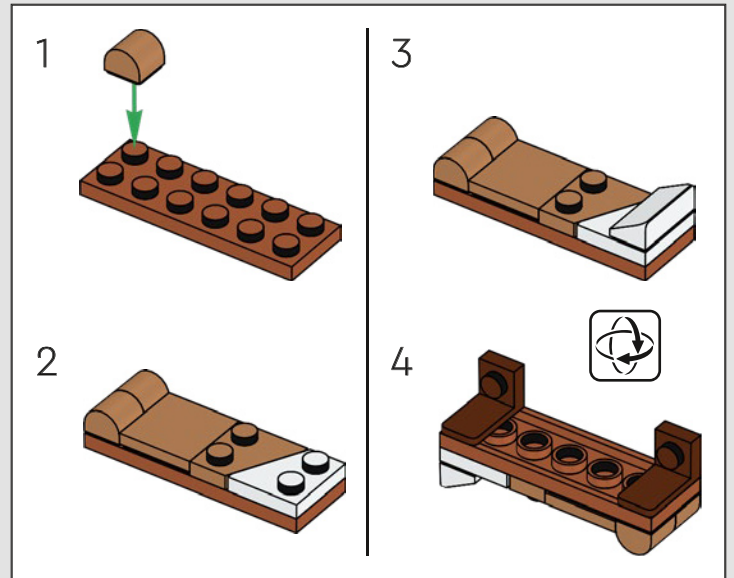



230

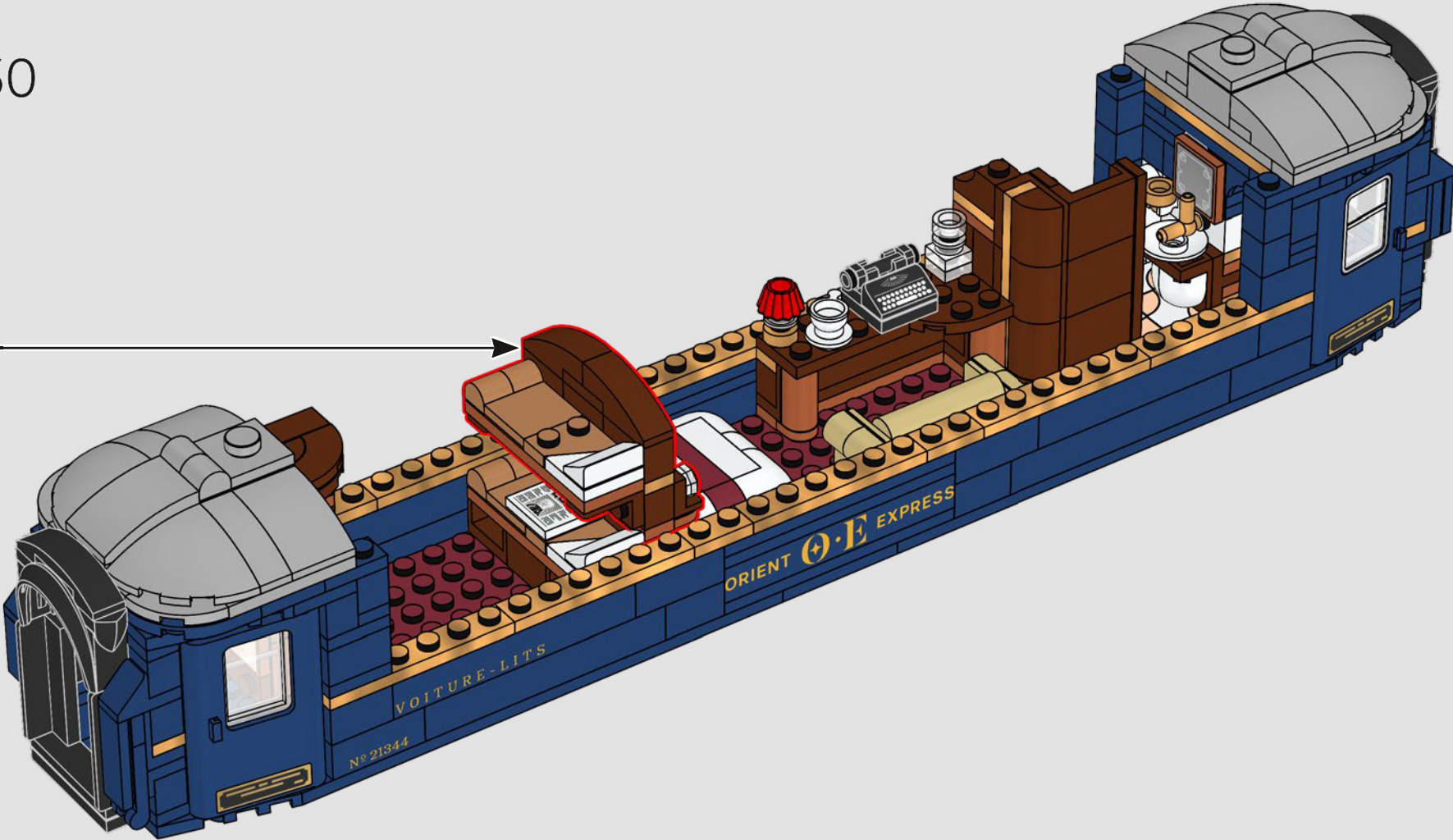

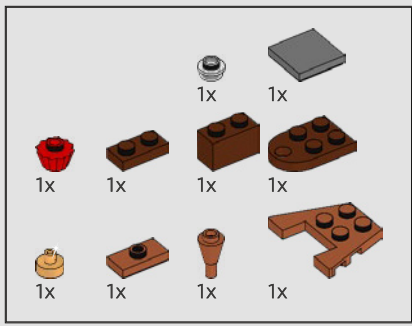

231

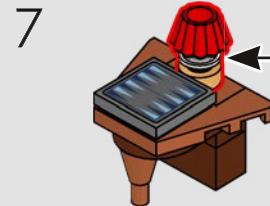
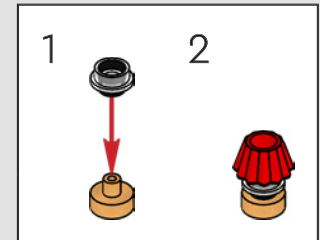
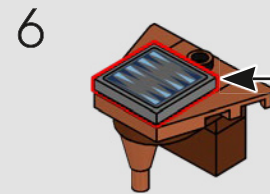
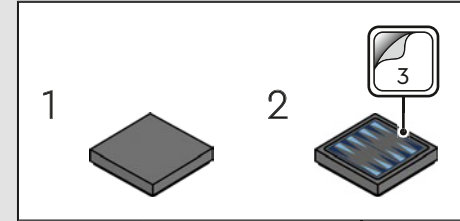
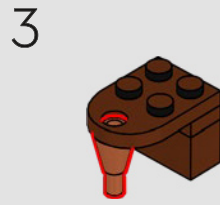
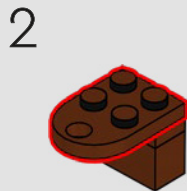
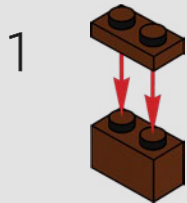

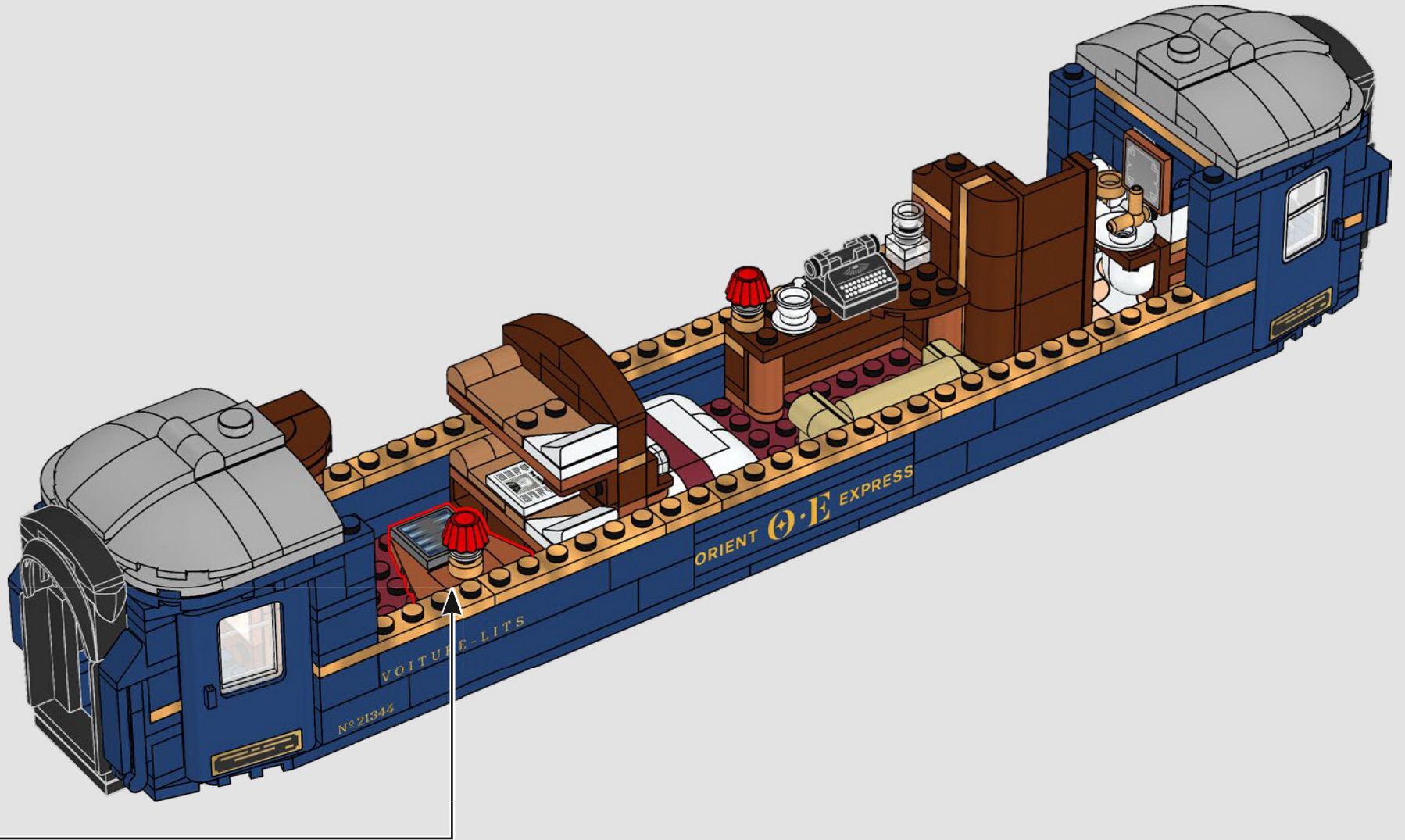





Fermata successiva: BUCAREST  
"Questa vivace città è la nostra prossima tappa.  
I grandi viali brulicano di attività".

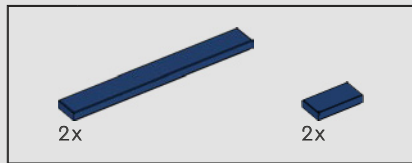

232

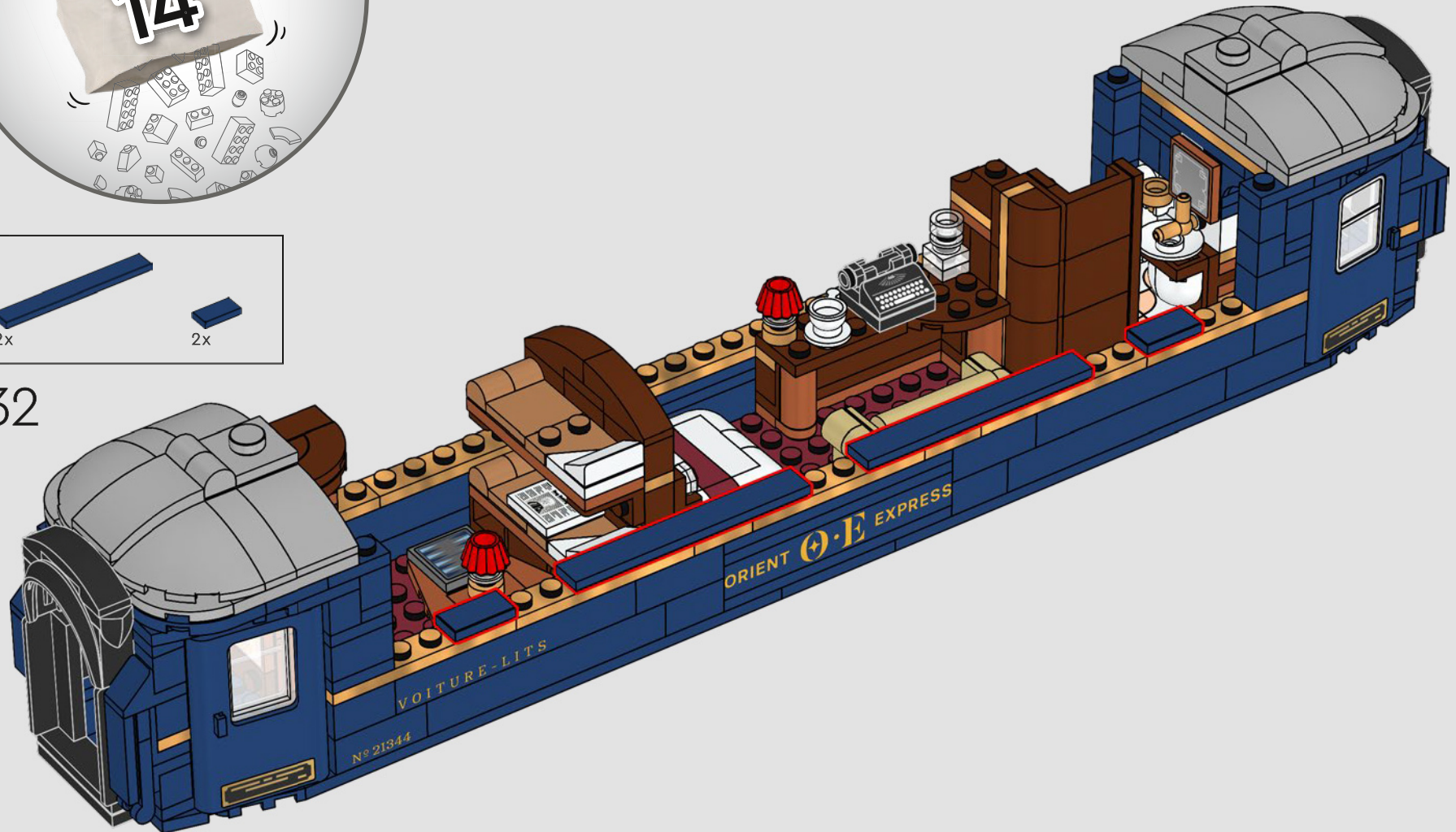

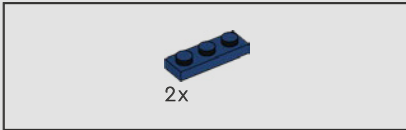
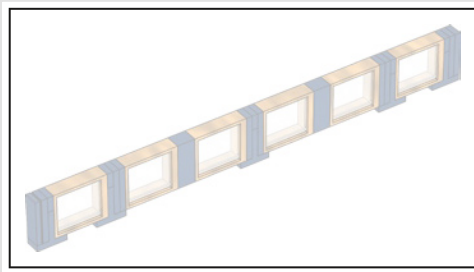

2x

233

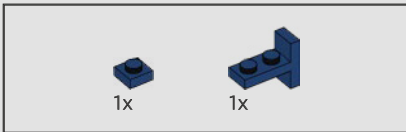
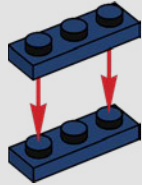

1x

1x

234

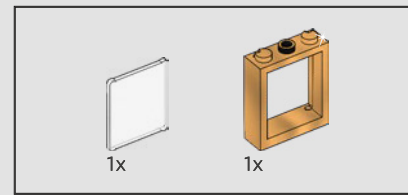
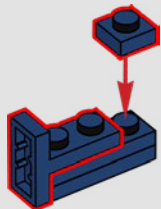

1x

1x

235

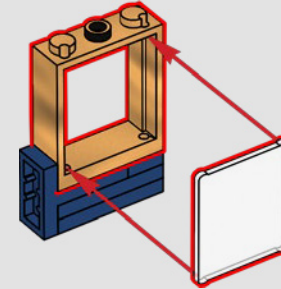

1x

1x

236

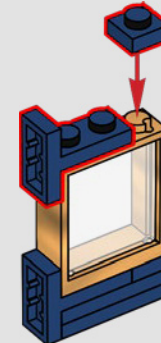

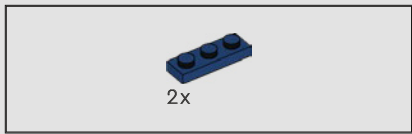

237

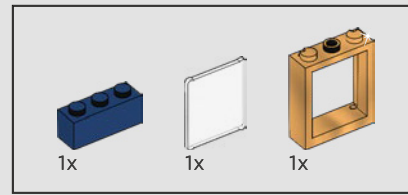
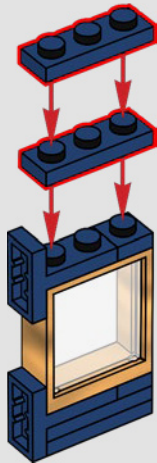

238

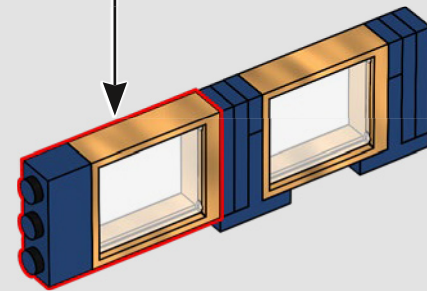
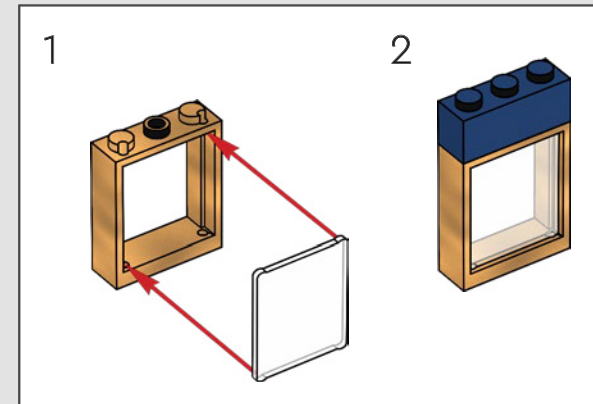



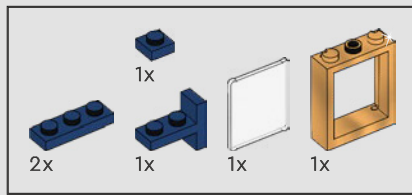

239

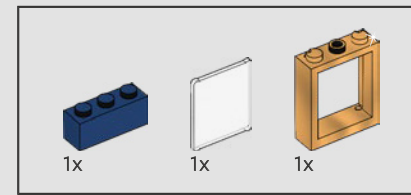
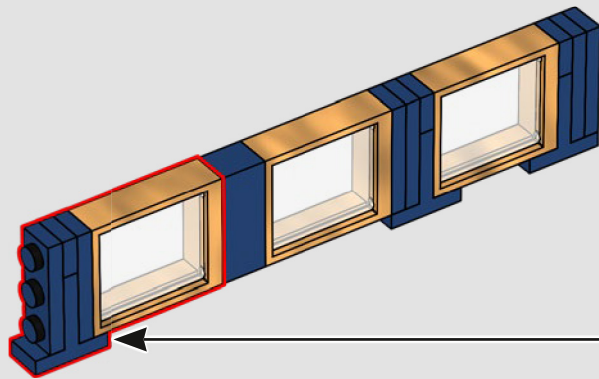
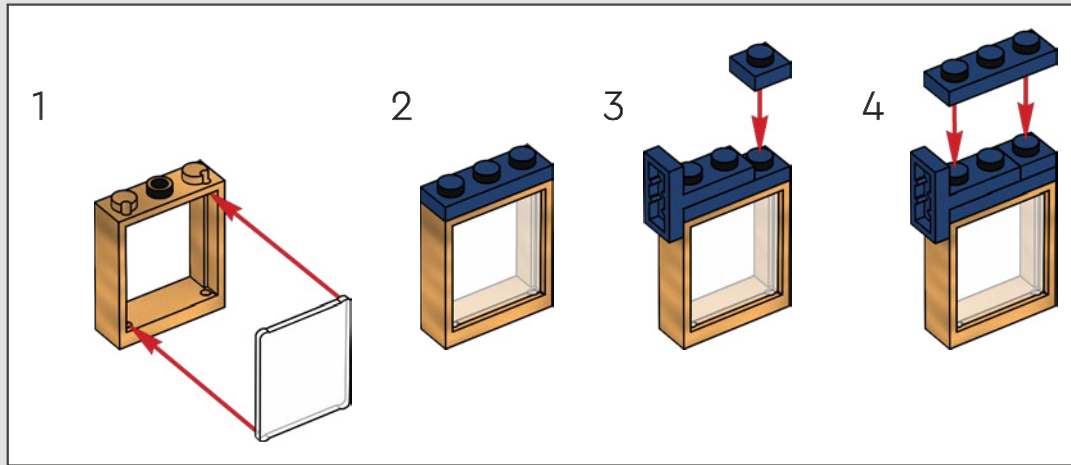

240

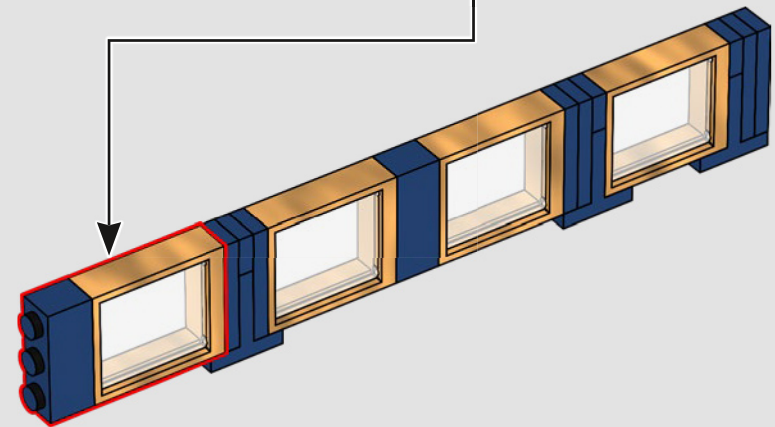
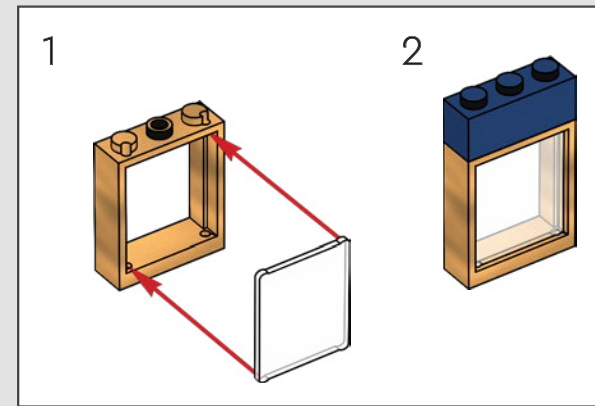

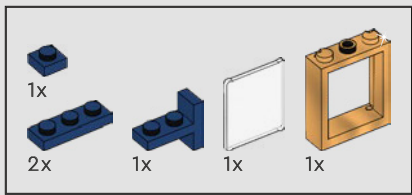

241

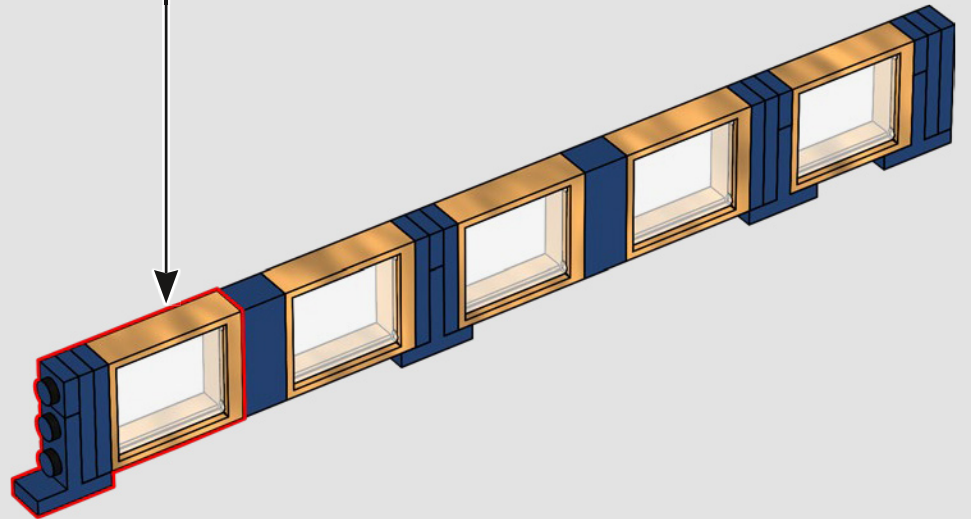
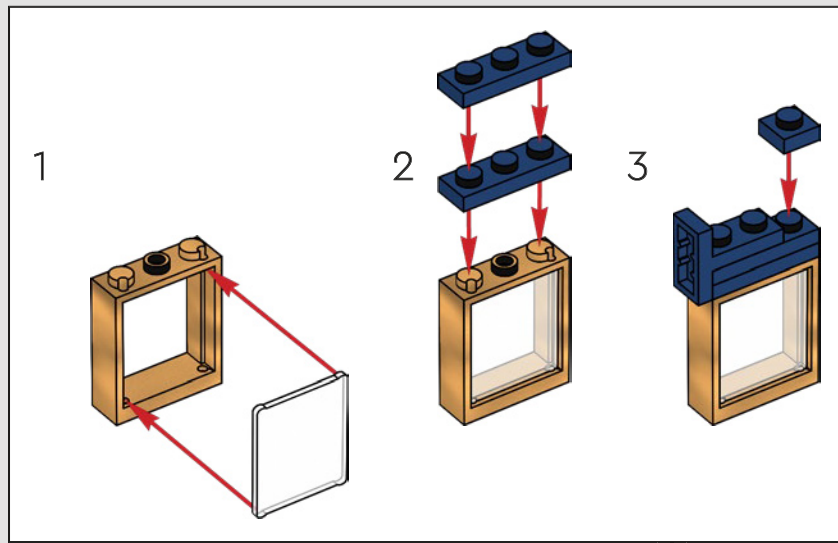

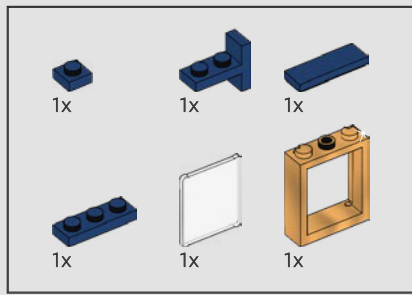

242

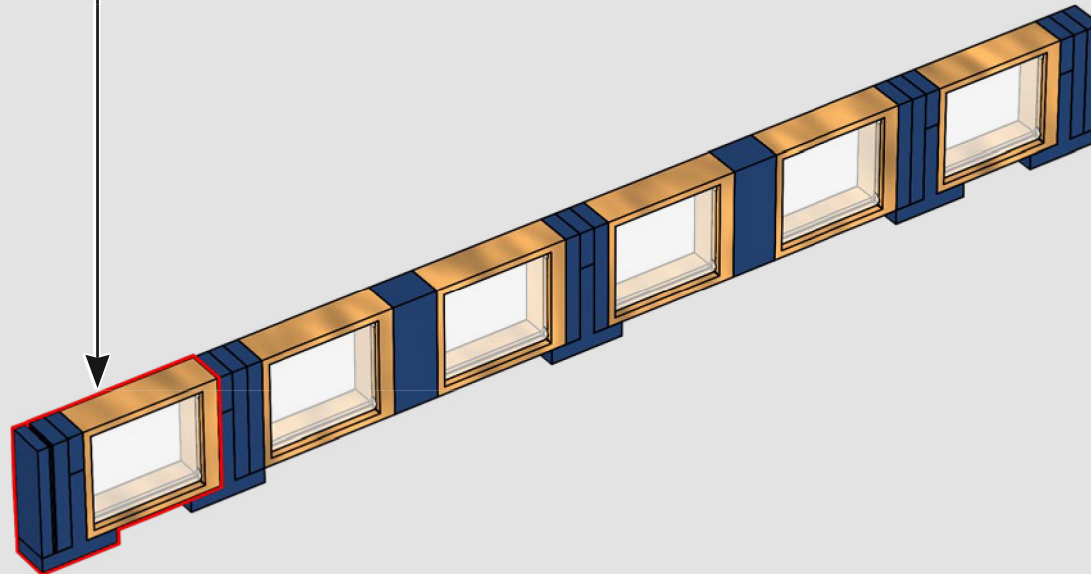
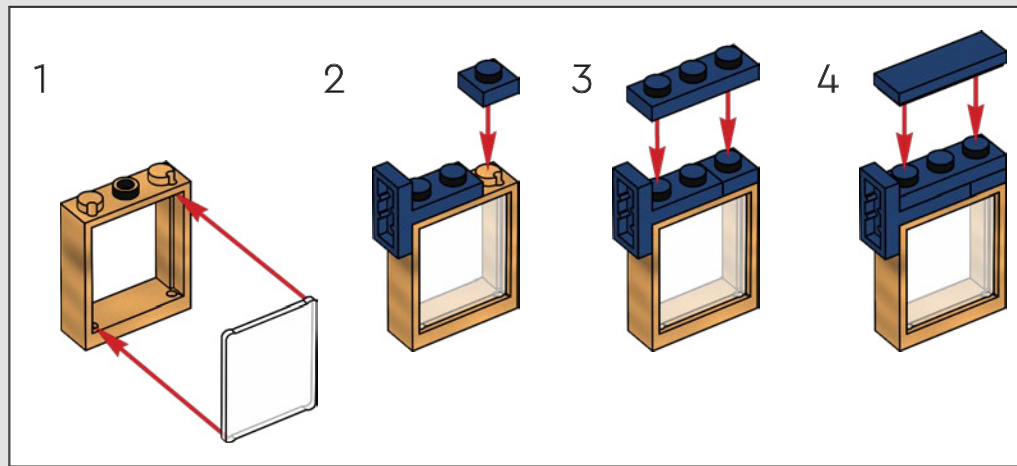



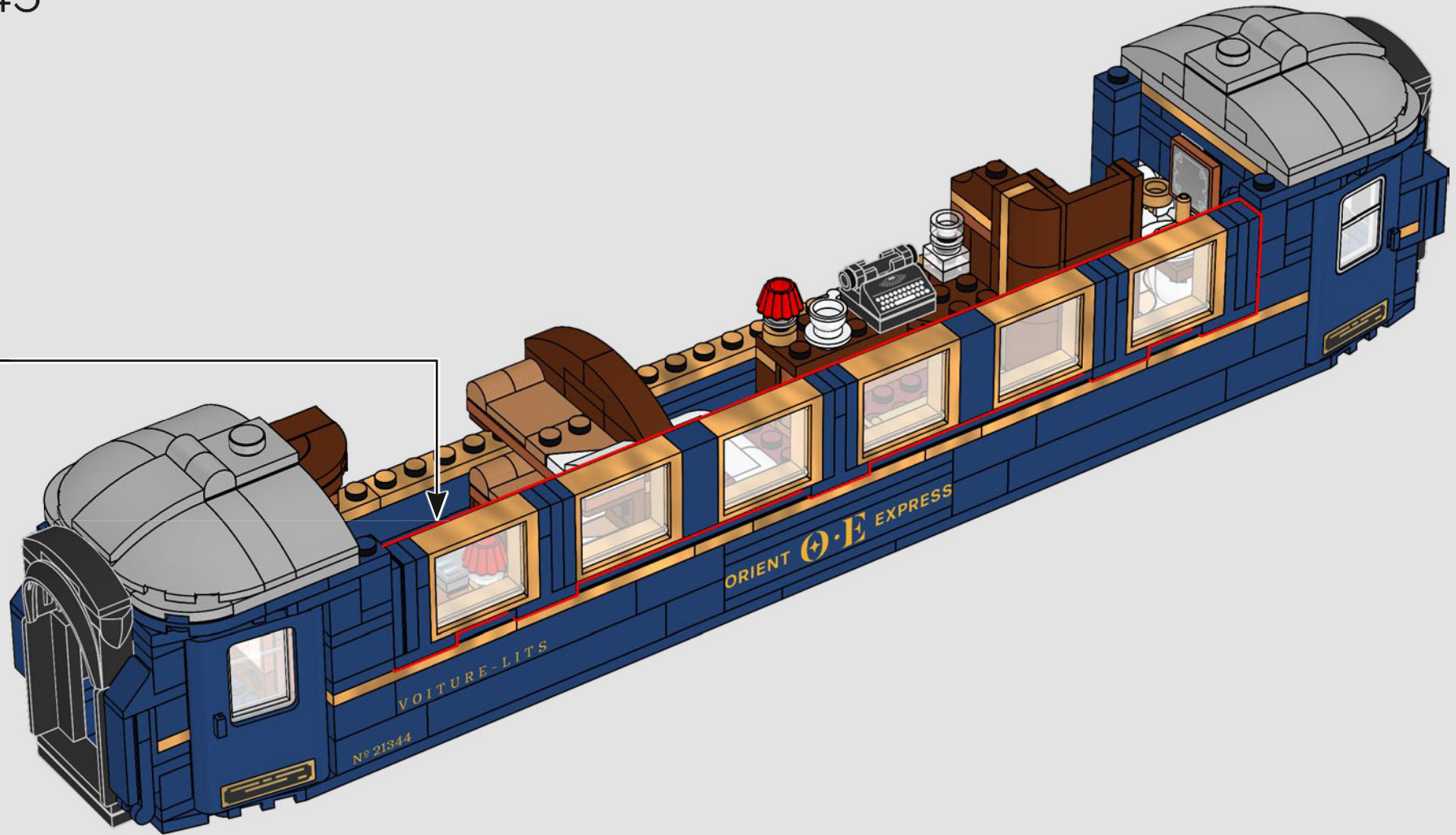

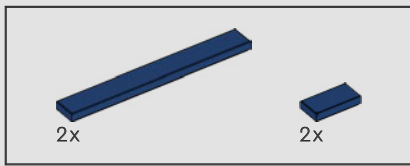

244



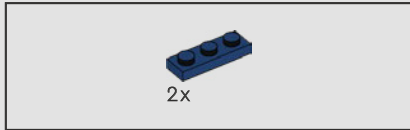
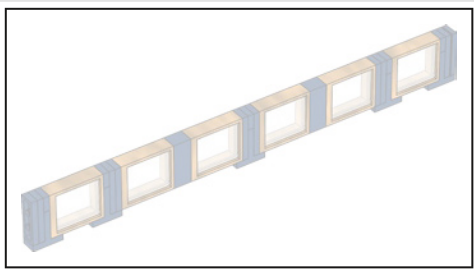

245

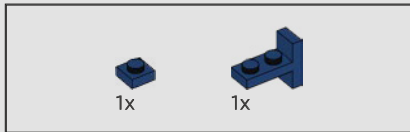
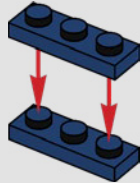

246

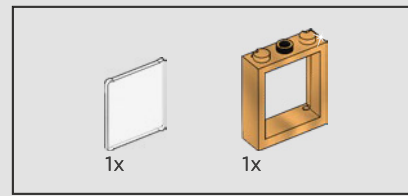
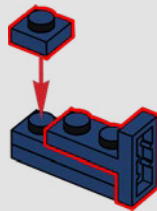

247

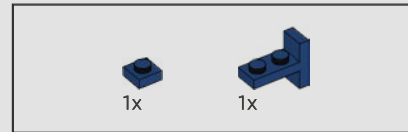
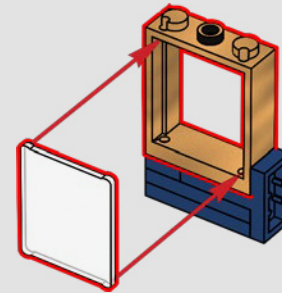

248

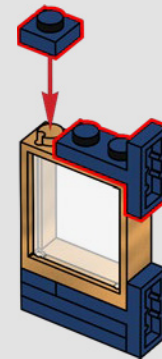



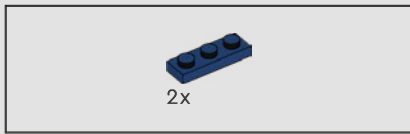

249

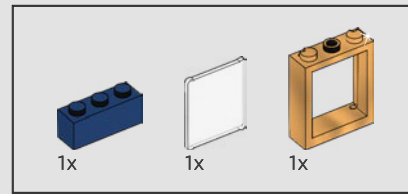
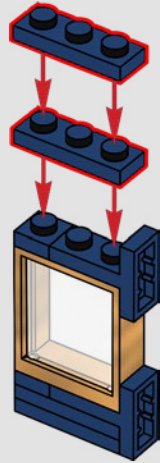

250

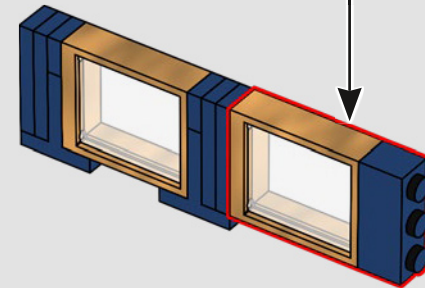
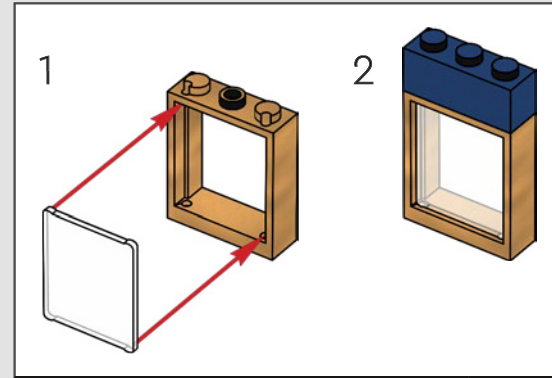

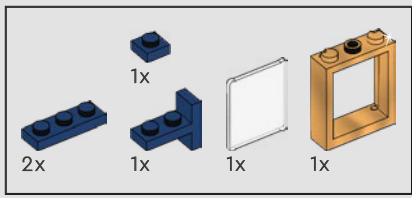

251

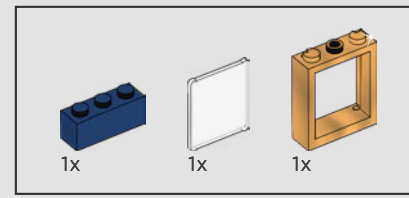
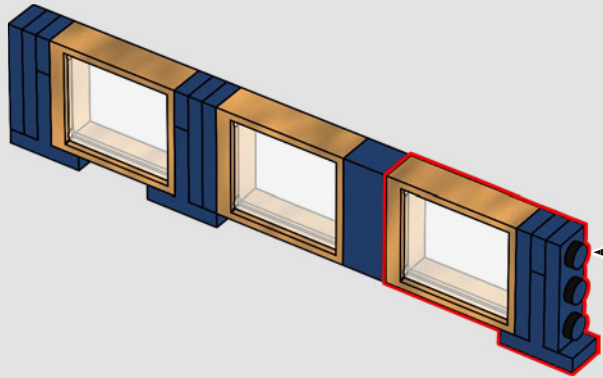
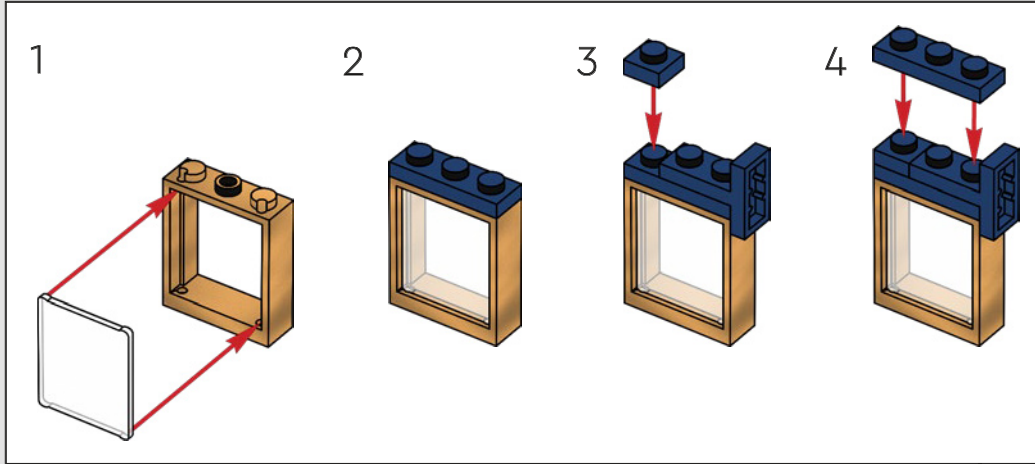

252

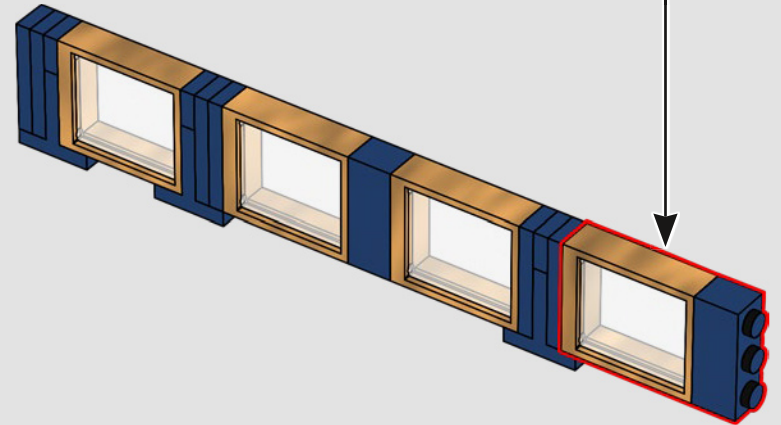
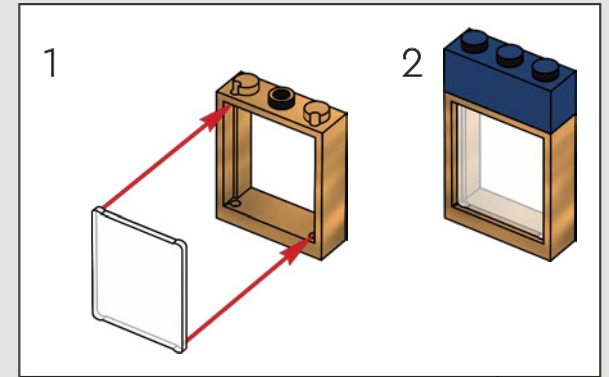

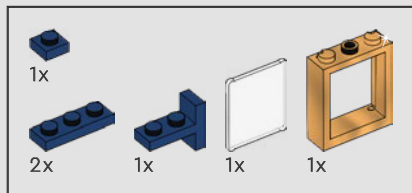

253

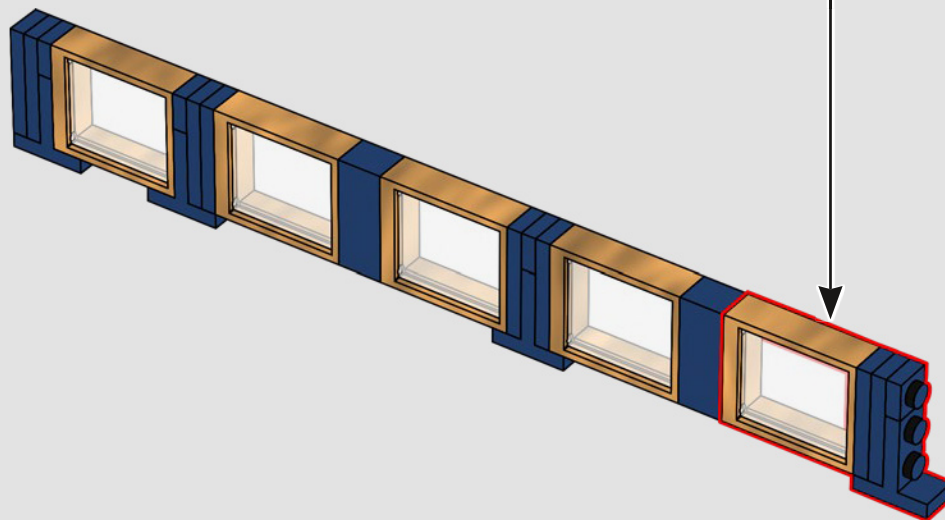
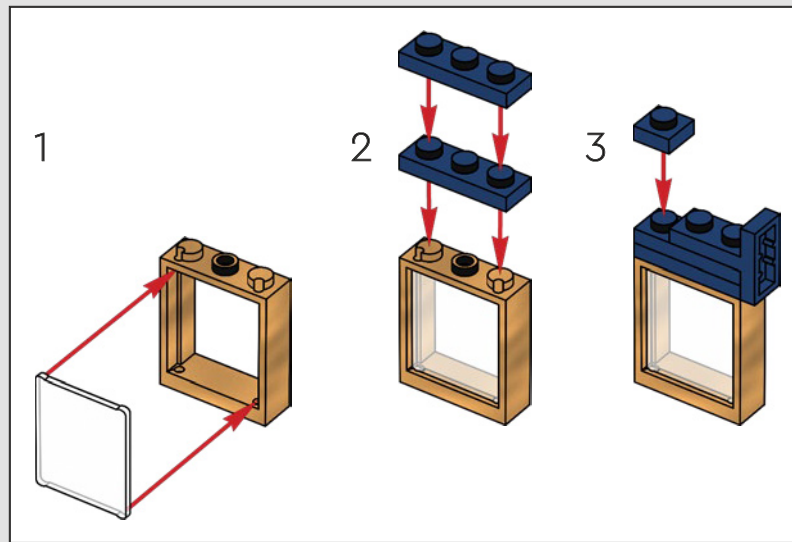



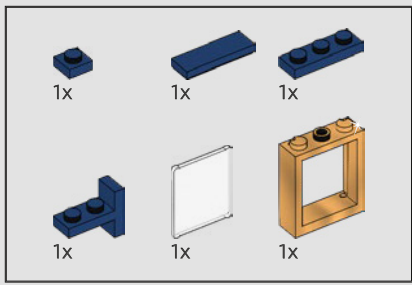

254

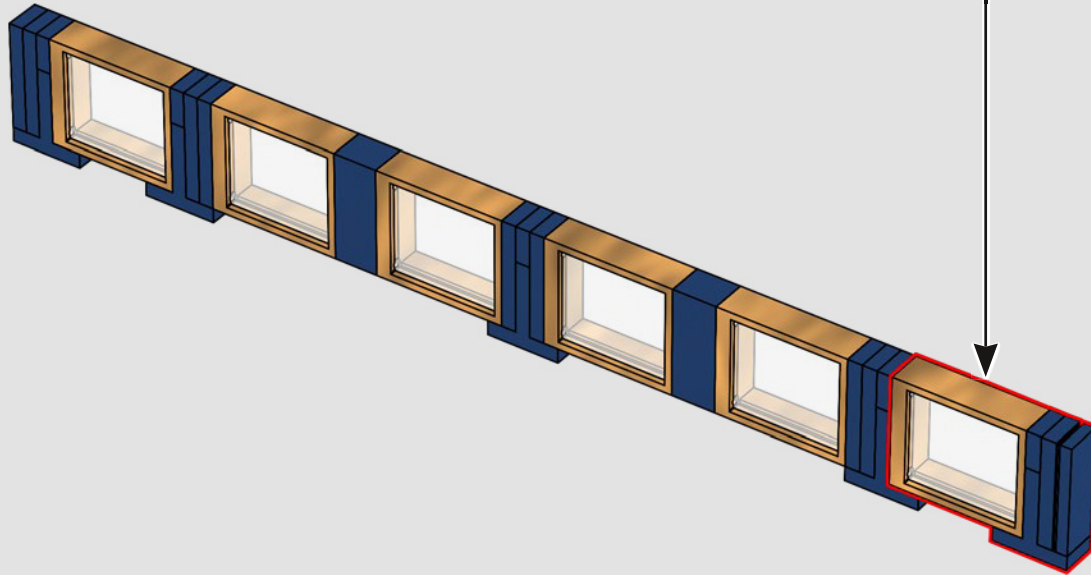
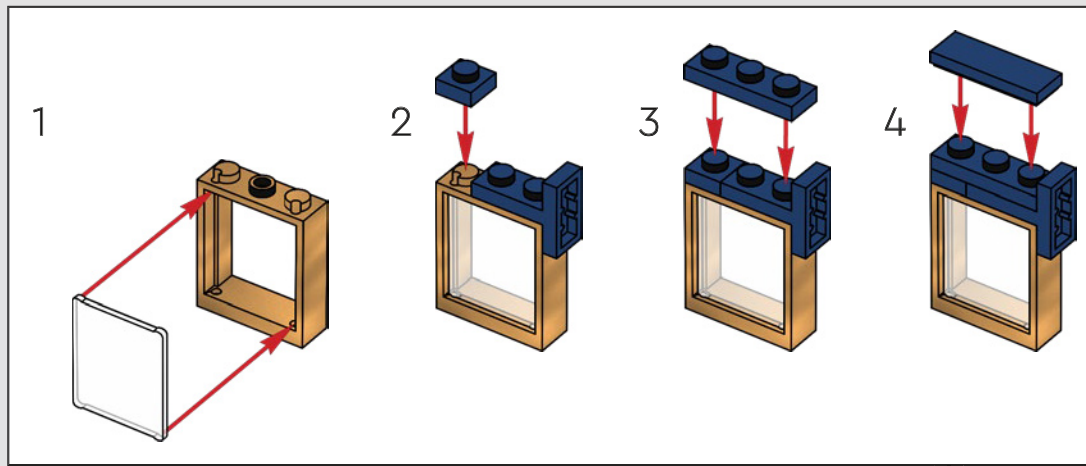

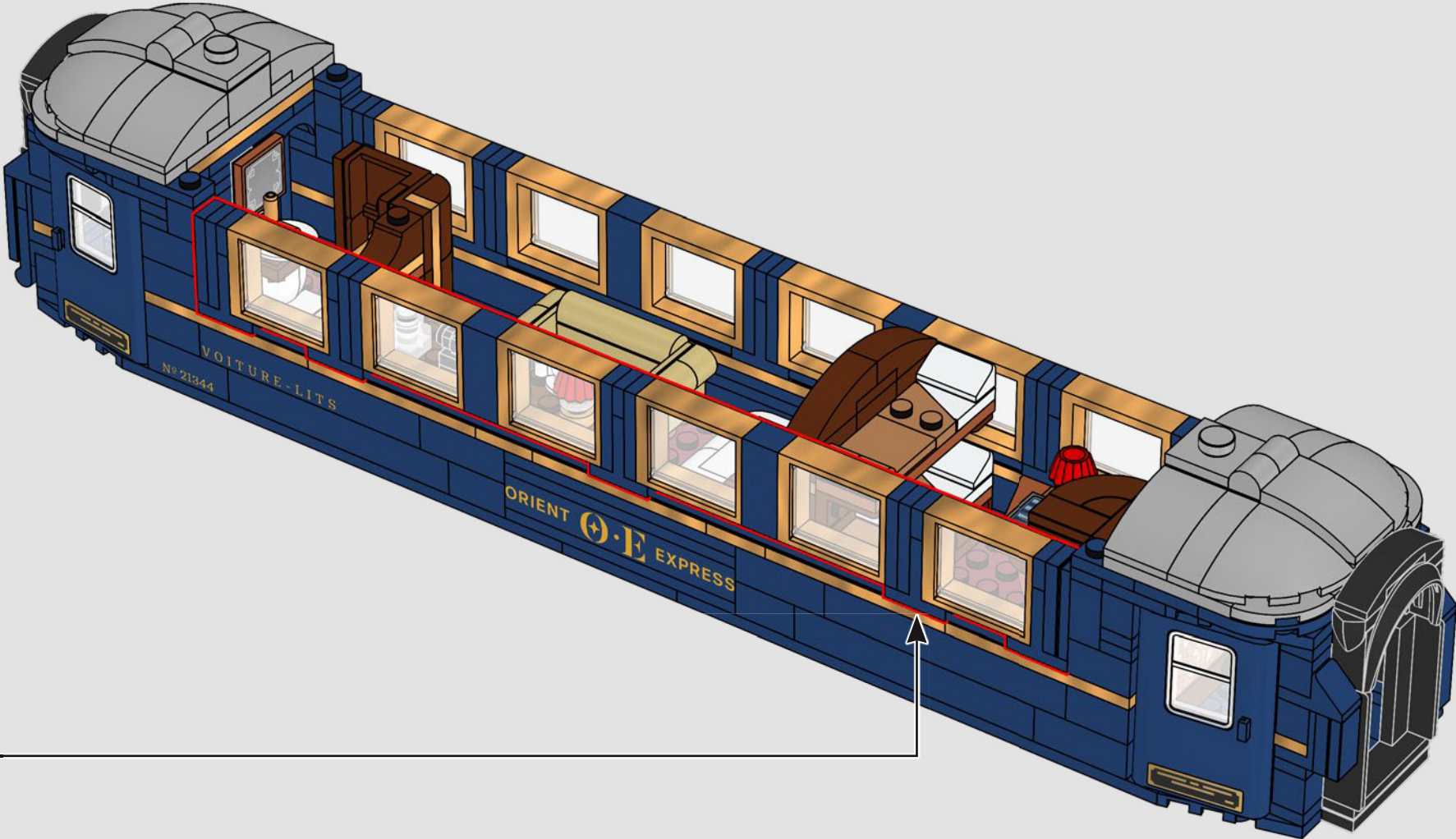



● .....  
"I passeggeri trasportano ogni tipo di bagaglio:  
dai manufatti agli effetti personali... alcuni hanno  
TANTISSIME valigie!"

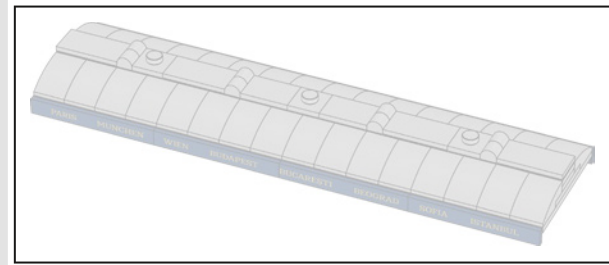
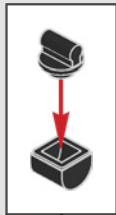
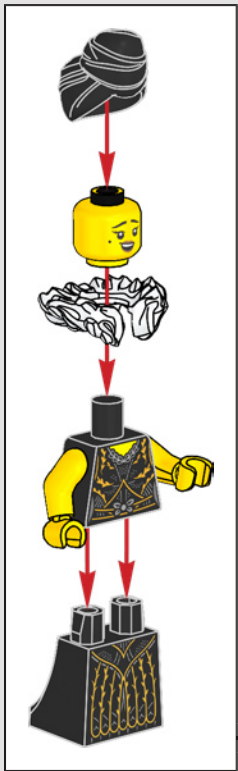

256

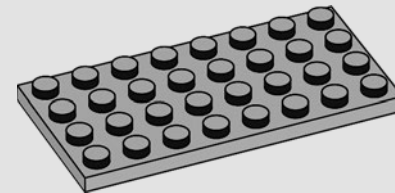



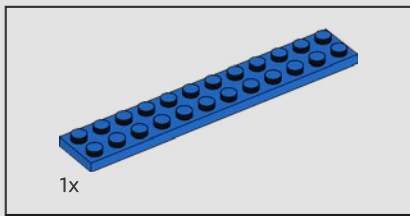

257

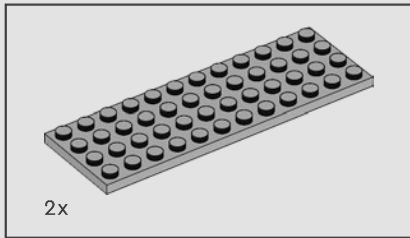
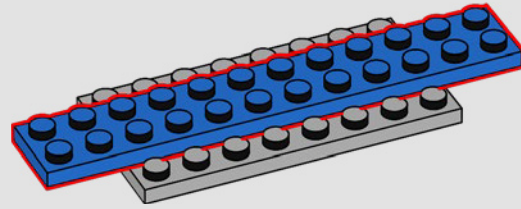

258

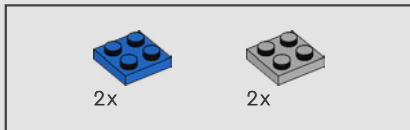
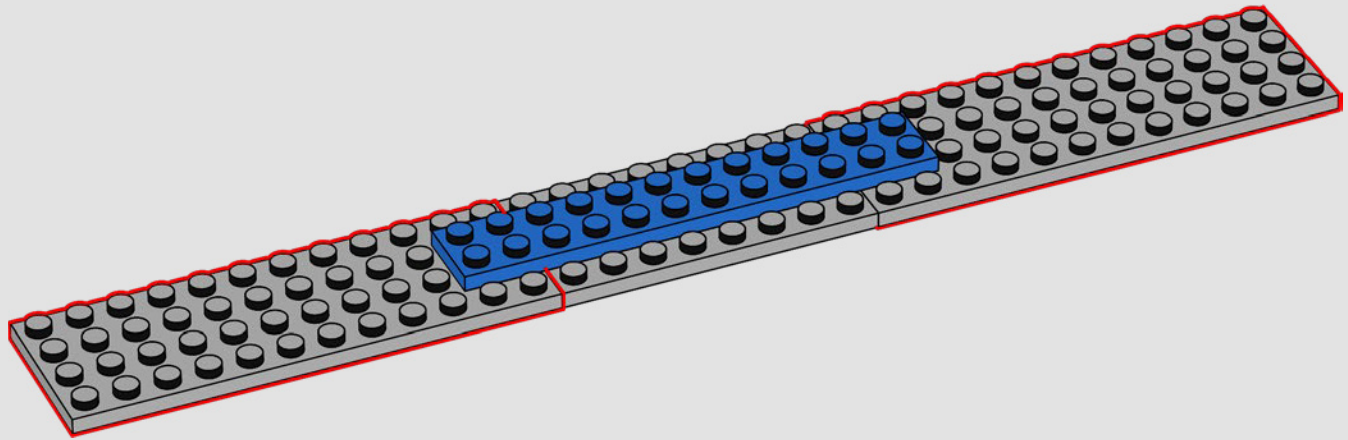

259

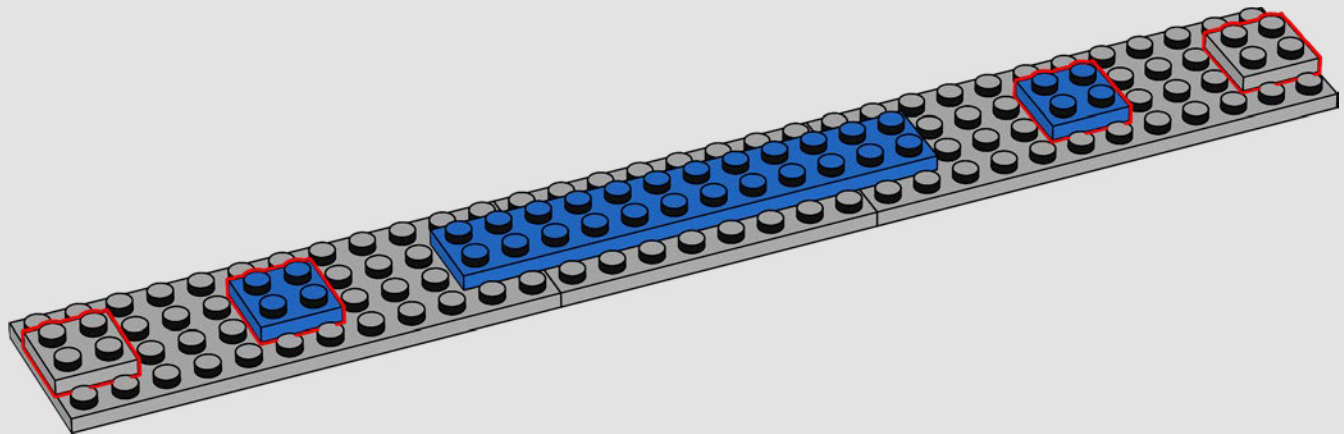

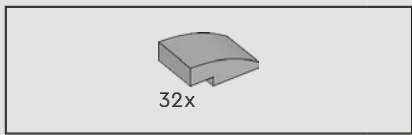

260

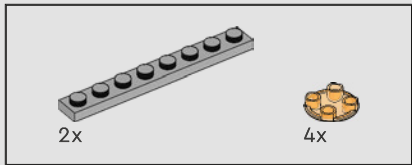
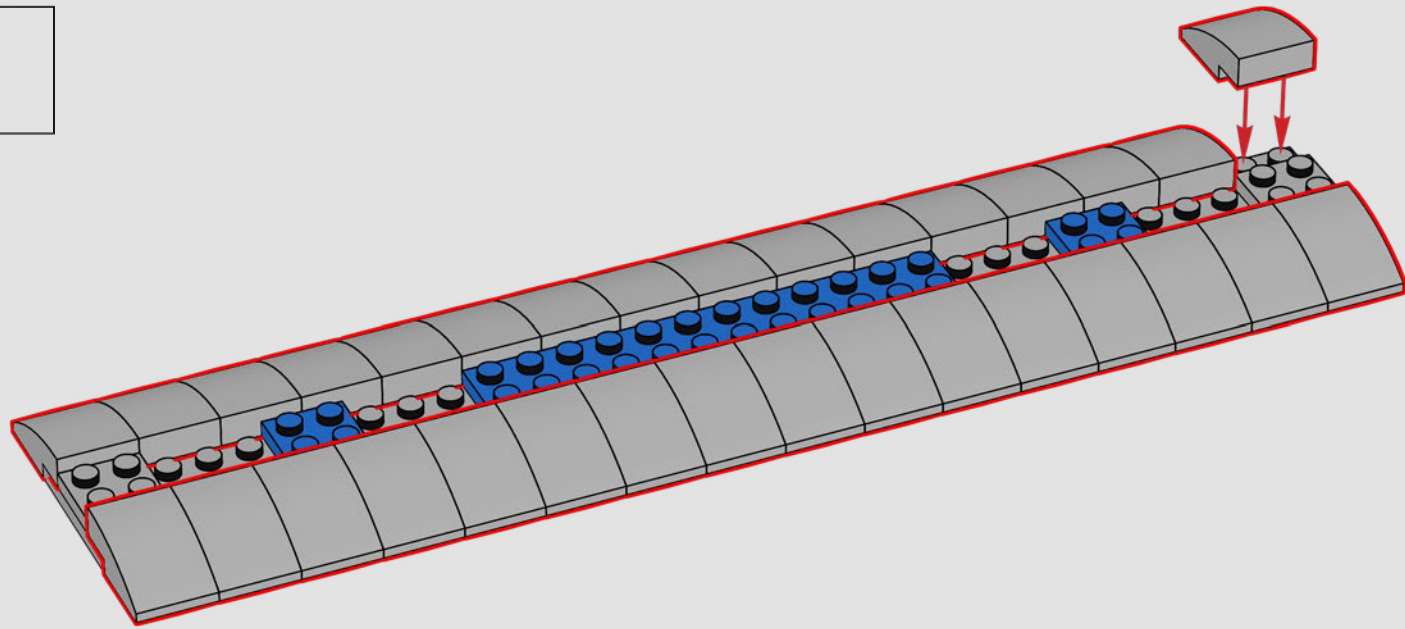

261

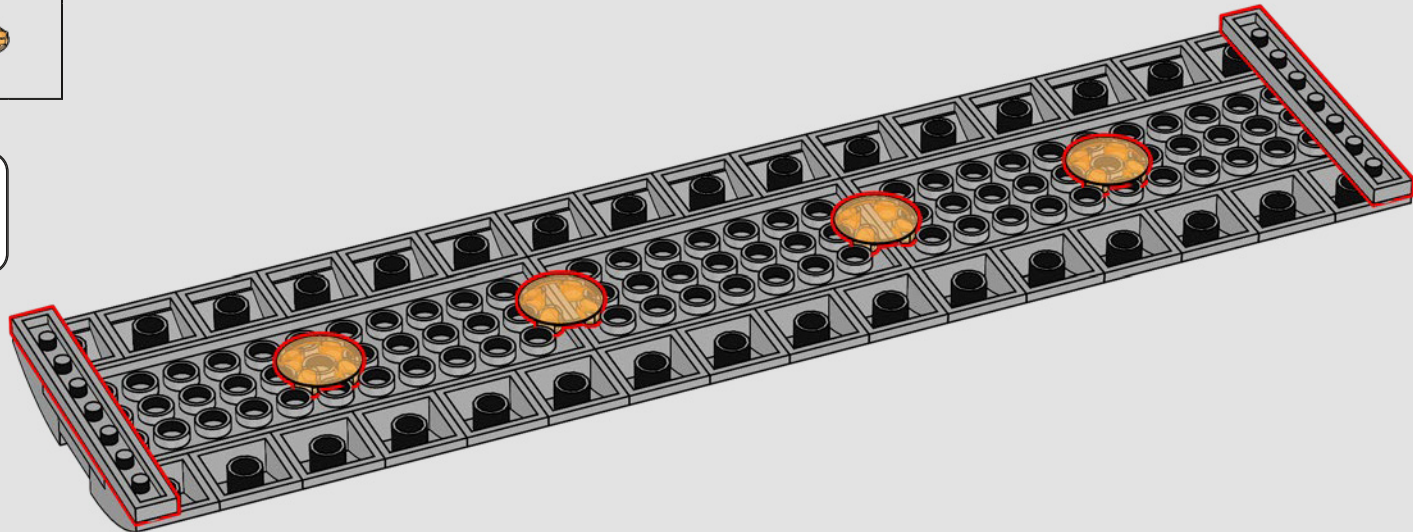

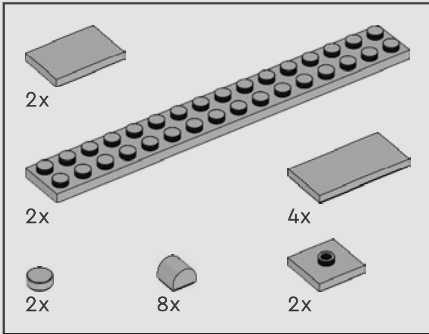
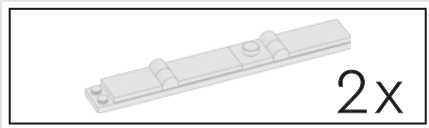

262

1

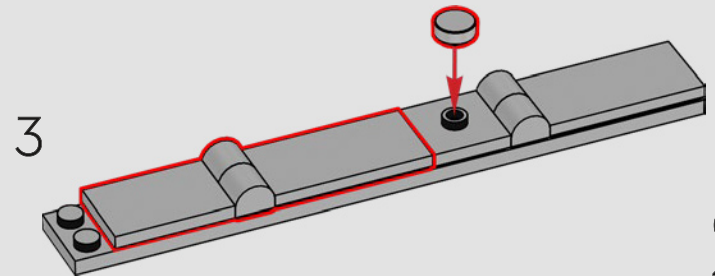
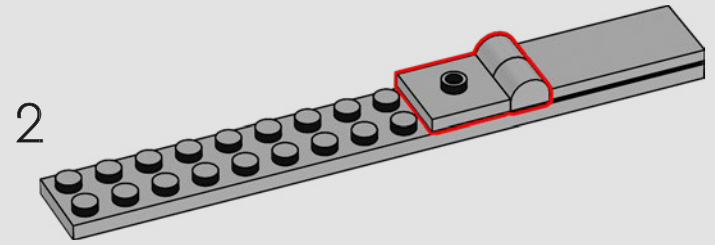
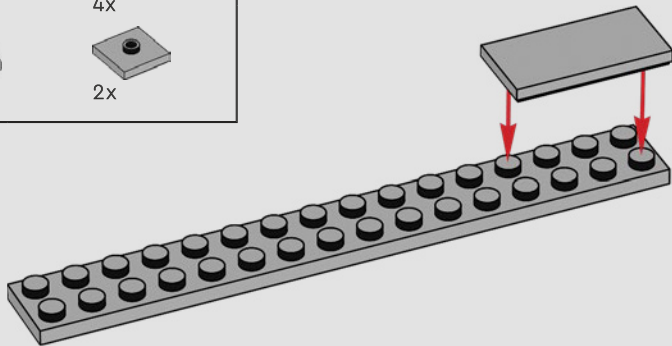

2x

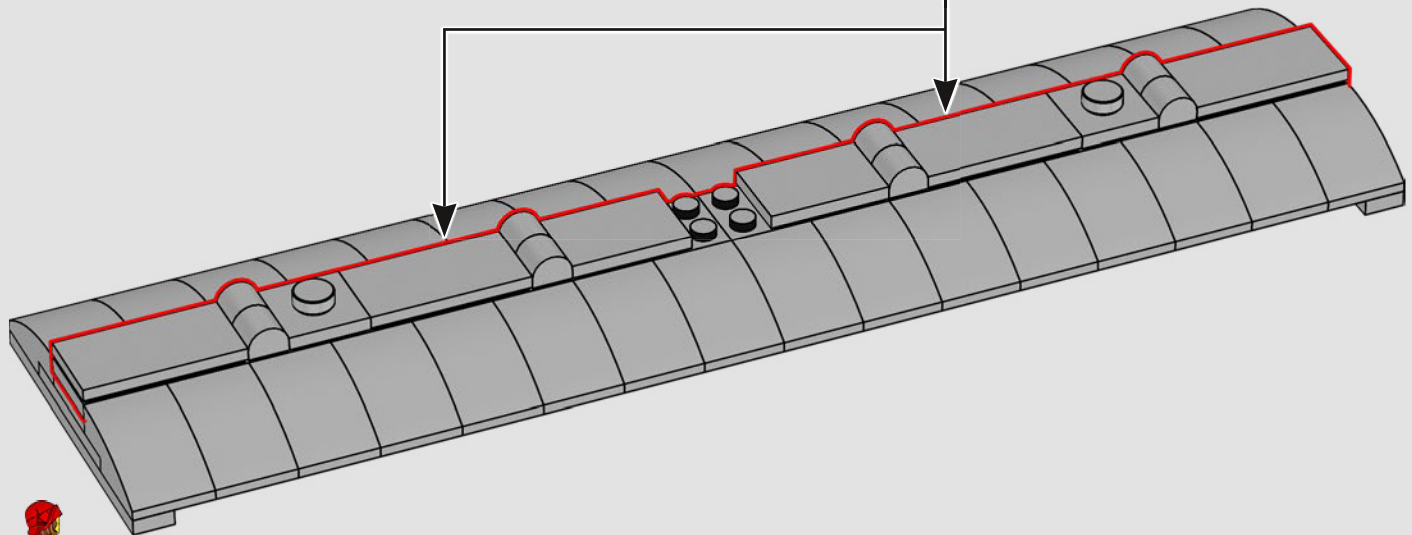



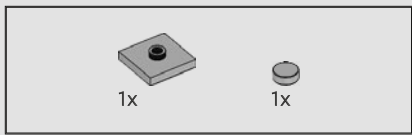

263

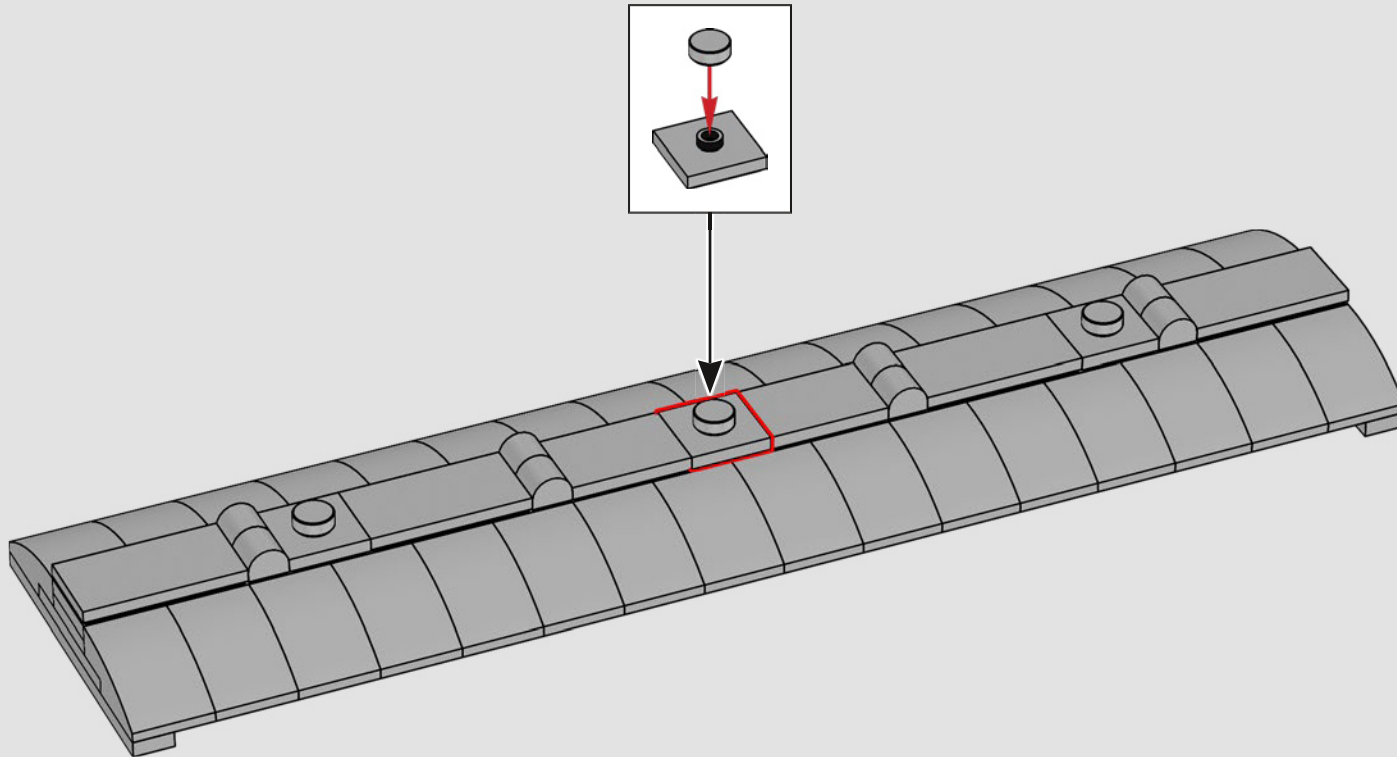

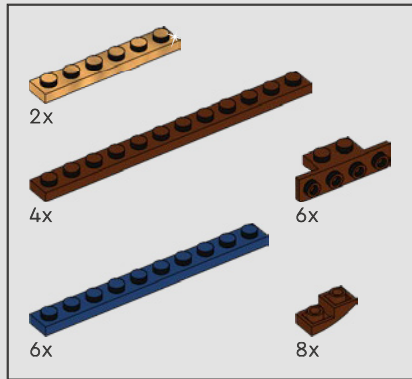
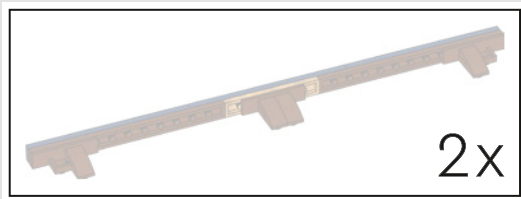

264

1

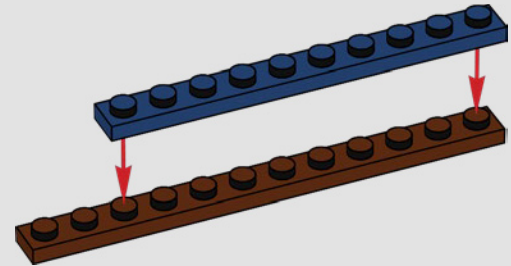

2

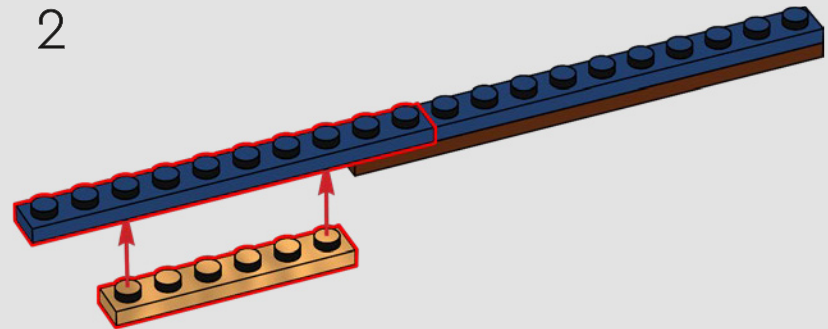

3

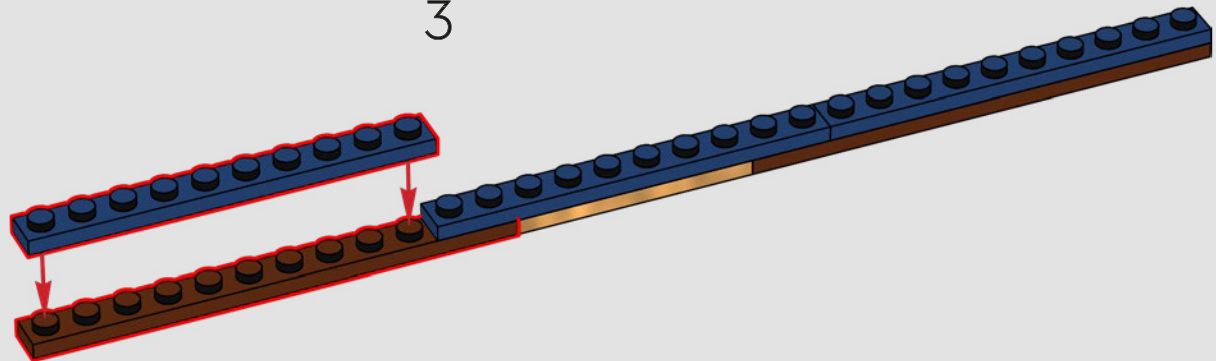

4

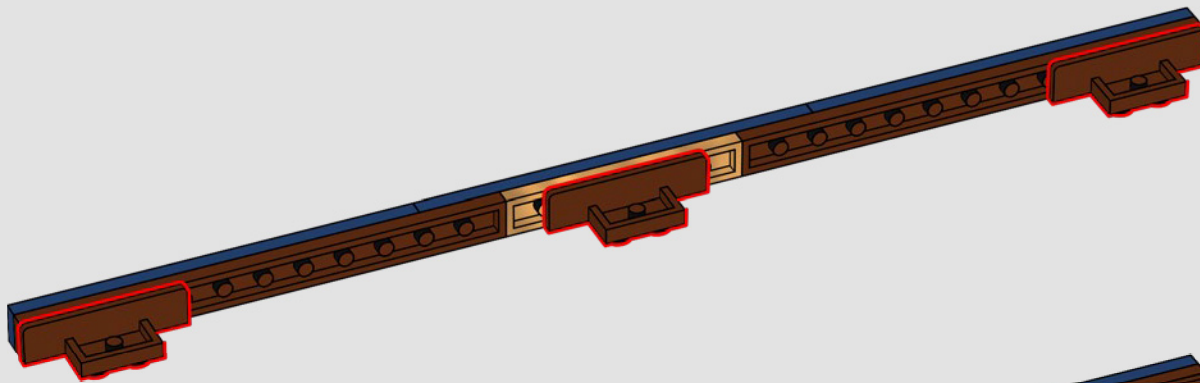

5

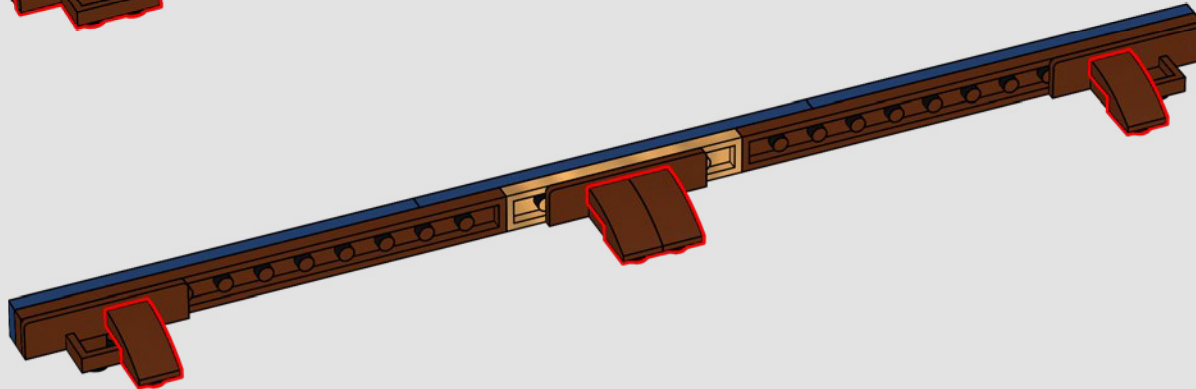

2x

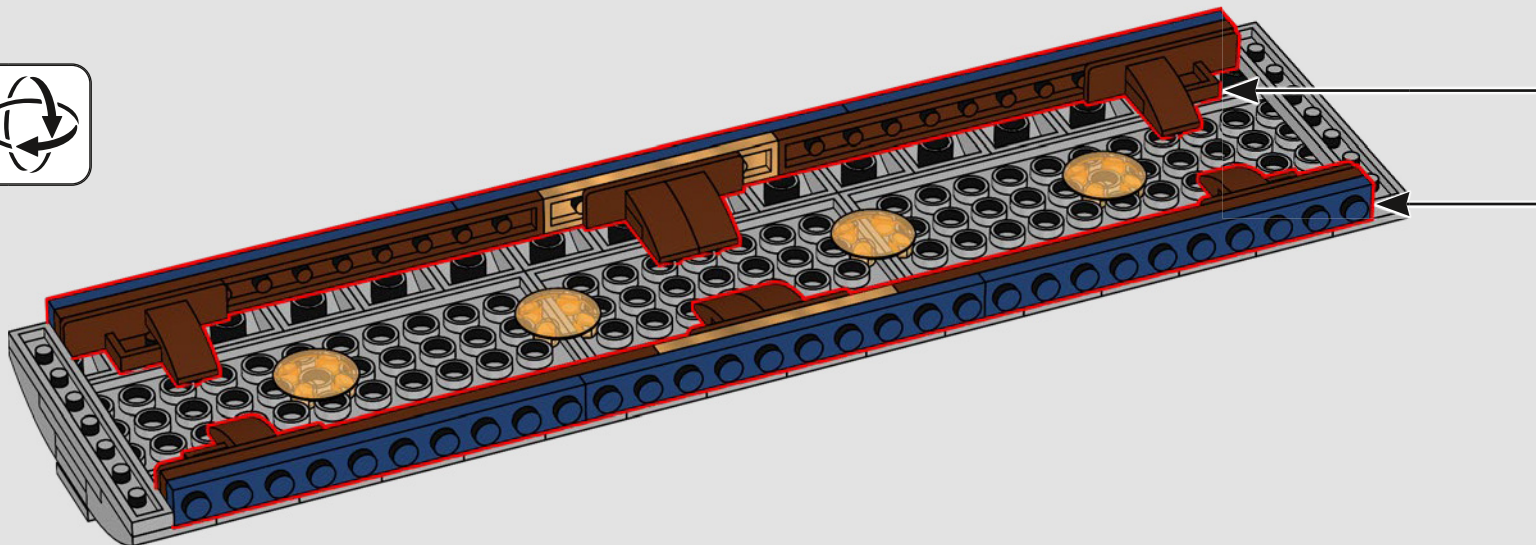



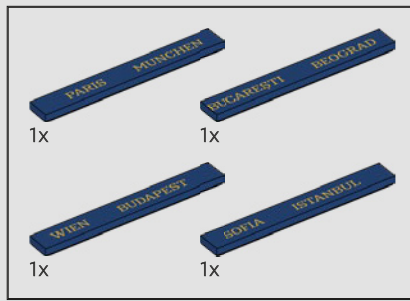

265

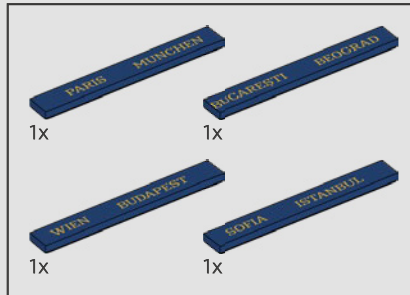
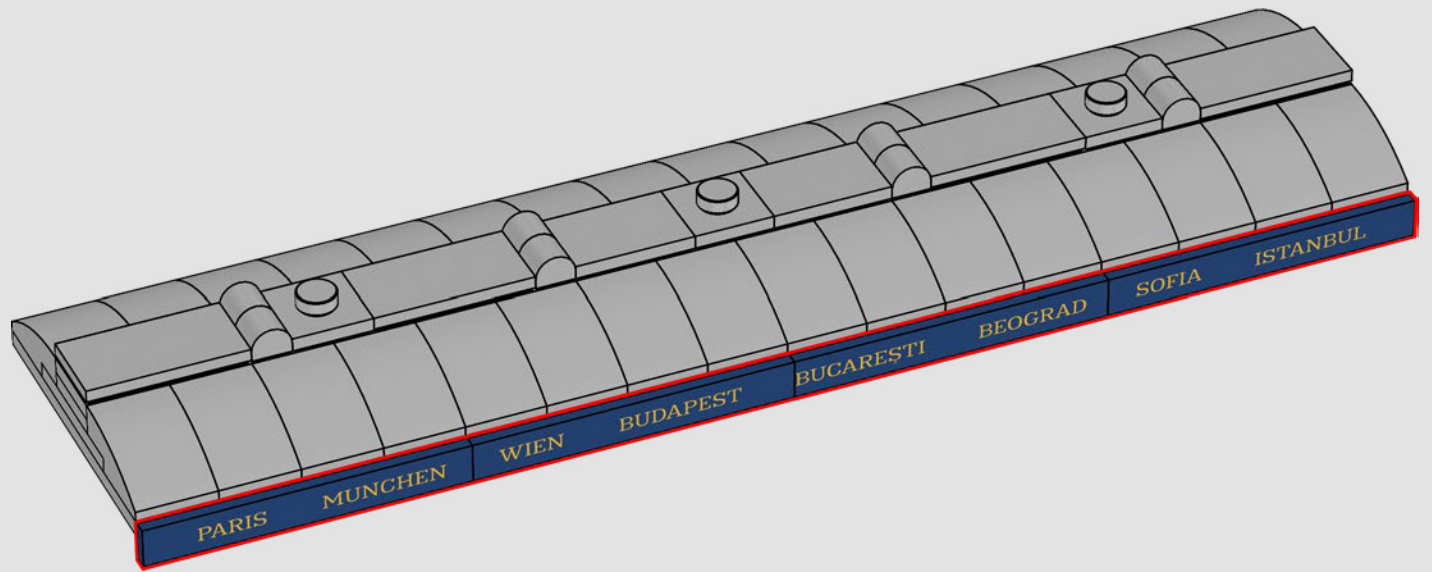

266

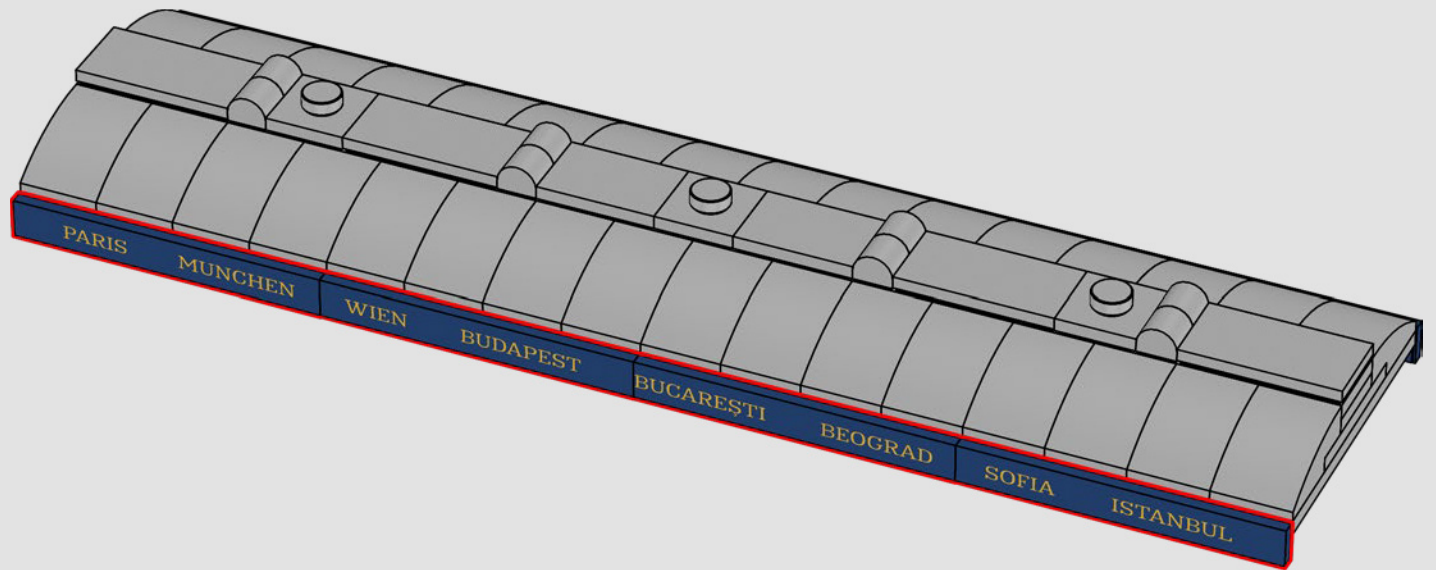

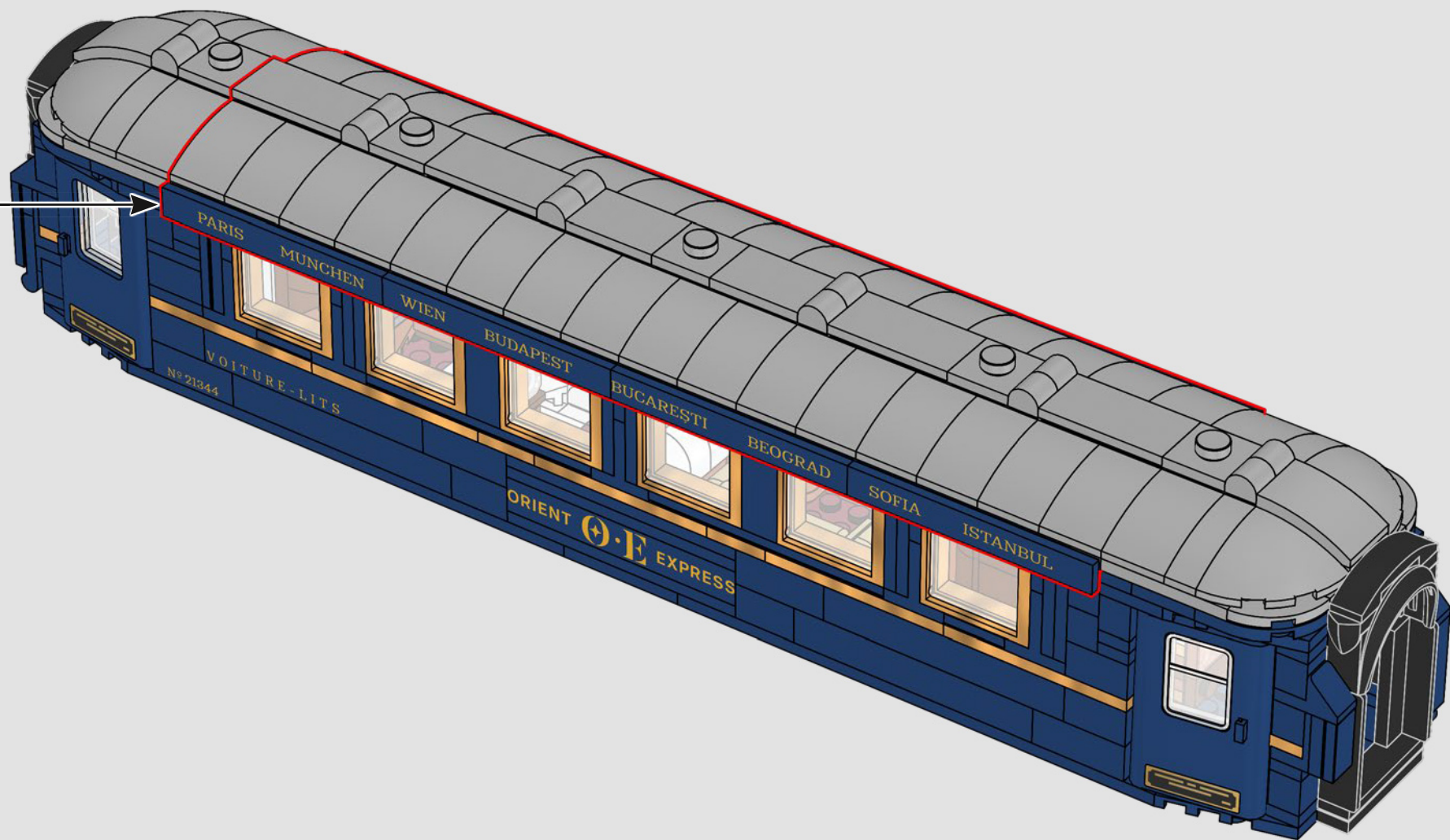

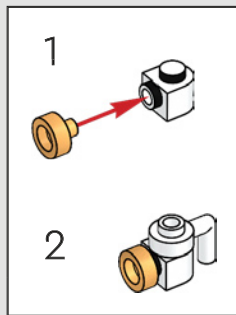
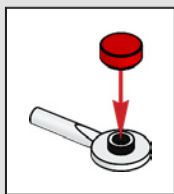
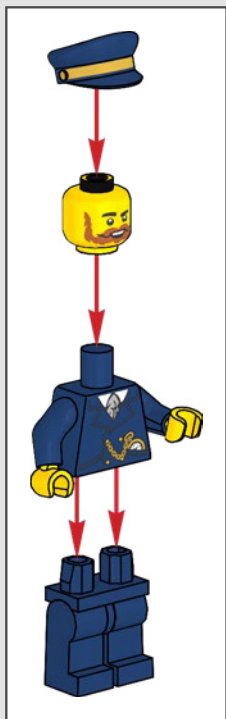

Fermata successiva: BELGRADO

"Il capostazione controlla che ogni carrozza del treno sia agganciata correttamente".

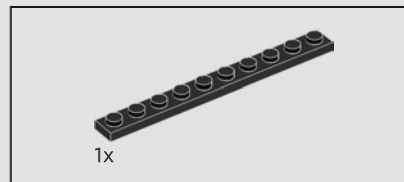
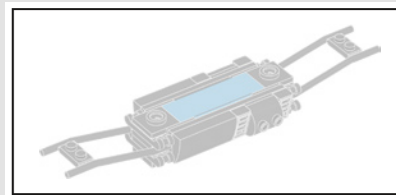

268

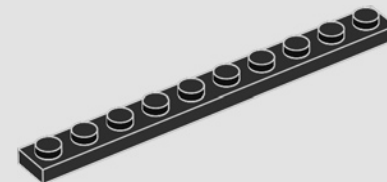



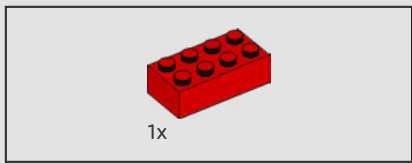

269

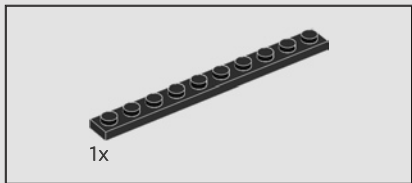
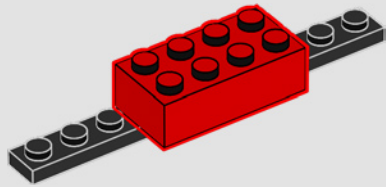

270

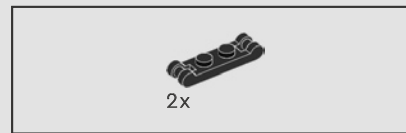
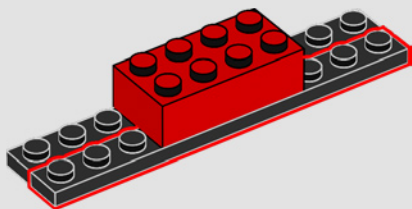

271

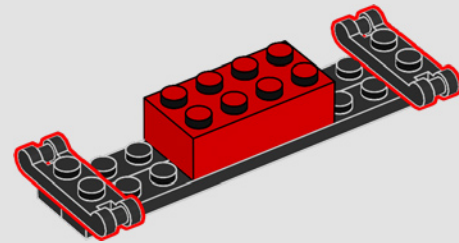

272

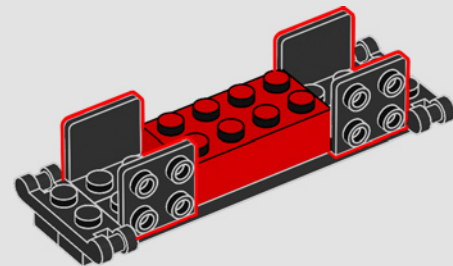

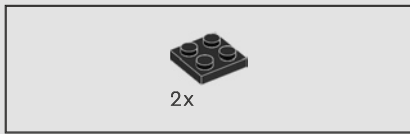

273

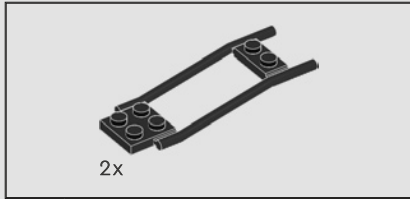
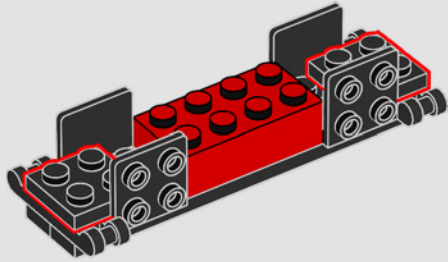

274

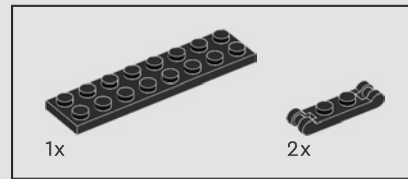
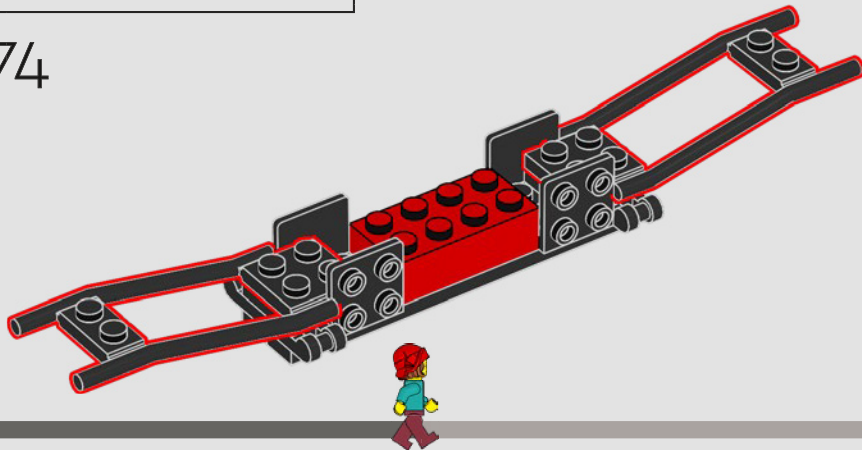

275

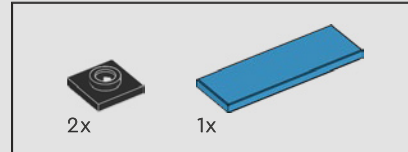
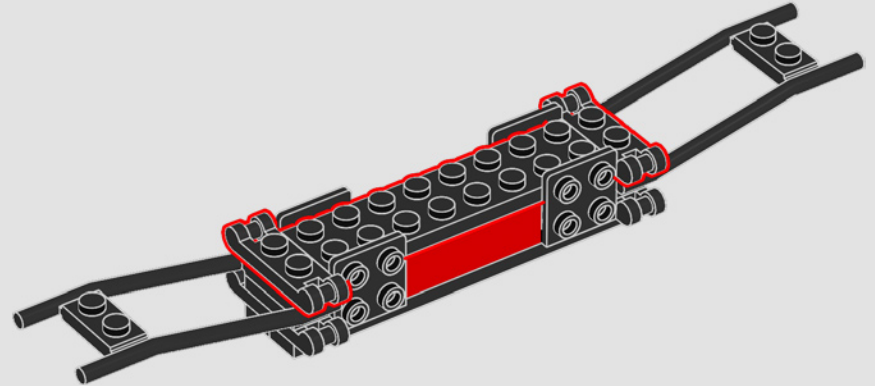

276

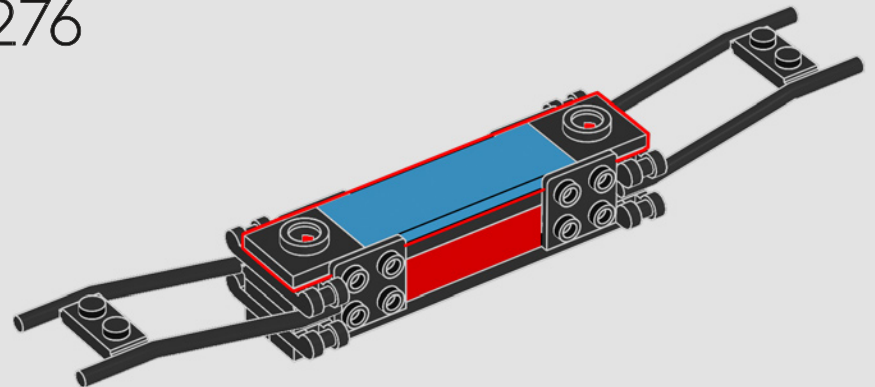

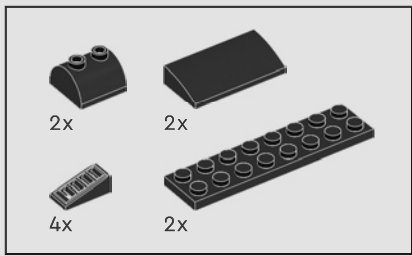

277

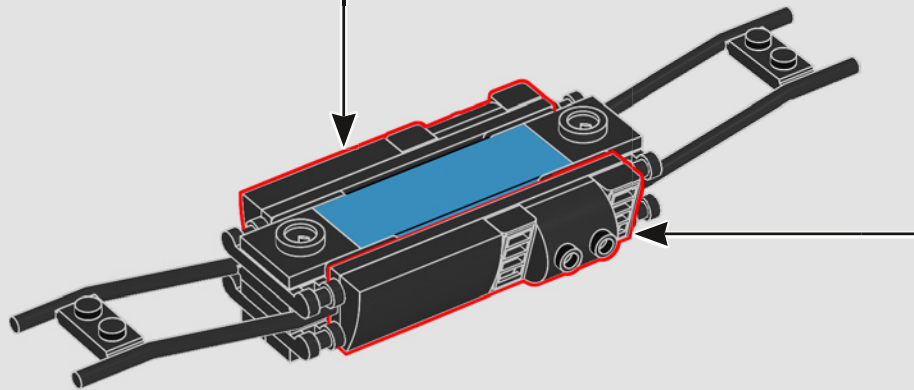
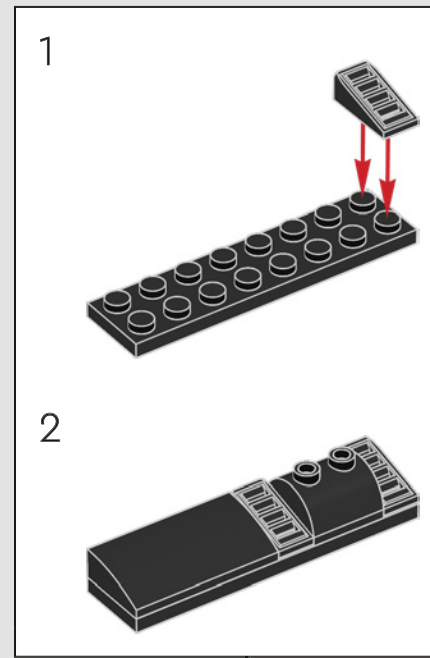
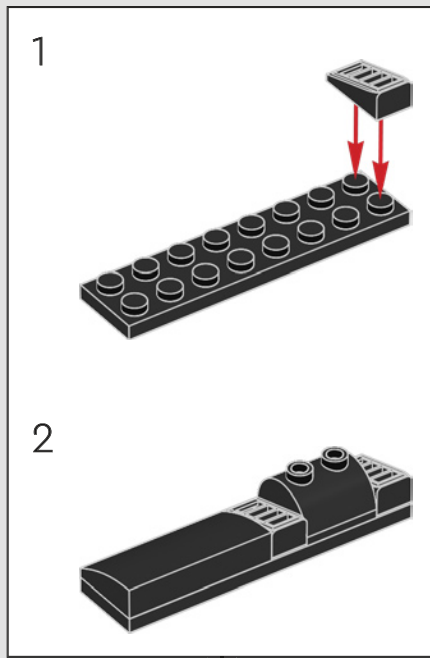



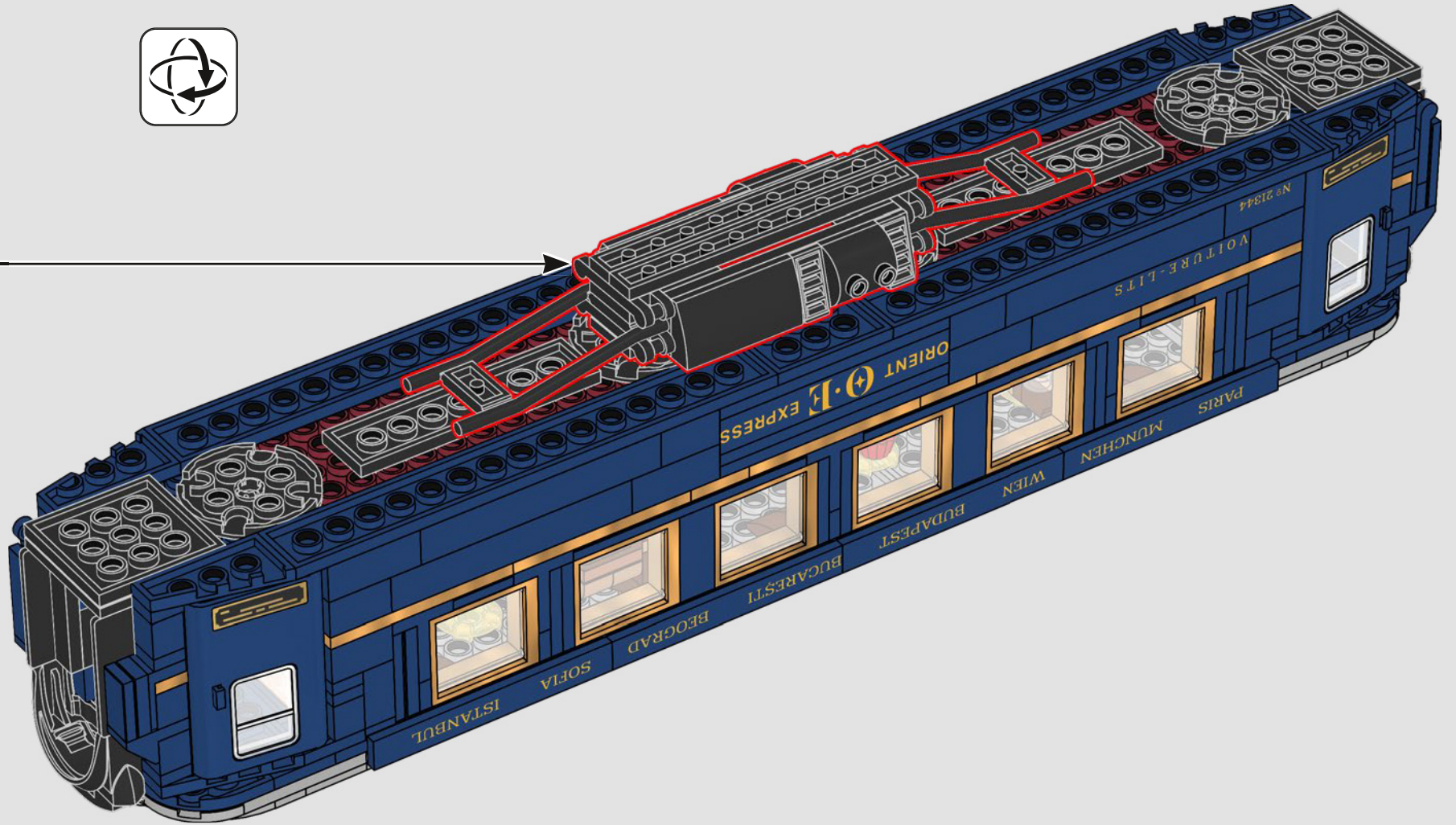

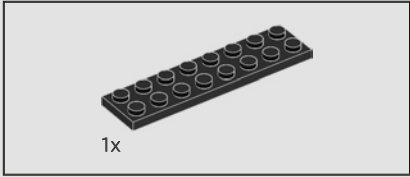
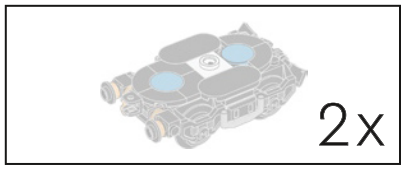

279

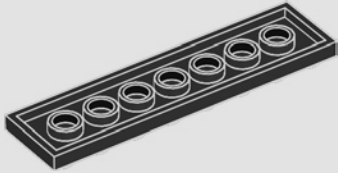

280

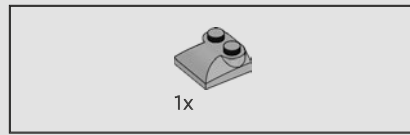
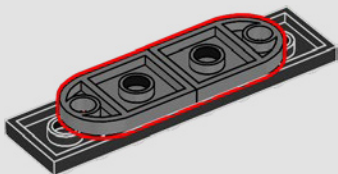

281

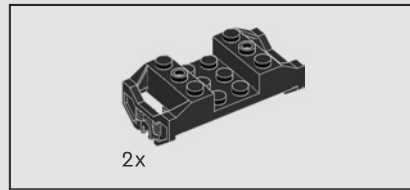
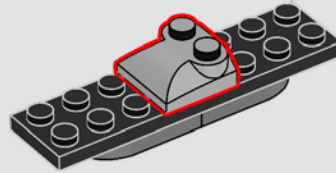

282

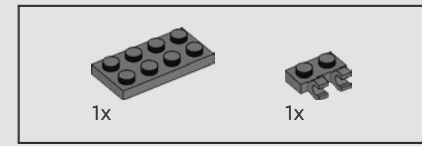
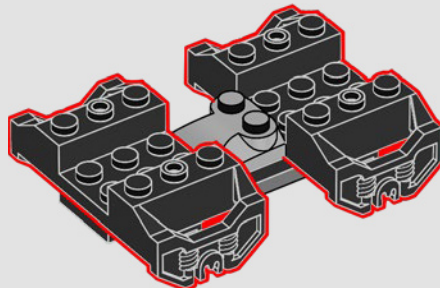

283

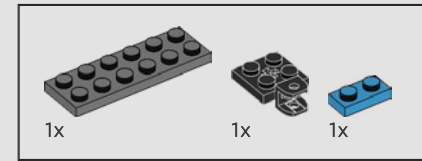
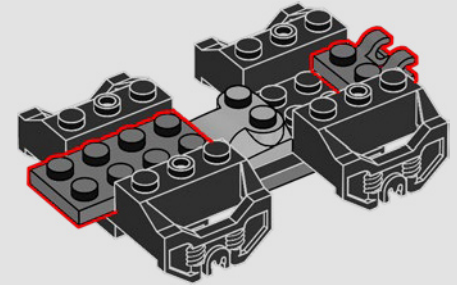

284

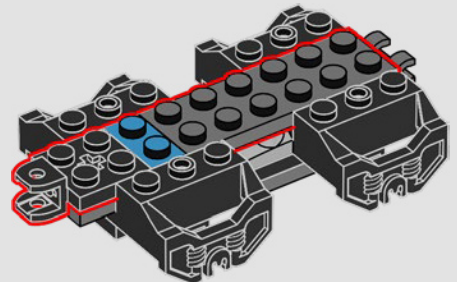

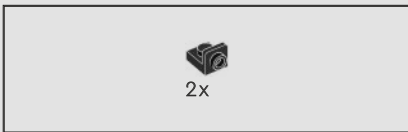

285

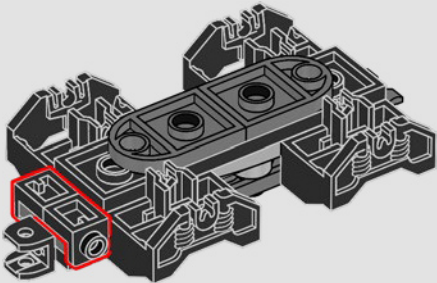

286

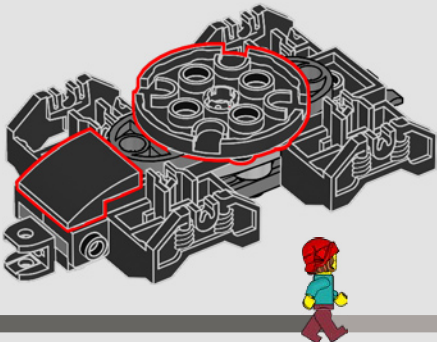

287

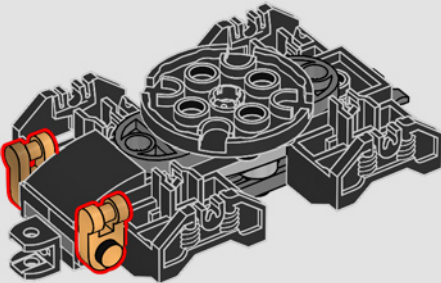

288

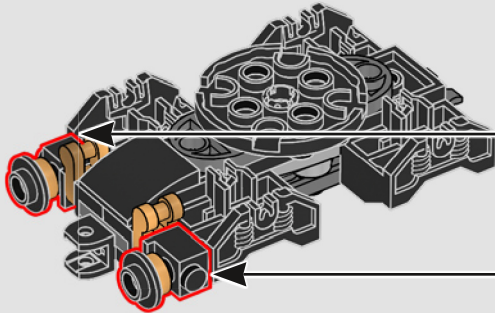
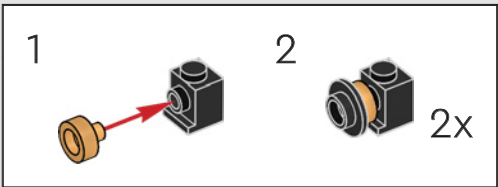

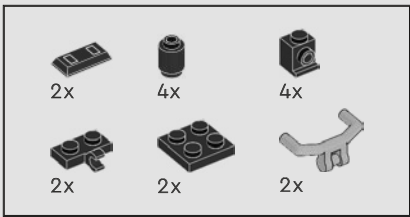

289

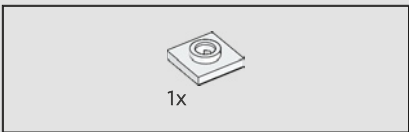
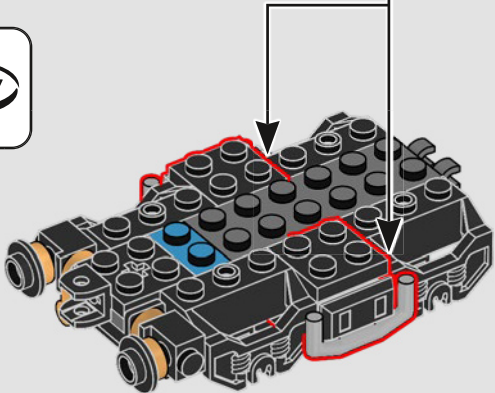
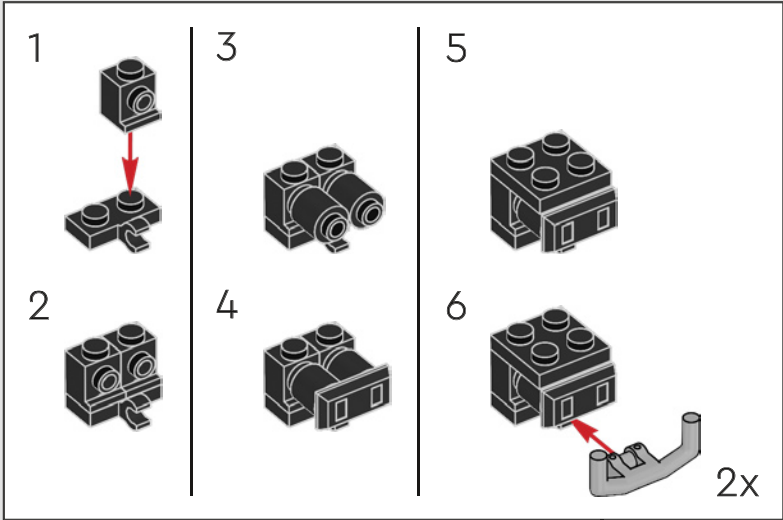

290

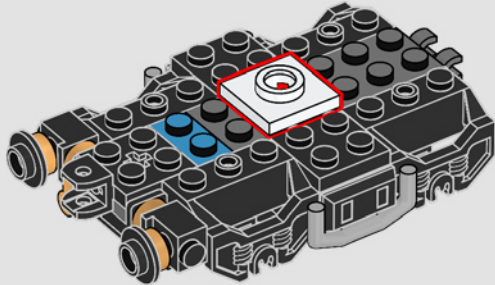

291

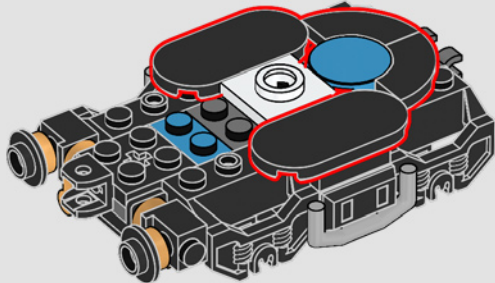



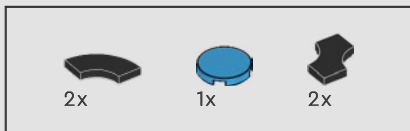

292

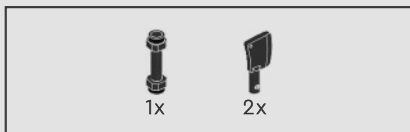
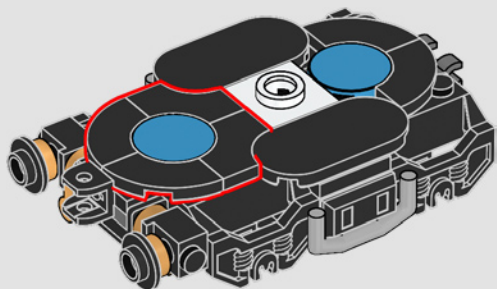

293

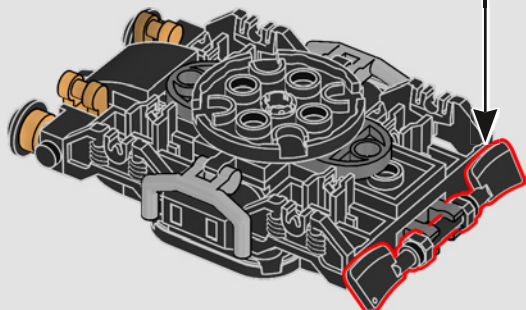
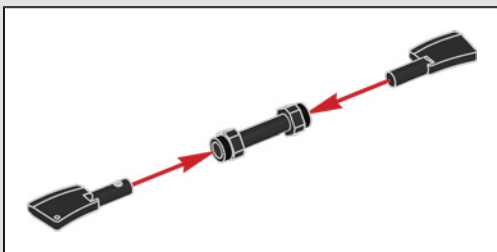

294

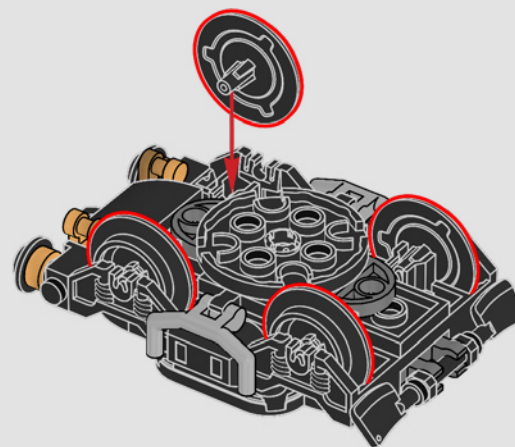

2x

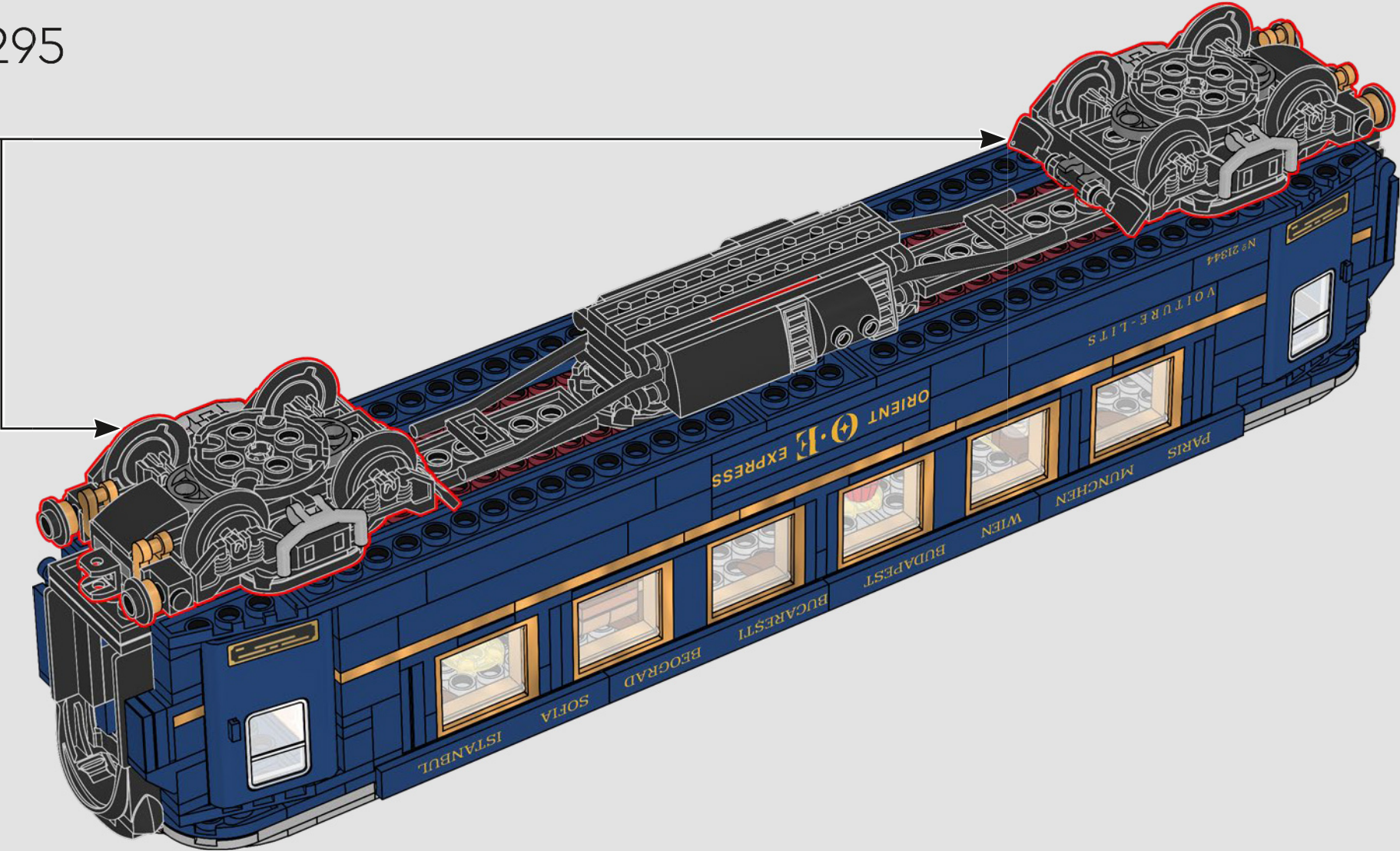





296

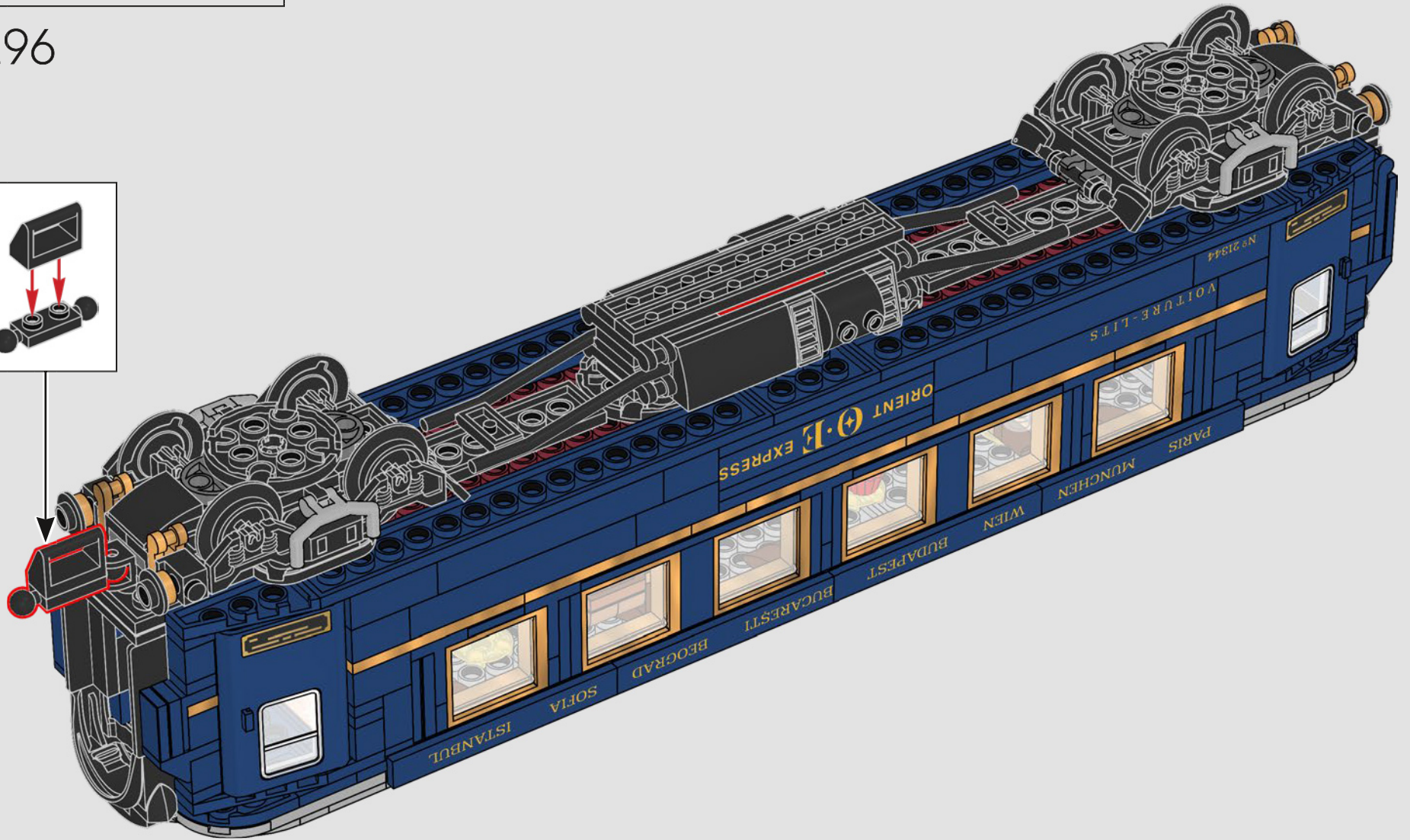
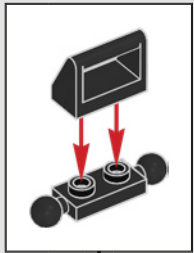

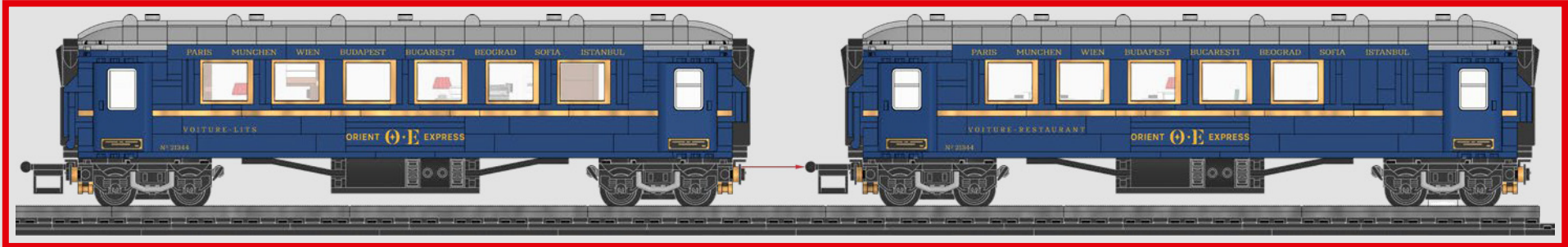
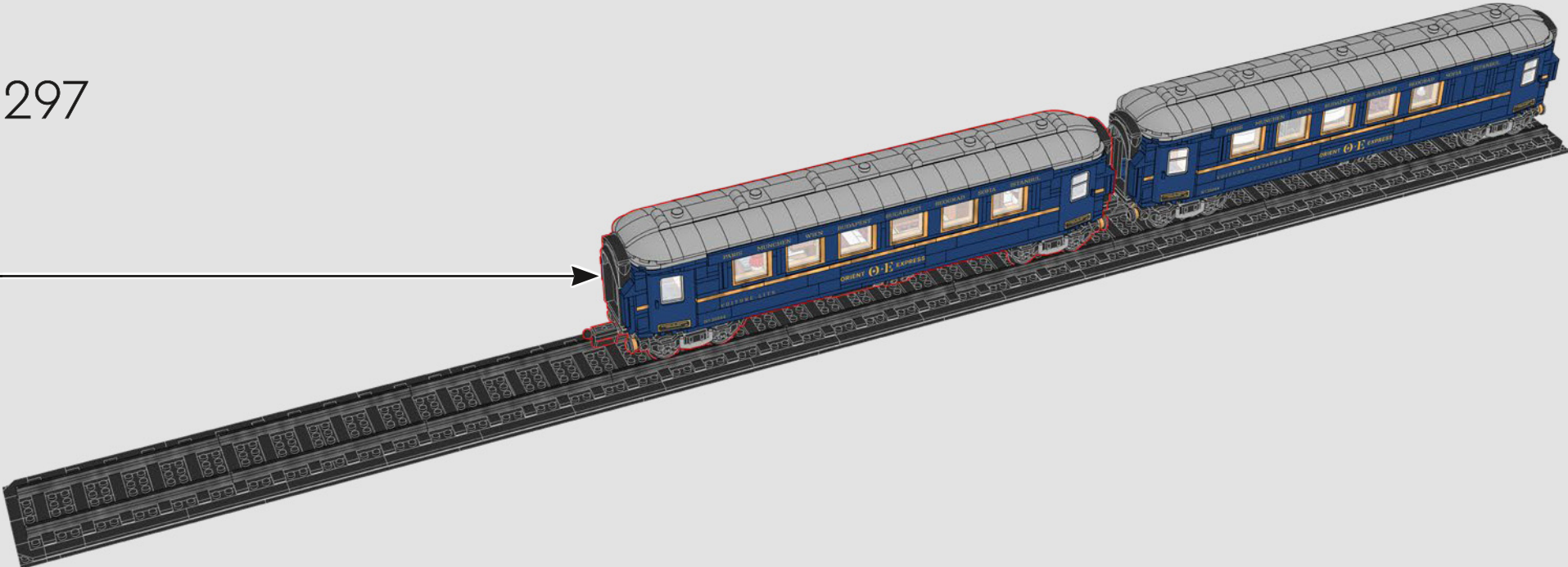



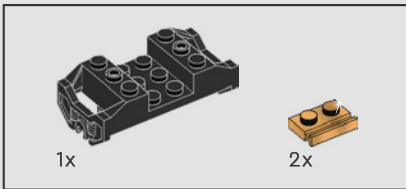
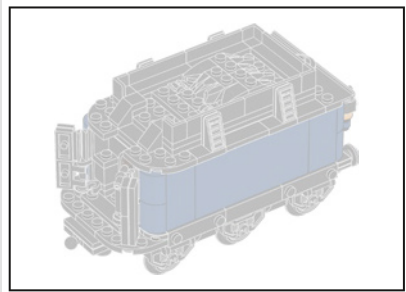

298

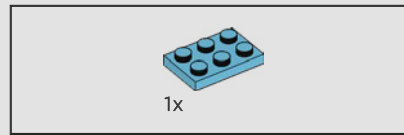
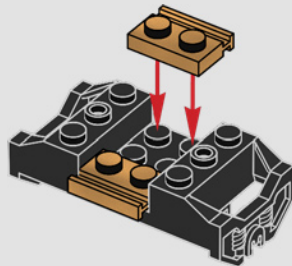

299

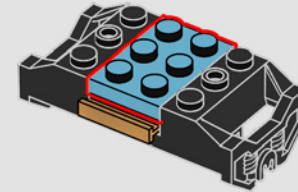

300

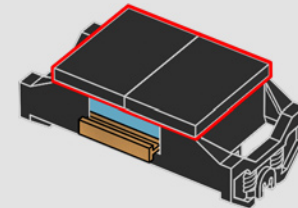

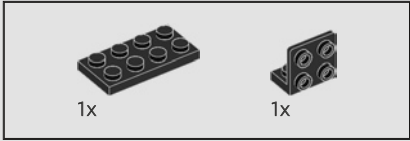
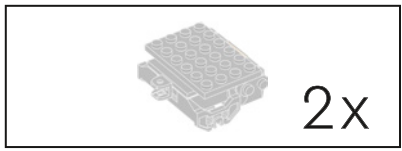

301

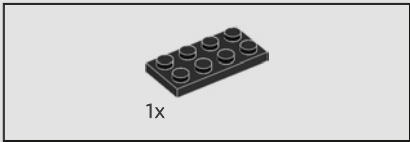
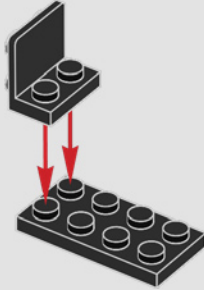

302

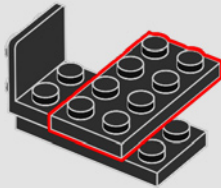

303

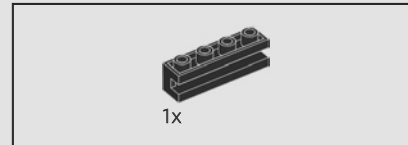
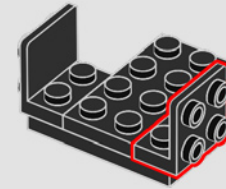

304

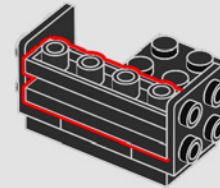



305

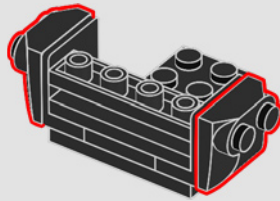

306

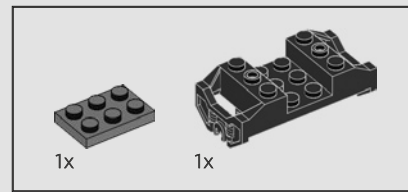
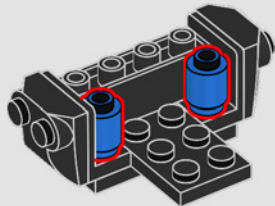

307

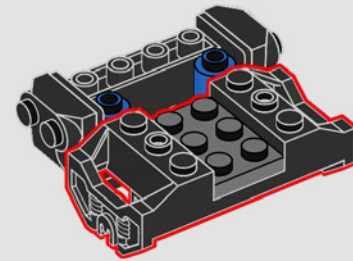
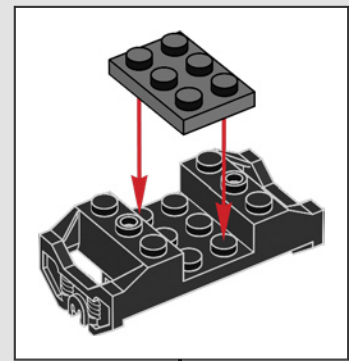

308

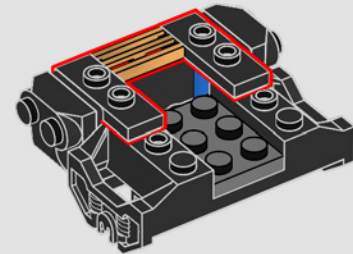



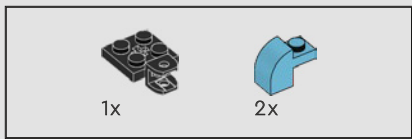

309

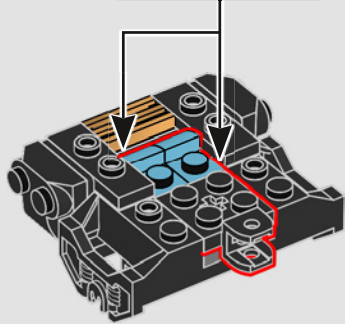
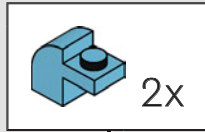

310

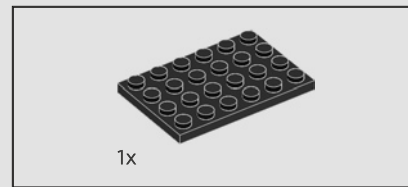
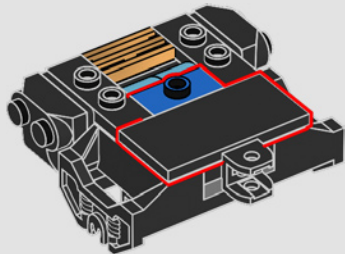

311

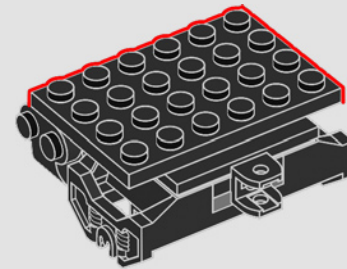

2x

312

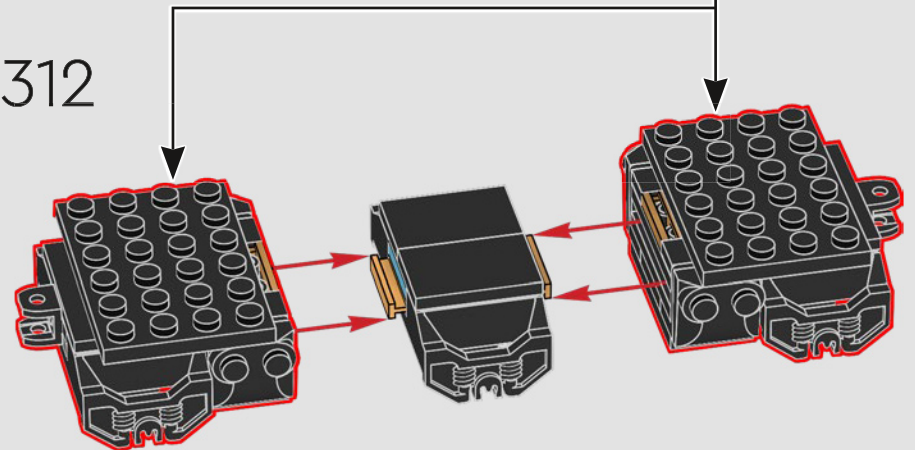

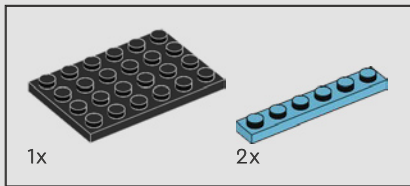

313

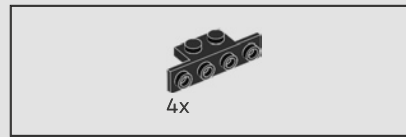
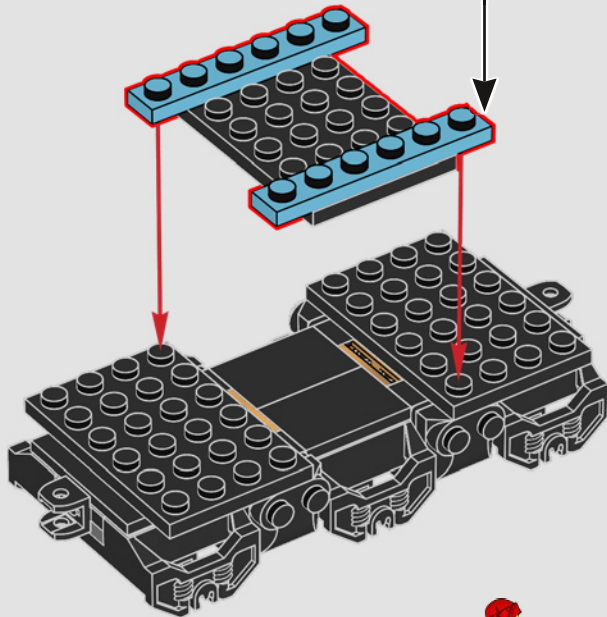
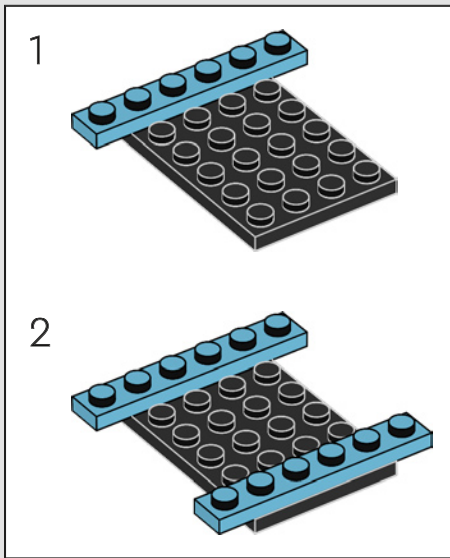

314

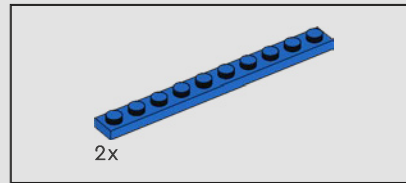
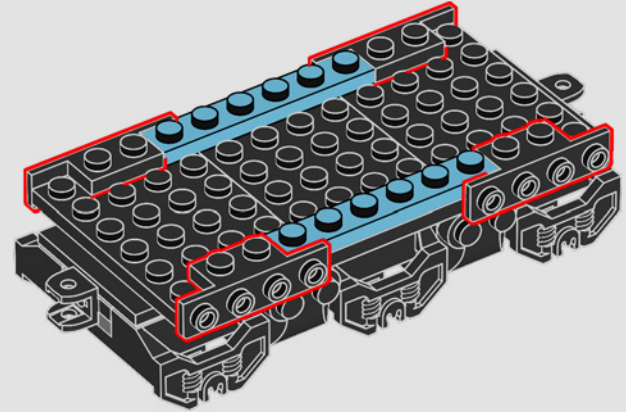

315

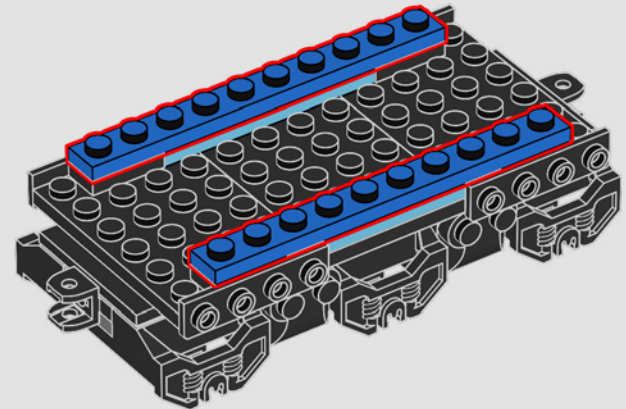

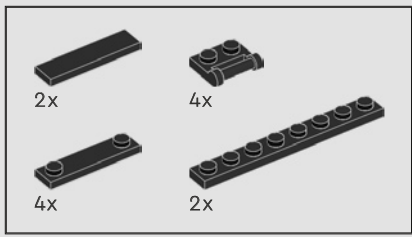

316

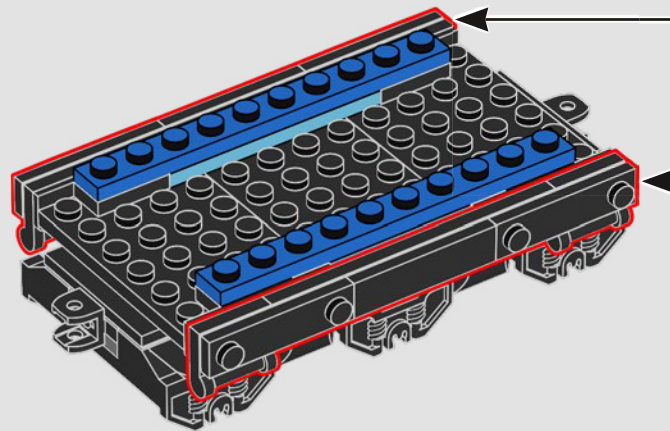
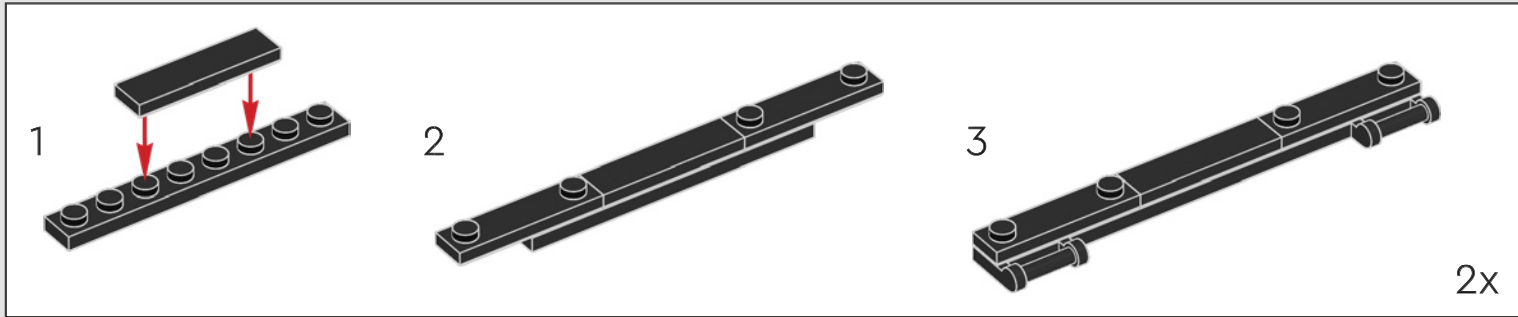



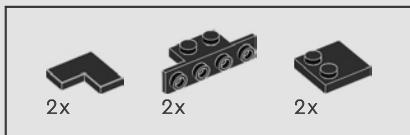

317

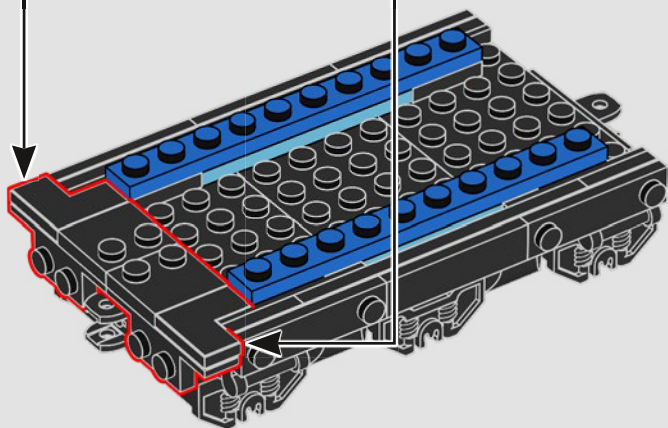
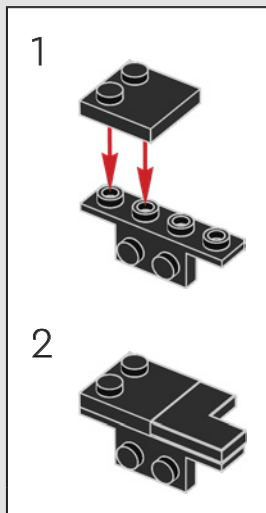
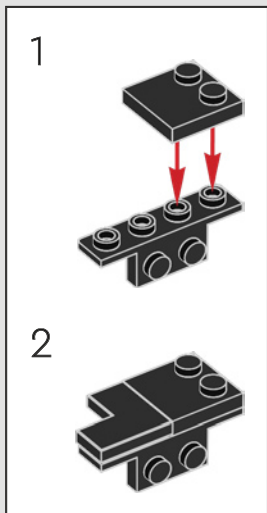

318

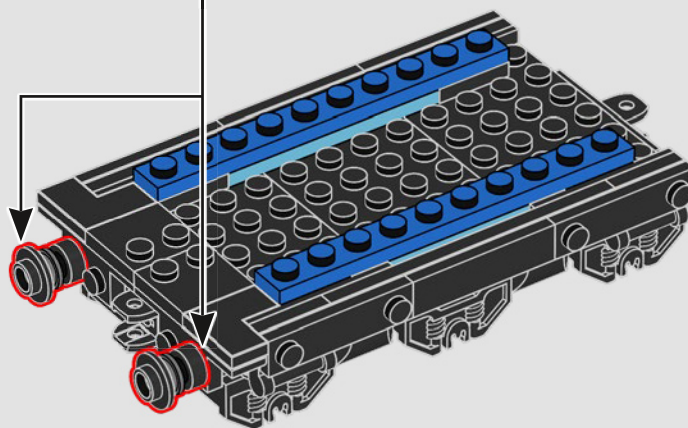
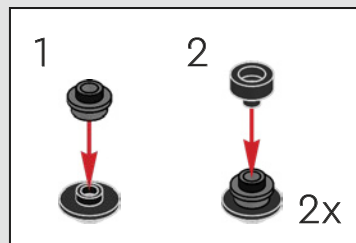

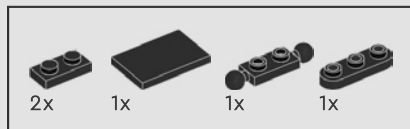

319

..... ●  
"Il vapore continua a fuoriuscire dal locomotore.  
Il tender del carbone deve essere davvero grande  
per alimentare una locomotiva di questo tipo".

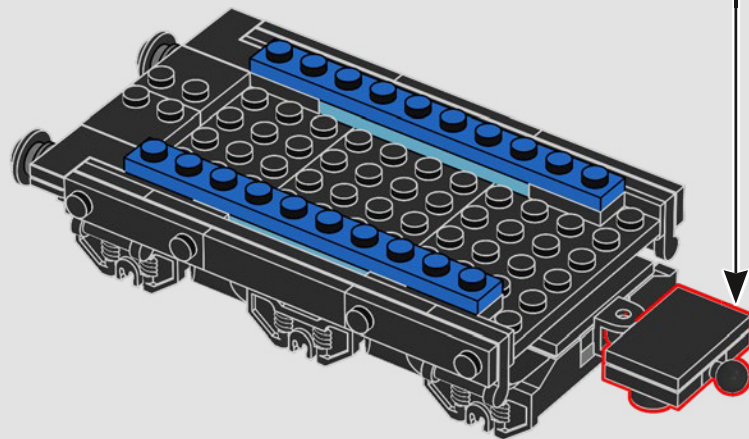
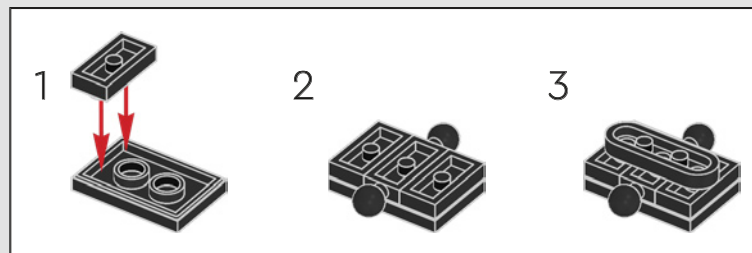

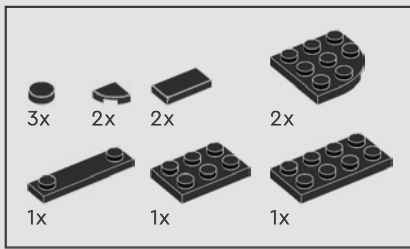

320

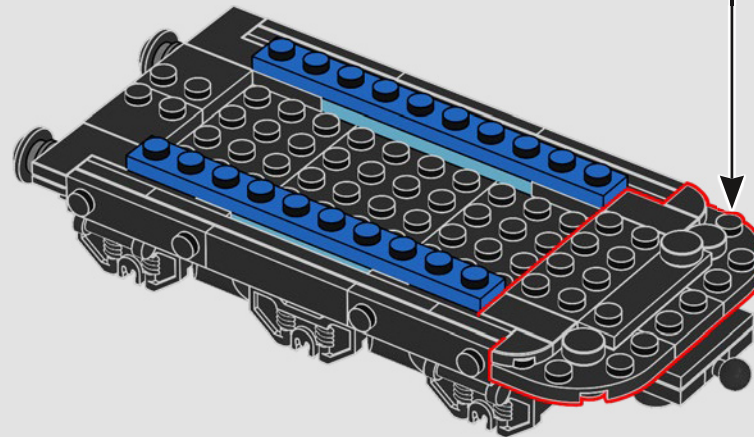
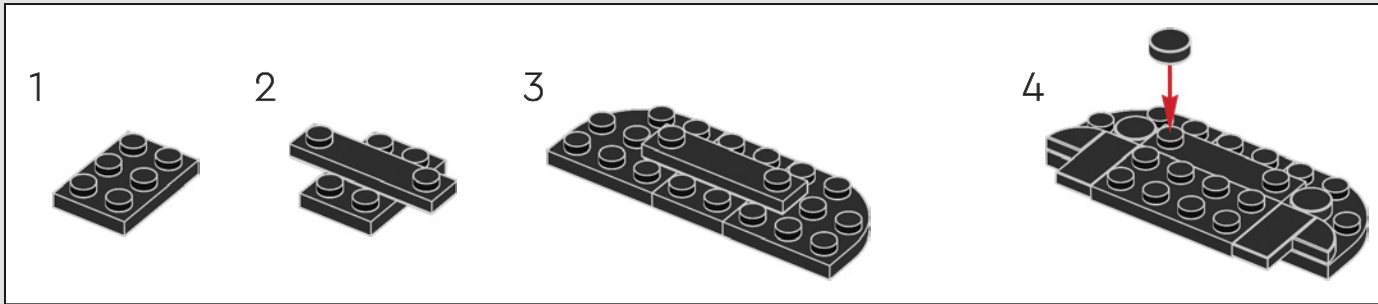



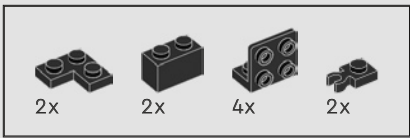

321

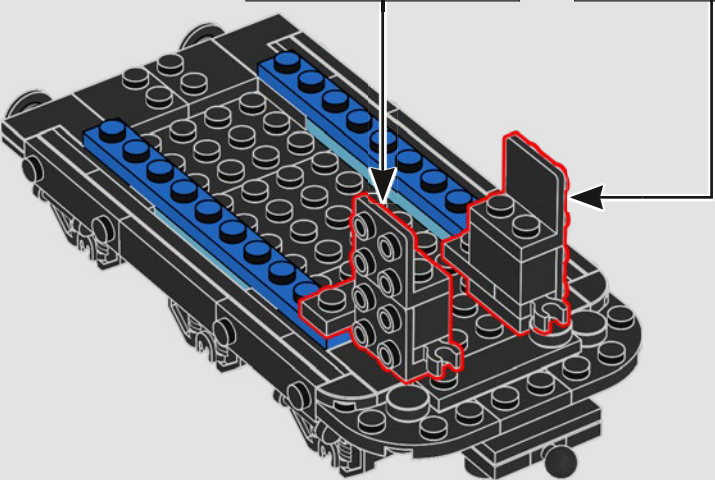
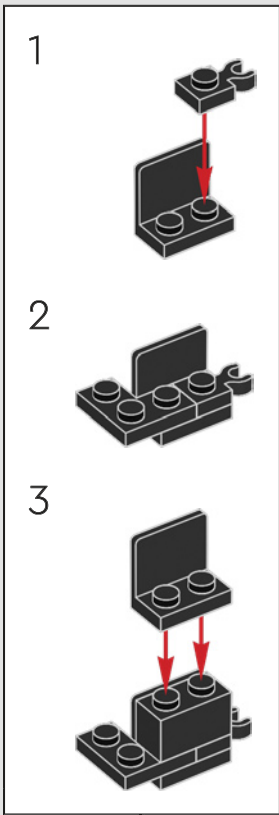
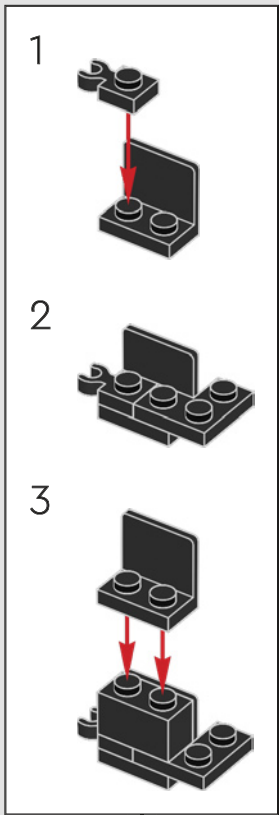



322

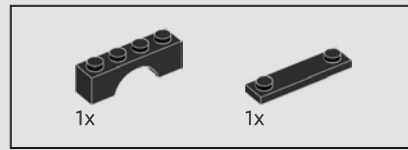
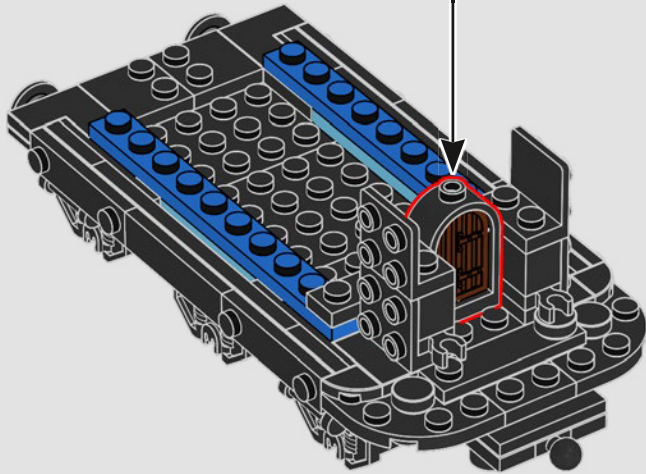
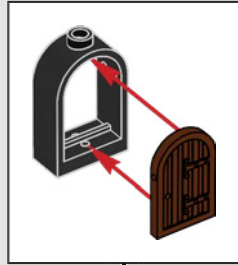

323

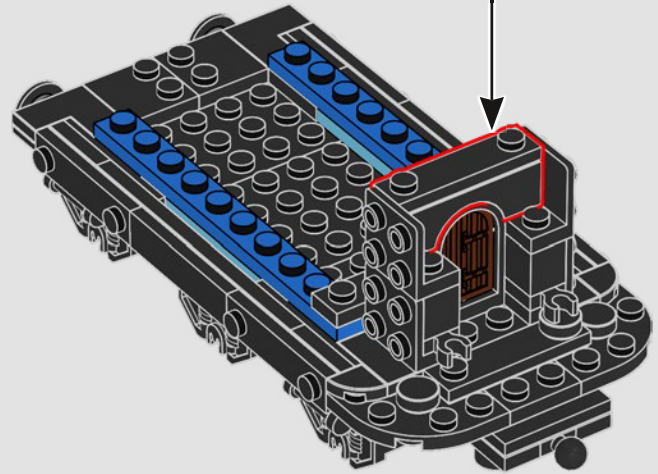
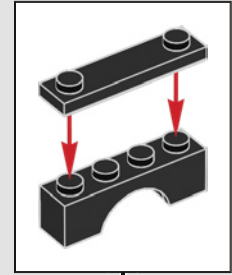

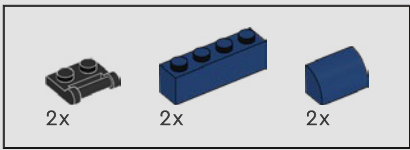

324

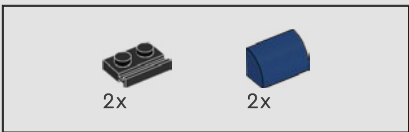
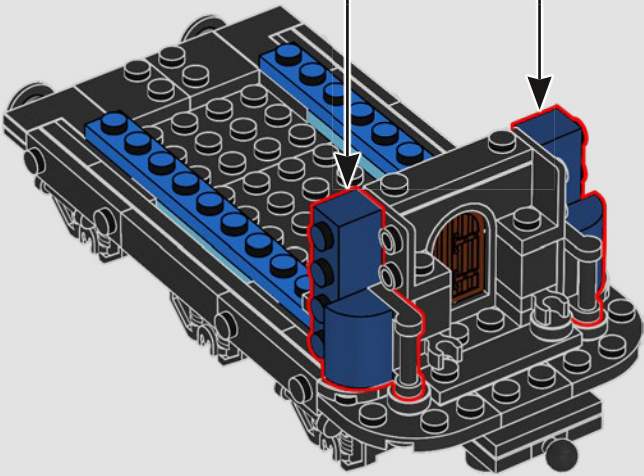
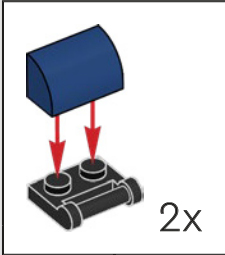

325

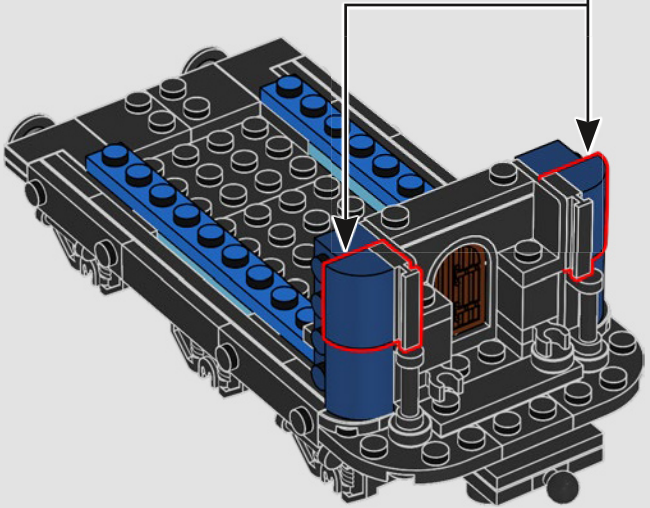
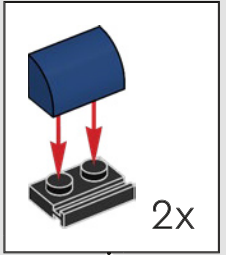



326

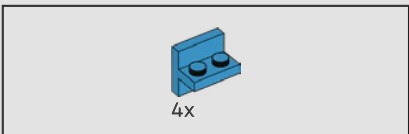
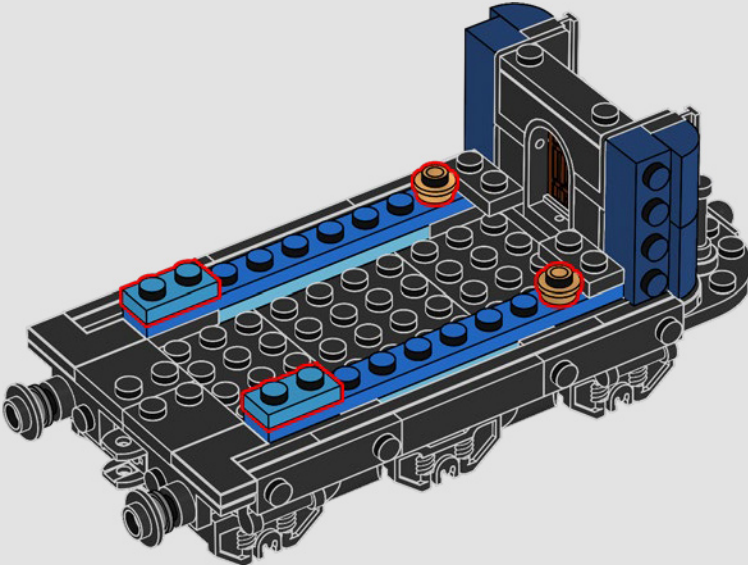

327

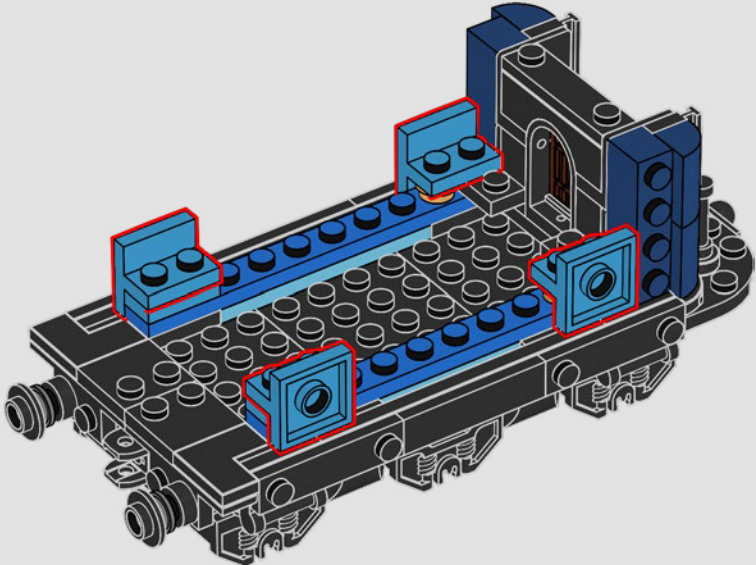





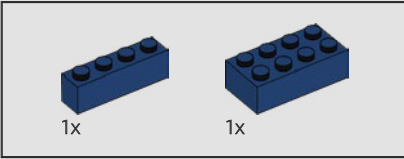
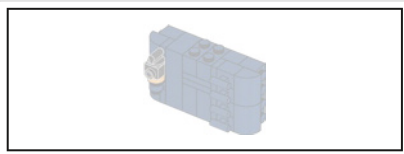

330

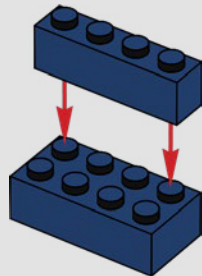

331

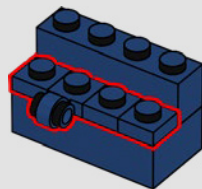

2x

332

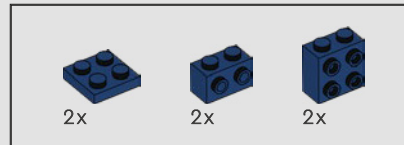
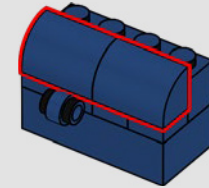

2x

2x

2x

333

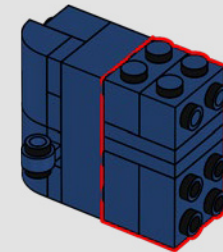
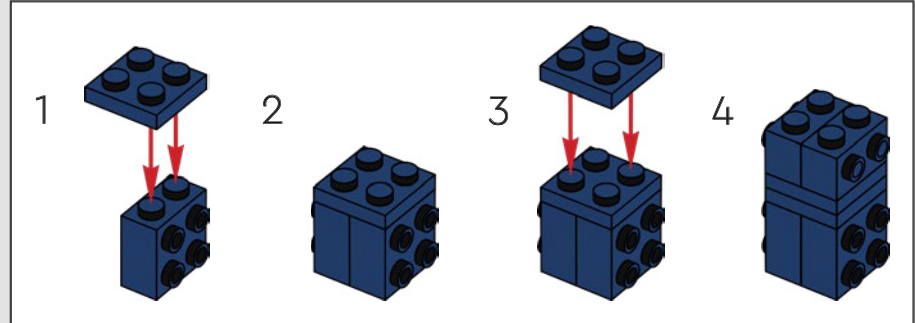

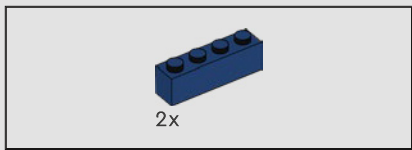

334

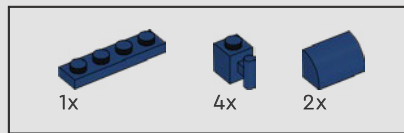
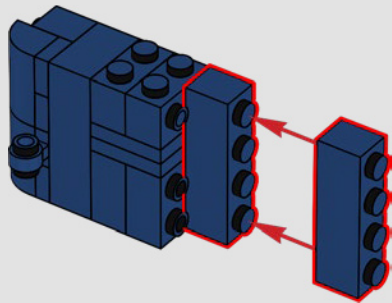

335

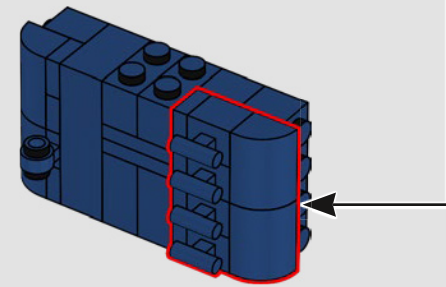
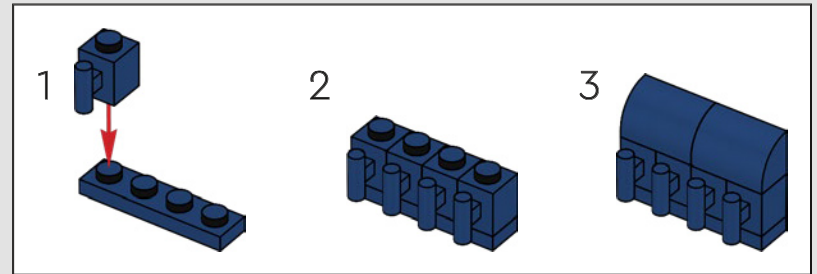

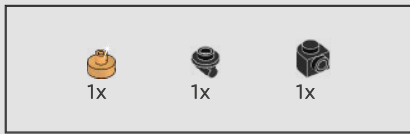

336

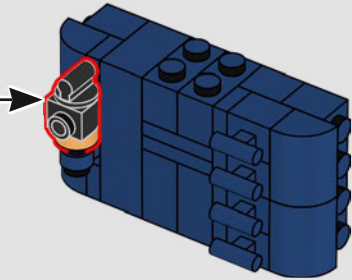
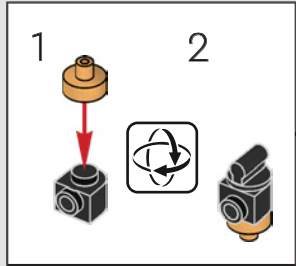

337

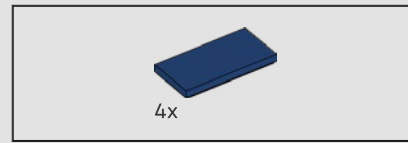
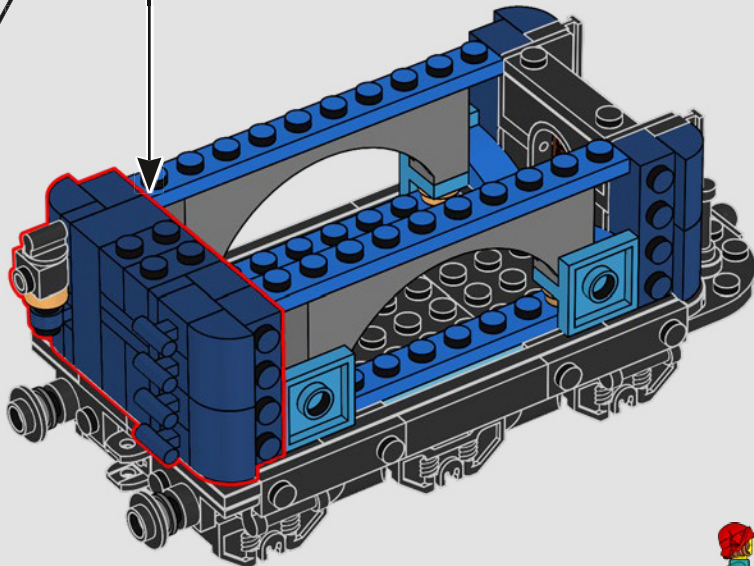

338

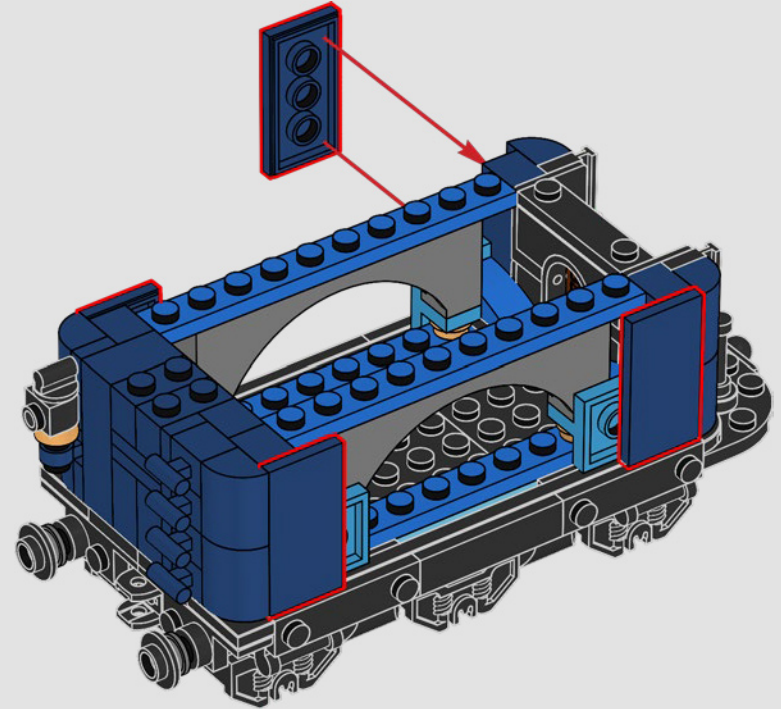



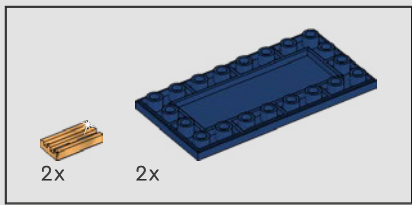

339

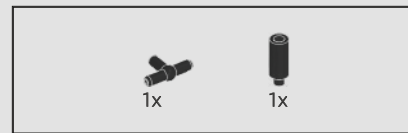
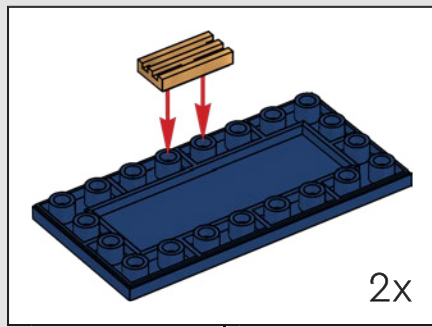

340

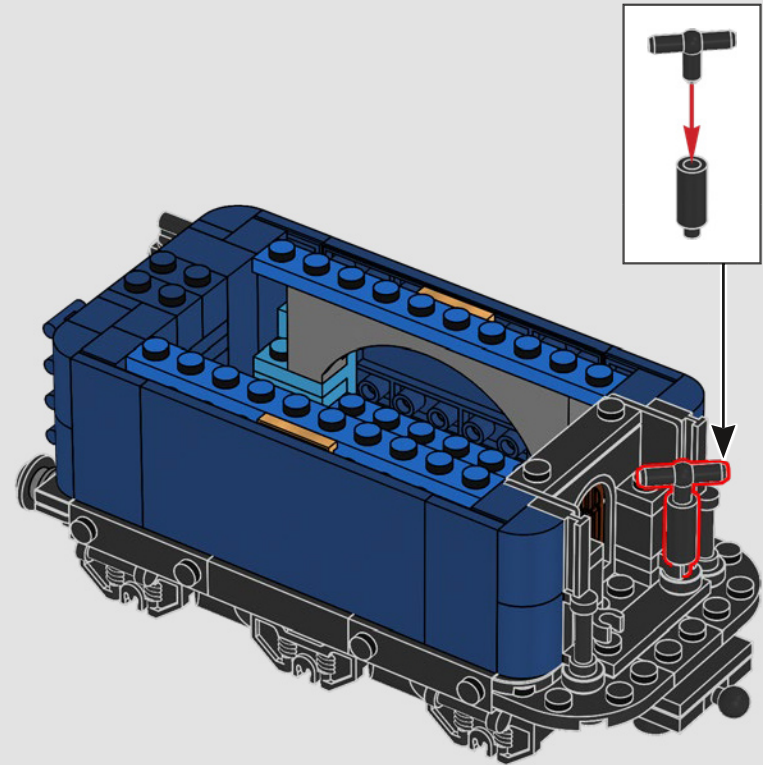
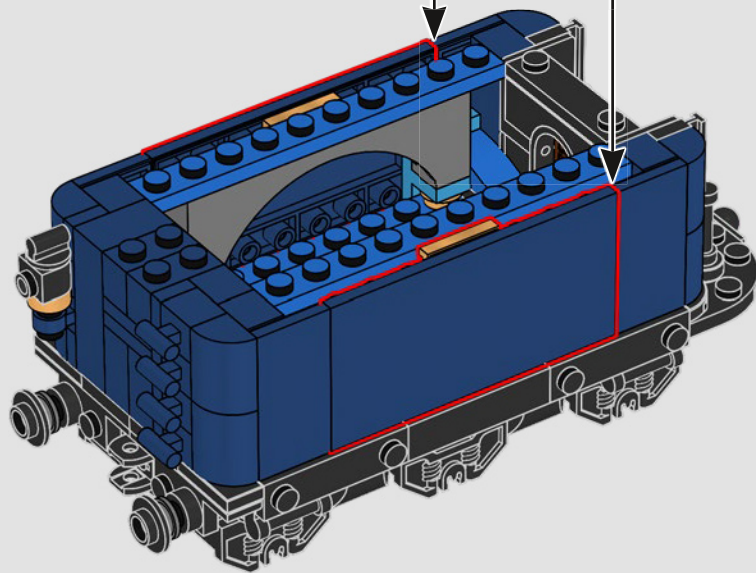

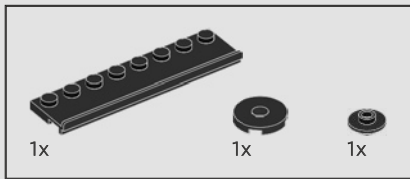

341

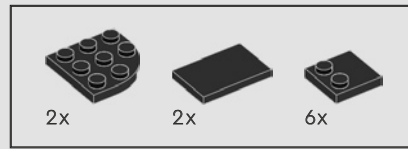
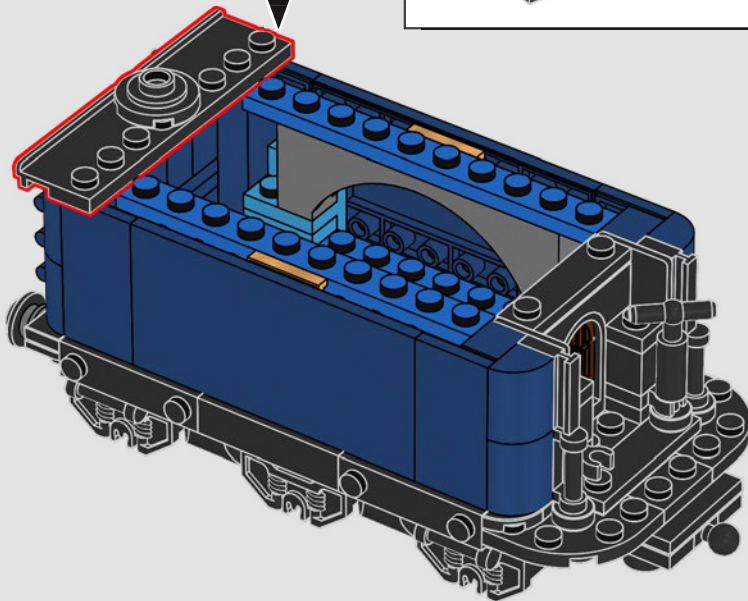
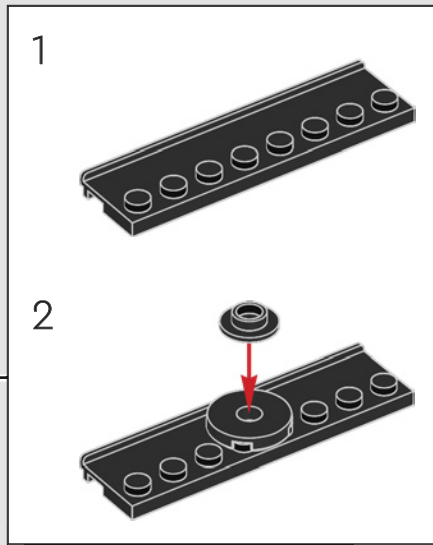

342

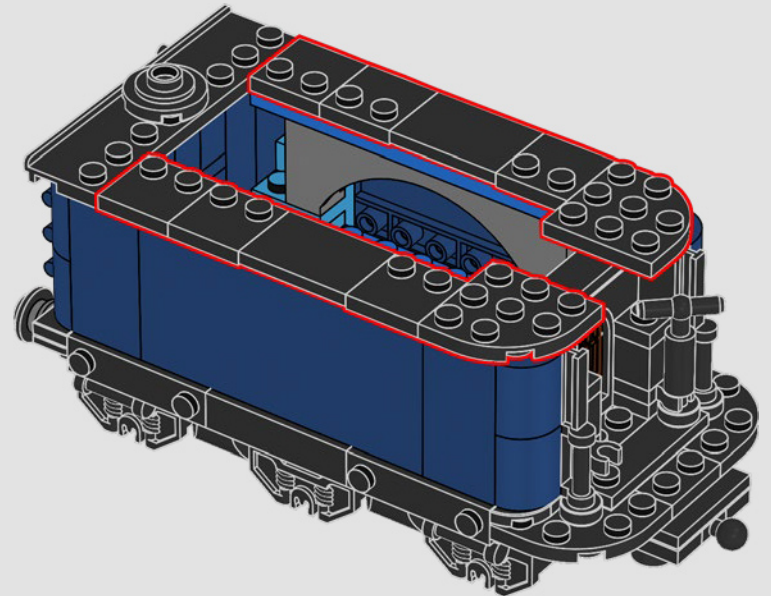

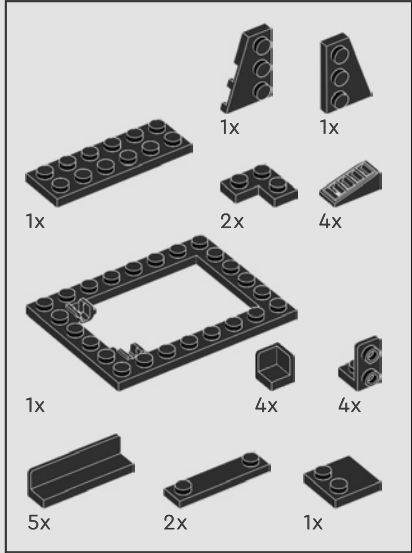
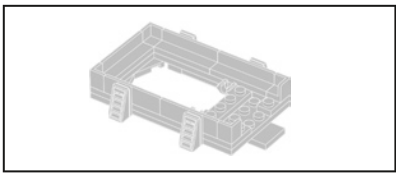

343

1

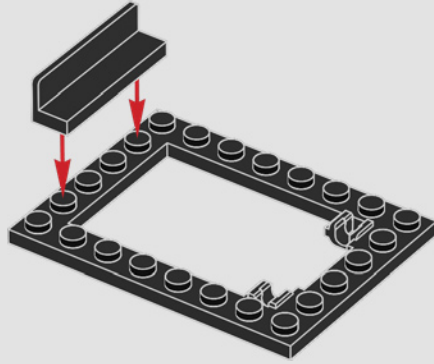

2

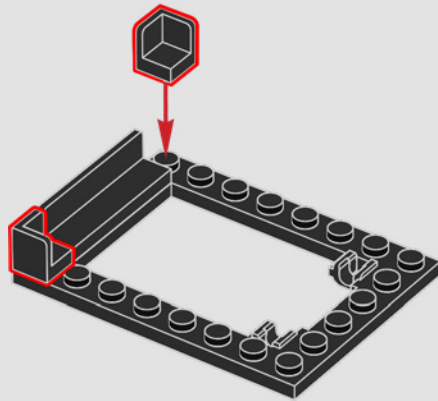

3

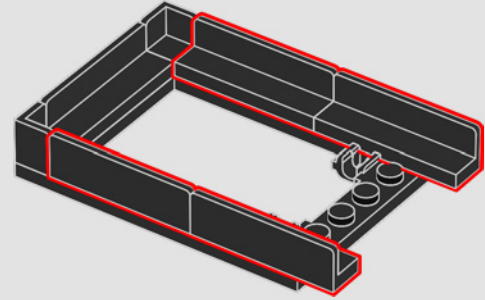

4

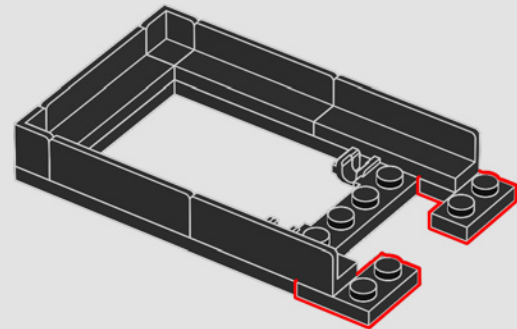

5

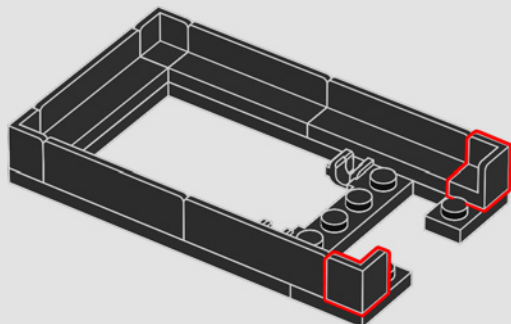

6

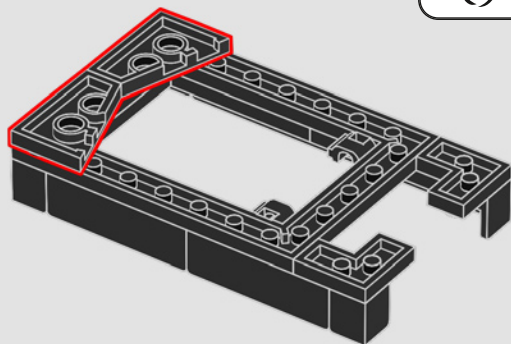

7

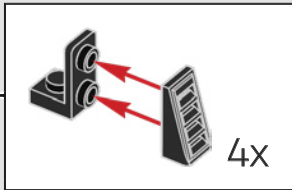
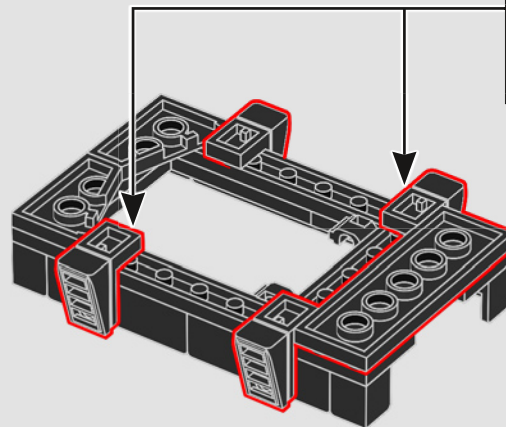

8

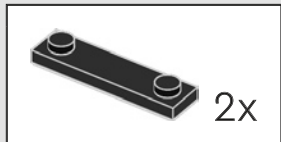
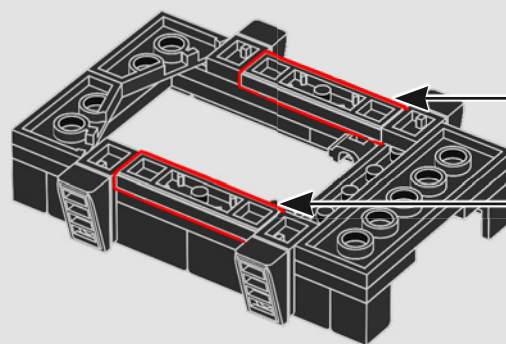





9

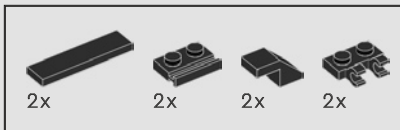
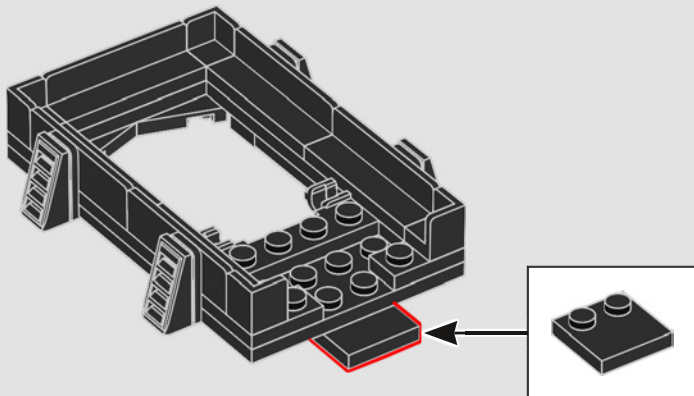

344

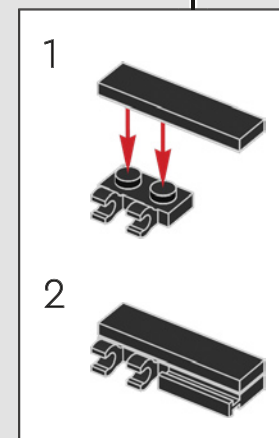
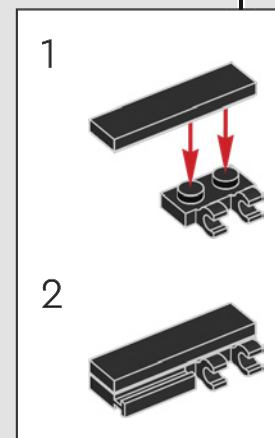
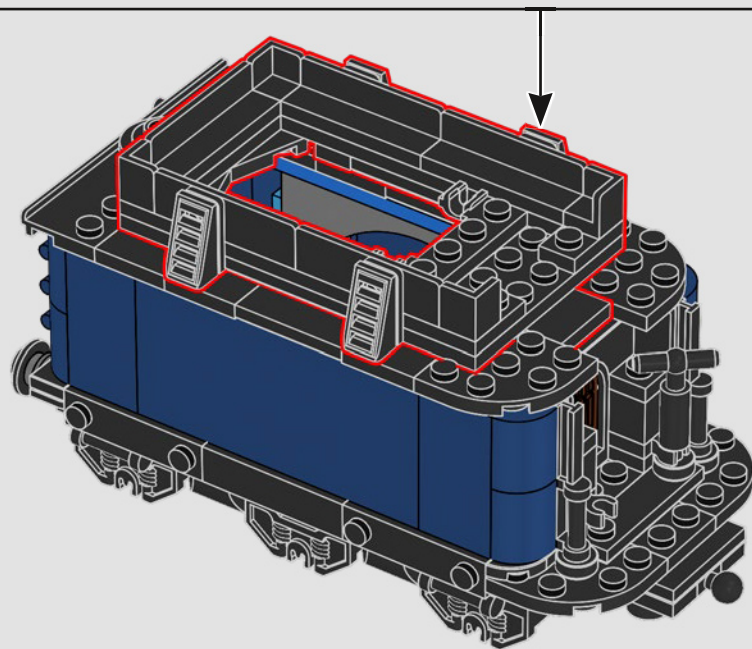
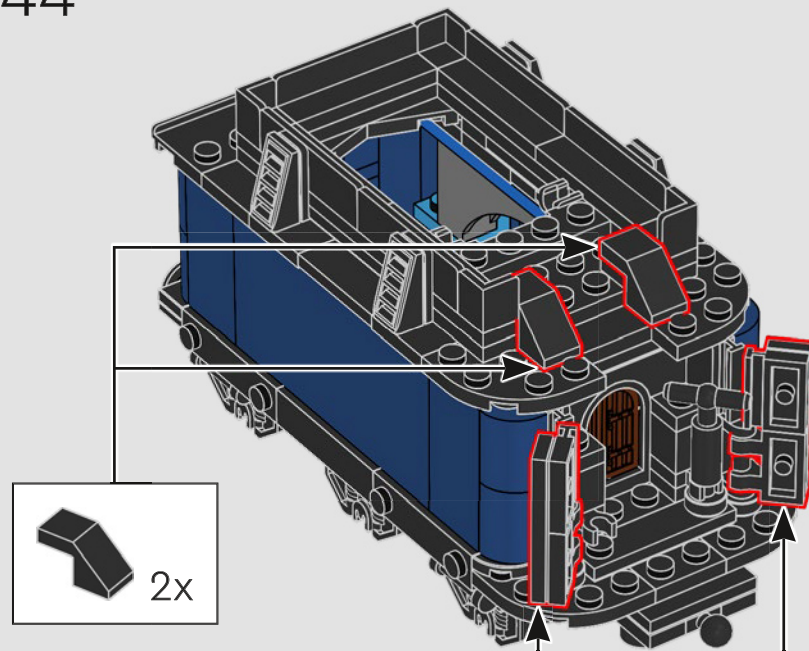



345

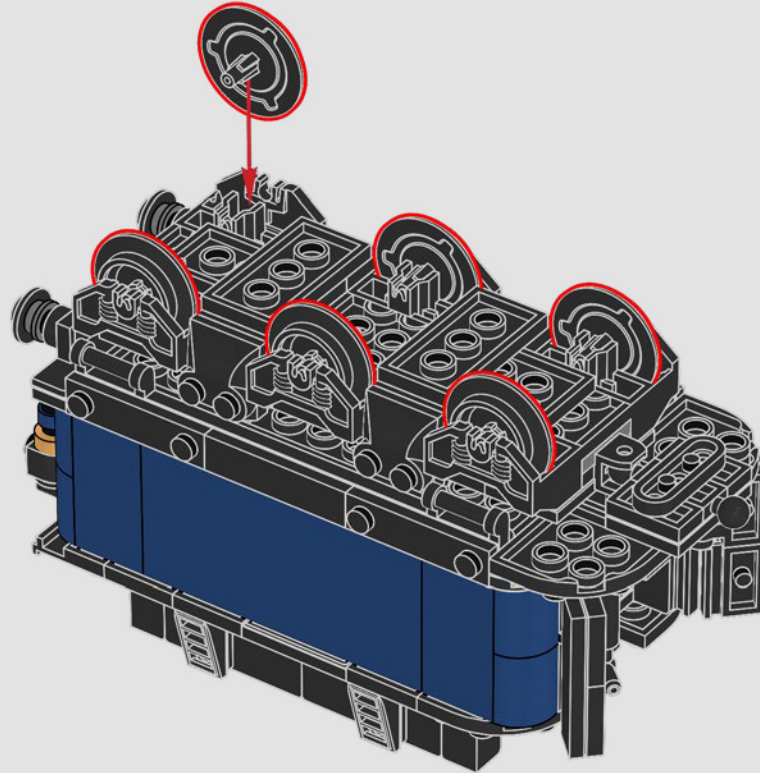

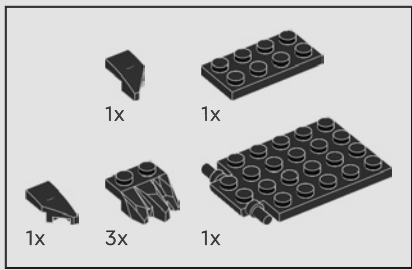

346

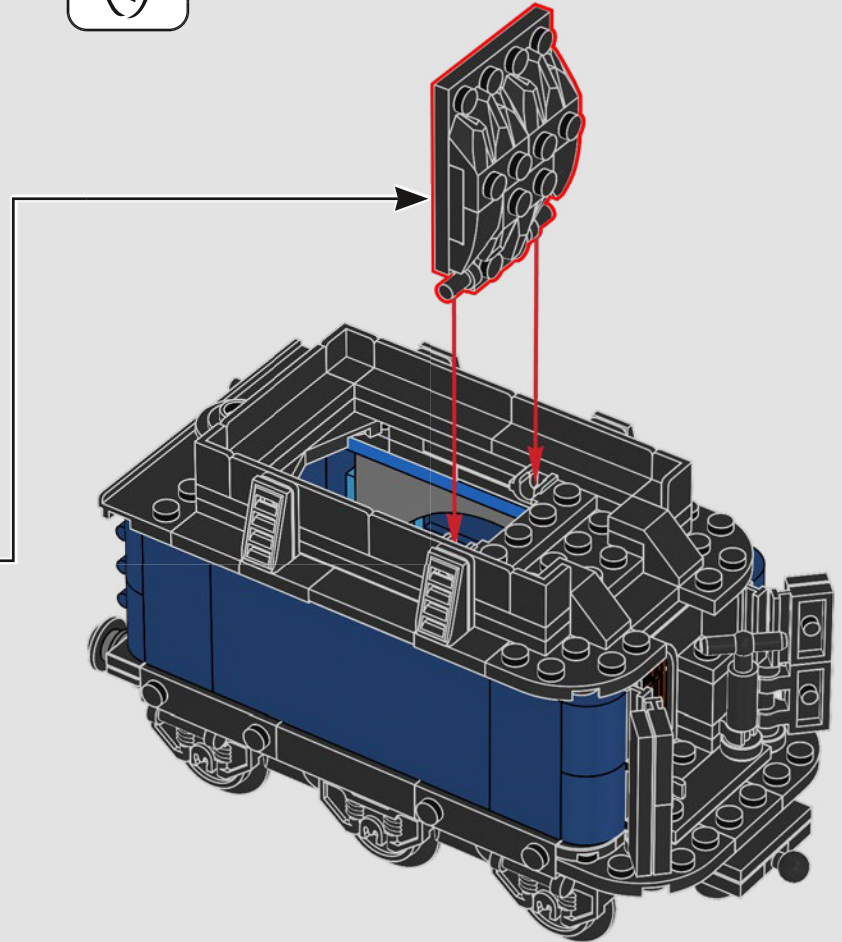
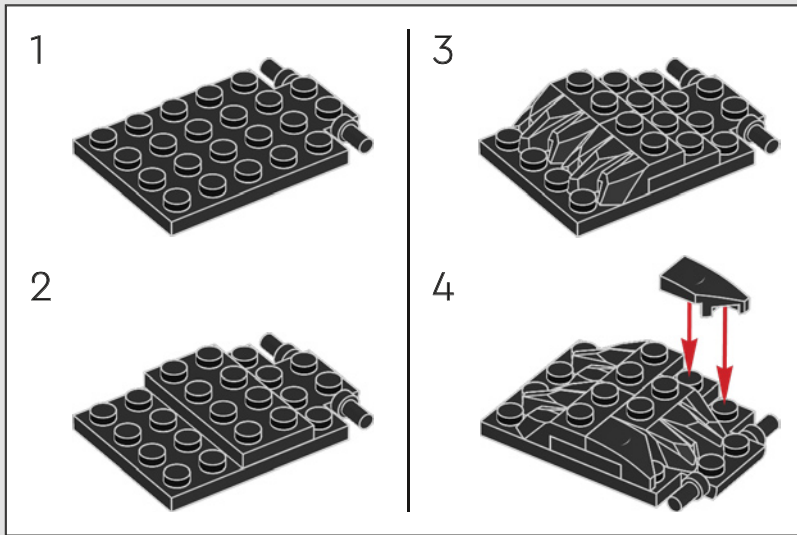

347





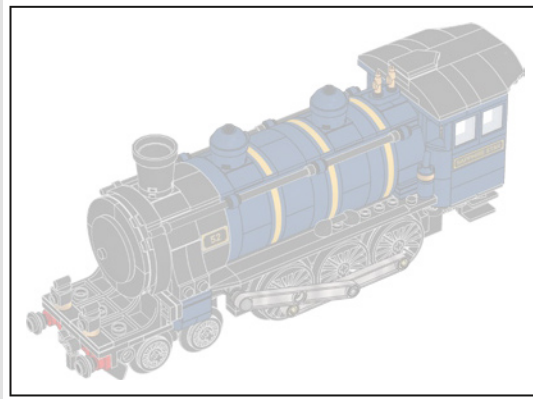
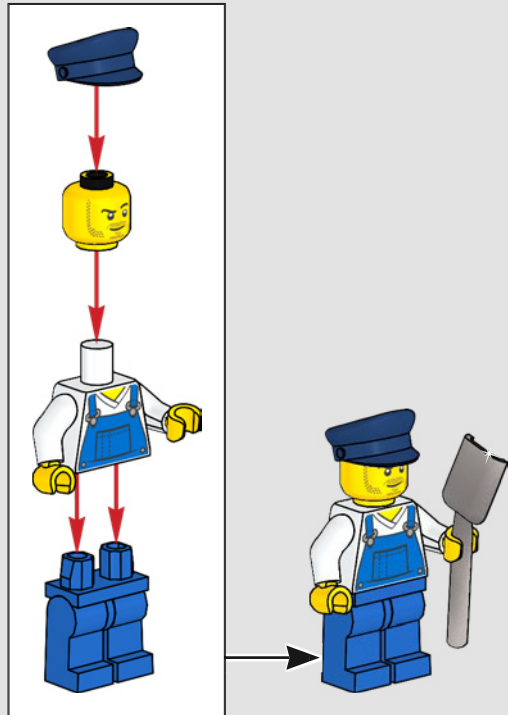

348

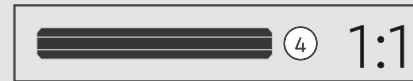
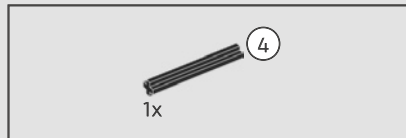

349

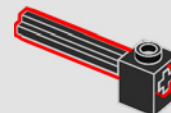

..... ●  
"Il macchinista controlla che le fiamme non si spengano e che la locomotiva abbia il carbone necessario per il lungo viaggio".



350

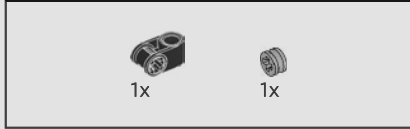
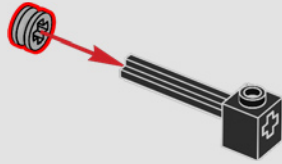

351

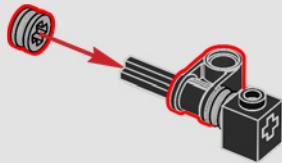

352

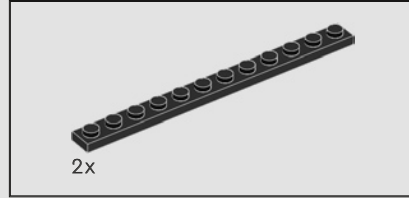
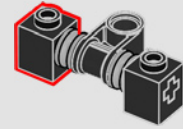

353

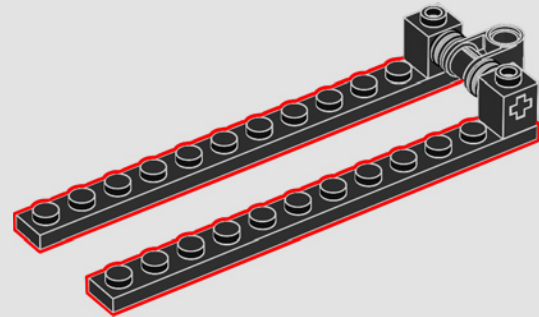

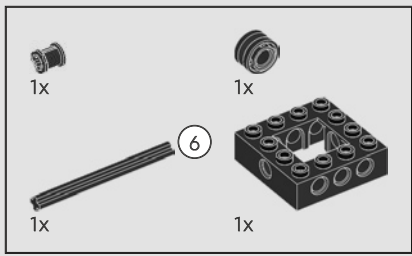

354

1

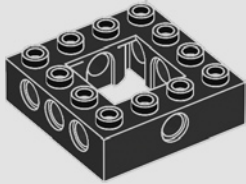

2

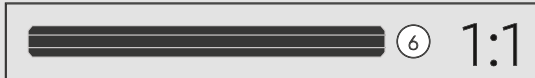
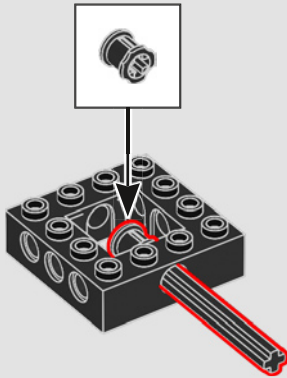

3

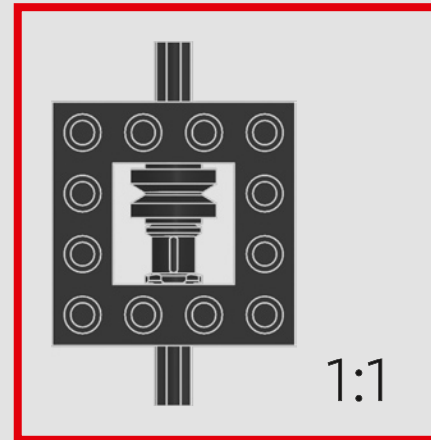
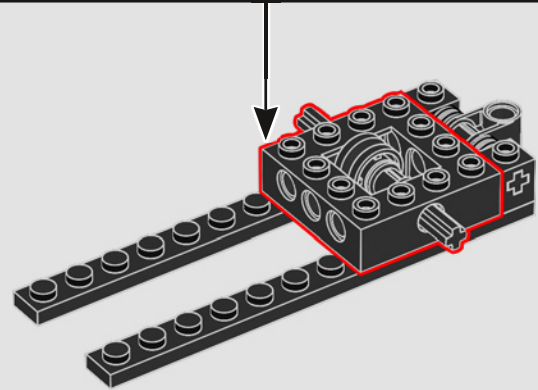
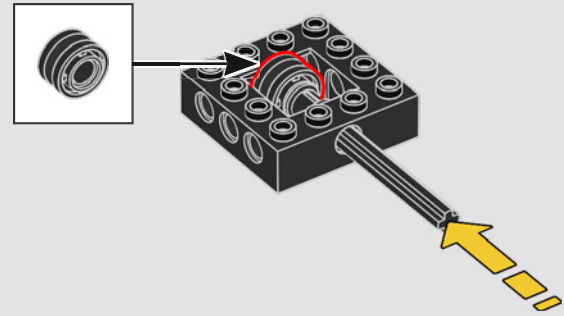

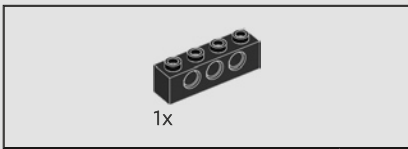

355

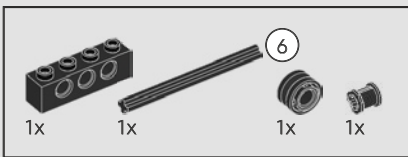
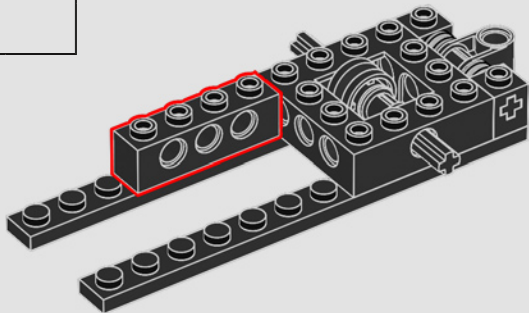

356

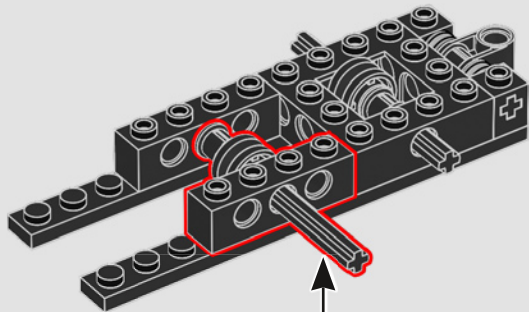
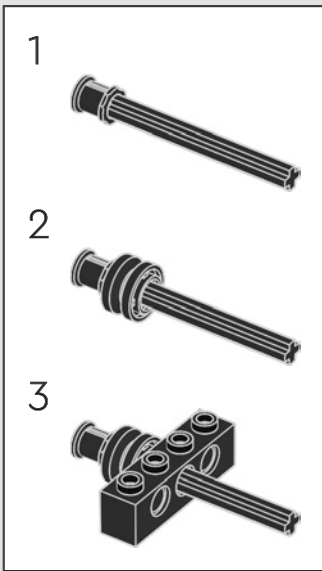

357

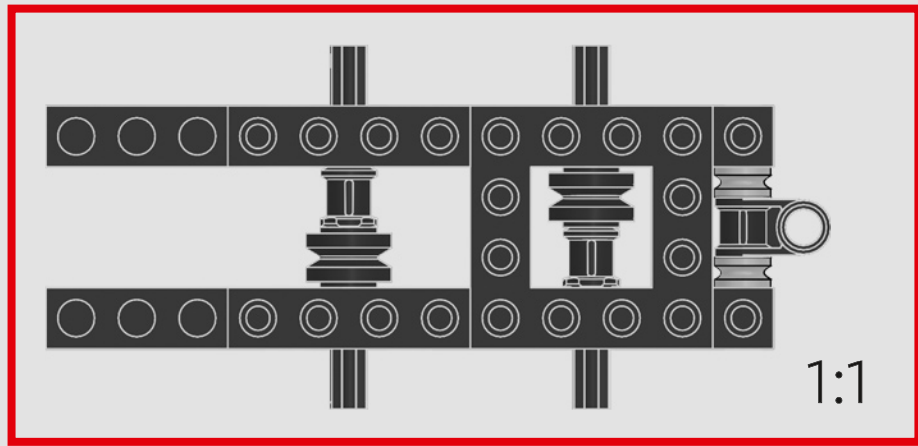
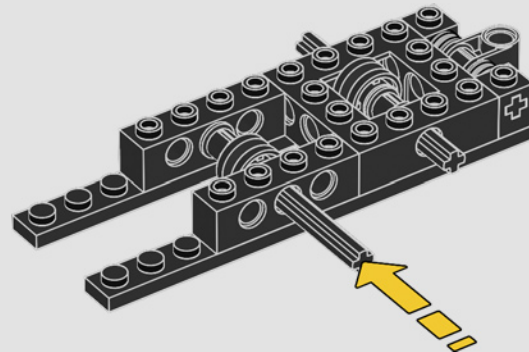



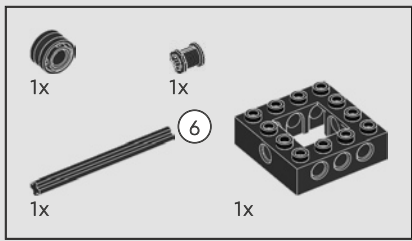

358

1

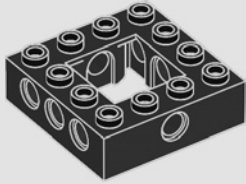

2

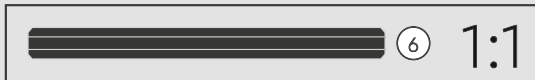
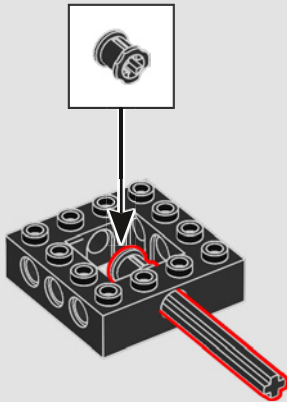

3

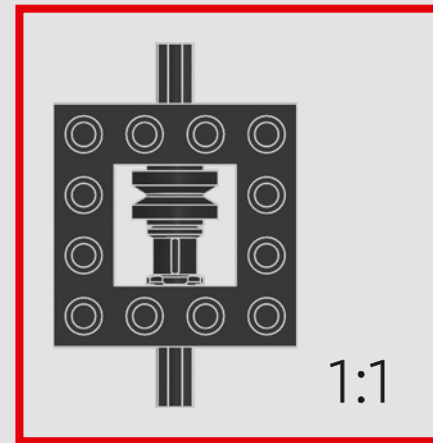
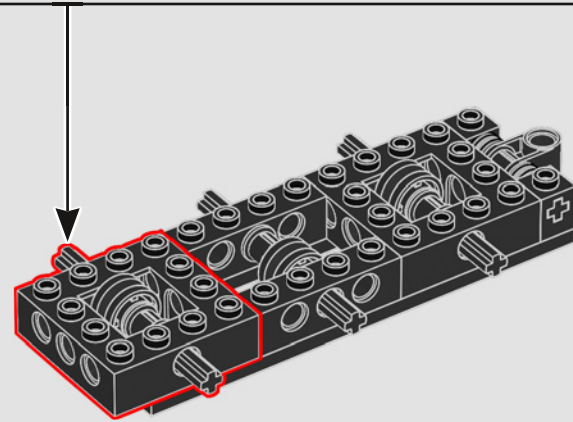
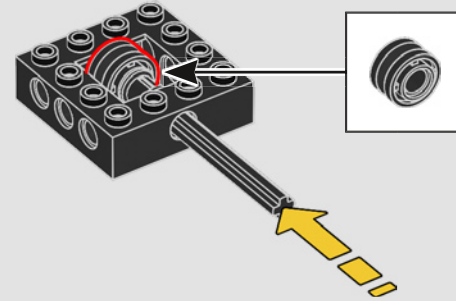

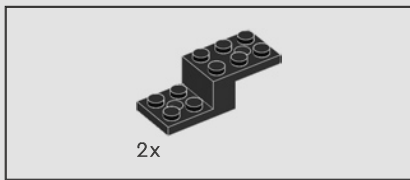

359

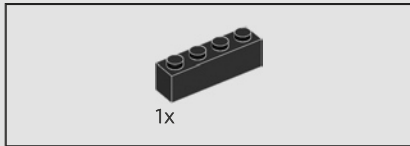
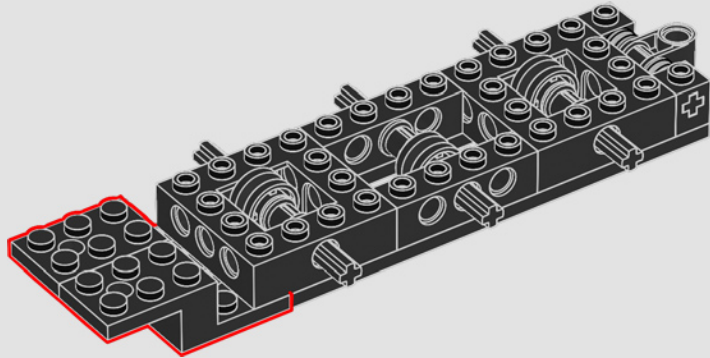

360

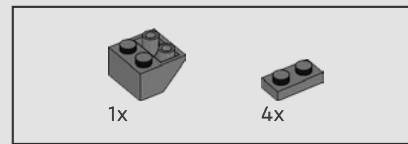
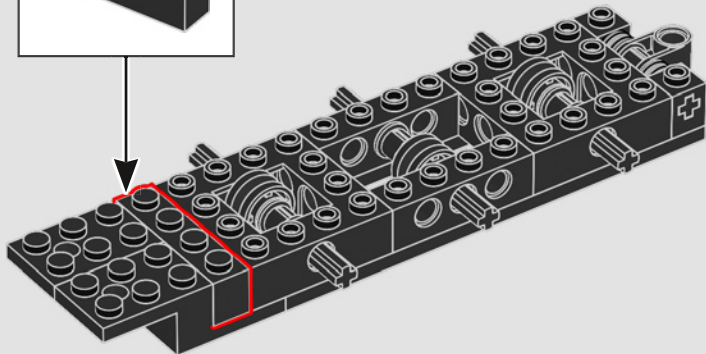
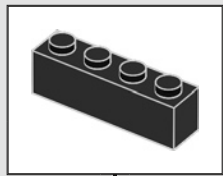

361

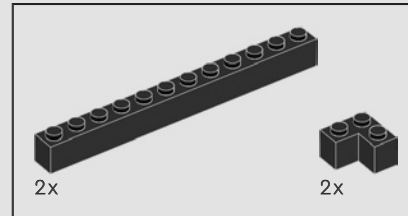
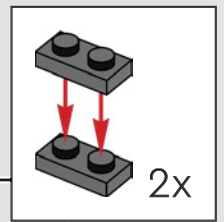
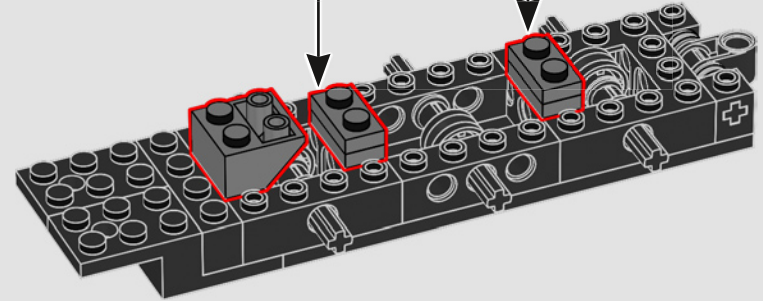

362

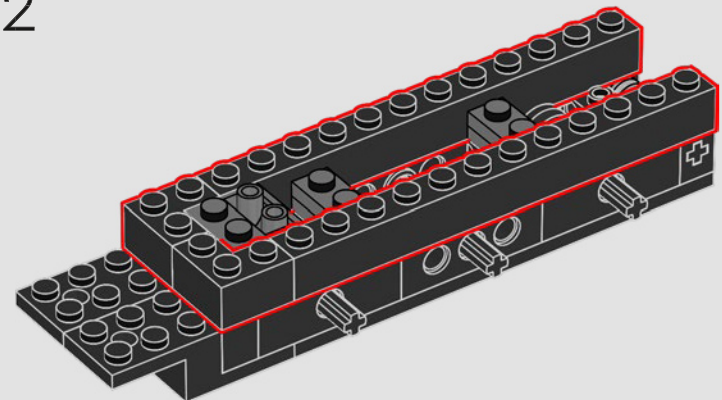

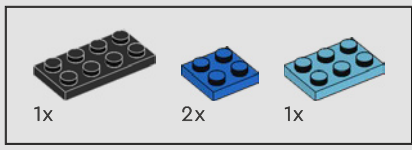

363

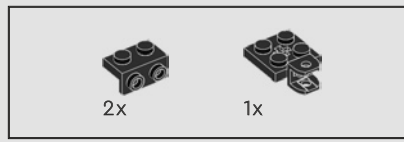
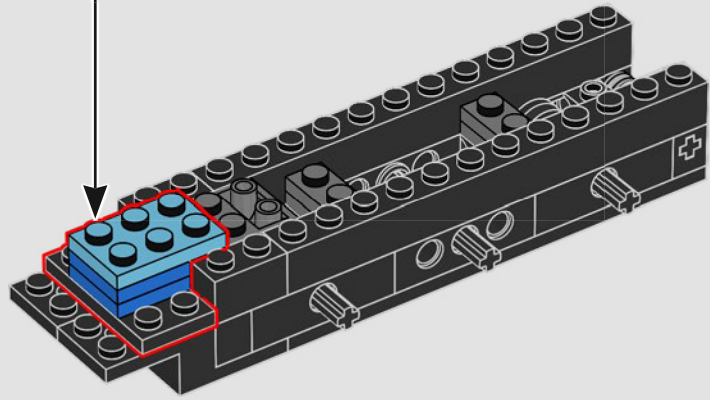
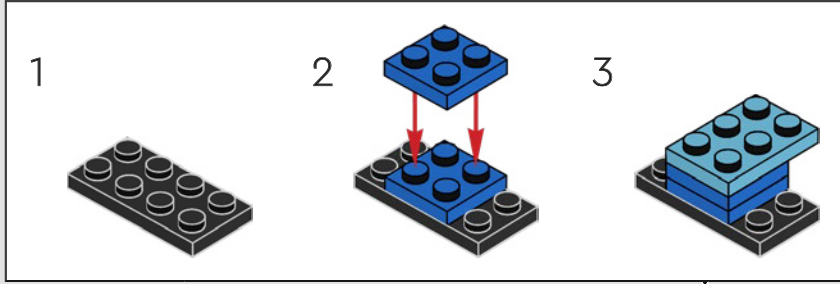

364

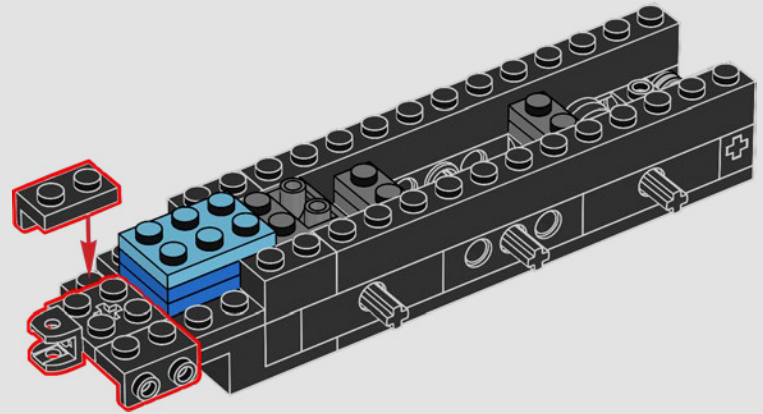

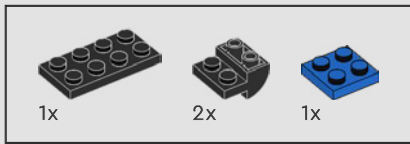

365

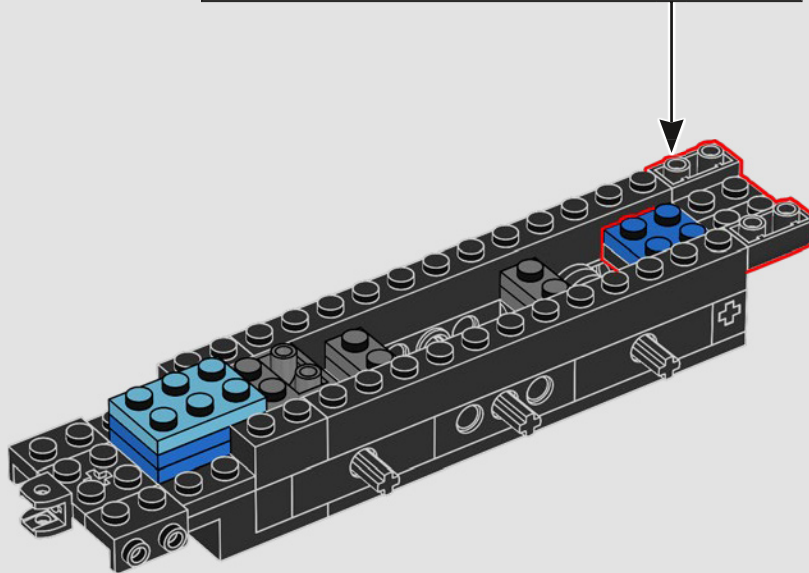
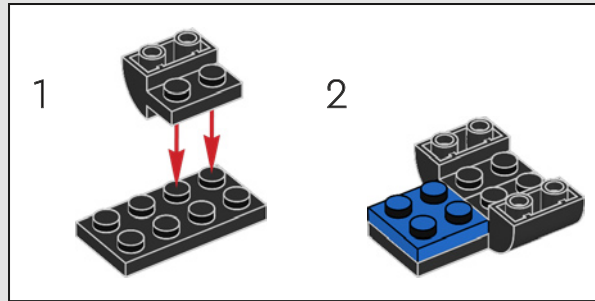



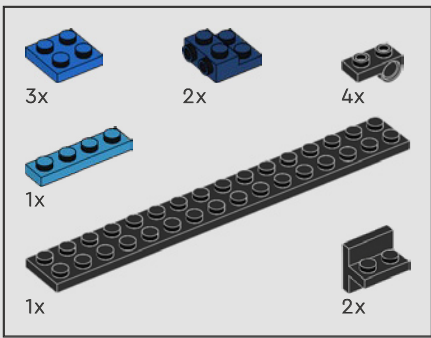

366

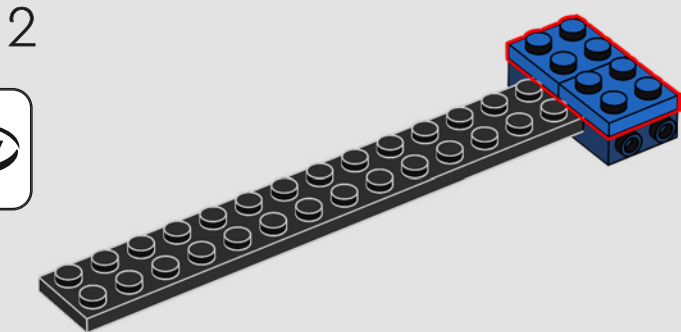
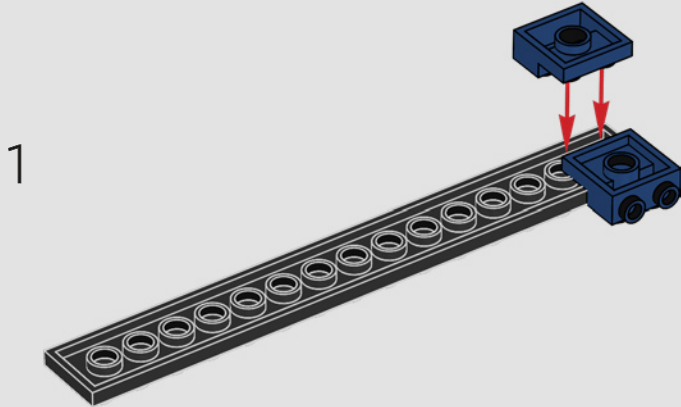

3

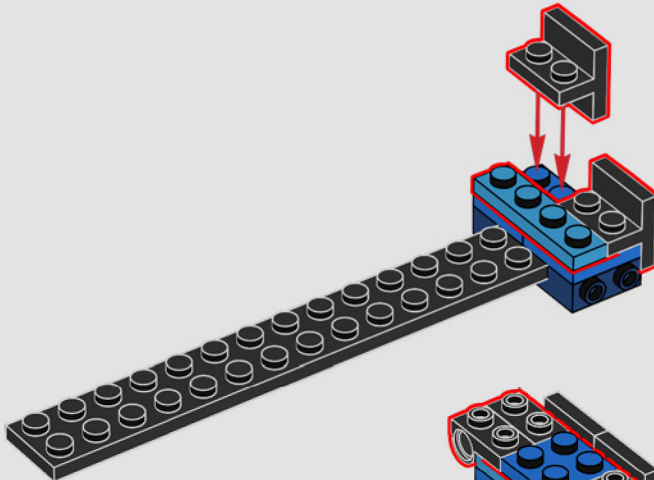

4

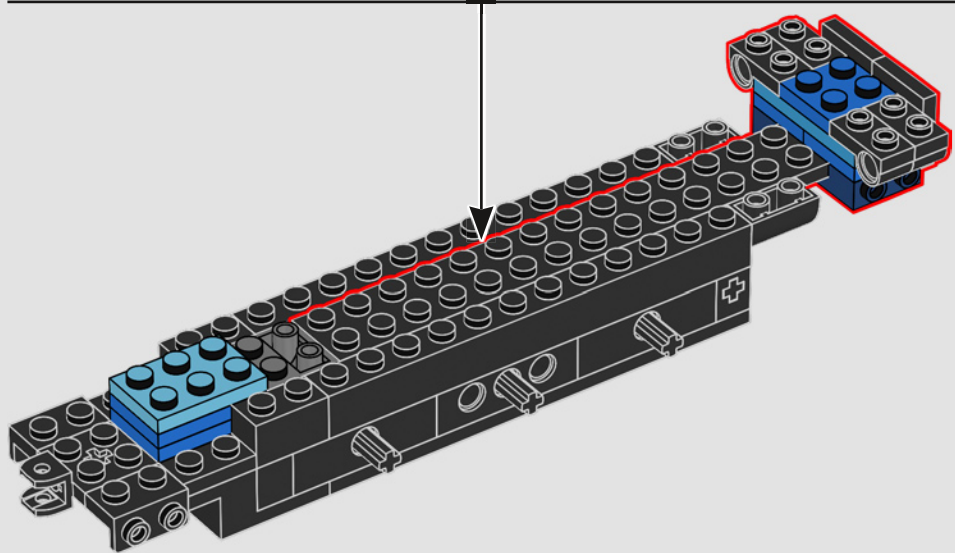
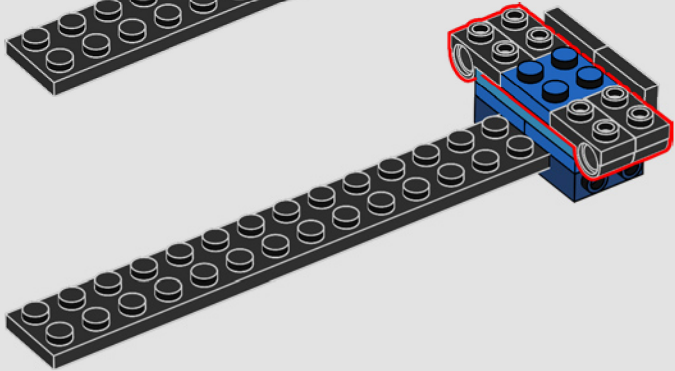

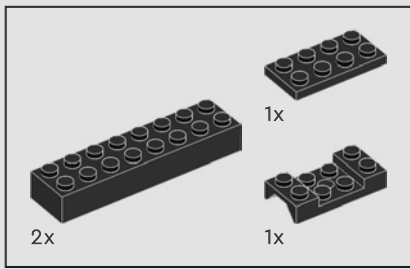

367

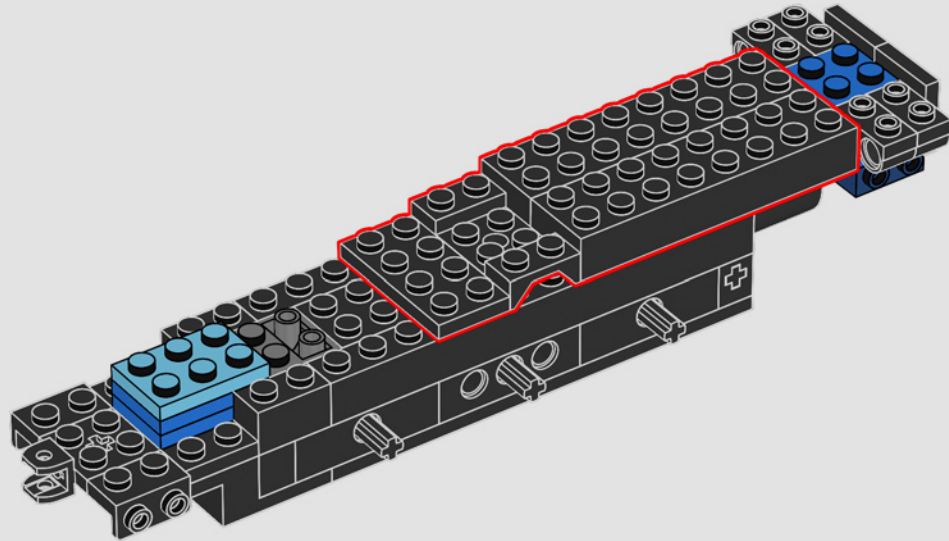

368

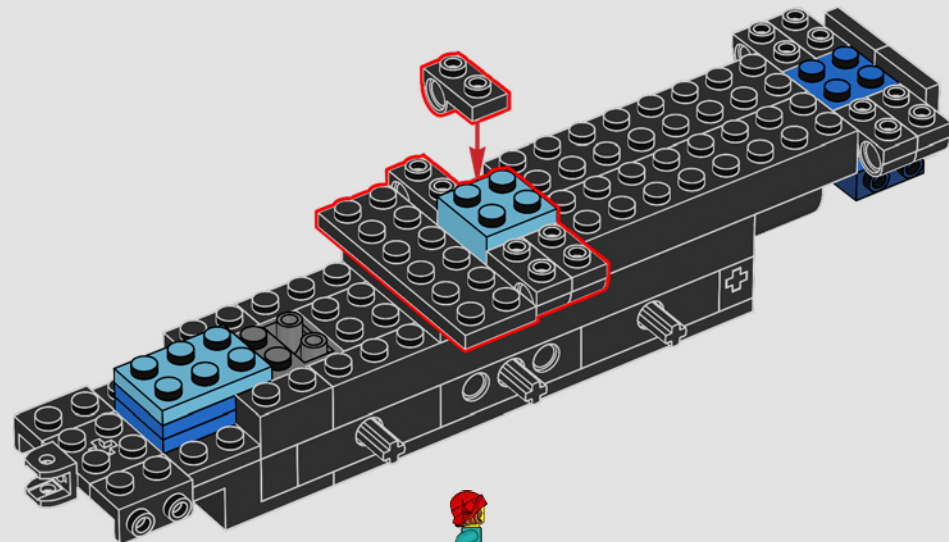

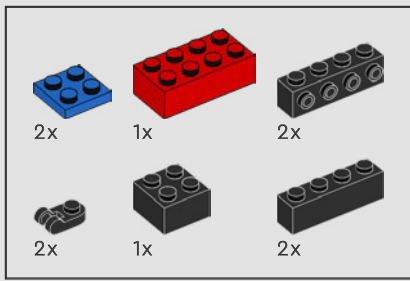

369

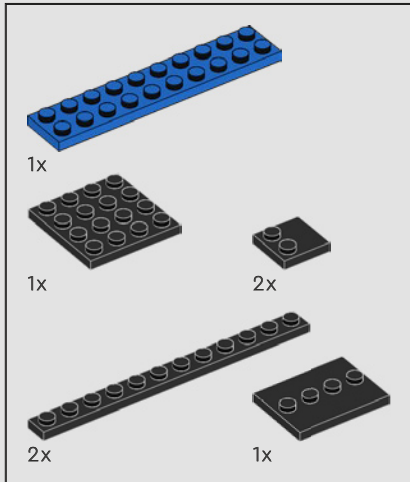
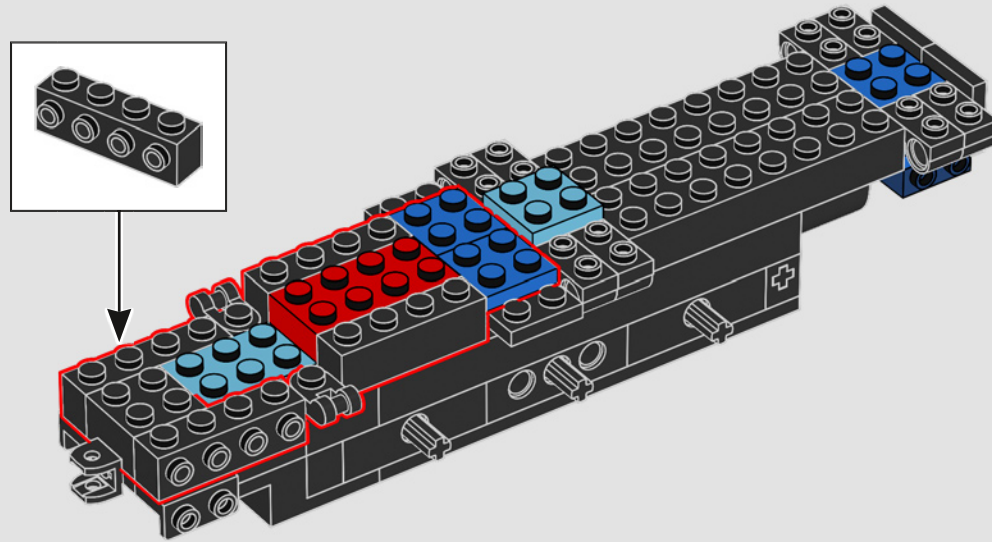

370

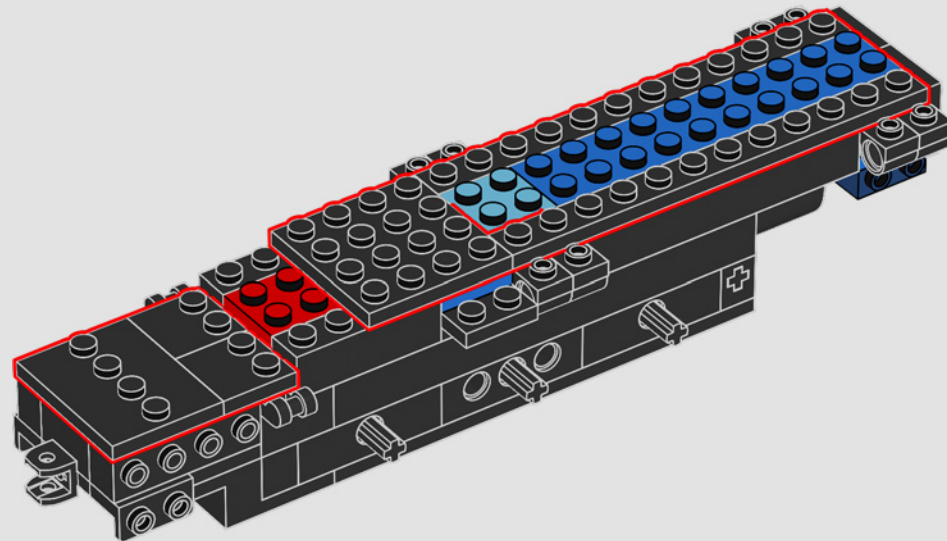

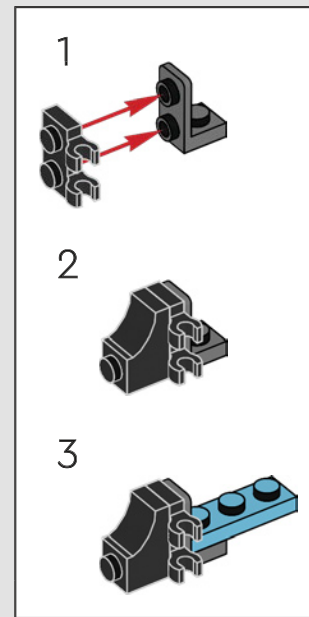
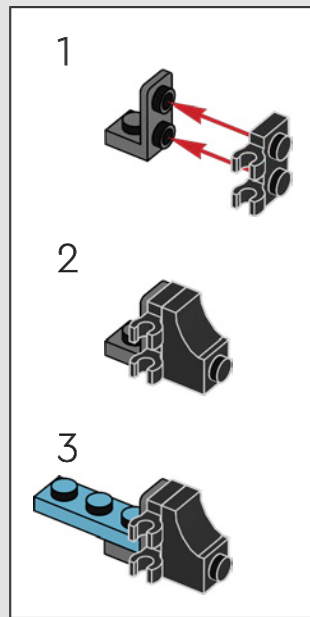

Fermata successiva: SOFIA  
"A tutto vapore attraverso le  
montagne balcaniche e verso la  
nostra prossima tappa cittadina".

371

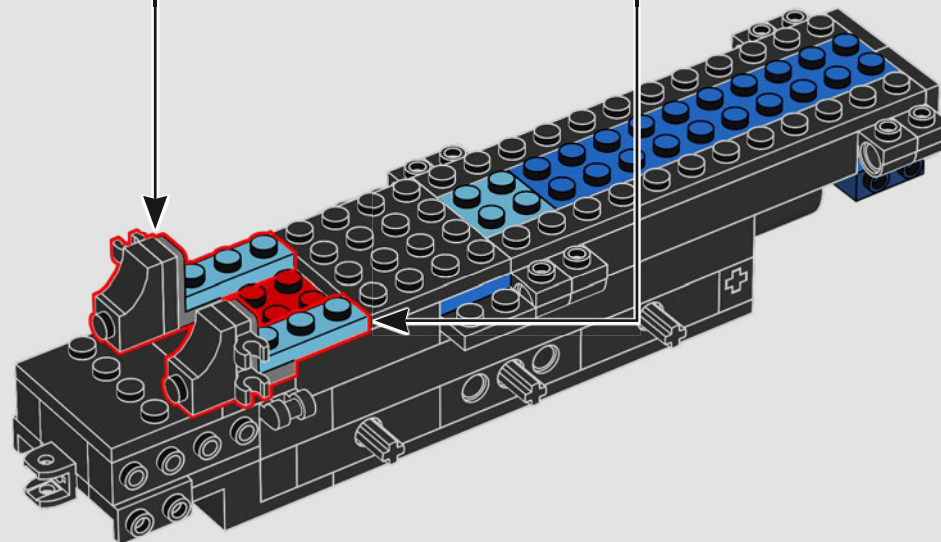



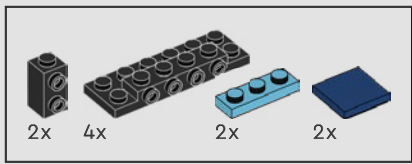

372

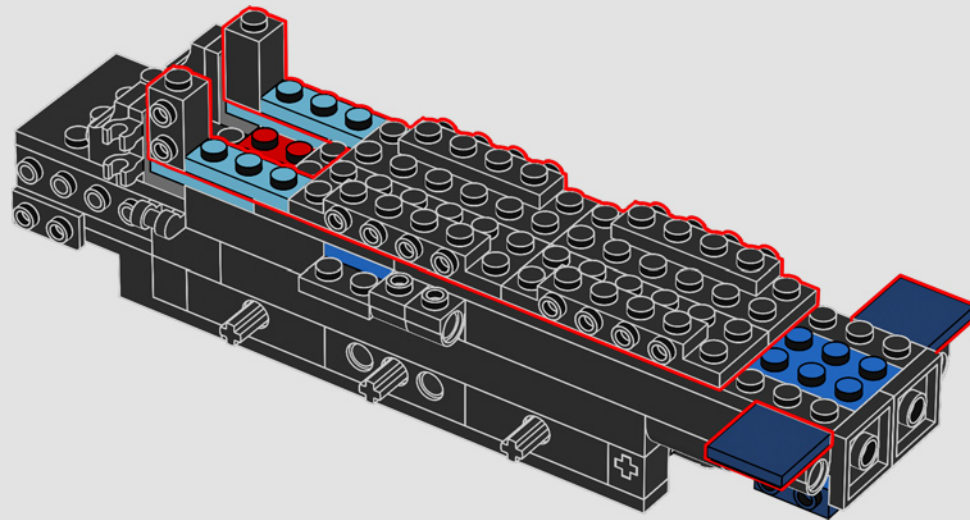

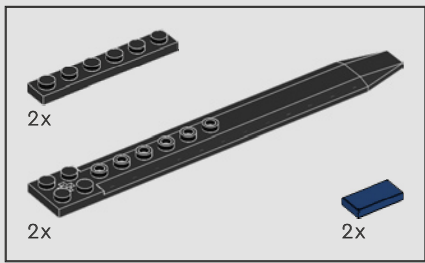

373

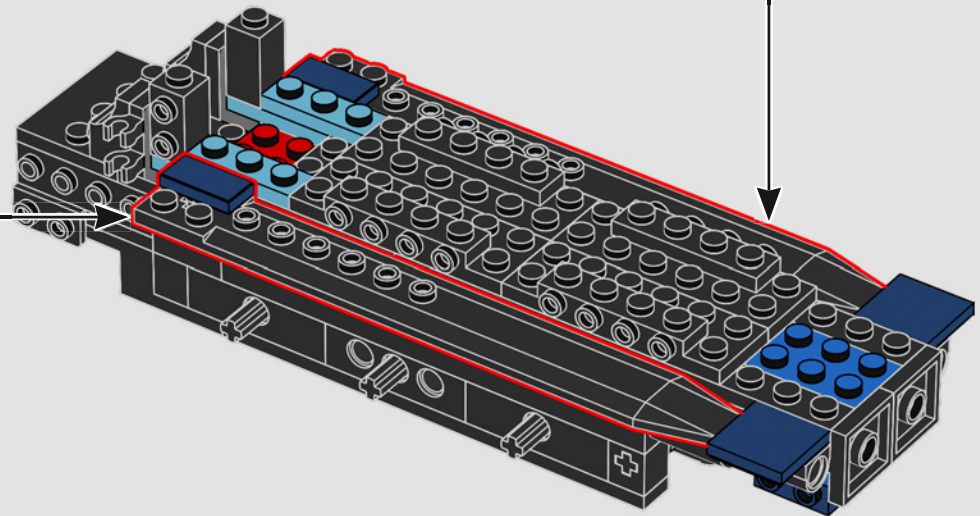
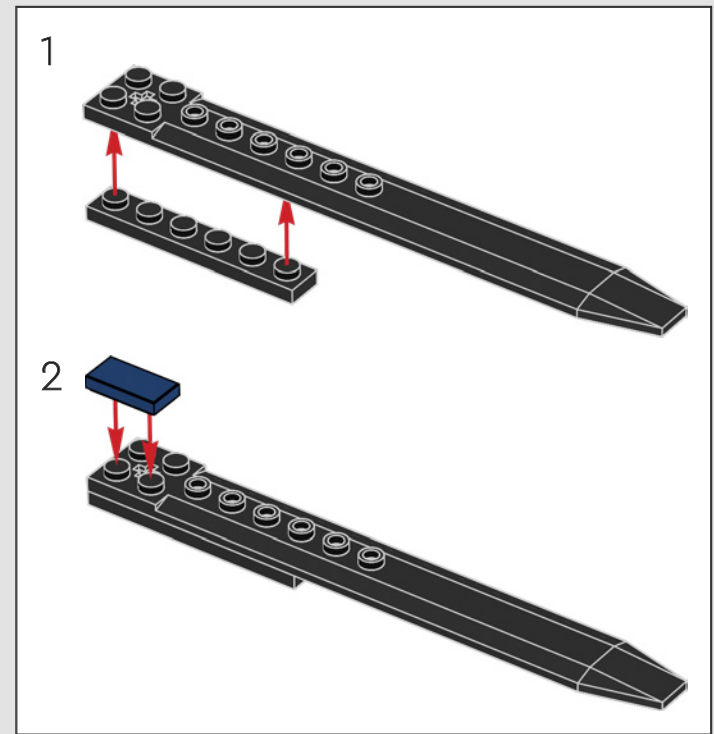
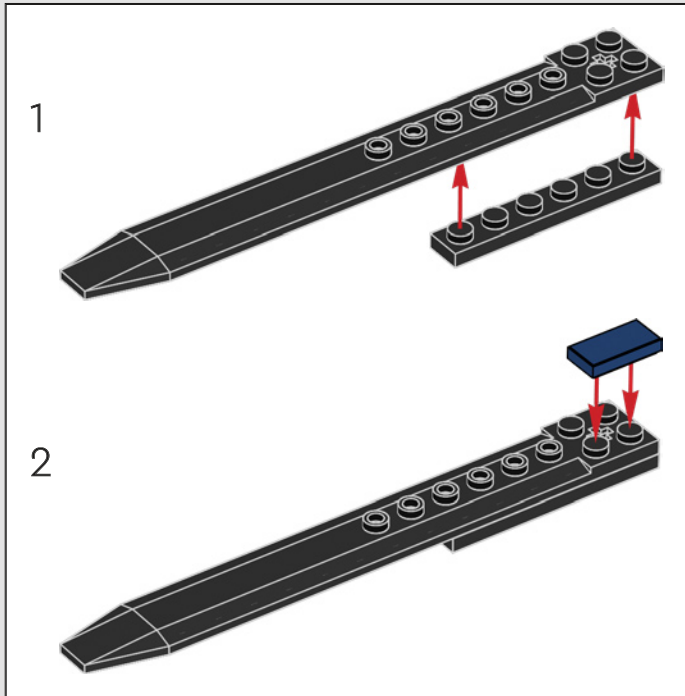

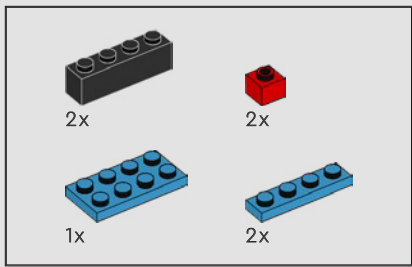

374

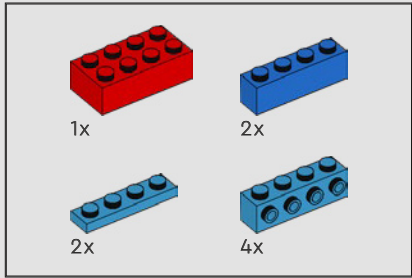
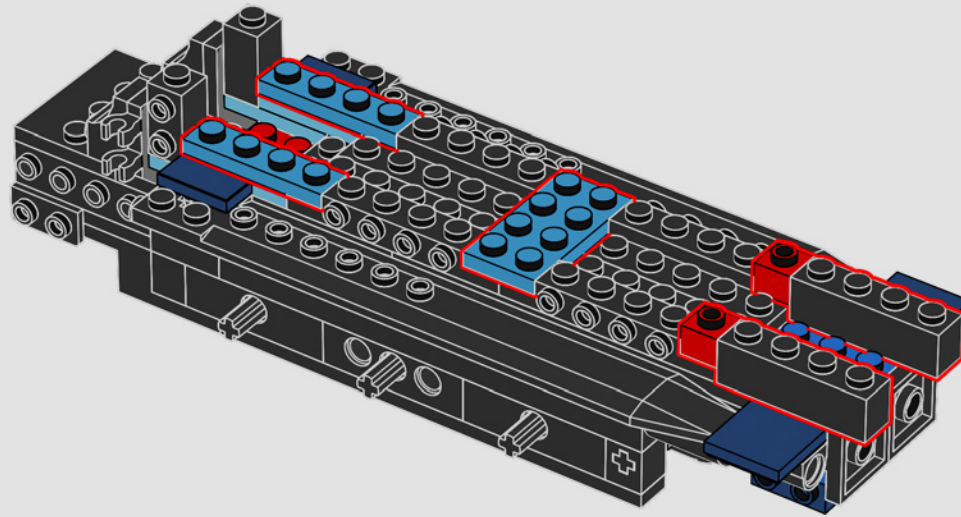

375

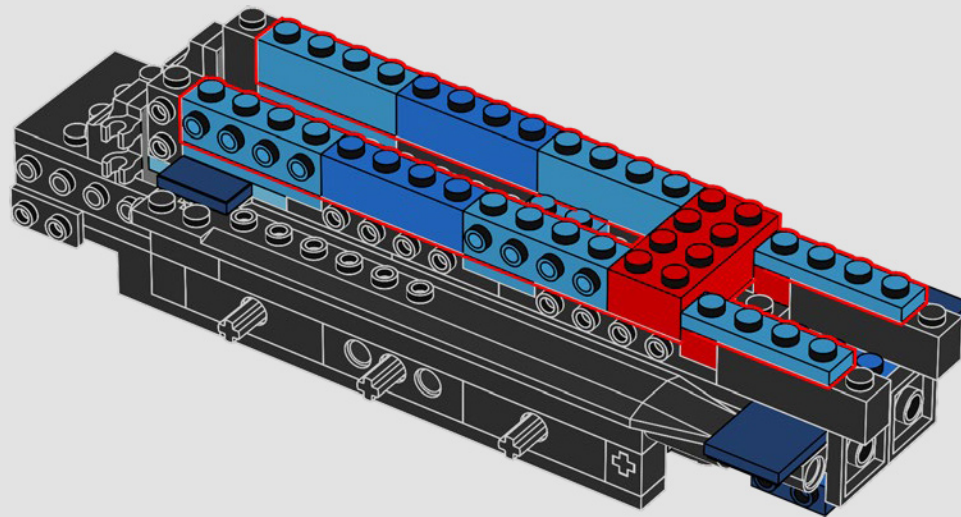

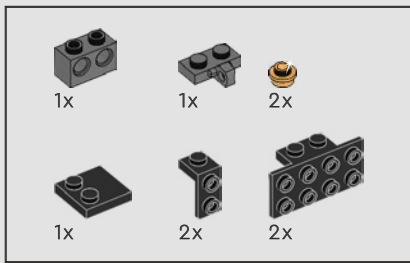

376

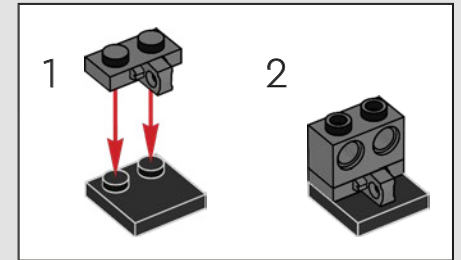
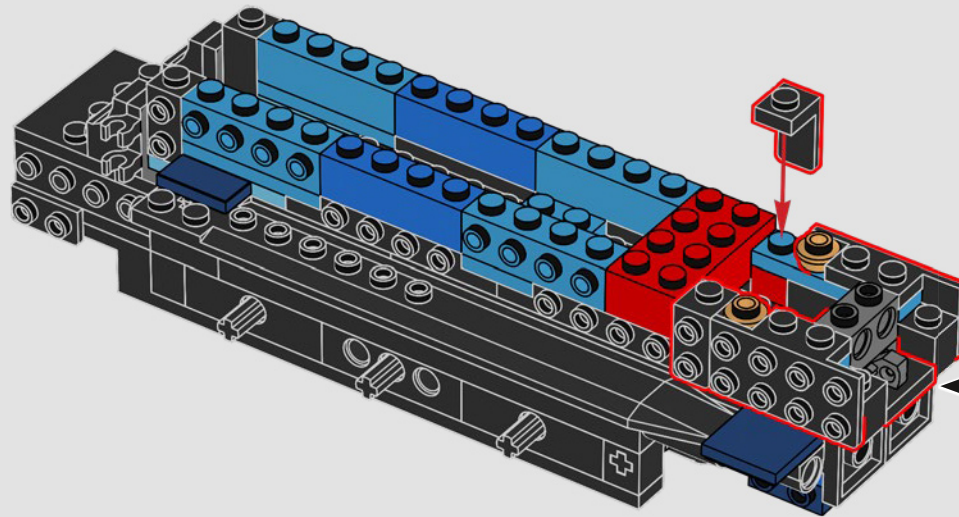



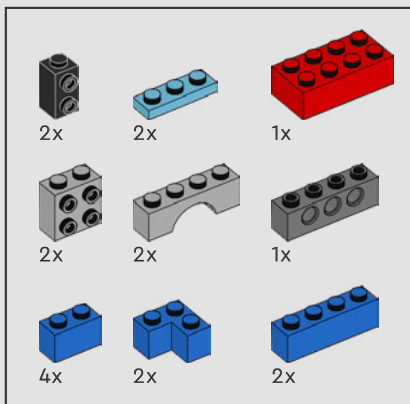

377

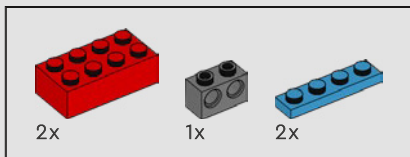
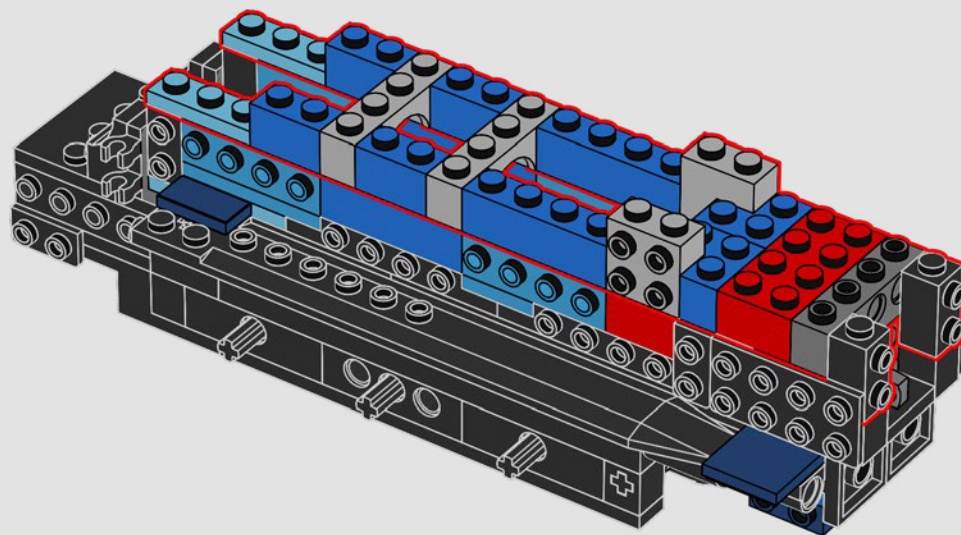

378

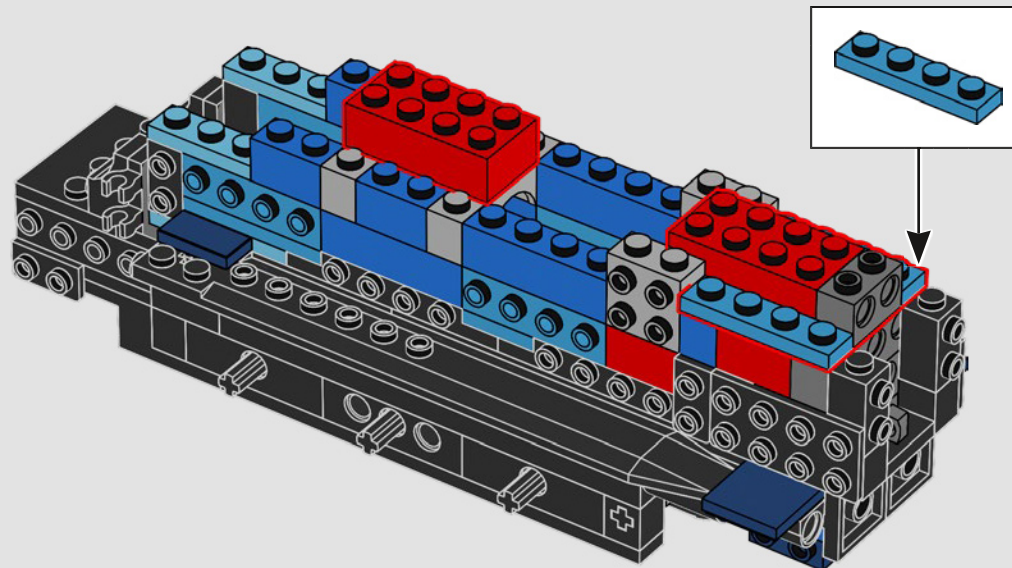

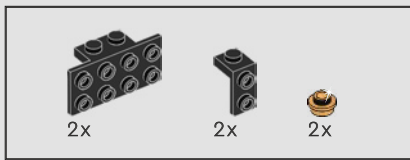

379

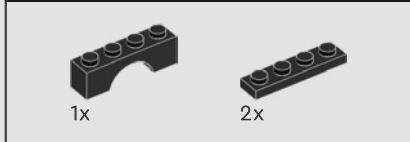
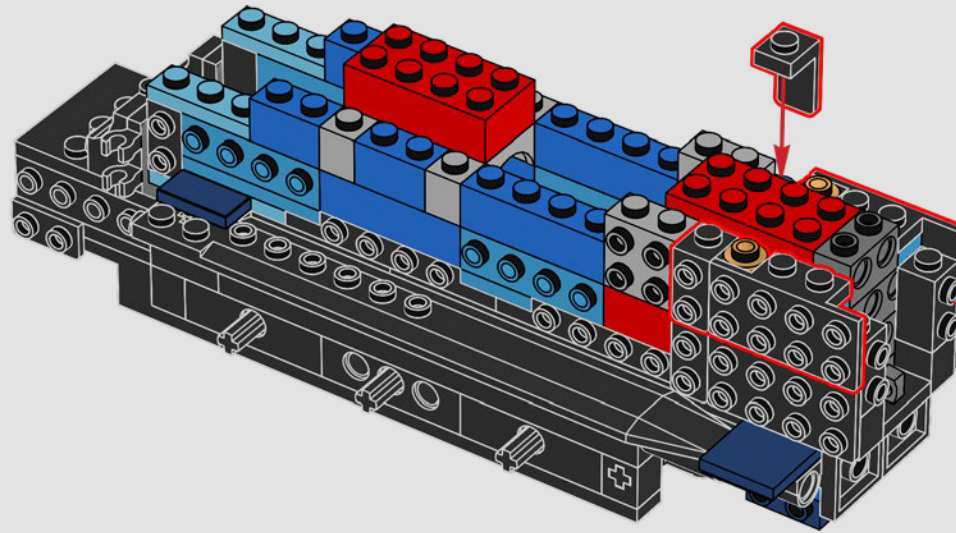

380

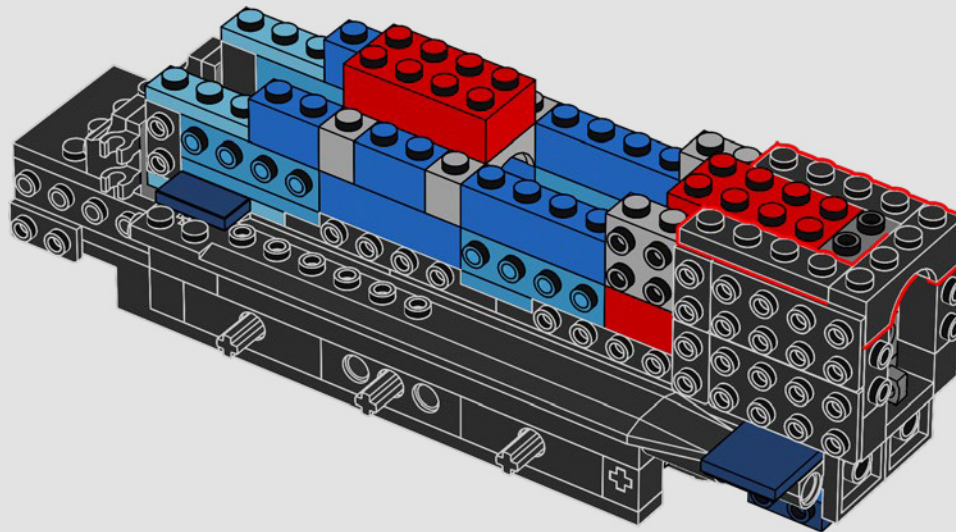

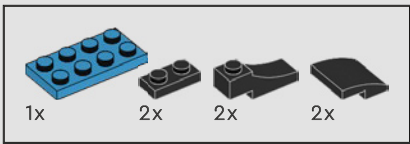

381

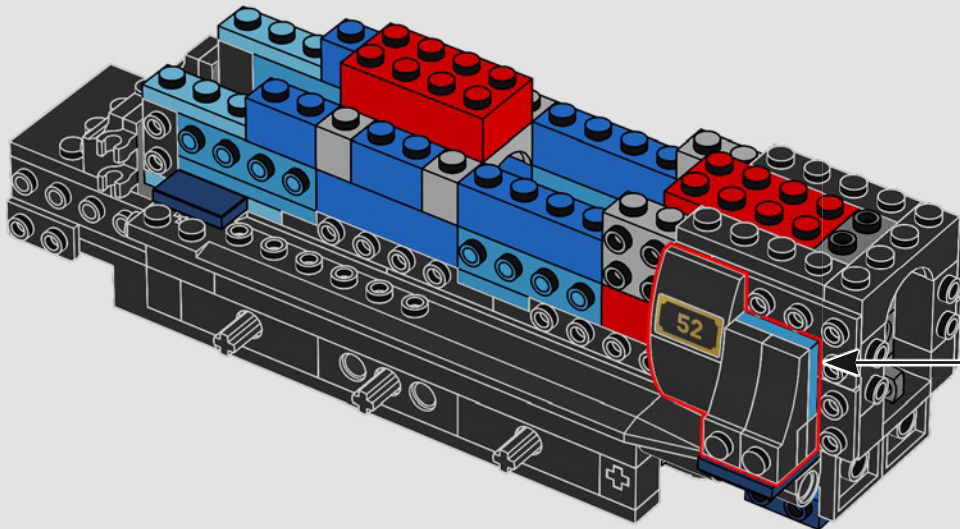
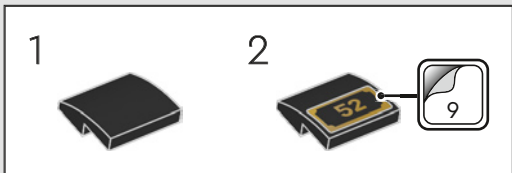
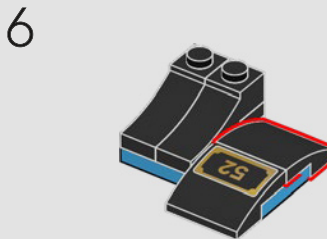
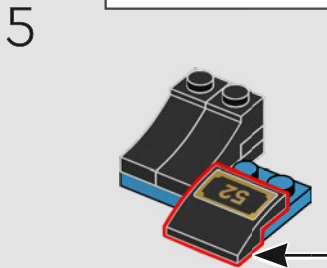
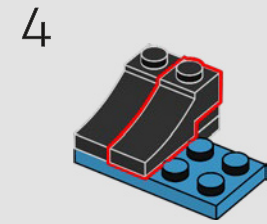
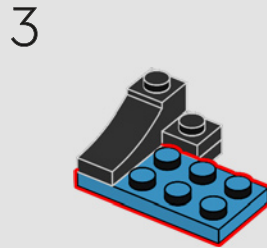
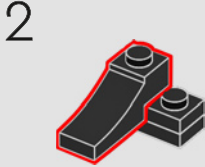
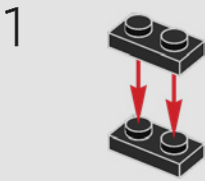



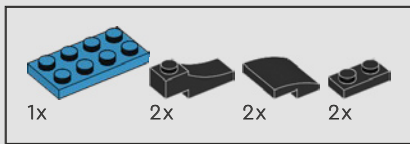

382

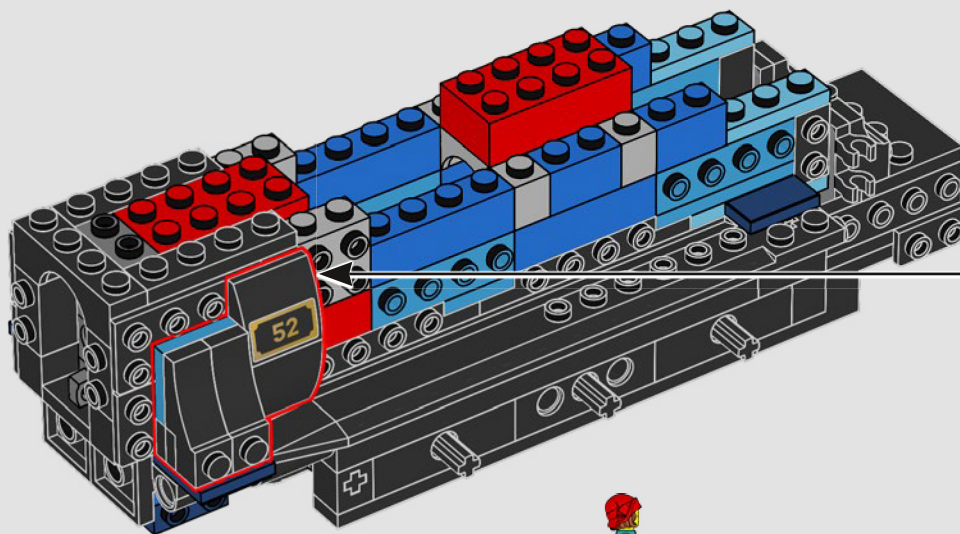
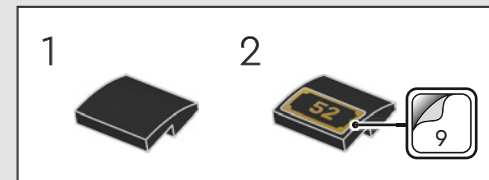
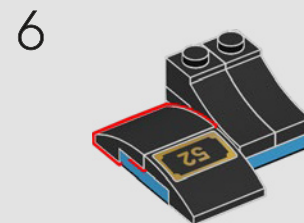
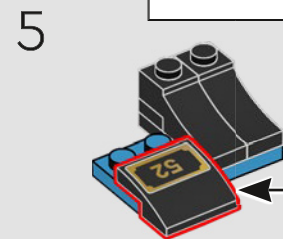
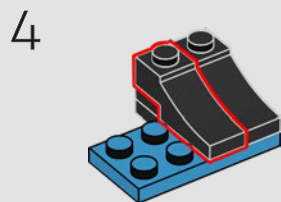
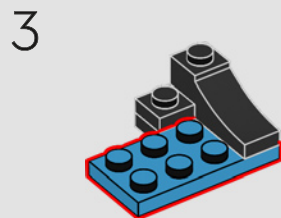
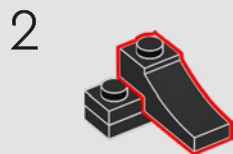
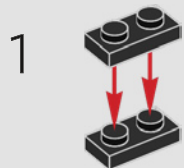





383

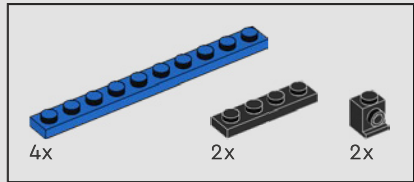
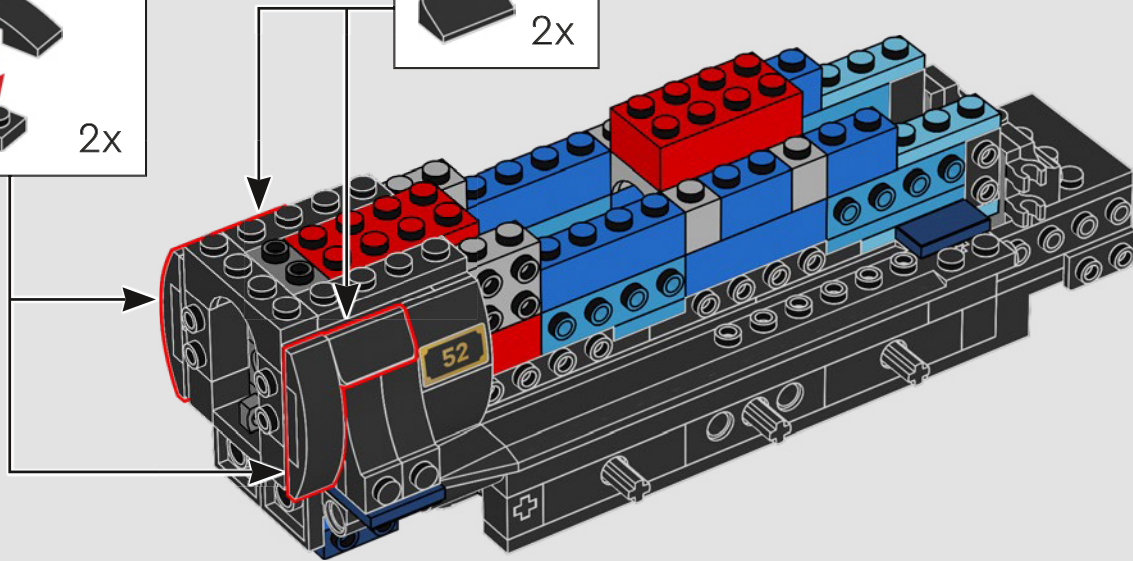
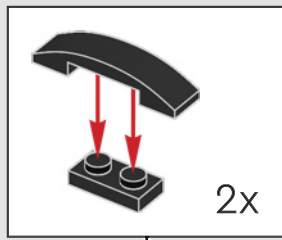

384

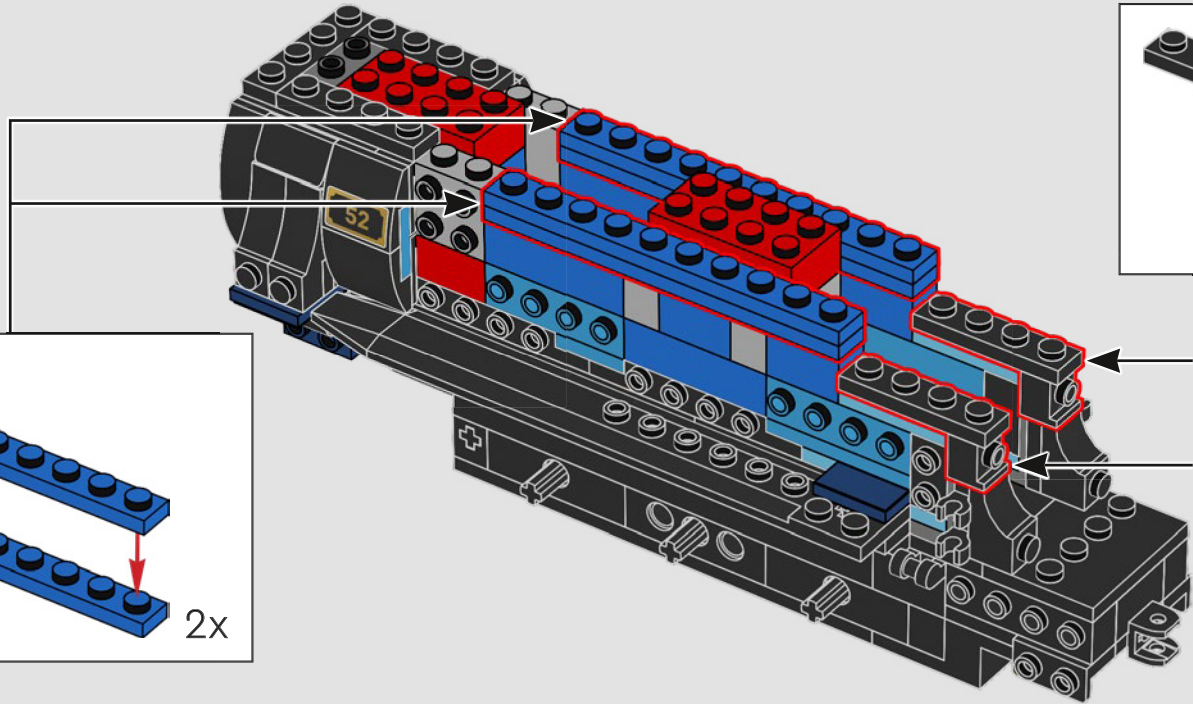
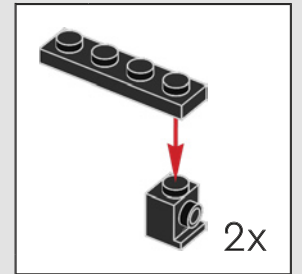
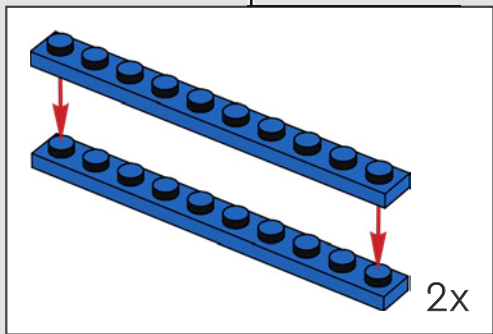

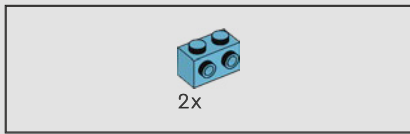

385

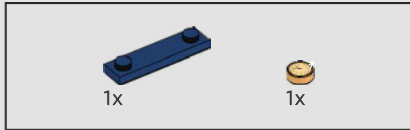
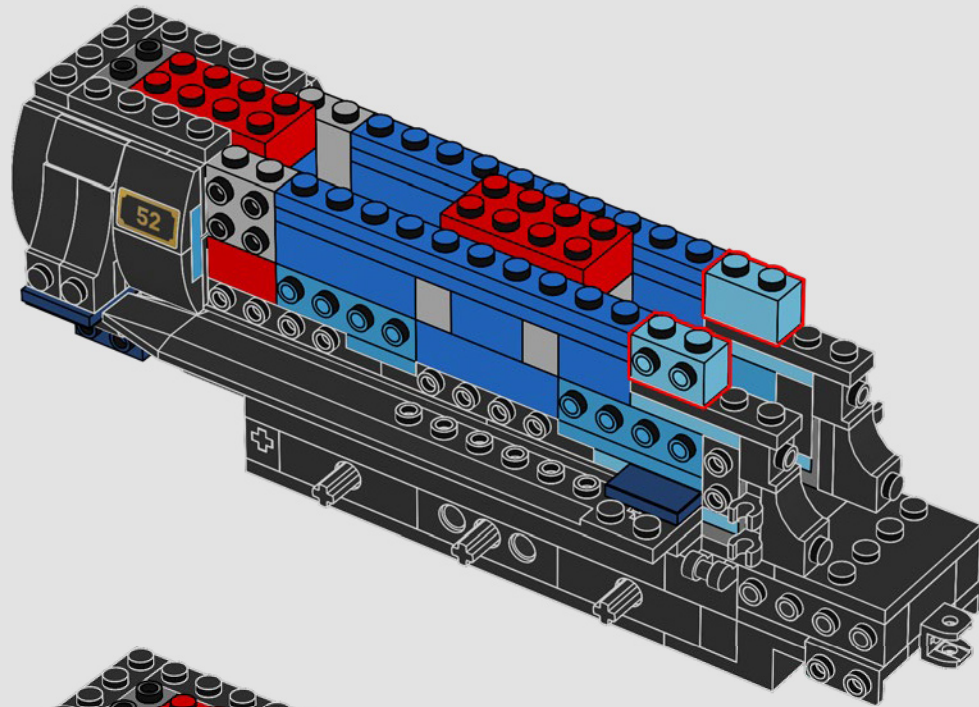

386

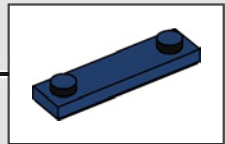
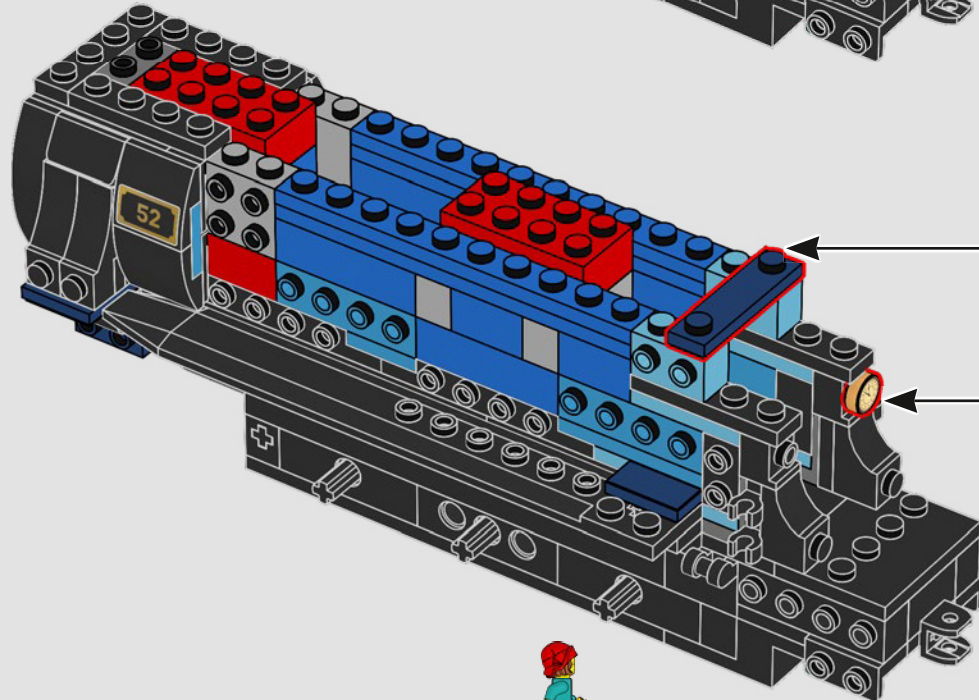





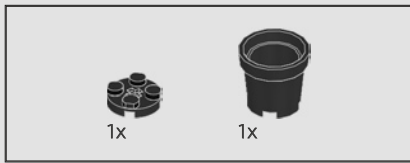

388

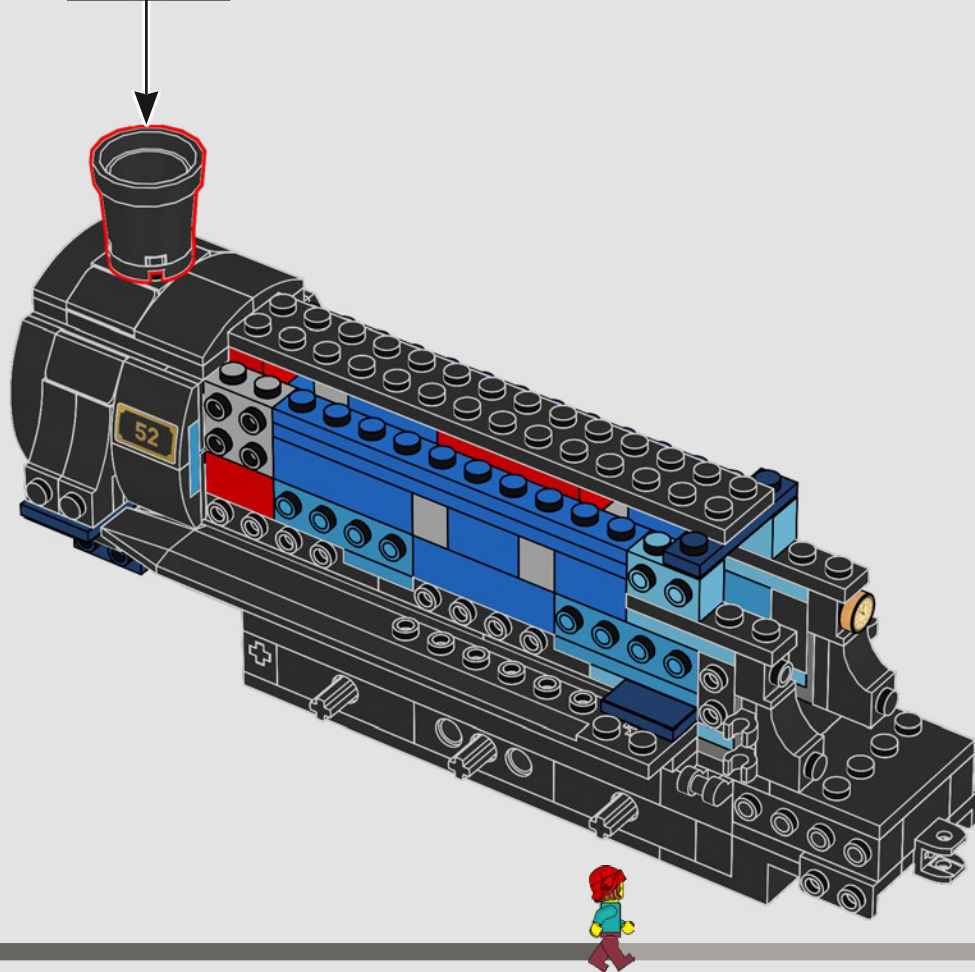
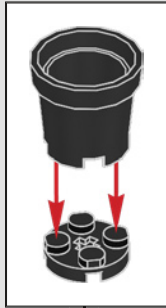



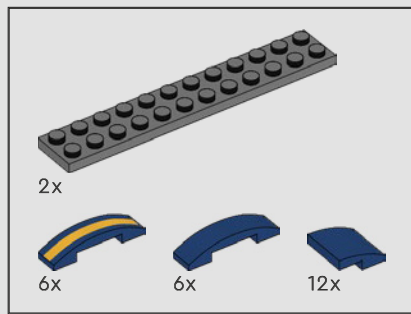

389

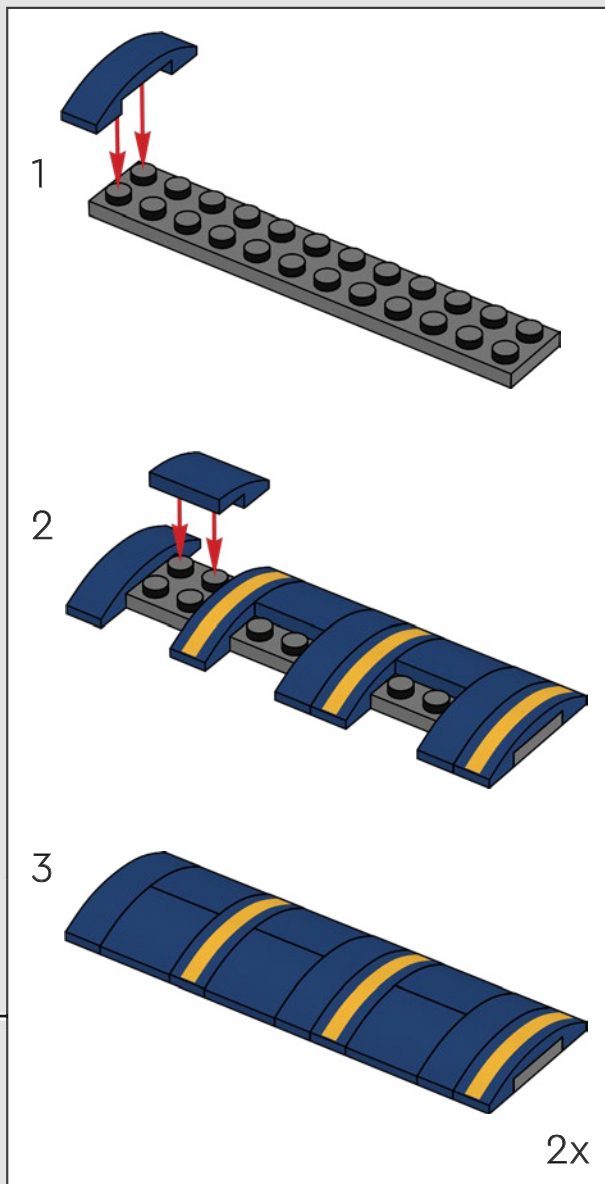
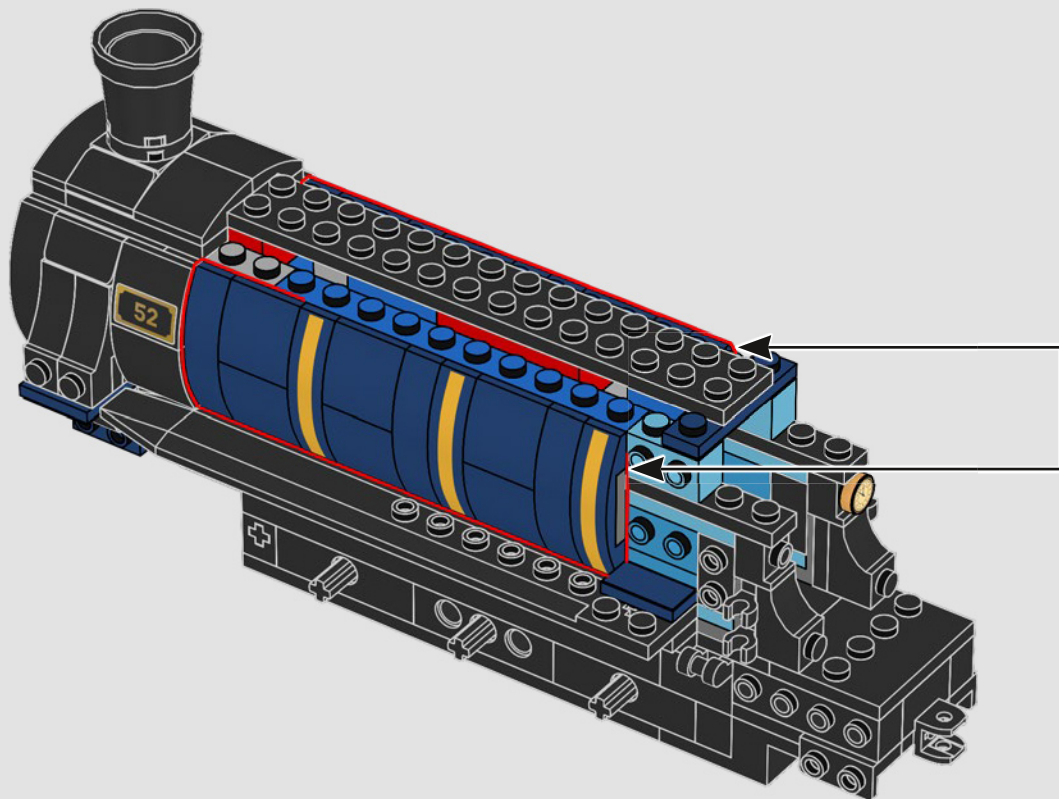

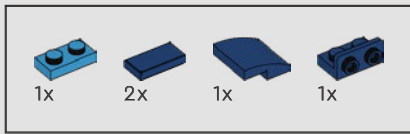

390

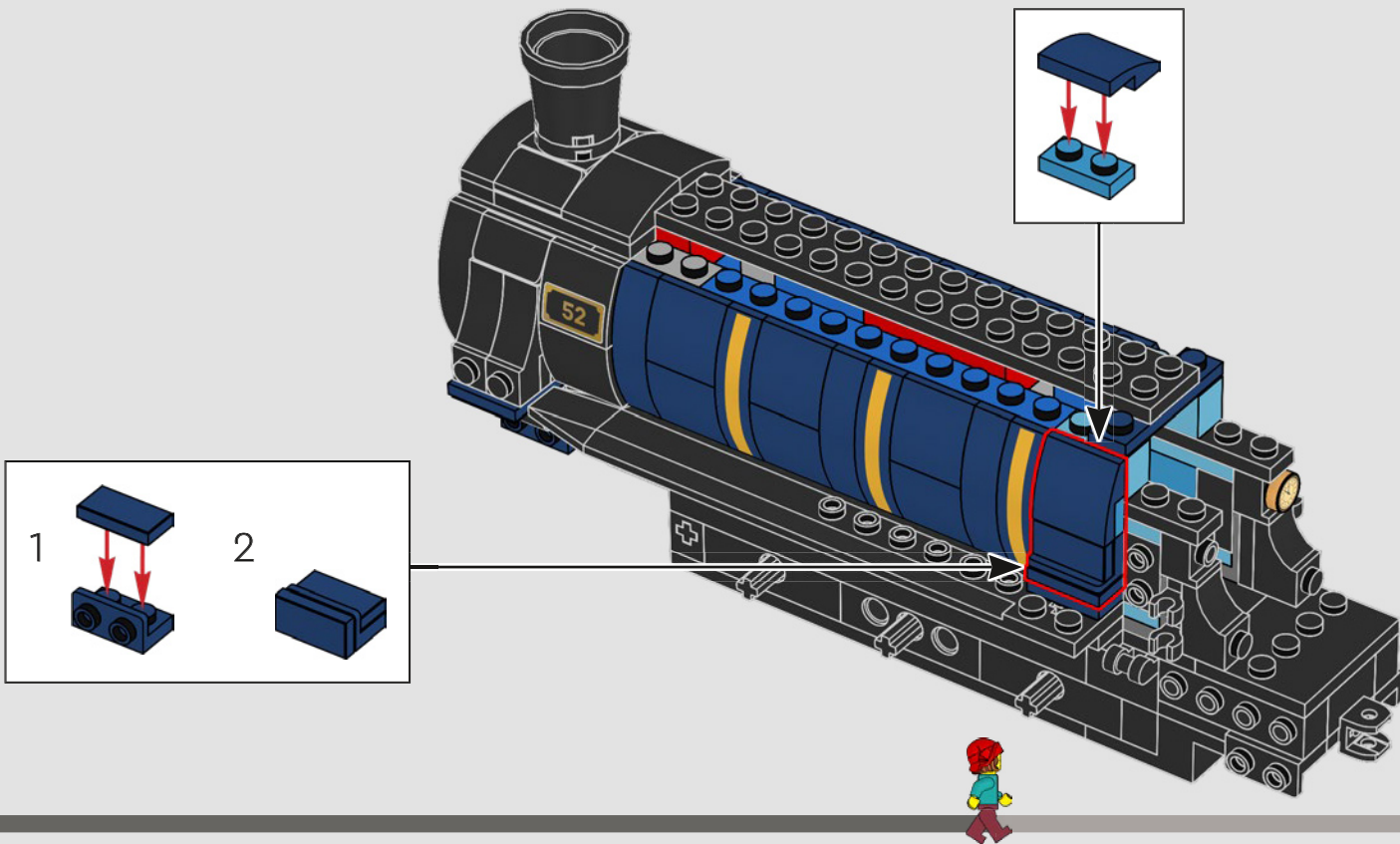

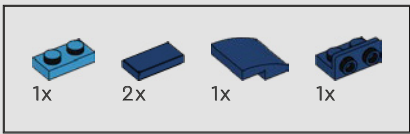

391

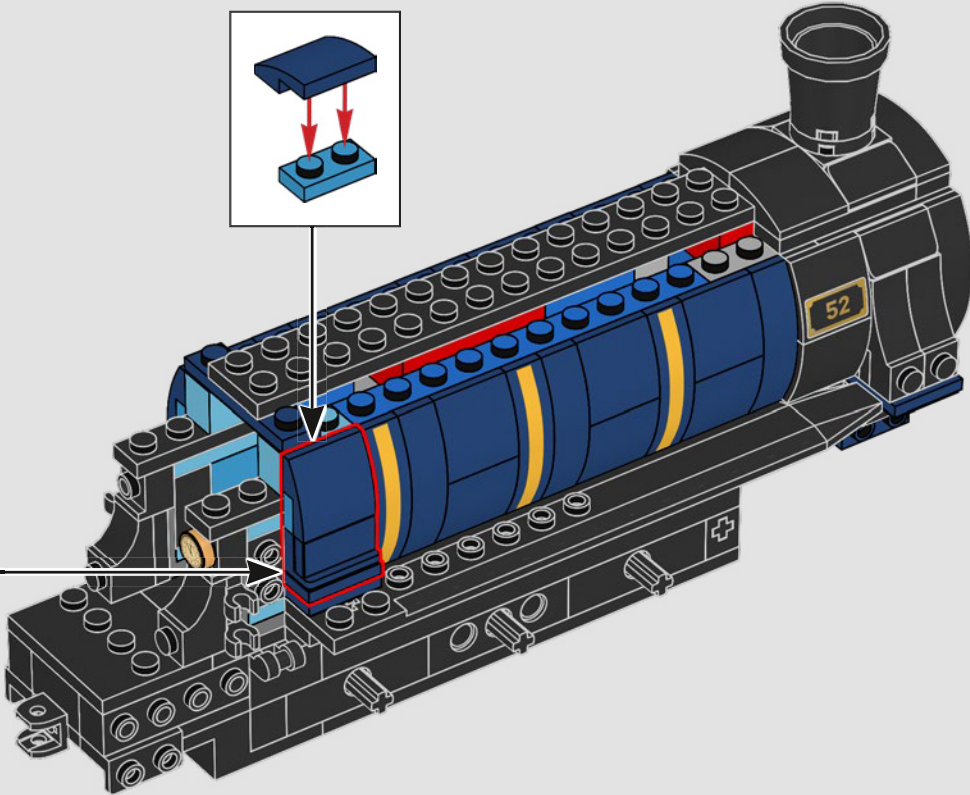
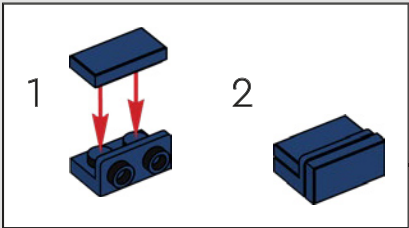
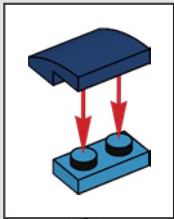

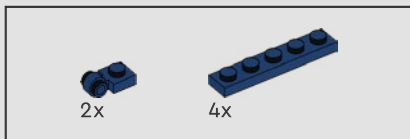

392

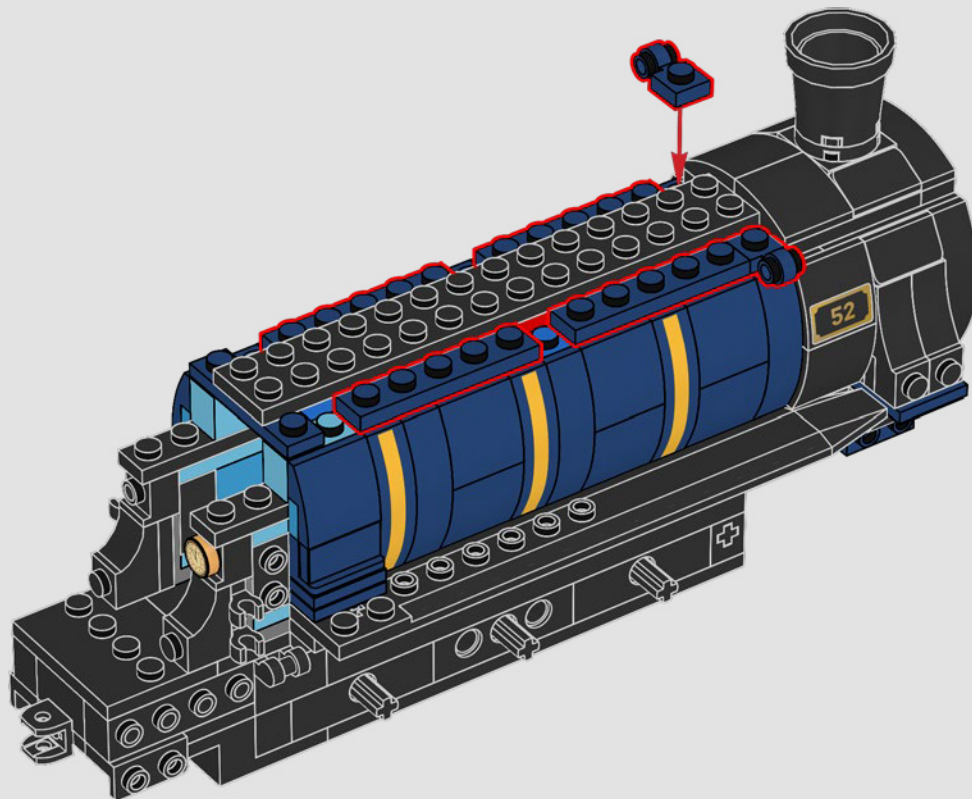



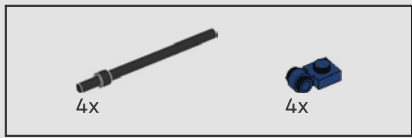

393

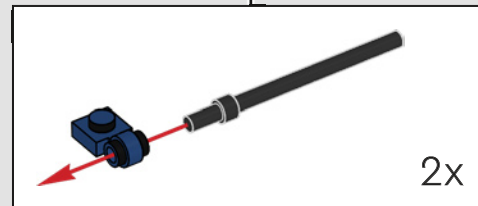
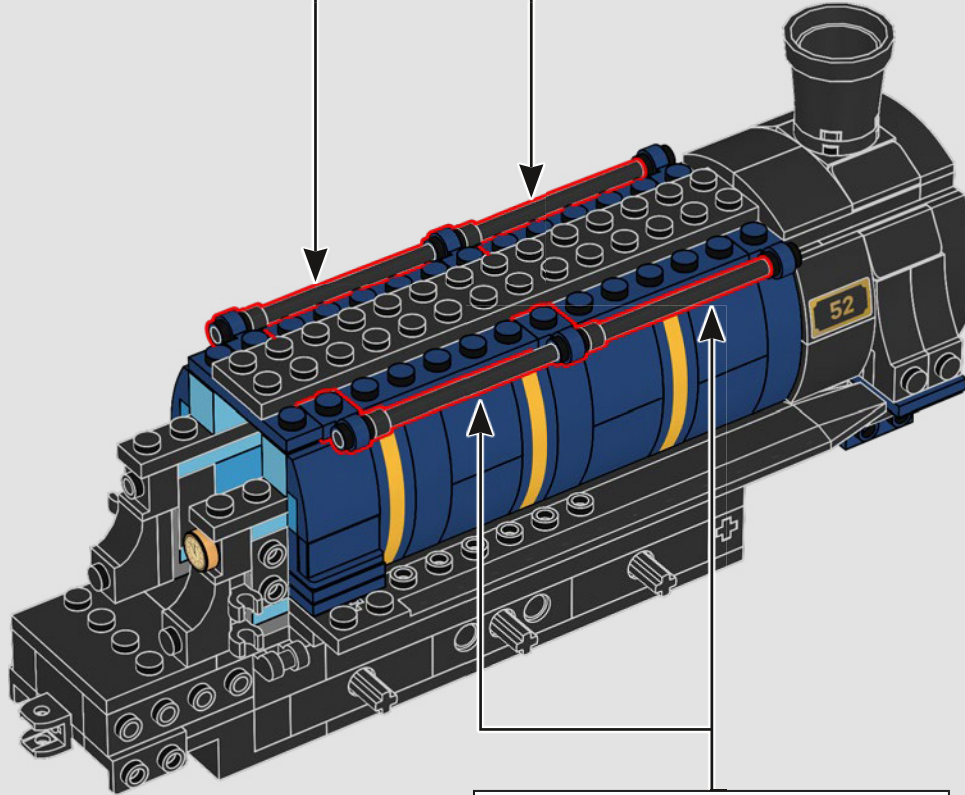
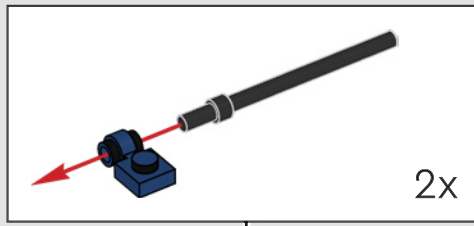

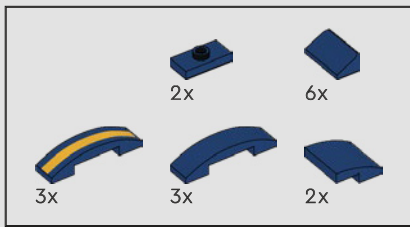

394

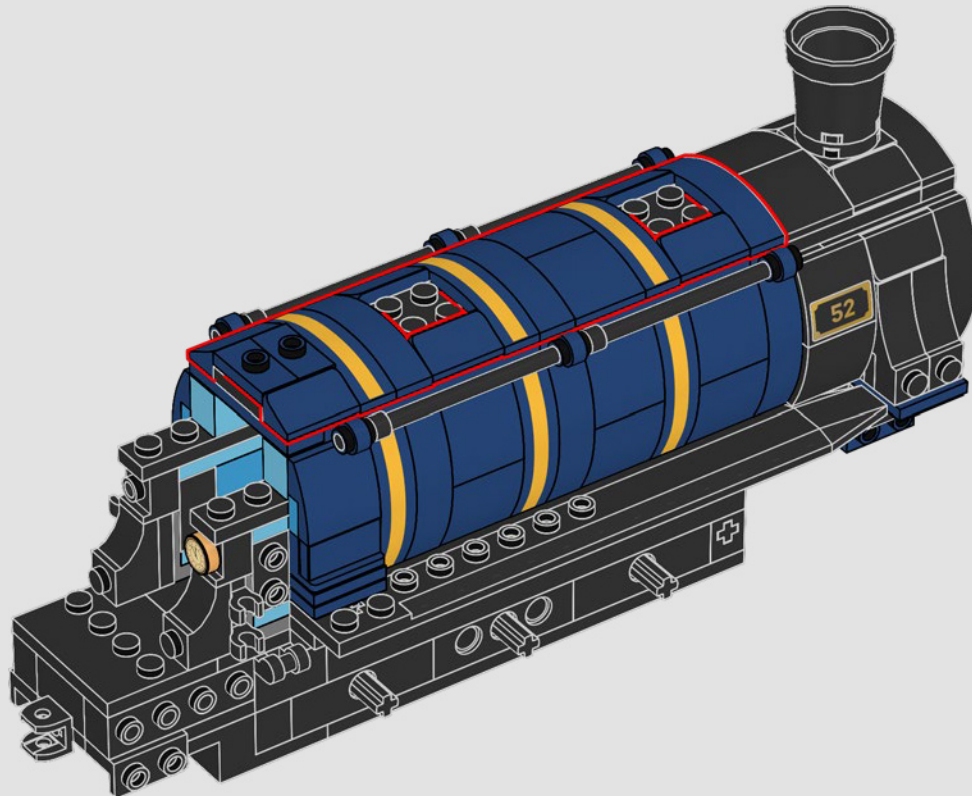

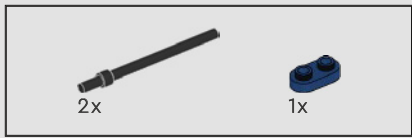

395

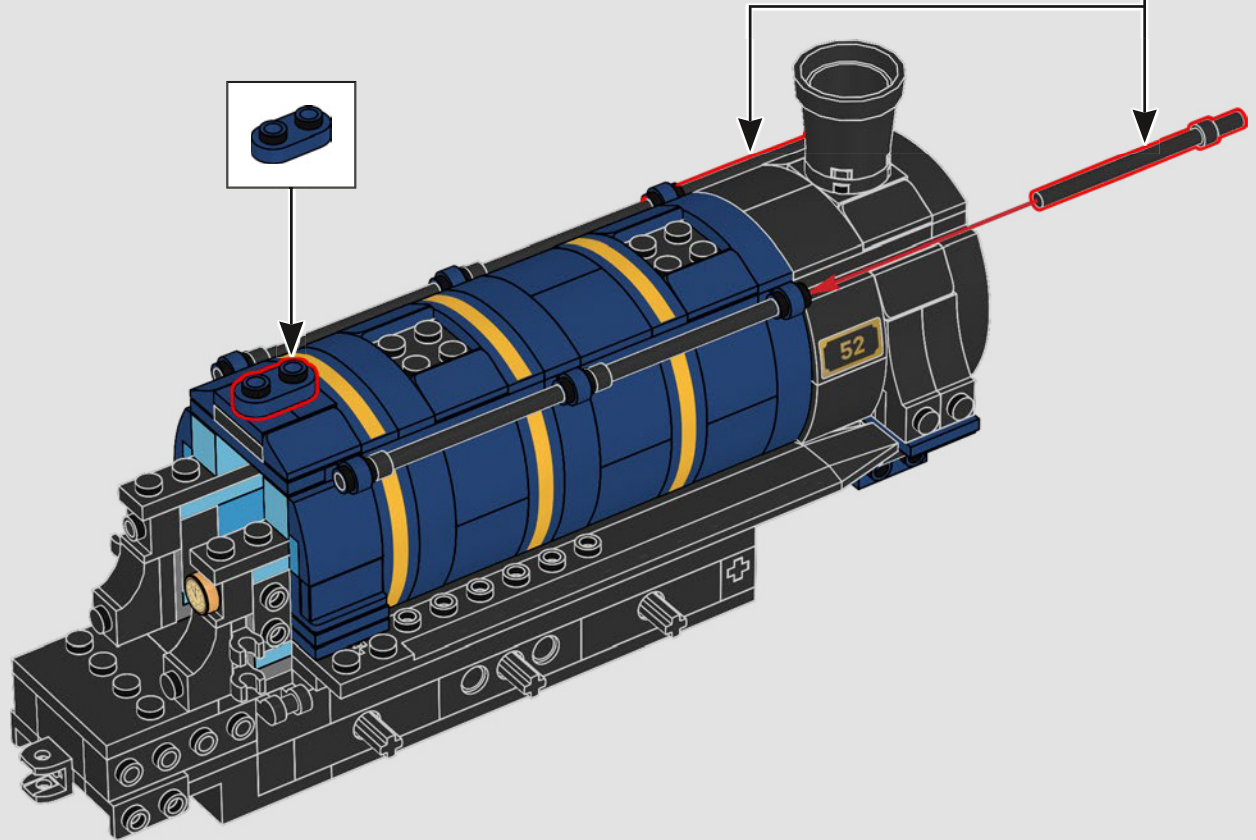

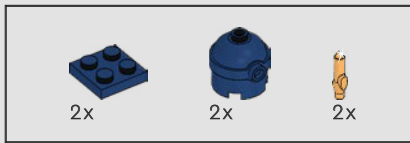

396

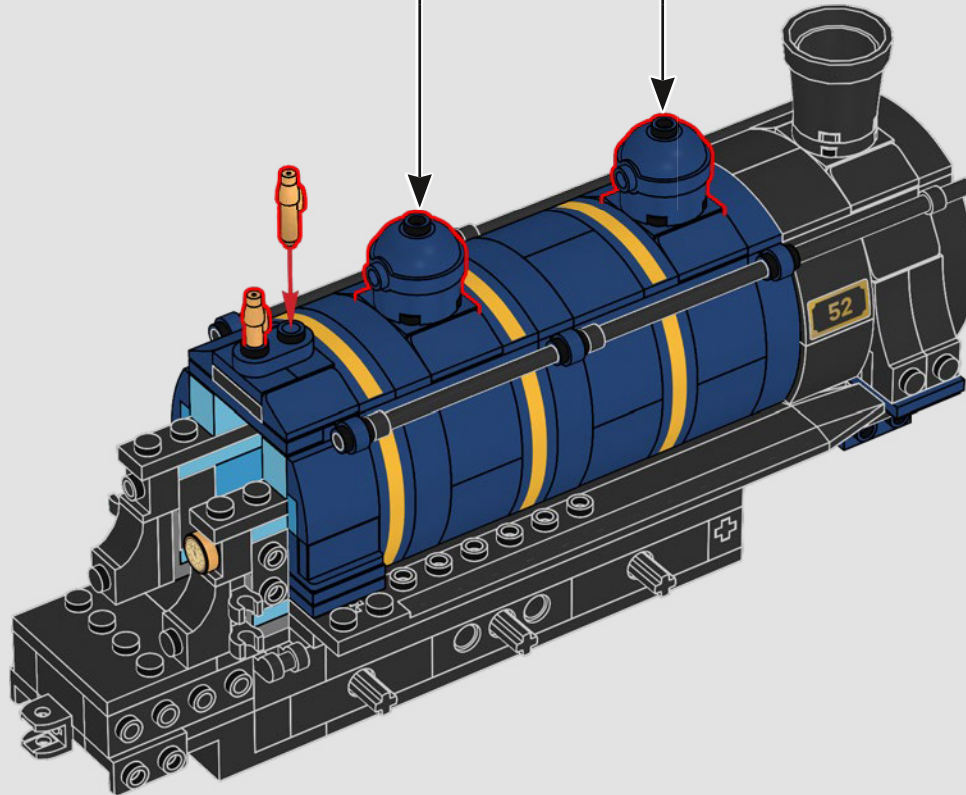
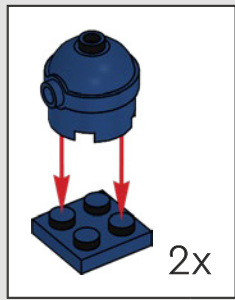



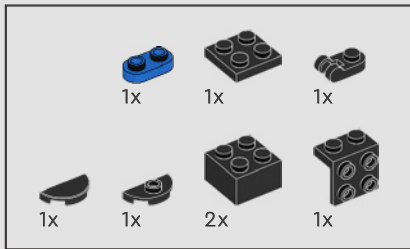
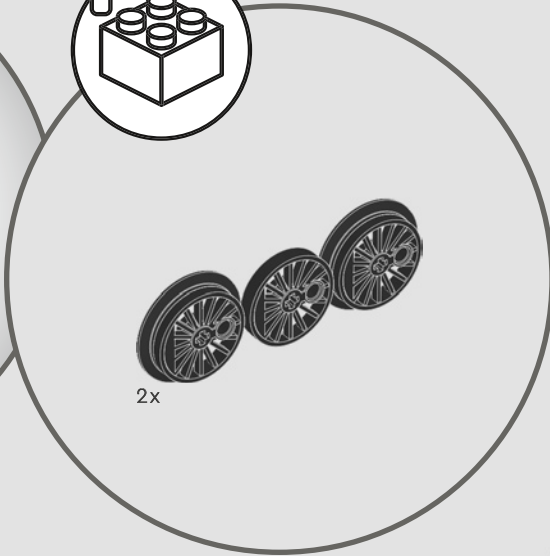
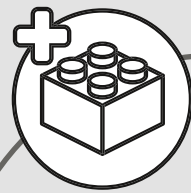

397

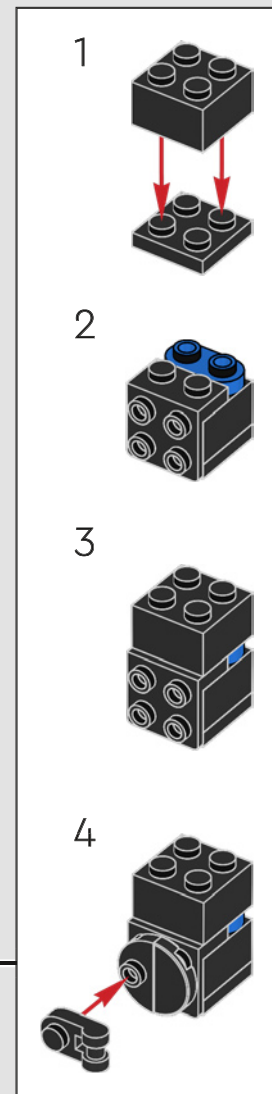
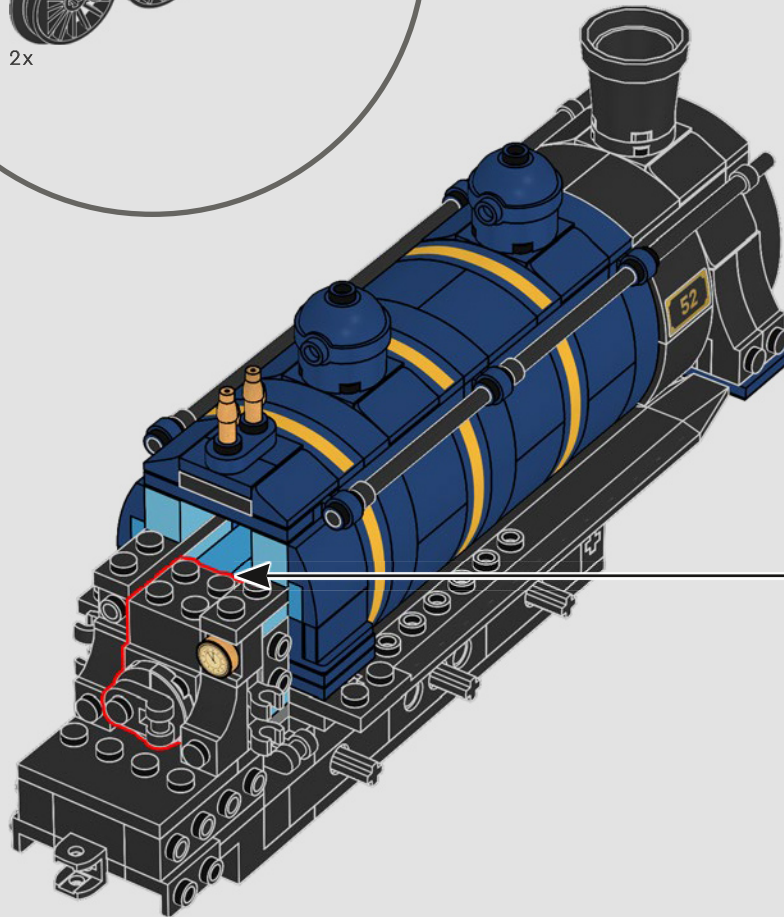

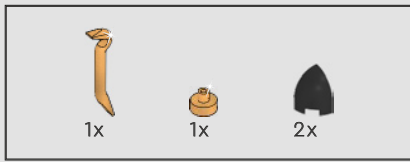

398

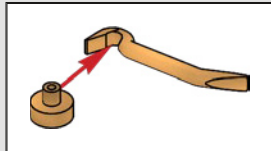
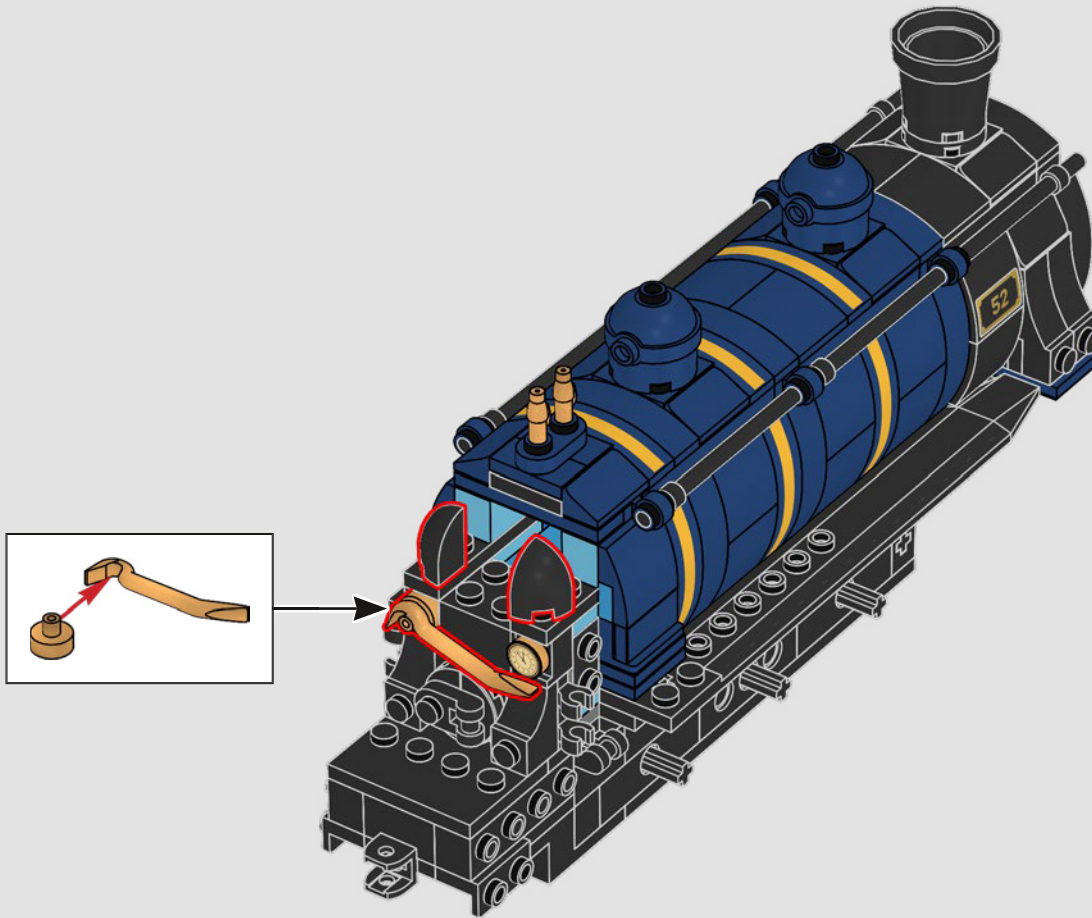

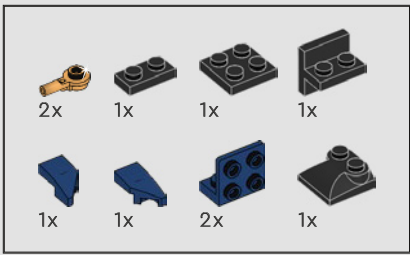

399

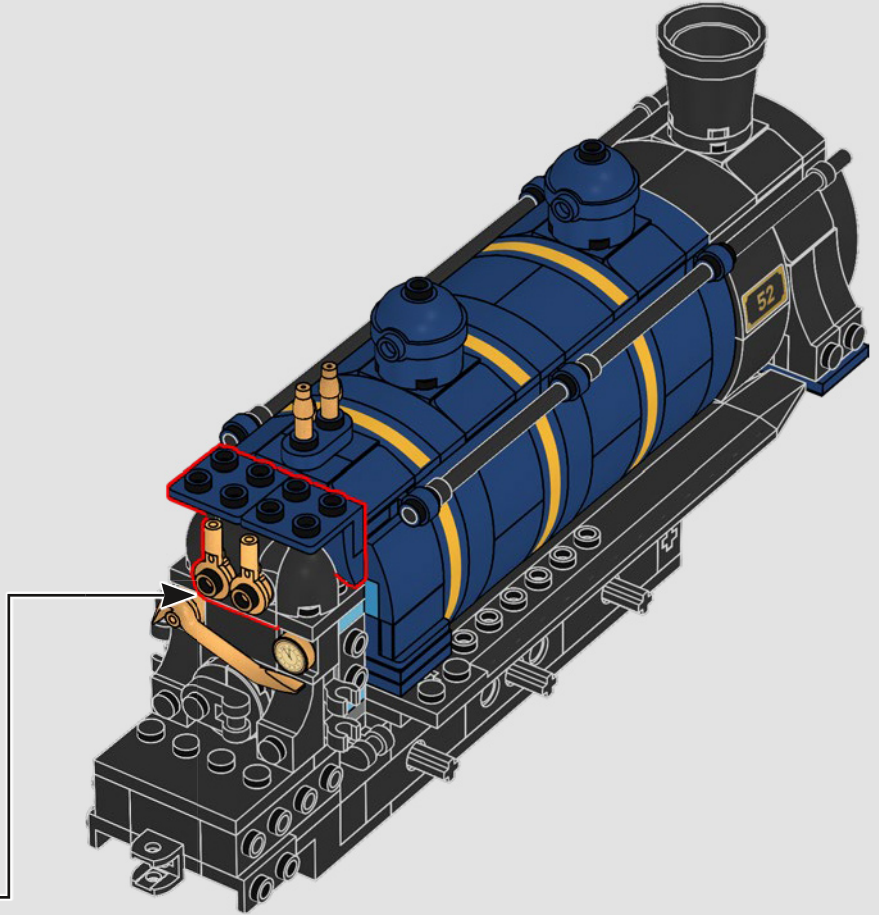
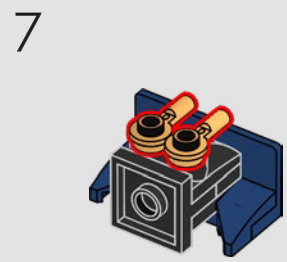
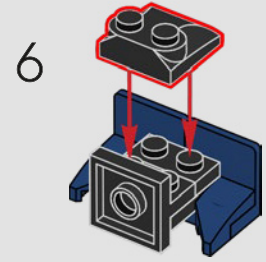
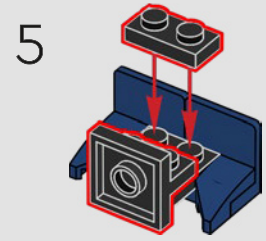
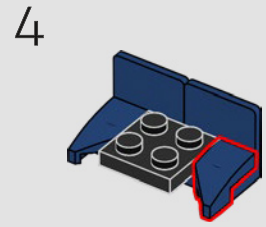
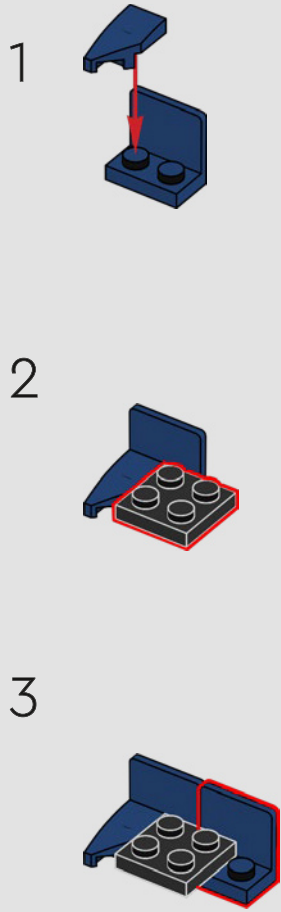

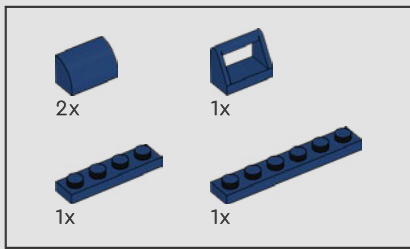

400

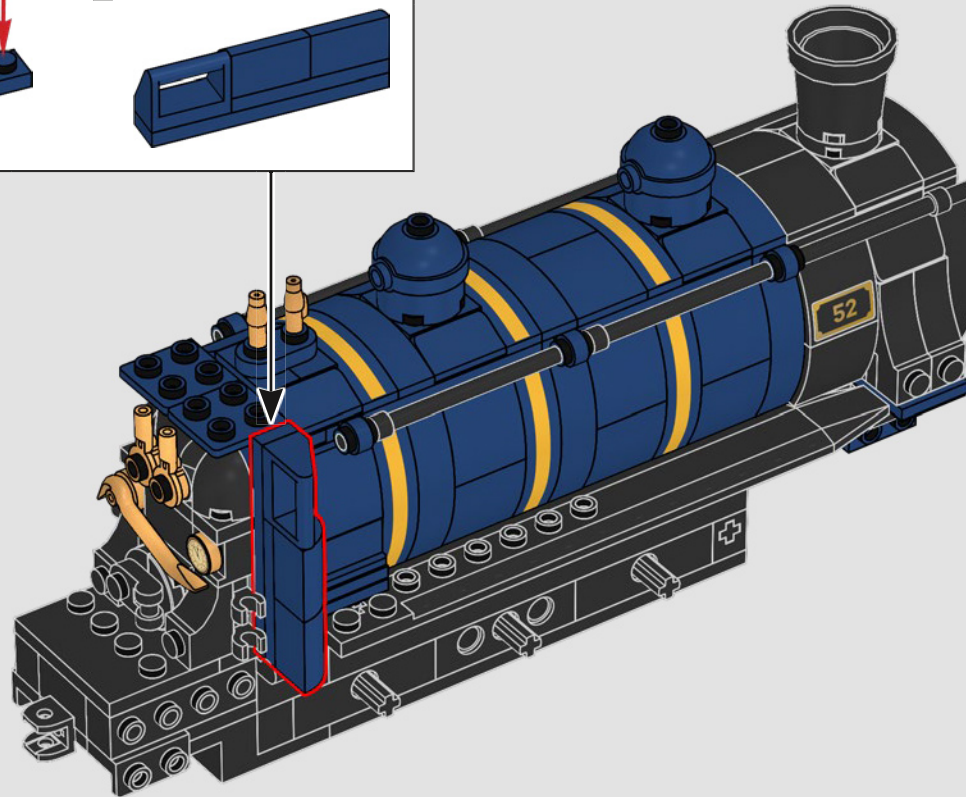
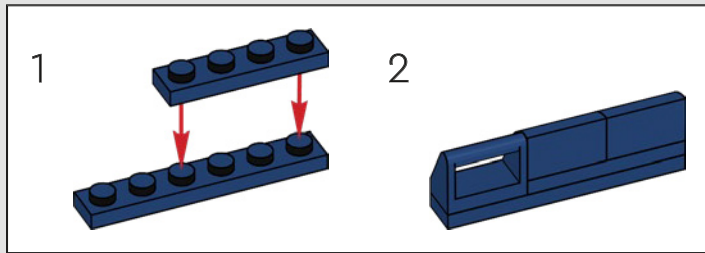



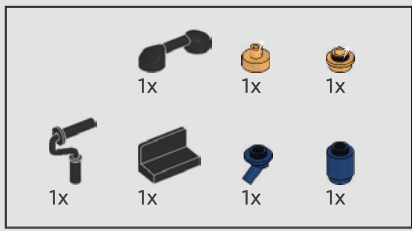

401

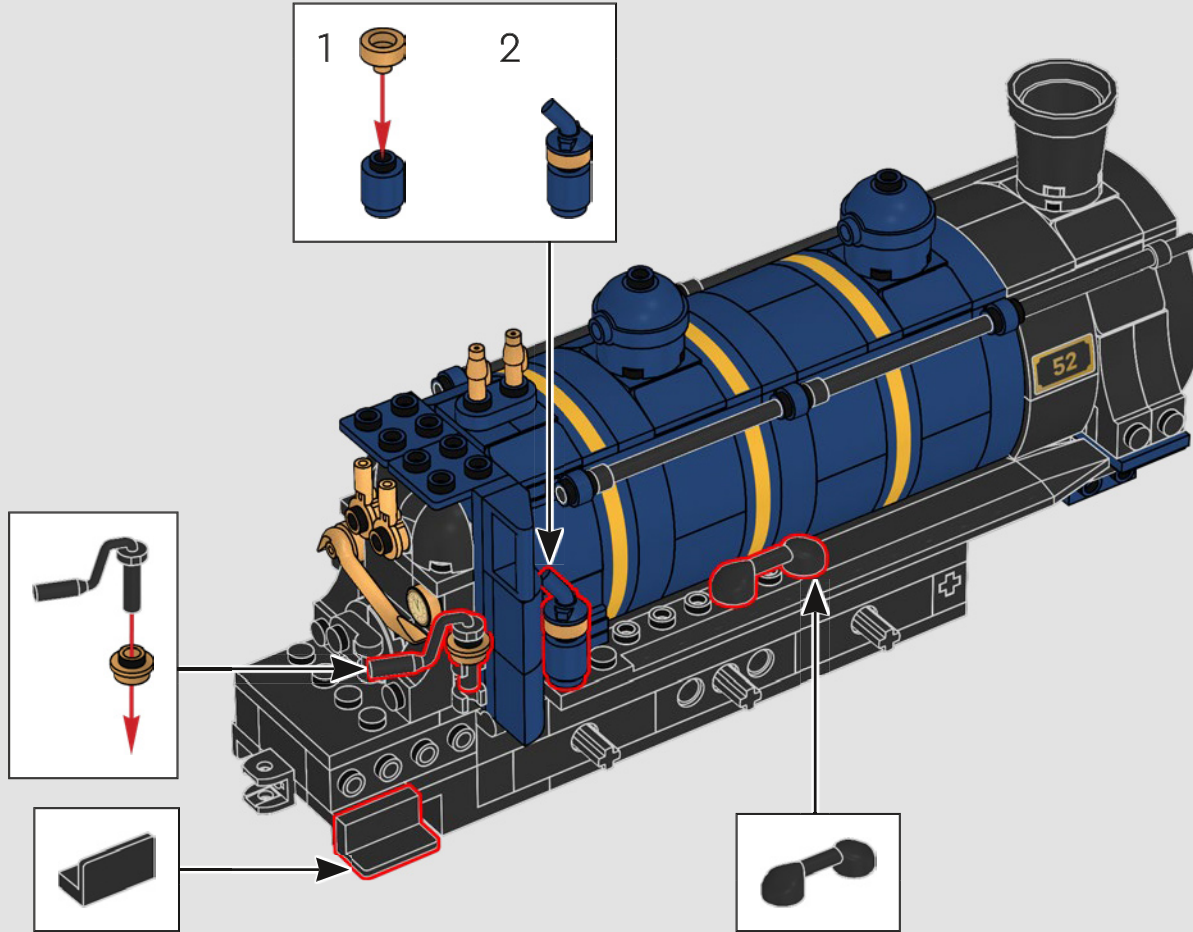

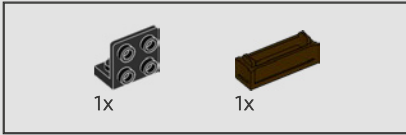
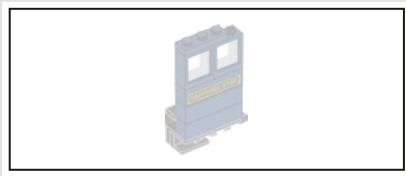

402

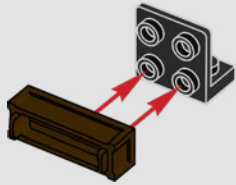

403

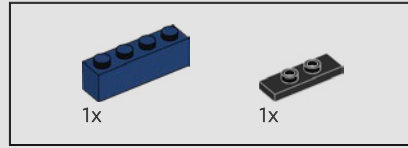
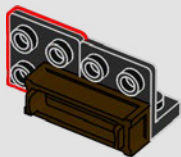

404

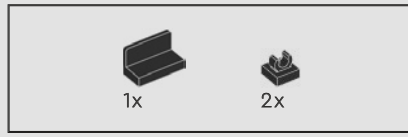
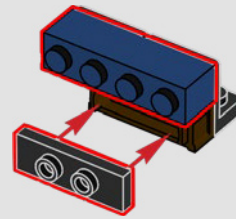

405

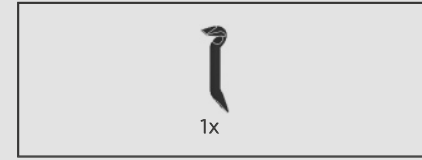
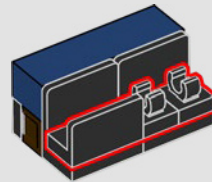

406

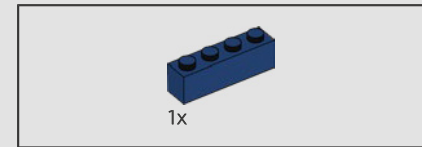
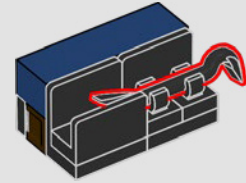

407

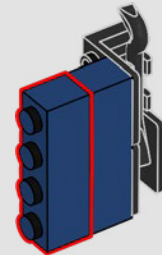
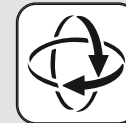

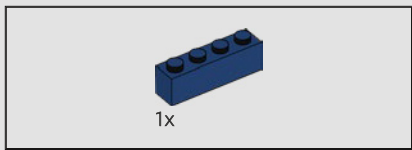

408

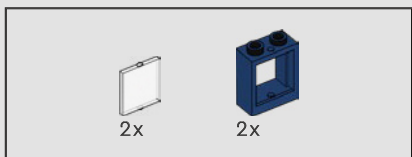
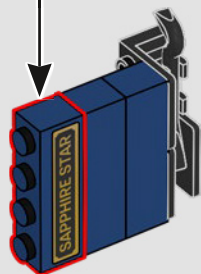
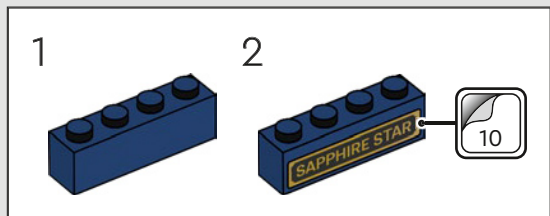

409

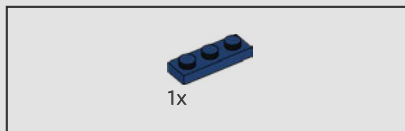
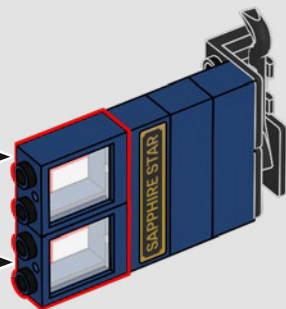
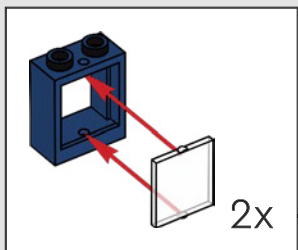

410

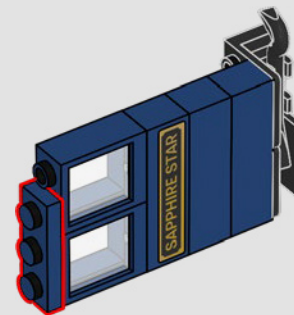

411

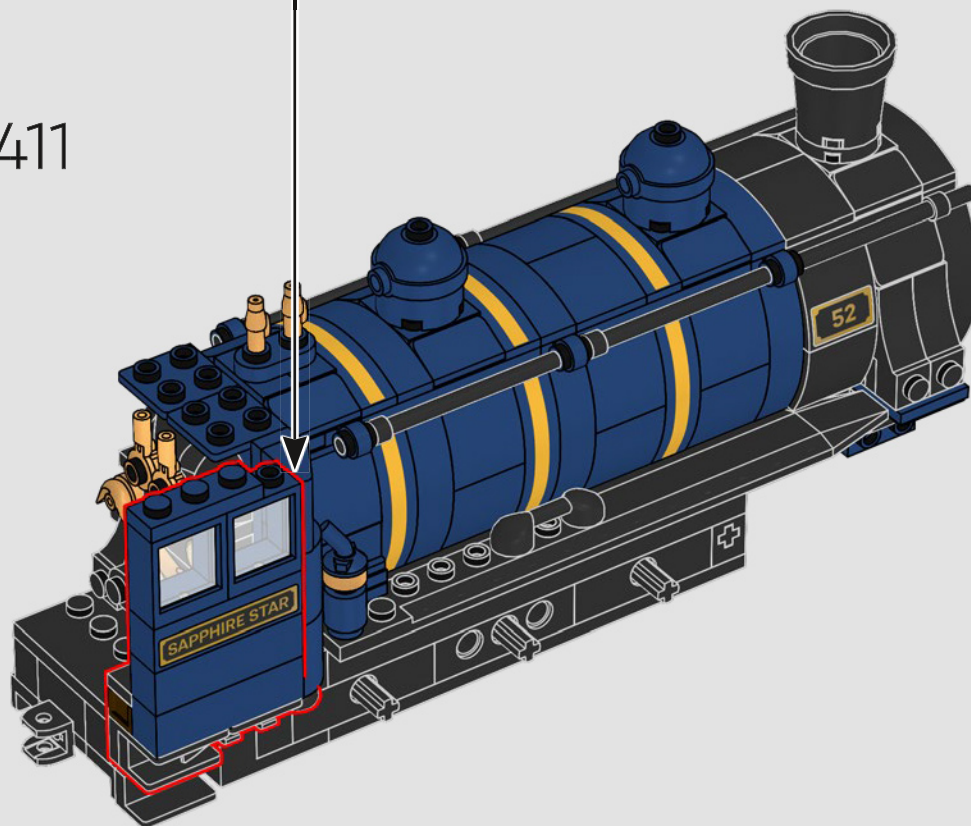

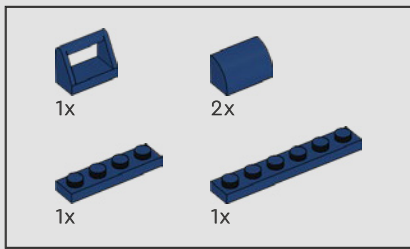

412

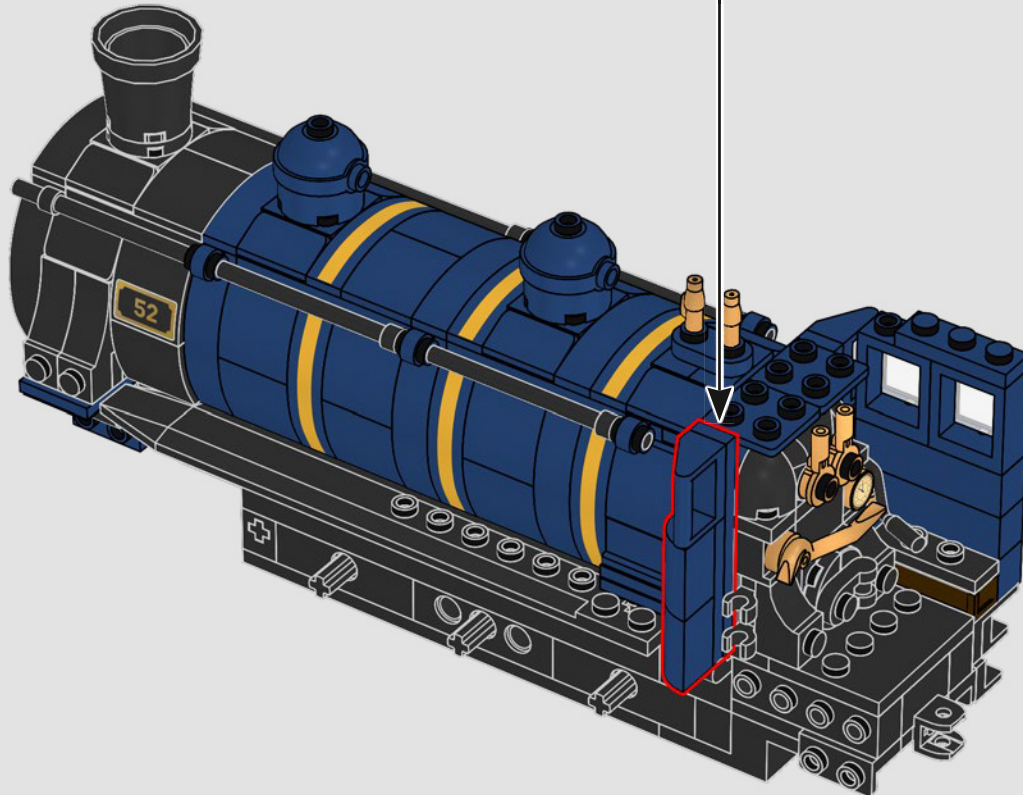
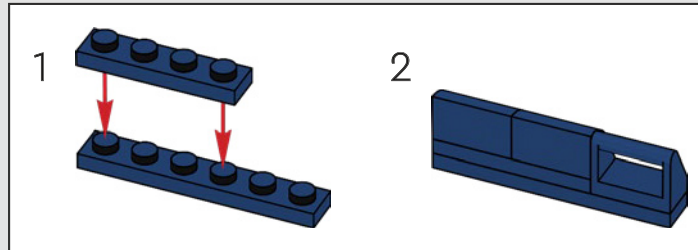



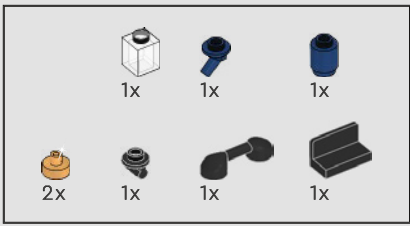

413

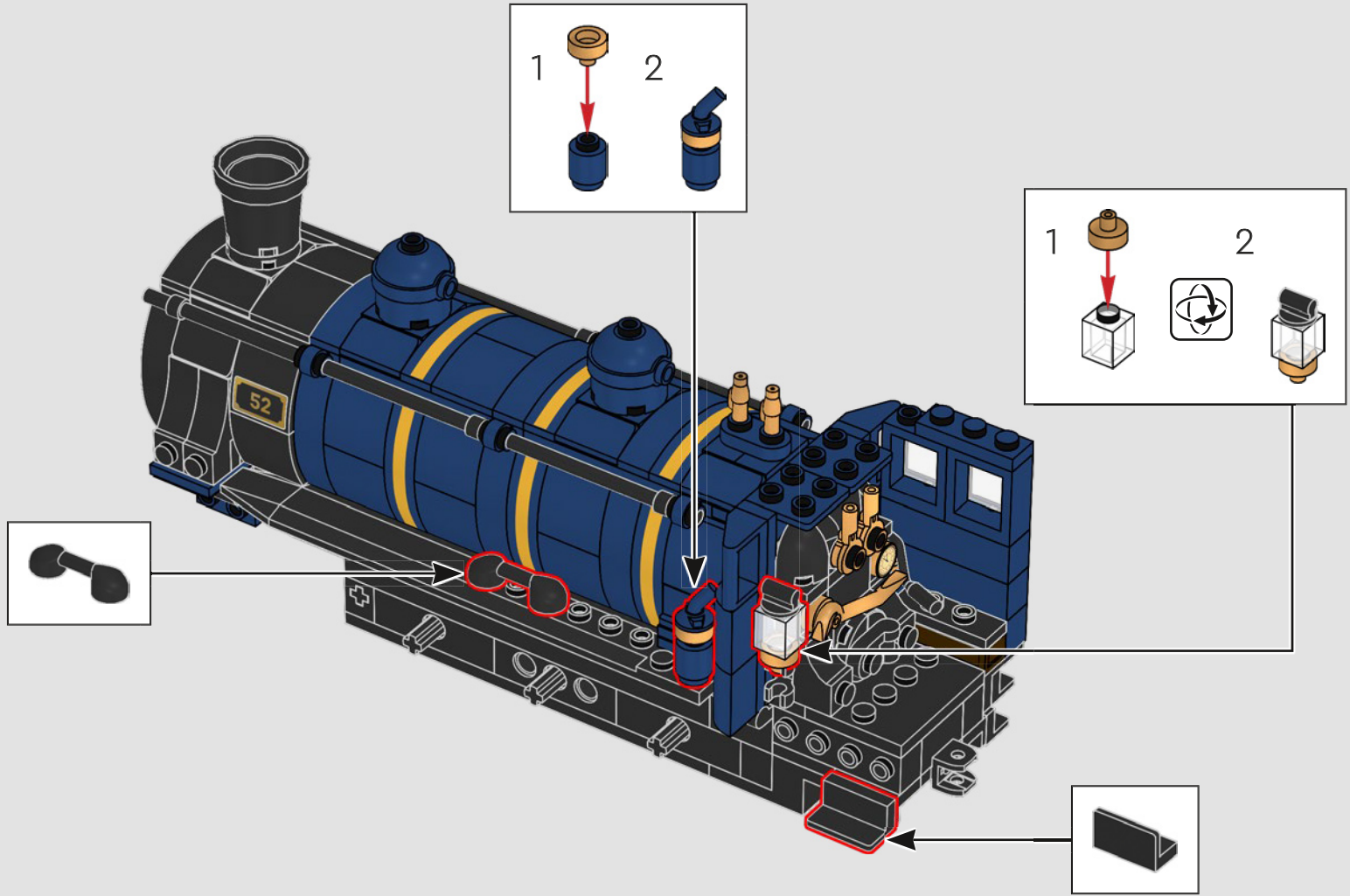

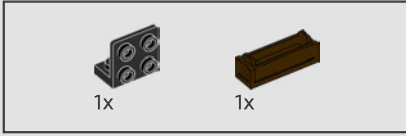
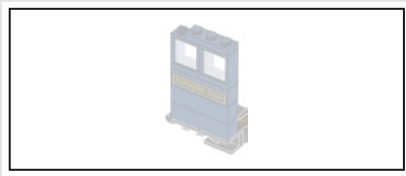

414

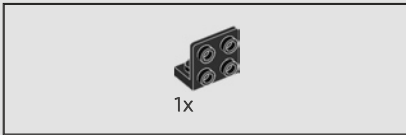
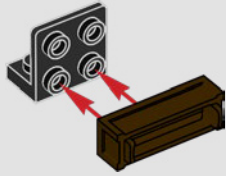

415

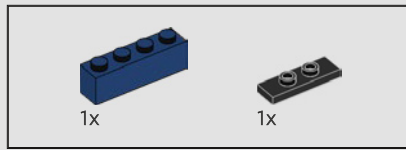
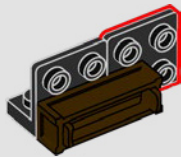

416

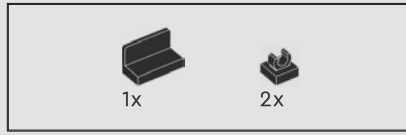
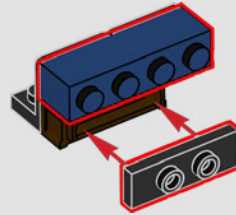

417

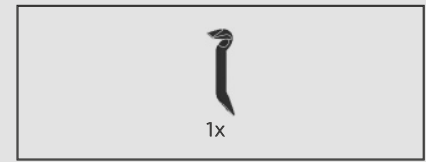
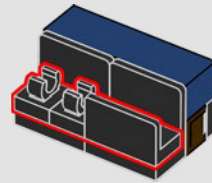

418

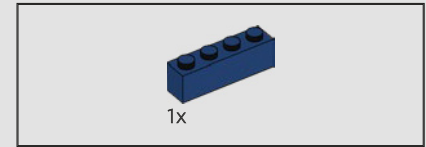
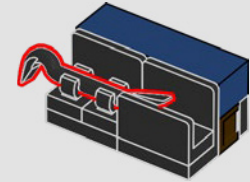

419

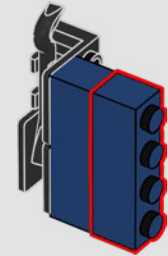

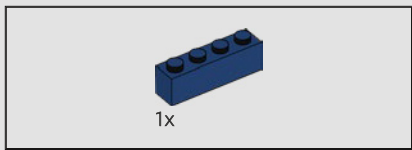

420

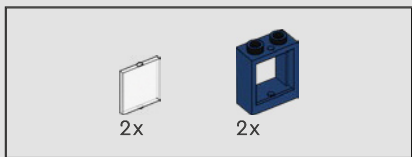
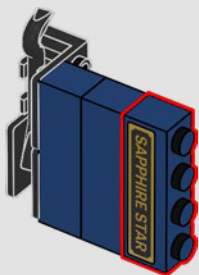
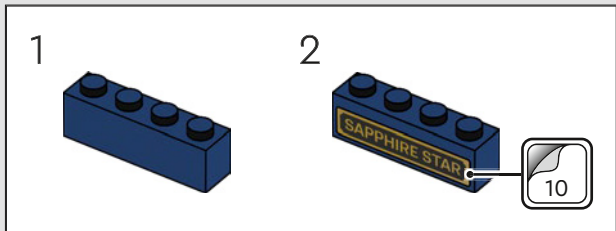

421

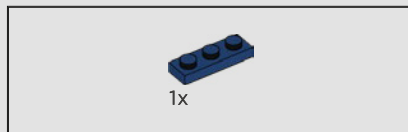
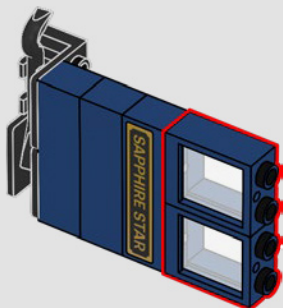
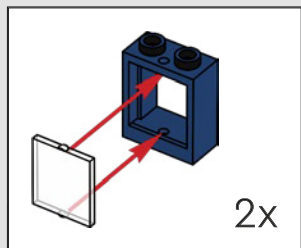

422

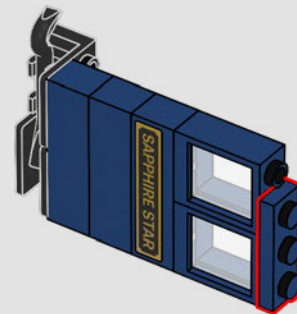

423

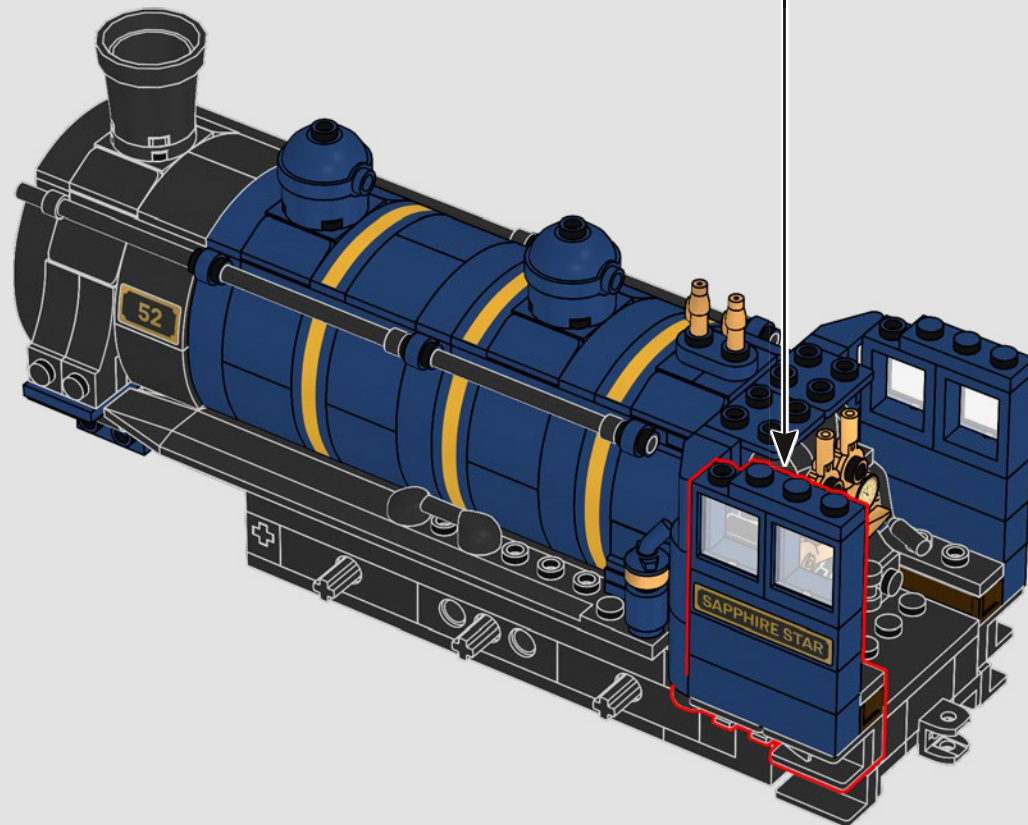

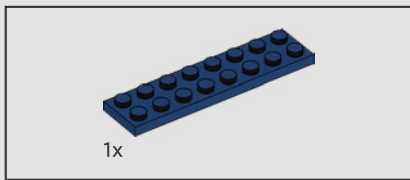

424

.....●  
"La Sapphire Star – che gioiello!  
Mi ricorda un treno notturno che  
presi anni fa sull'Isola di Smeraldo".

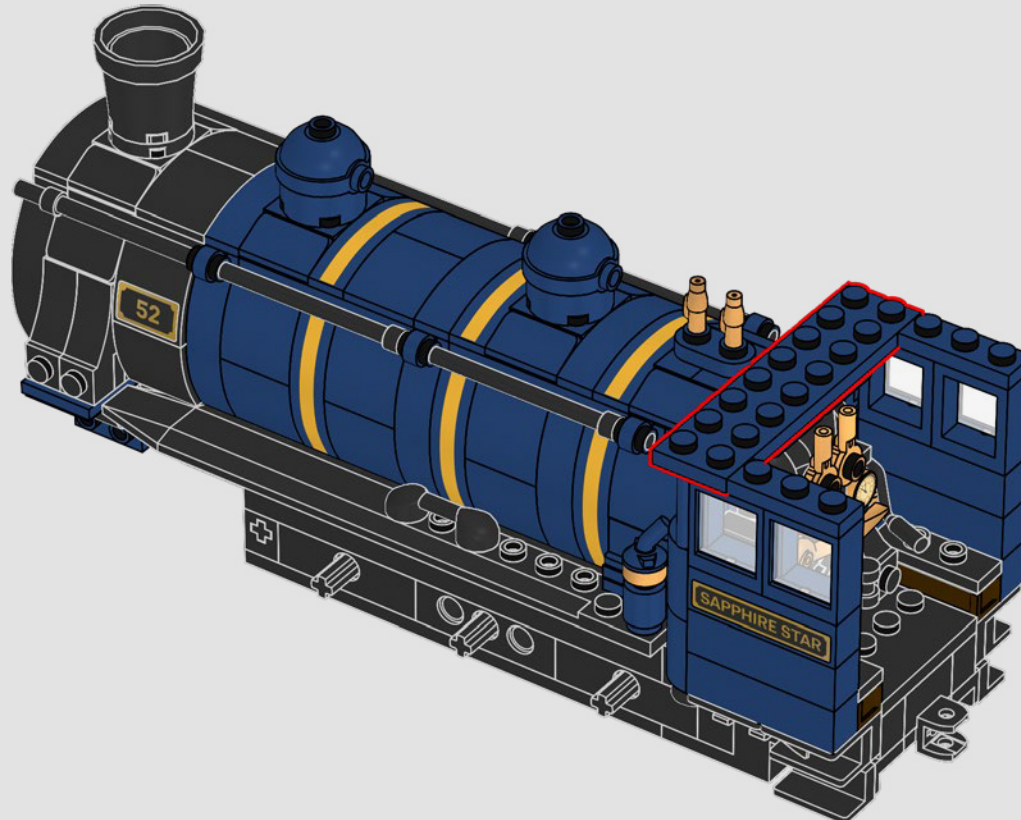



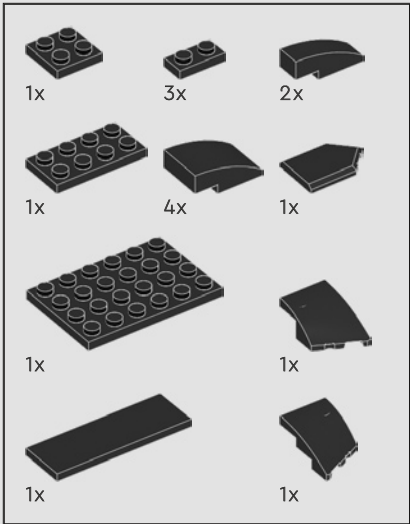

425

1

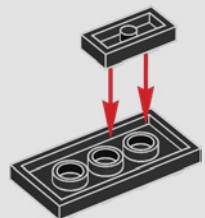

2

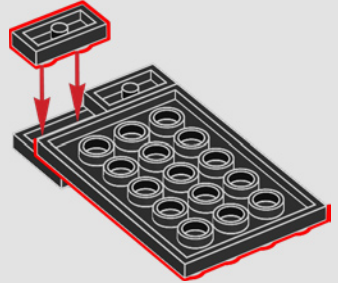

3

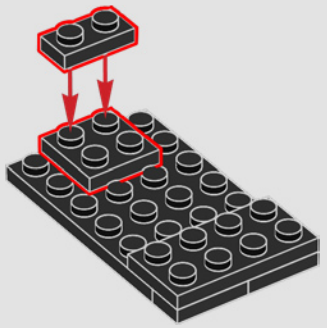

4

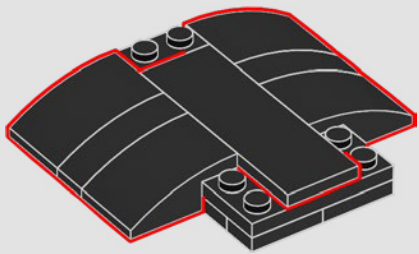

5

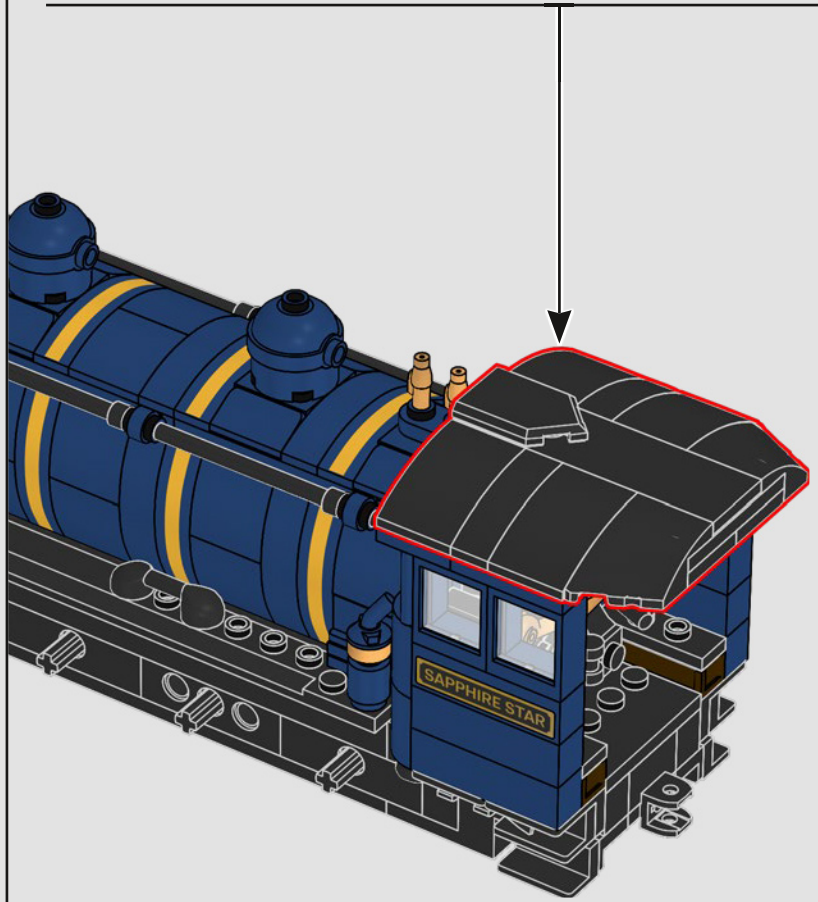
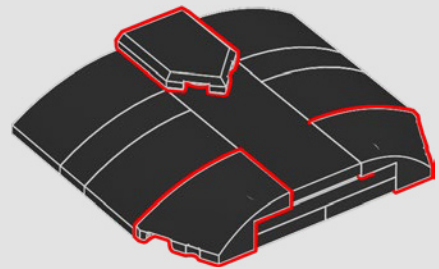

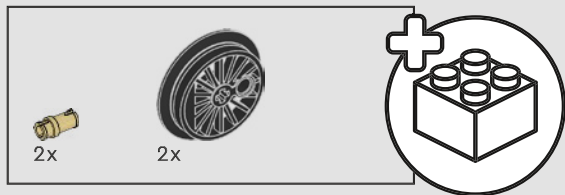

426

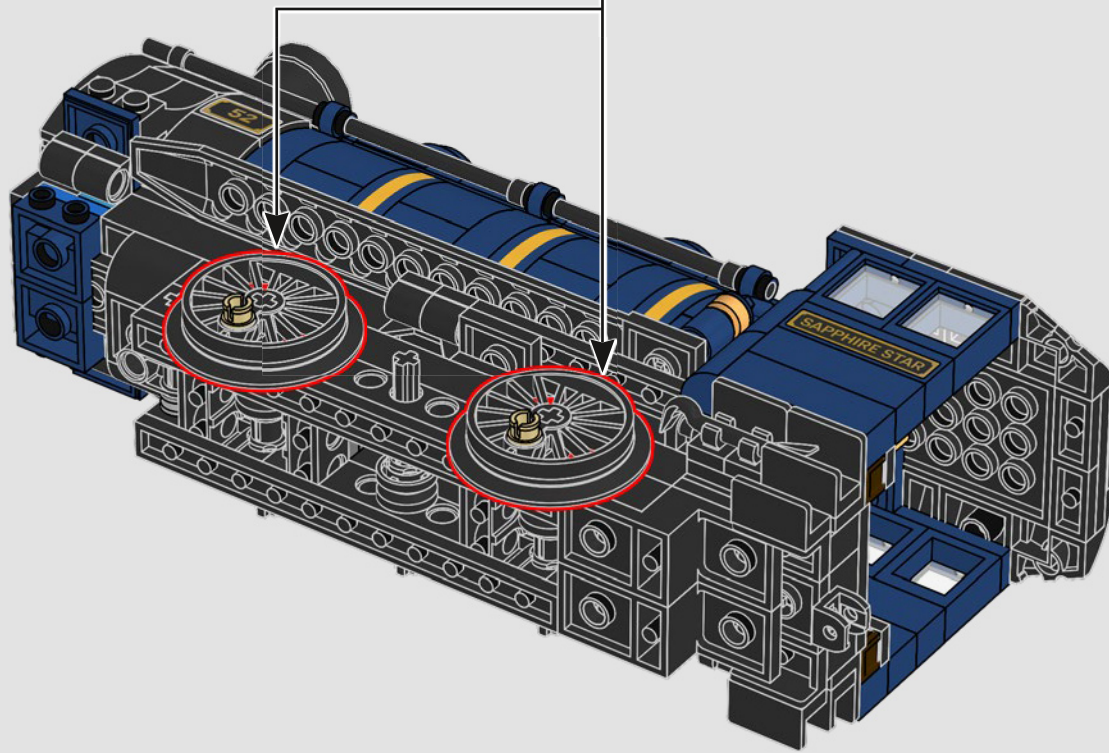
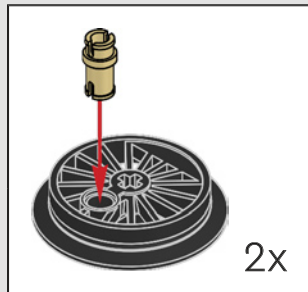

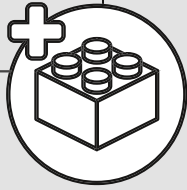

427

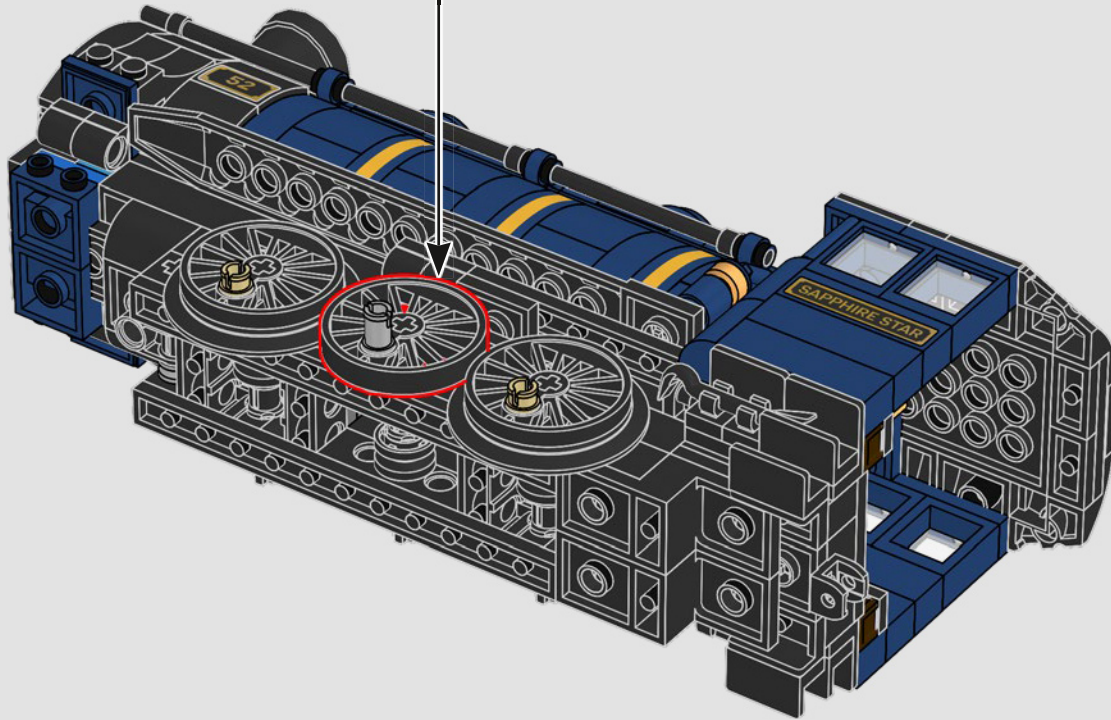
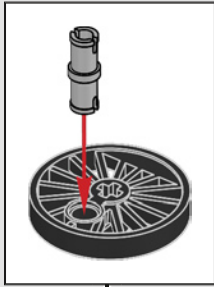

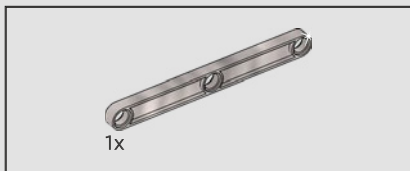

428

..... ●  
"Queste aste di accoppiamento argentate sono di nuova concezione, appositamente create per questa locomotiva".

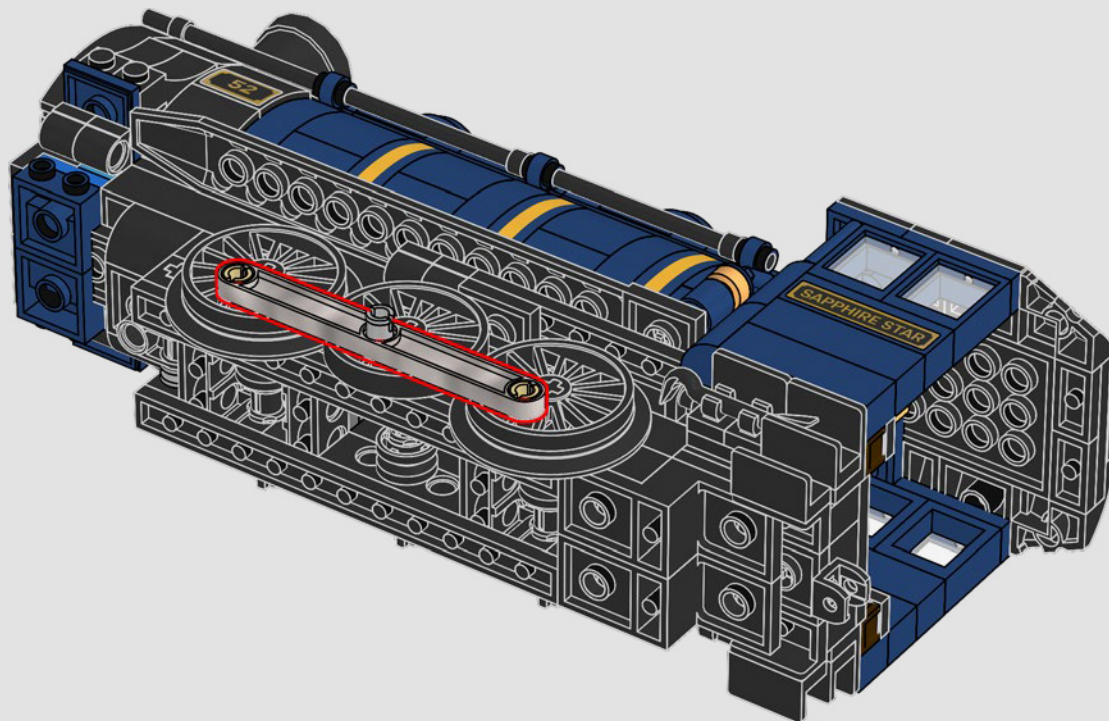





429

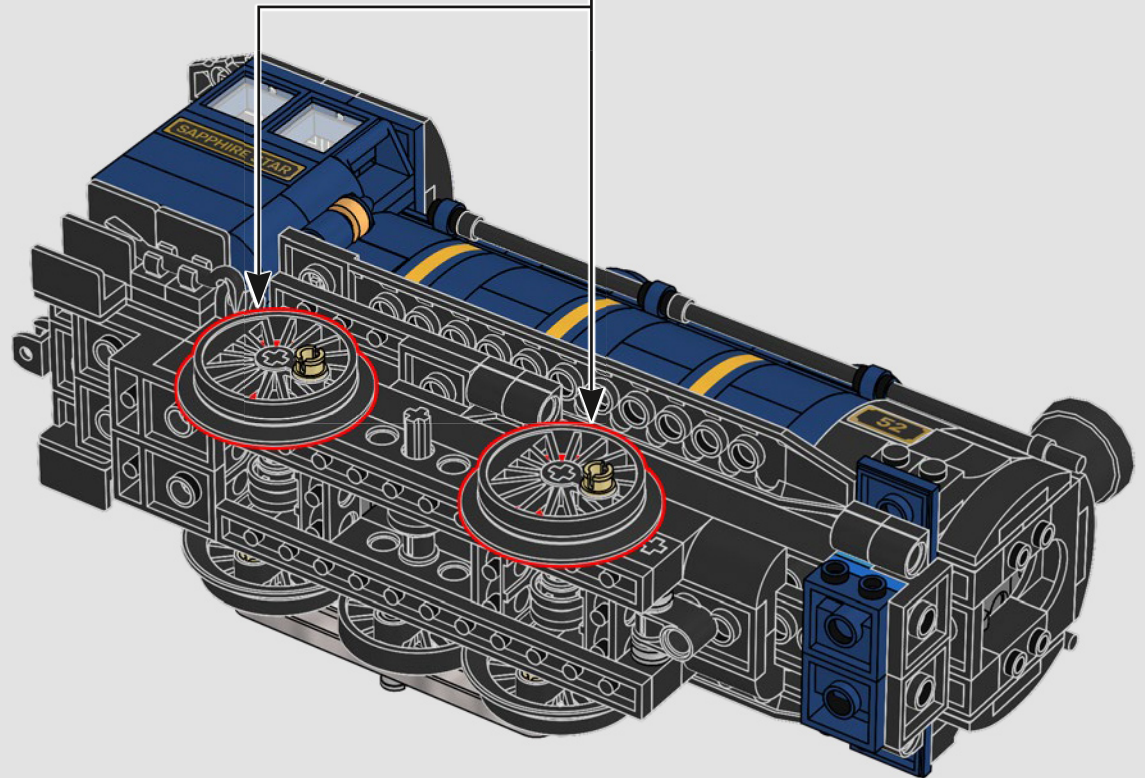
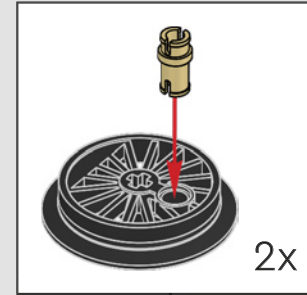
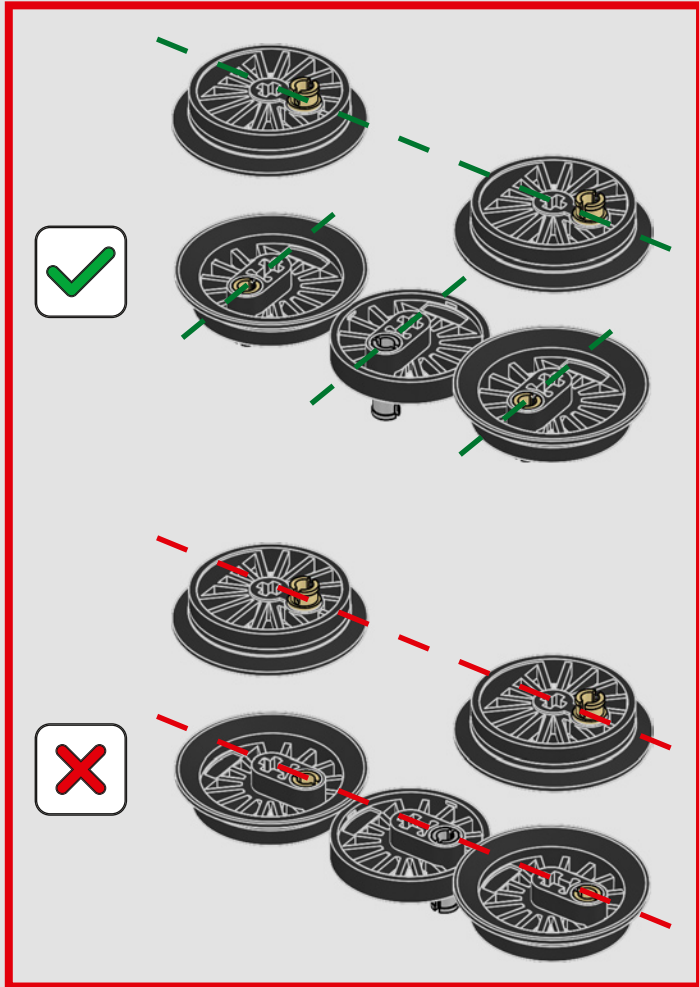



430

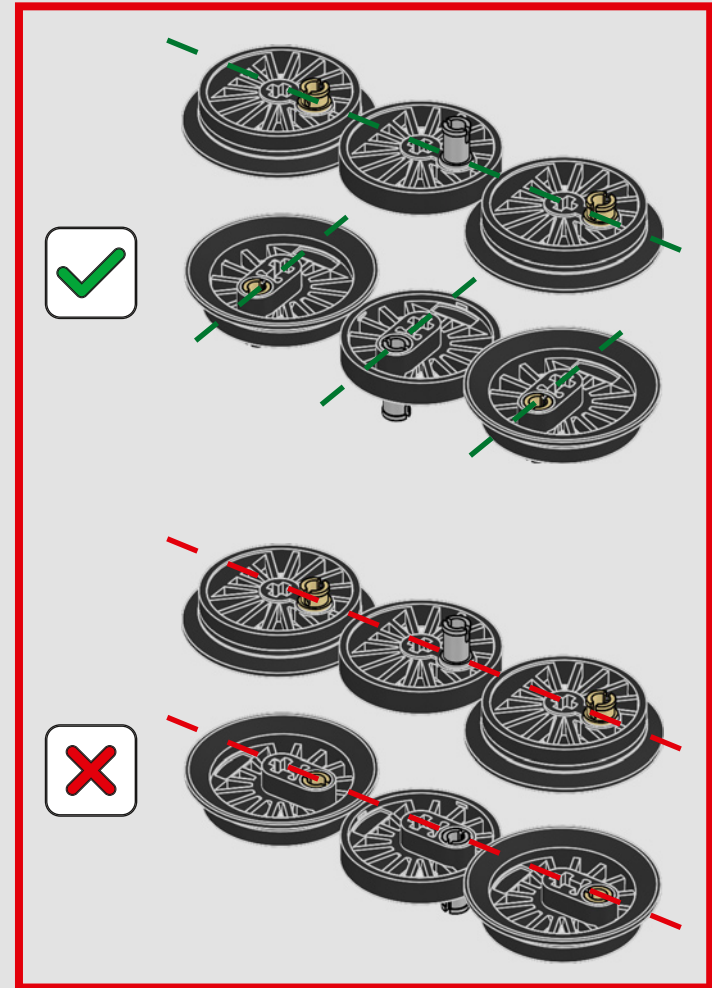
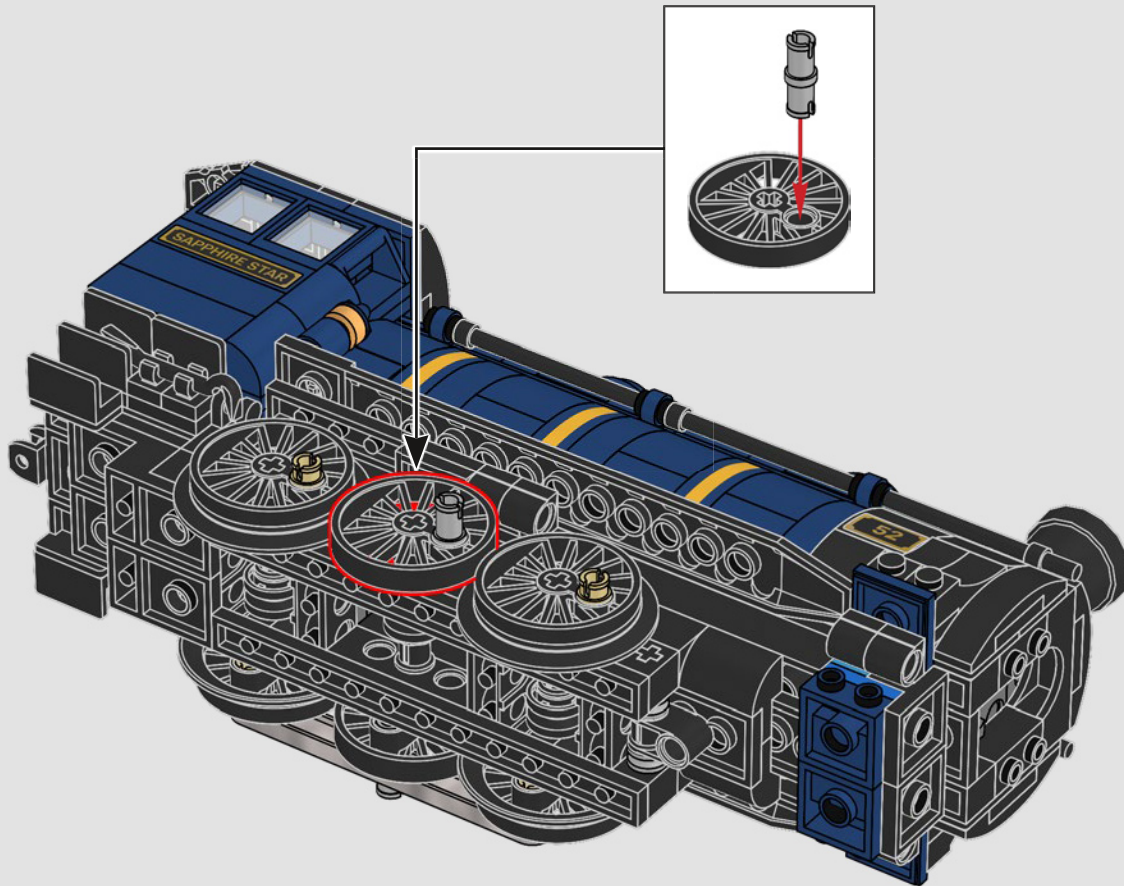

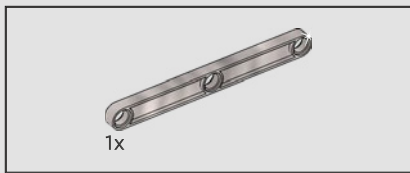

431

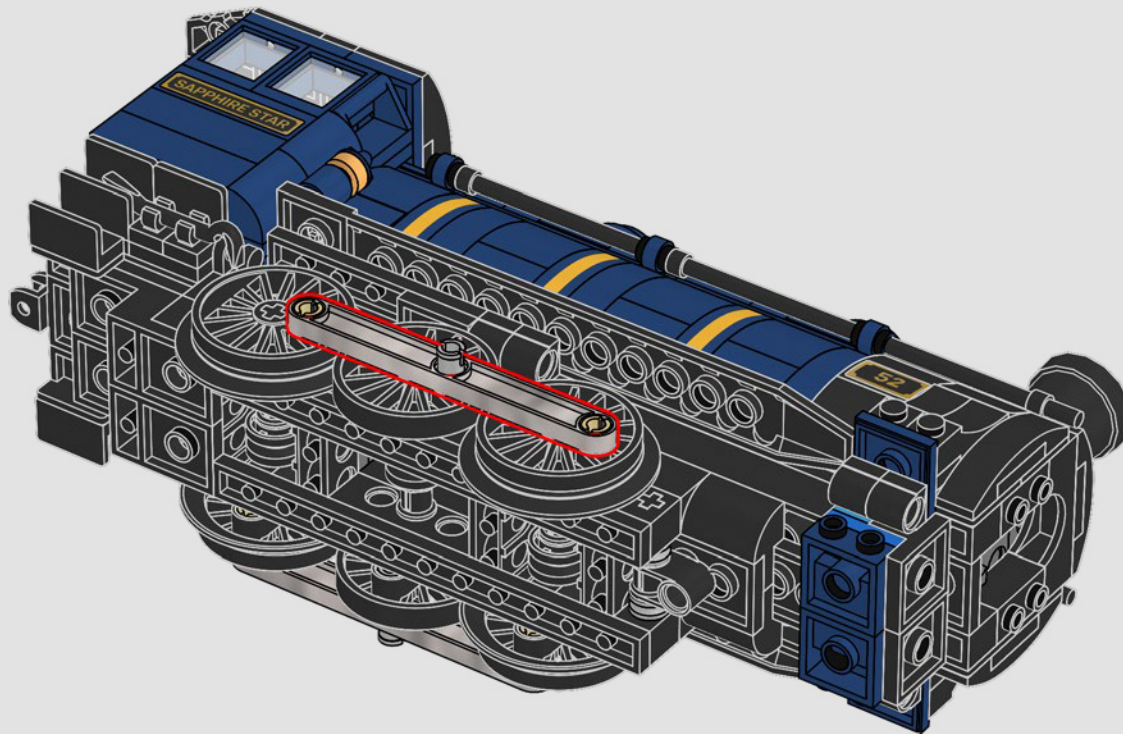



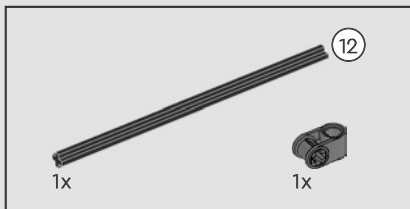

432

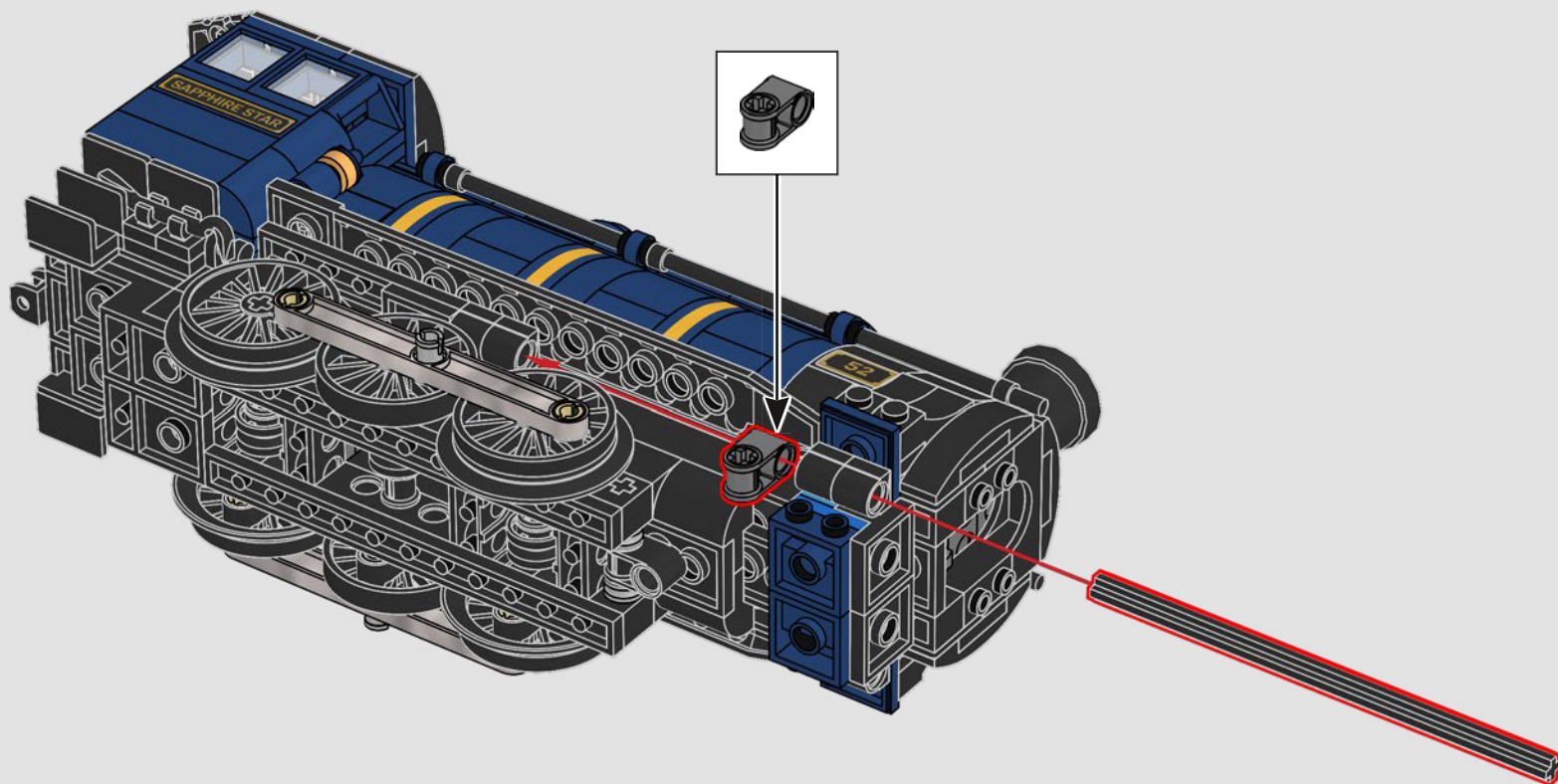



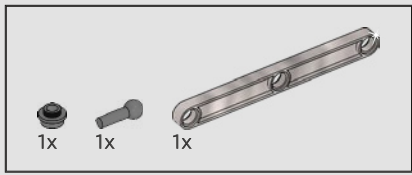

433

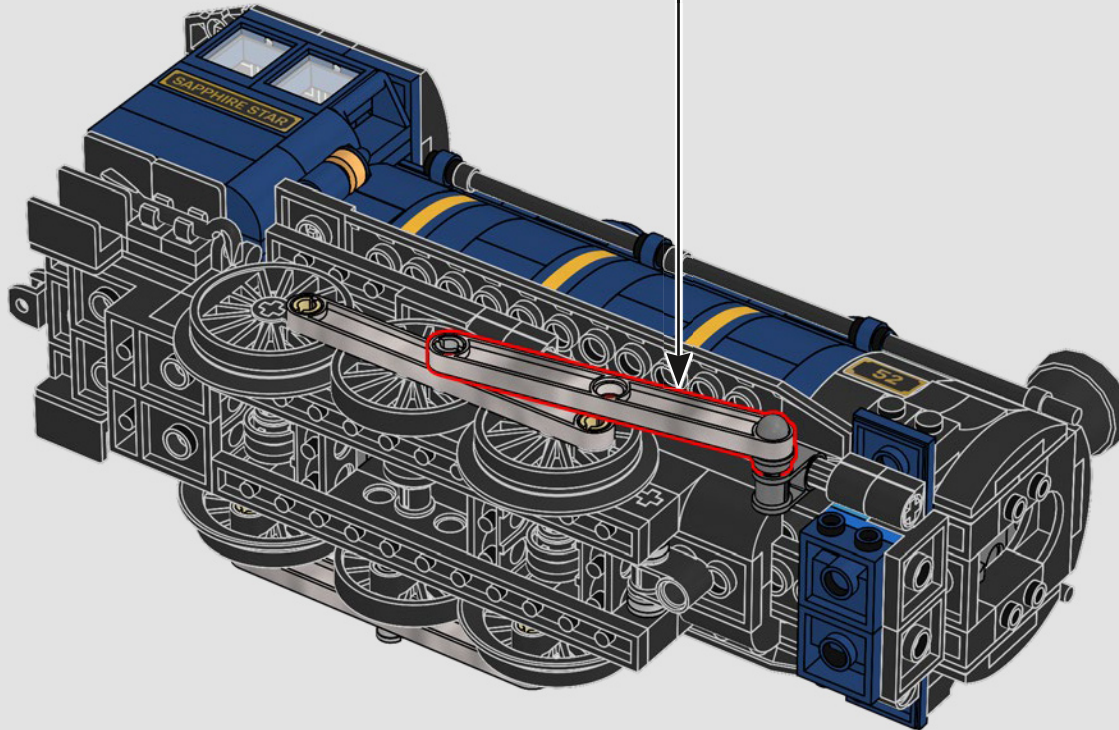
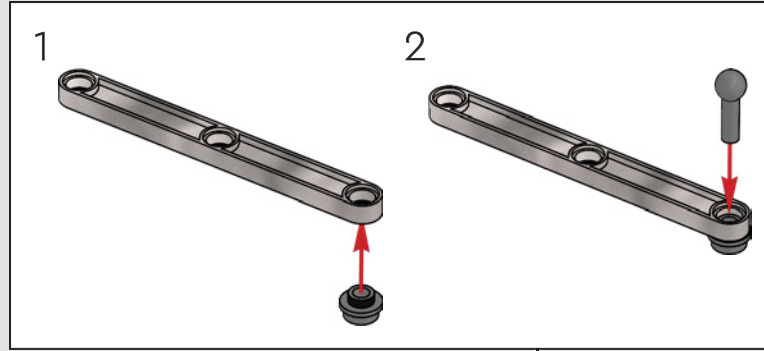

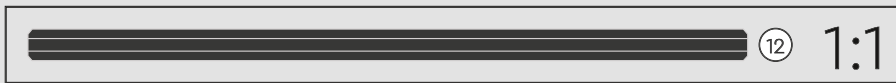
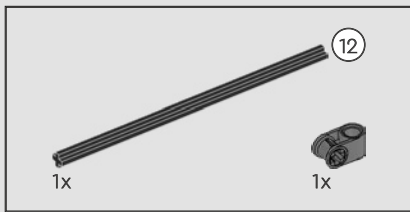

434

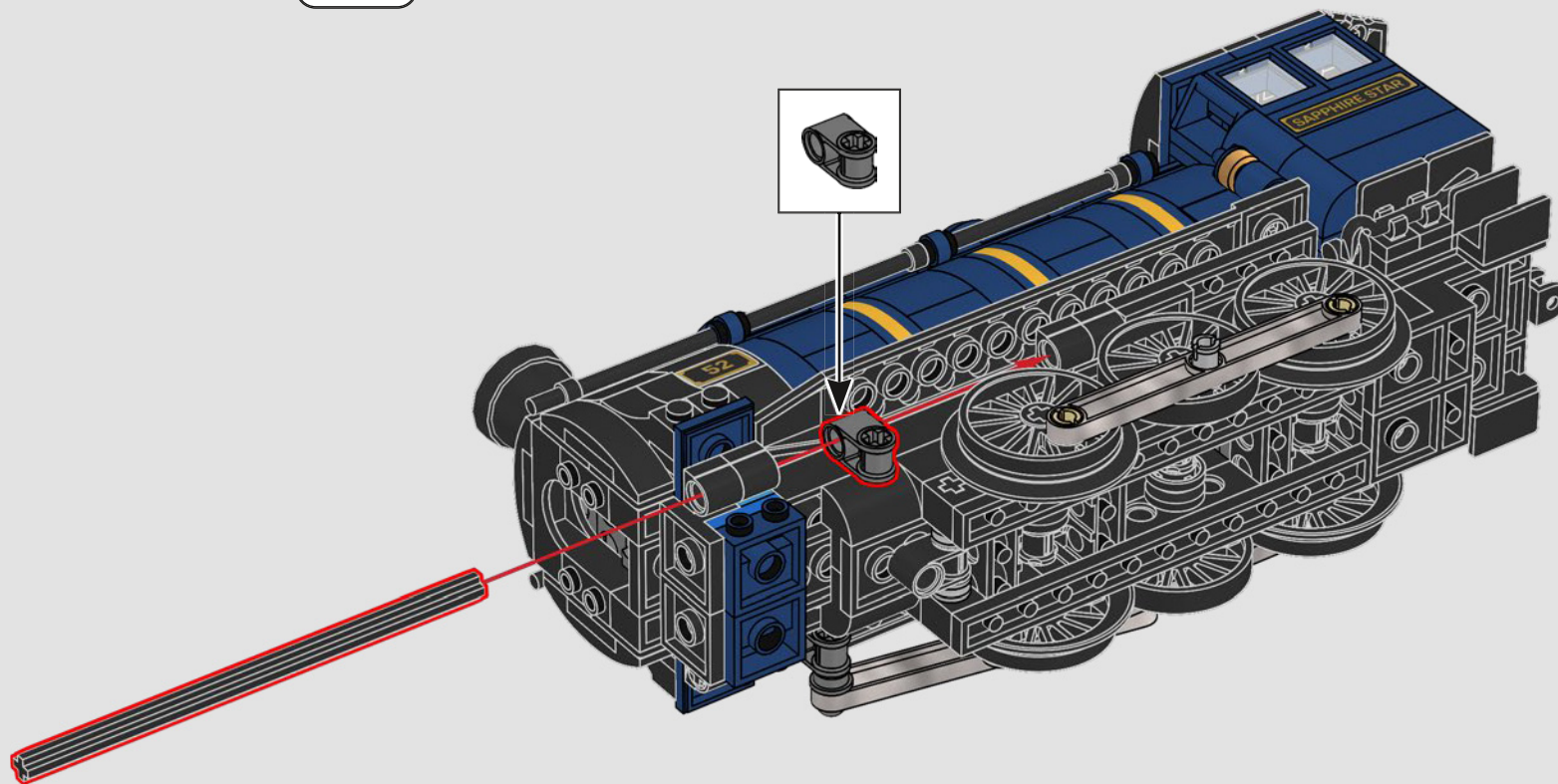

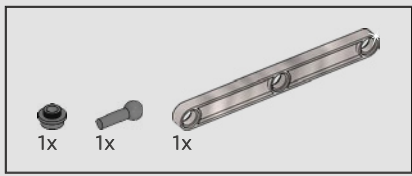

435

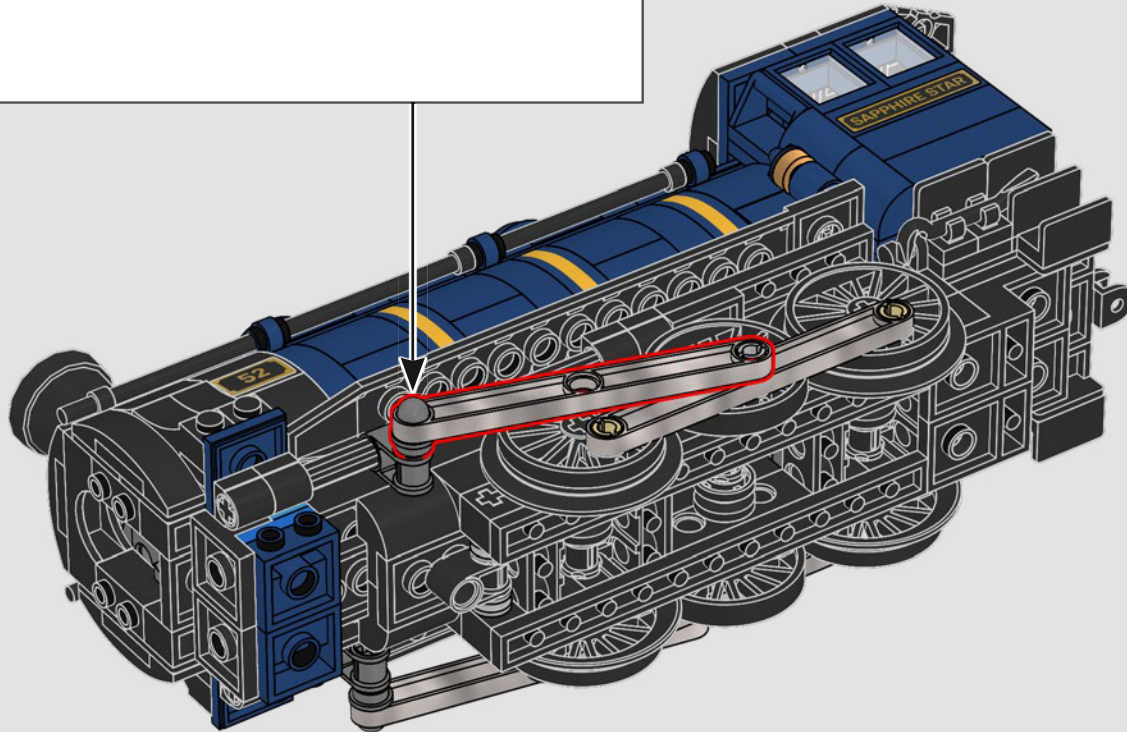
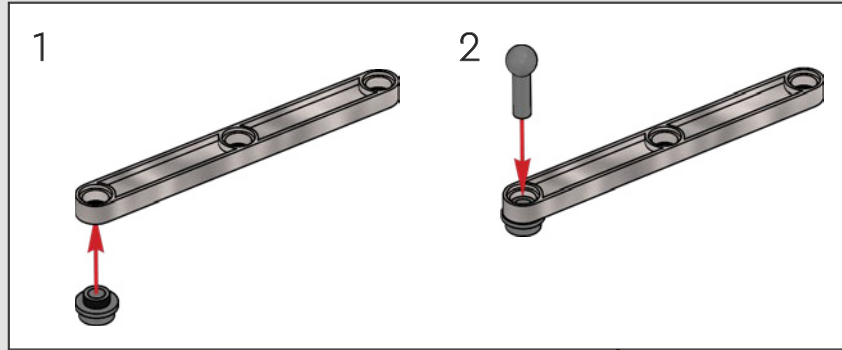

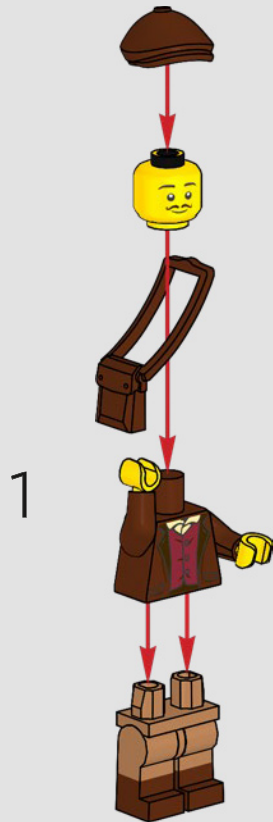
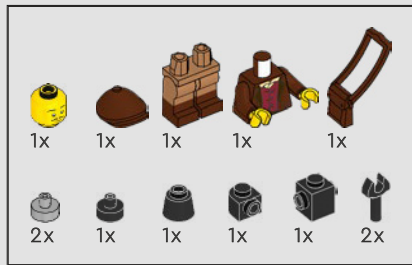

1

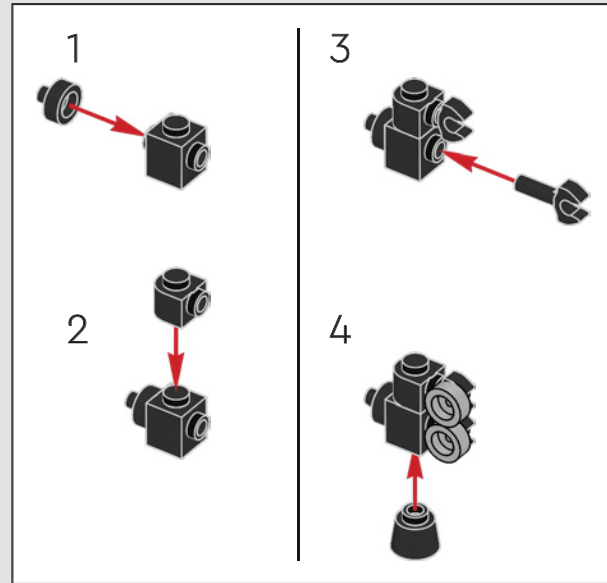

2





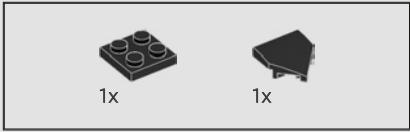
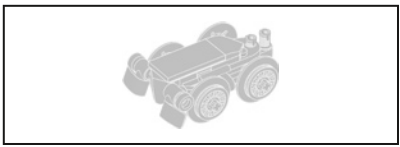

436

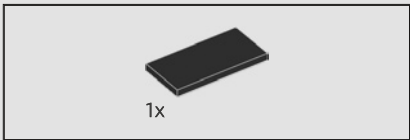
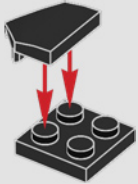

437

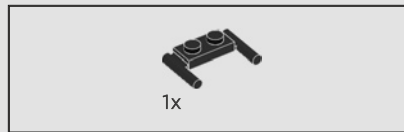
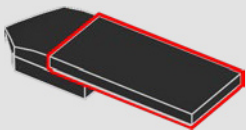

438

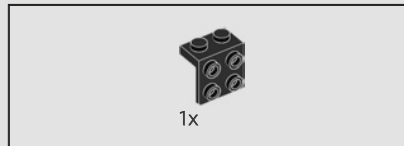
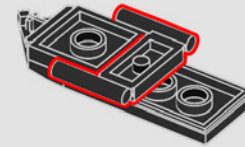

439

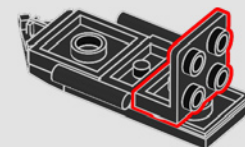

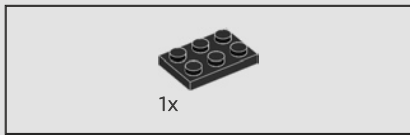

440

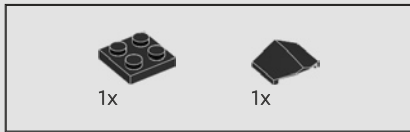
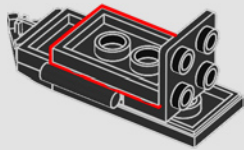

441

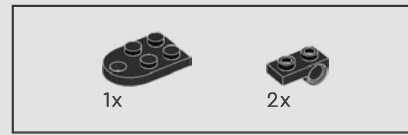
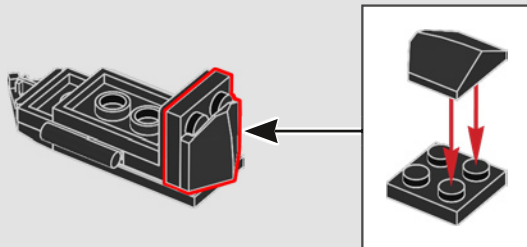

442

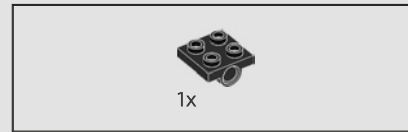
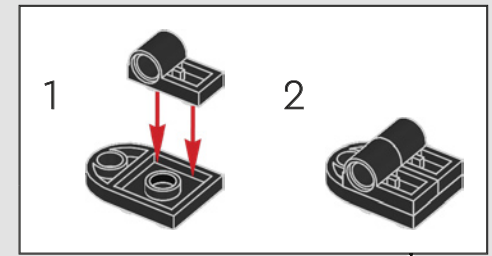
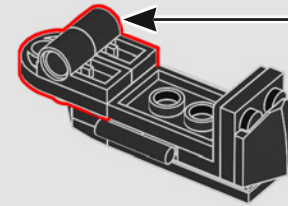

443

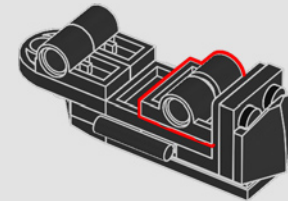

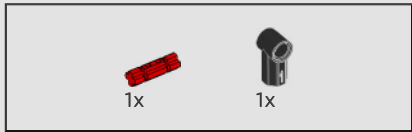
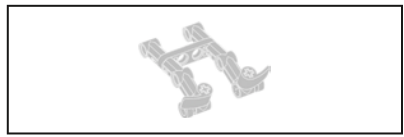

444

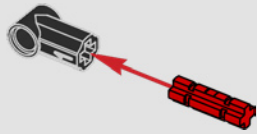

445

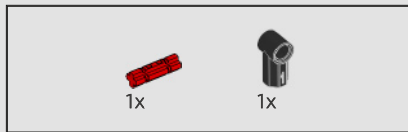

446

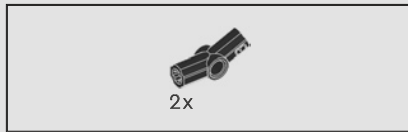
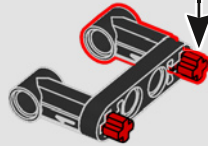
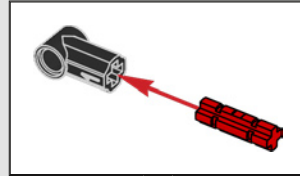

447

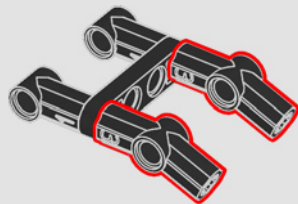

448

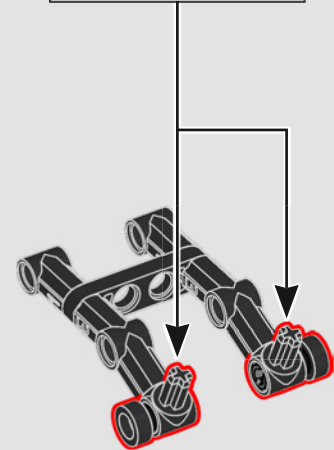
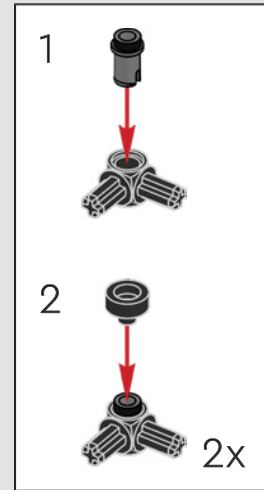



449

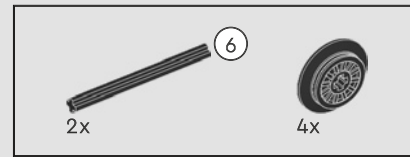
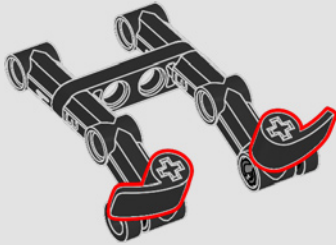

451

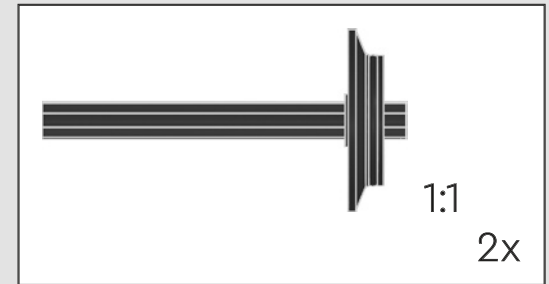
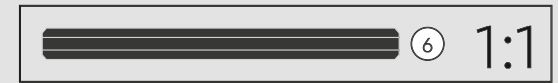

450

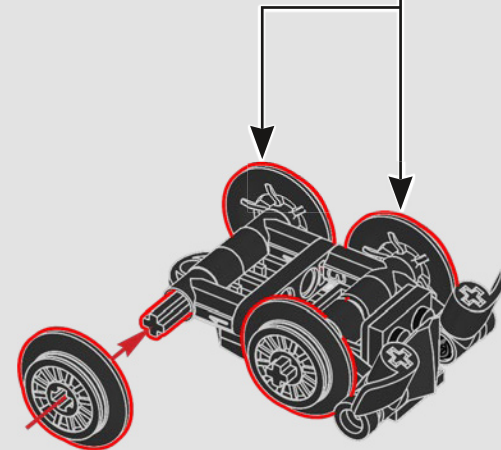
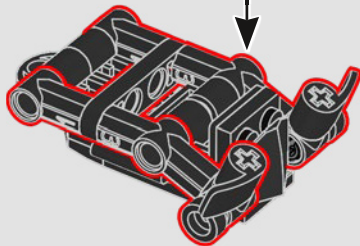



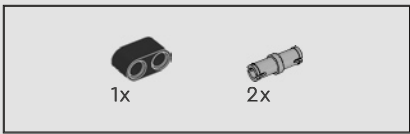

452

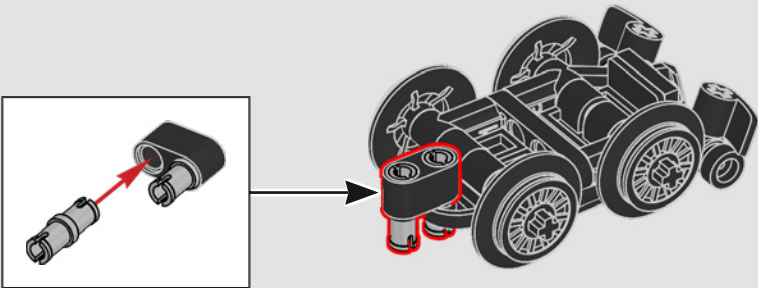

453

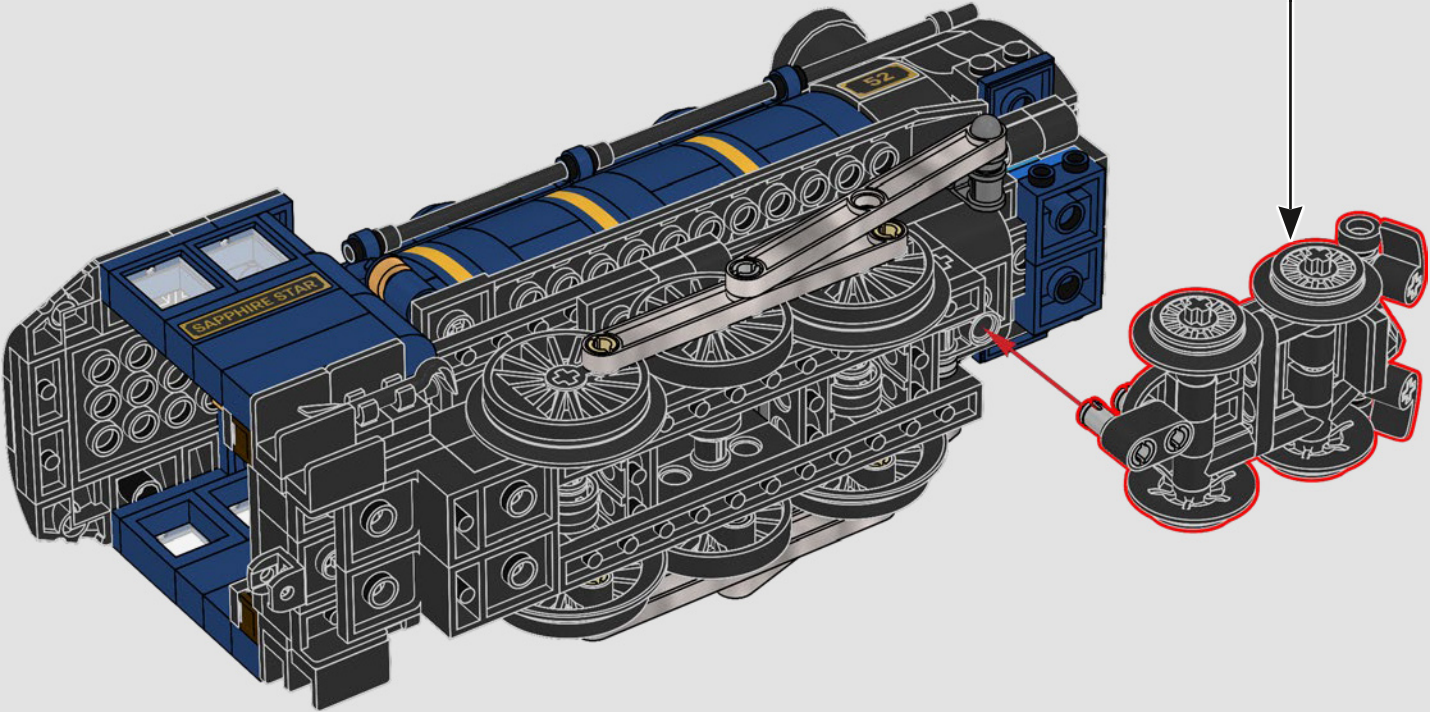

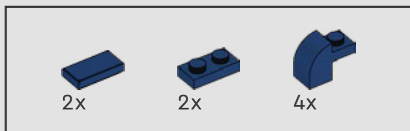

454

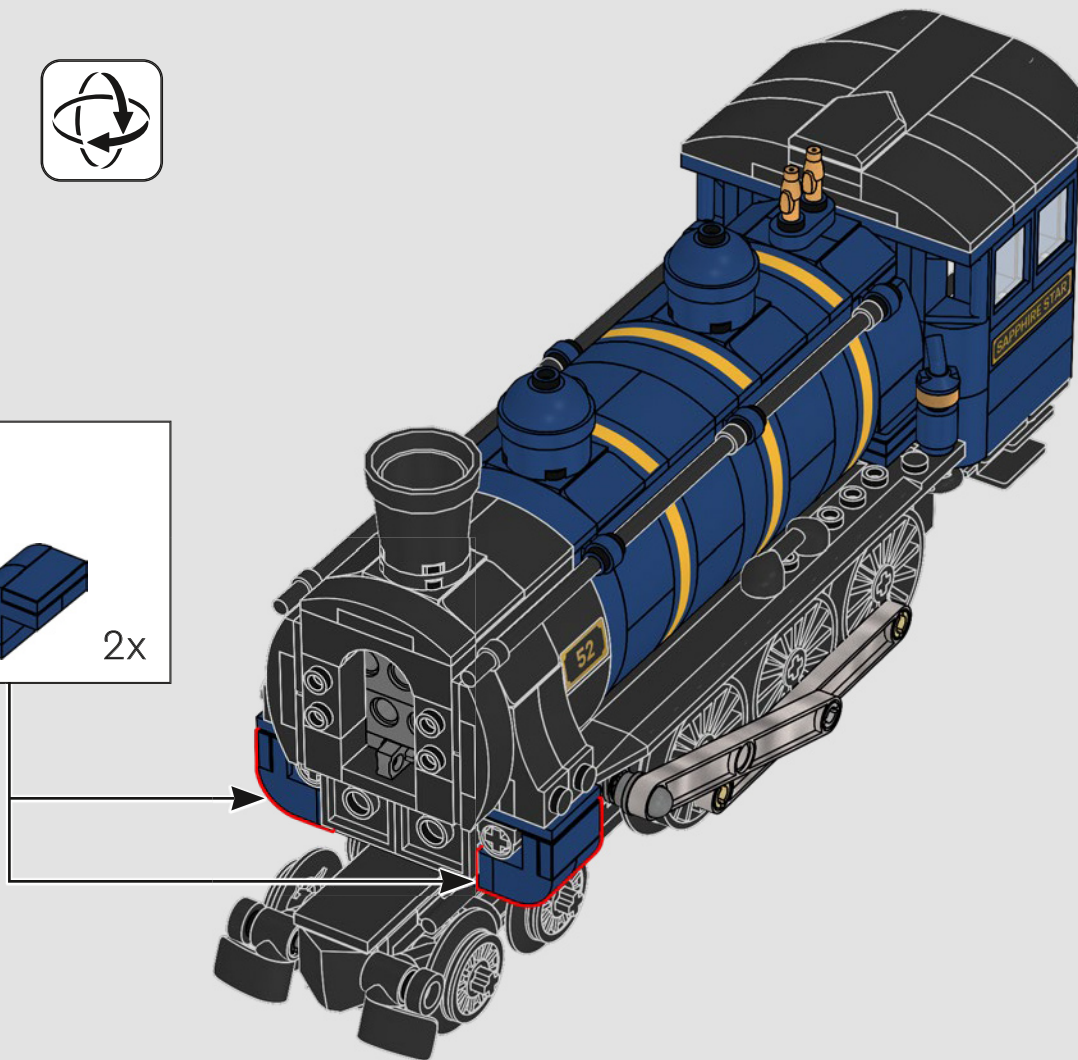
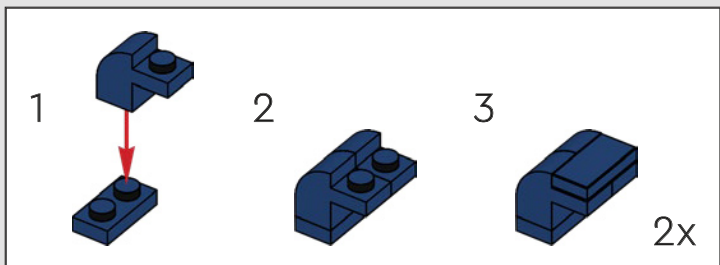

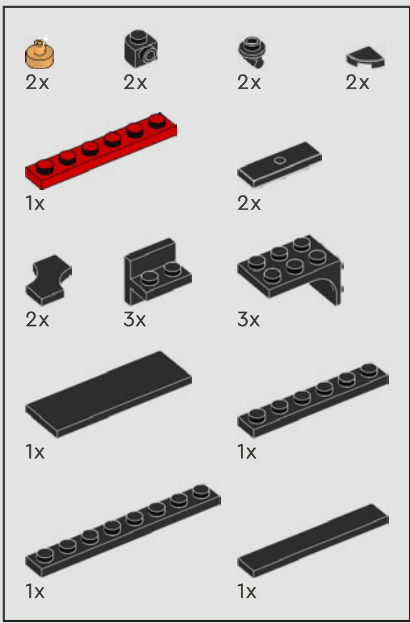

455

1

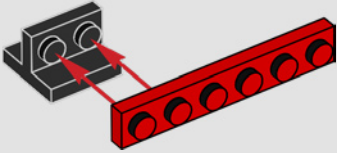

2

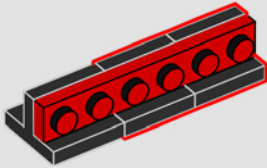

3

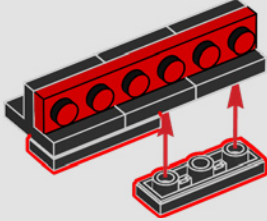

4

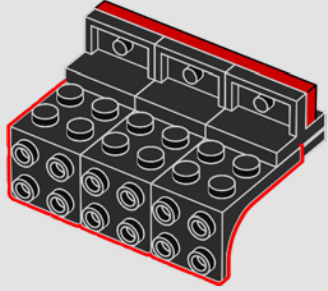

5

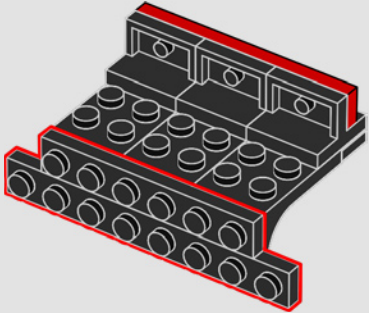

6

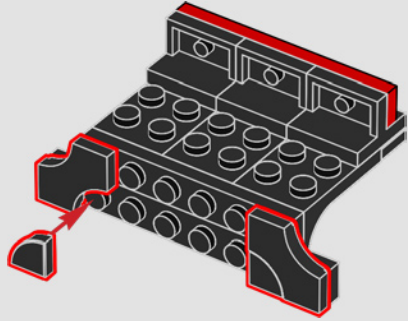

7

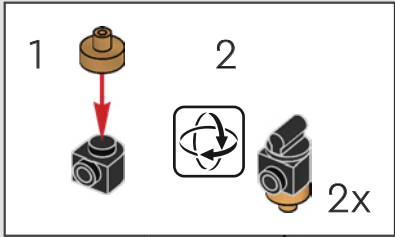
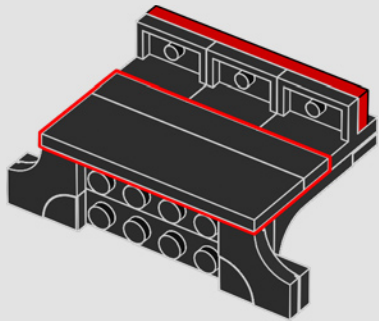

8

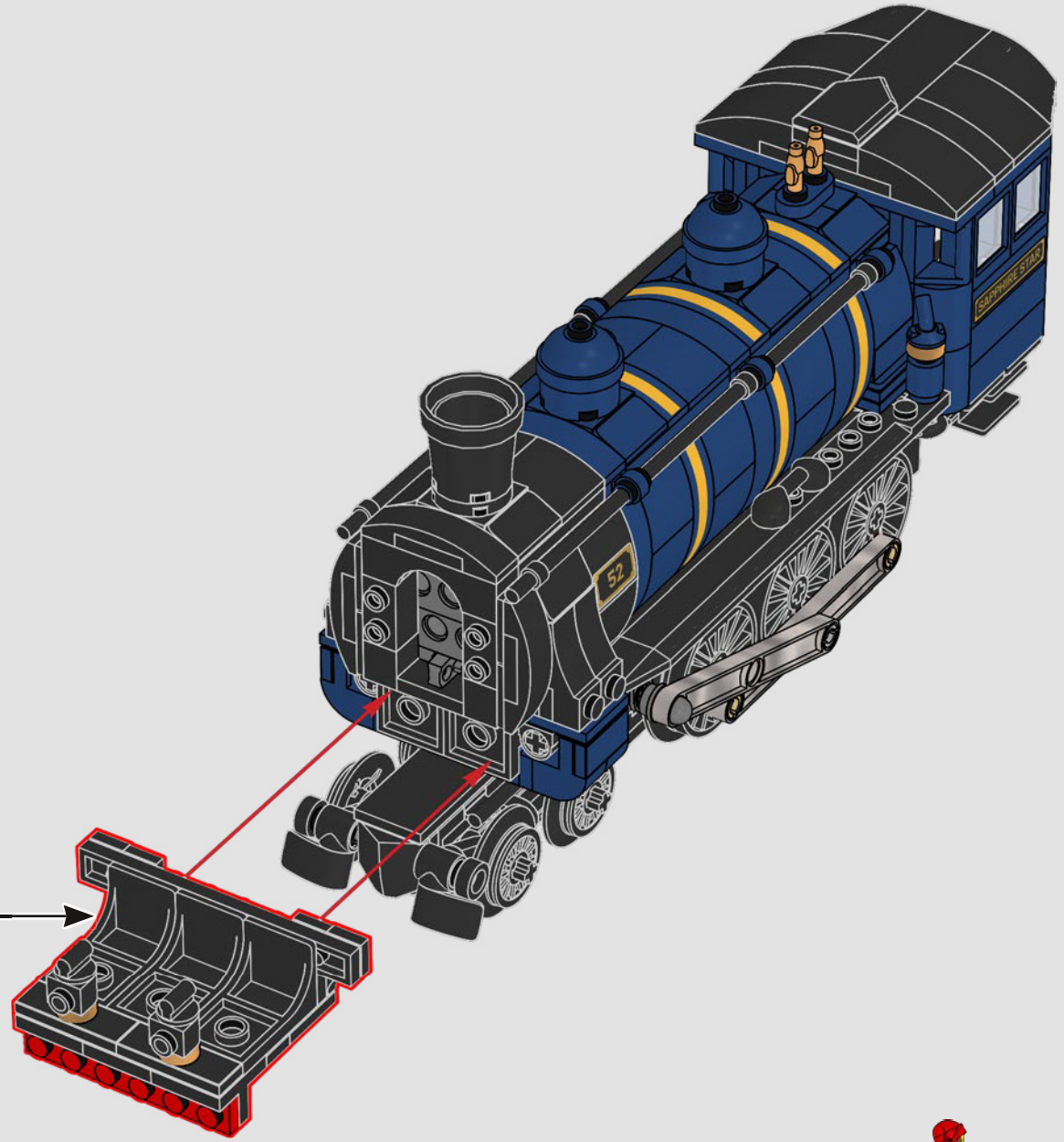
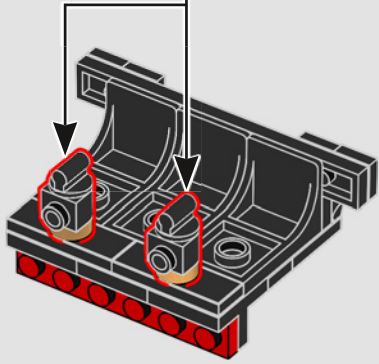



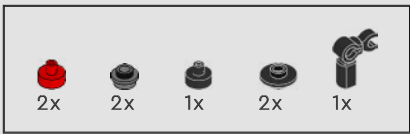

456

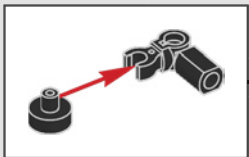
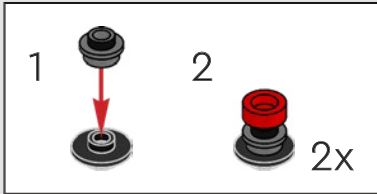
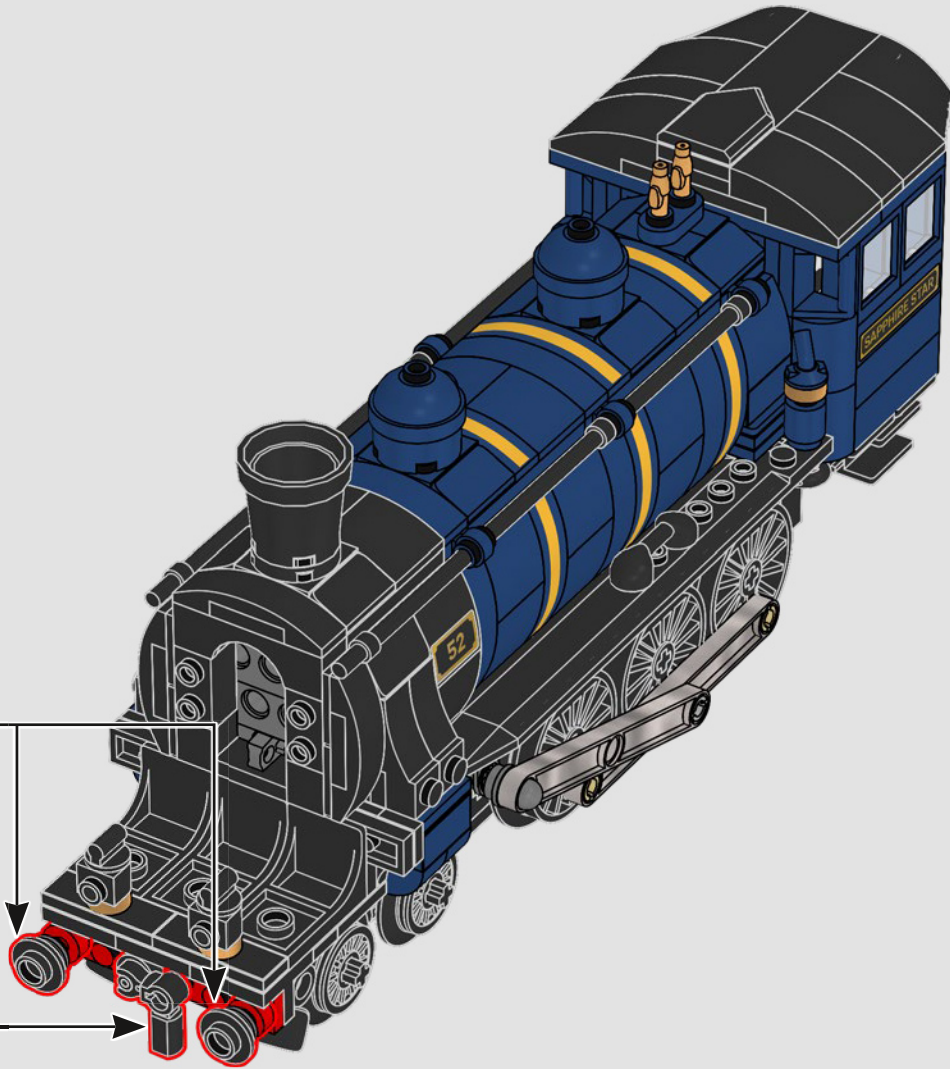

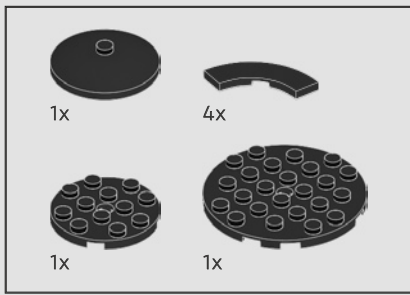

457

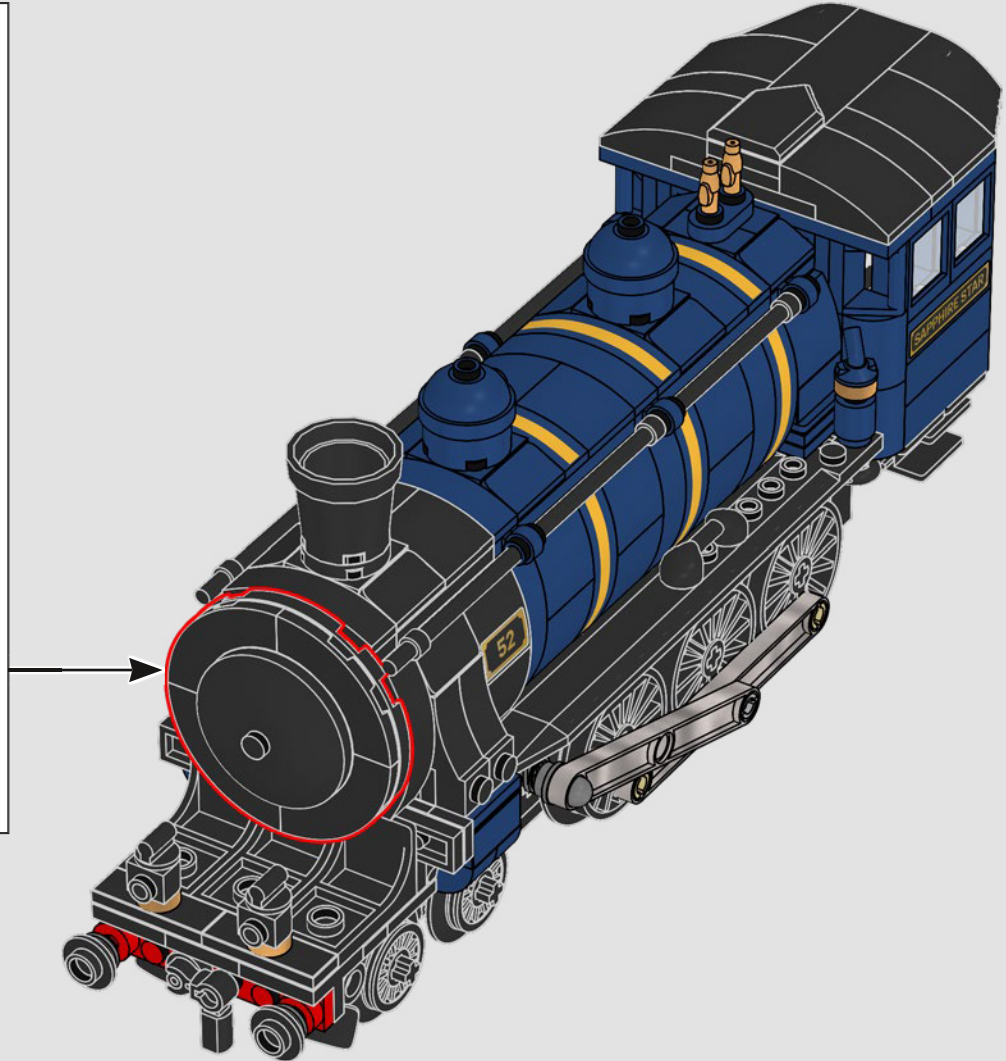
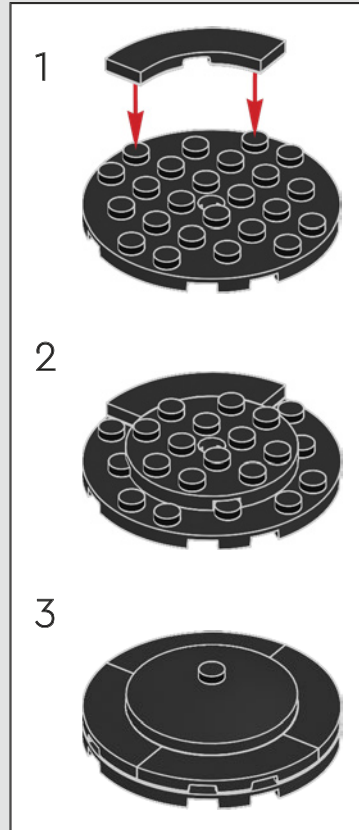

● .....  
Destinazione: ISTANBUL

"L'ultima fermata. Da qui si possono prendere coincidenze per località esotiche come Baghdad, Il Cairo, Teheran, Gerusalemme o Bombay!"

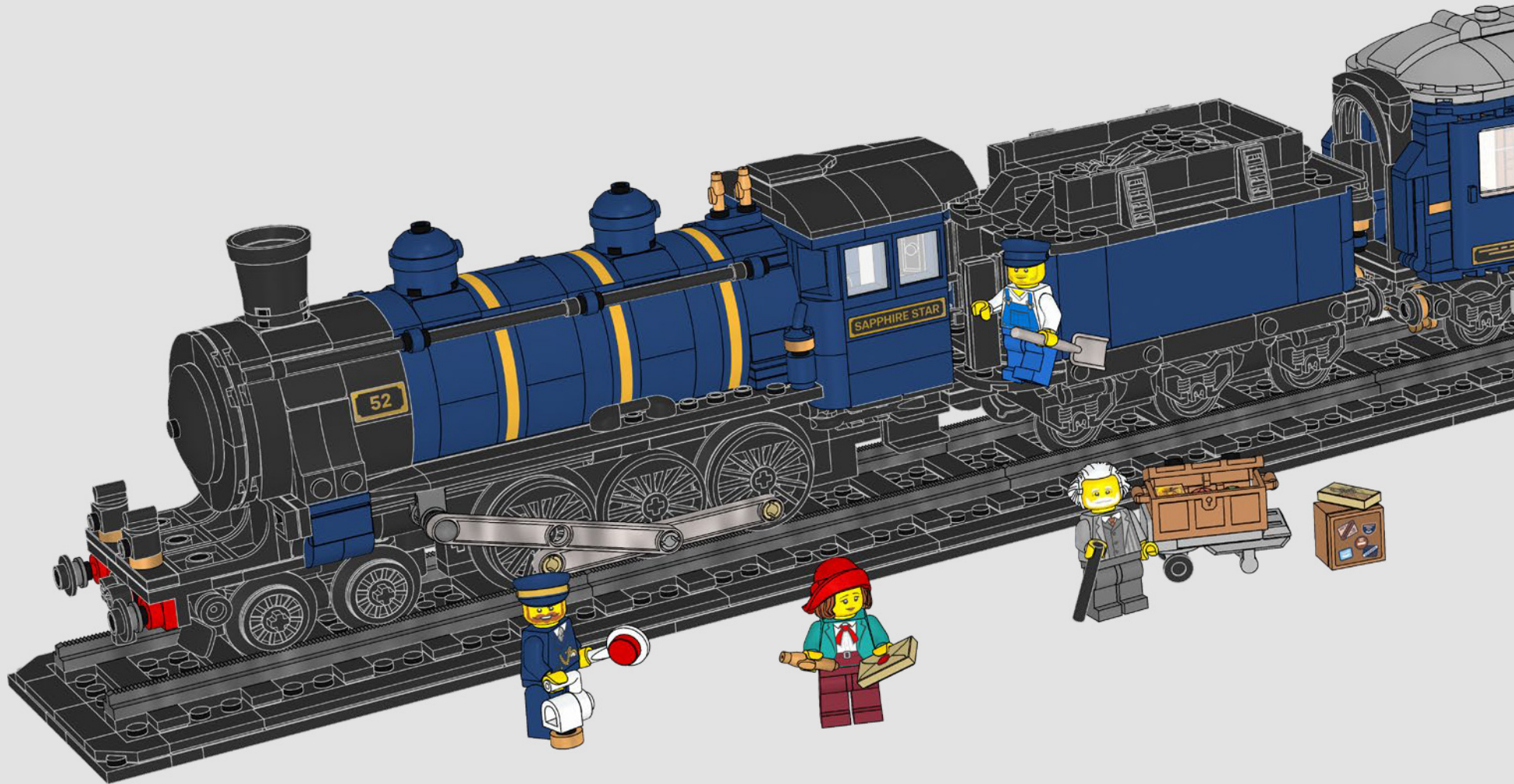



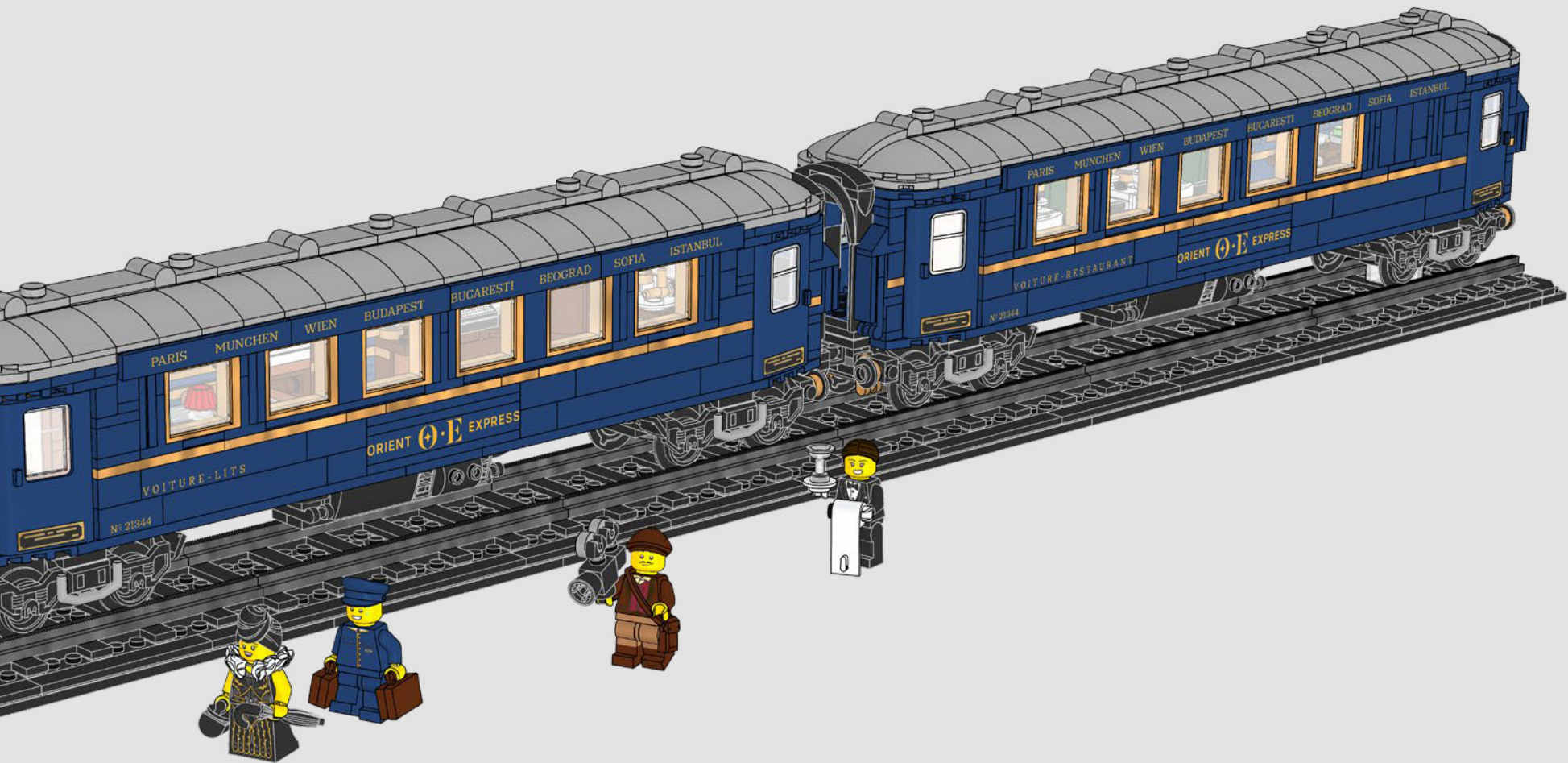





# IDEAS

GATHER SUPPORT  
HOL DIR UNTERSTÜTZUNG  
RECUEILLEZ DES VOTES  
CHIEDI DI ESSERE SUPPORTATO  
CONSIGUE APOYOS  
OBTÉM APOIO  
争取支持  
ZDOBĄDŹ GŁOSY

ZÍSKEJTE PODPORU  
ZÍSKAJTE PODPORU  
SZEREZZ TÁMOGATÁST!  
CERE SPRIJIN  
ПОЛУЧЕТЕ ПОДКРЕПА  
IEGŪSTI ATBALSTU  
KOGU TOĒTUST  
RINK PALAIKYMĄ

SHARE YOUR IDEA  
TEILE DEINE IDEE  
PARTAGEZ VOTRE IDÉE  
CONDIVIDI LA TUA IDEA  
COMPORTE TU IDEA  
PARTILHA A TUA IDEIA  
分享创意  
PODZIEL SIĘ POMYSŁEM

SDÍLEJTE SVÉ NÁPADY  
ZDIEĽAJTE SVOJE NÁPADY  
OSZD MEG AZ ÖTLETED!  
ÎMPĂRȚĂȘEȘTE IDEEA TA  
СПОДЕЛЕТЕ ИДЕИТЕ СИ  
PARĀDI SAVU IDEJU  
JAGA OMA IDEED  
PASIDALINK SAVO IDĒJA

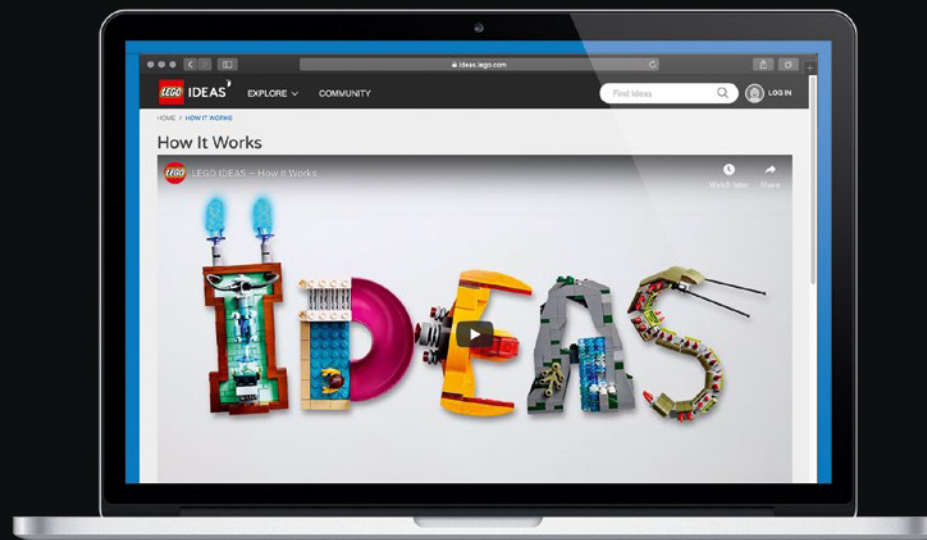
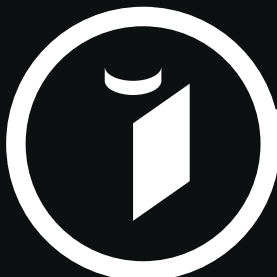
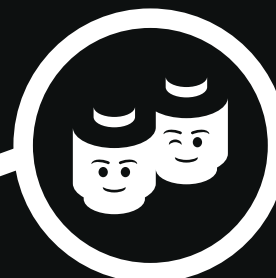

LEGO® REVIEW  
LEGO® PRÜFUNG  
EXAMEN PAR LEGO®  
REVIEW LEGO®  
REVISIÓN DE LEGO®  
AVALIAÇÃO LEGO®  
乐高®审核  
OCENA LEGO®

OUZENÍ DESIGNÉRY LEGO®  
POSÚDENÉ DIZAJNÉRMÍ LEGO®  
LEGO® VÉLEMÉNYEZÉS  
VERIFICARE LEGO®  
ΠΡΕΓΛΕΔ ΗΑ LEGO®  
LEGO® RECENZIIJA  
LEGO® ARVUSTUS  
LEGO® APŽVALGA

NEW LEGO® PRODUCT  
NEUES LEGO® PRODUKT  
NOUVEAU PRODUIT LEGO®  
NUOVO PRODOTTO LEGO®  
NUEVO PRODUCTO LEGO®  
NOVO PRODUTO LEGO®  
全新乐高®产品  
NOWY PRODUKT LEGO®

NOVÁ STAVEBNICE LEGO®  
NOVÁ STAVEBNICA LEGO®  
ÚJ LEGO® TERMÉK  
PRODUS LEGO® NOU  
НОВ ПРОДУКТ LEGO®  
JAUNS LEGO® PRODUKTS  
UUS LEGO® TOODE  
NAUJAS LEGO® PRODUKTAS

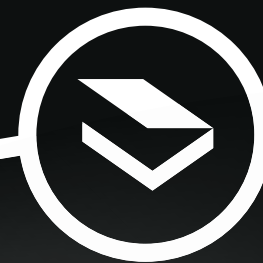
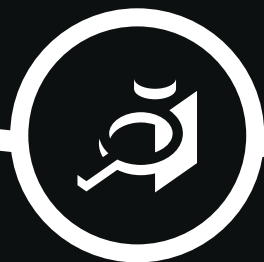

ideas.LEGO.com

1x 407001	1x 6434569	1x 474001	1x 4114084	4x 306223	1x 6123730	16x 306226	1x 6181713	1x 4177444	5x 301026	4x 303226
1x 4558952	3x 302301	1x 6172674	1x 6257600	2x 6055065	1x 6218310	2x 6436425	2x 6369578	1x 6261371	4x 371026	14x 303426
1x 6321349	1x 302201	2x 4537987	1x 6352222	2x 6092582	1x 6384058	2x 6344819	1x 6308912	2x 6396456	8x 6254045	3x 346026
1x 6218823	2x 6126046	1x 4527637	2x 6174925	12x 302223	1x 6384051	4x 4548180	4x 6211476	4x 302426	8x 243126	3x 346026
1x 6218823	1x 6415097	1x 6219621	4x 6013938	1x 6315482	1x 6434805	1x 6323421	2x 6458098	110x 302326	8x 243126	3x 346026
2x 6383982	1x 4558168	1x 6334236	2x 6215539	4x 6315482	1x 6288000	2x 6267487	4x 4200023	6x 306926	10x 302026	4x 447726
1x 306201	7x 6195371	1x 390001	1x 6284574	1x 9341	1x 6372016	1x 6273589	6x 6053077	4x 241226	3x 4560182	4x 303526
2x 6442360	7x 302101	6x 6475151	1x 6465499	4x 300423	1x 6352820	1x 6181720	1x 6390748	4x 6092585	1x 6076678	2x 6037390
1x 6050914	1x 6446788	4x 6235083	4x 6454454	2x 4558606	6x 6186675	4x 6138173	4x 6328095	4x 242026	1x 663626	4x 4514845
2x 4547489	1x 6348055	1x 6396958	2x 4142865	4x 301023	26x 407026	2x 265326	2x 4251161	19x 302226	3x 366626	2x 611226
1x 6213880	1x 6437184	4x 6238334	2x 6397571	8x 447723	13x 6228987	2x 4162443	1x 6390749	20x 6192346	5x 4243819	2x 244526
2x 6258135	2x 6168618	2x 4114026	1x 6284163	1x 362321	1x 4214559	2x 370126	4x 6147790	2x 6133722	2x 6318582	18x 428226
1x 6213881	6x 6449595	1x 6284163	1x 6455324	1x 6217123	2x 300426	2x 6039194	7x 4613153	8x 4558170	2x 379526	8x 6094066
2x 6248827	2x 6132203	4x 6286329	1x 6286329	1x 383223	2x 235726	2x 365926	2x 365926	6x 6199908	2x 379526	
1x 6285777	1x 6093053	1x 6375672	1x 6375672	7x 300121	3x 300326	4x 4587844	5x 6162892	5x 302126	82x 416226	
3x 6299937	2x 6023806	1x 4113916	1x 4113916	1x 366621	2x 244523	2x 6222427	4x 4587844	5x 6162892	82x 416226	

6x 6335388	4x 6424674	3x 6284070	1x 403226	1x 6104209	4x 6172383	8x 6156991	1x 4666322	1x 6134251	1x 6247798
2x 6272184	4x 6380236	6x 4225201	1x 6143850	1x 6093525	10x 6433936	12x 4541191	6x 6361813	2x 6058089	4x 6454463
4x 6310981	4x 6335317	1x 281726	1x 6428168	6x 6170421	1x 6420852	1x 6452332	6x 6315198	1x 6186867	1x 6186867
4x 4161332	8x 6234695	7x 6273226	16x 6191630	1x 9339	1x 6438919	3x 6195185	2x 6315198	6x 6449836	6x 6449836
4x 4161332	3x 6157554	1x 317626	4x 4227392	1x 9339	8x 6173959	5x 6394979	2x 6441768	1x 6253418	1x 6253418
1x 4180536	2x 6330189	3x 6416838	8x 6331483	1x 6431021	1x 6192778	1x 6245251	2x 6143431	3x 6408240	4x 6254552
4x 4160869	8x 6313116	4x 6118829	1x 396026	1x 6430624	1x 6454452	5x 6356406	5x 6186012	8x 6410188	8x 6410188
1x 4180508	2x 243226	6x 6168620	13x 4515350	1x 6438667	2x 6151289	2x 6439039	1x 6092602	23x 6278710	23x 6278710
4x 6284697	10x 6192309	8x 6099483	4x 6434275	1x 6203937	5x 6331084	3x 6332148	4x 4570877	9x 6359273	1x 6258607
1x 6057902	2x 6117973	1x 383926	1x 6187587	1x 6454457	1x 249626	2x 6284699	1x 4615606	1x 6340042	1x 6247785
4x 6284697	20x 6000650	3x 6468138	1x 6327548	1x 6290456	22x 6253473	1x 6338384	4x 6186423	1x 6359041	1x 6247793
1x 6057902	2x 6016172	4x 6401209	4x 4106347	1x 6359833	4x 6284110	3x 6291068	2x 6186423	1x 6429033	1x 6247788
2x 6236464	4x 6310268	1x 6057903	4x 6146220	2x 6186698	1x 4600178	2x 6099801	2x 6186007	3x 6252041	1x 6247364
2x 370826	4x 4107761	1x 6057903	4x 6146220	8x 6395769	1x 4600178	2x 6261386	2x 6186007	1x 6220959	1x 6464185
2x 4527604	10x 6250020	1x 6161298	1x 6408578	13x 6475153	4x 6443446	1x 370526	1x 6074893	1x 6239418	1x 6254100
					11x 6253474	5x 370626			















































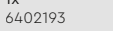





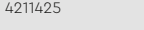





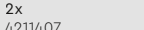















12

4

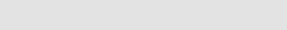
6



- 17x 4255413
- 40x 4249891
- 2x 6454453
- 4x 6228123
- 4x 6453215
- 22x 6233955
- 13x 4264569
- 1x 6275133
- 2x 6463543
- 4x 6465404
- 2x 6463544
- 12x 6277303
- 1x 6224377
- 4x 6256616
- 2x 6429965
- 5x 6135606
- 2x 4177741
- 6x 6216905
- 8x 6186683
- 1x 6214811
- 1x 6214812
- 12x 6384915
- 4x 6411363
- 16x 6061569
- 9x 6037886
- 9x 6453216
- 4x 6464198
- 62x 4184108
- 2x 6092588
- 32x 4528981
- 20x 4528488
- 12x 6037890
- 2x 4205004
- 8x 6132566
- 41x 4177735
- 7x 4502089
- 1x 6256610
- 4x 4569836
- 5x 6384913
- 2x 4508313
- 4x 6453208
- 12x 6250216
- 4x 6453207
- 8x 4507080
- 4x 6453209
- 4x 6453210
- 5x 6027627
- 4x 6106692
- 12x 6200663
- 2x 6429734
- 2x 6454464
- 8x 6120642
- 7x 6328107
- 2x 6097457
- 2x 6224472
- 2x 6371455
- 20x 6464203
- 2x 6470186
- 4x 6407191
- 1x 6236571
- 8x 4502091
- 8x 4529954
- 8x 6251836
- 4x 6382723
- 1x 6253883
- 8x 6450823
- 4x 6254479
- 2x 6409752
- 1x 6410902
- 2x 6391515
- 2x 4162916
- 1x 6463580
- 1x 6409766
- 4x 6454450
- 4x 6454451
- 4x 6315608
- 1x 6435099
- 1x 6308322
- 1x 6252040
- 8x 6171727
- 4x 4538760
- 2x 4210762
- 1x 4213607
- 1x 4211000
- 2x 6336390
- 1x 6266248
- 4x 6350292
- 8x 4225733
- 6x 6231765
- 1x 4222693
- 2x 6261374
- 4x 4211063
- 1x 4211055
- 2x 4211043
- 4x 4211065
- 4x 4211002
- 2x 6313652
- 2x 4211067

 2x 6258831	 5x 6171894	 1x 6146223	 1x 6201911	 2x 6253167	 2x 6149677	 1x 6236915
 10x 6284071	 4x 4211396	 1x 6468371	 1x 6468374	 1x 6397820	 5x 6341553	 4x 6172636
 4x 4211386	 16x 4211445	 1x 6195471	 1x 6408343	 2x 6322211	 2x 6238874	 12x 6168623
 2x 6123809	 4x 4211395	 1x 6152344	 2x 6268857	 3x 6311210	 4x 6226436	 1x 4211159
 2x 6123809	 8x 4560183	 1x 6152344	 1x 6270078	 16x 6172922	 2x 6251470	 1x 6037289
 8x 6407412	 1x 6402193	 8x 4644102	 2x 6329114	 2x 6172922	 2x 4211190	 1x 6102360
 24x 6262085	 4x 4211425	 4x 4494475	 6x 4211242	 2x 6409552	 1x 4211194	 2x 4283660
 8x 4251163	 4x 4211425	 2x 6271165	 2x 6177699	 2x 6299939	 6x 6257604	 1x 6228841
 76x 6132207	 2x 4211407	 4x 4211807	 2x 4211180	 2x 6325975	 2x 4211186	 1x 6424037
 2x 4211435	 4x 4211401	 1x 6134378	 5x 4211149	 2x 4211288	 1x 4579690	 1x 6398342
 4x 4211397	 2x 4211407	 2x 6420741	 2x 4211210	 2x 4221744	 1x 4211204	 1x 6063447
 4x 4211397	 4x 4211486	 8x 6163990	 2x 4211225	 5x 4211151	 1x 4221590	 4x 6291040
 10x 6126082	 4x 4211725	 4x 4211725	 2x 4211193	 1x 4211257	 2x 6326103	 3x 6064188
				 7x 6196221	 8x 6055145	 3x 6064188

2x  
6395635

2x  
6364352

3x  
6464199

12x  
6218047

4x  
4490599

22x  
6186672

2x  
6335111

8x  
6212377

2x  
6338242

30x  
6449109



[LEGO.com/service](https://www.LEGO.com/service)

2x  
6375358

1x  
6372427

7x  
6190252

1x  
6400656

1x  
6327553

1x  
6477142

1x  
6173139

1x  
6056774

8x  
6083975

1x  
6370621

2x  
6452472

1x  
4585493

23x  
6459521

1x  
6451126

2x  
6310366

4x  
6296061

3x  
6102990

2x  
6433733

1x  
6435640

1x  
6467618

1x  
6435310

1x  
6394960

1x  
6102984

2x  
6287309

12x  
6275872

8x  
4653988

4x  
6424641

8x  
6346764

7x  
6133728

4x  
6250001

3x  
6210675

2x  
6337197

4x  
6453350

1x  
6210601

18x  
6454456

1x  
4653970

2x  
6348142

4x  
6335566

6x  
6119107

2x  
4619513

2x  
4625036

9x  
6146926

2x  
6411330

1x  
4583299

1x  
4541496

4x  
6411595



# YOU COULD WIN



## YOU COULD WIN

Your feedback will help shape the future development of this product series.

Visit:

## DU KÖNNTEST GEWINNEN

Dein Feedback trägt zur Weiterentwicklung dieser Produktreihe bei.

Geh auf:

## VOUS POURRIEZ GAGNER

Vos commentaires nous aideront à concevoir les futurs produits de cette gamme.

Visitez :

## POTRESTI VINCERE TU

La tua opinione ci aiuterà a migliorare la creazione futura di questa linea di prodotti.

Visita:

## PUEDES GANAR

Tu opinión contribuirá al futuro de esta serie de productos.

Visita:

## 轻松获奖

您的反馈将有助于我们在今后改进本产品系列。

请访问:

---

[LEGO.com/productfeedback](https://www.lego.com/productfeedback)

---

You also have the chance to win a LEGO® set.

Terms and conditions apply.\*

Außerdem hast du die Chance, ein LEGO® Set zu gewinnen.

Es gelten die Teilnahmebedingungen.\*

Vous pourriez également gagner un ensemble LEGO®.

Des conditions s'appliquent.\*

Hai anche la possibilità di vincere un set LEGO®.

Termini e condizioni sono applicabili.\*

También tienes la oportunidad de ganar un set LEGO®.

Aplican términos y condiciones.\*

您还有机会赢取乐高®套装。

条款和条件适用。\*

\*[LEGO.com/productfeedback-terms](https://www.lego.com/productfeedback-terms)



# ORIENT EXPRESS



LEGO and the LEGO logo are trademarks of the LEGO Group. ©2023 The LEGO Group.  
ORIENT EXPRESS™ is a registered trade mark of Orient Express. All rights reserved.