

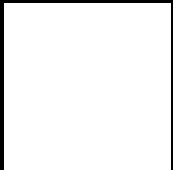

Booklet available in English on
Heft in deutscher Sprache erhältlich auf
Livret disponible en français sur
Libretto disponibile in Italiano su
Folleto disponible en español en
如需中文版手册, 请访问



Meet Clemens Fiedler

I'm 22 years old and live in Hannover, Germany. I study geography at the University of Hannover and plan to study landscape architecture after I complete my degree. I've played with LEGO® bricks for as long as I can remember, and my passion for medieval architecture and design was ignited early in life when my father's friend taught me how to forge metal. We started with small objects and then moved on to things like damask knives as well. It's a time-consuming process, but the results are really impressive.

I've always found that the best way to get new building ideas is to search your passions and interests and create something you can really identify with. So that's how the idea for a charming old Medieval Blacksmith's workshop was born. With 2,164 bricks, this model is packed full of details, too. I wanted to create a harmonious color scheme and stay true to the authentic architectural style throughout the set. The roof was a fun challenge! It has so many different elements and slopes. All in all, the original set took more than a month to create, including a digital version.

Thanks to everyone who supported this project across the LEGO Ideas platform, the amazing LEGO fans community and the LEGO designers! I hope you will enjoy traveling back in time, sense the heat, sounds and smells from the forge and anvil and soak up the atmosphere of this classical, creative craft as you build your set.



“ I love building classical house designs and honoring all the great attention to detail you can recreate with LEGO elements – especially medieval architecture styles, colors and design ”



Some of Clemens' early medieval builds

The LEGO® designers

Wes Talbott, LEGO® Design Master

This Medieval Blacksmith's workshop immediately caught my eye. I love medieval architecture – the very iconic half-timbered, wattle and daub style. I've seen other fans create large medieval dioramas, but we have never released an official model in this scale, with this much detail... until now! I love the layout of the building and the detailed exterior and interior. The concave bend in the roof adds so much to the character of the house. I hope you'll enjoy discovering all the little details in every nook and cranny of the set, live out your own medieval fantasy as you build and maybe go all in and create an entire medieval village.

Austin William Carlson, LEGO® Senior Designer

Working on this model took me back to all my favorite classical tales of knights and castles. It has been a while since we've released an official, medieval castle-themed set, and it was really fun to step back in time and rediscover that part of world history – and LEGO® history, too, of course – to help create something new that LEGO fans will hopefully love. Older Black Falcons Castle sets (1984–2002) were some of the most iconic and popular LEGO models ever, and being able to bring back these knight minifigures in this setting was a wonderful journey. Now go forth and build your own new heroic tales!



The LEGO® Blacksmith (Wes) and Knight (Austin)



LEGO® blacksmith sets

The first LEGO® Blacksmith Shop (6040) was released in 1984. A horse, a hardworking blacksmith and a brave knight provided lots of role-play fun. It would be 18 years before the next Blacksmith Shop (3739) came out in 2002 – a cozy workshop for a blacksmith and his wife, designed by fan designer Daniel Siskind under the My Own Creation theme, the forerunner for LEGO Ideas. As part of the medieval theme in 2011, the LEGO Group also launched a LEGO Kingdoms Blacksmith Attack (6918) with an evil Dragon Knight, and a hammer and anvil powered by a mill. The Medieval Blacksmith model (21325) is the biggest medieval set to date, with all the charm and authenticity of a classical medieval tale.



1984



2002



2011



2021



From the architectural style to decorations and accessories, the immersive details of everyday medieval life in the model will spark your imagination and bring you back in time.

A light brick brings the forge to life



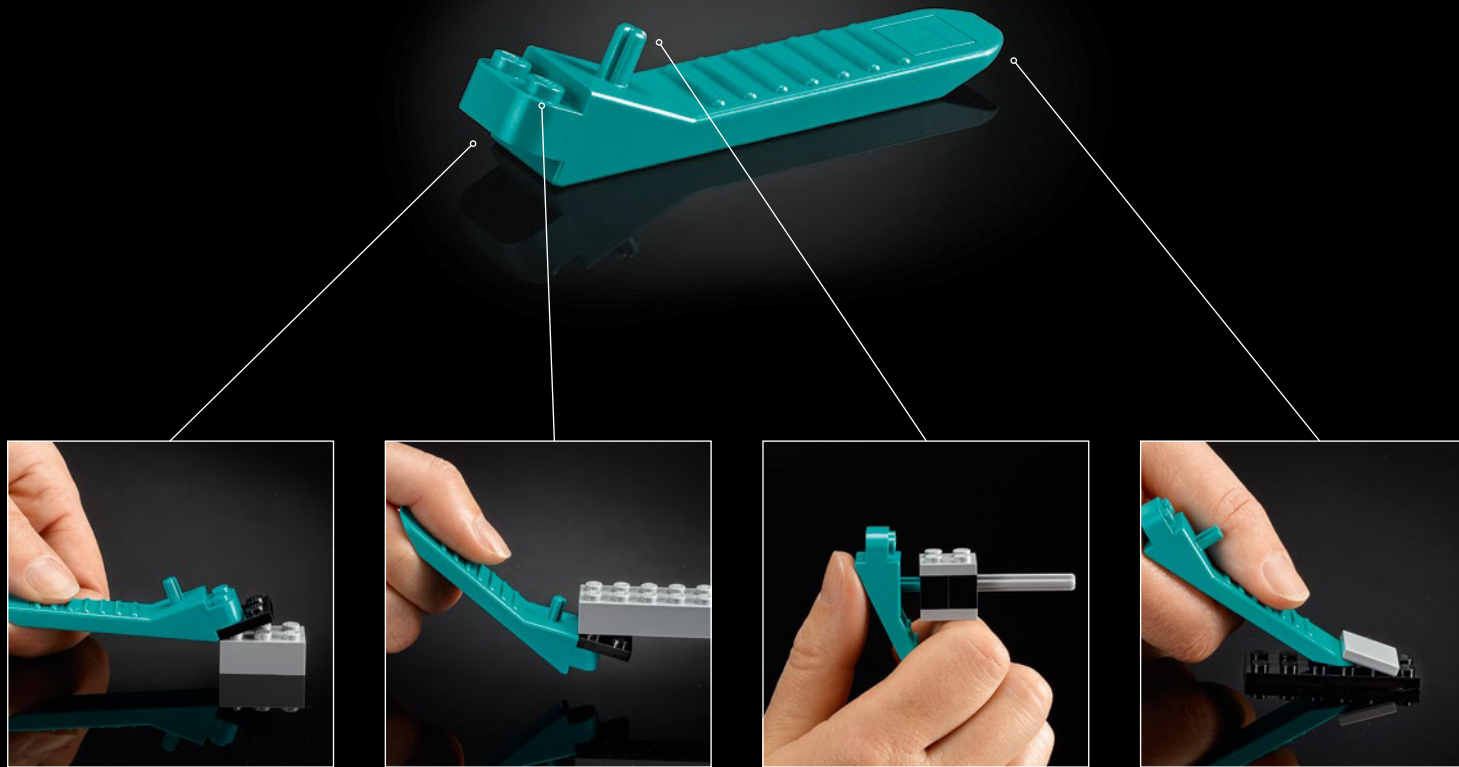

[LEGO.com/brickseparator](https://www.lego.com/brickseparator)

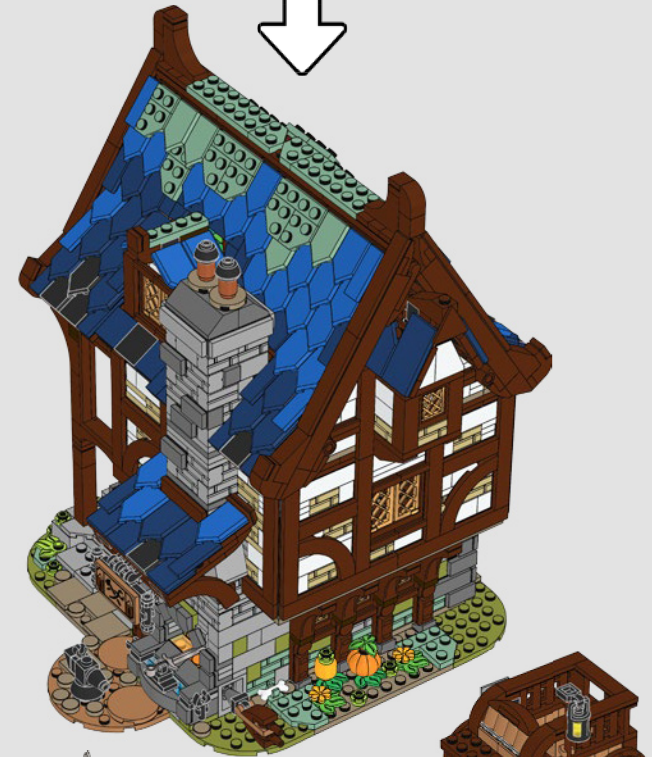
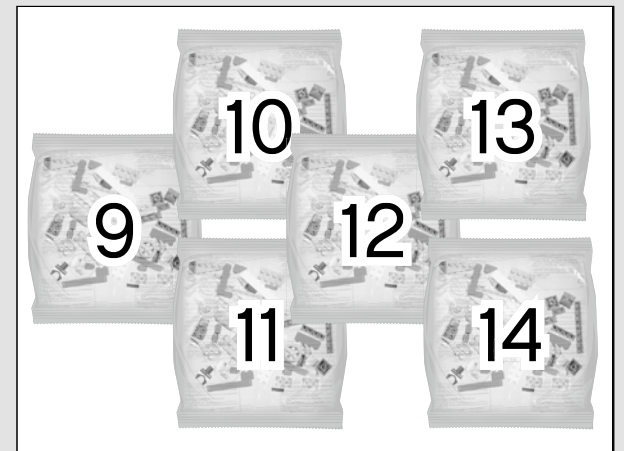
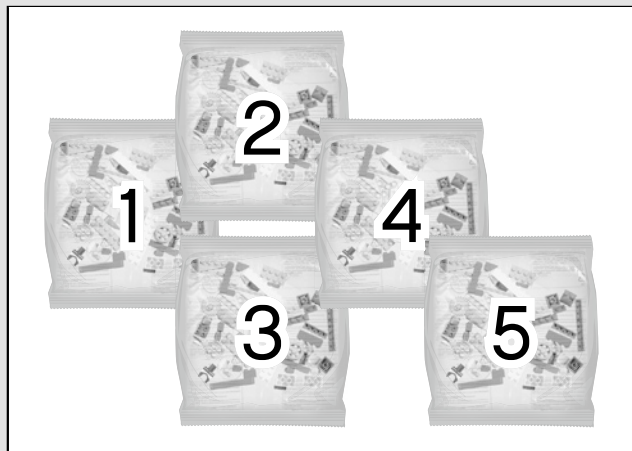

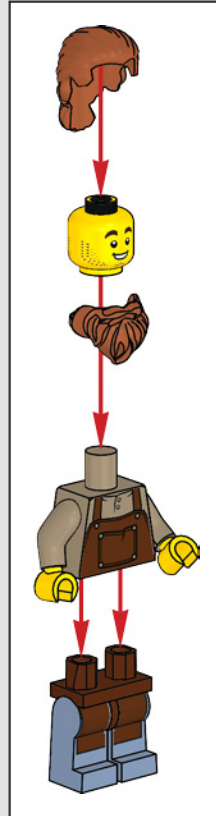
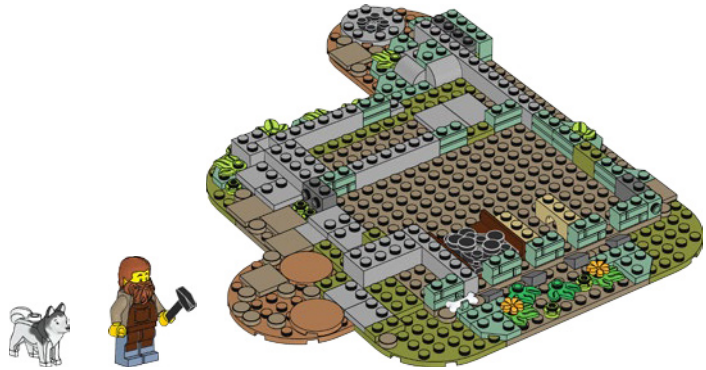
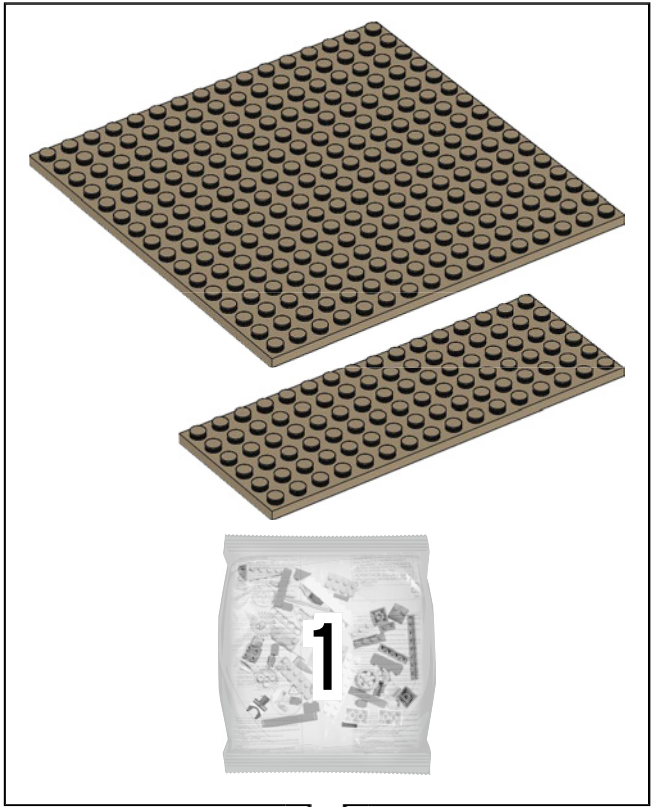

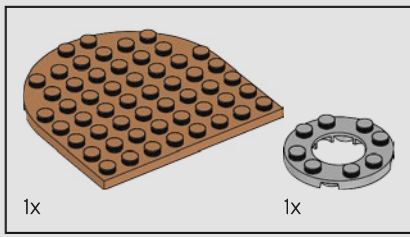

1

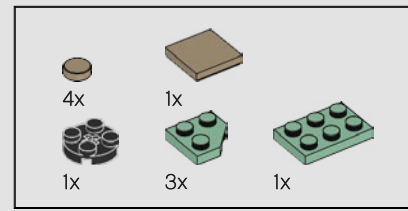
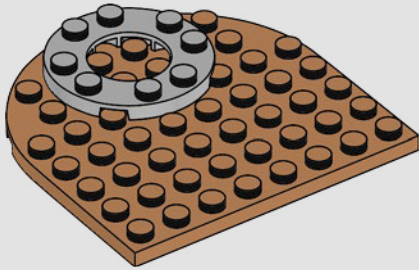

2

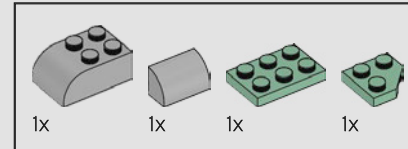
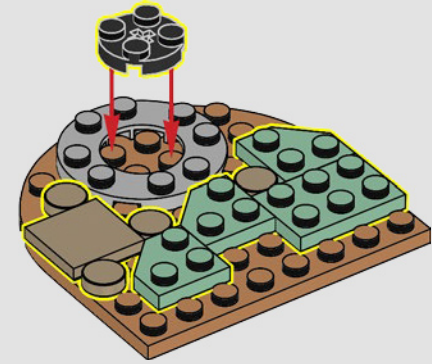

3

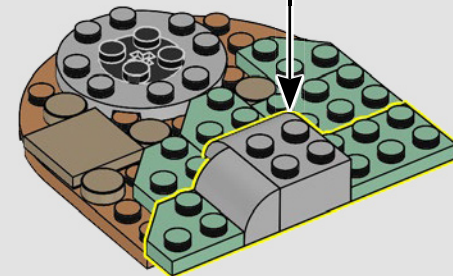
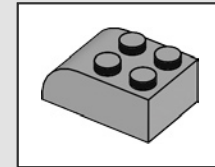

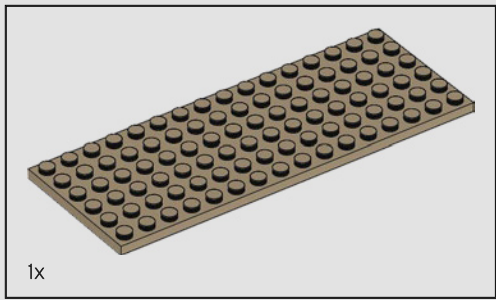

4

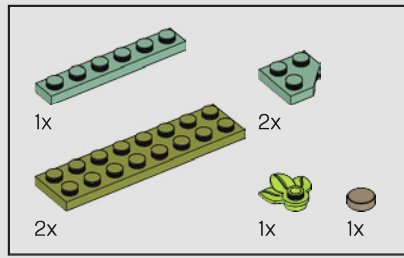
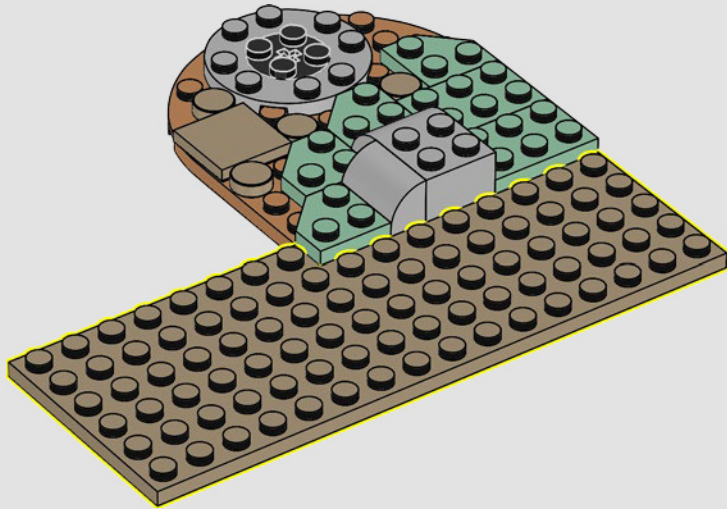

5

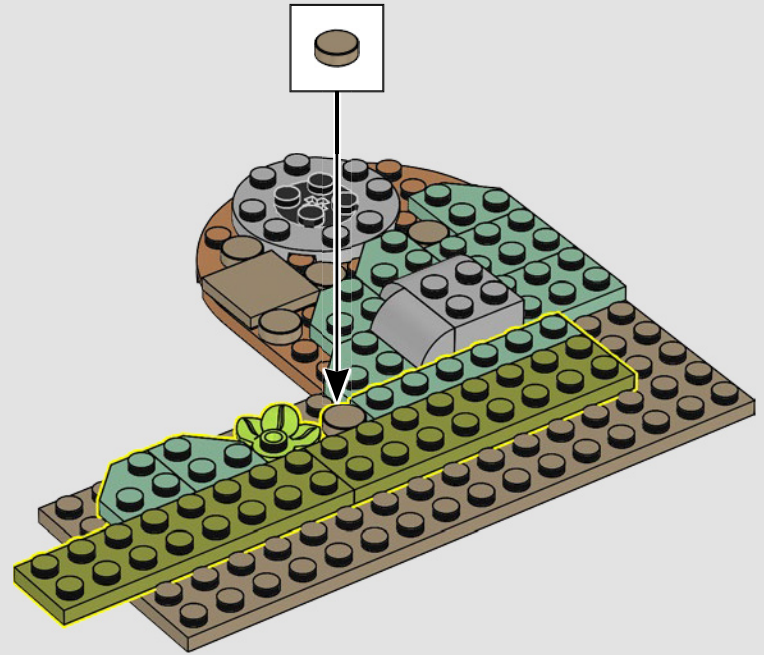

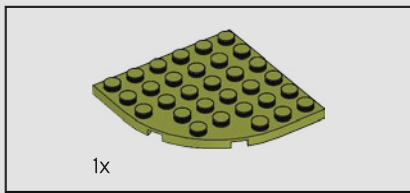

6

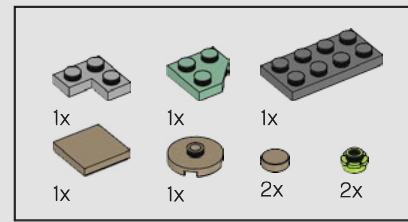
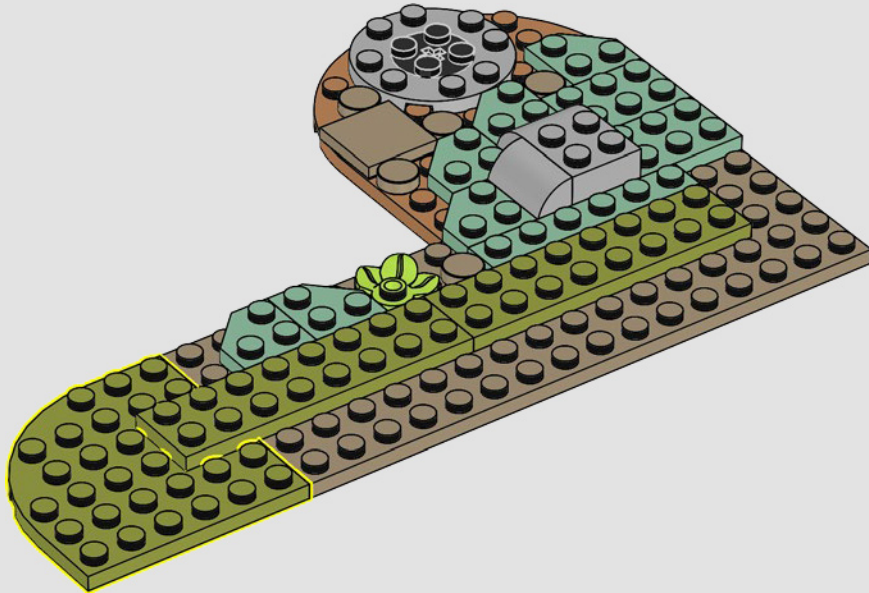

7

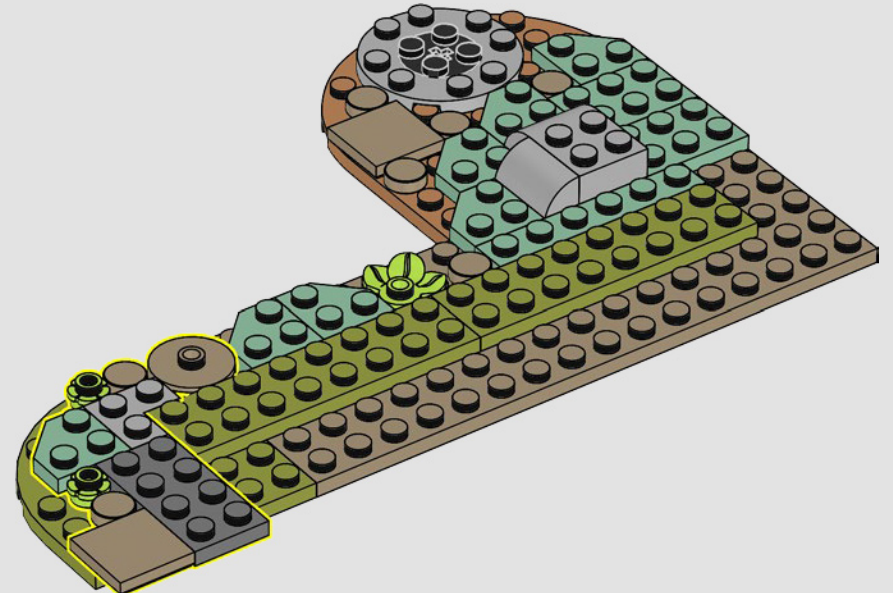

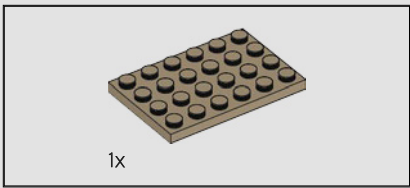

8

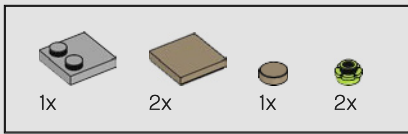
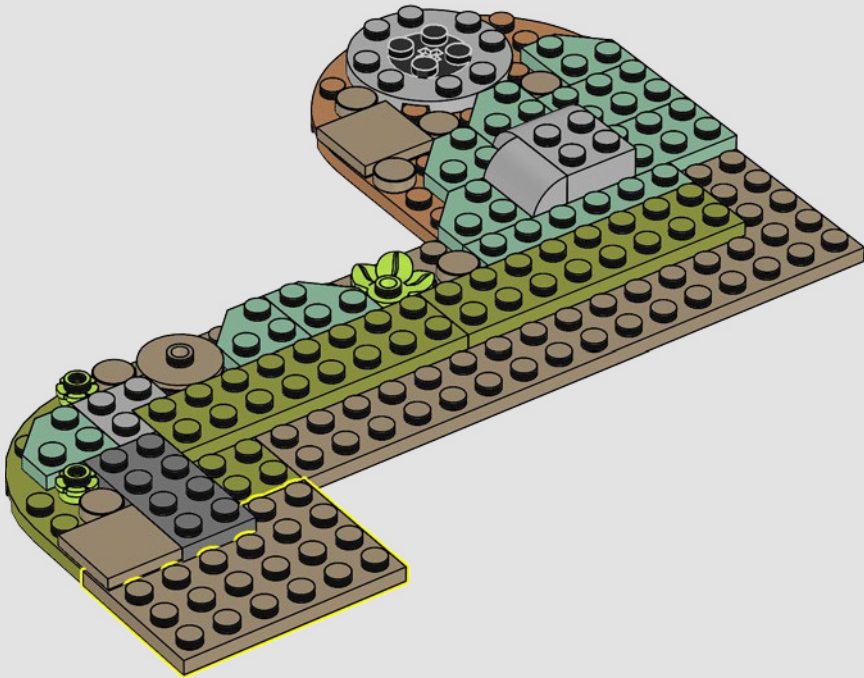

9

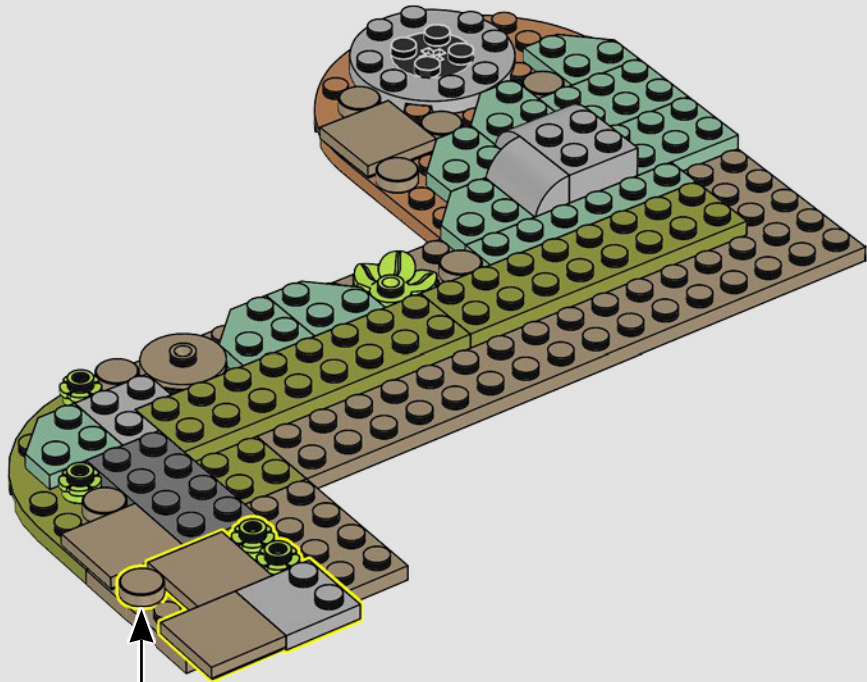

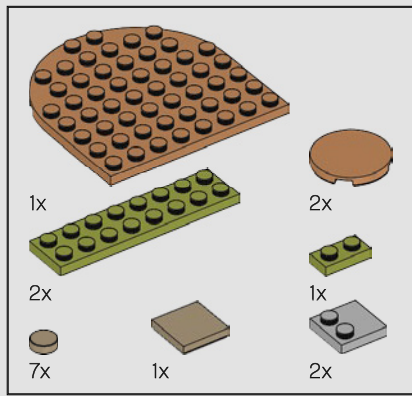

10

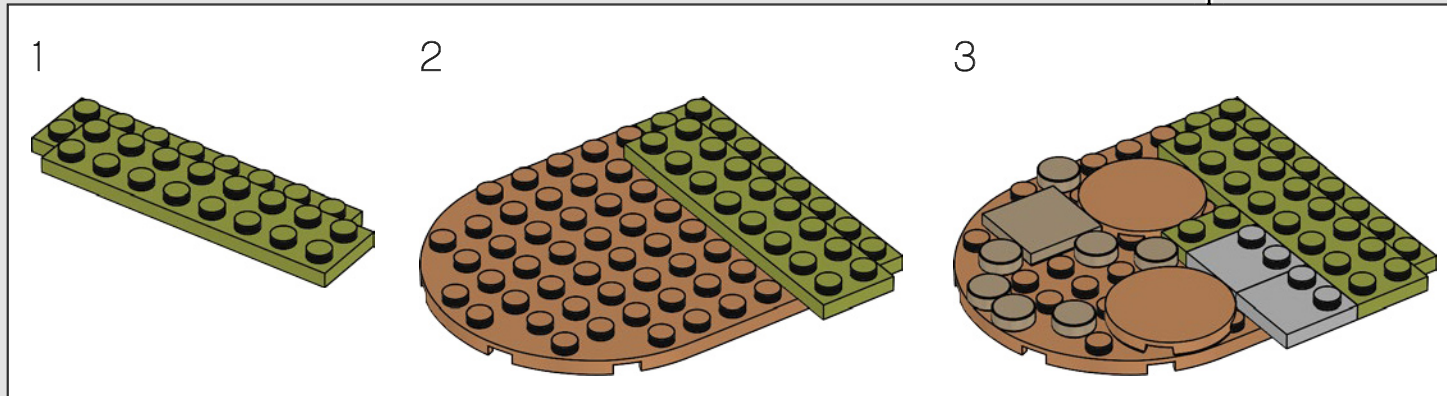
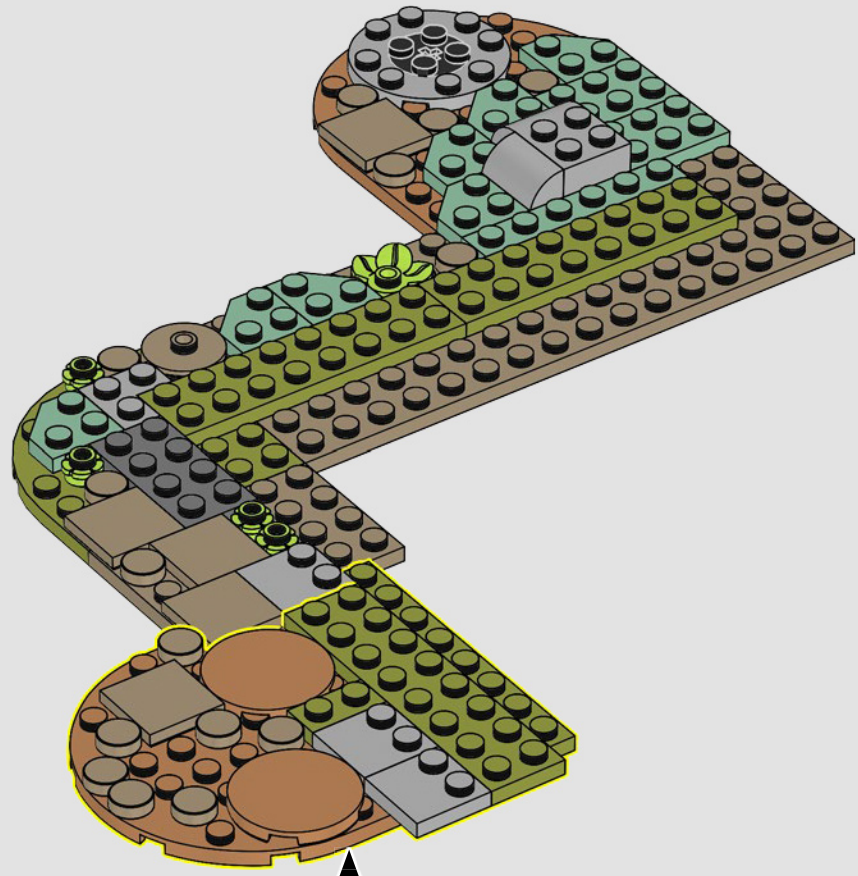

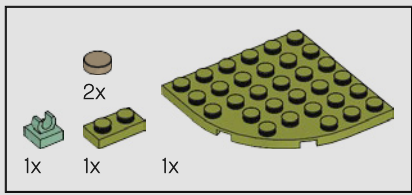

11

1

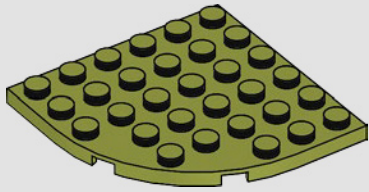

2

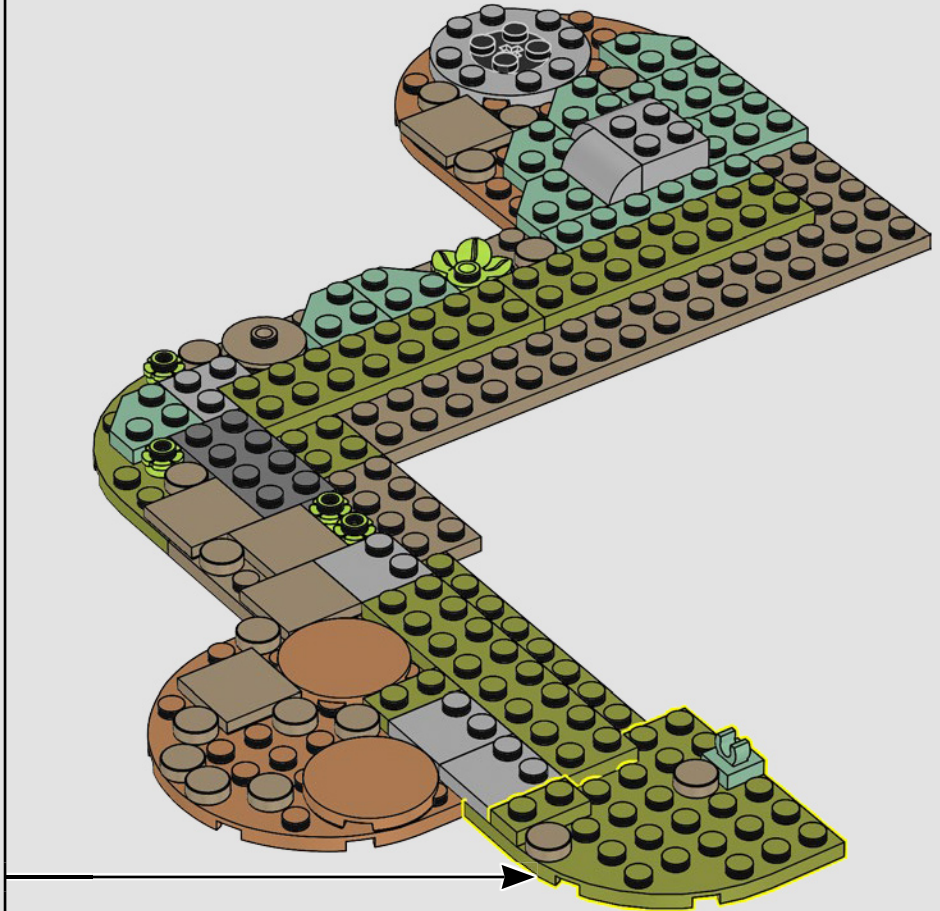
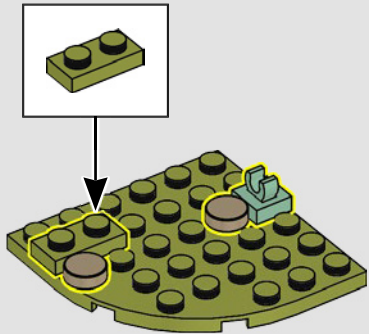

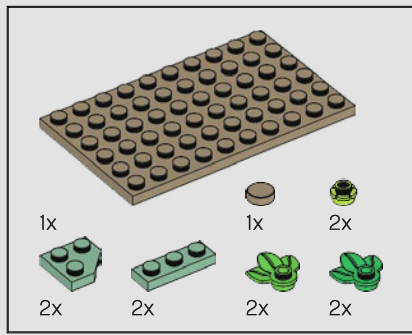

12

1

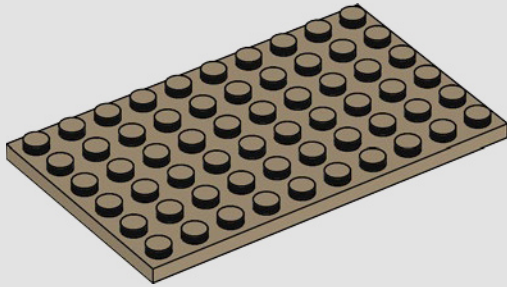

2

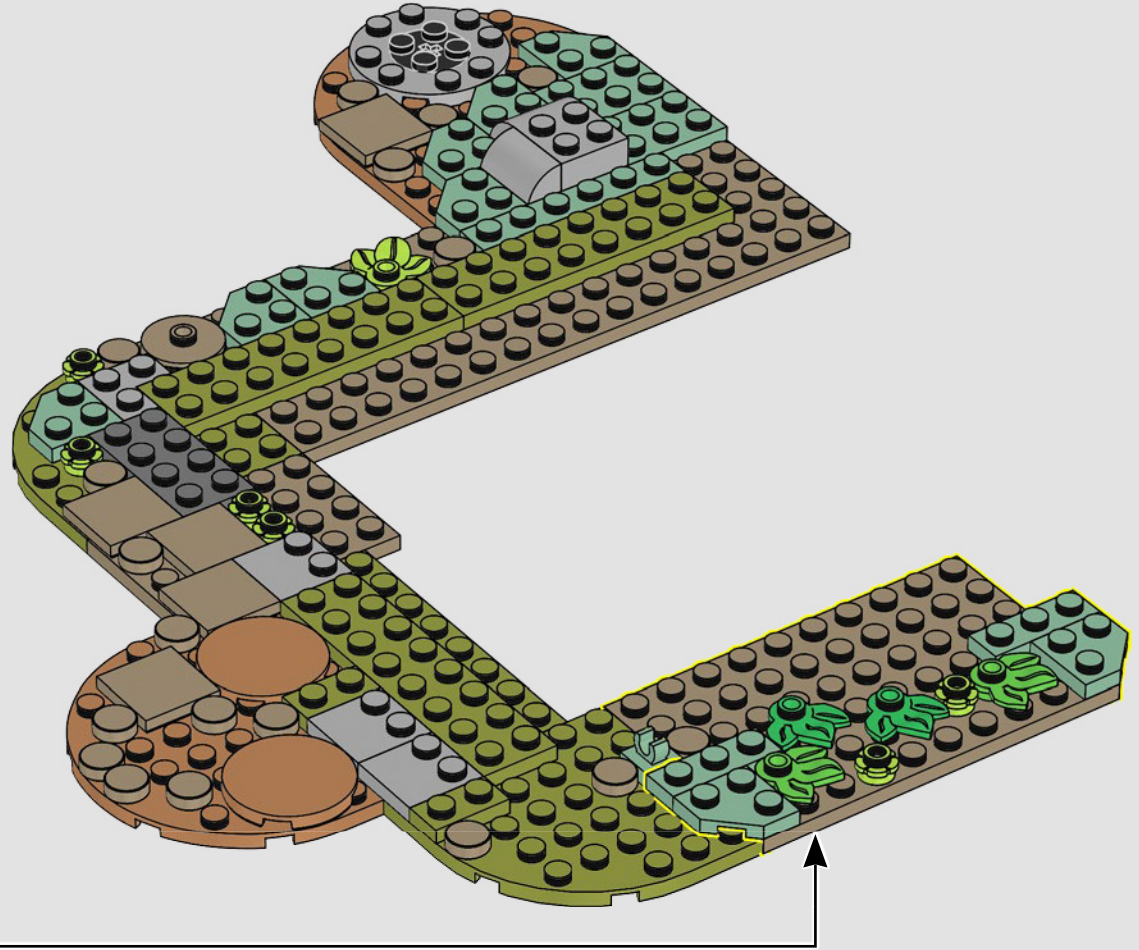
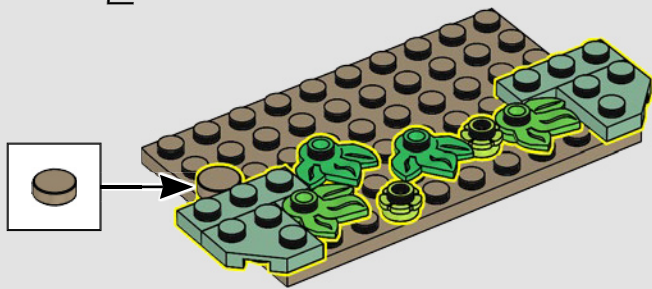

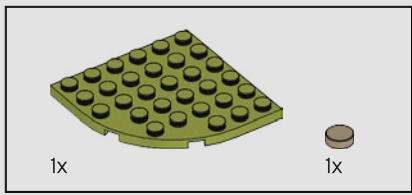

13

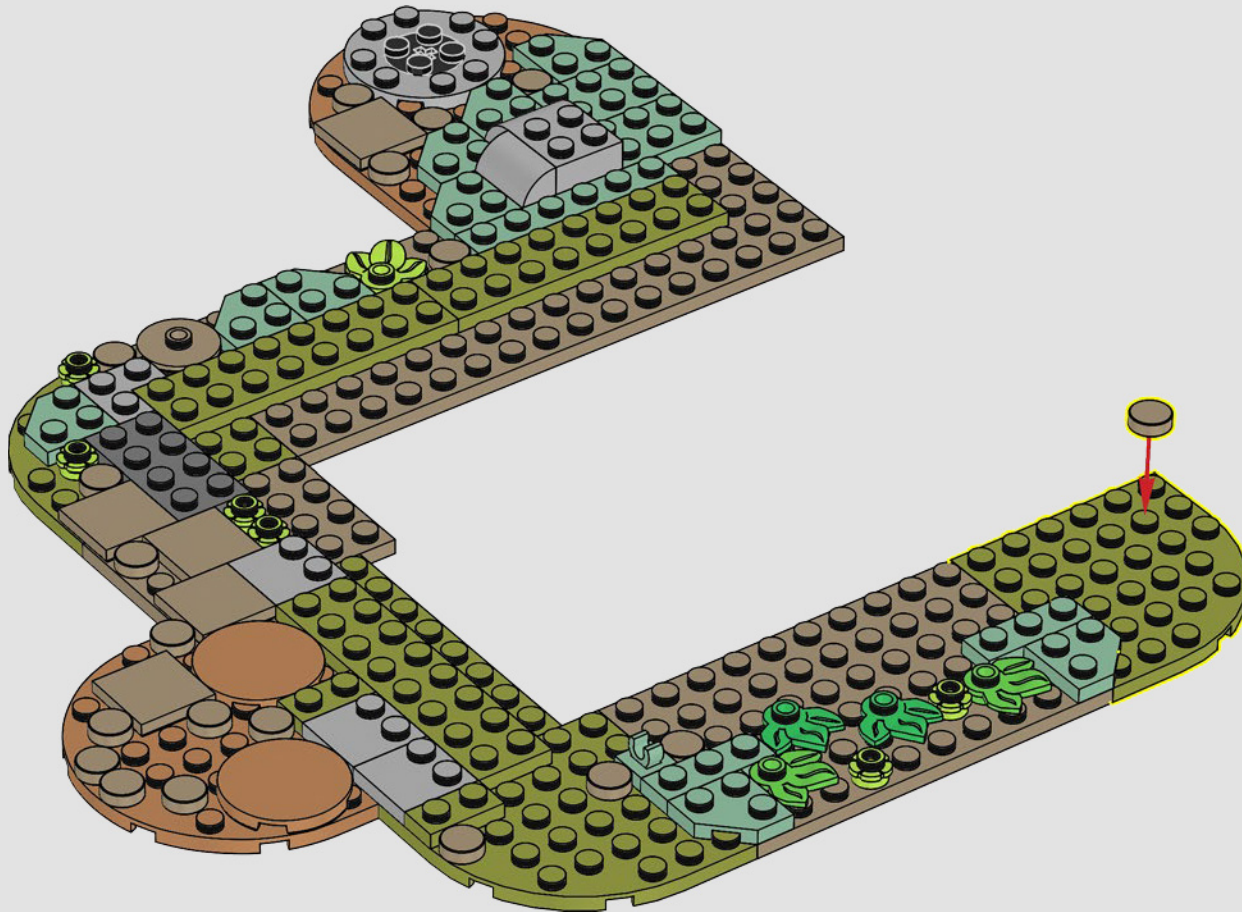

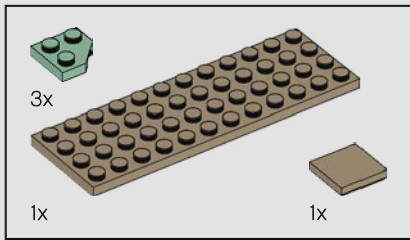

14

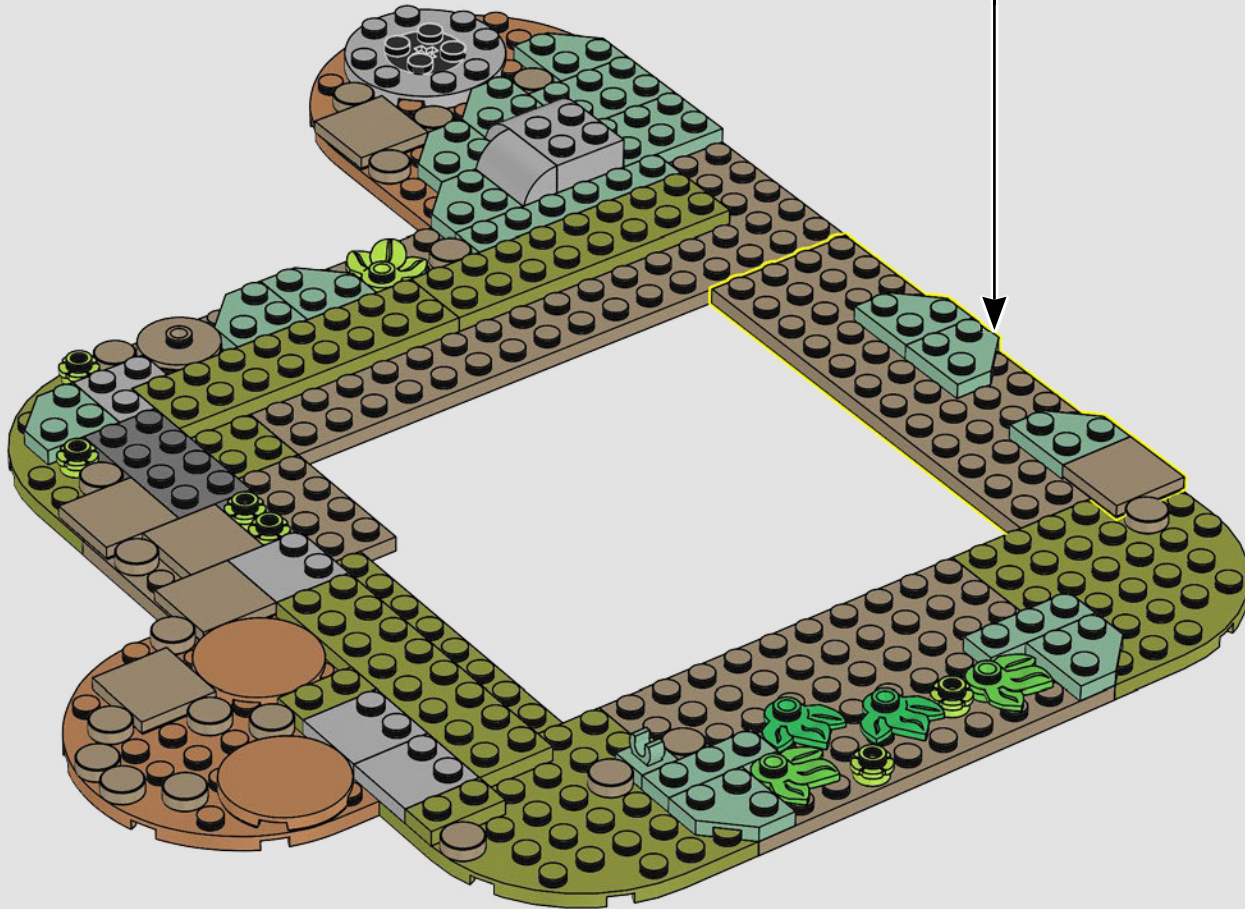
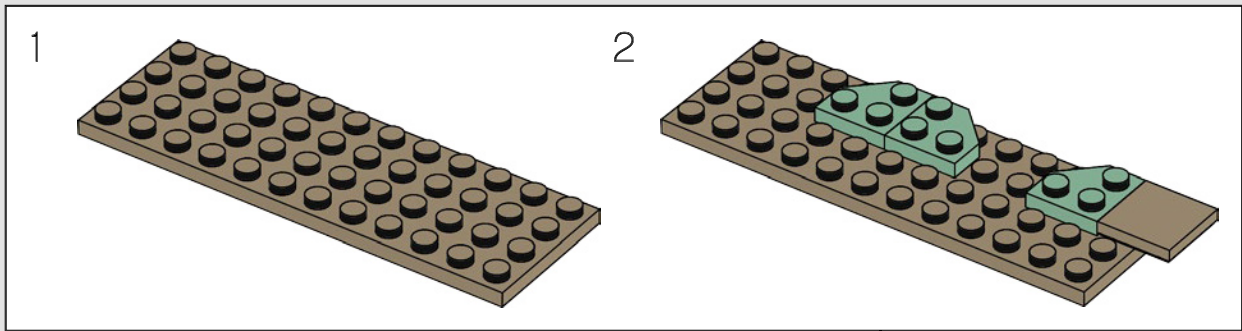

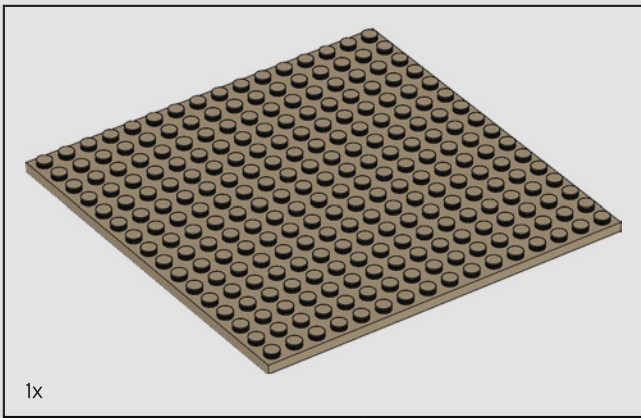

1x

15

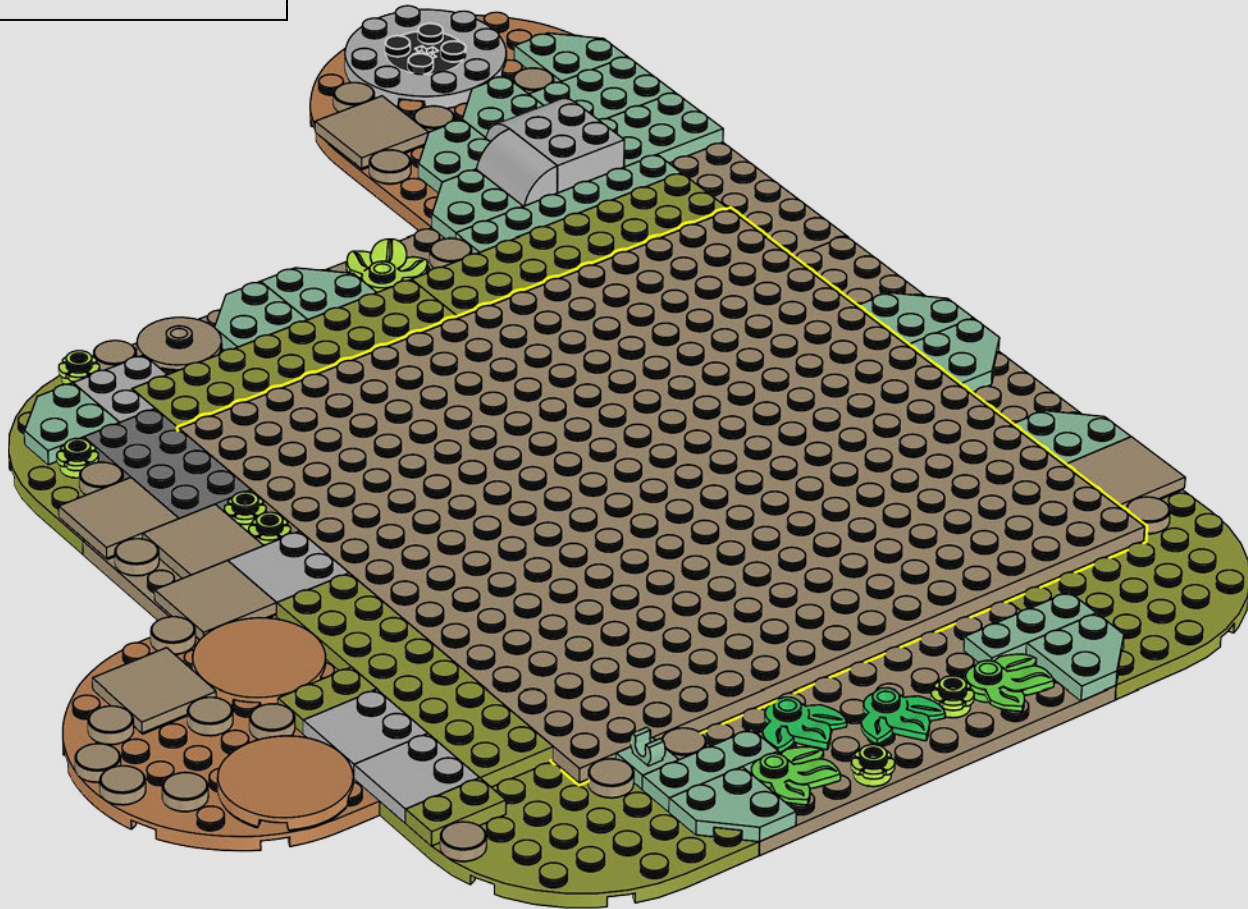

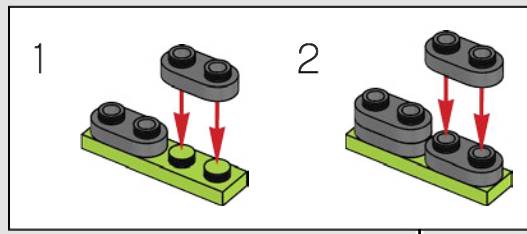
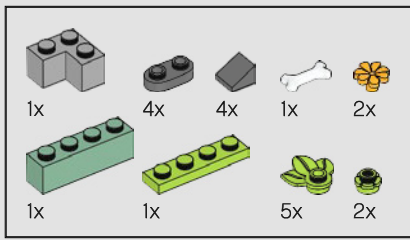

16

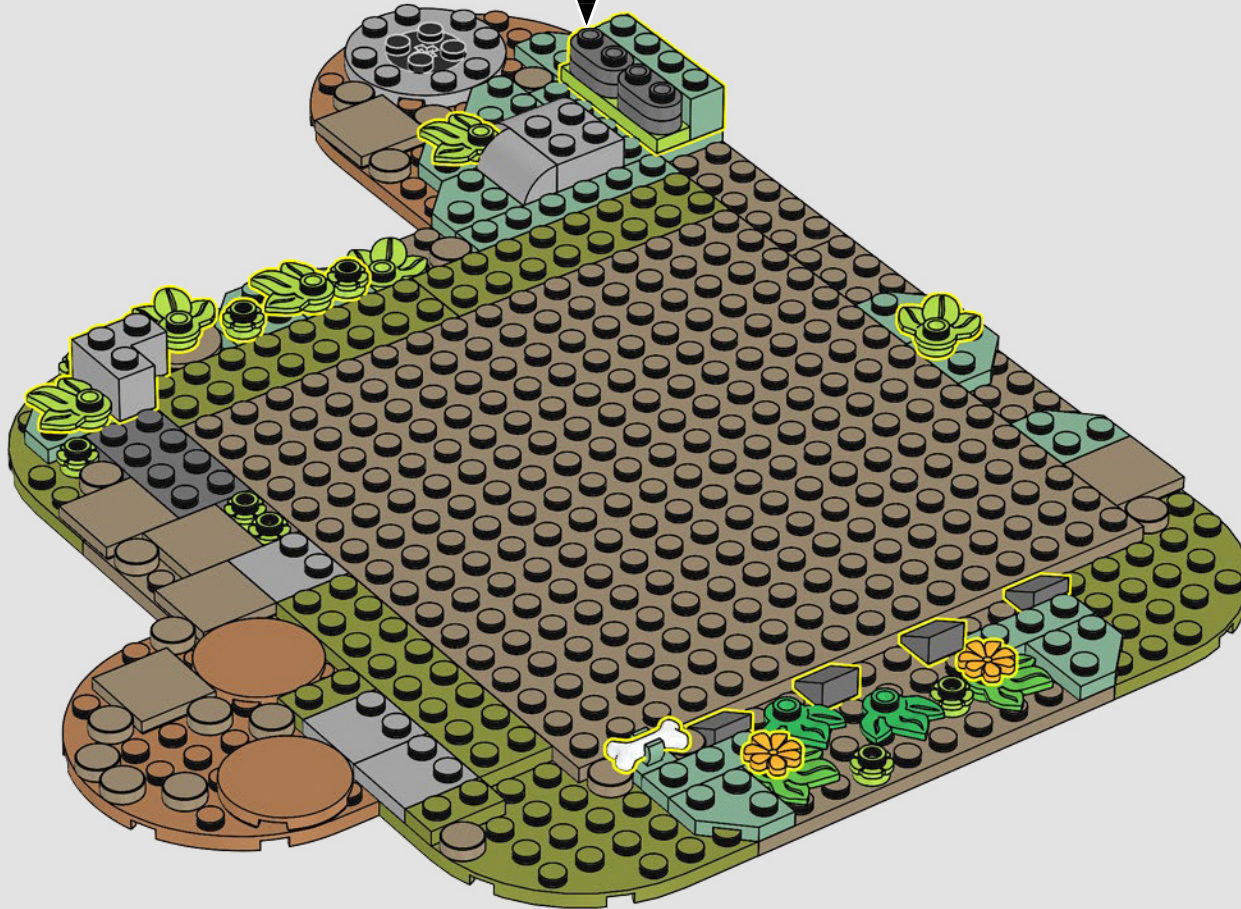

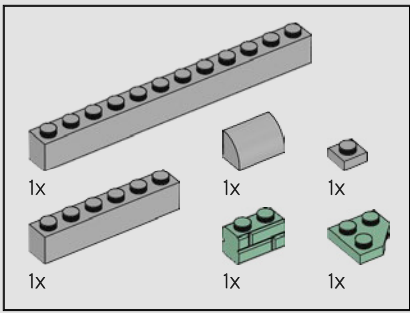

17

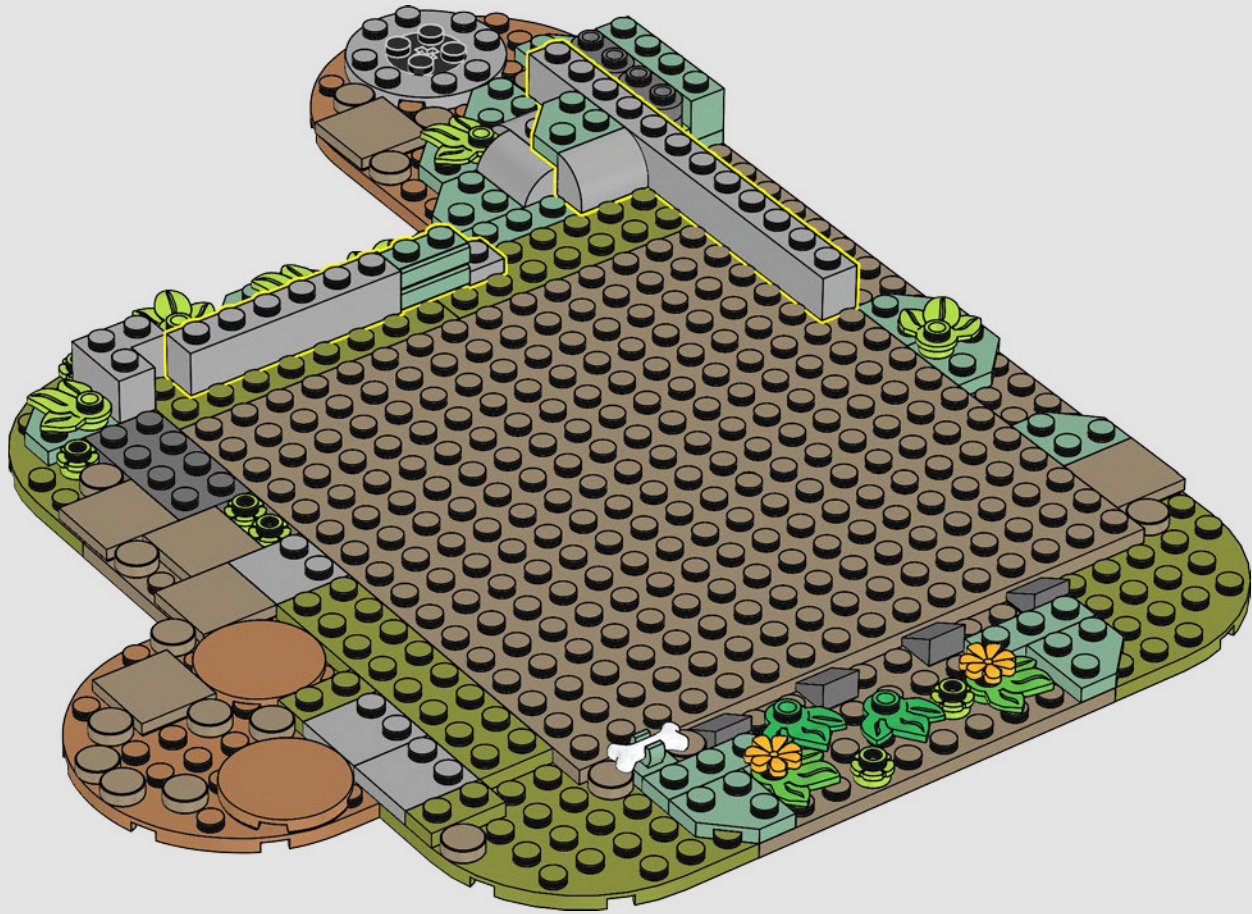

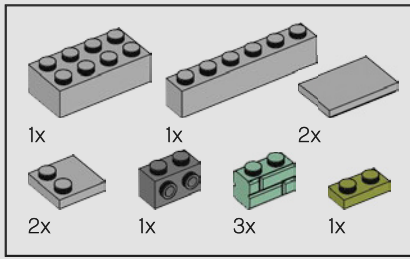

18

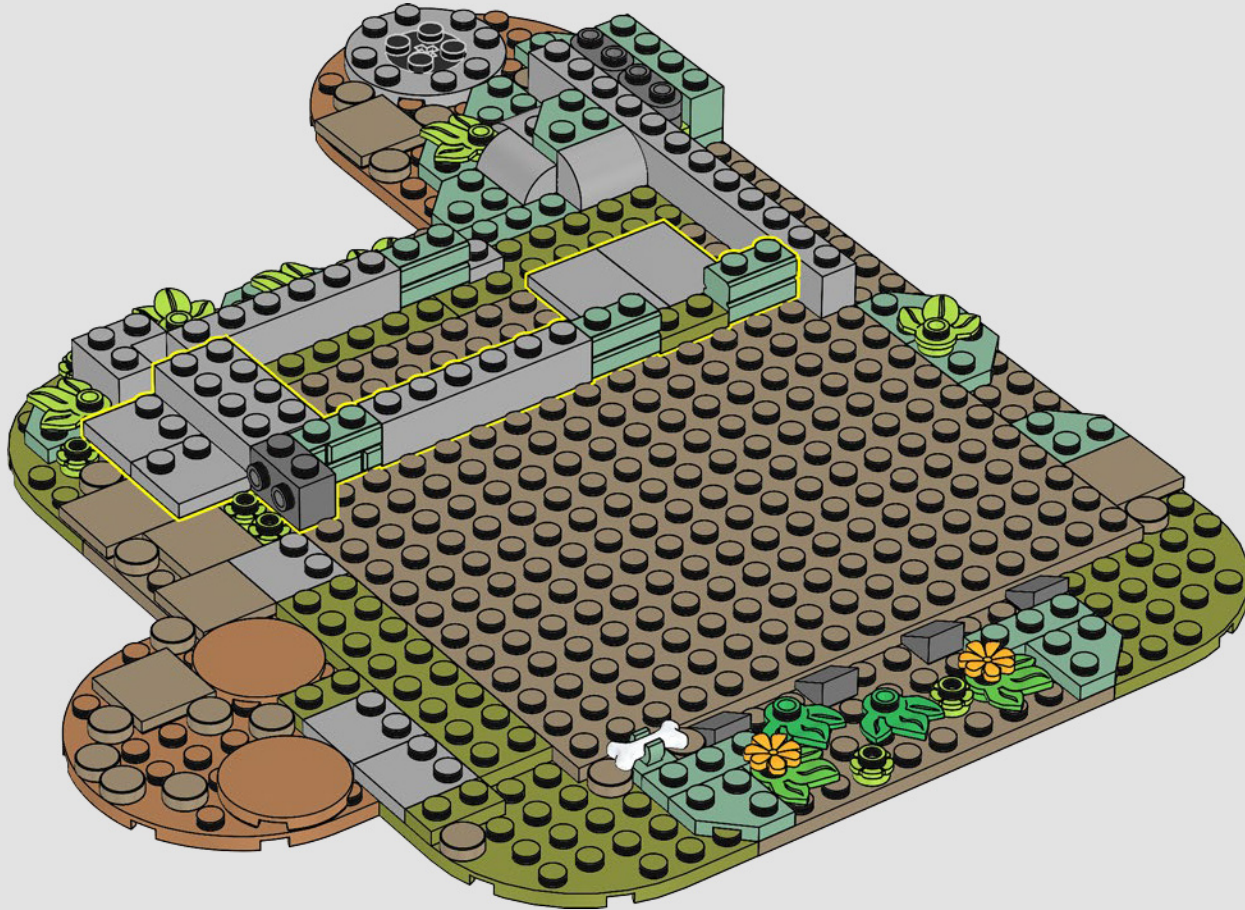

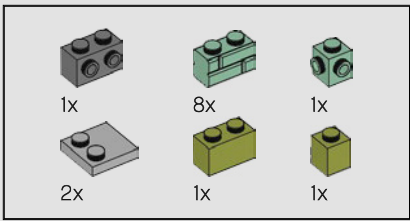

19

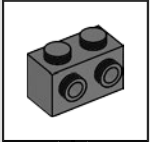
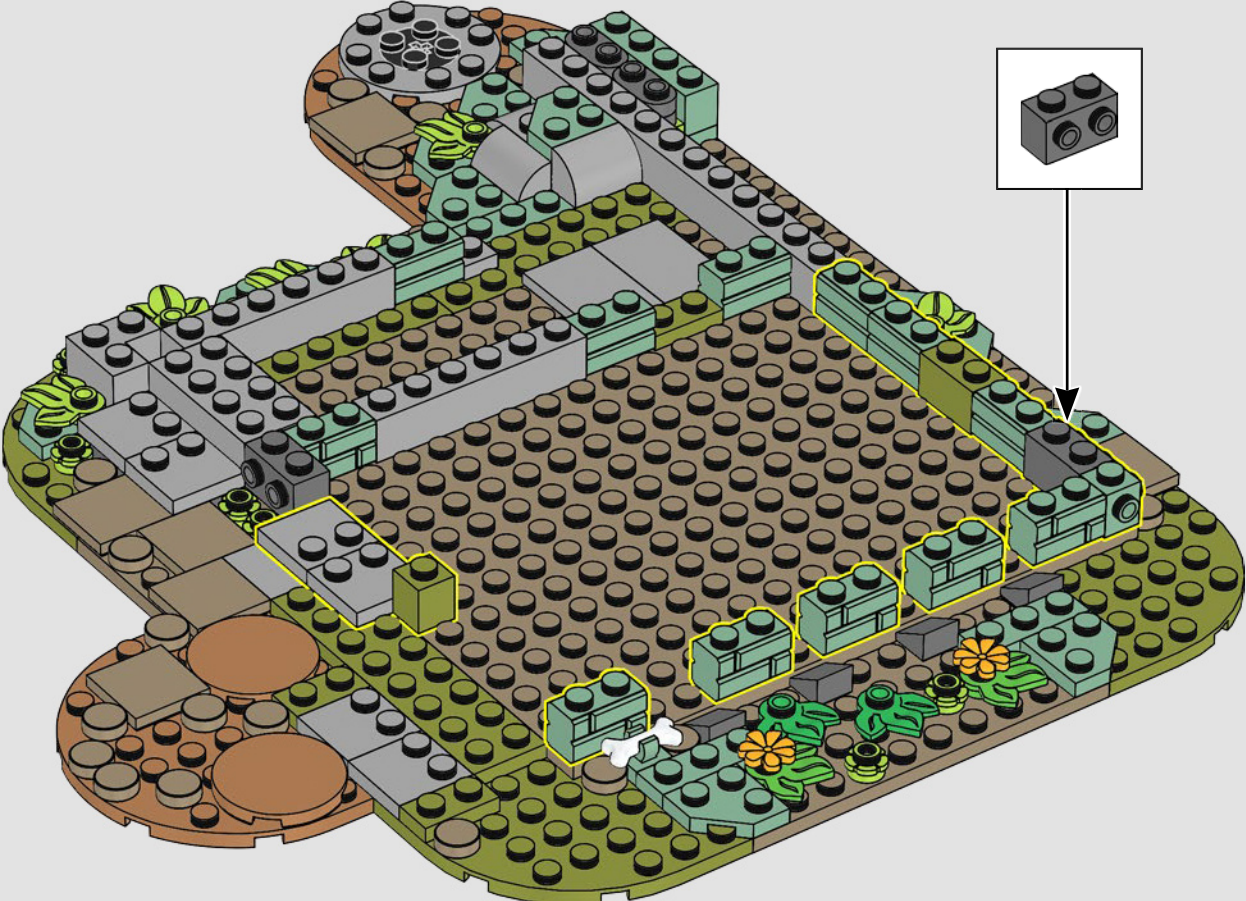

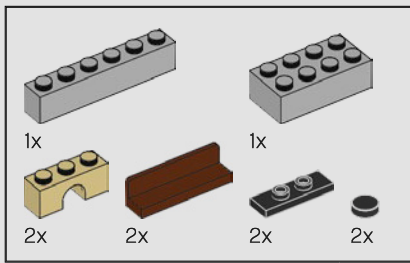

20

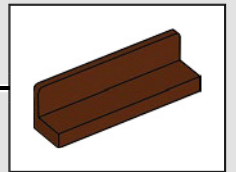
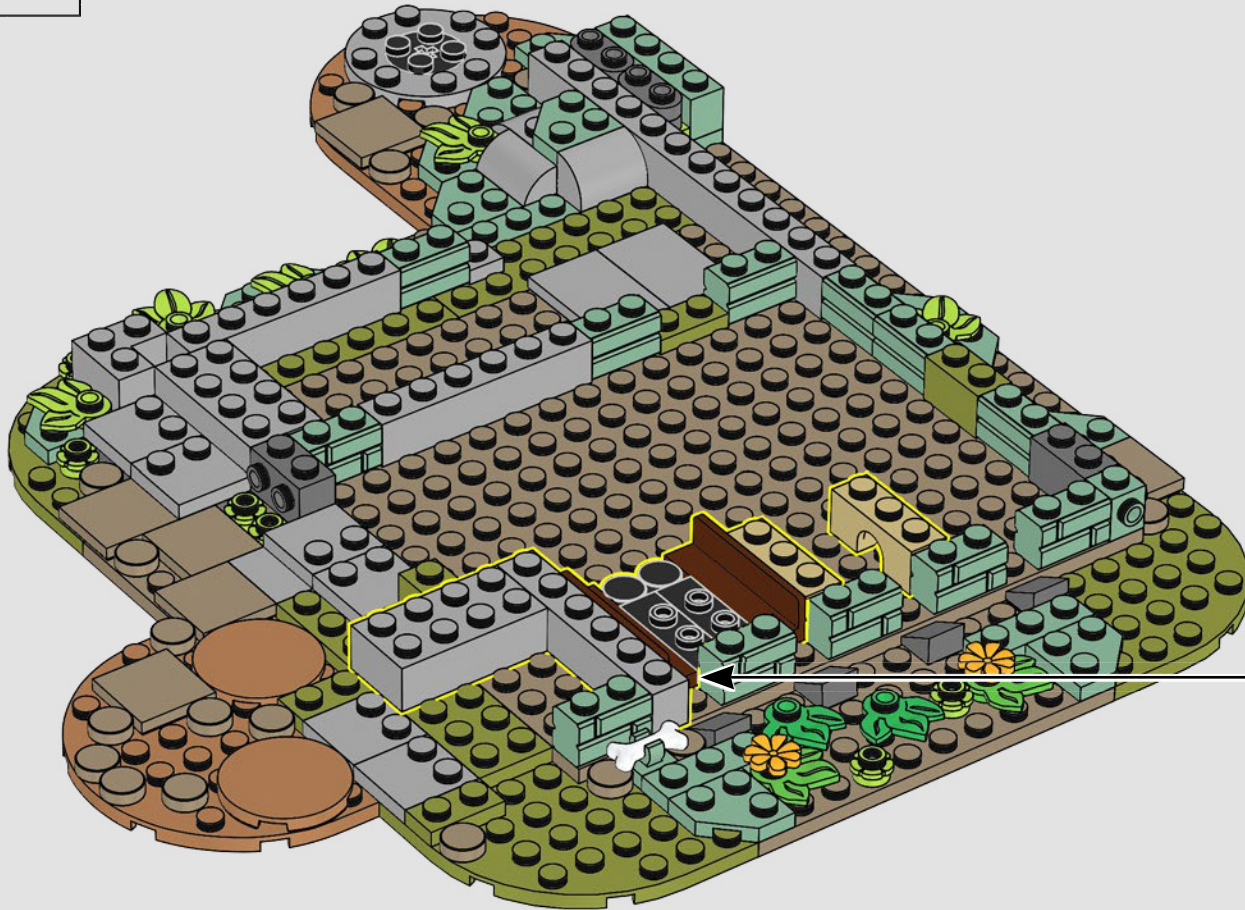

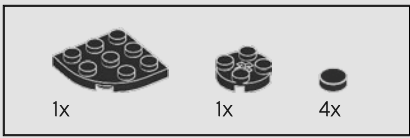

21

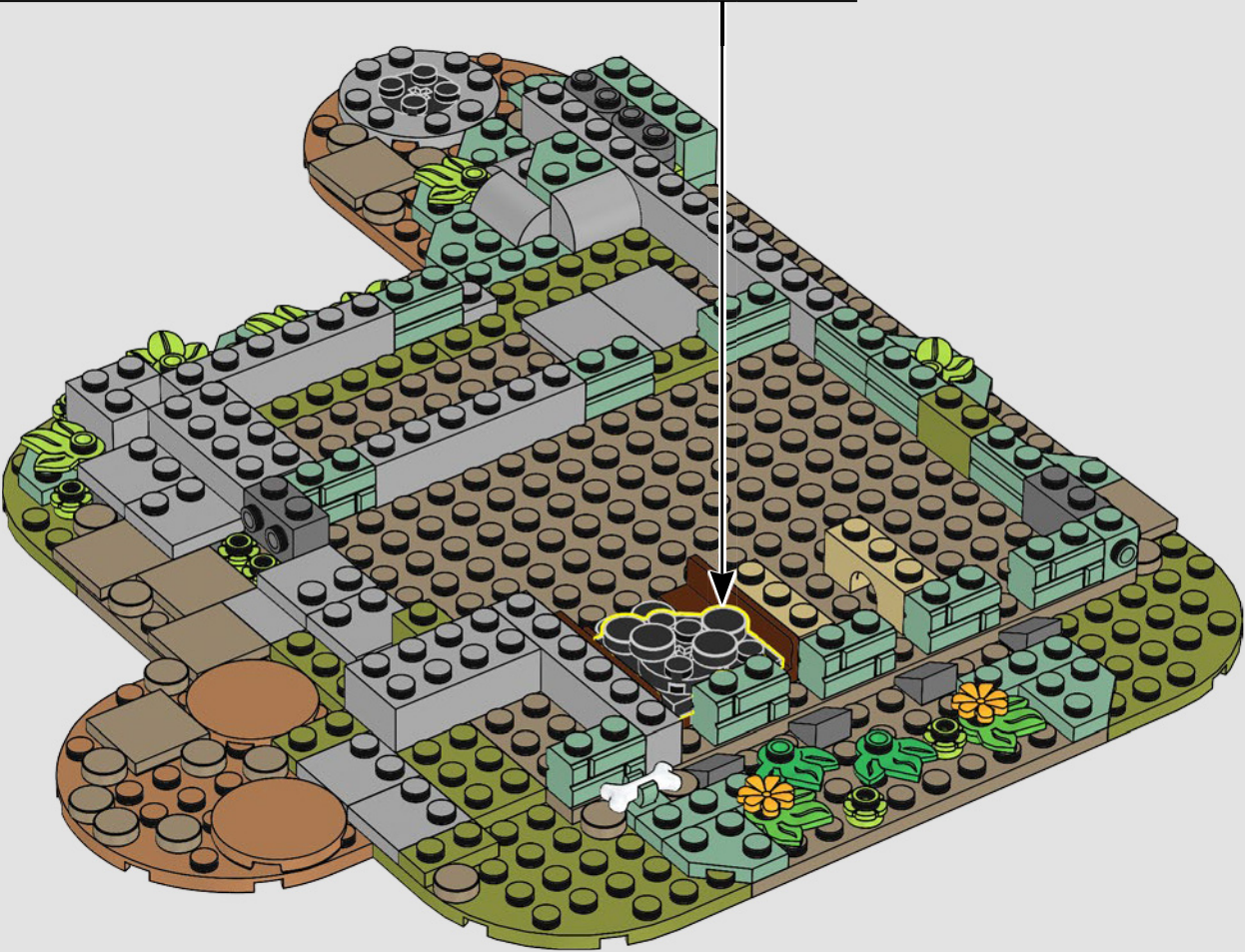
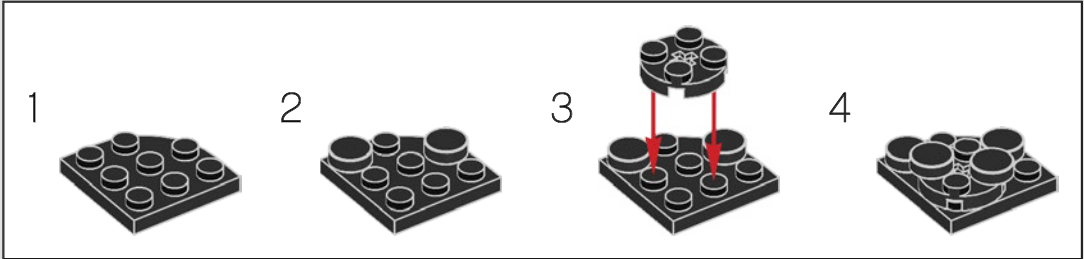

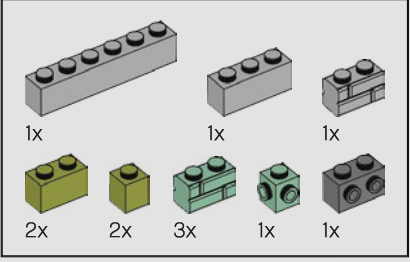
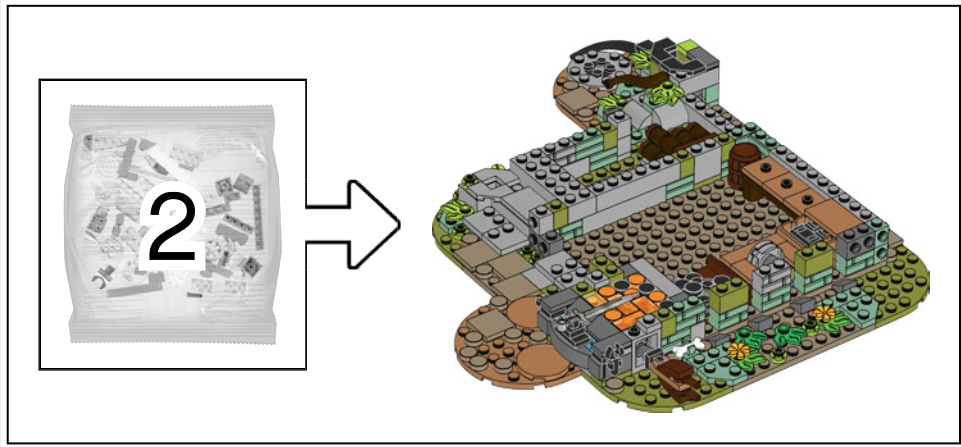

22

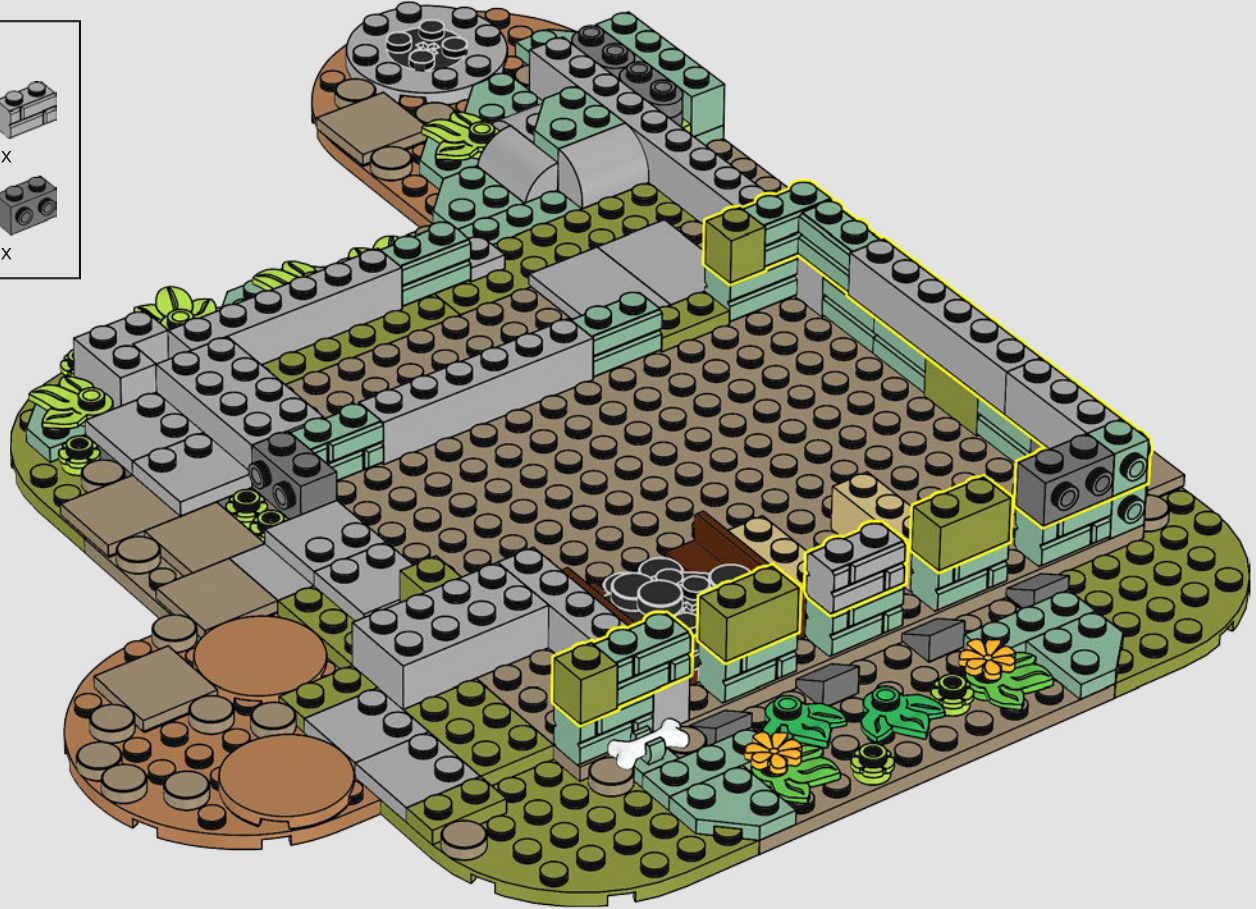

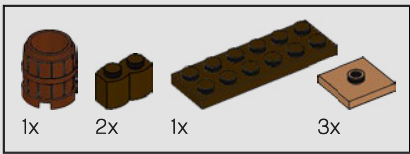

23

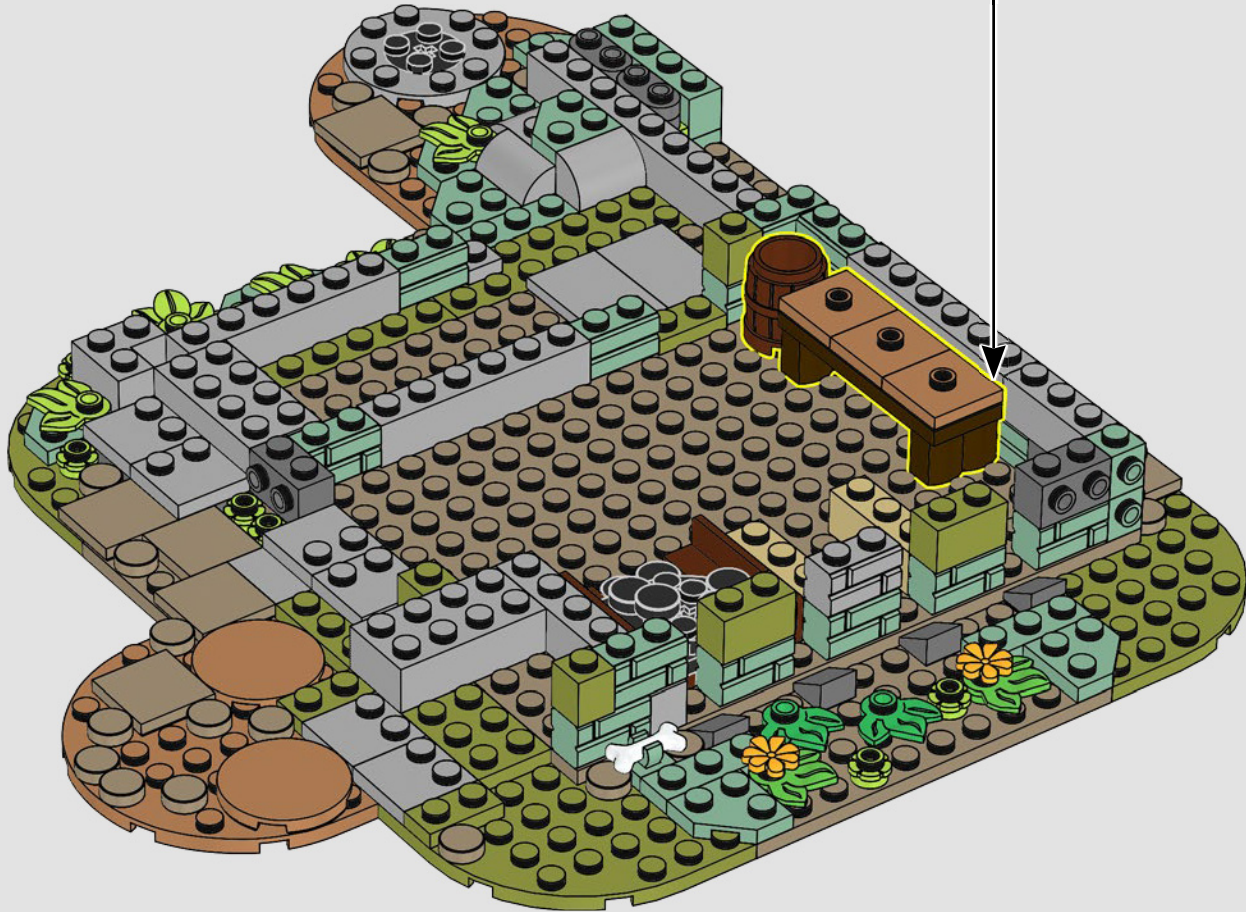
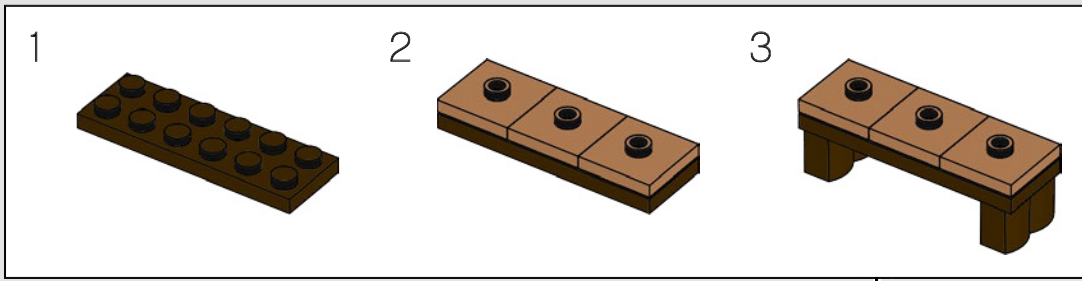

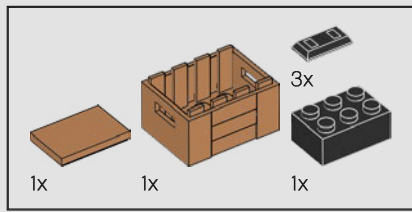

24

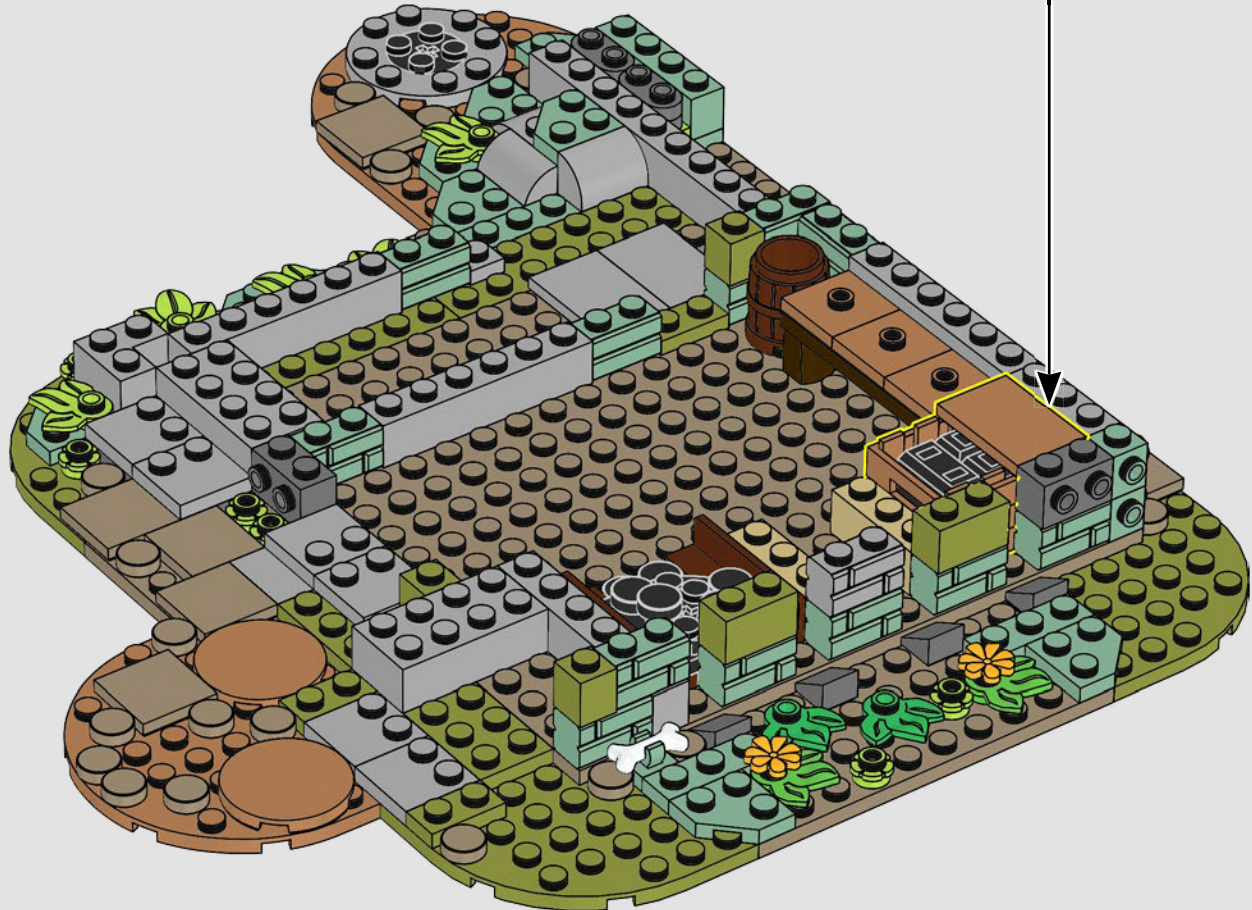
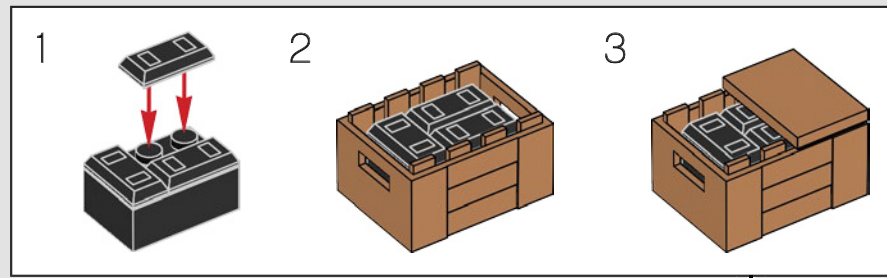

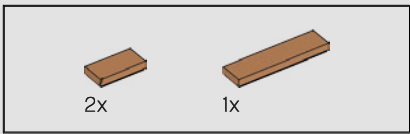

25



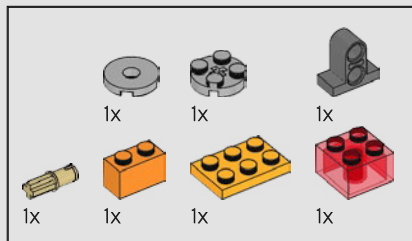

26

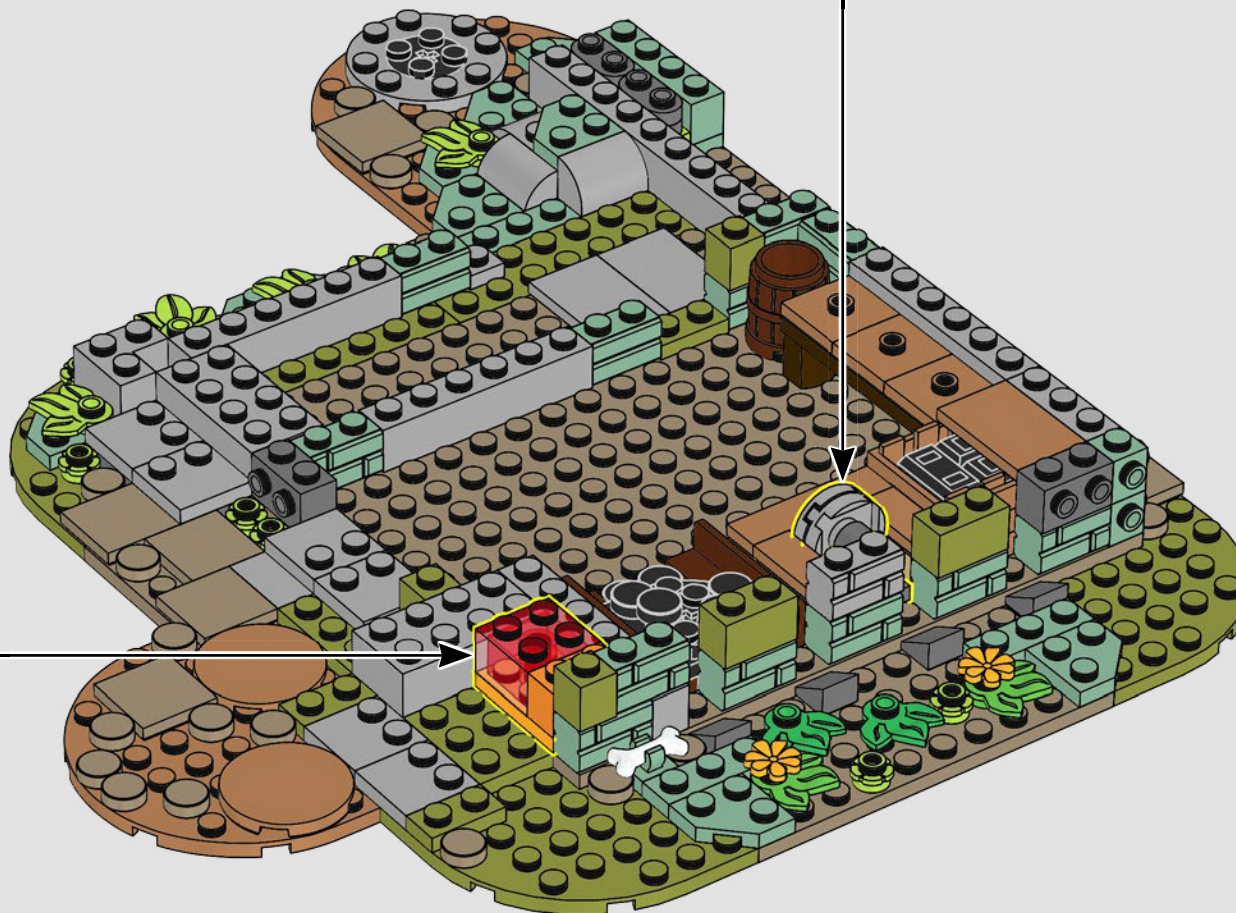
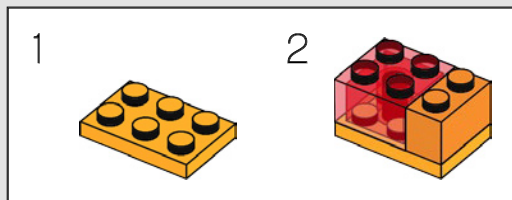
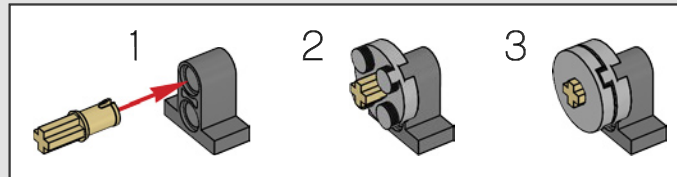

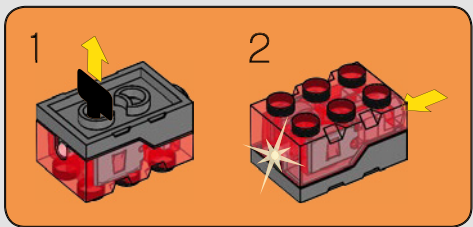
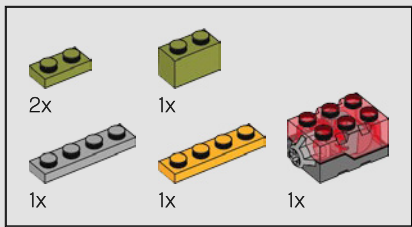

27

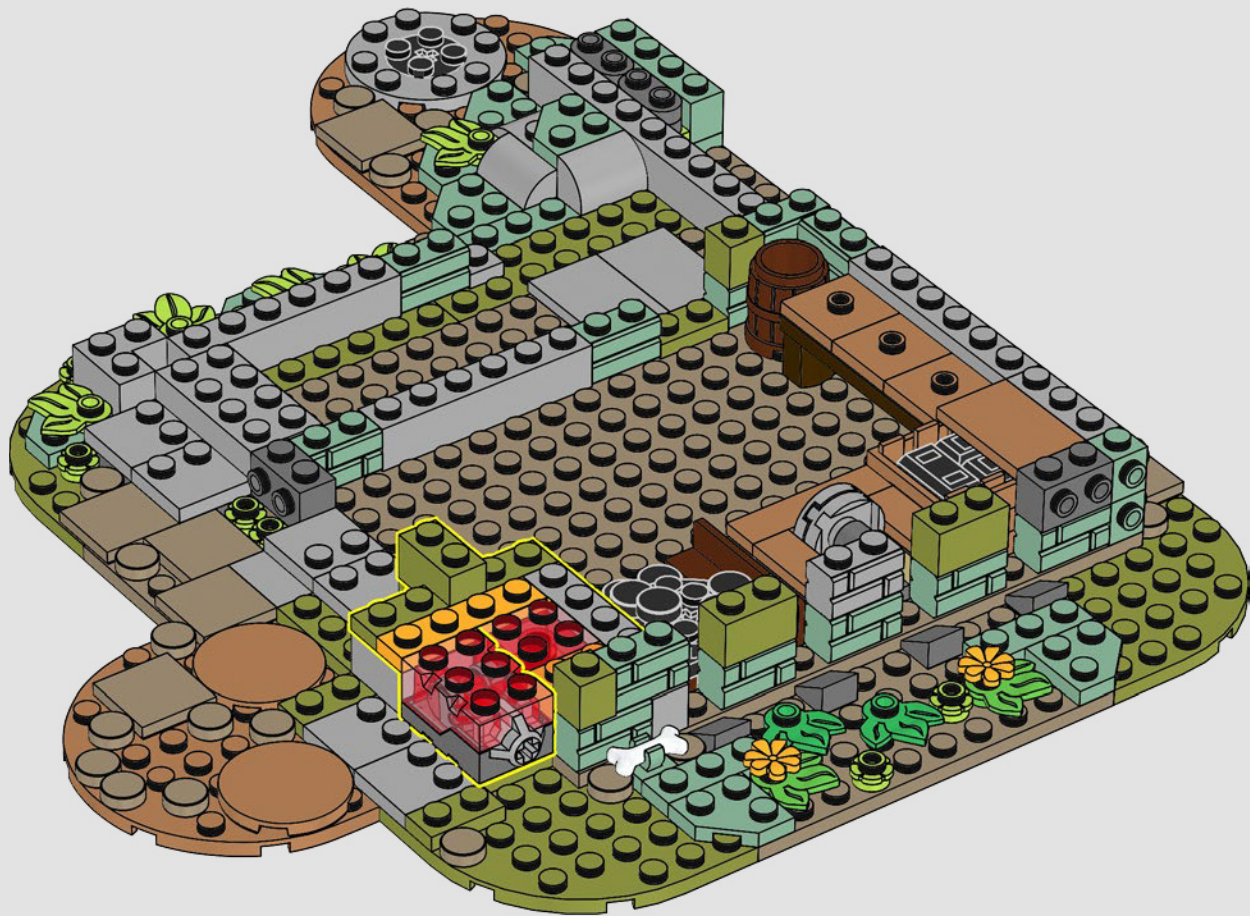

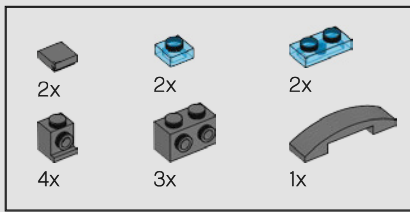

28

1

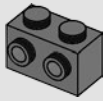

2

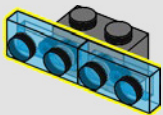

3

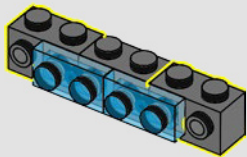

4

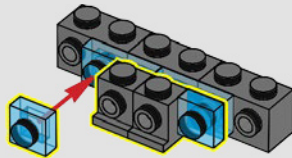

5

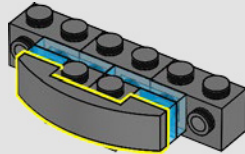

6

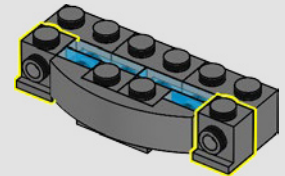

7

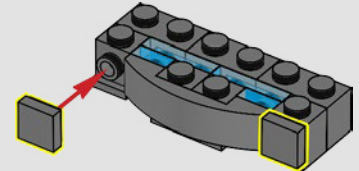



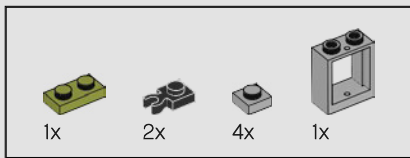

29

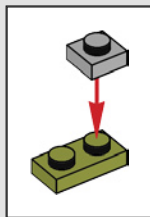
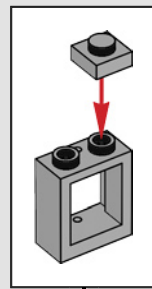

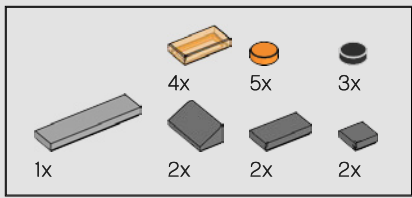

30



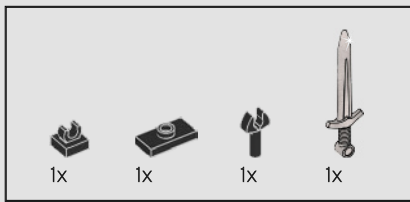

31

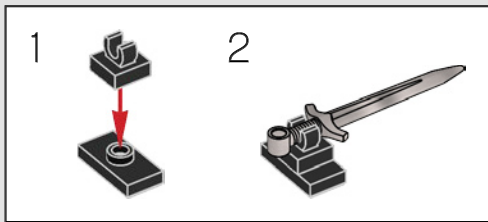

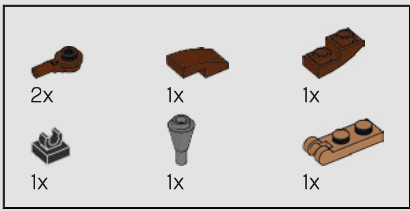

32

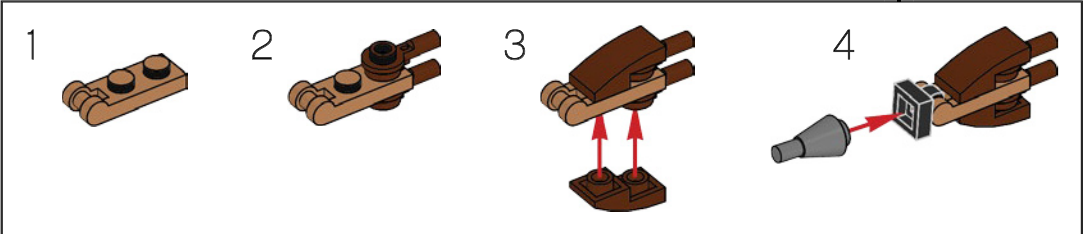
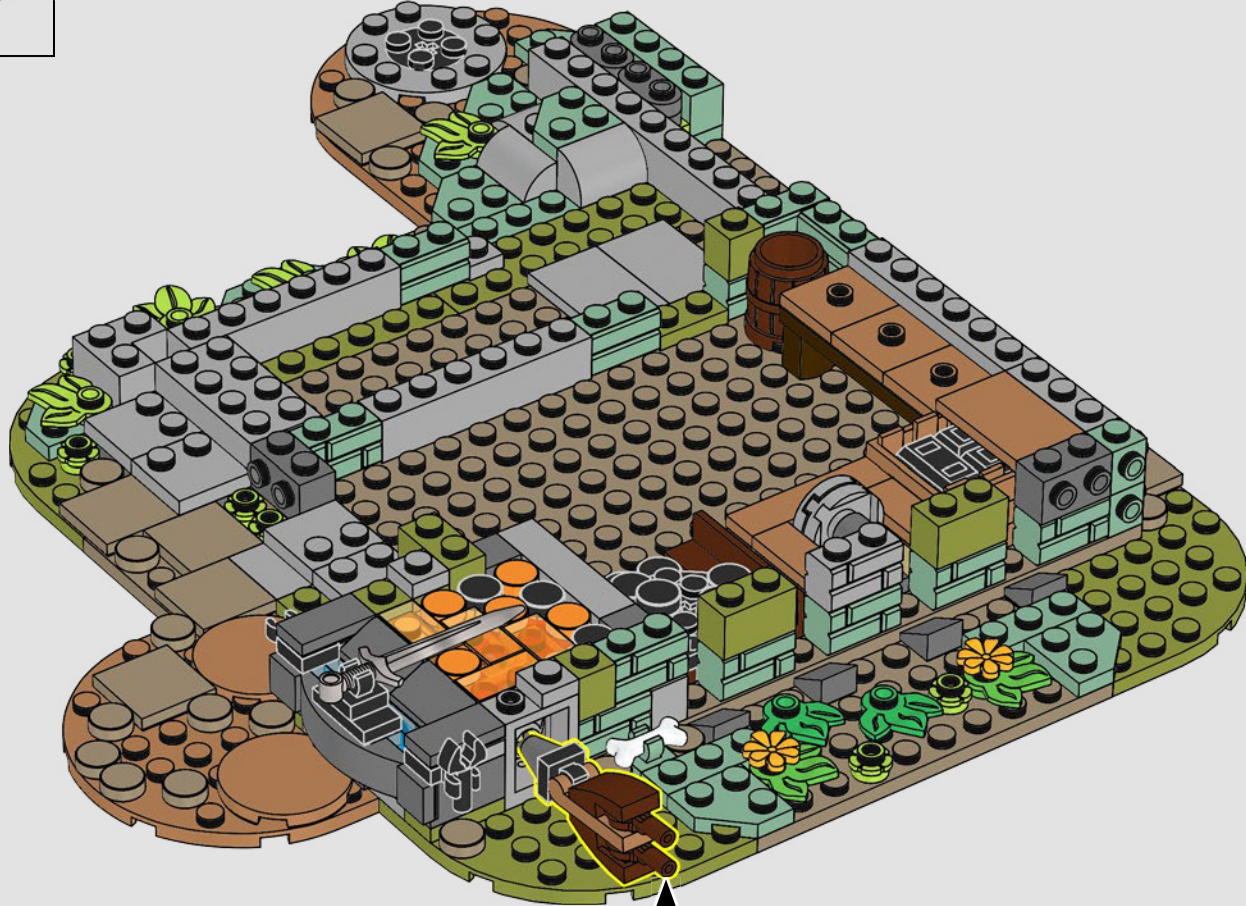

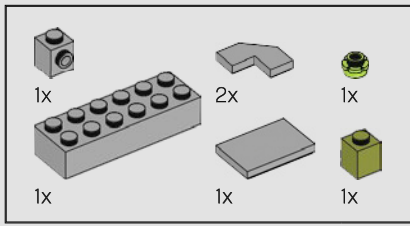

33



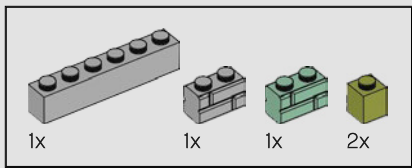

34

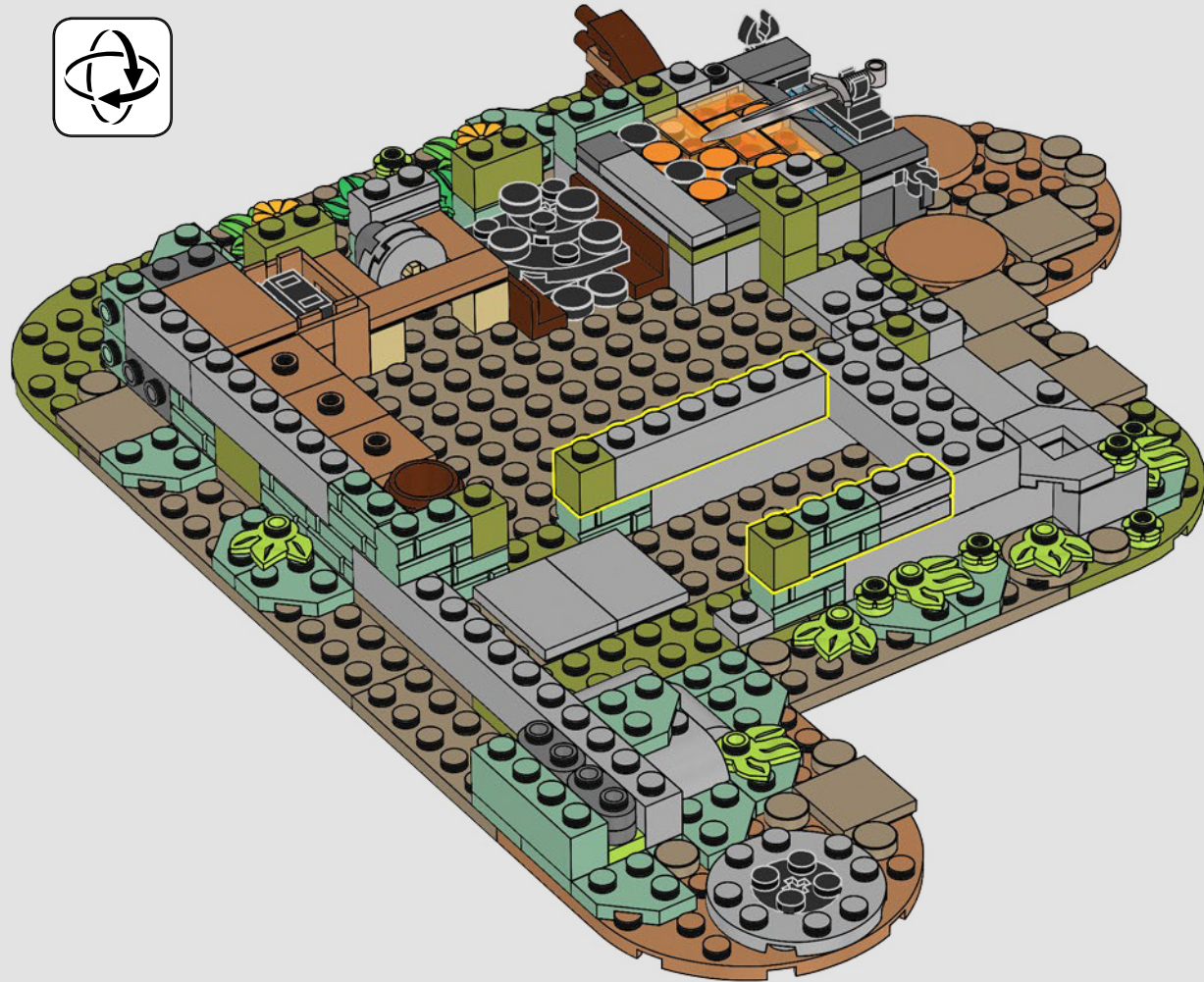

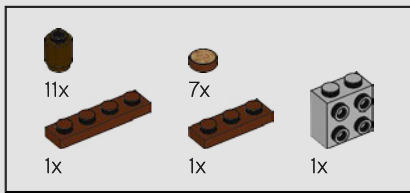

35

1

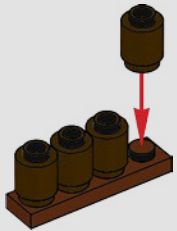

2



3



4

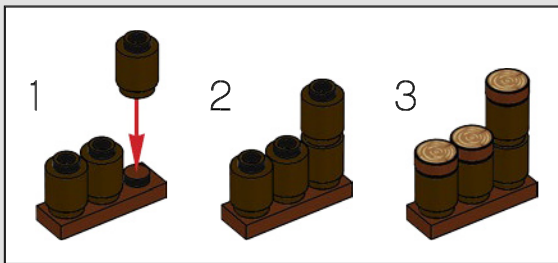
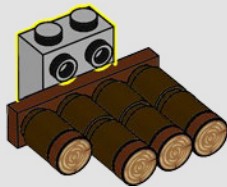

5

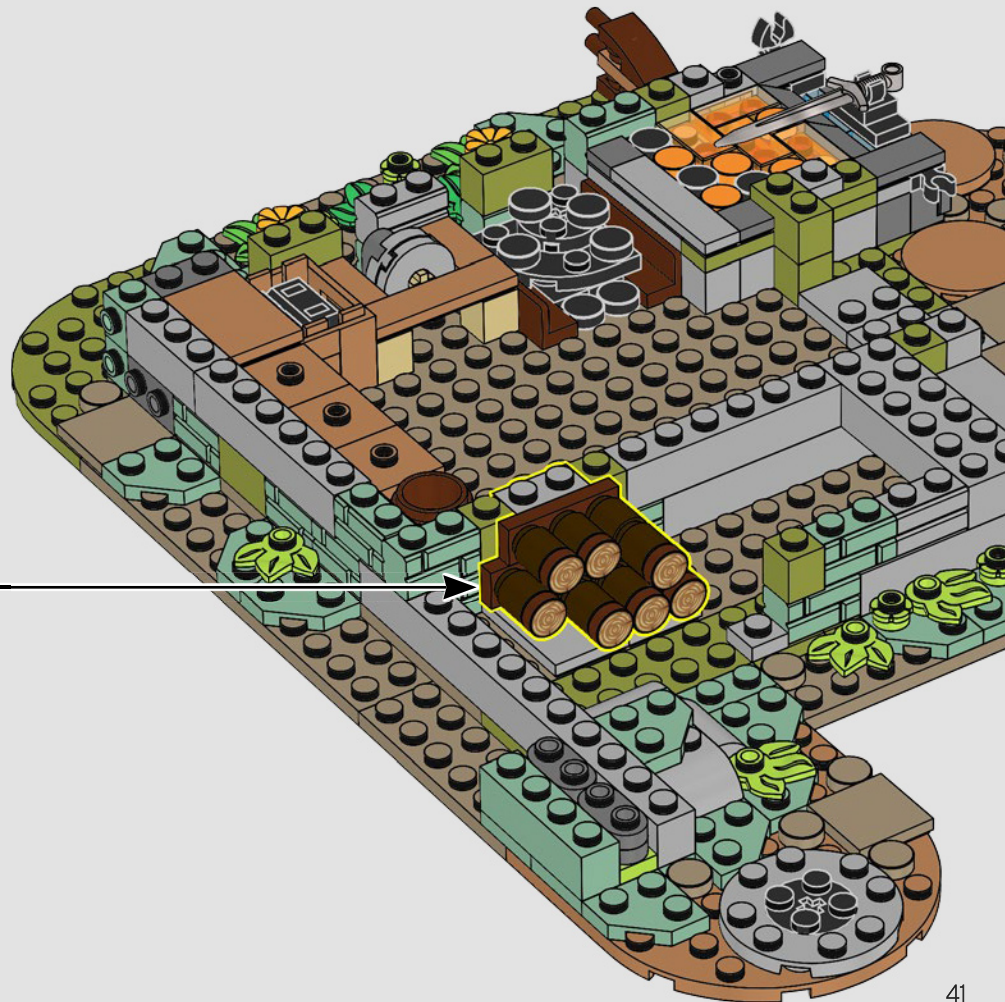
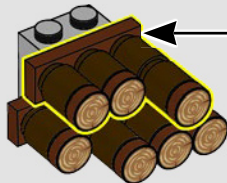

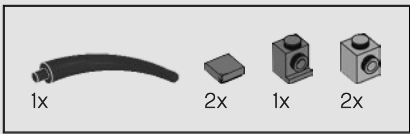

36

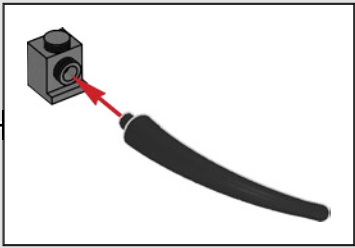
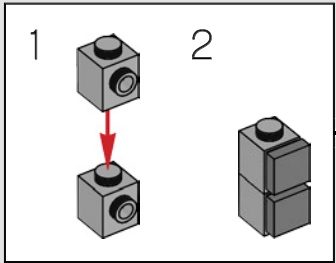
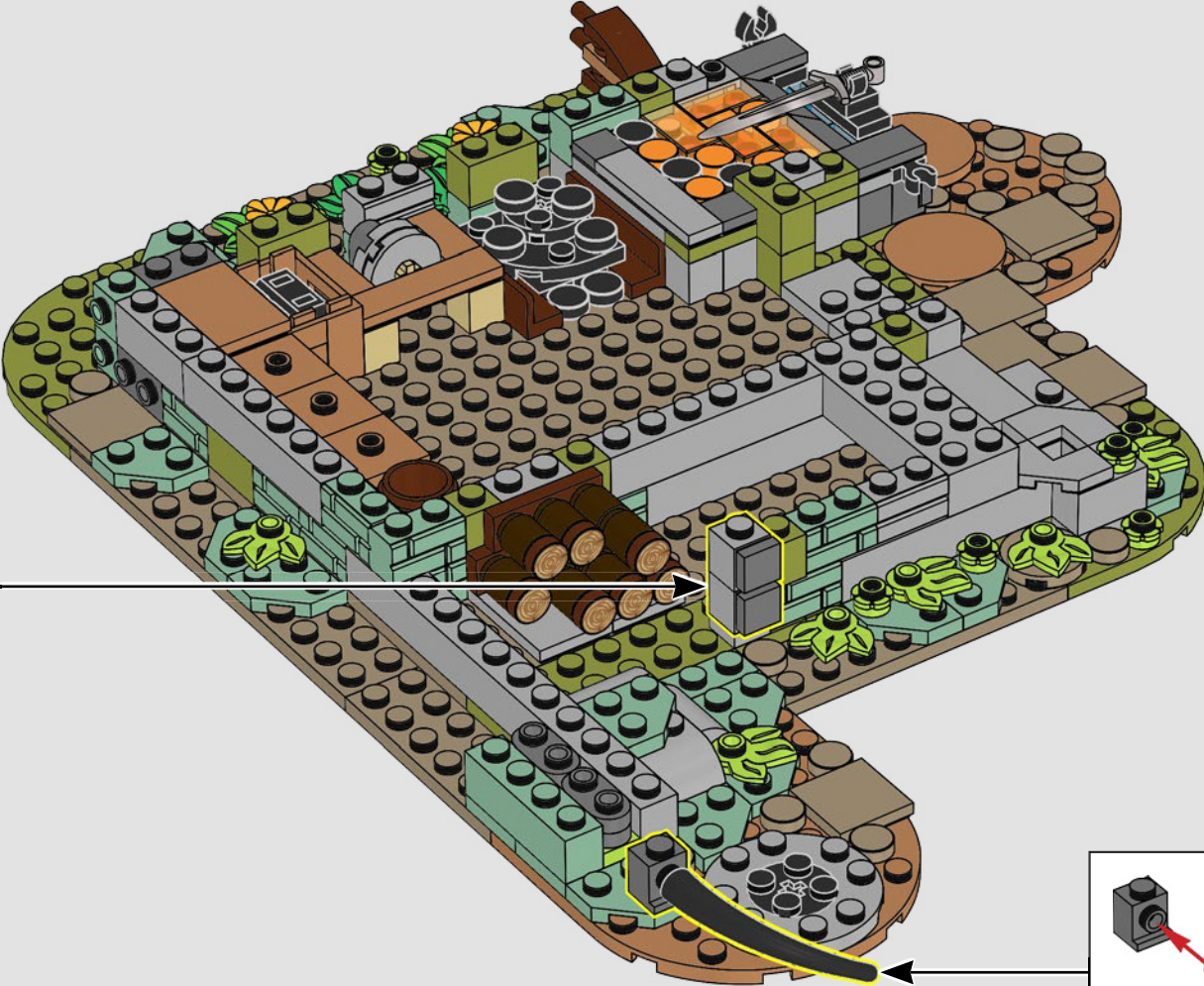

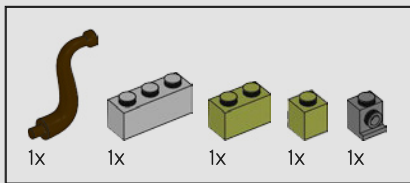

37

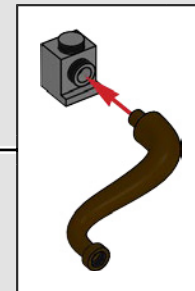
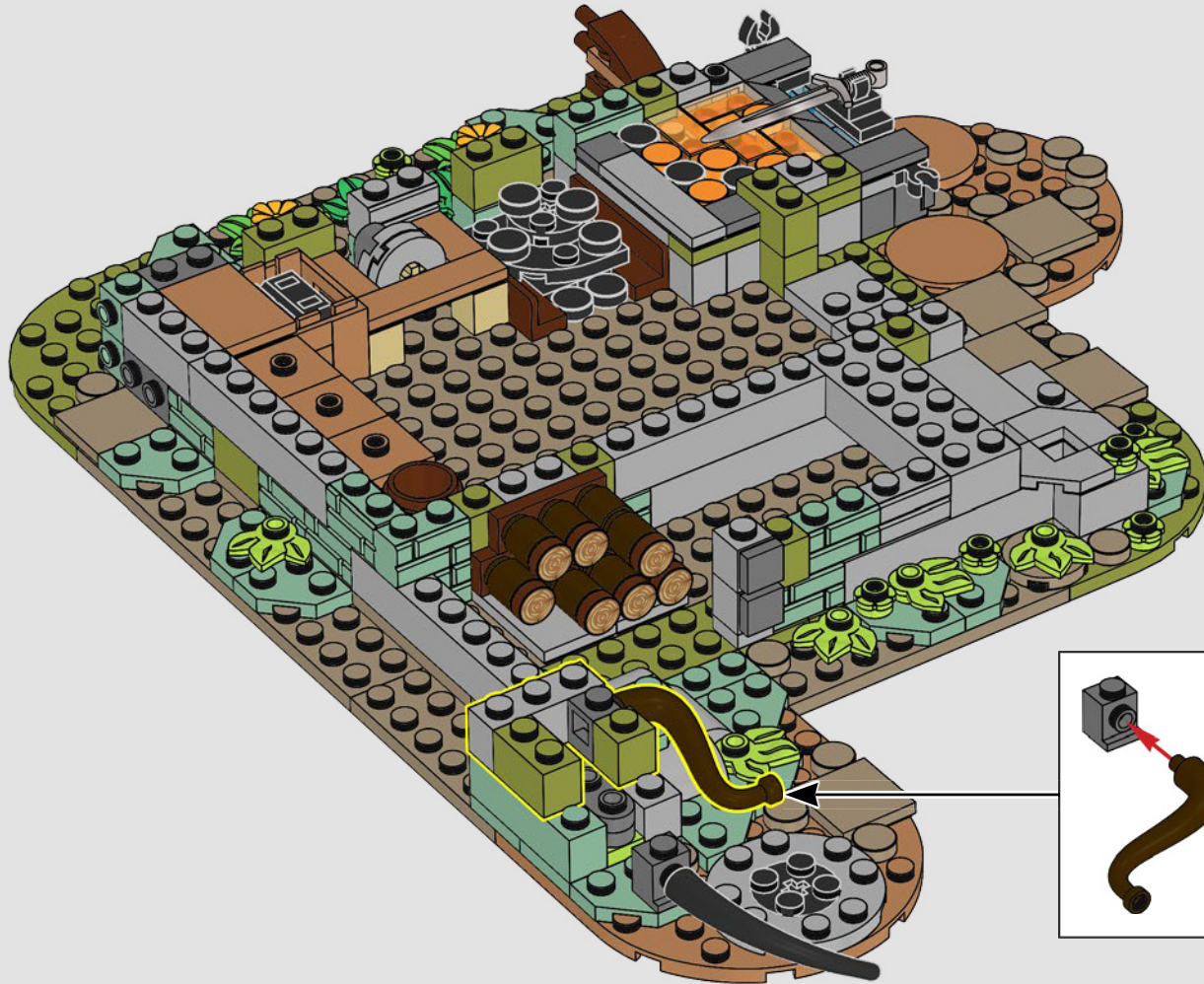

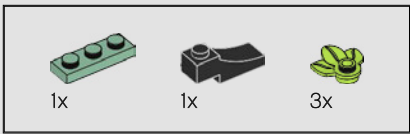

38

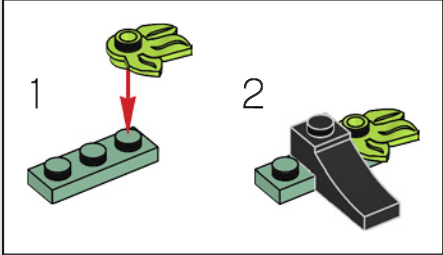
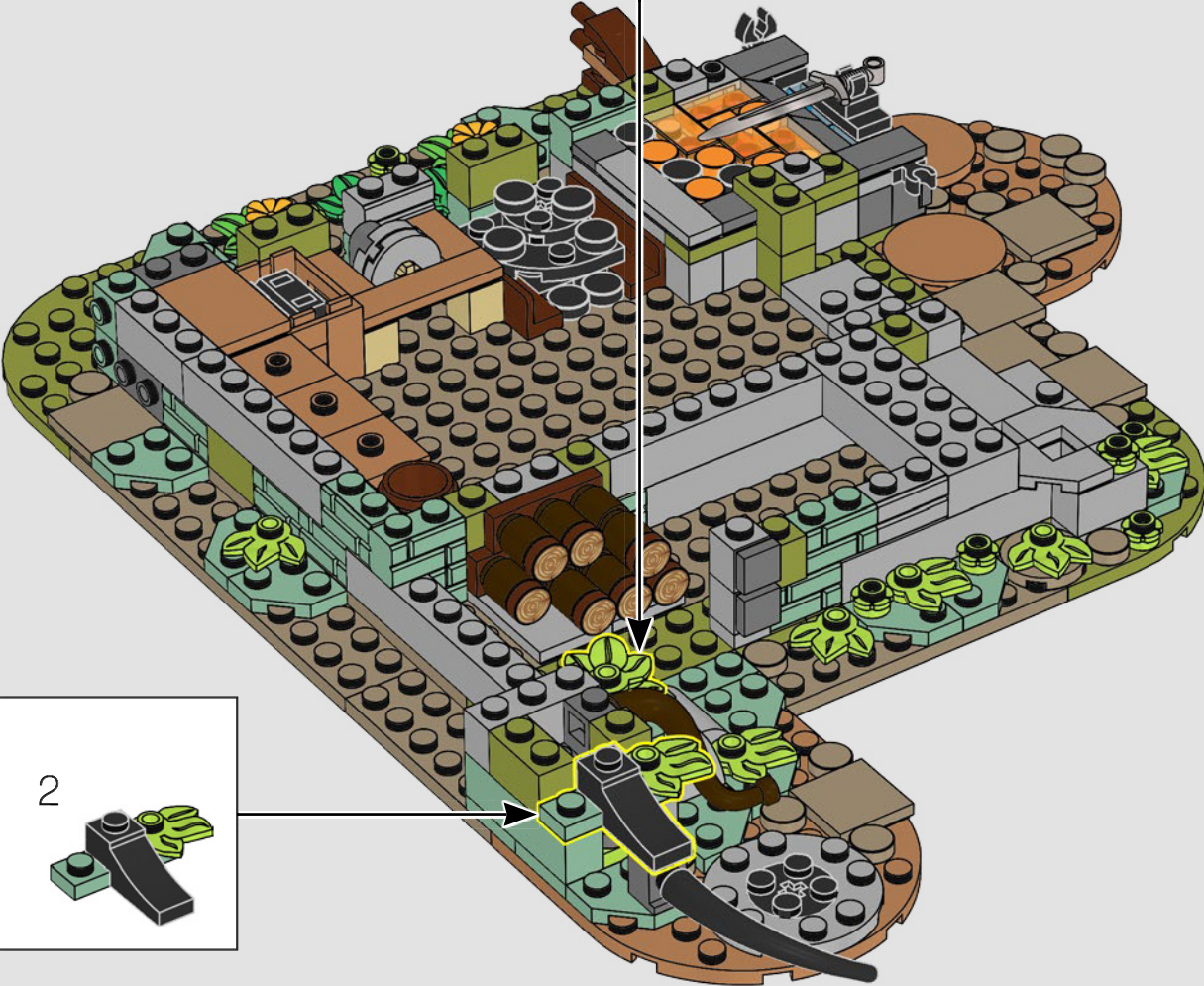
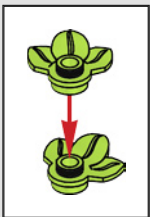

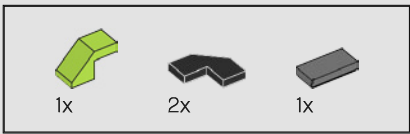

39



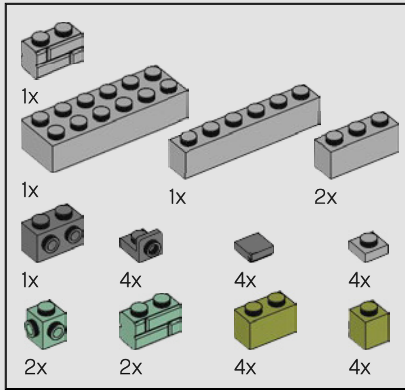
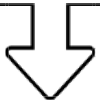

40

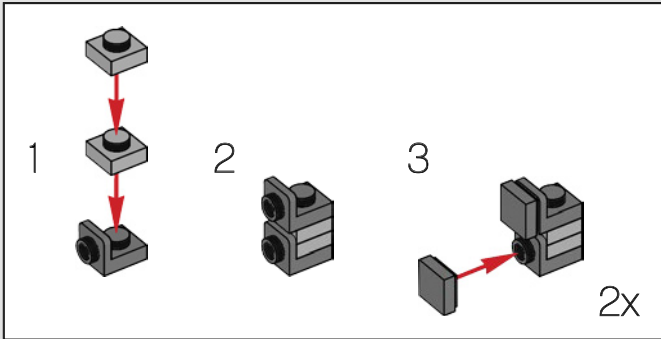
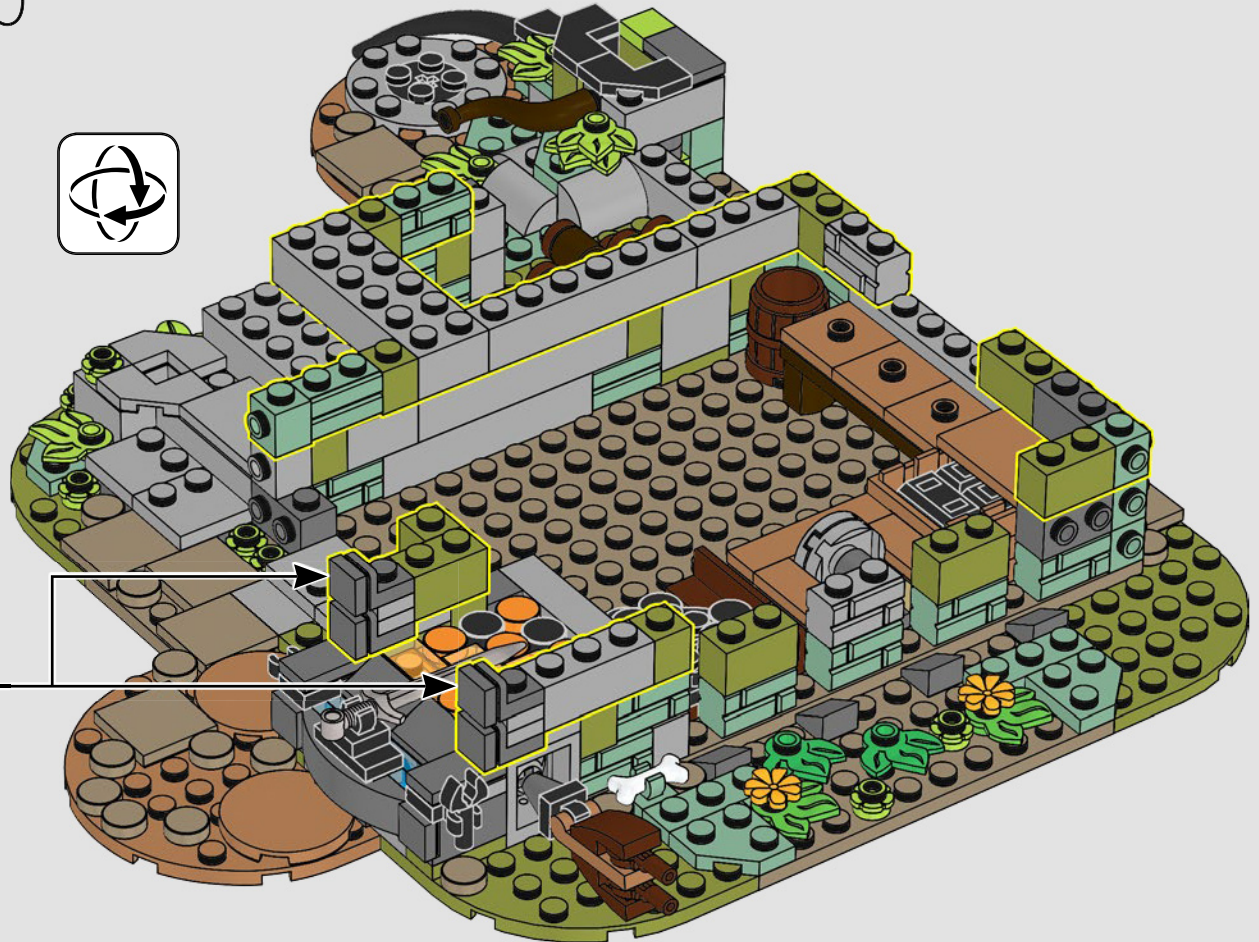
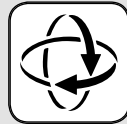

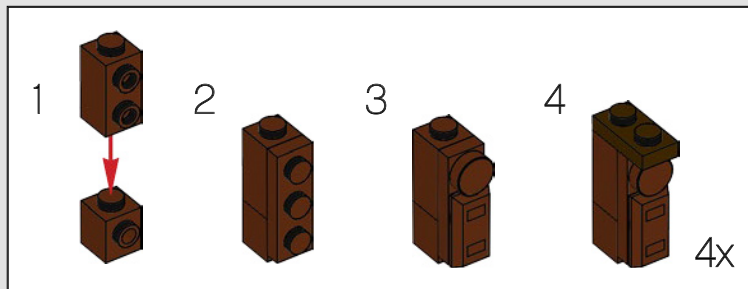
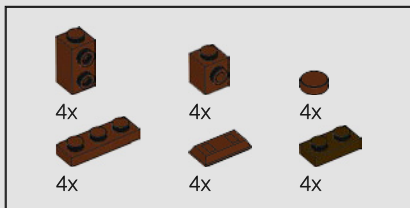

41

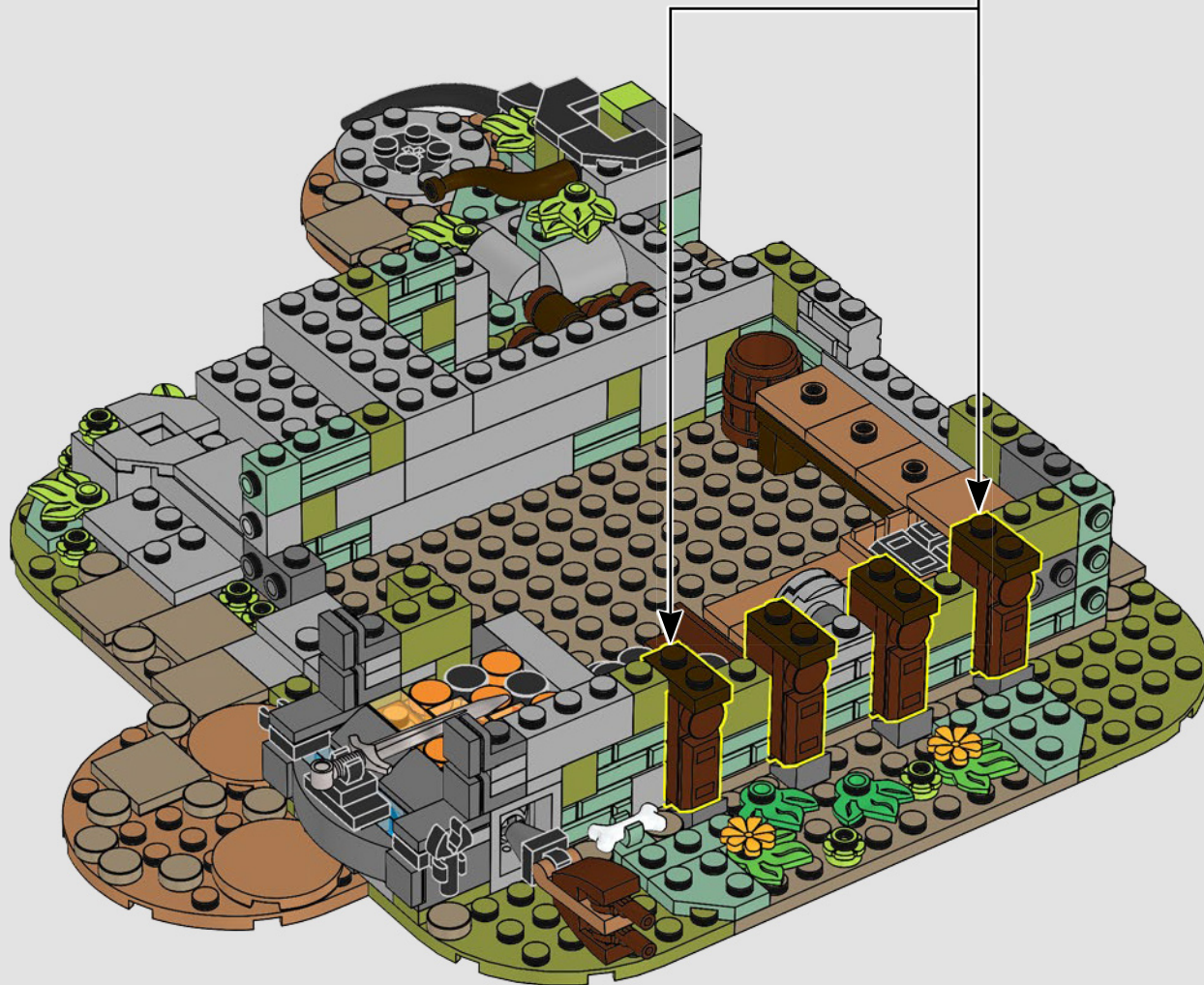

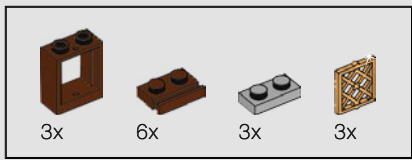

42

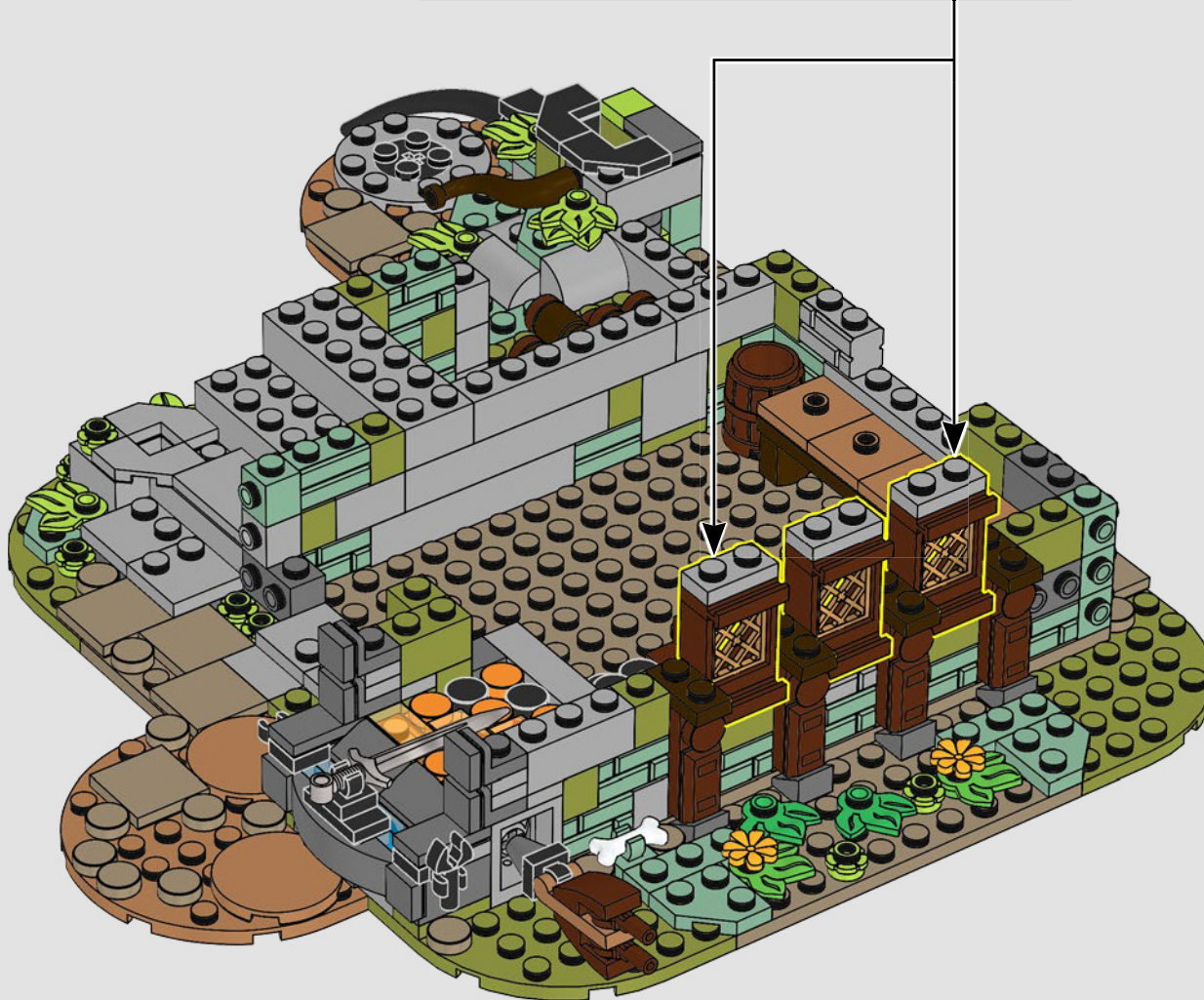
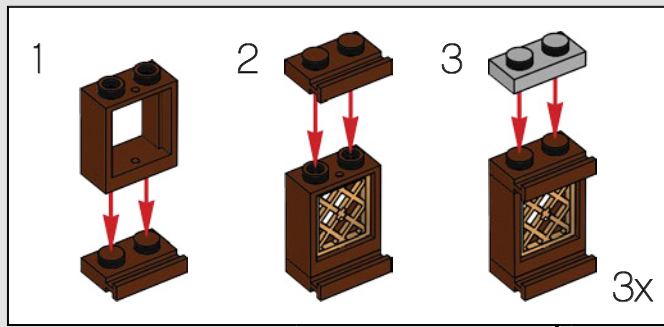

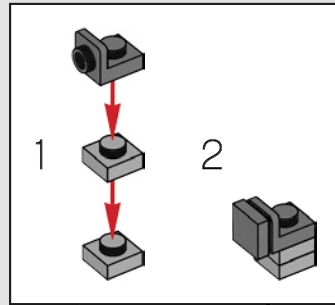
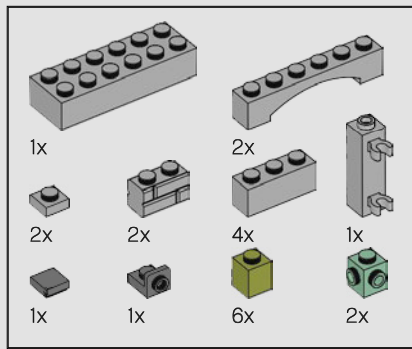

43

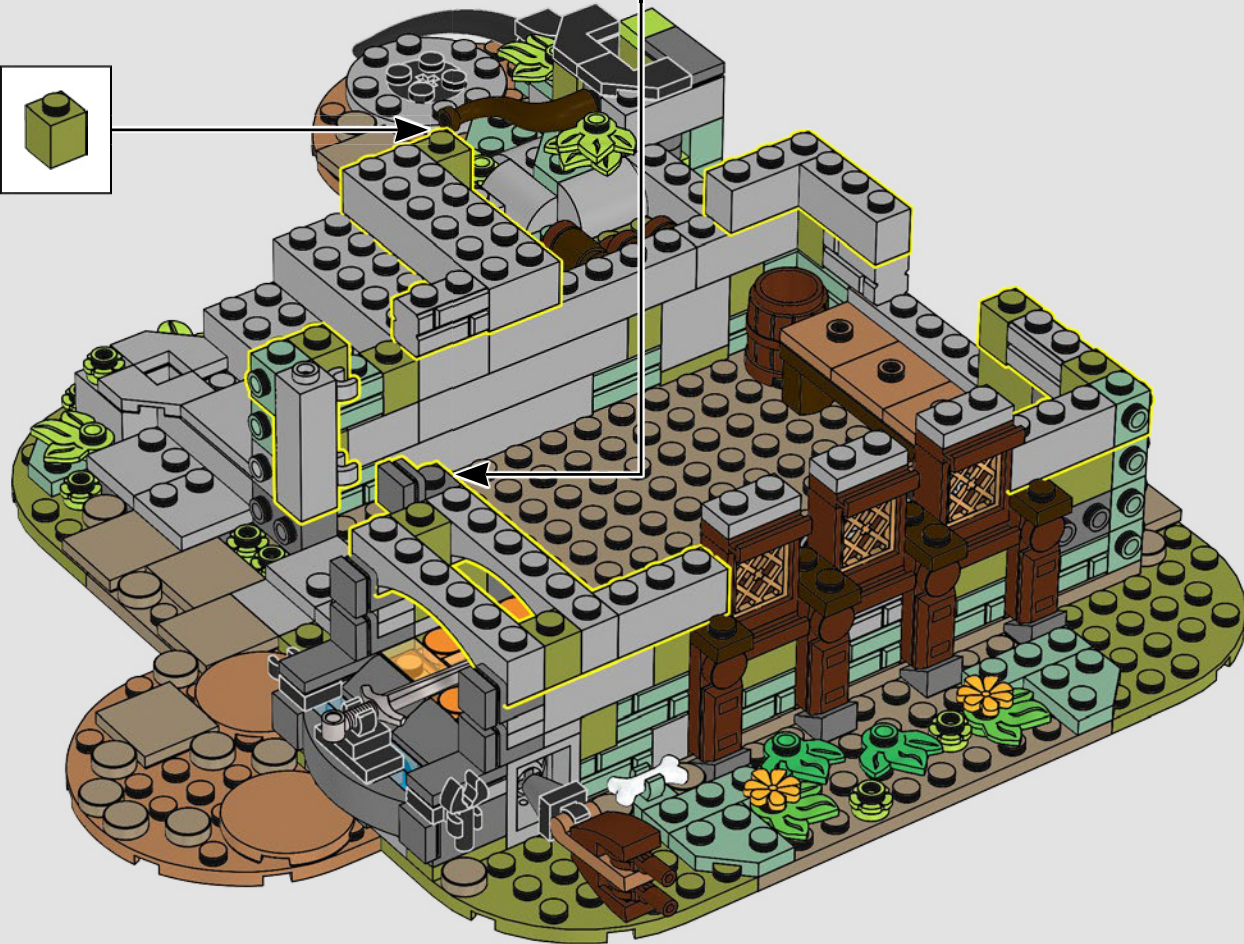
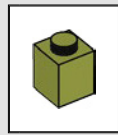

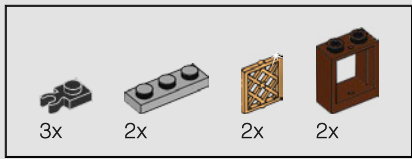

44

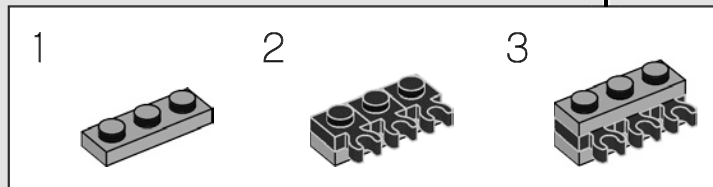
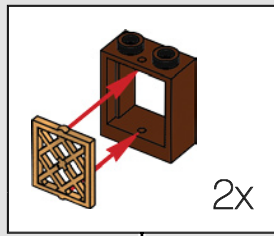

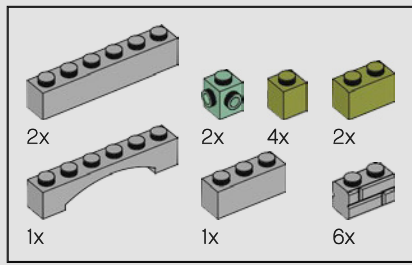

45

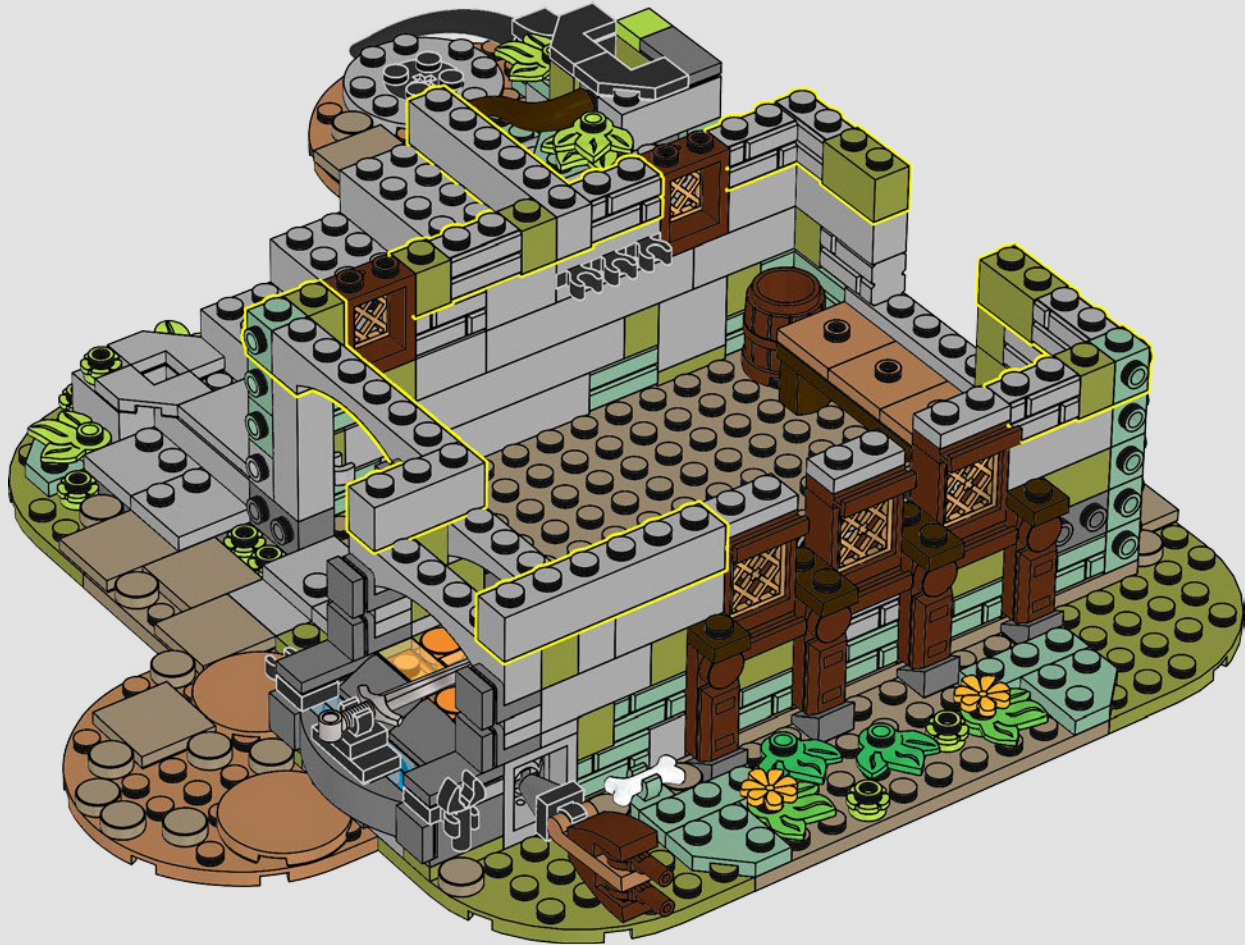



46

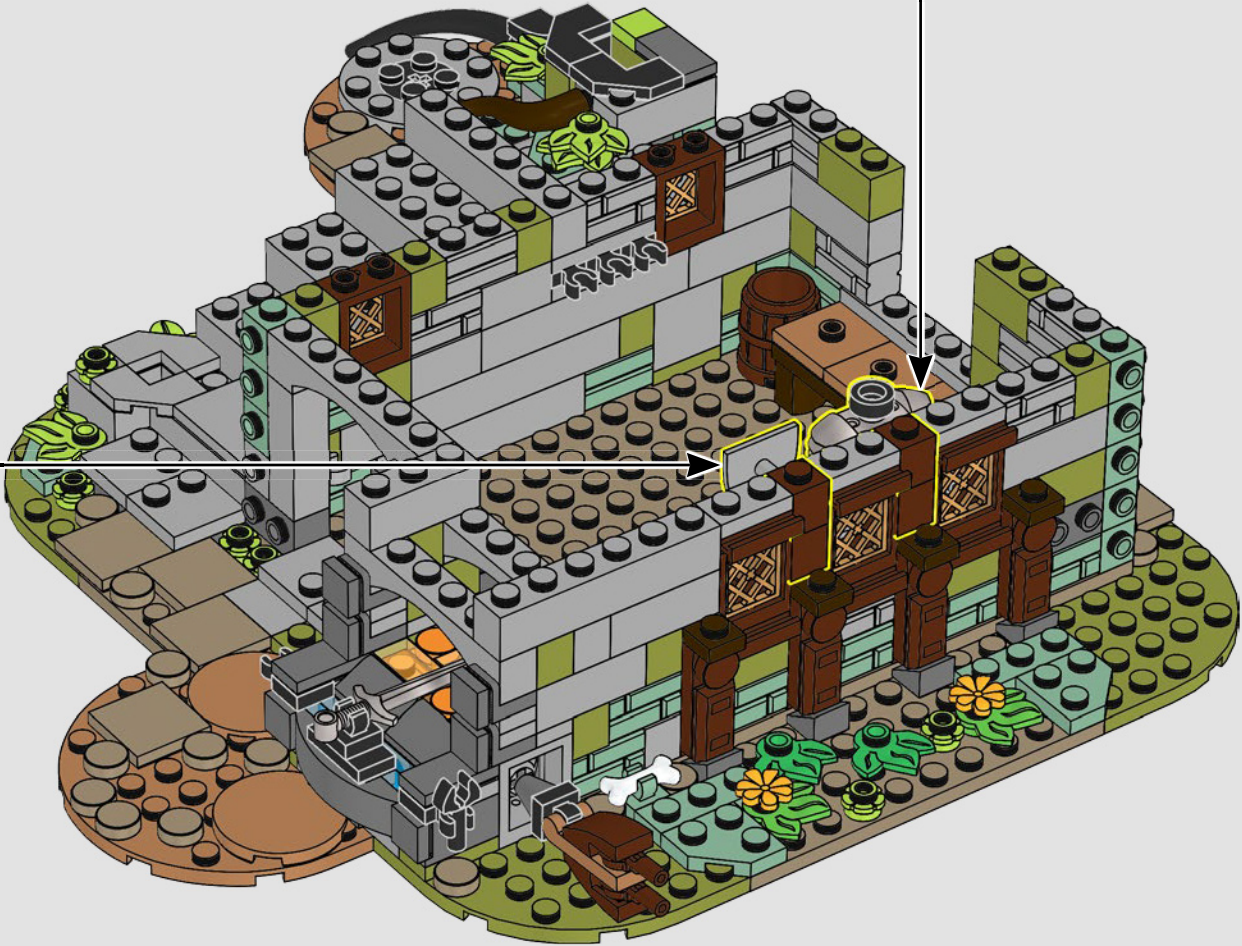
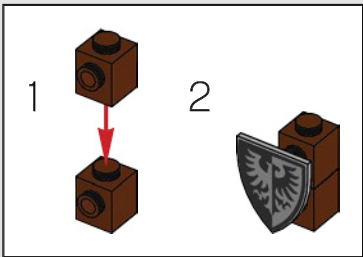
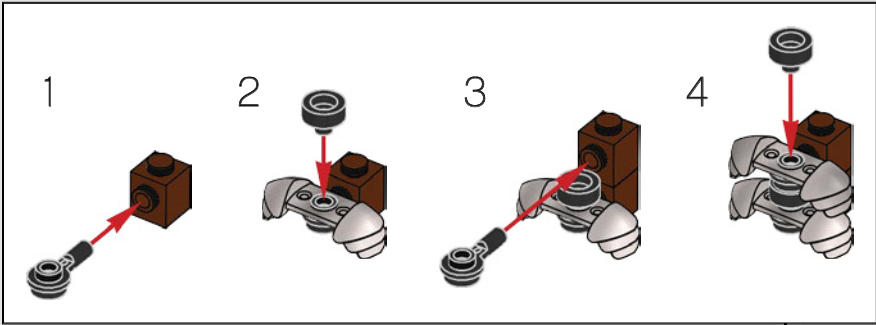

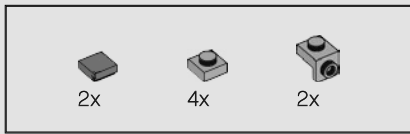

47

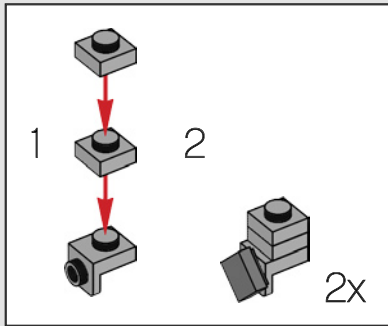

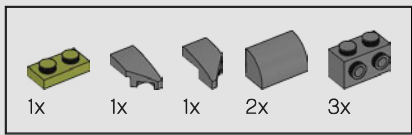

48

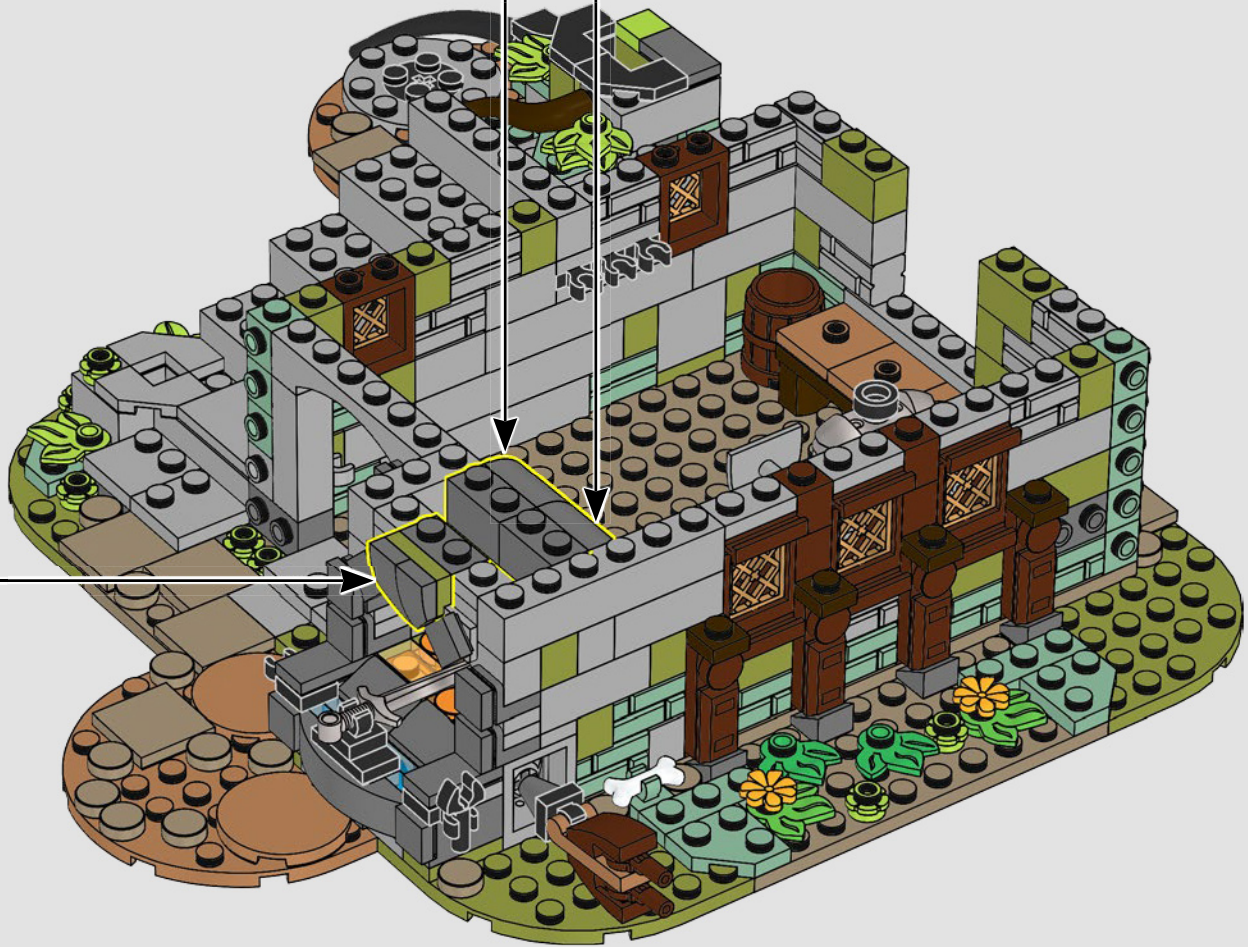
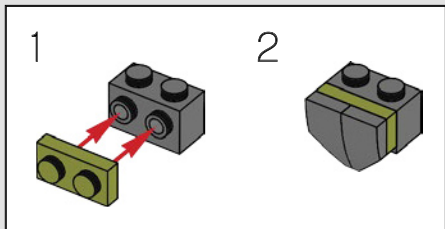
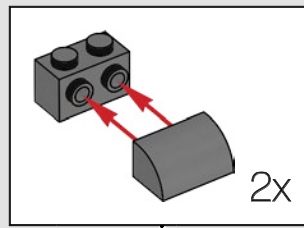



49

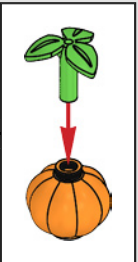
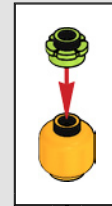

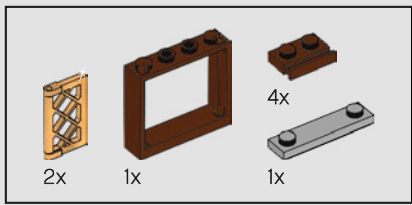

50

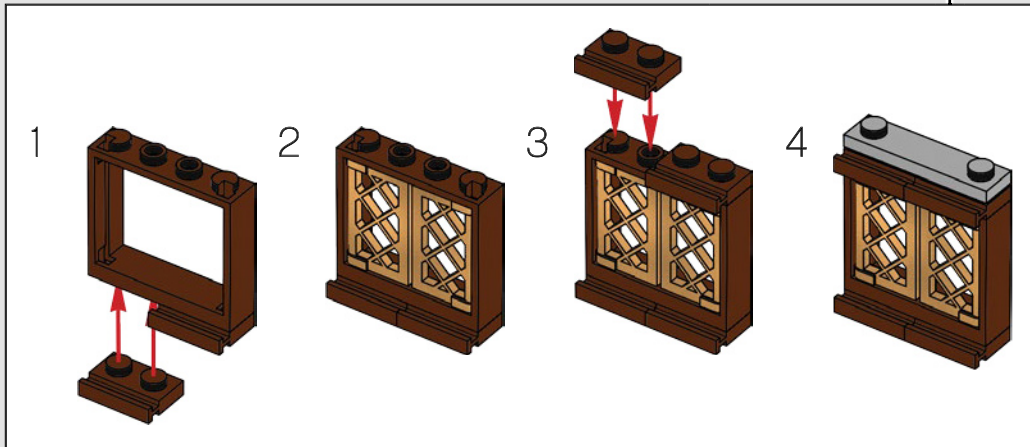
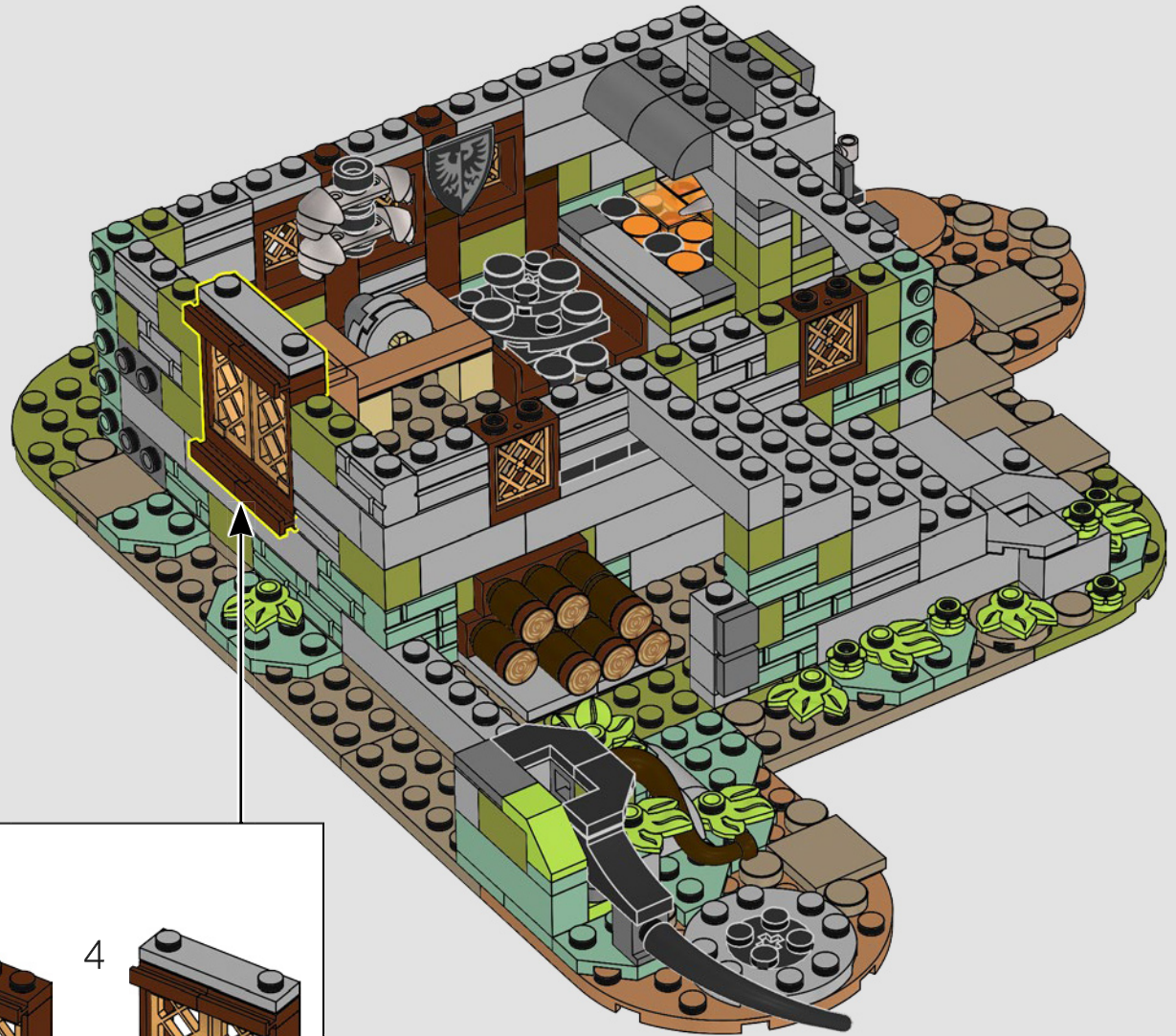

56

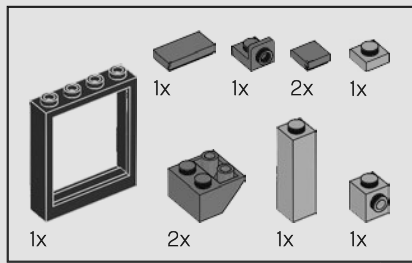

51

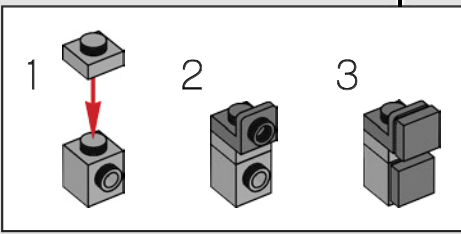
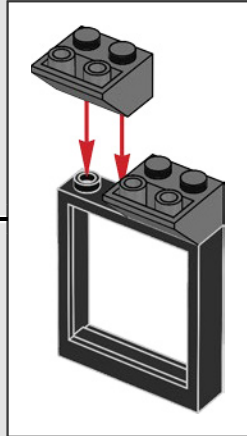

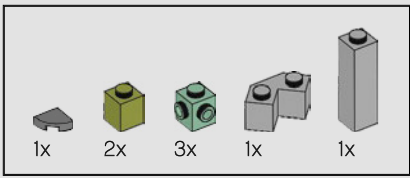

52

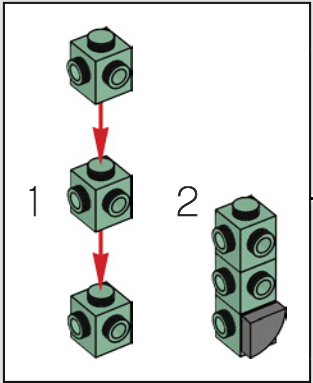
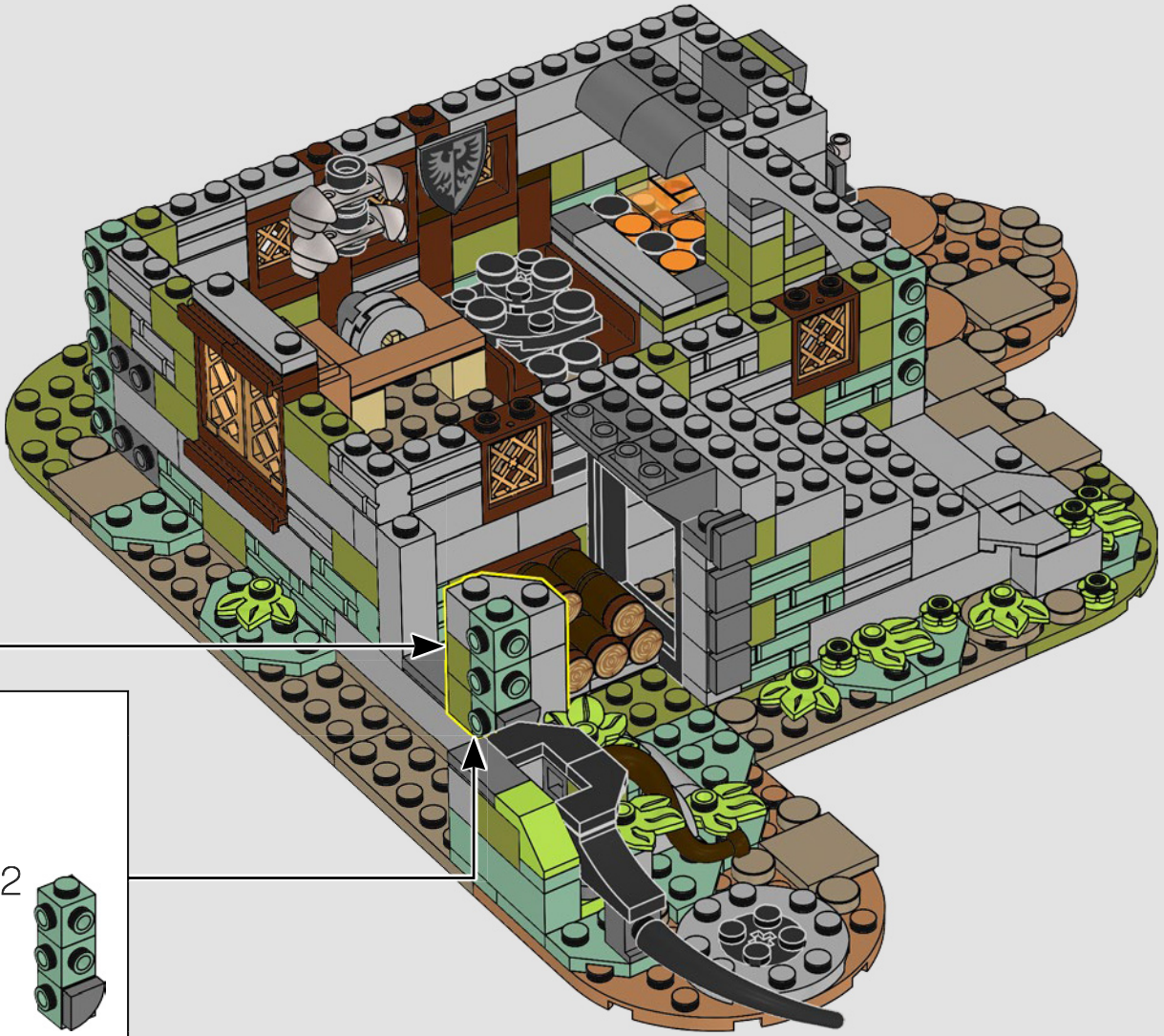
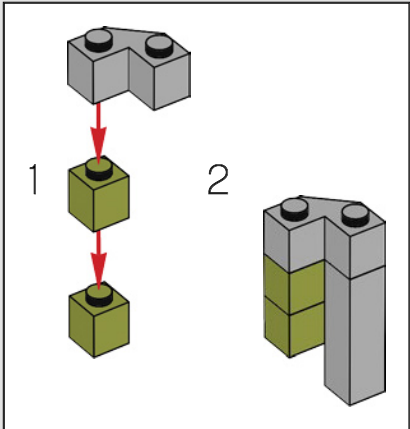

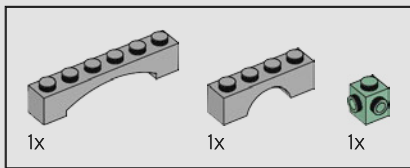

53

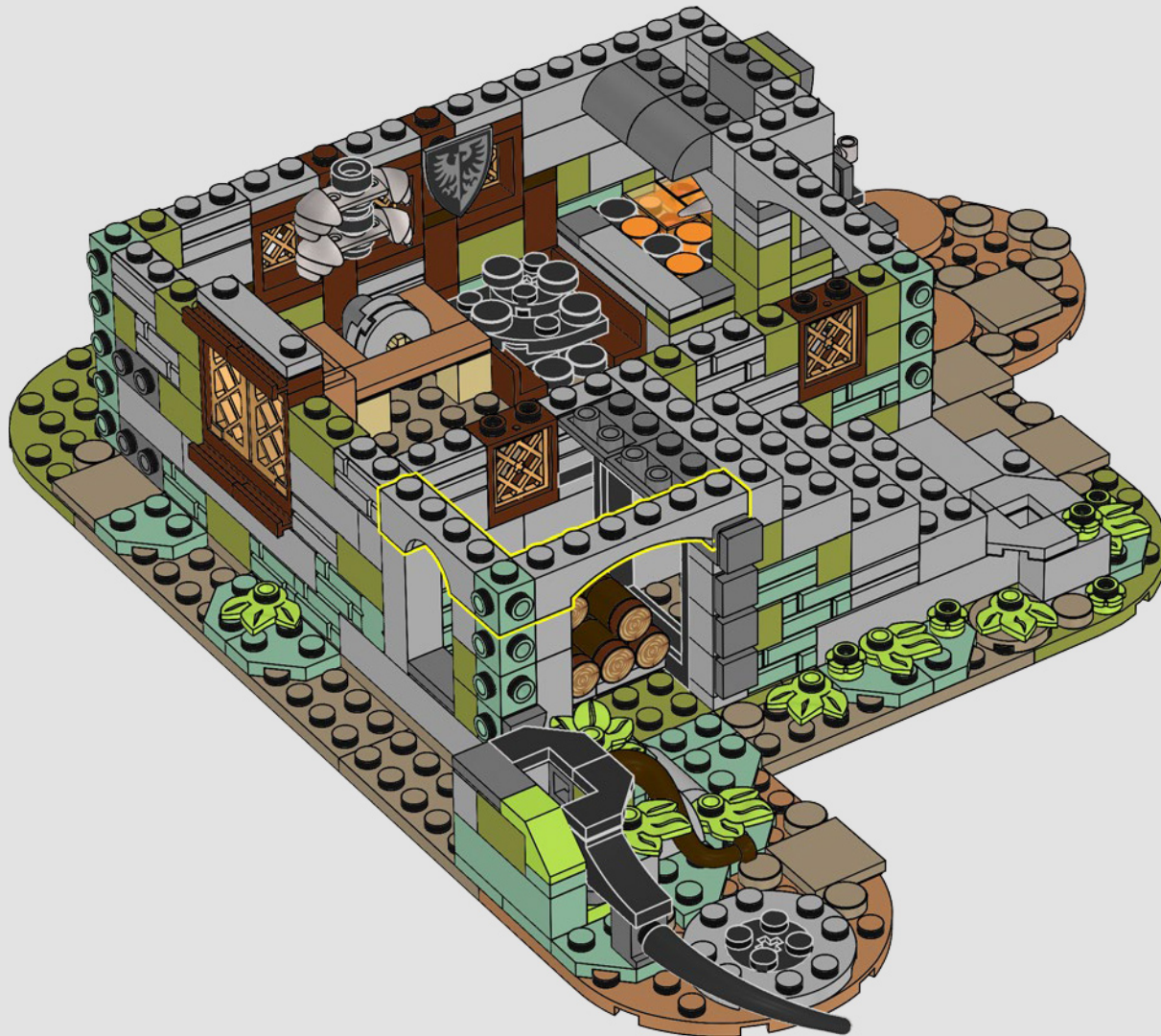

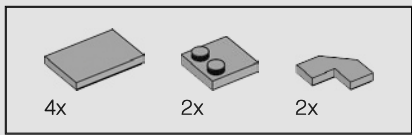

54

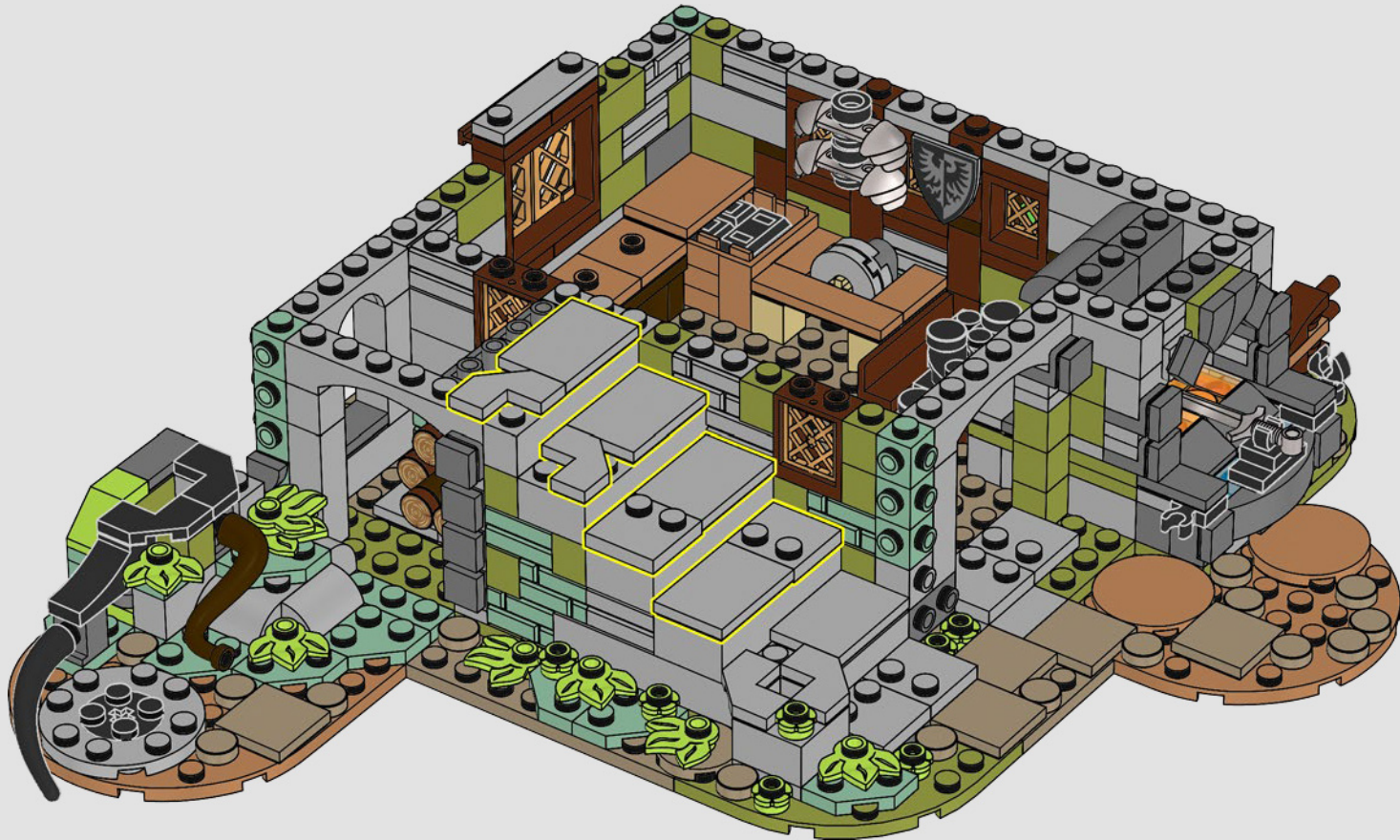

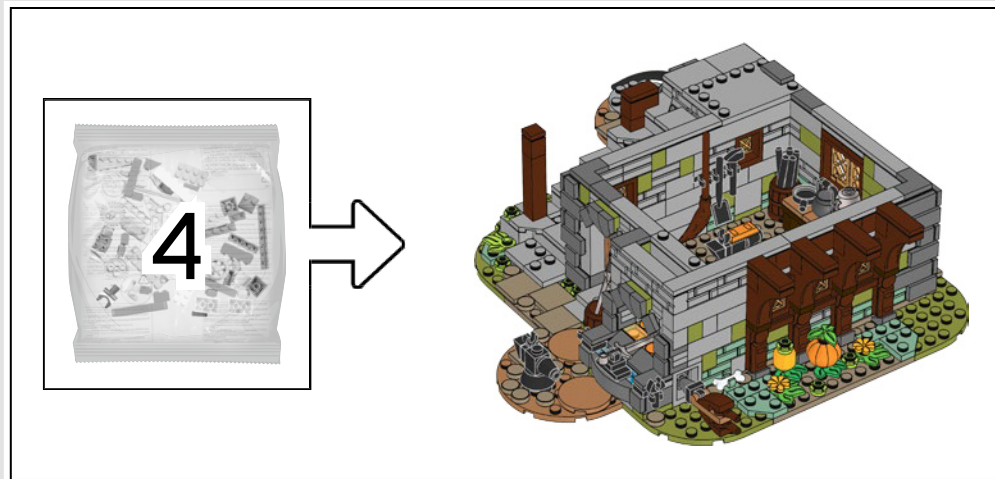

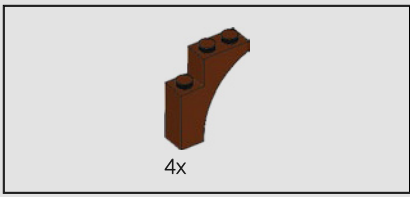

55



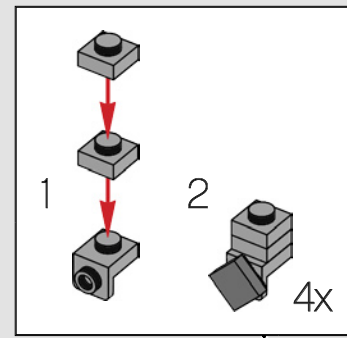
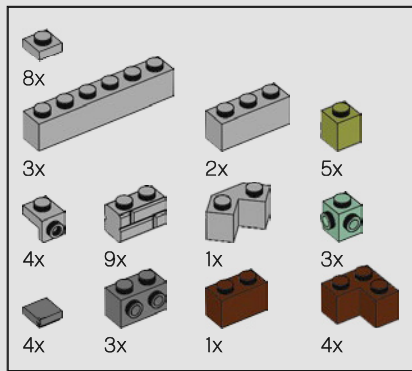

56



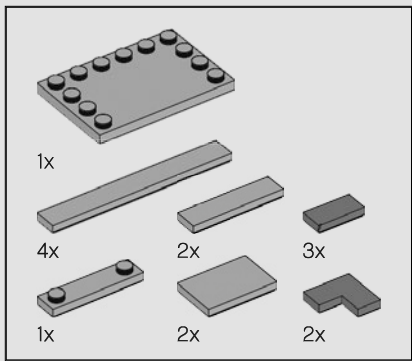

57



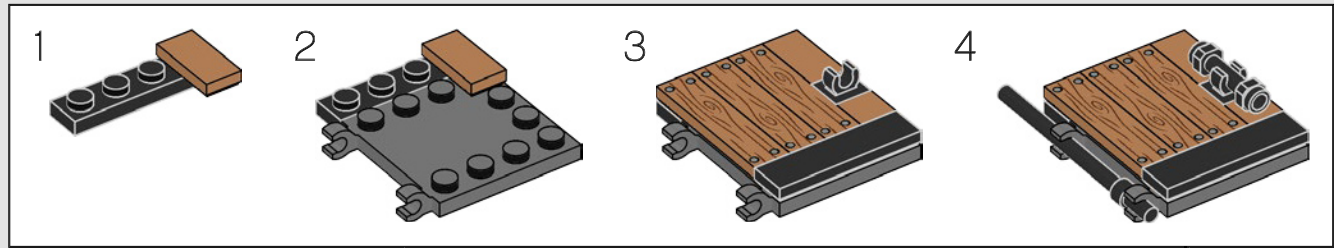
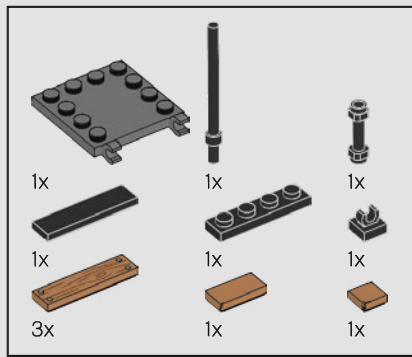

58



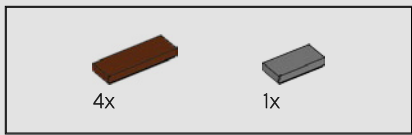

59



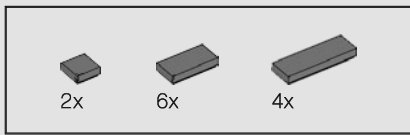

60



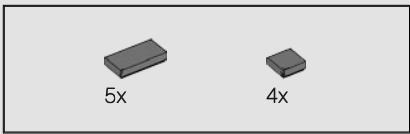

61



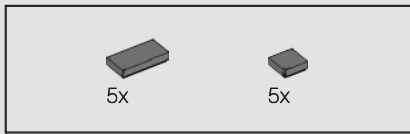

62

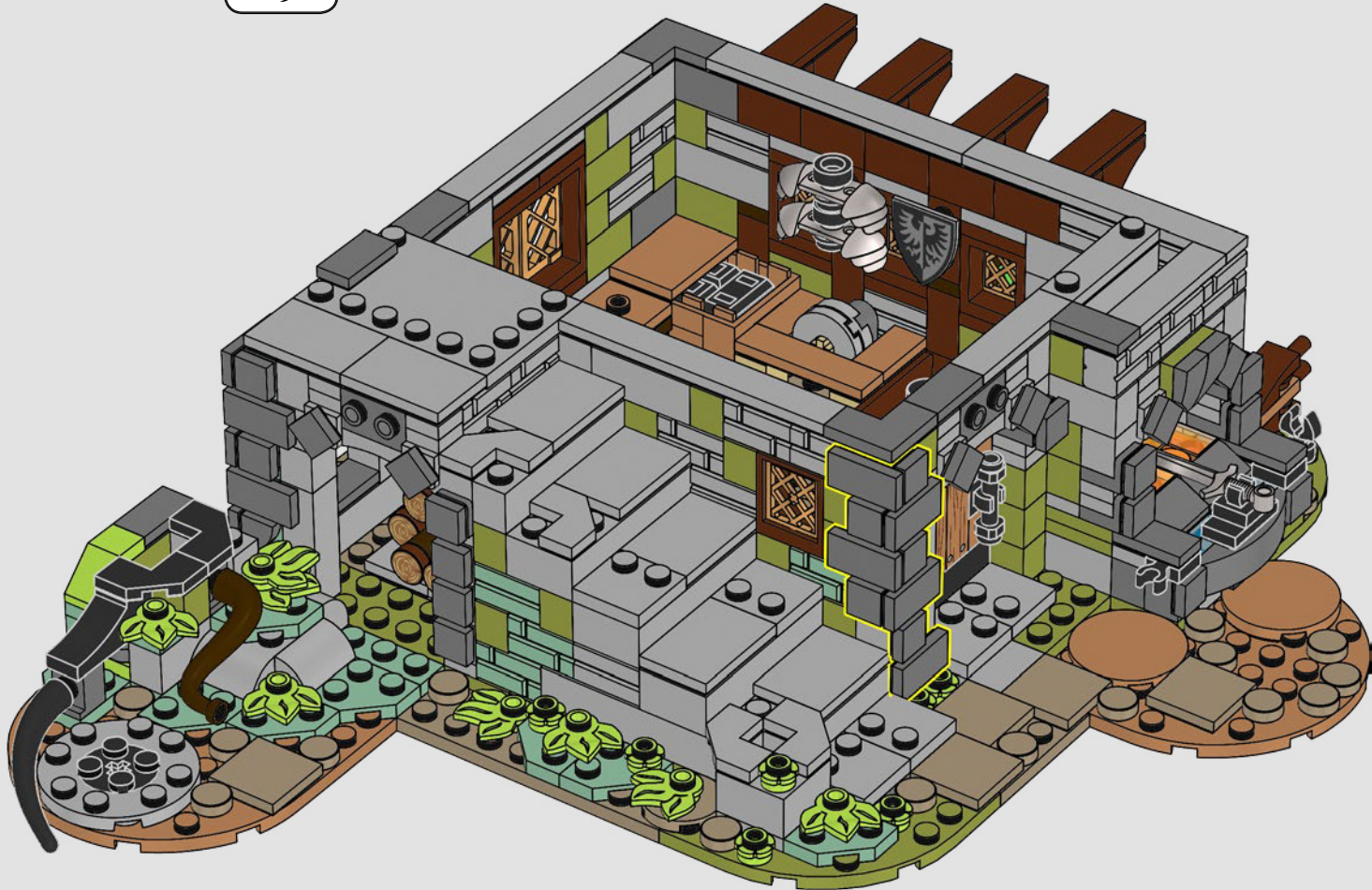

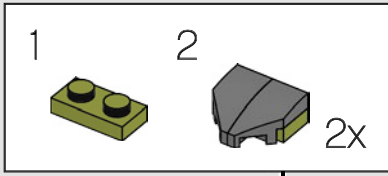
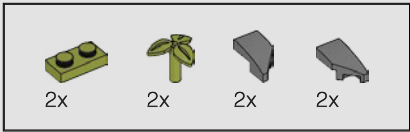

63

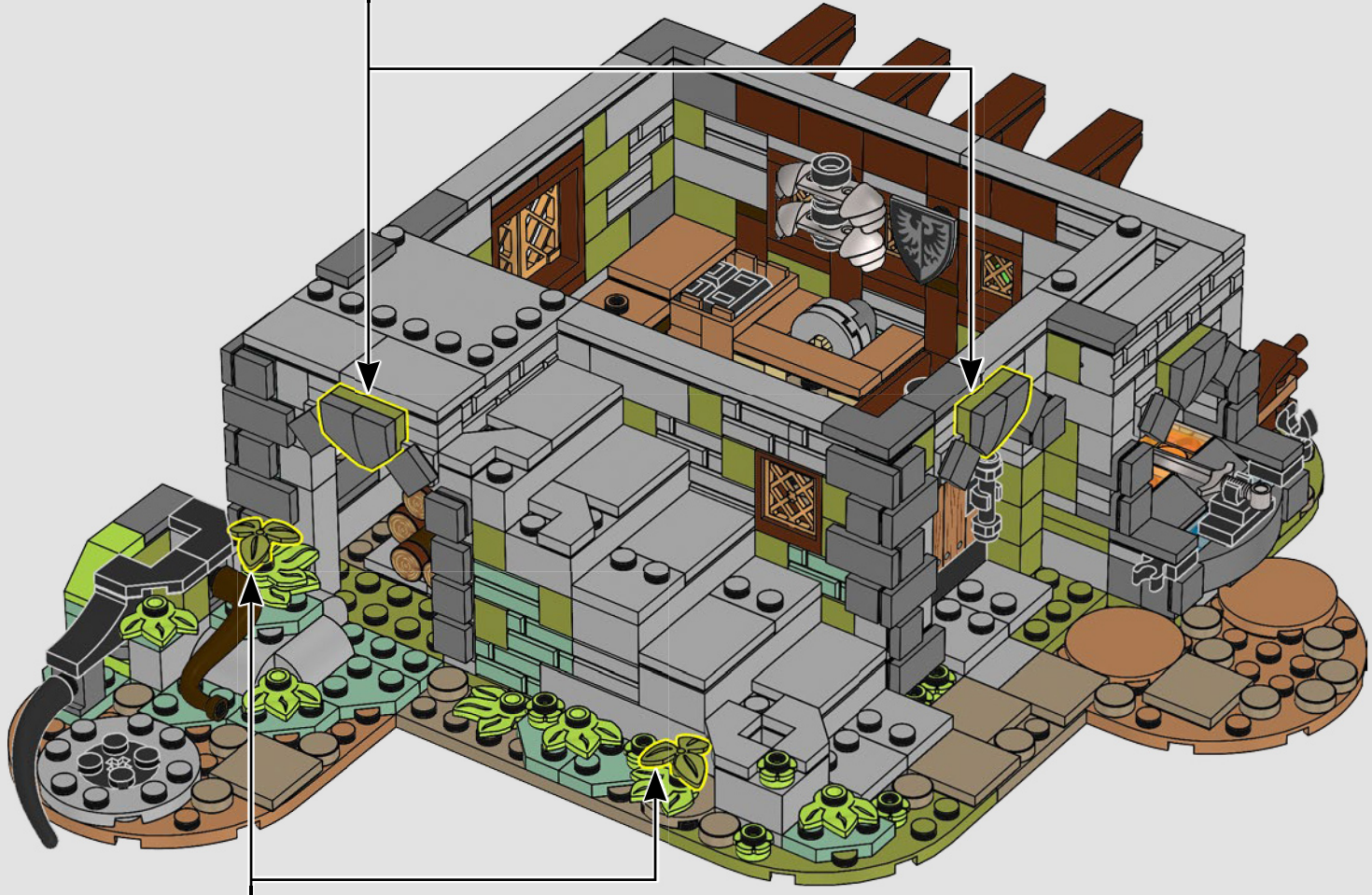



64

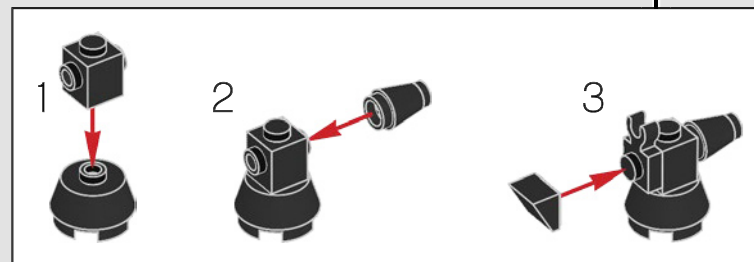
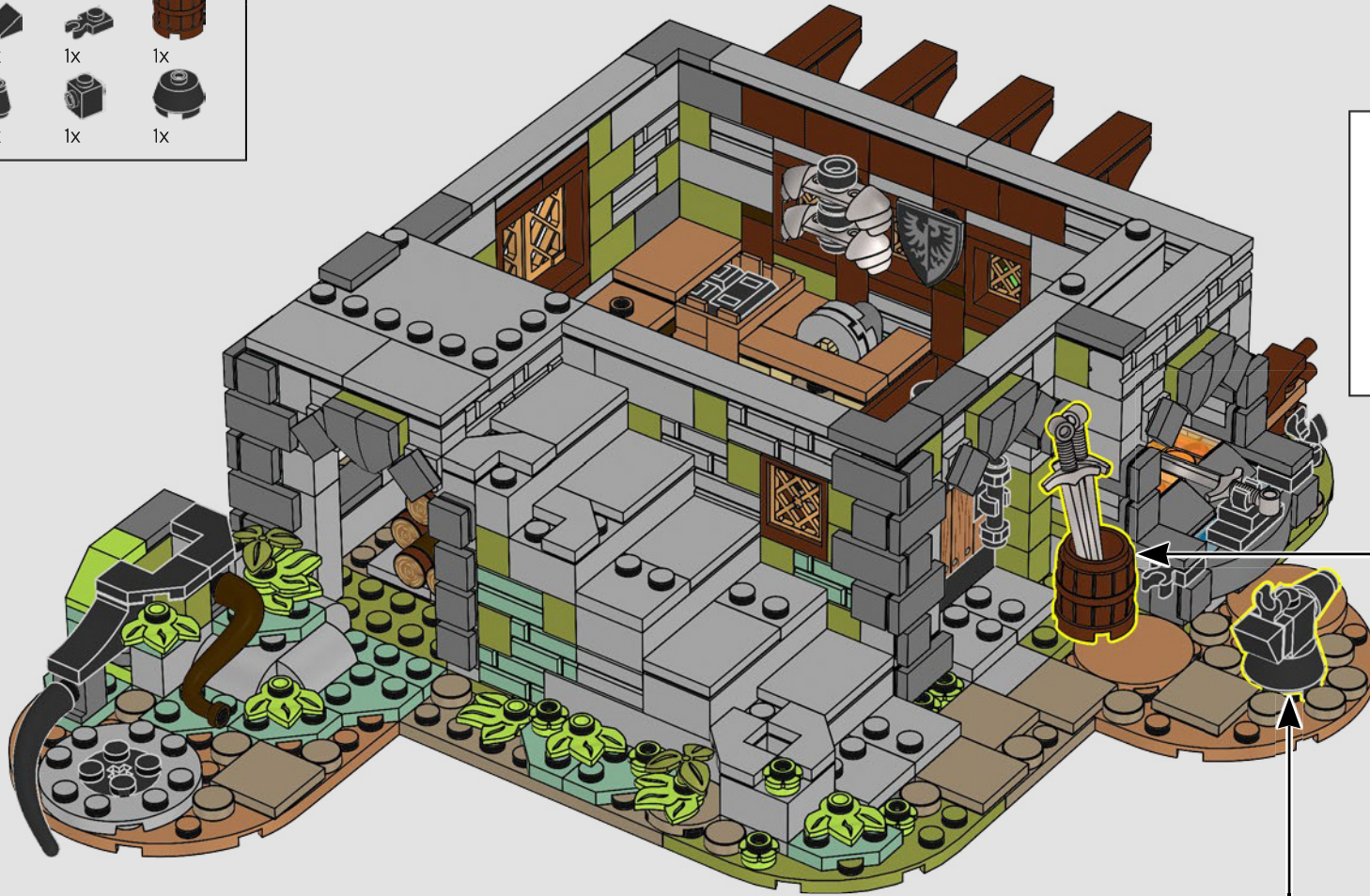

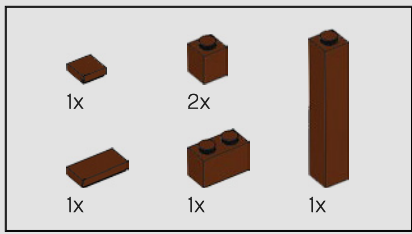

65

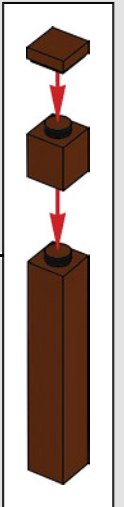
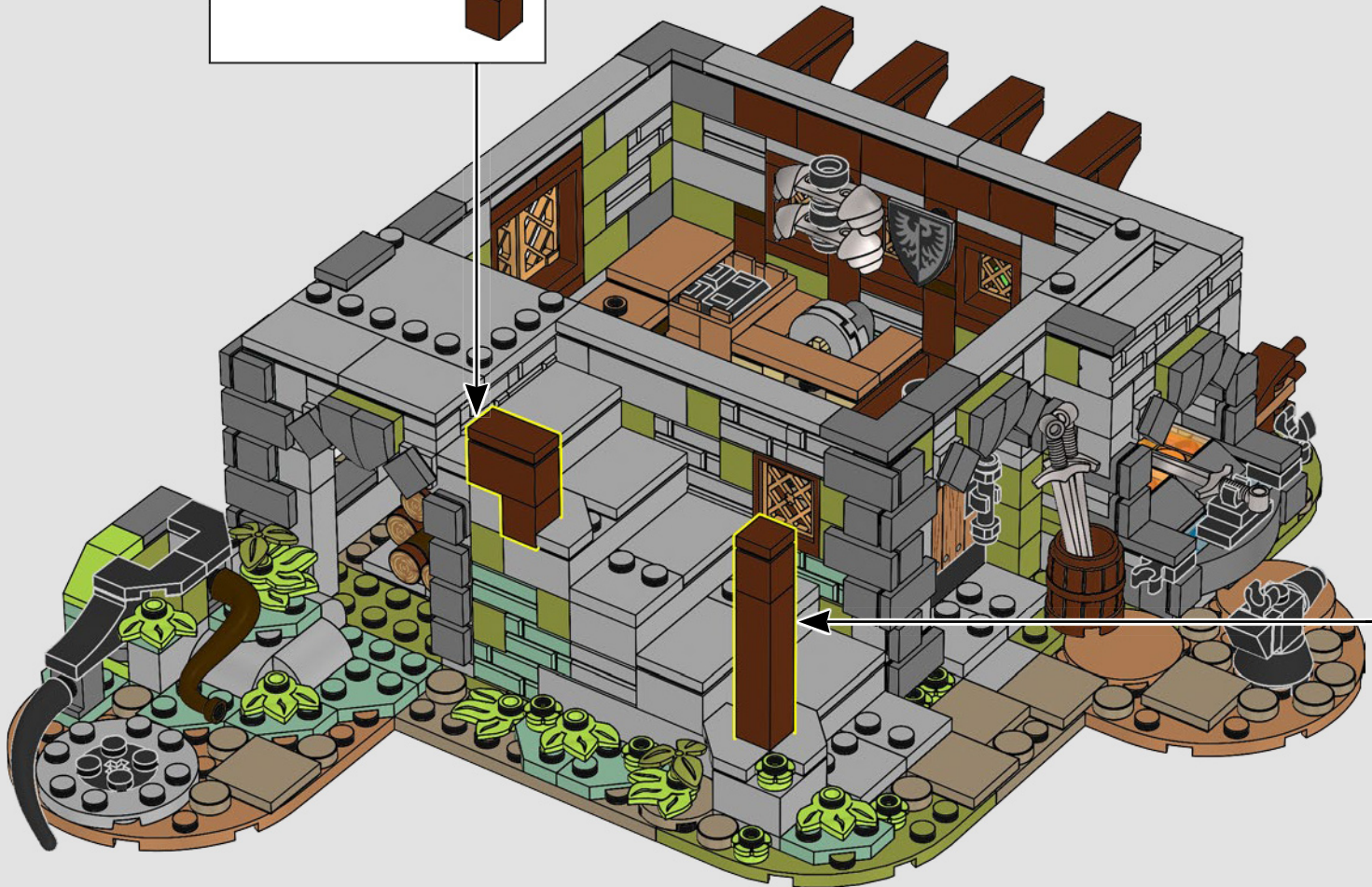
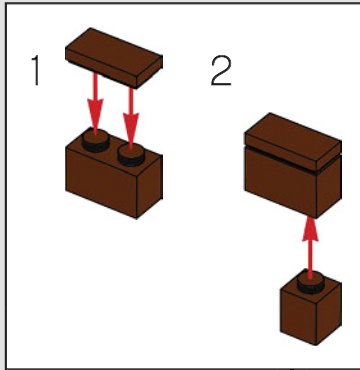

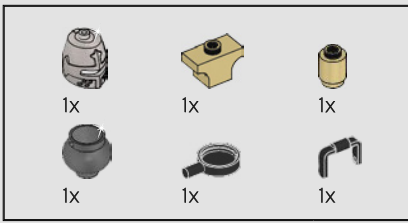

66

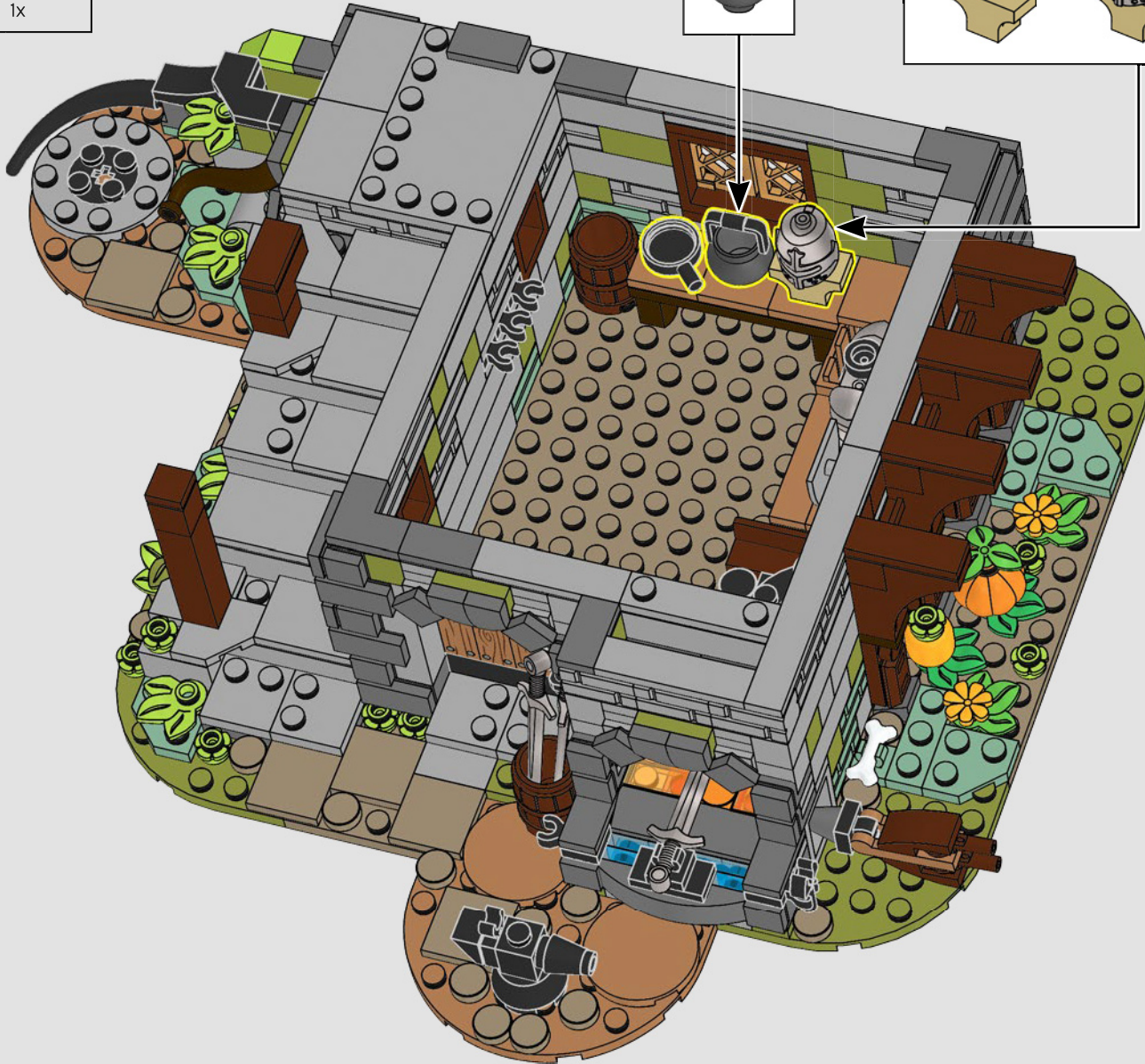
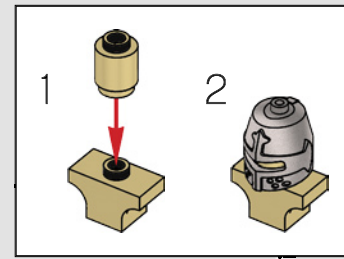
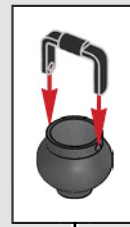

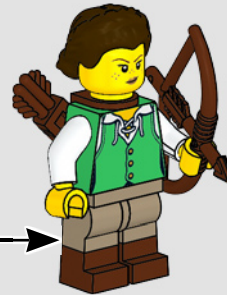
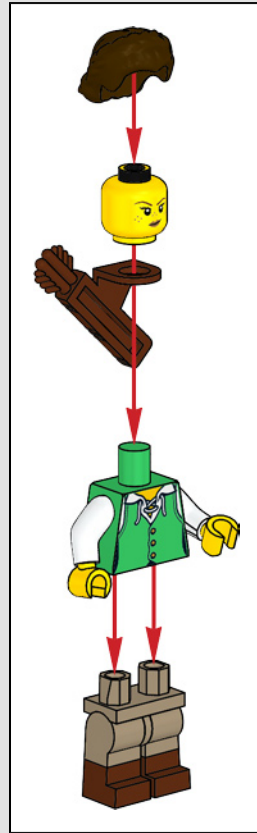
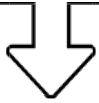

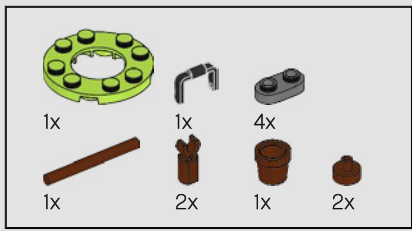

68

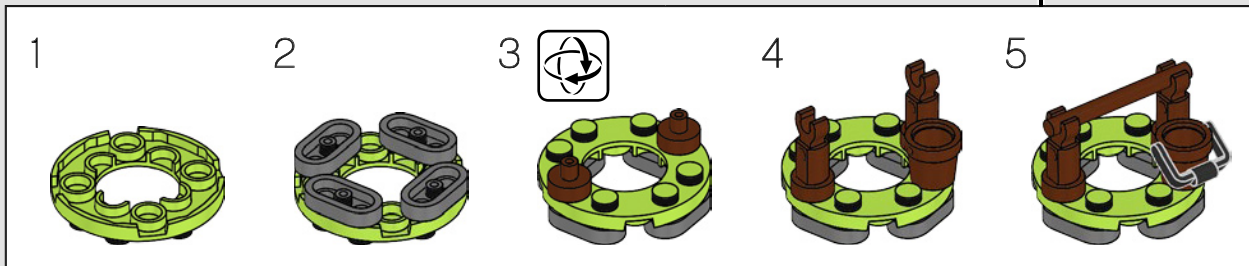
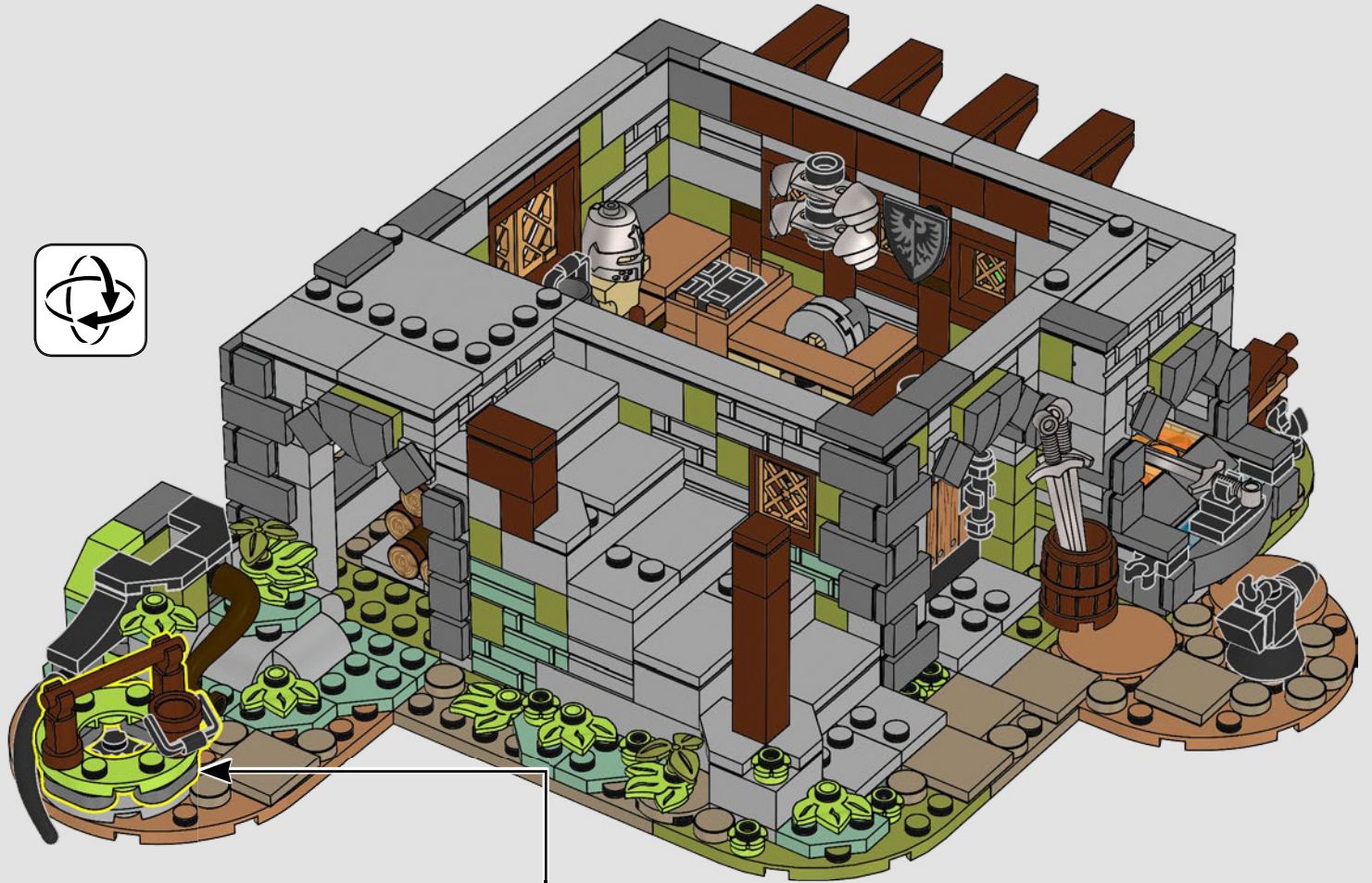

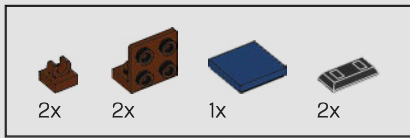

69

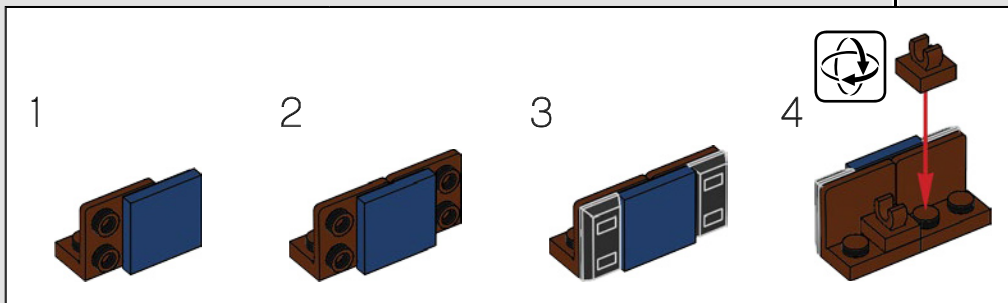
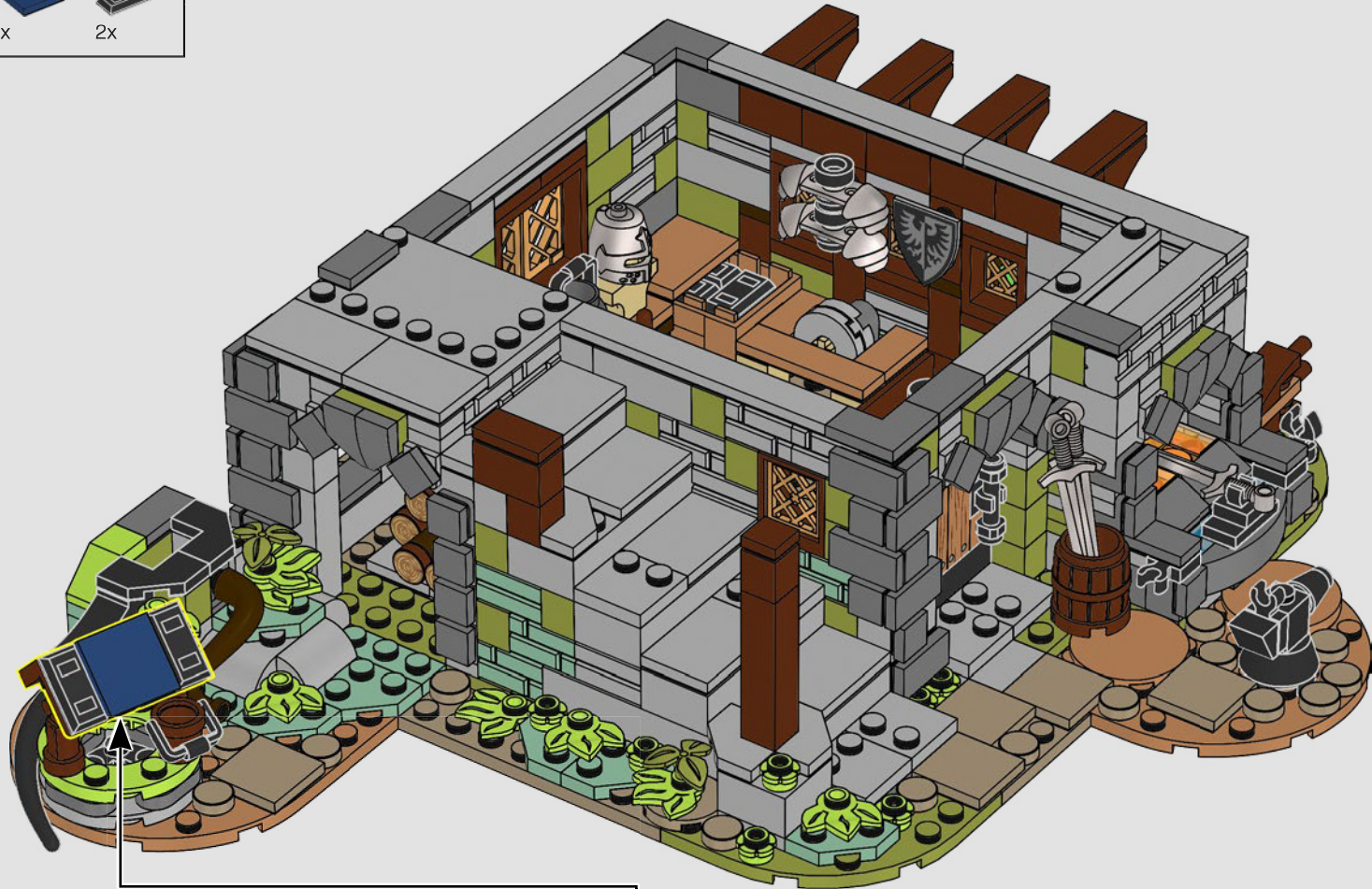

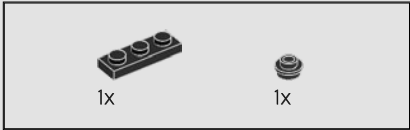
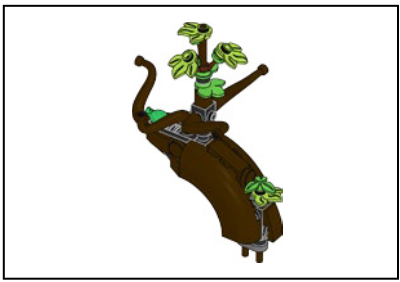

70

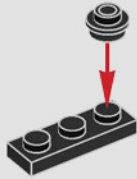

71

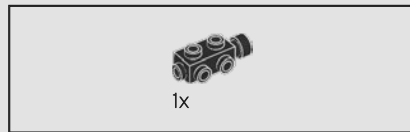
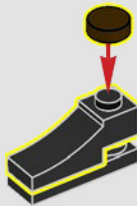

72

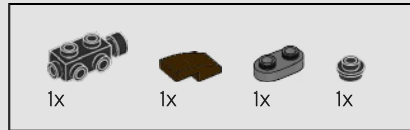
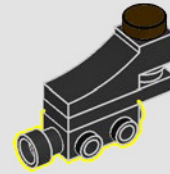

73

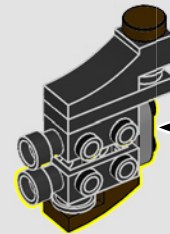
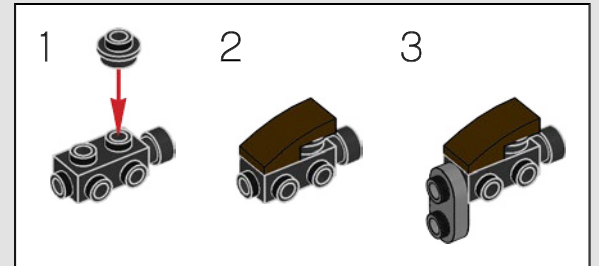

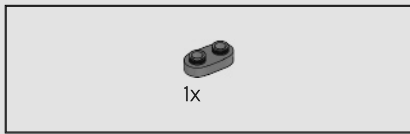

74

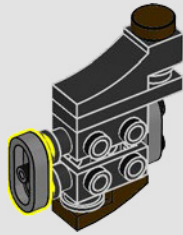

75

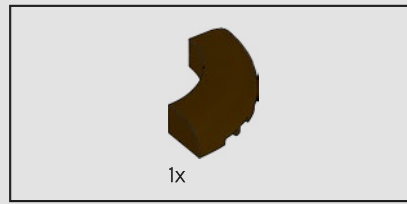
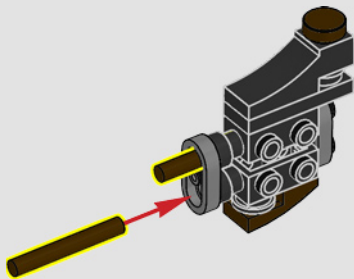

76

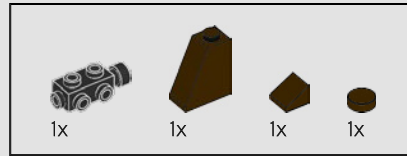
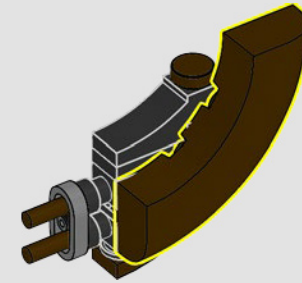

77

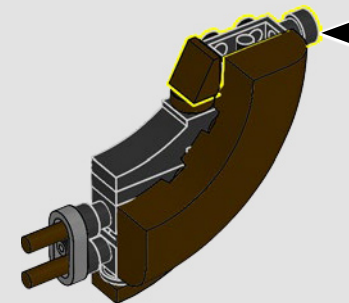
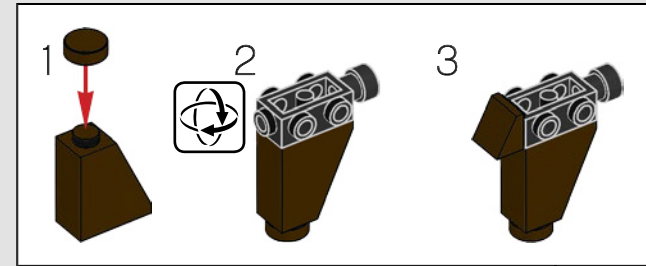

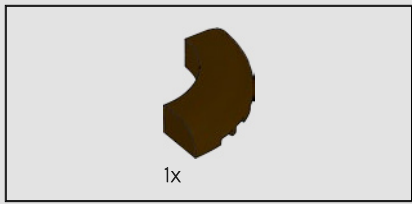

78

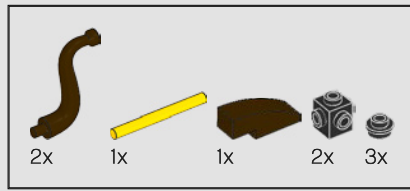
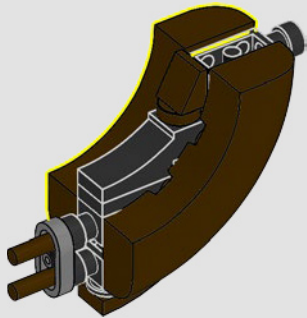

79

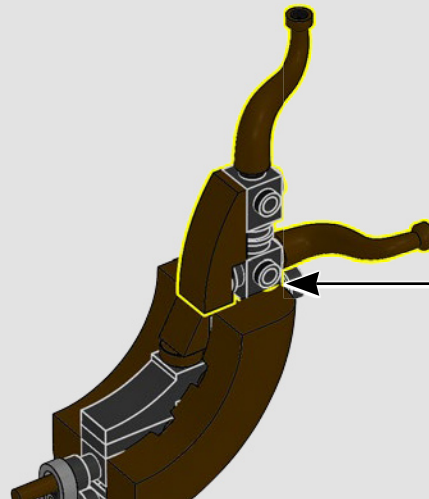
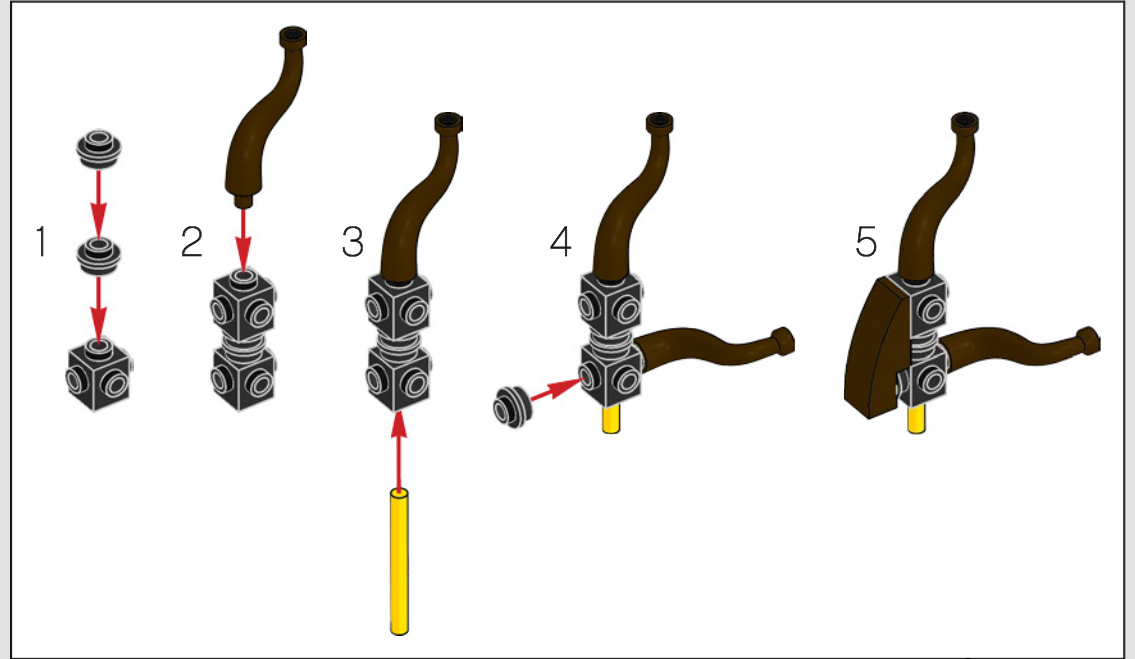

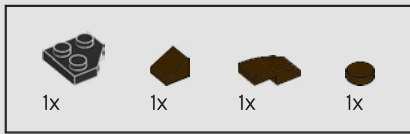

80

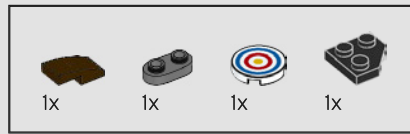
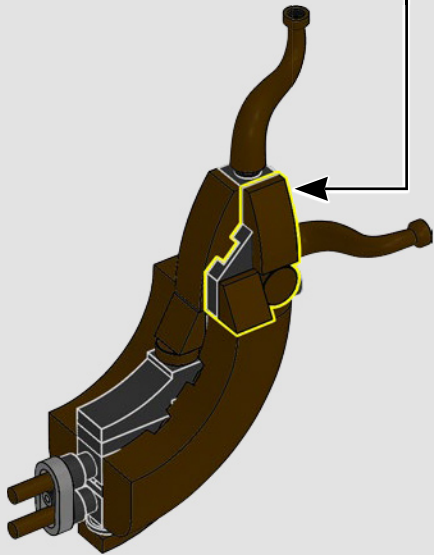
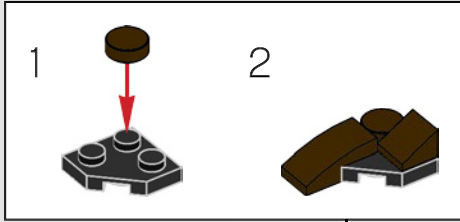

81

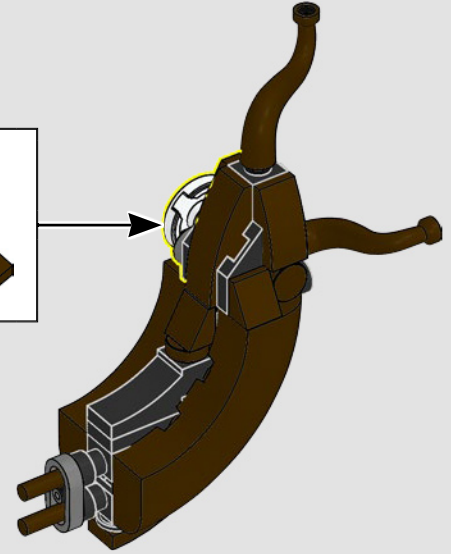
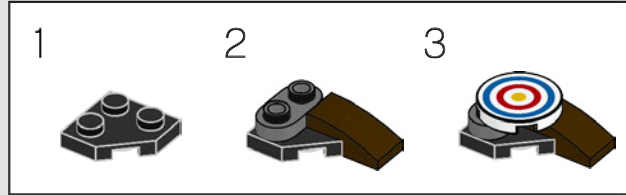

82

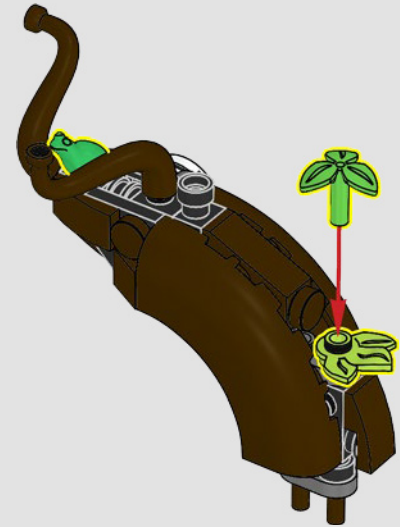
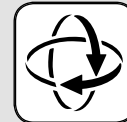

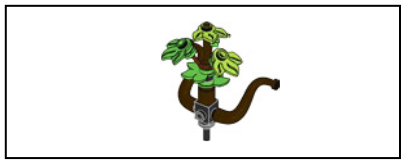

83

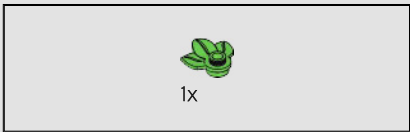

84

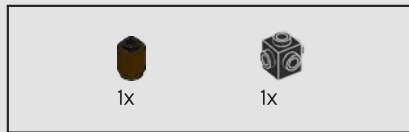

85



86

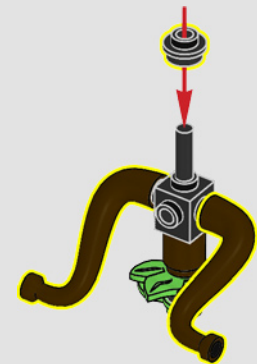

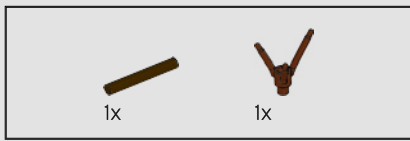

87

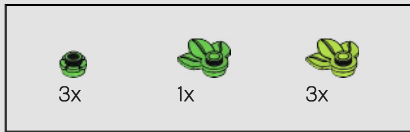

88

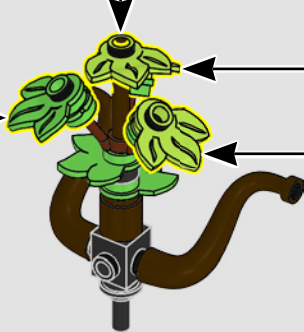
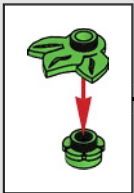
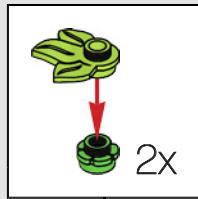

89



90



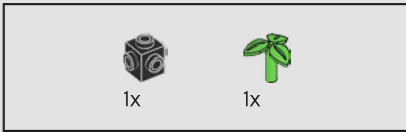
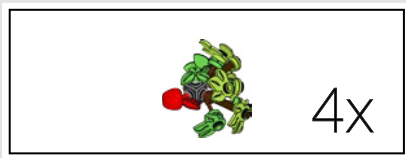

91

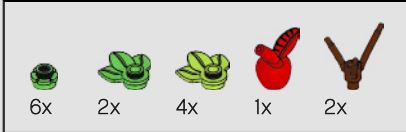

92

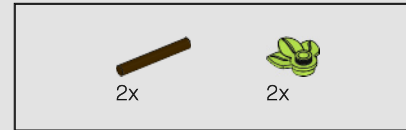
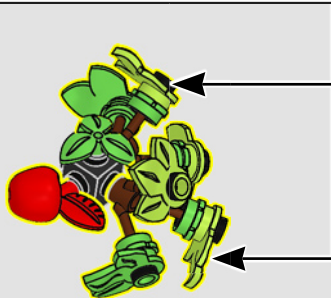
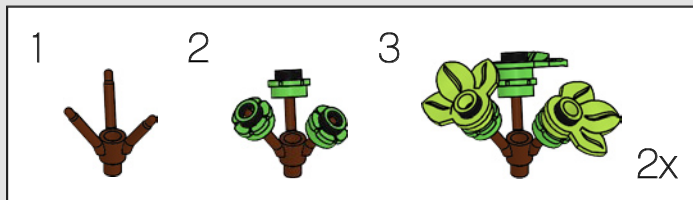

93

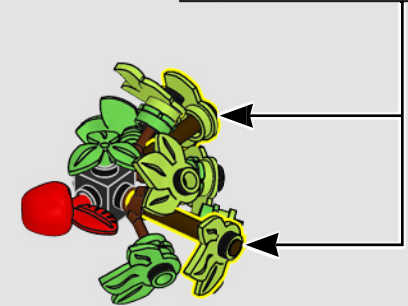
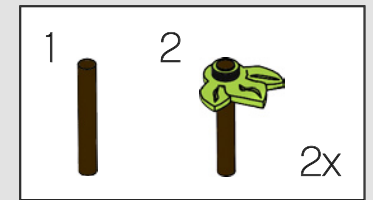

4x

94



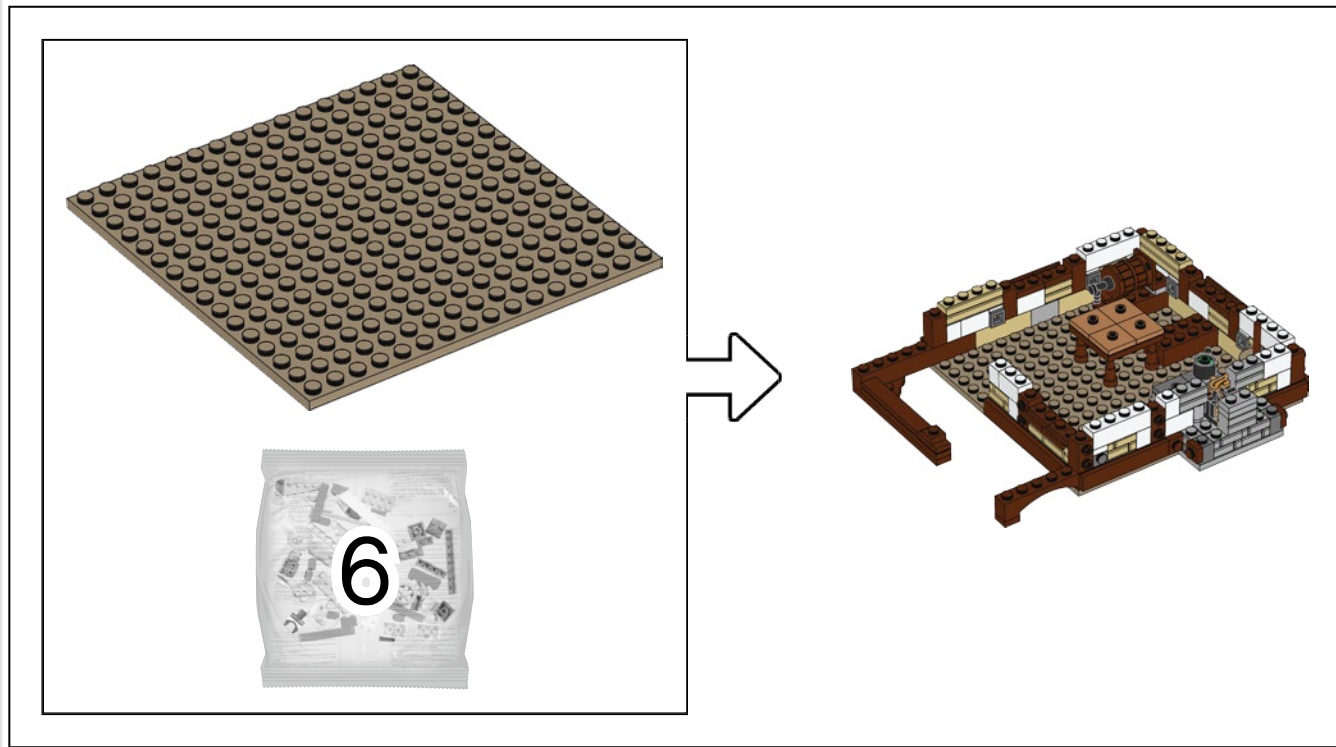

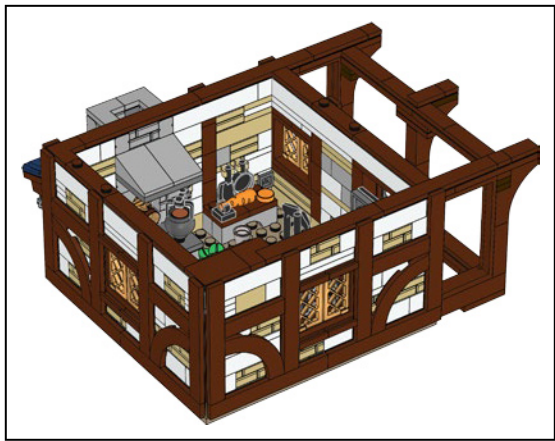

95

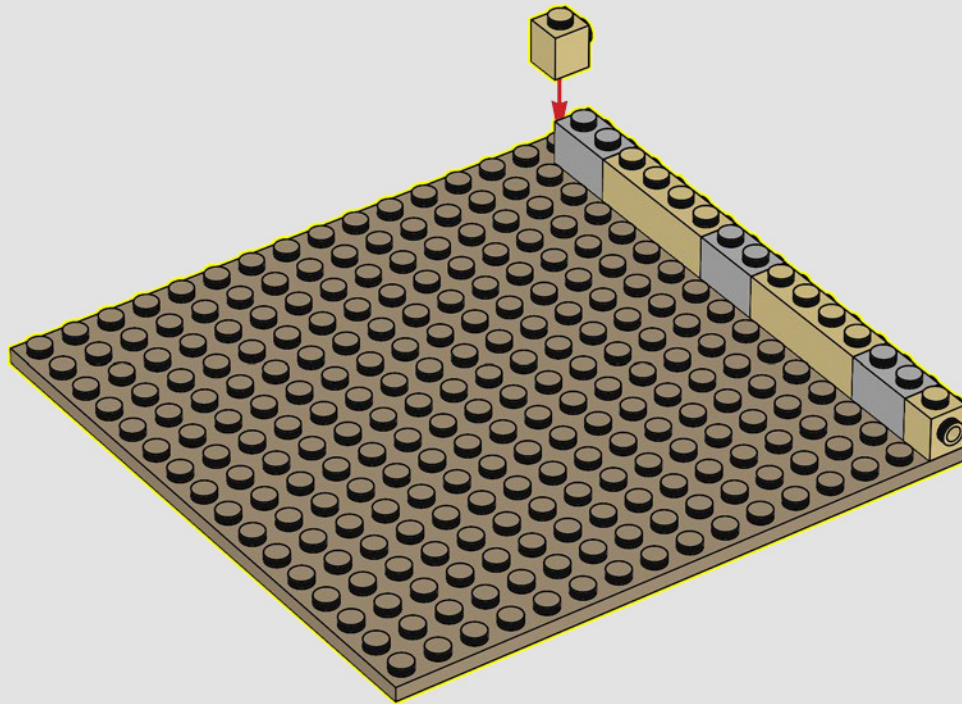

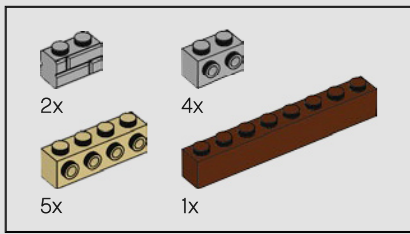

96

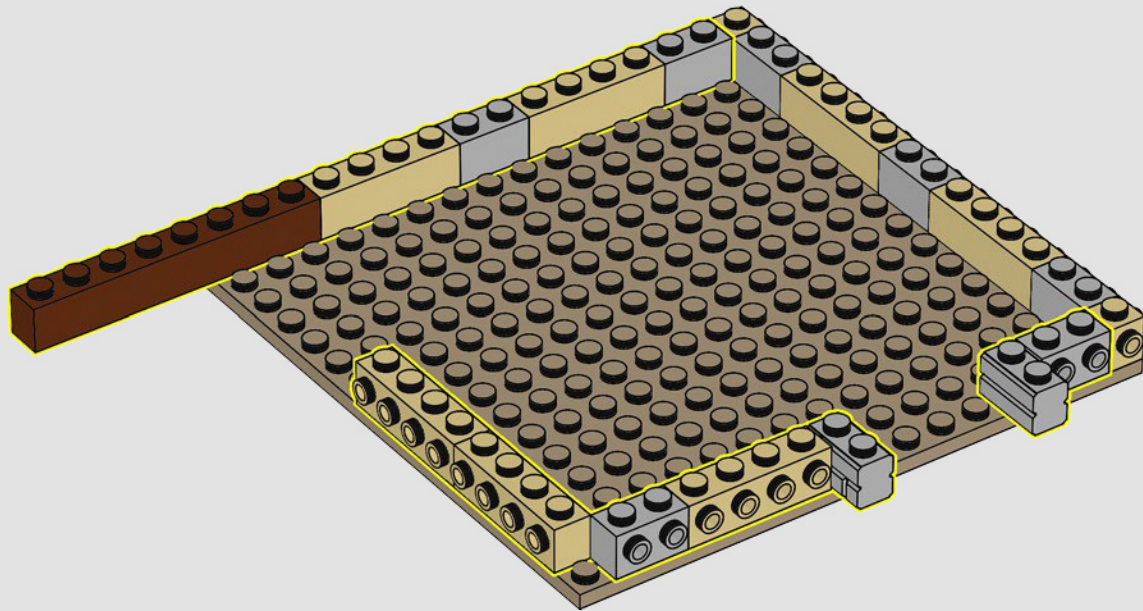

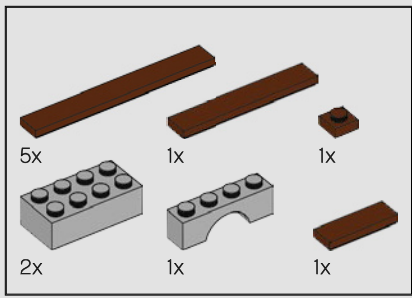

97

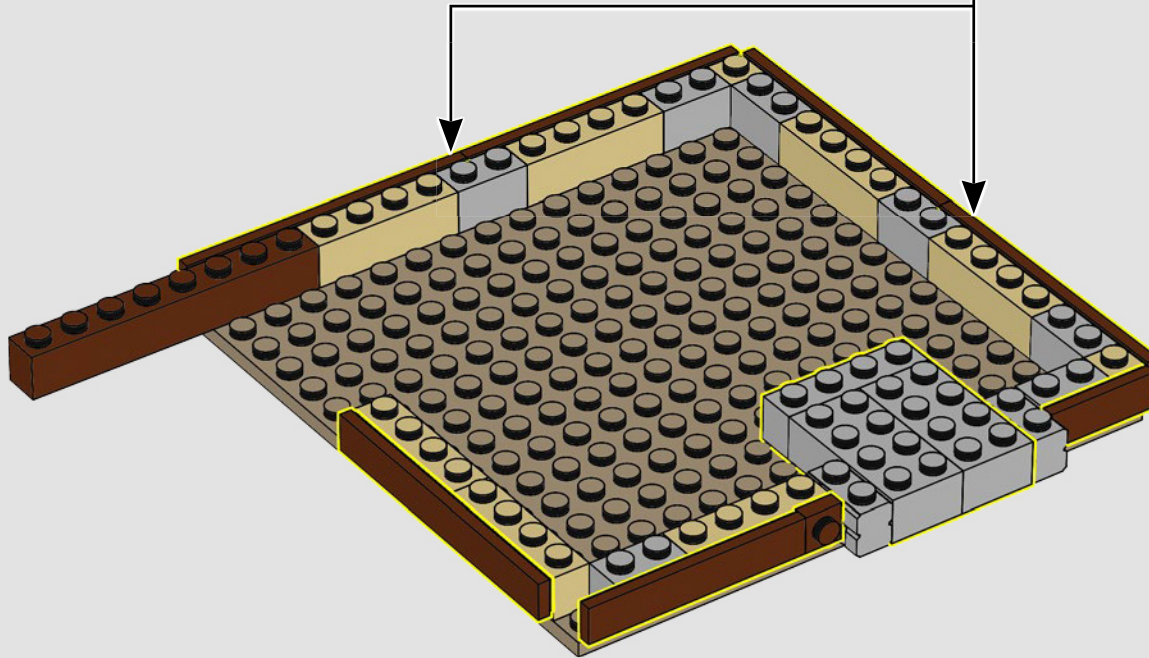
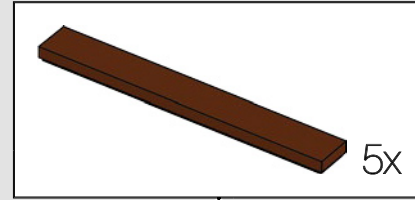

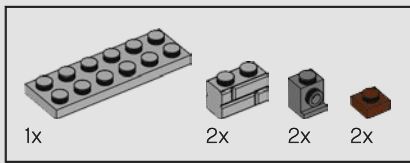

98

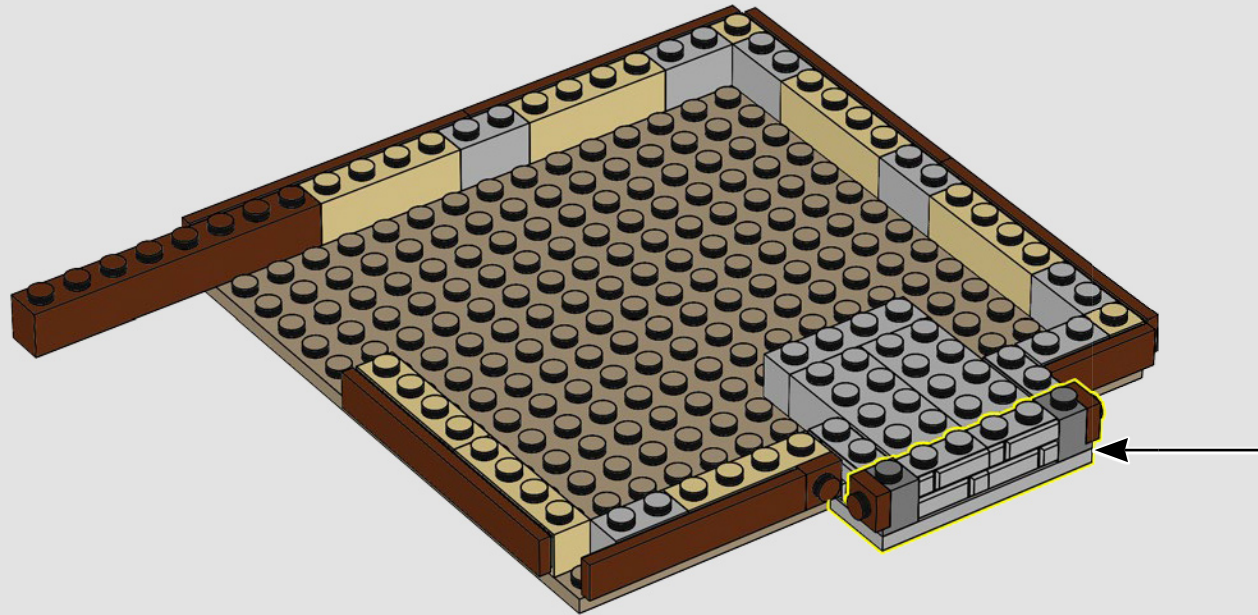
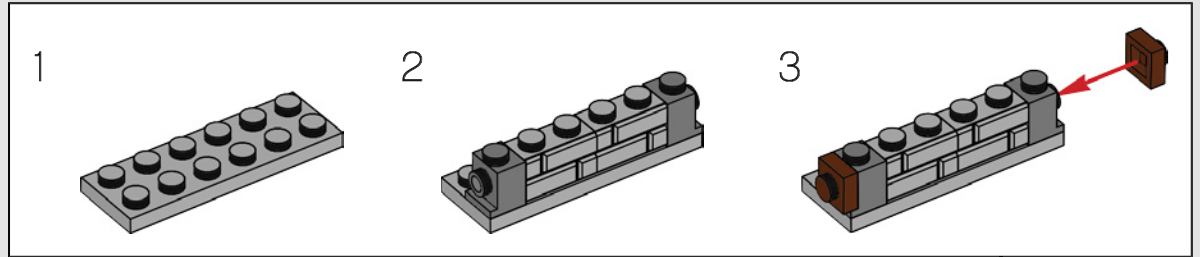

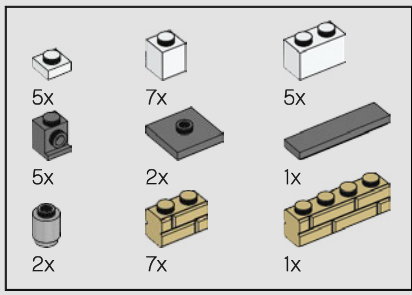

99

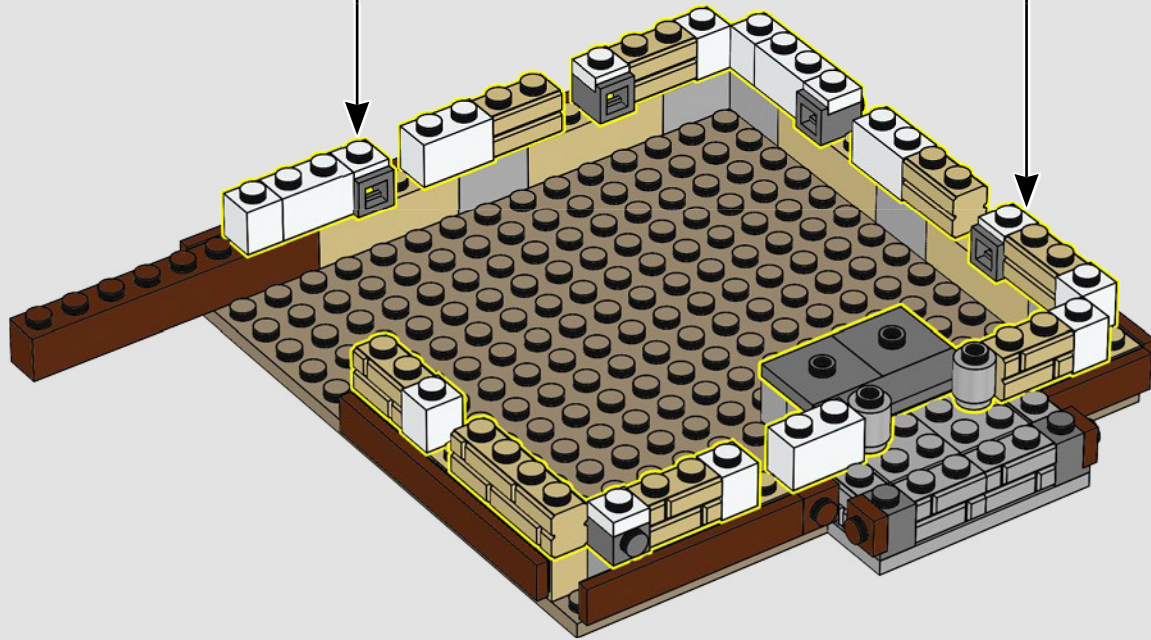
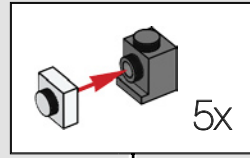

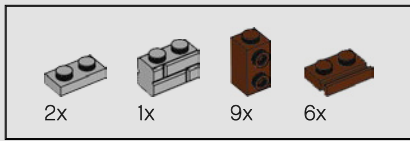

100

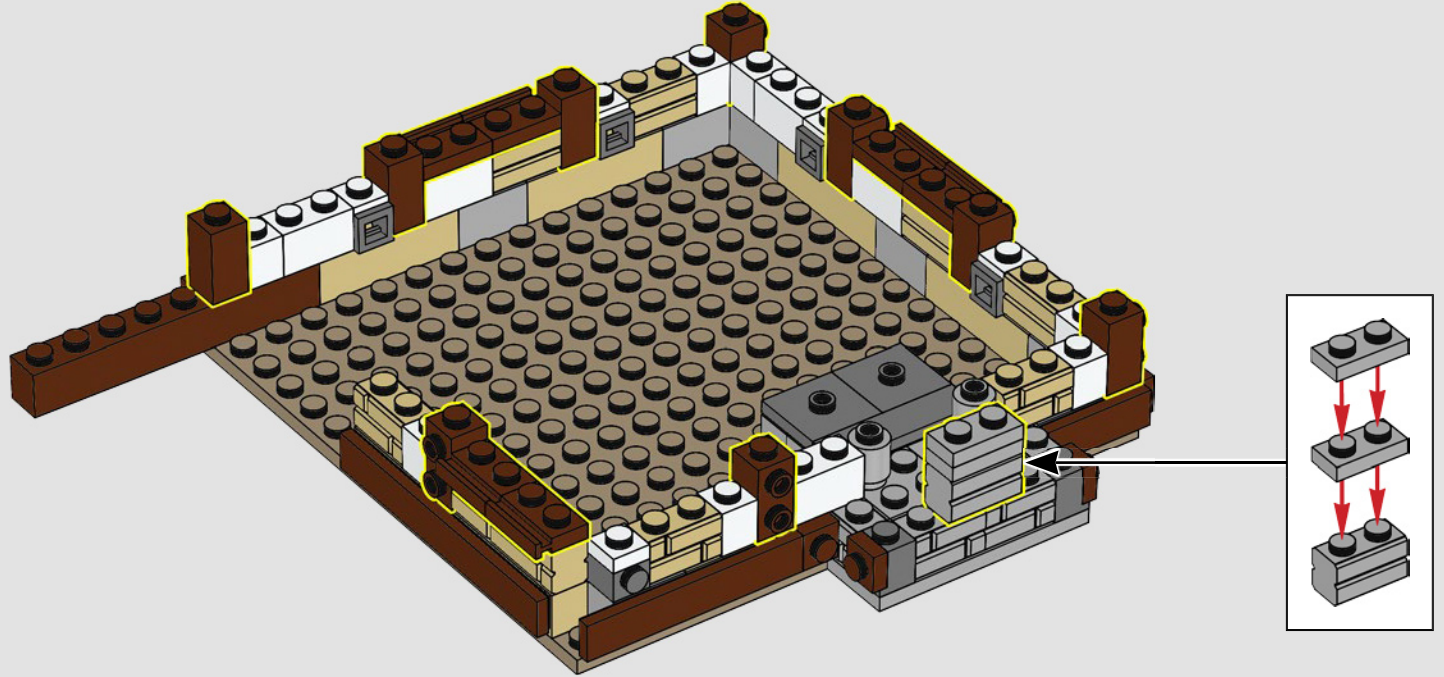

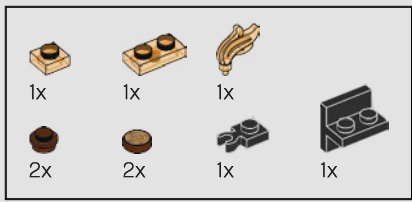

101

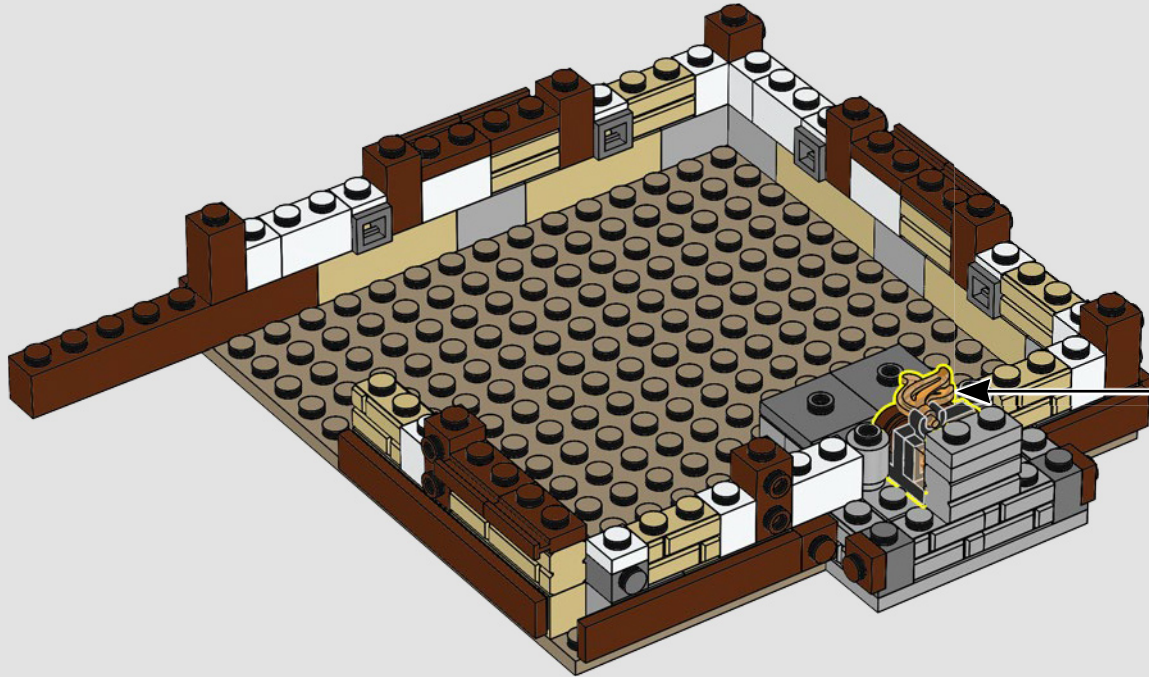
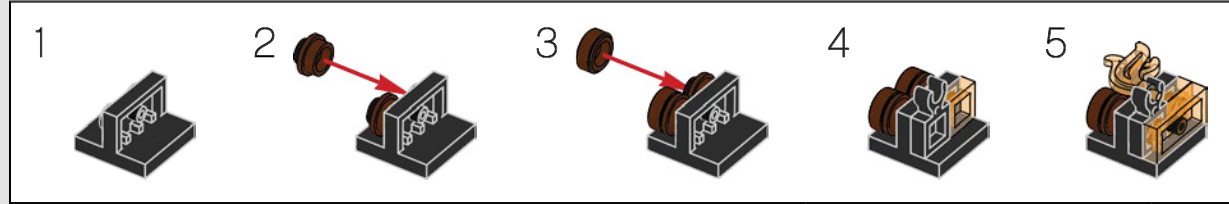

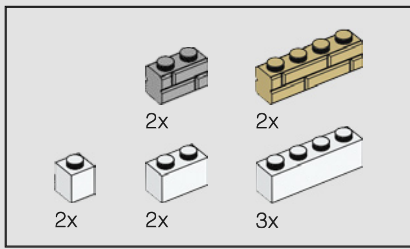

102

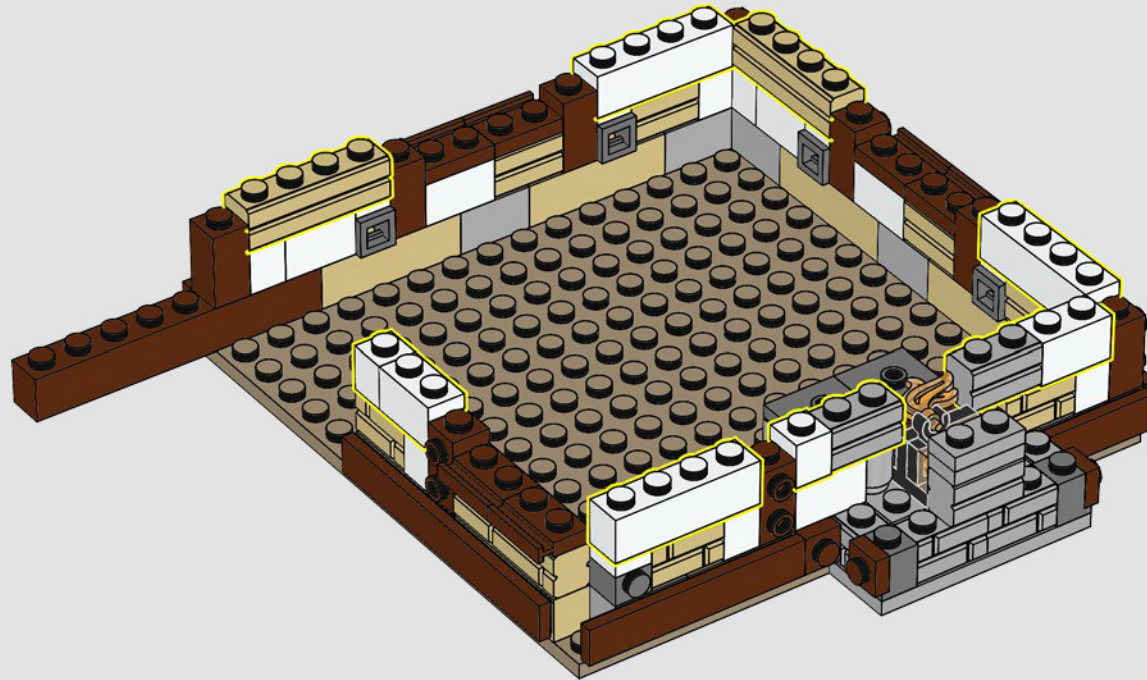

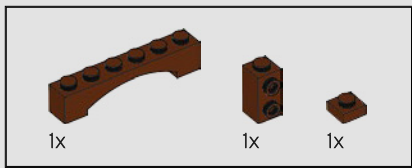

103

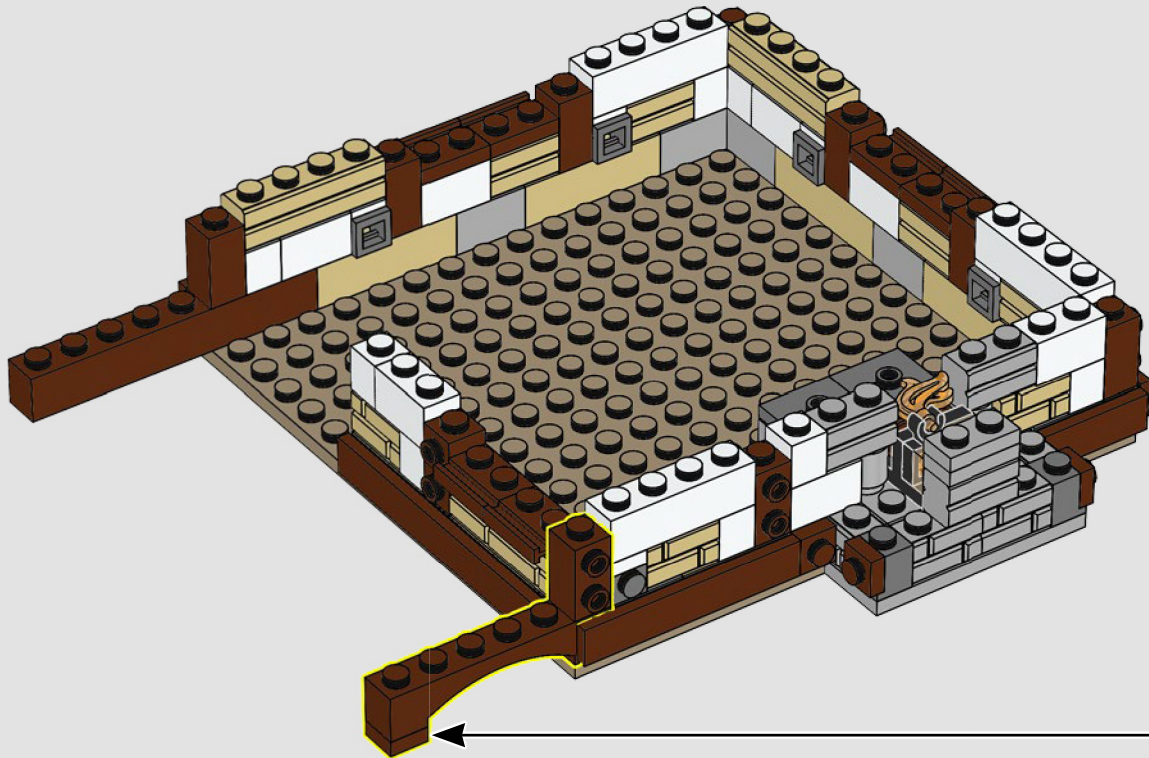
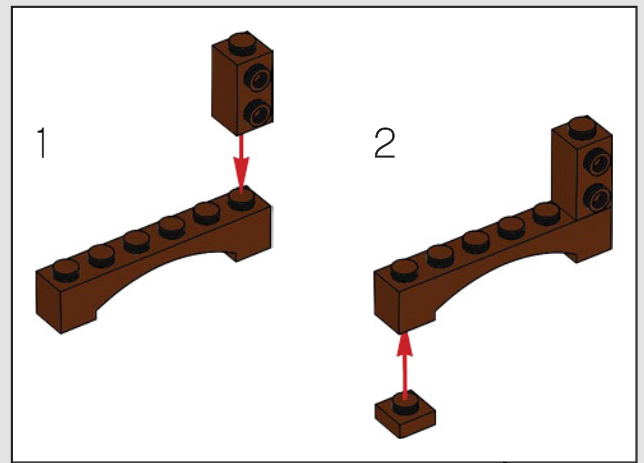

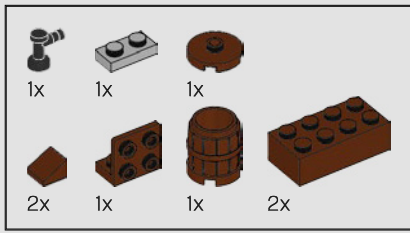

104

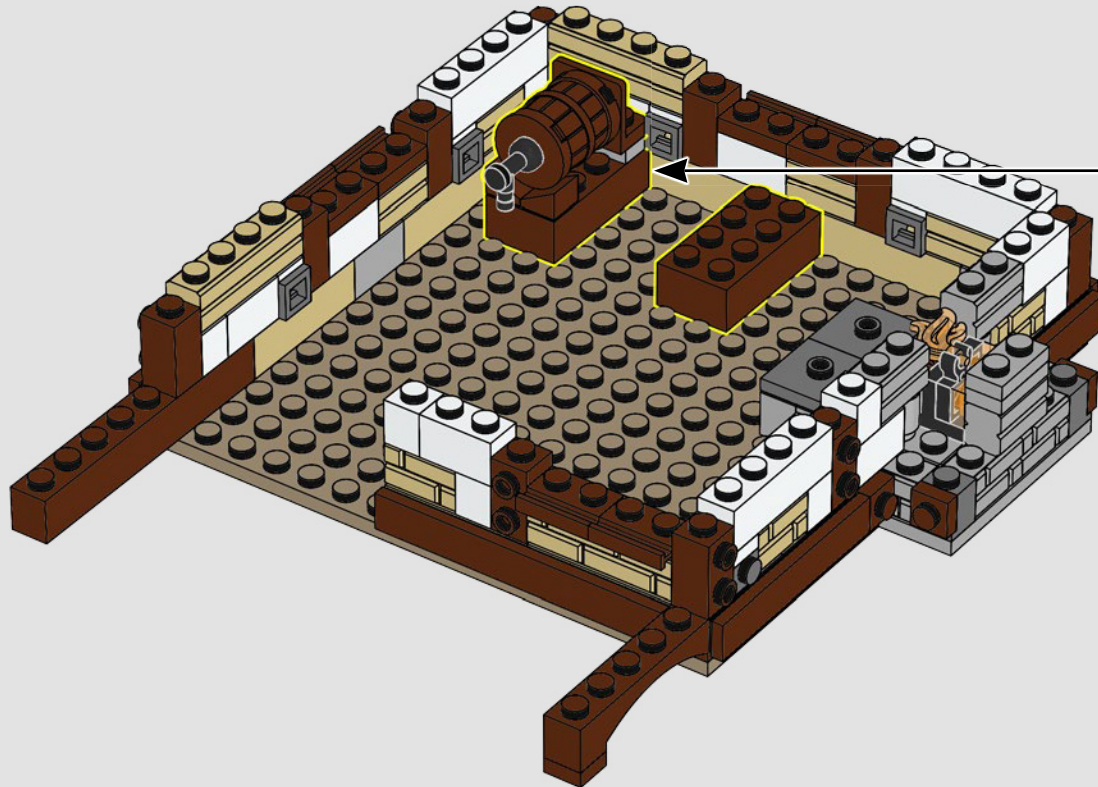
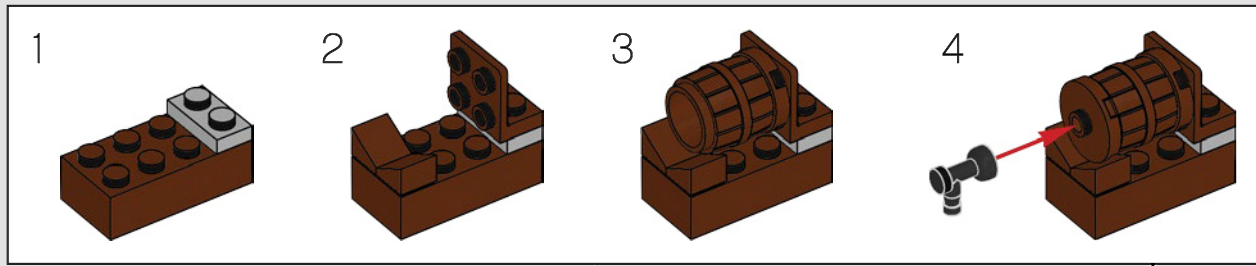

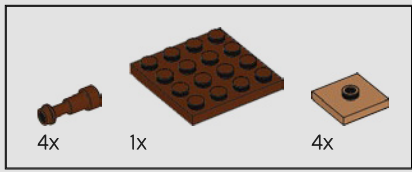

105

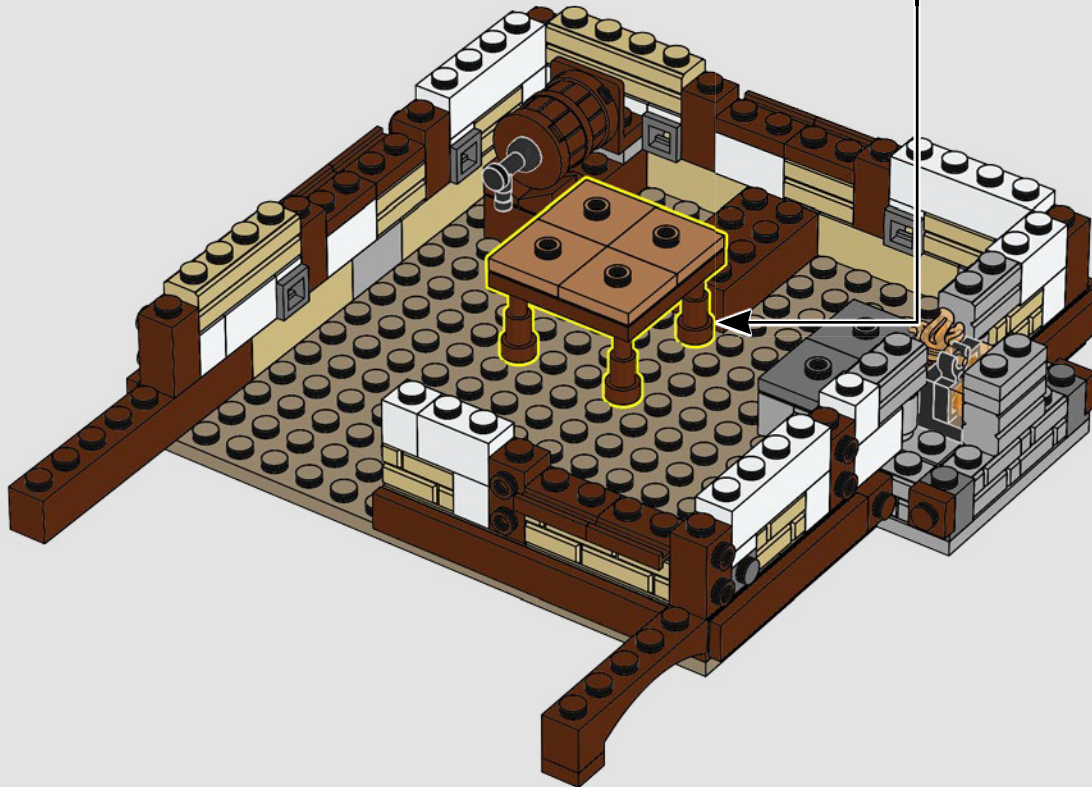
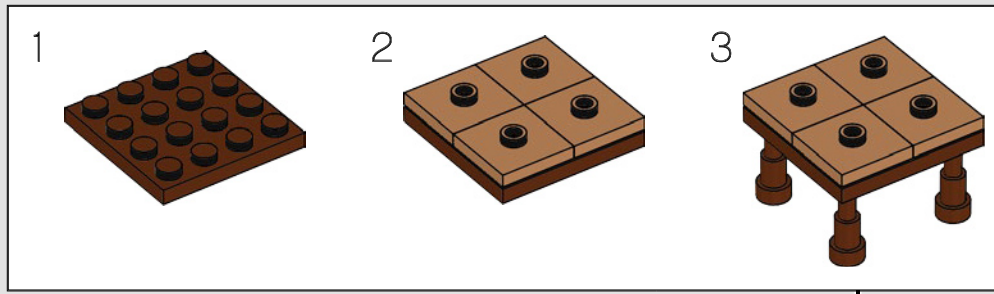

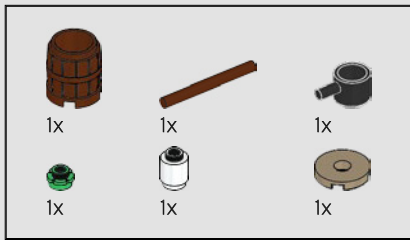

106

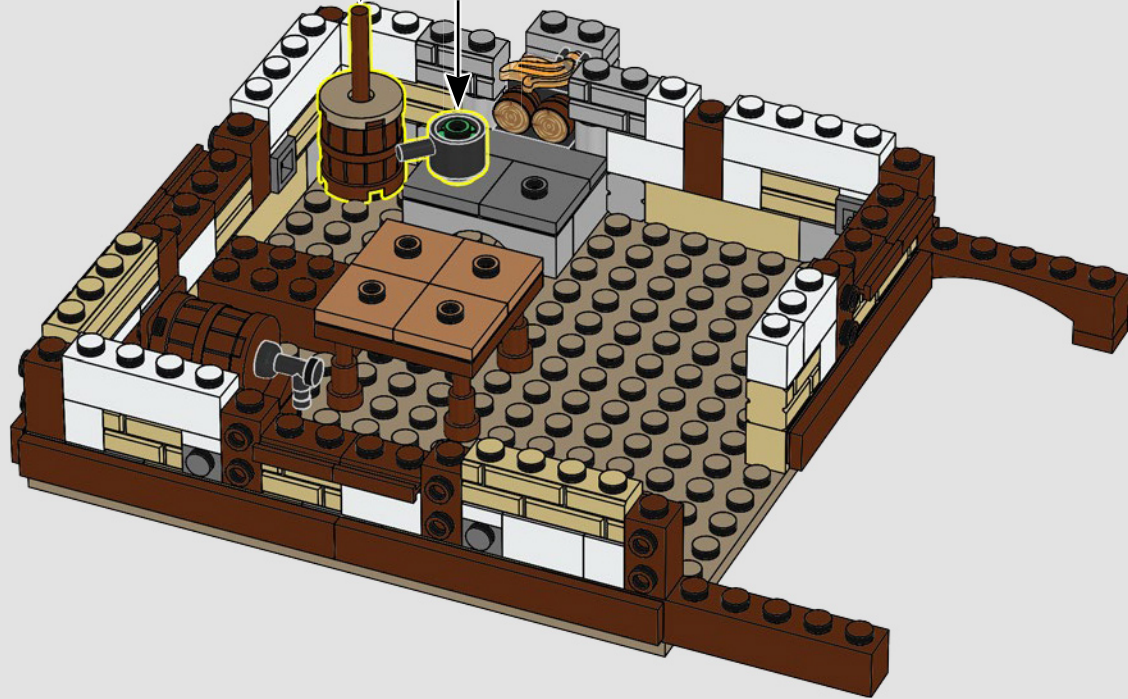
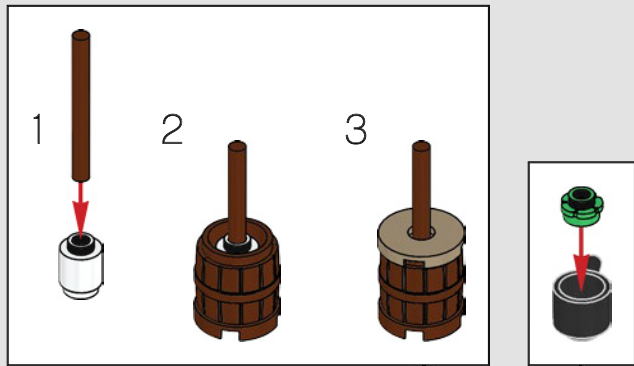

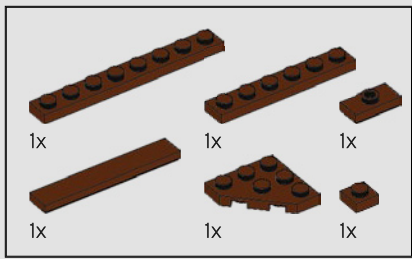

107

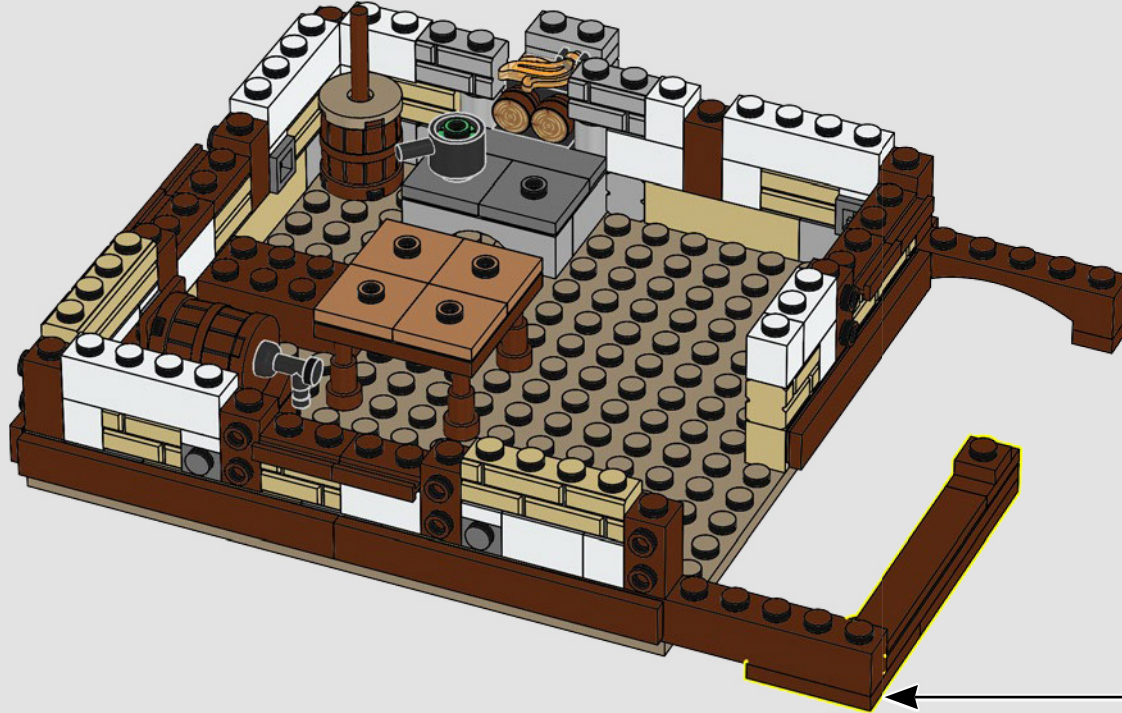
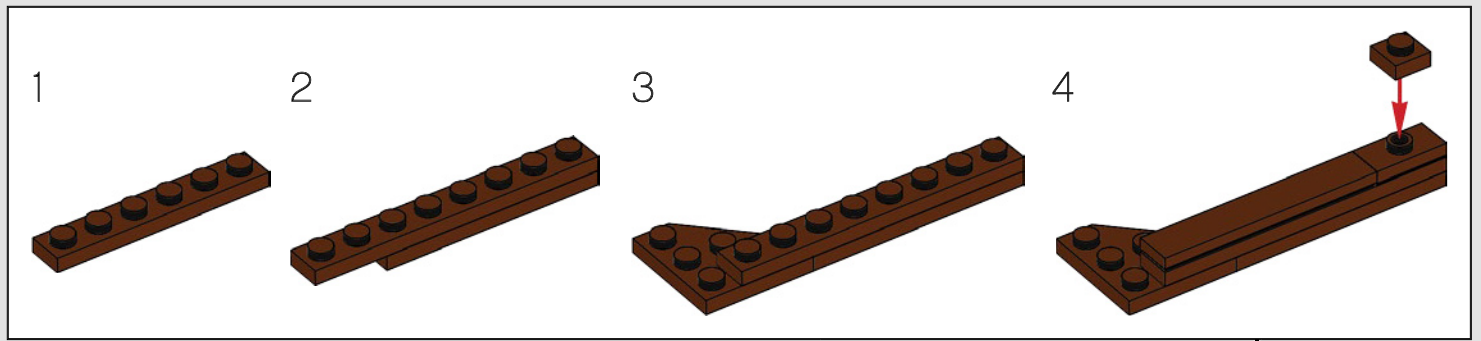

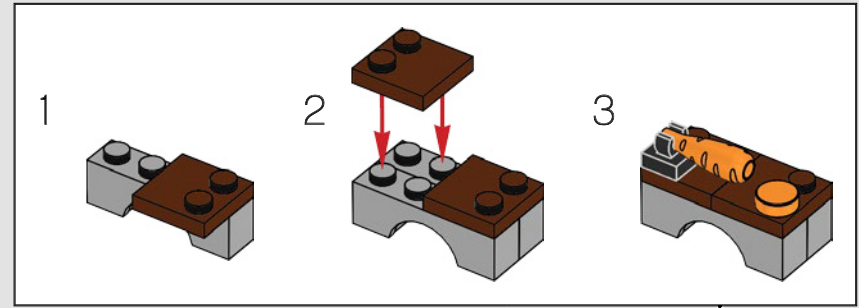
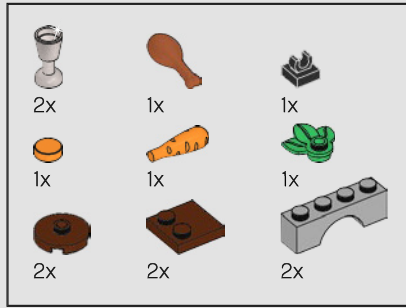
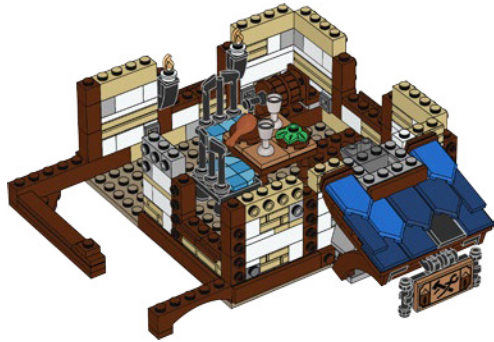

108

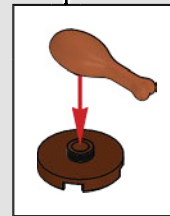
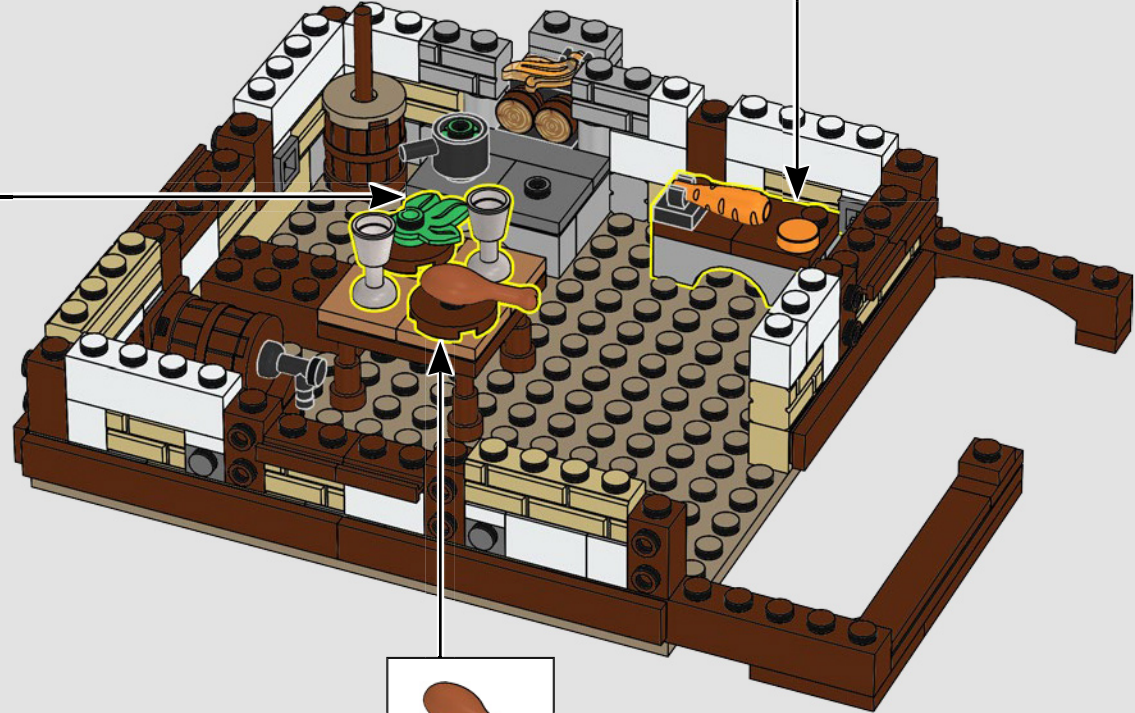
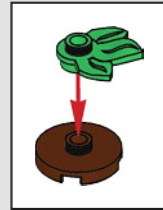

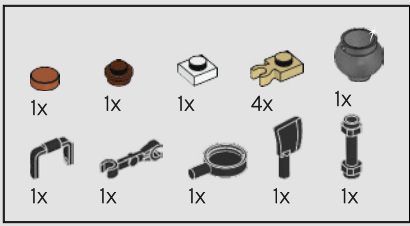

109

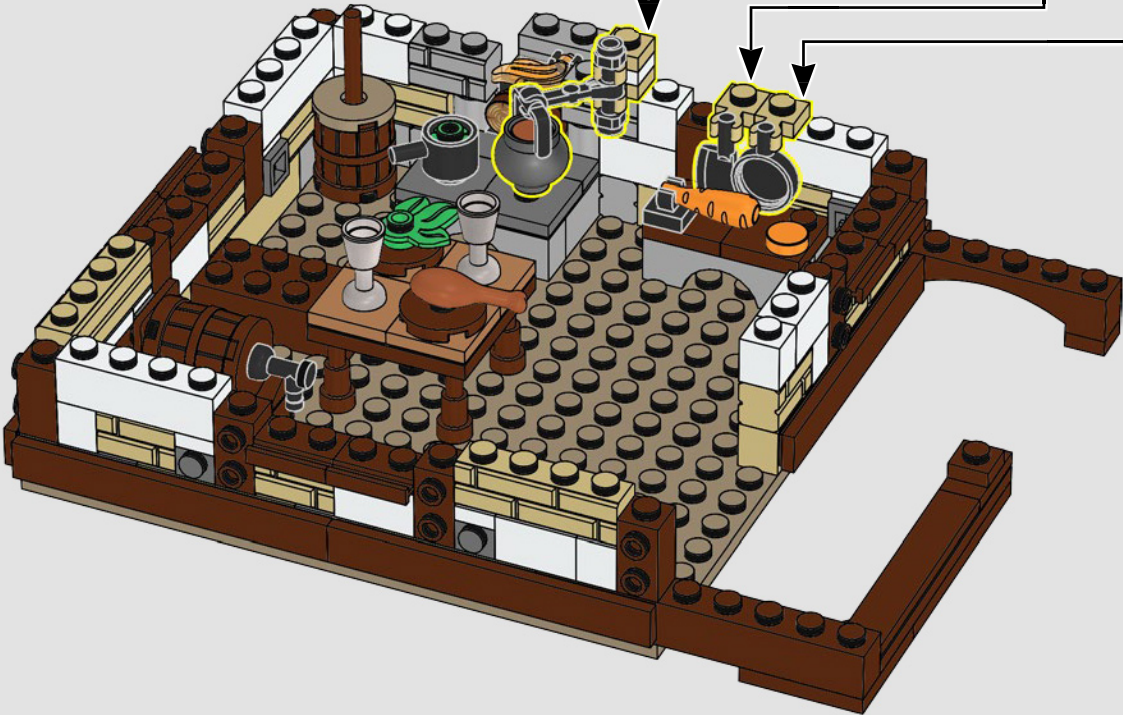
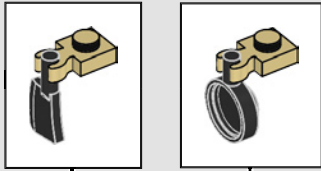
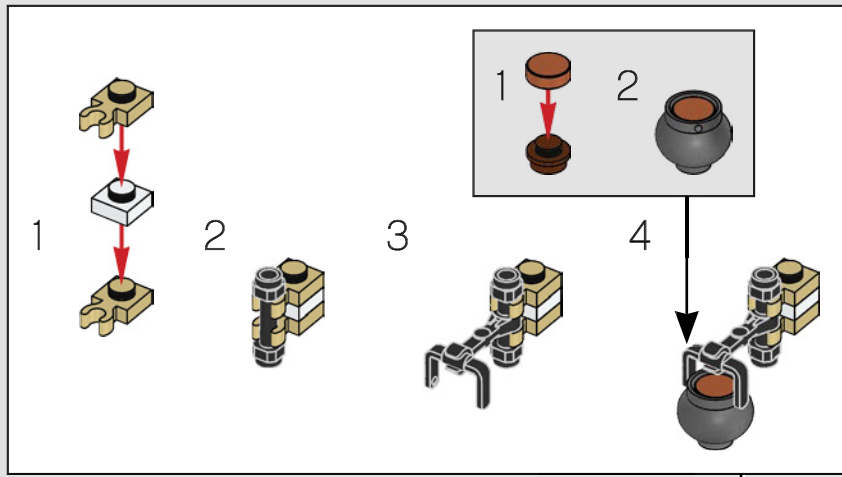

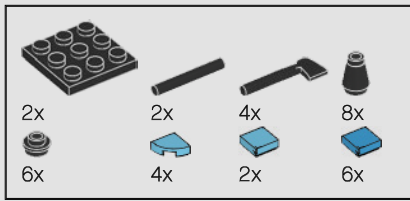

110

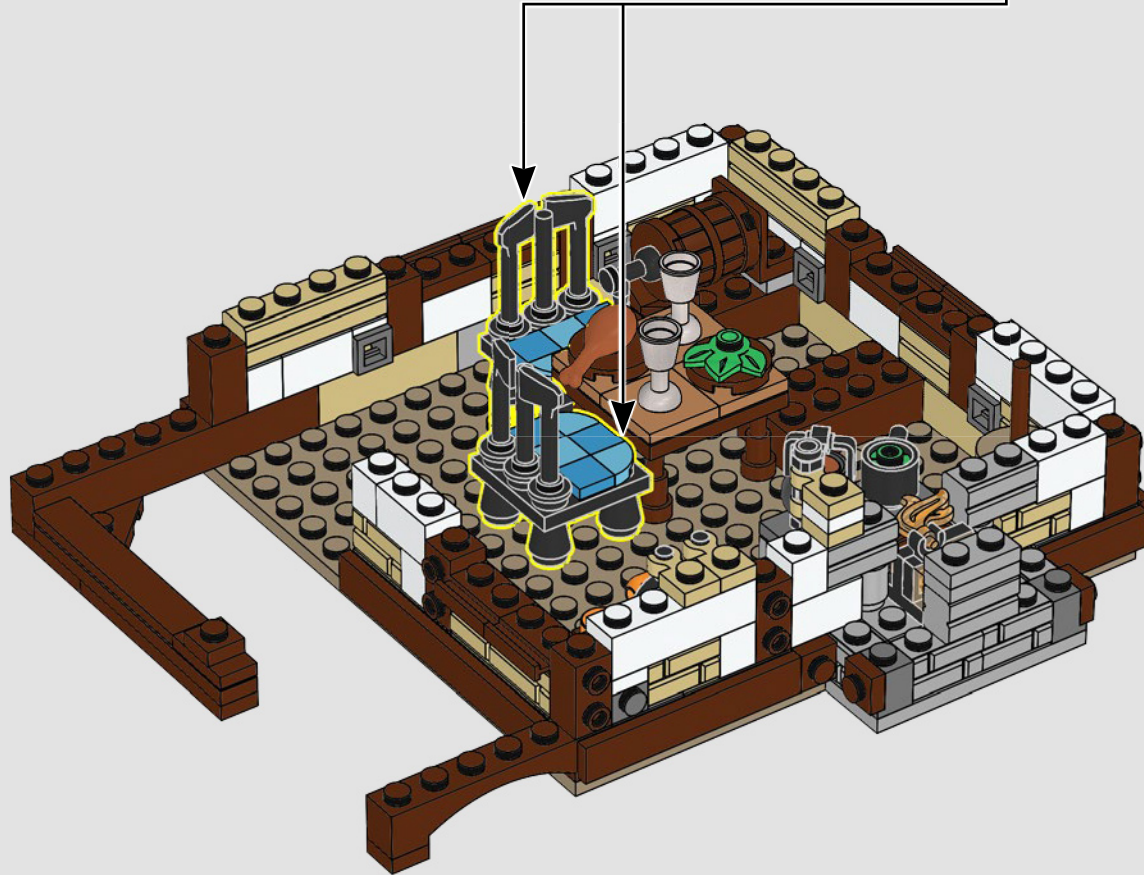
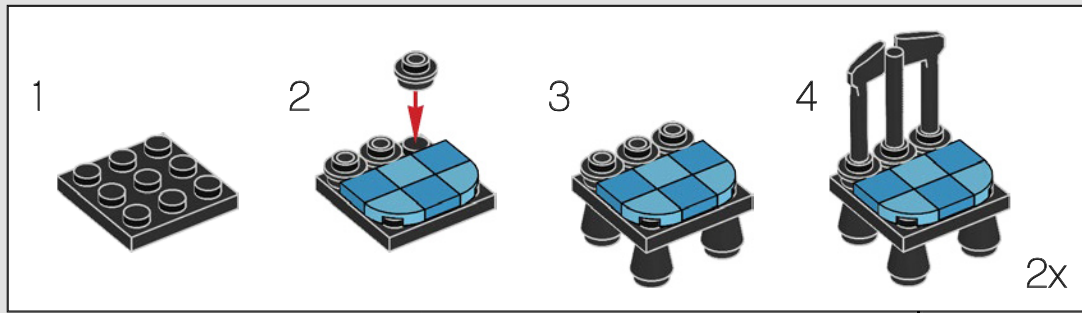

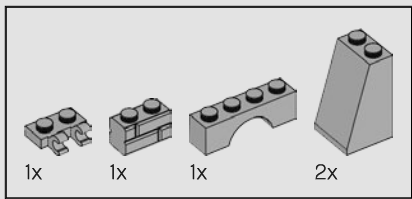

111

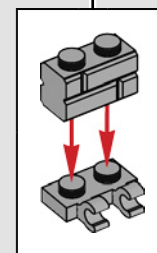

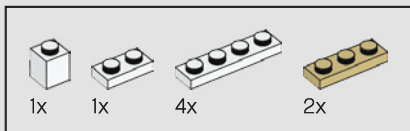

112

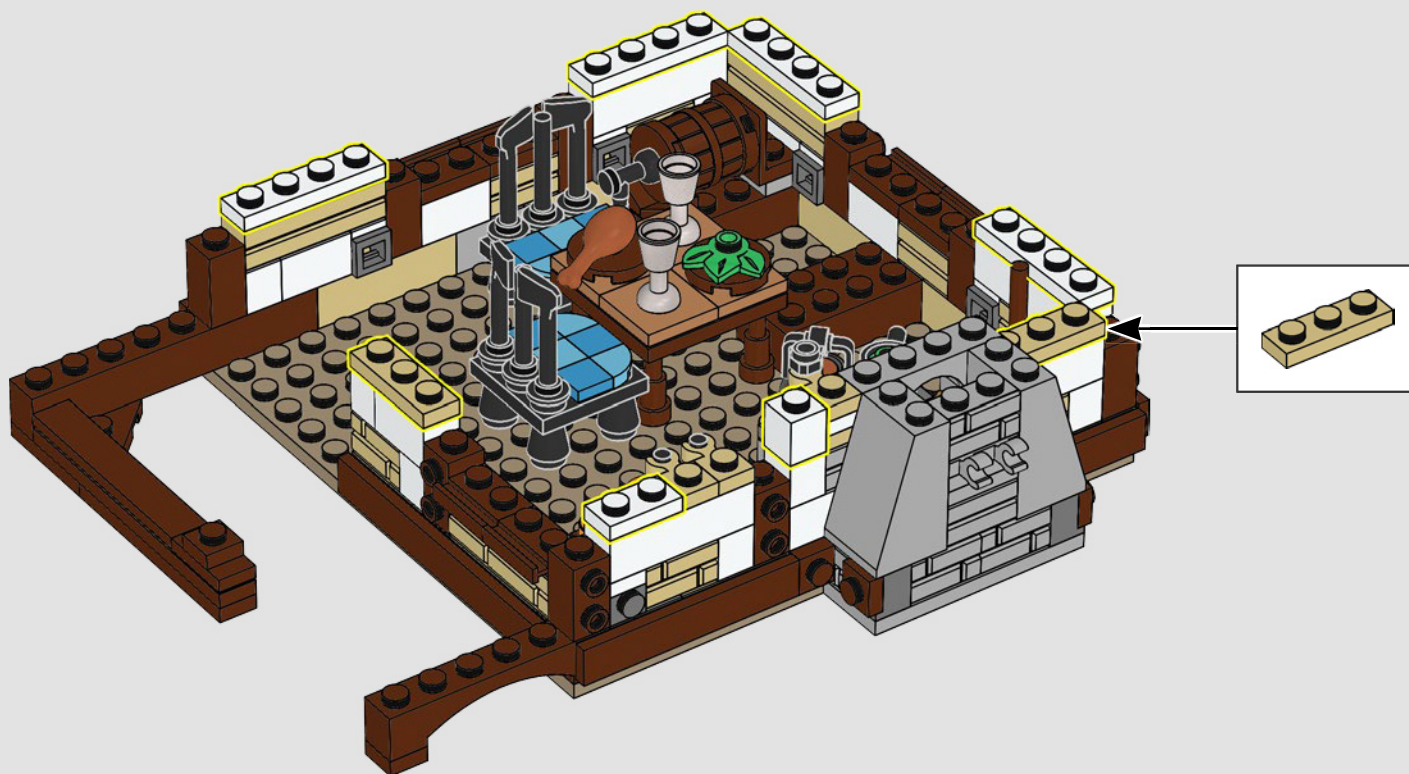

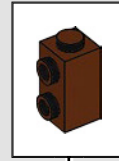
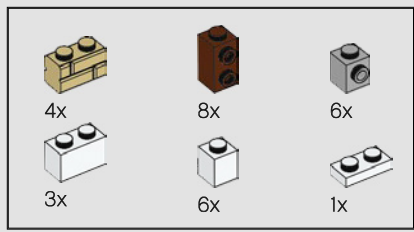

113

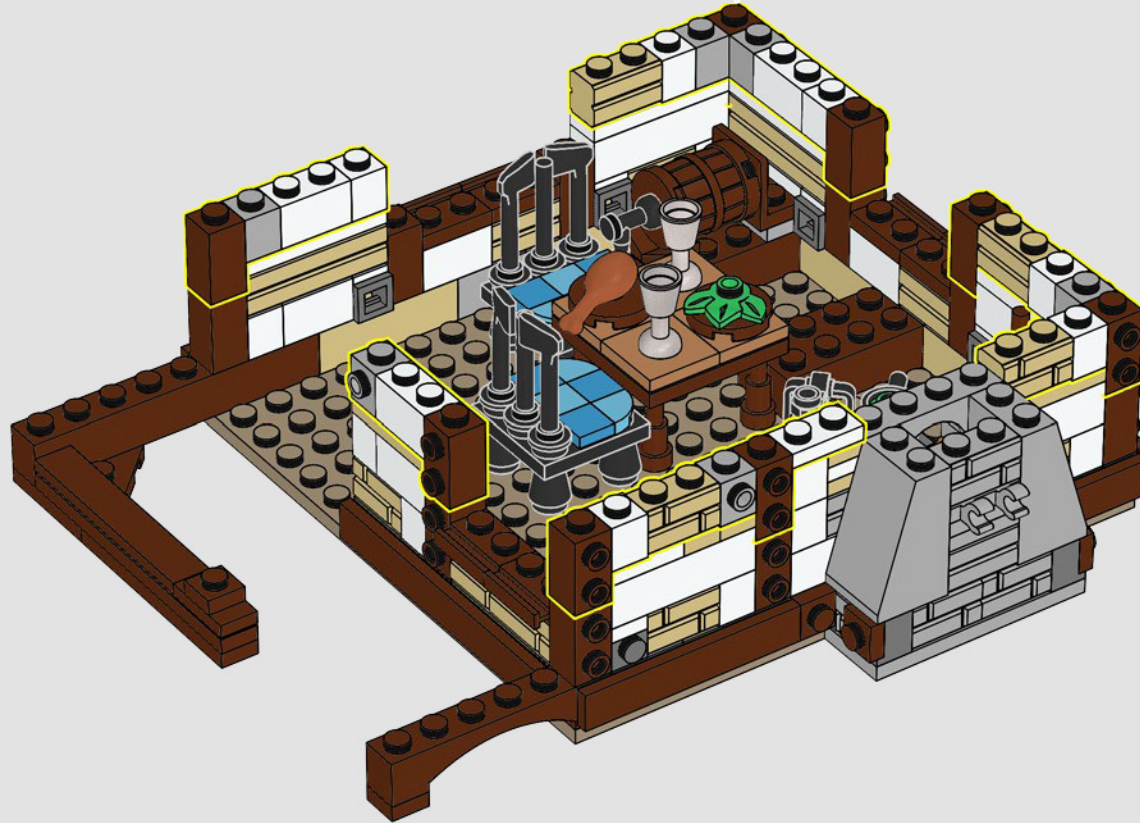

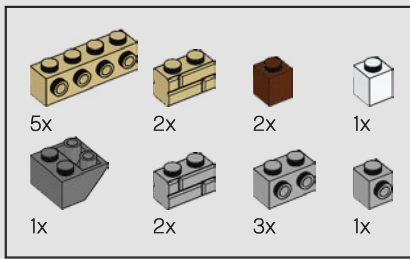

114

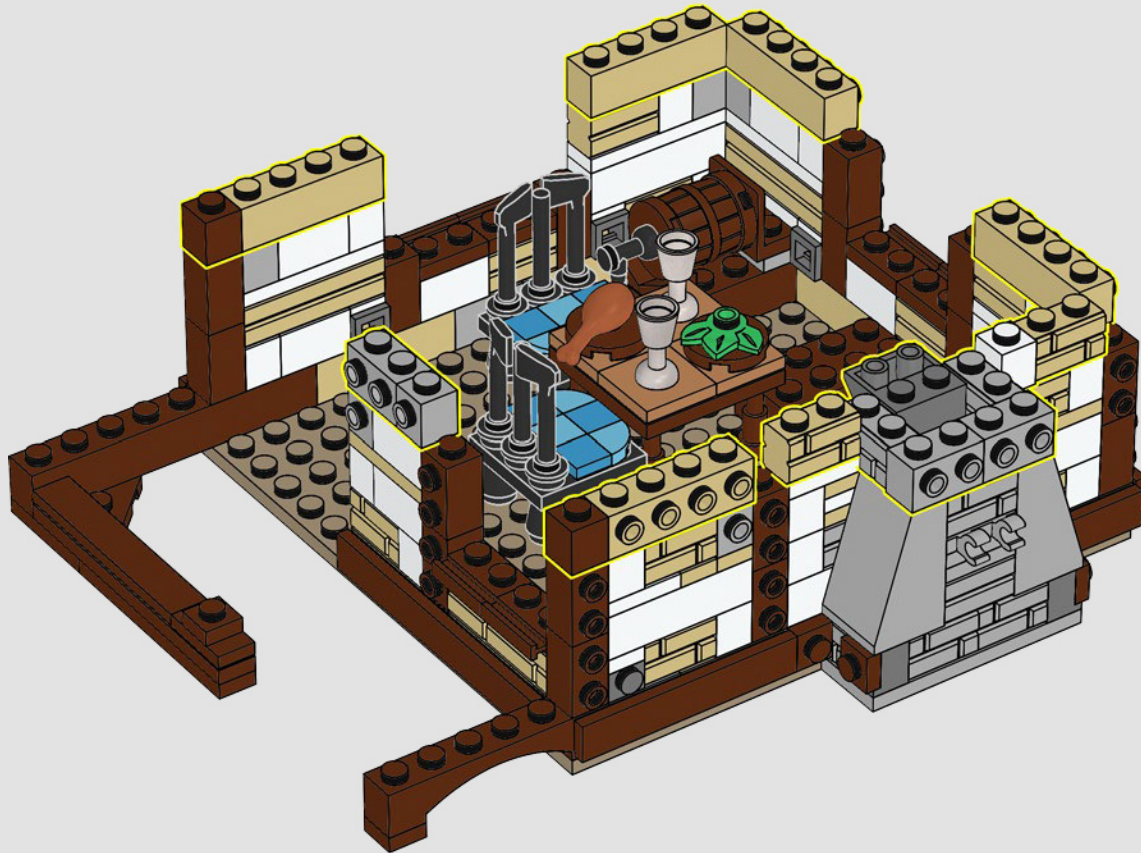

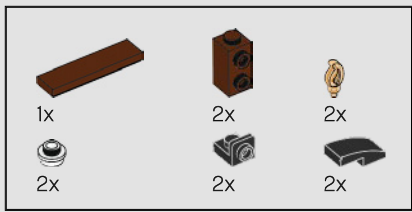

115

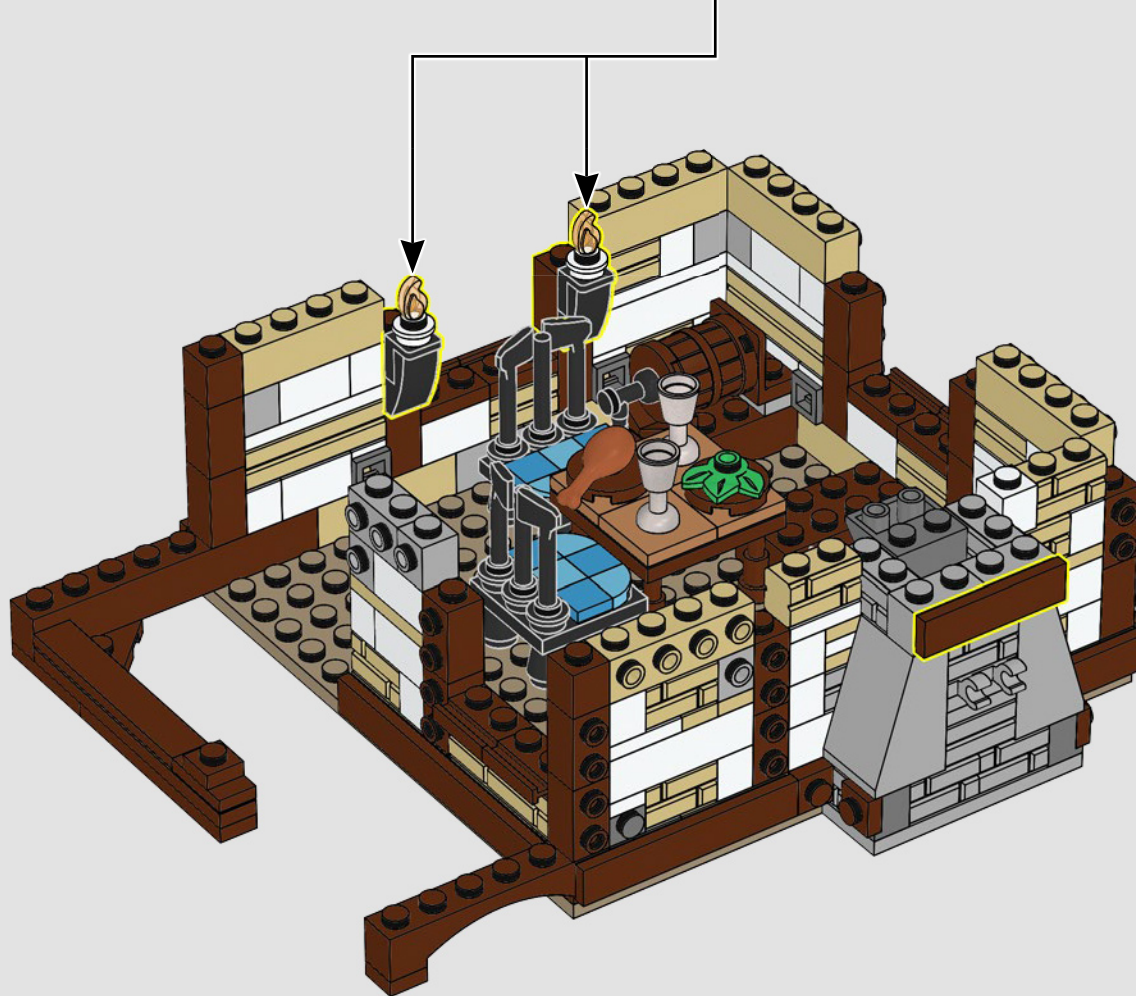
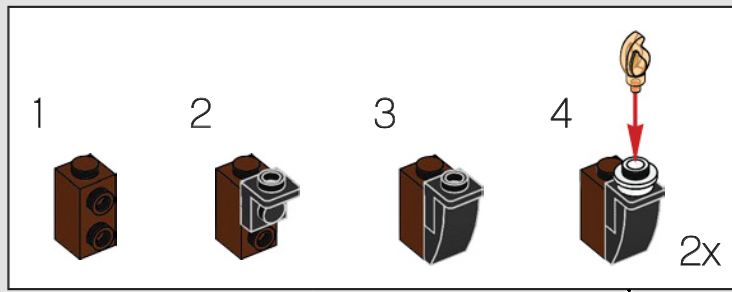

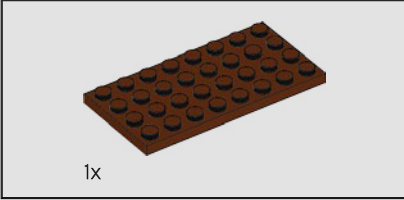
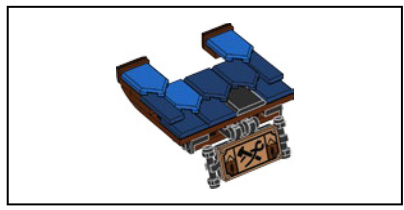

1x

116

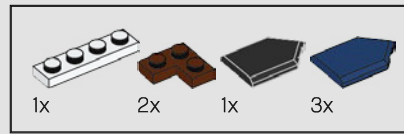
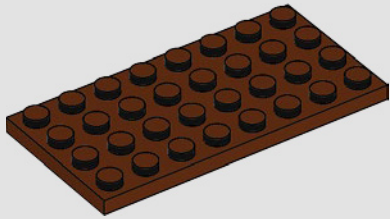

117

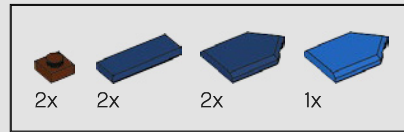
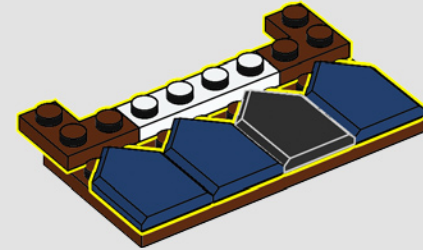

118

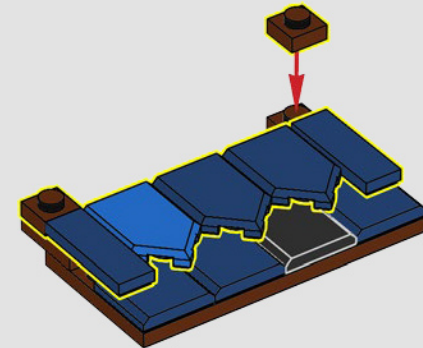



119

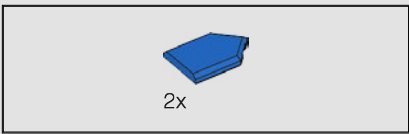
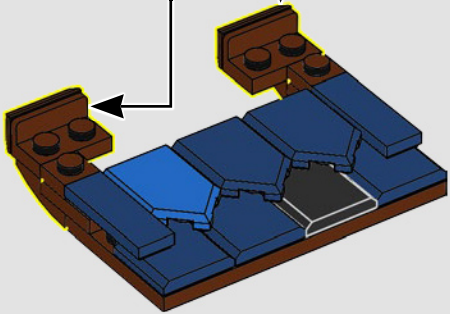
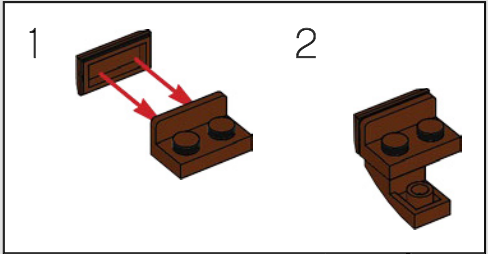
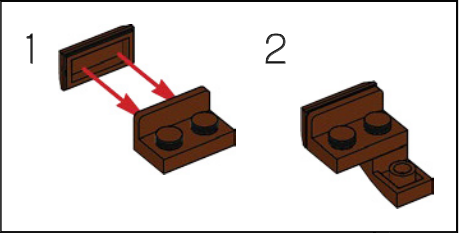

120

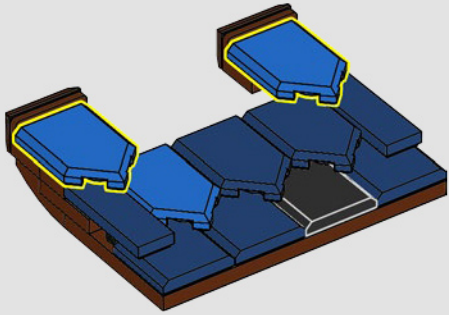

121

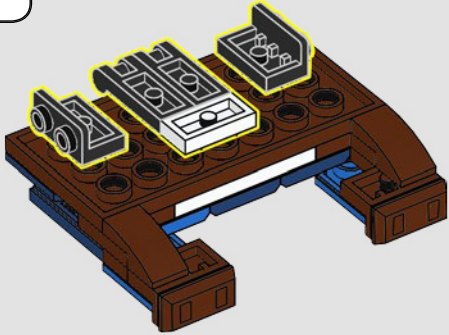



122

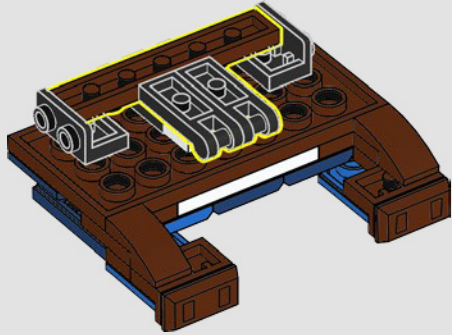

123

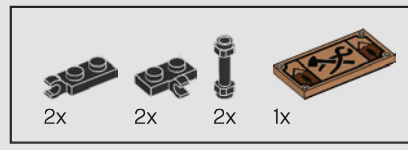
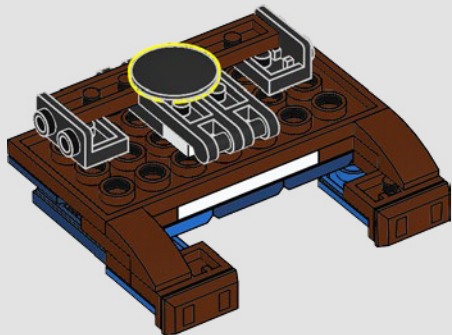

124

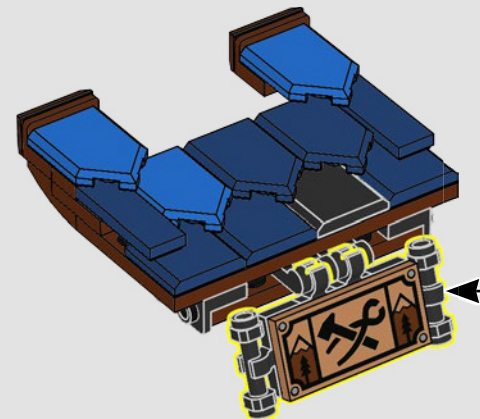
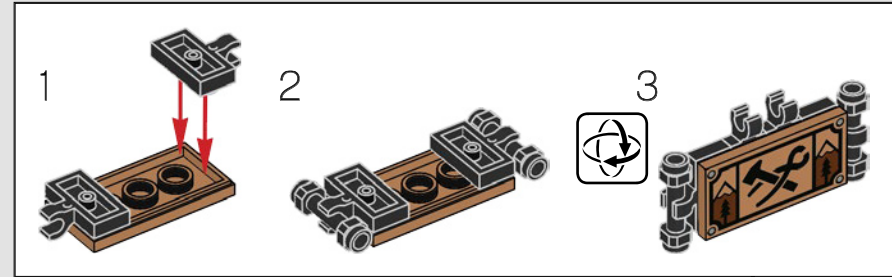

125



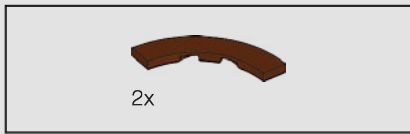

126

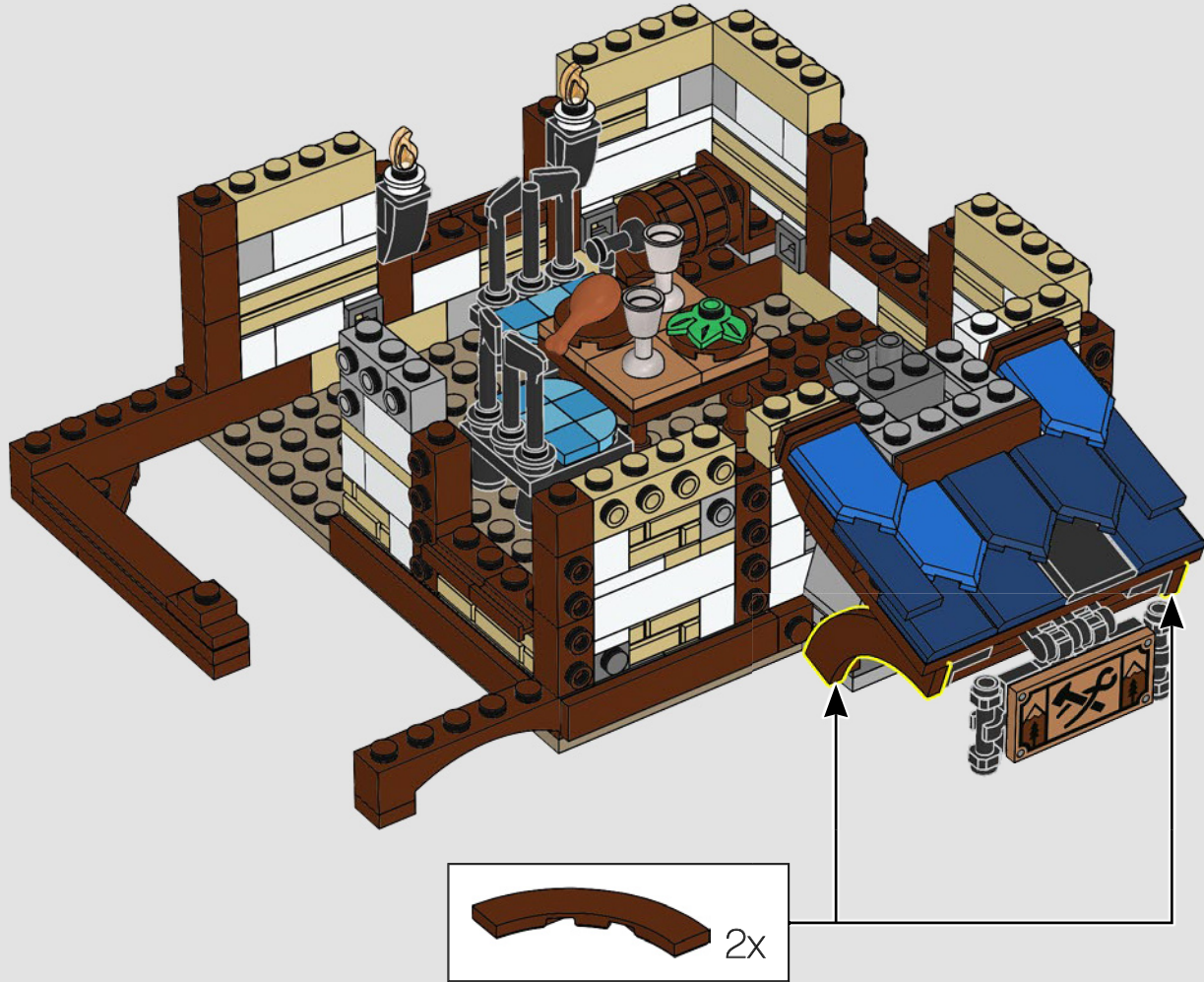

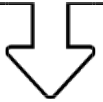

127

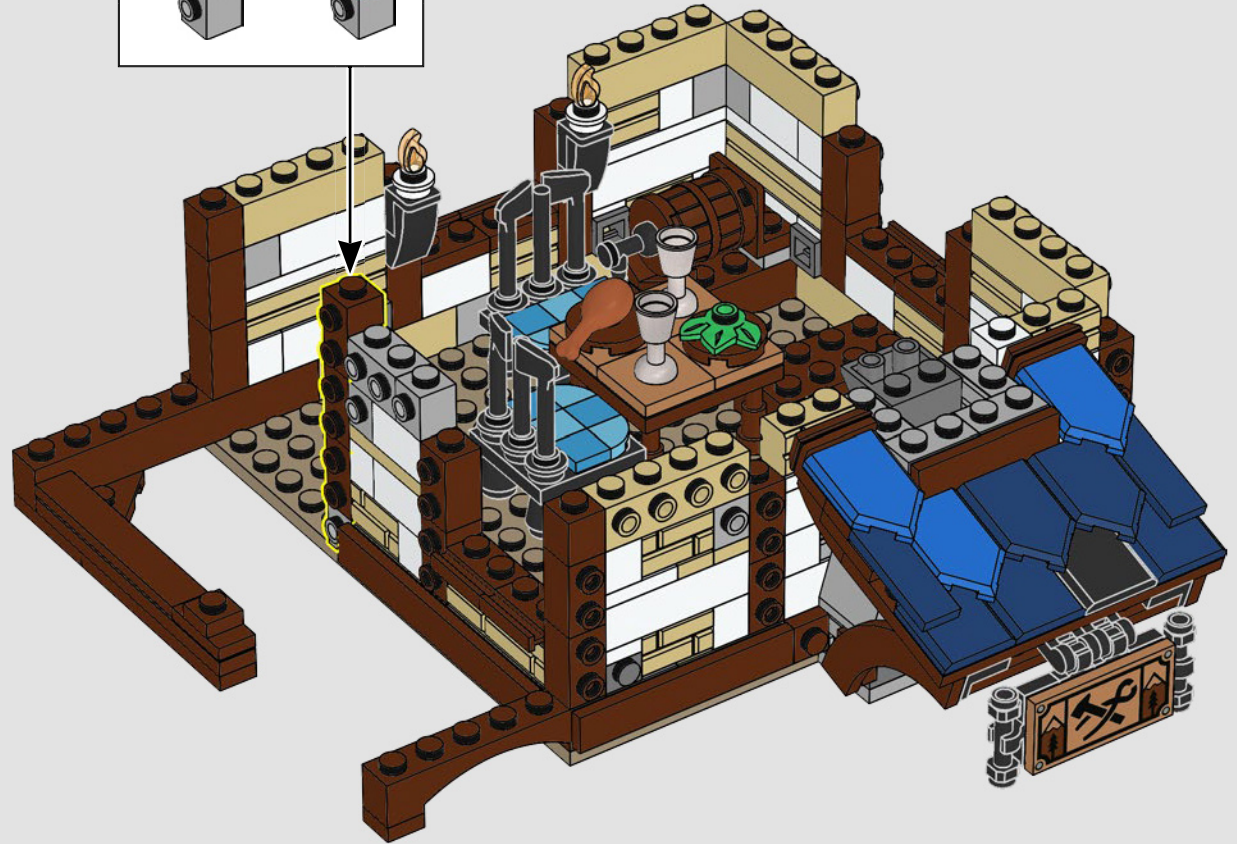
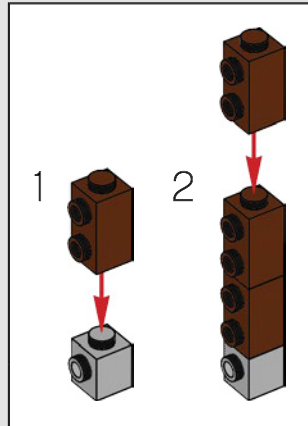

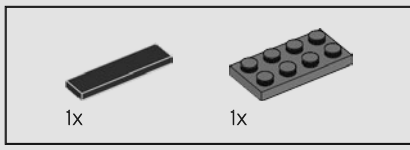

128

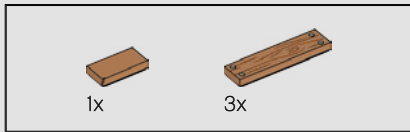
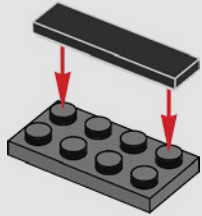

129

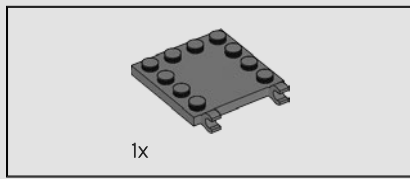
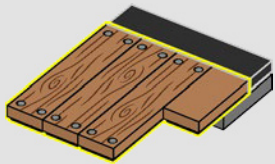

130

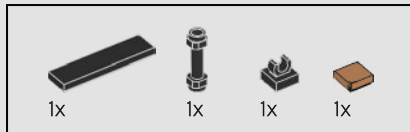
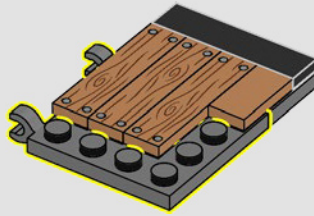

131

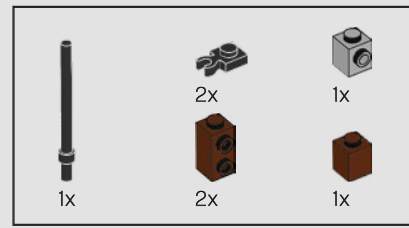
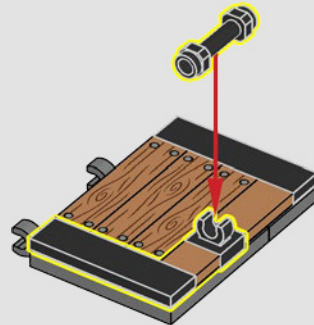

132

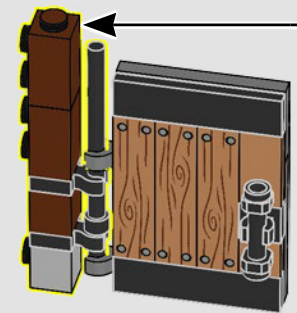
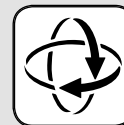
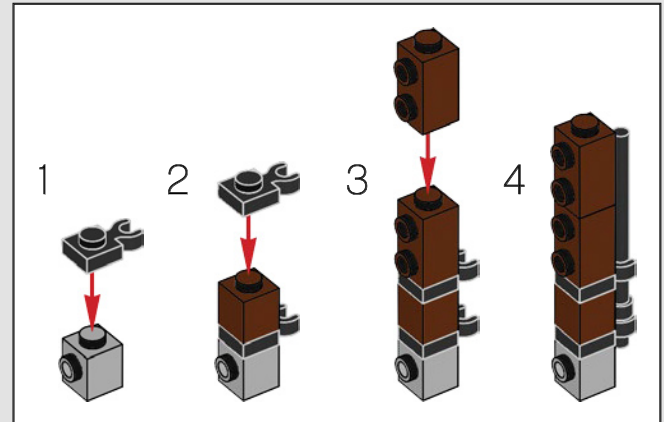

133

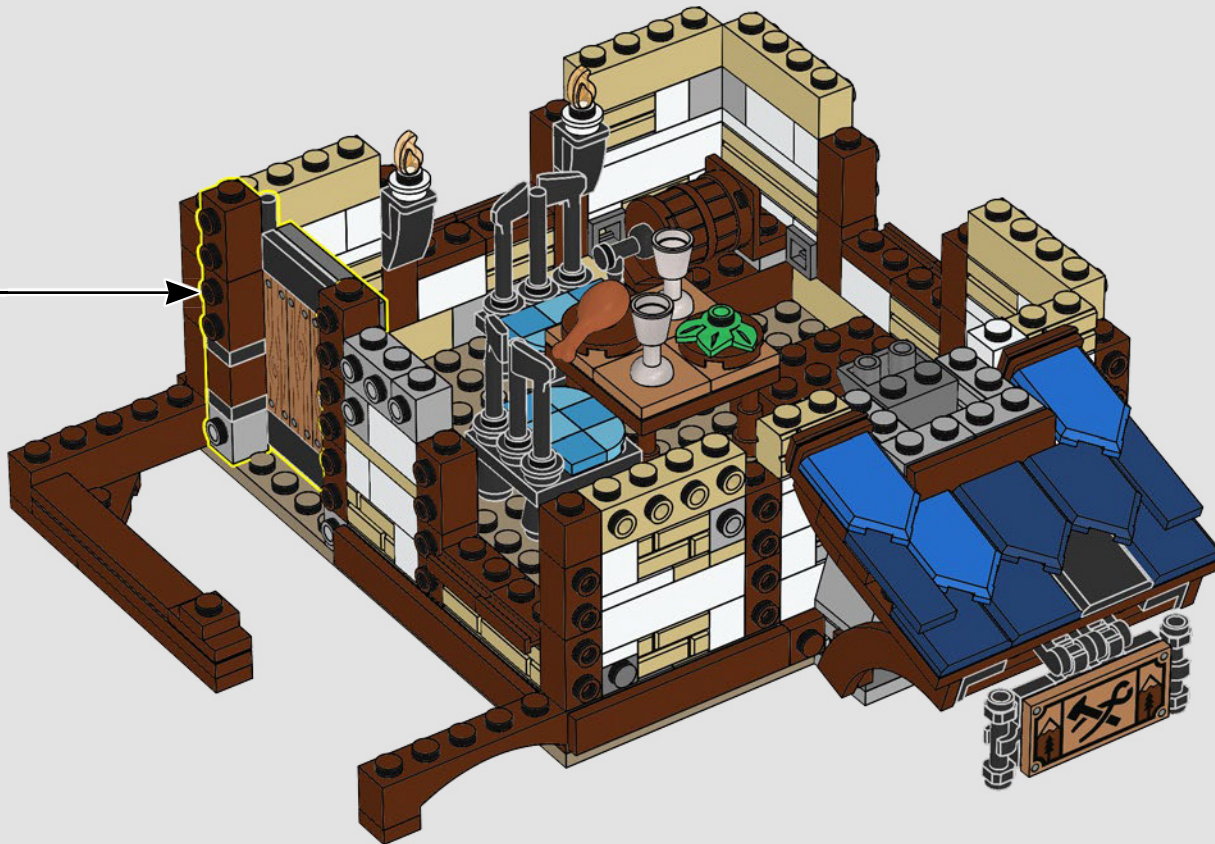

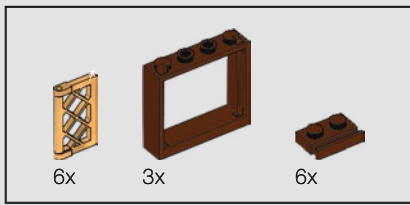

134

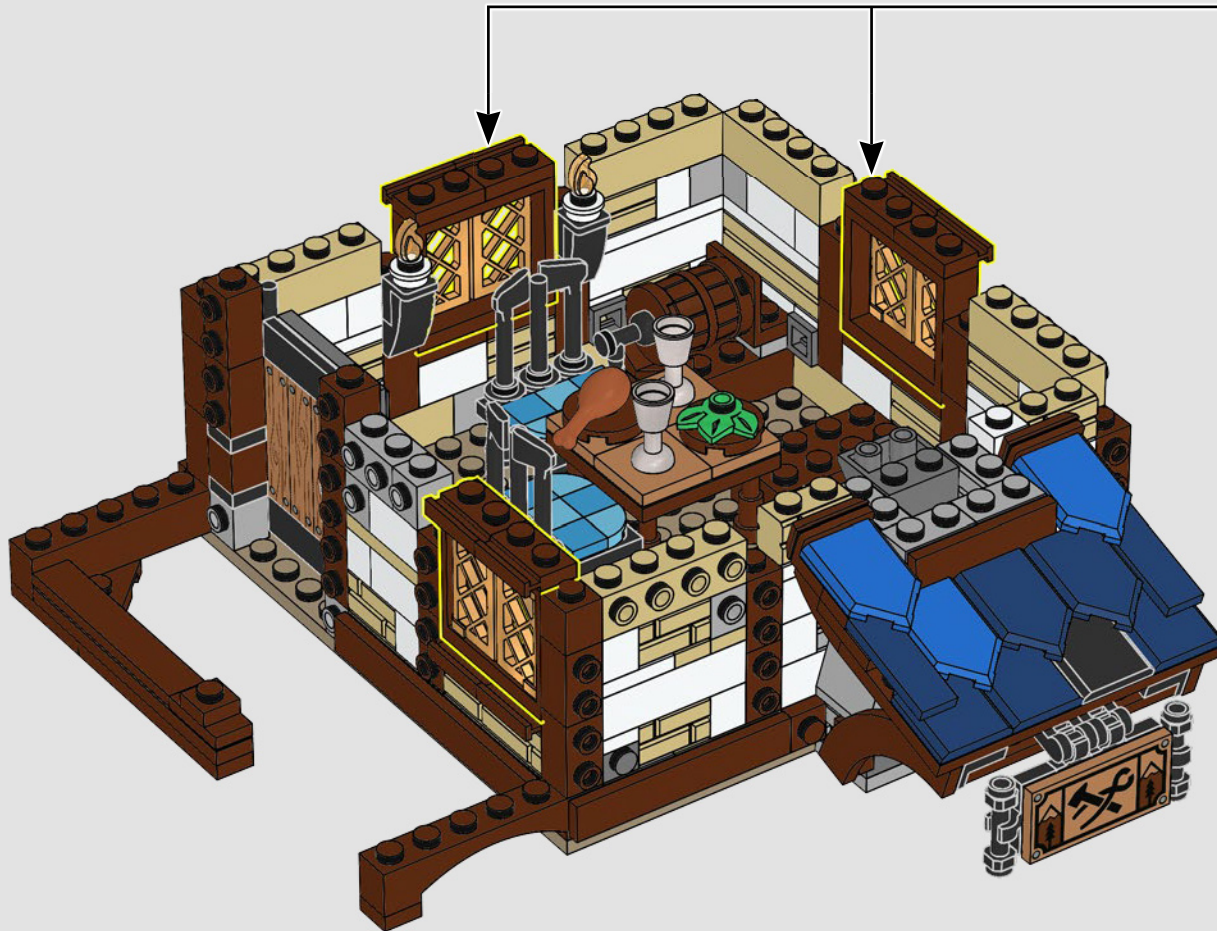
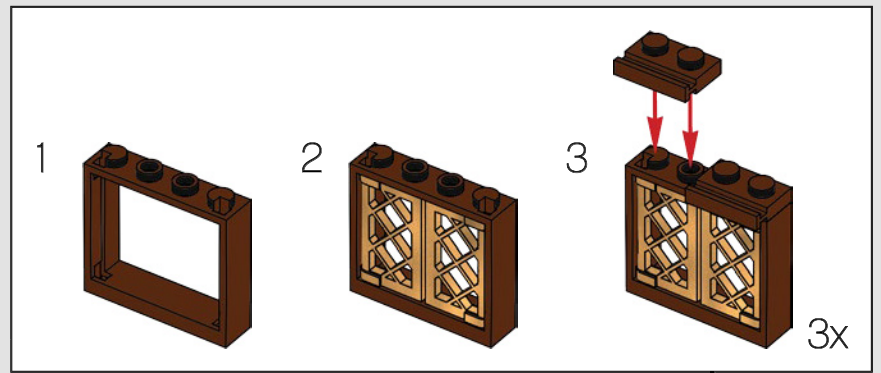

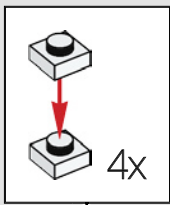
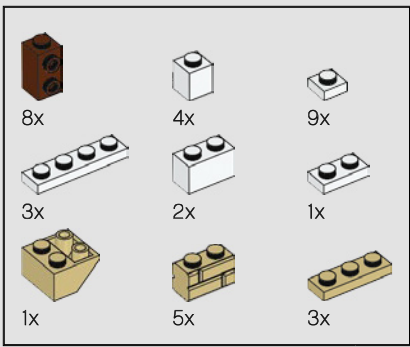

135

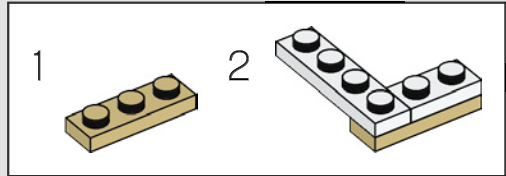
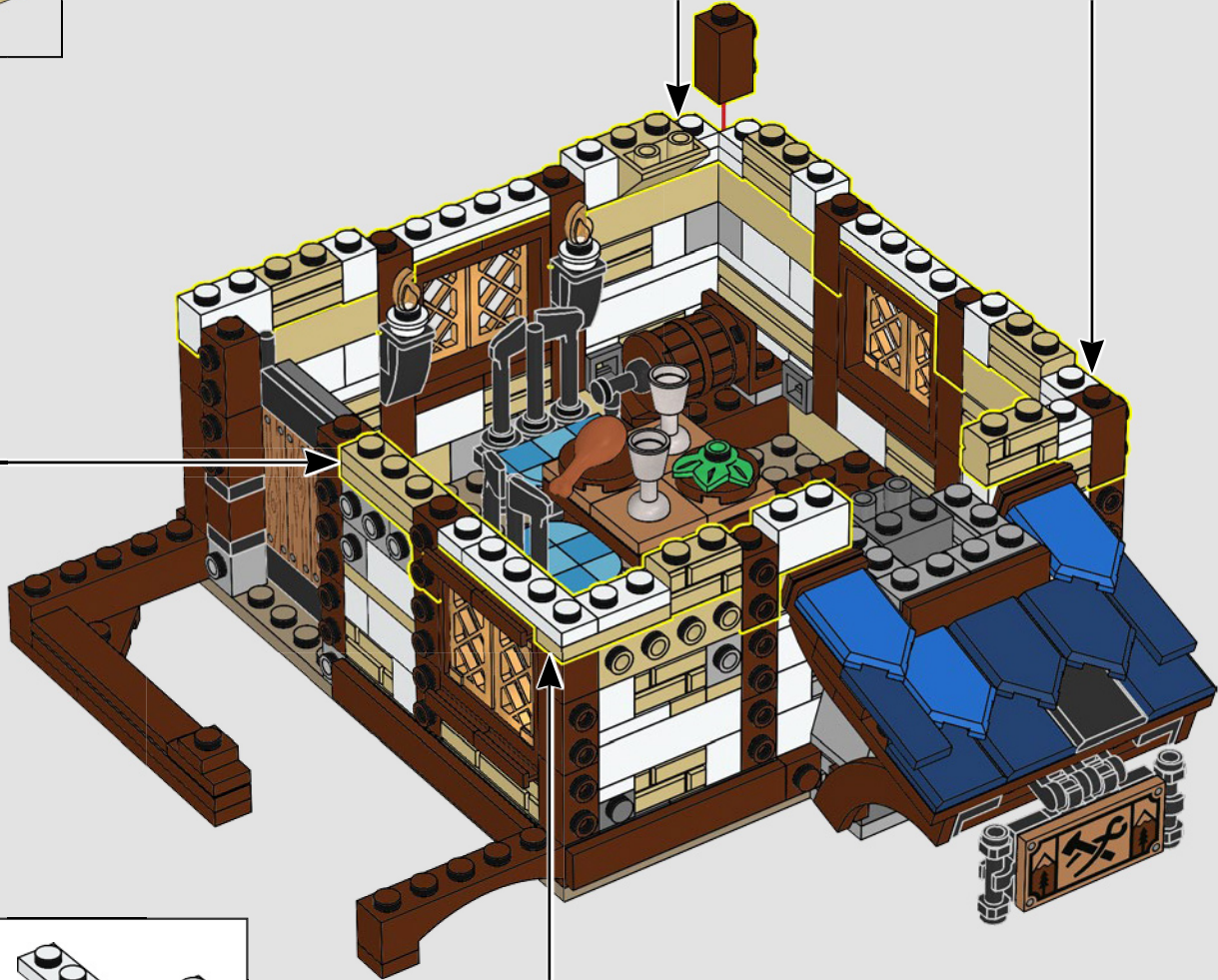
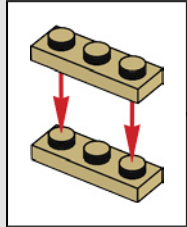

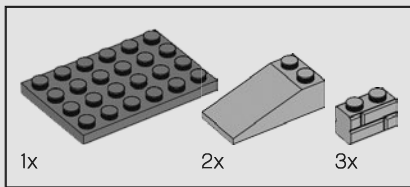

136

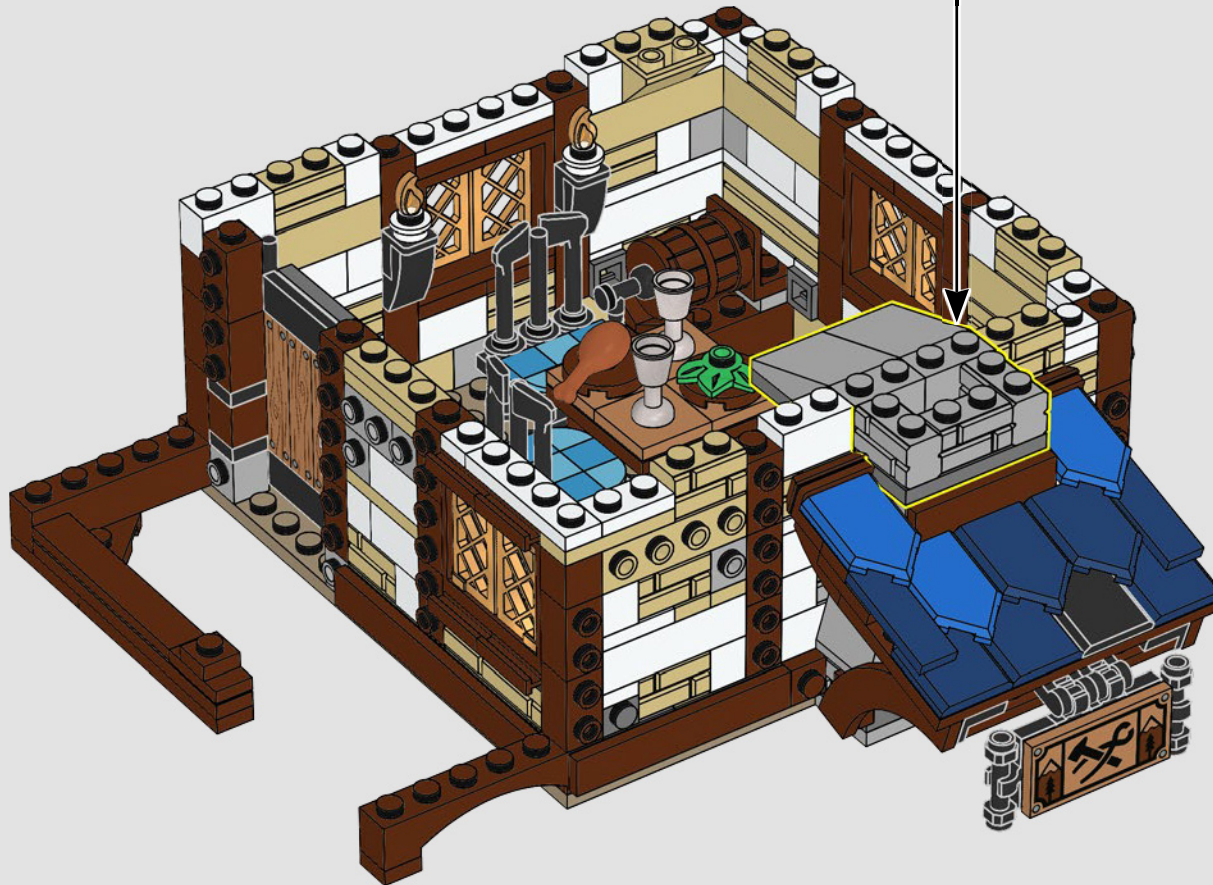
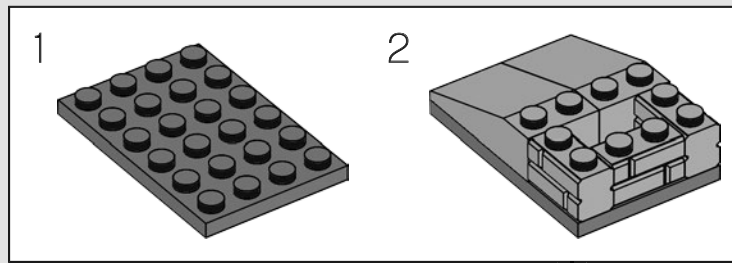

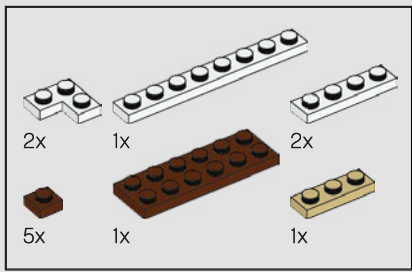

137

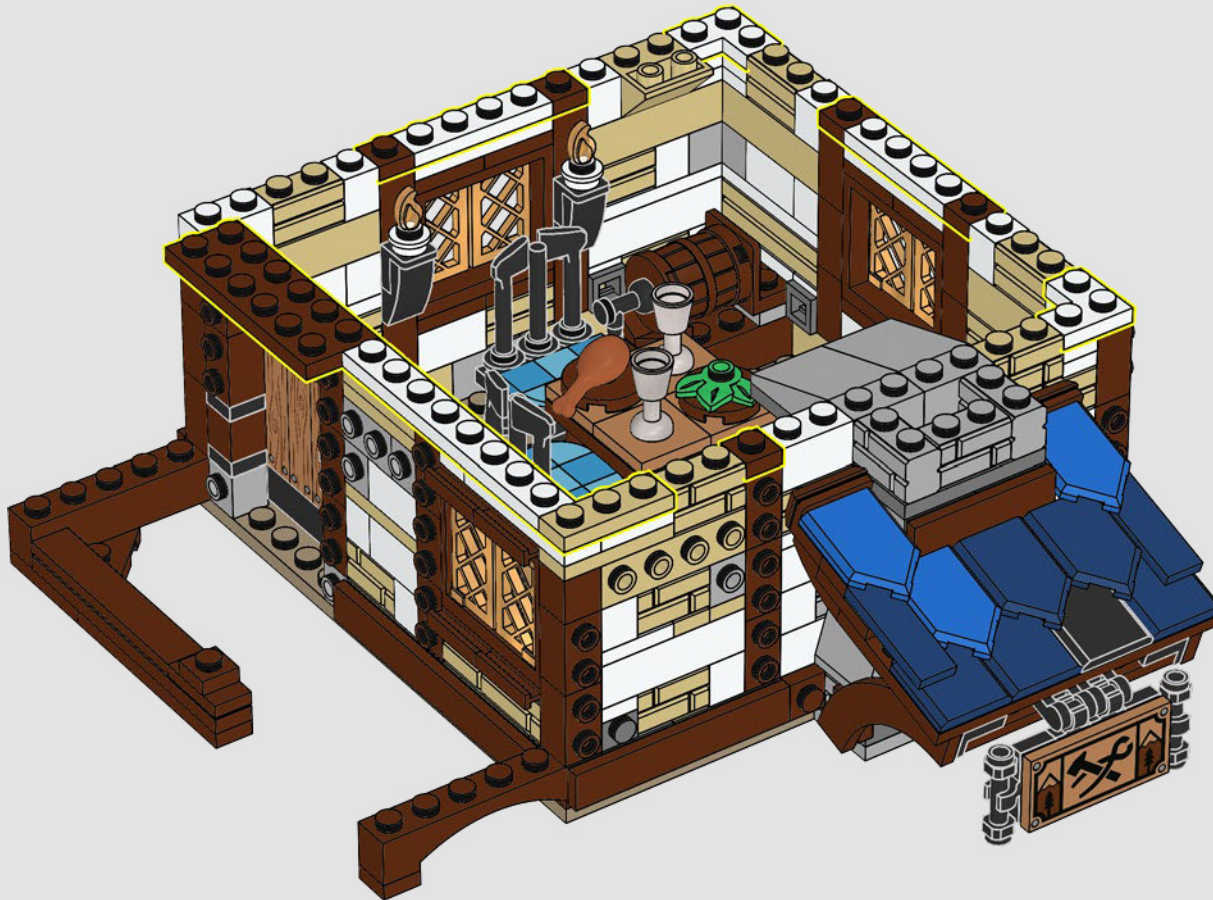

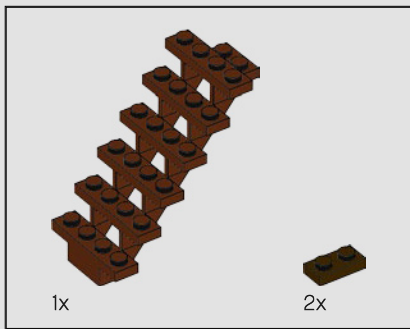

138

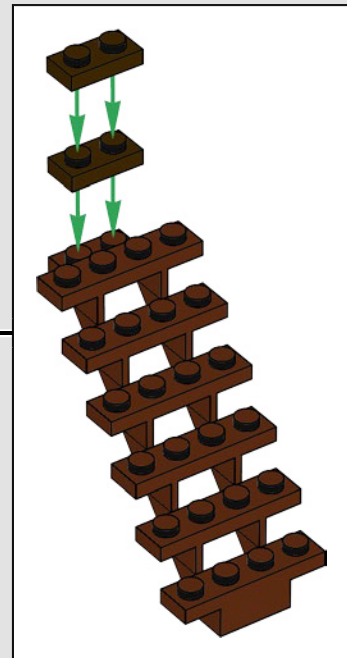
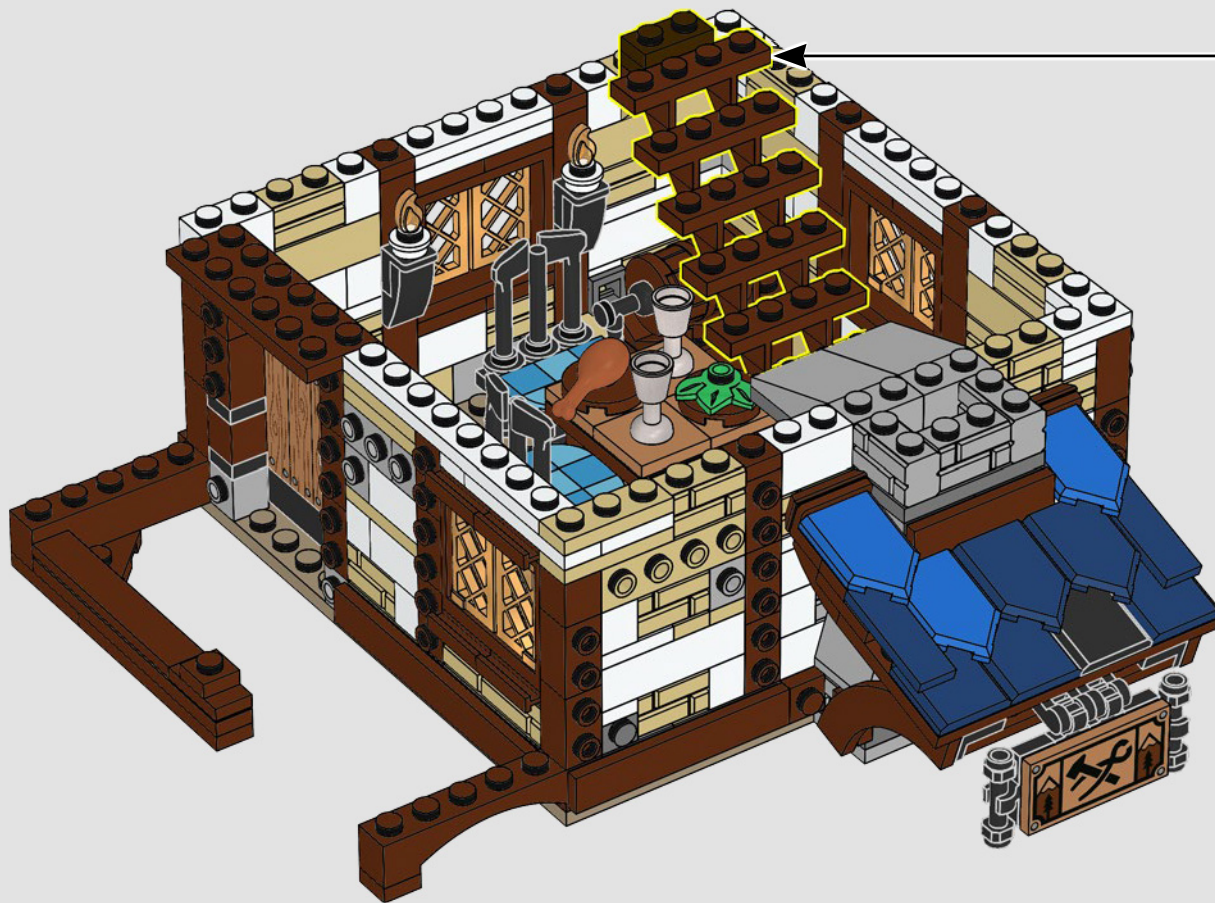

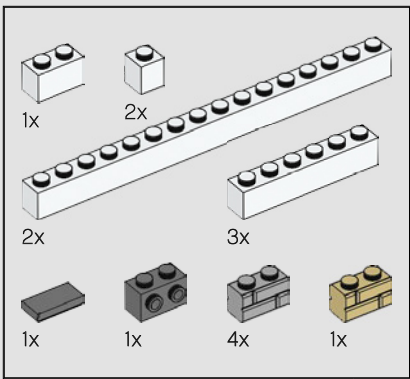

139

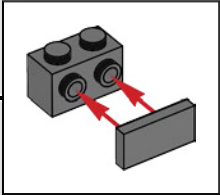
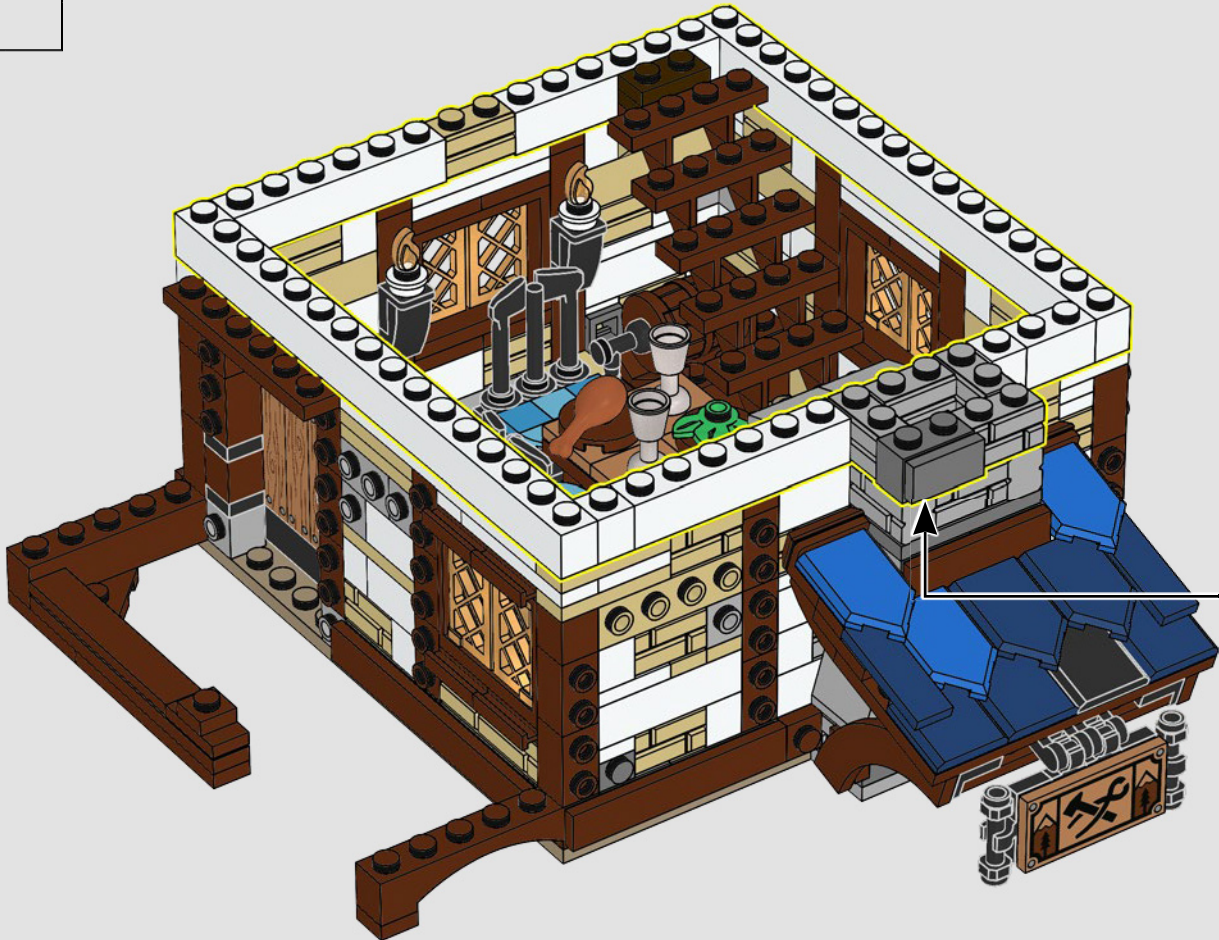

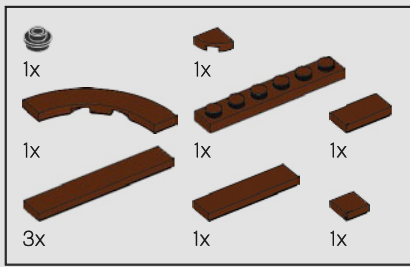

140

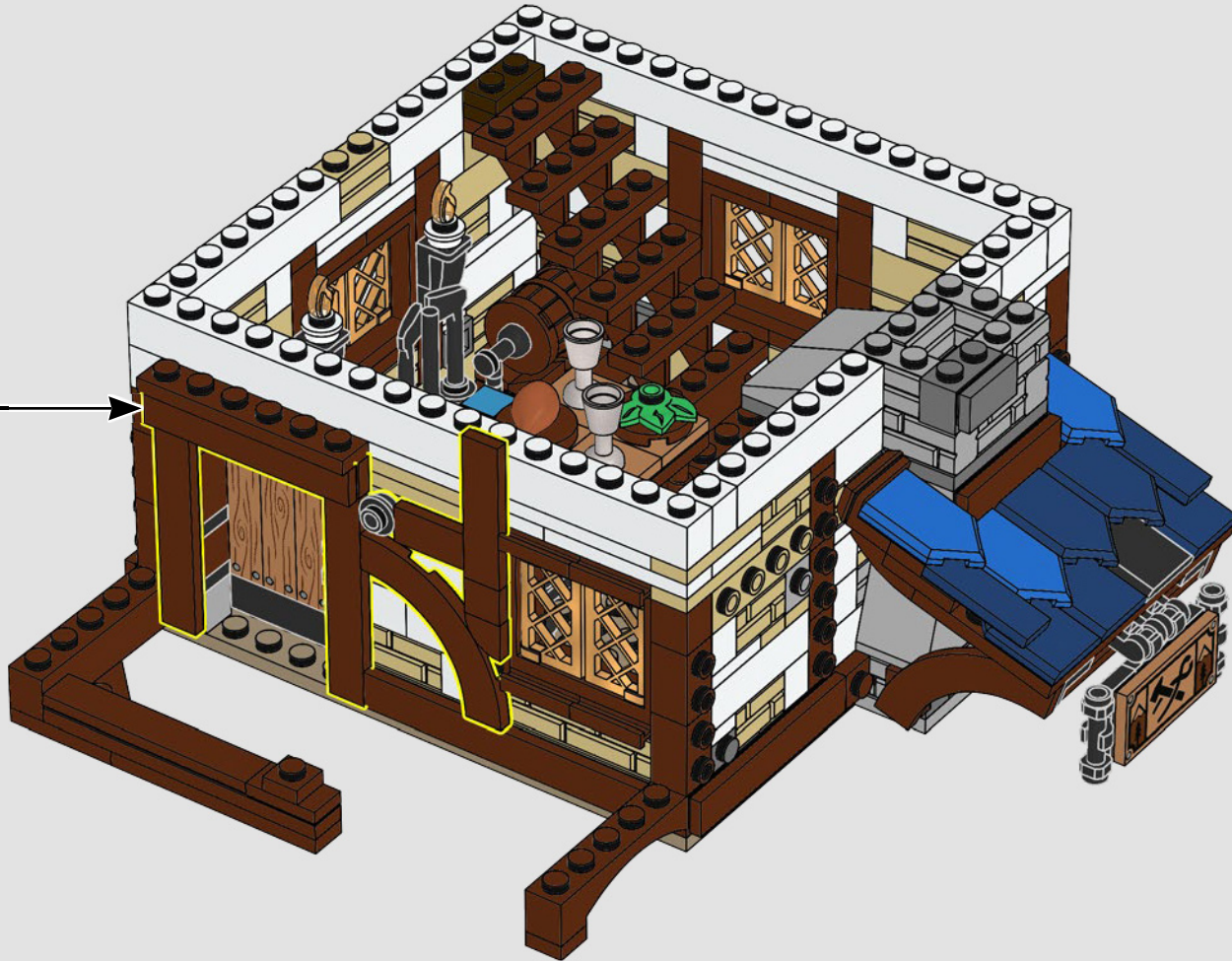
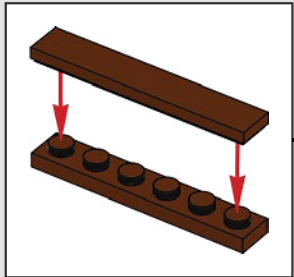

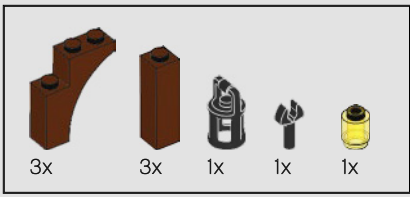

141

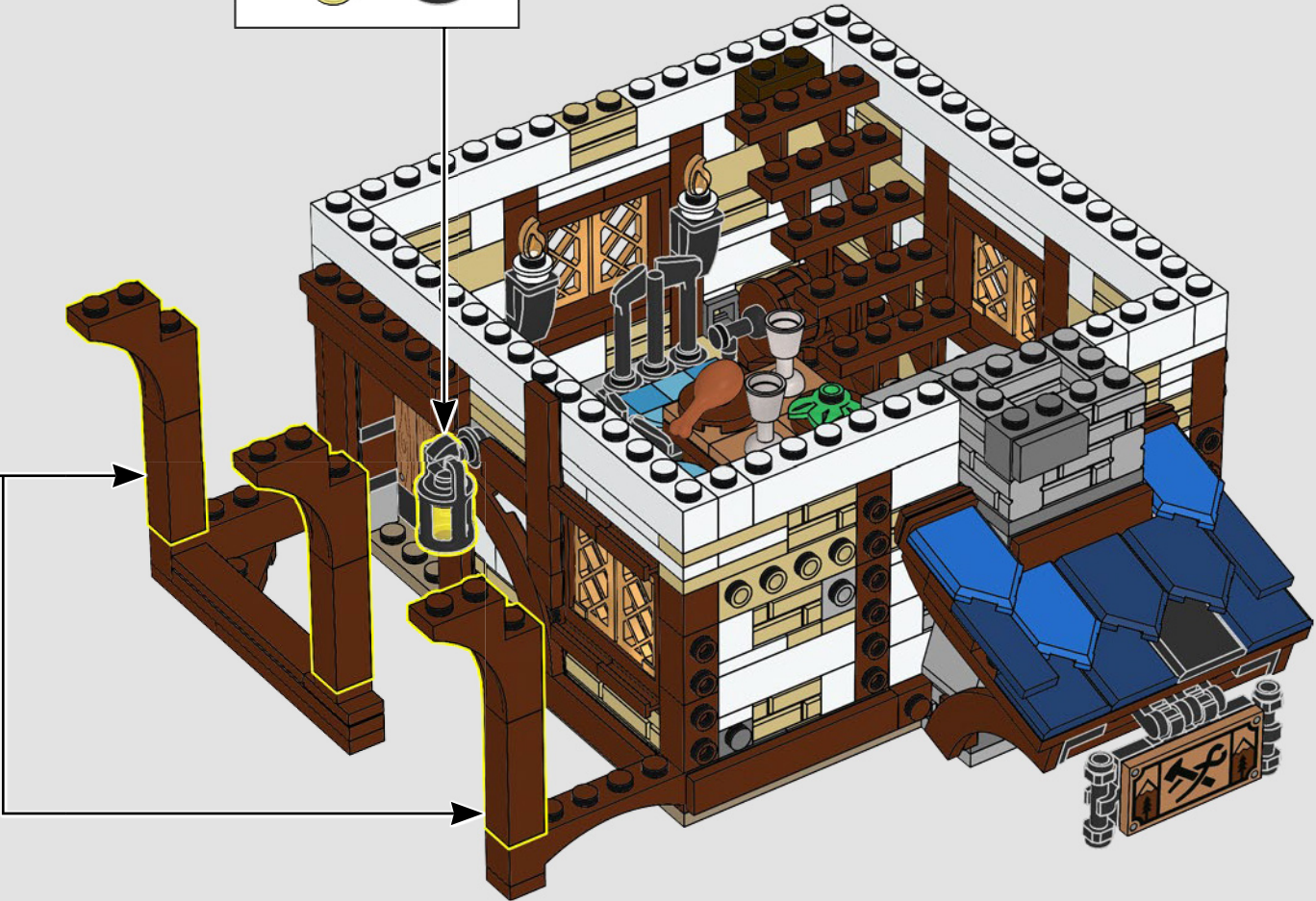
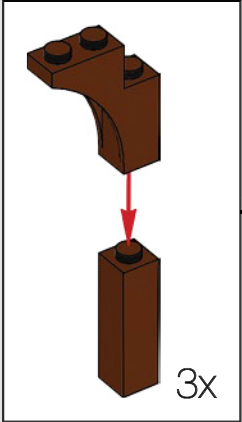
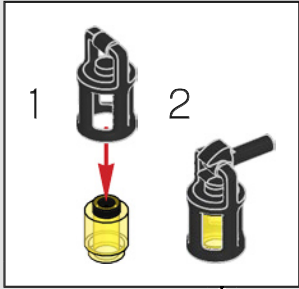

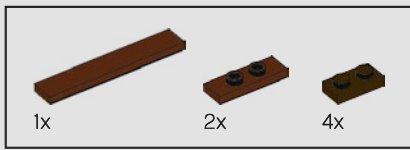

142

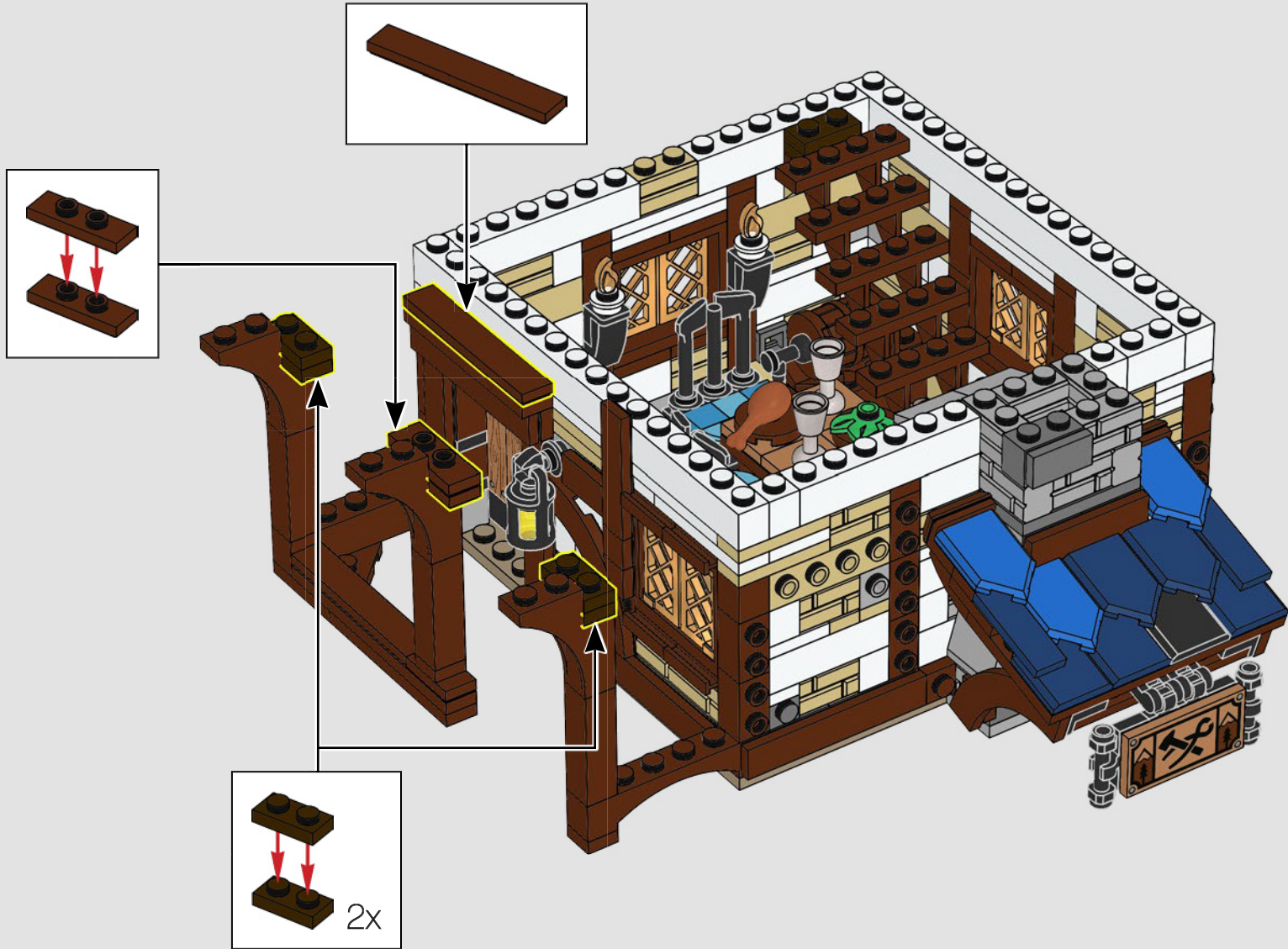

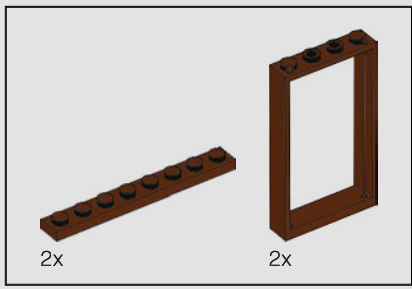

143

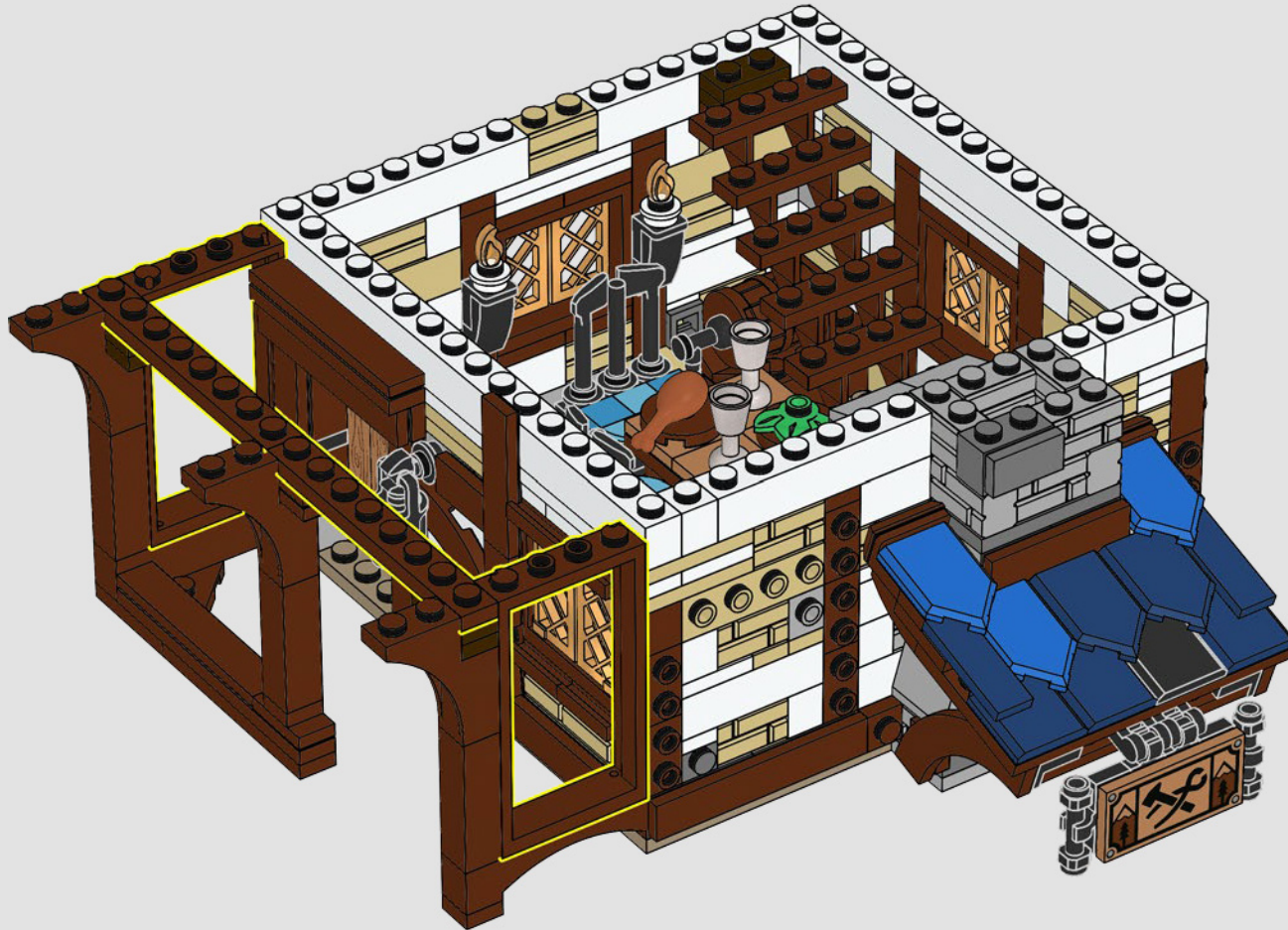

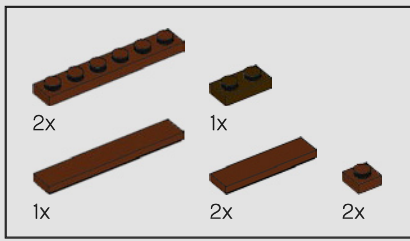

144

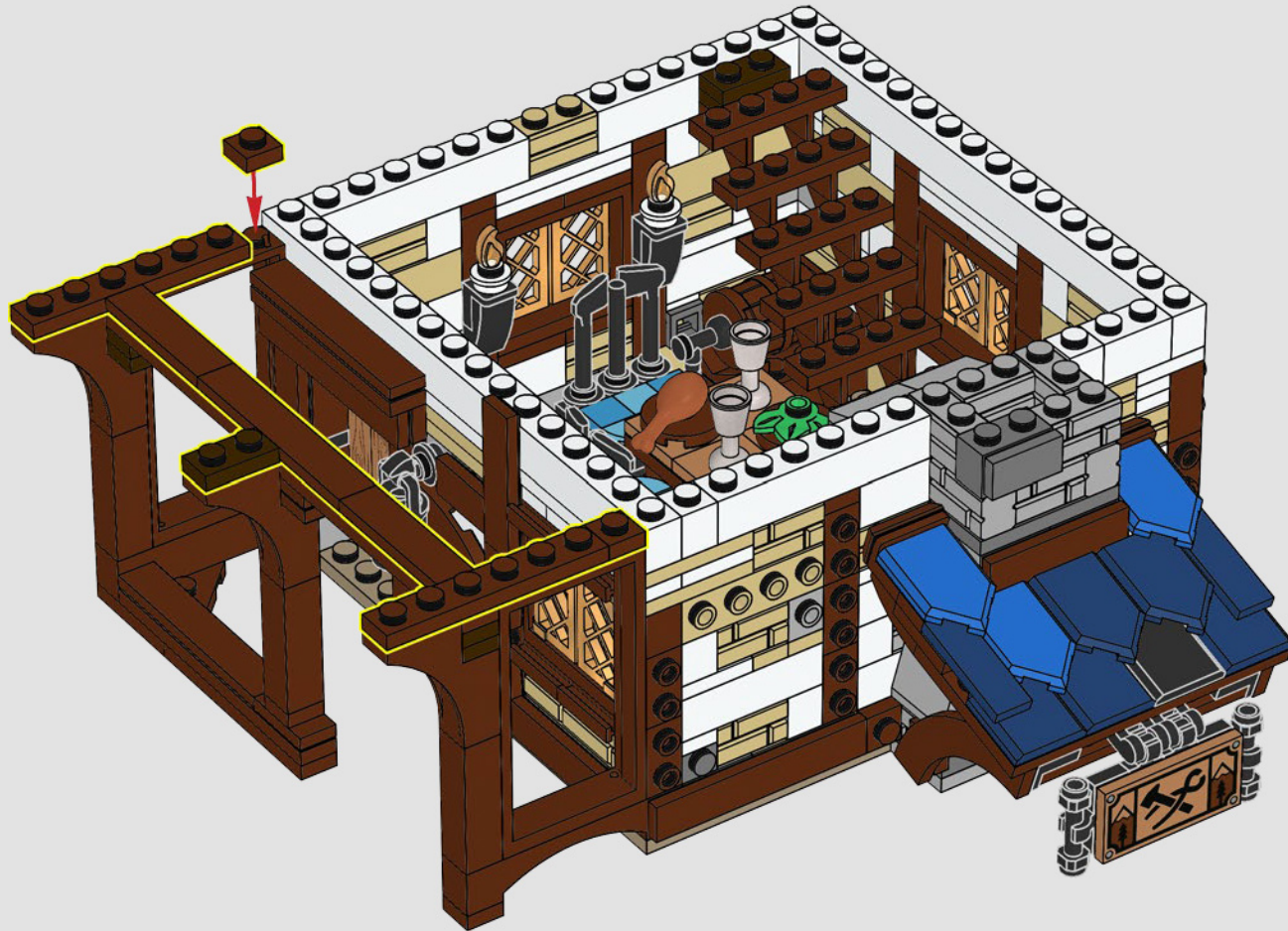

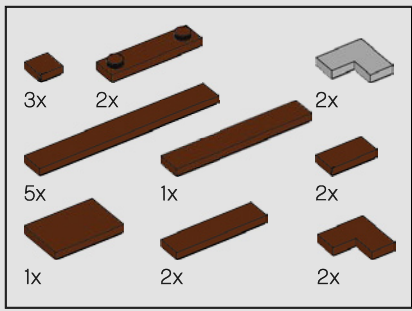

145

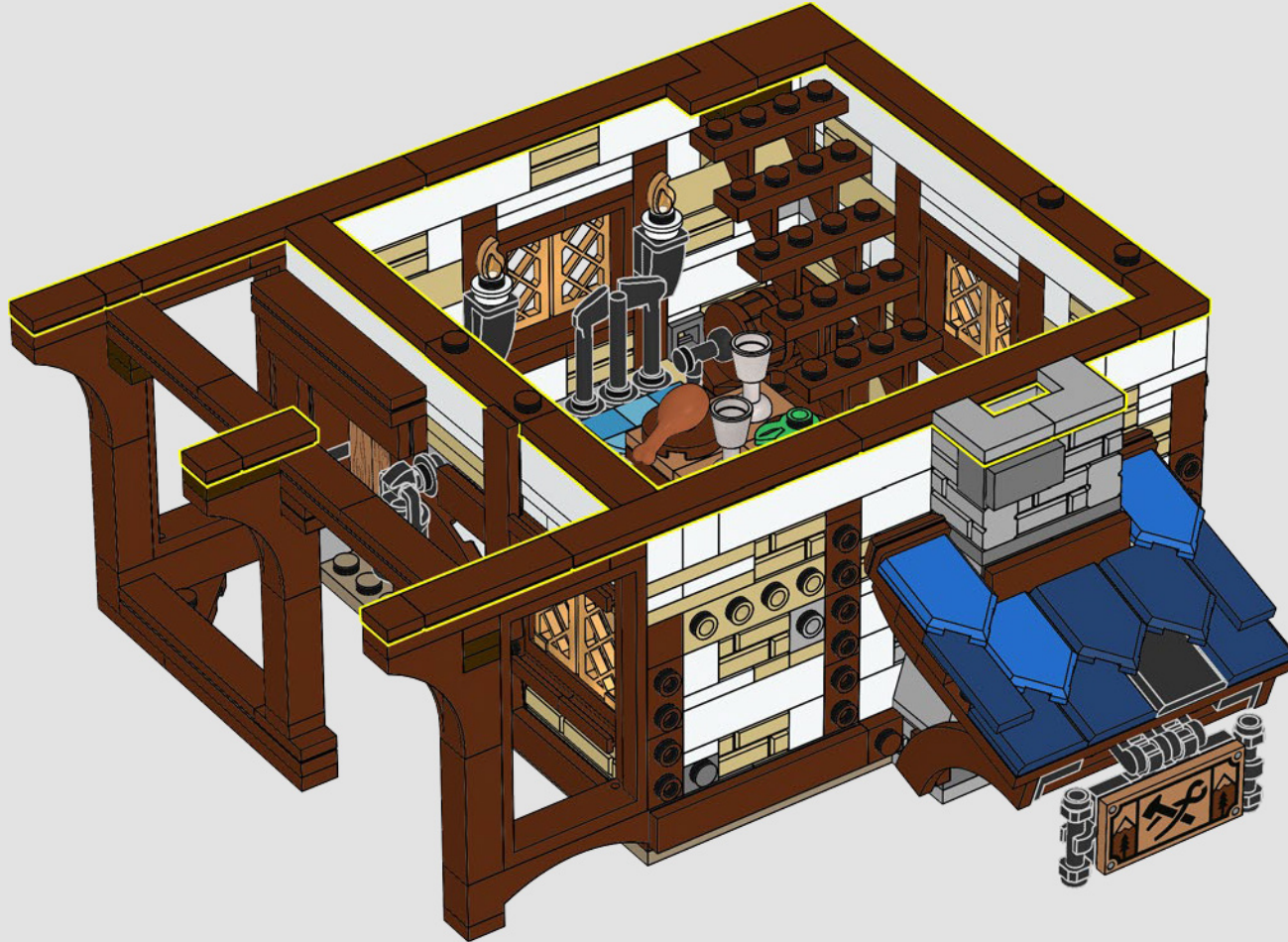

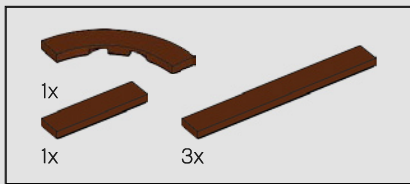

146

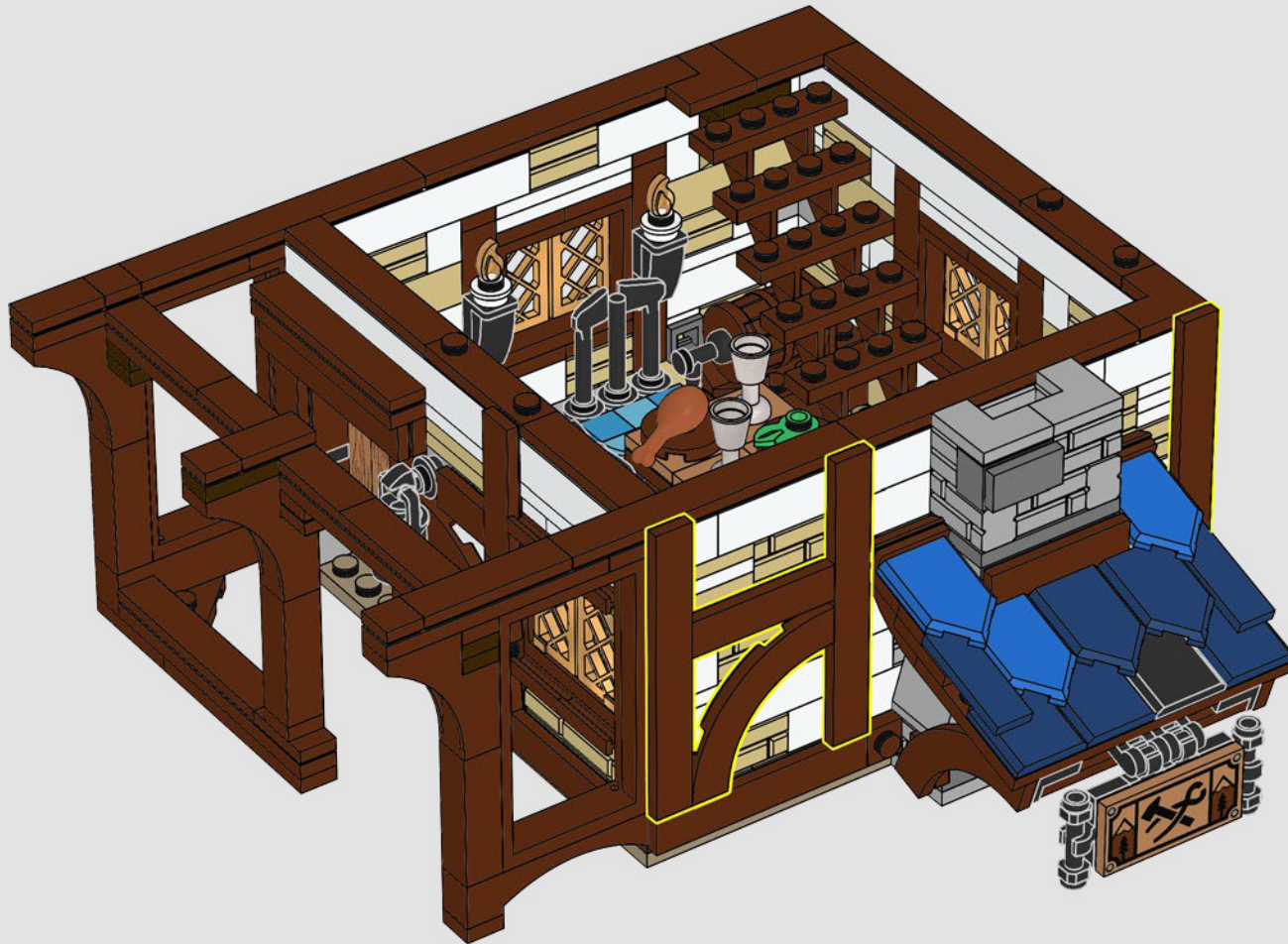

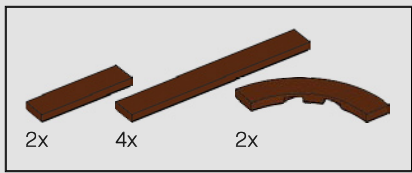

147

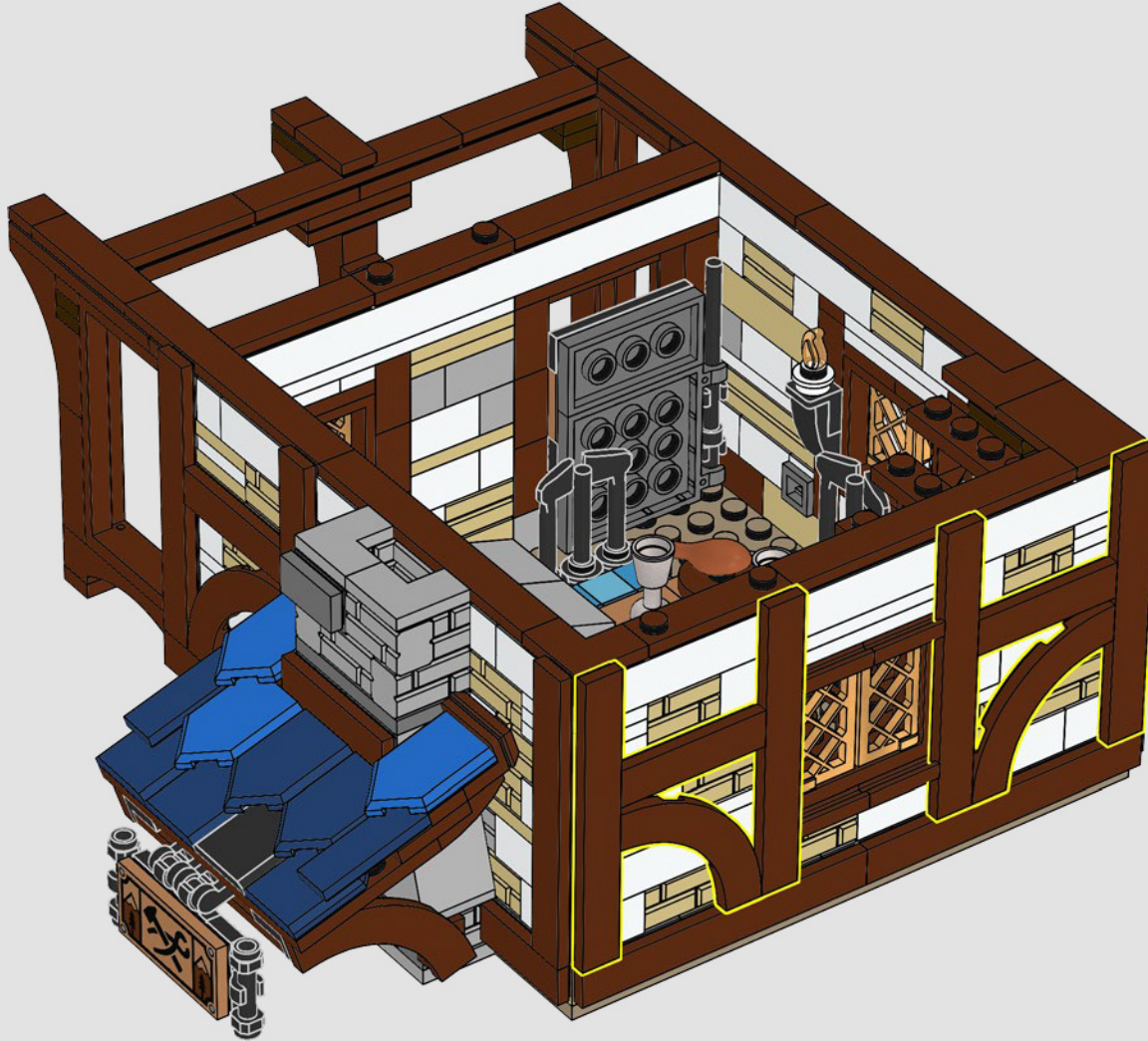

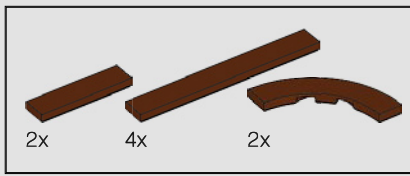

148

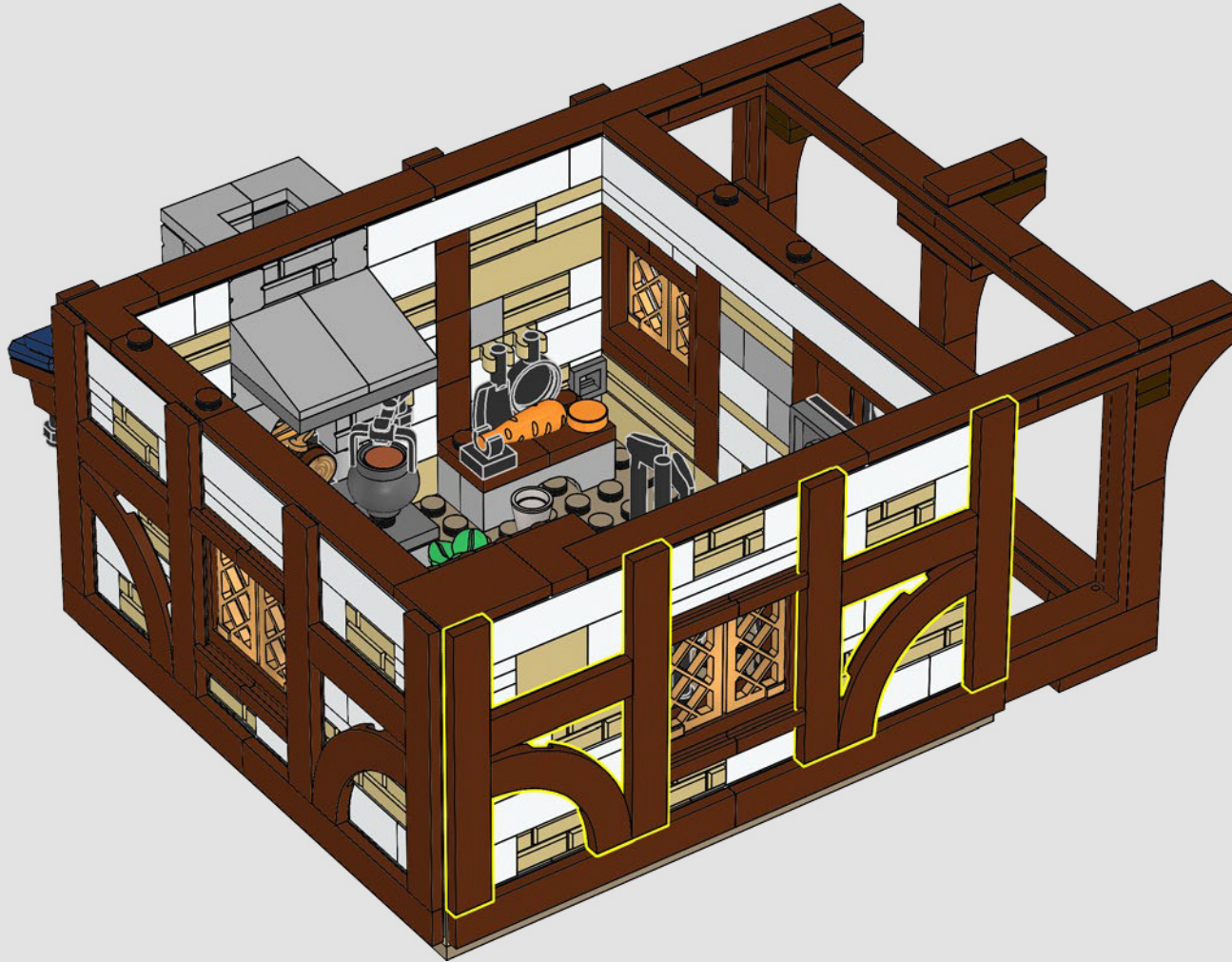



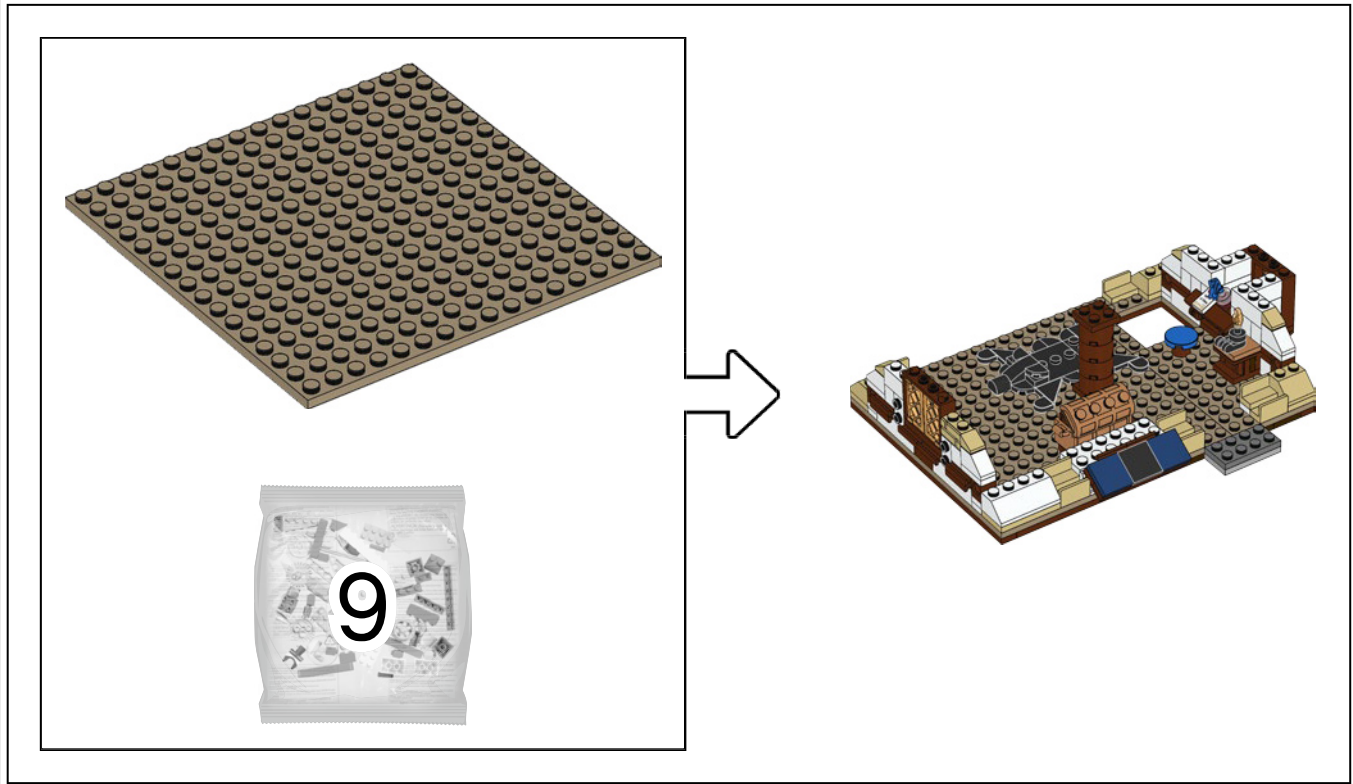

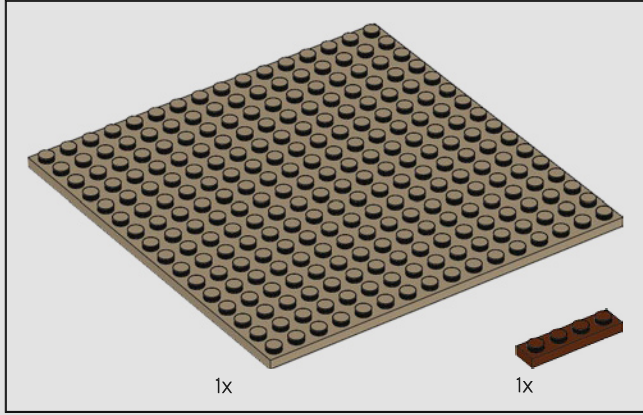
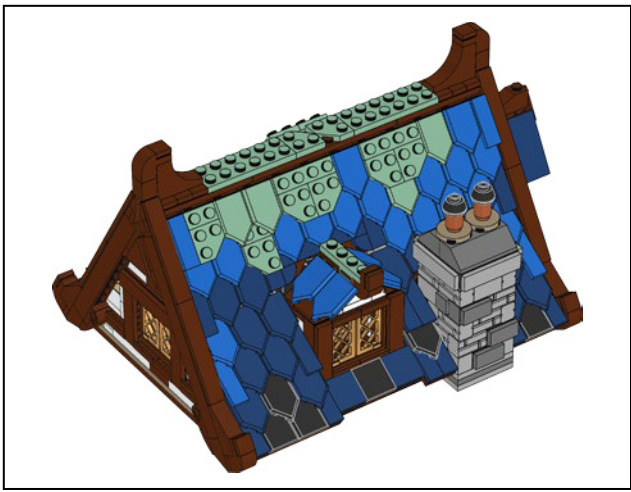

150



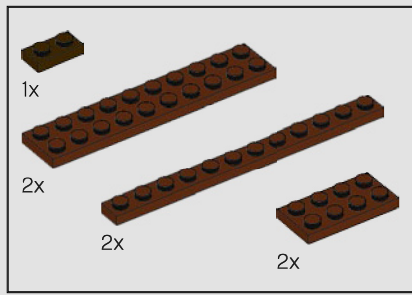

151

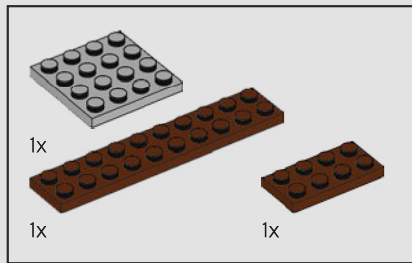
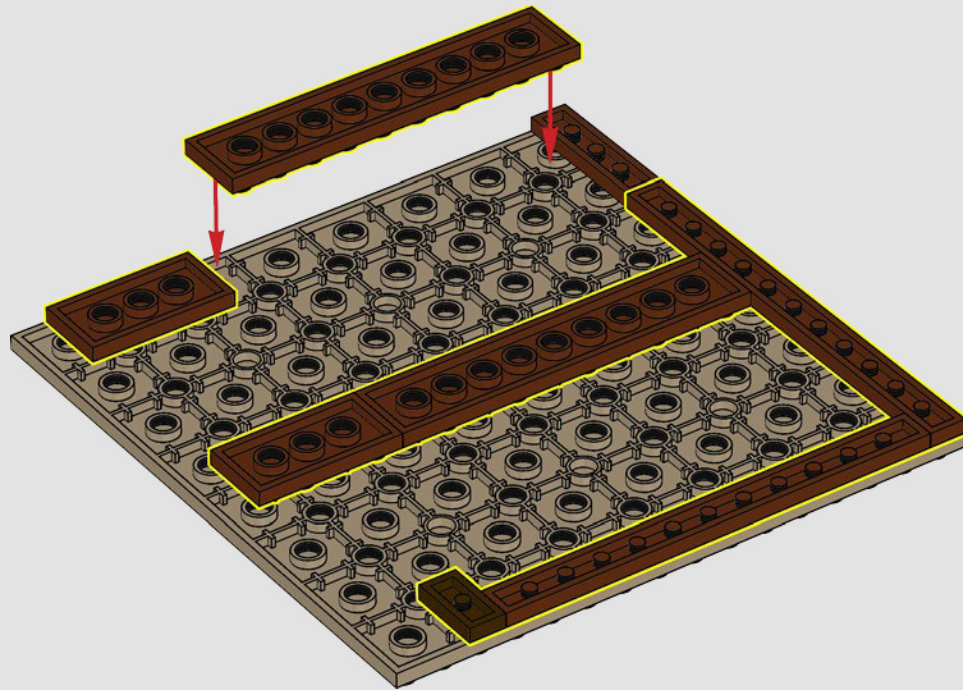

152



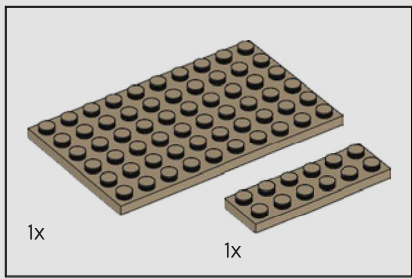

153

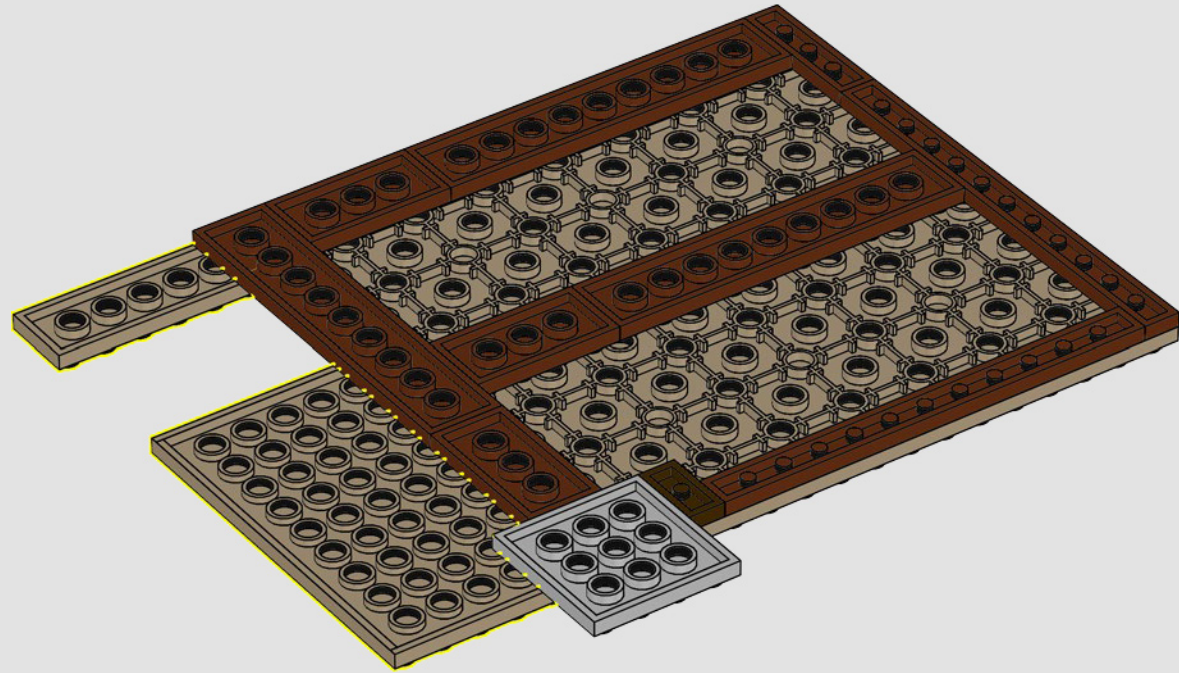

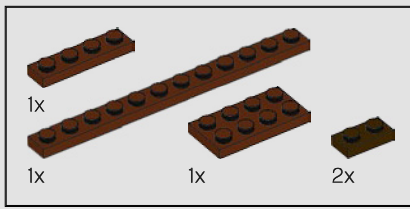

154

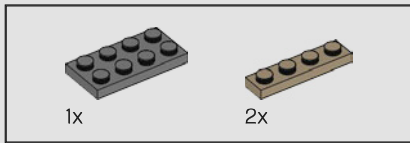
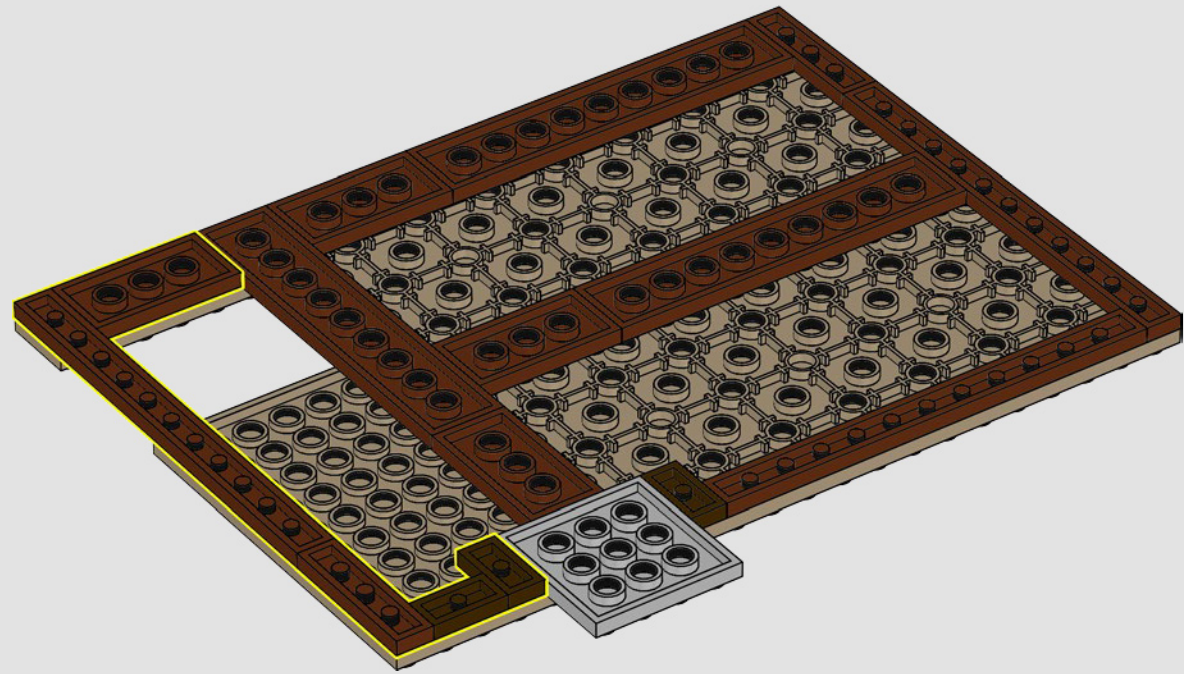

155

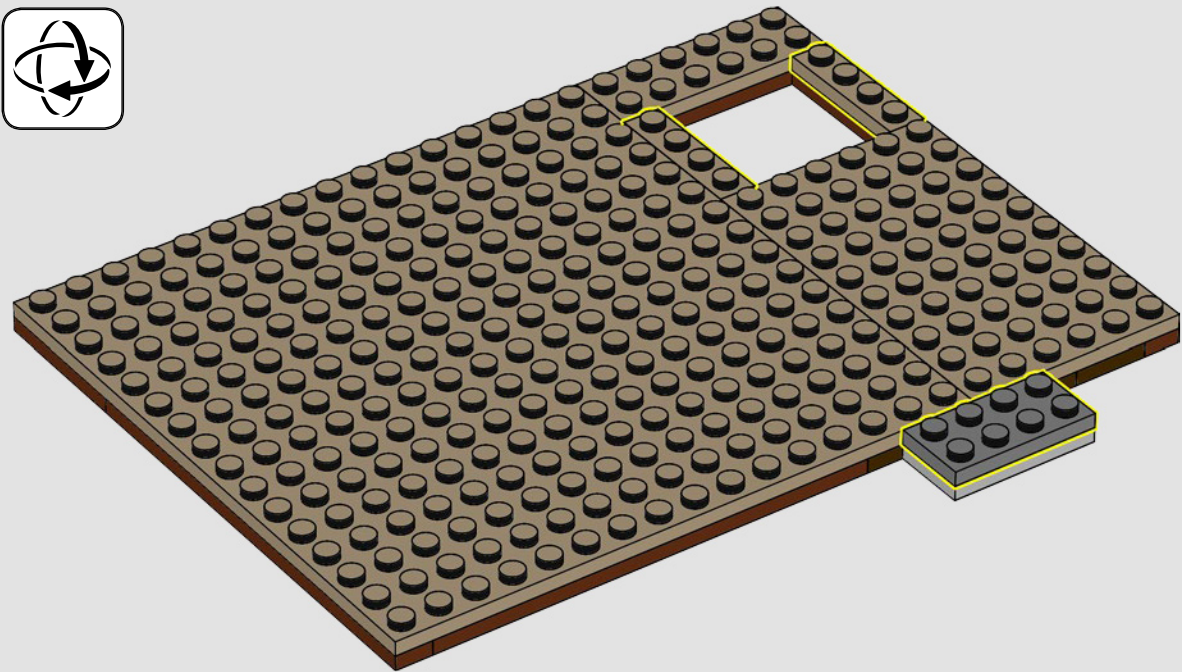

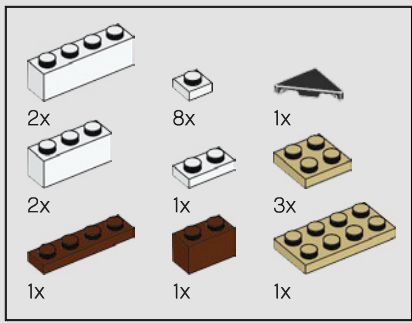

156

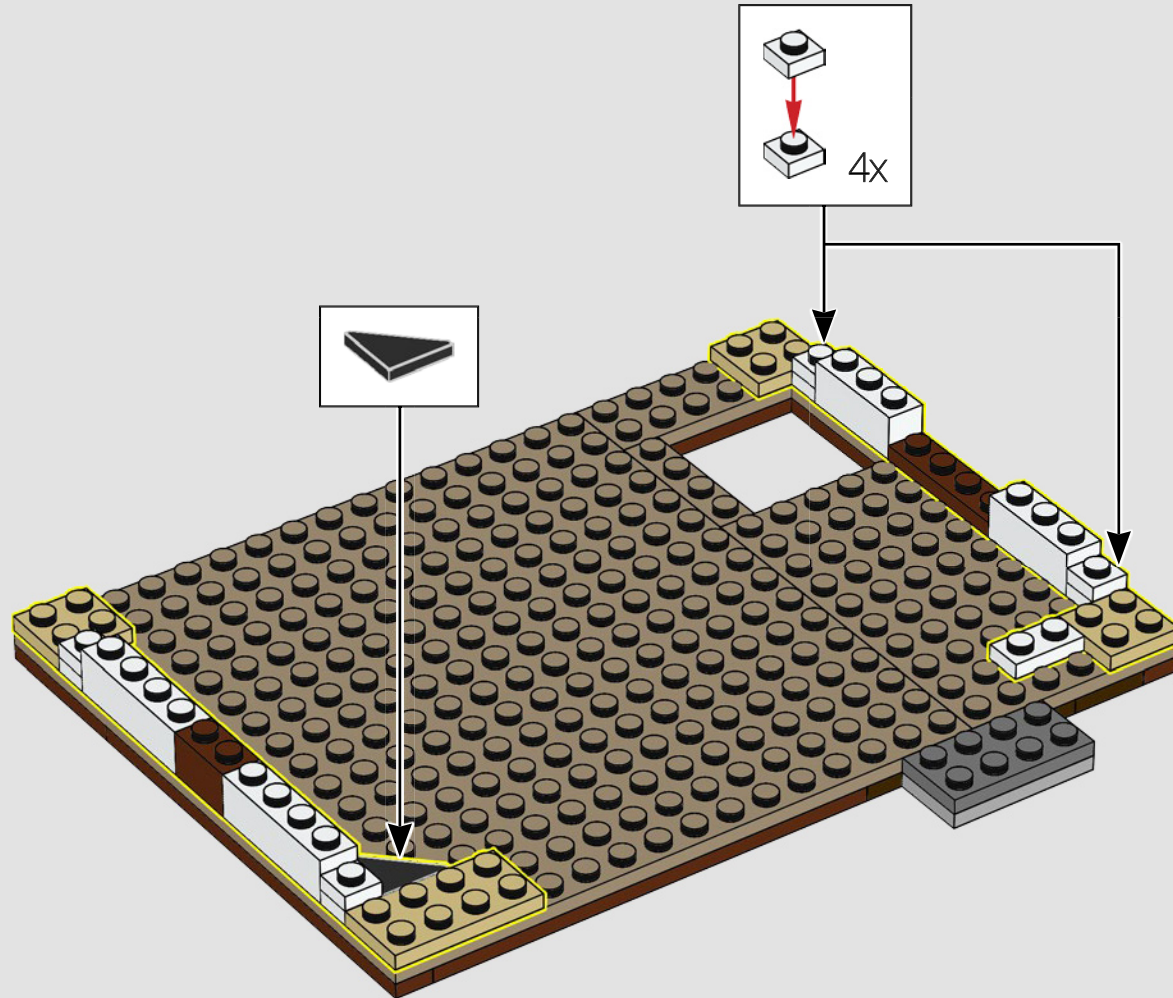

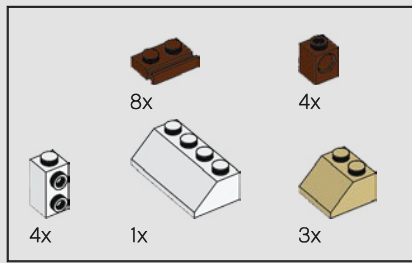

157

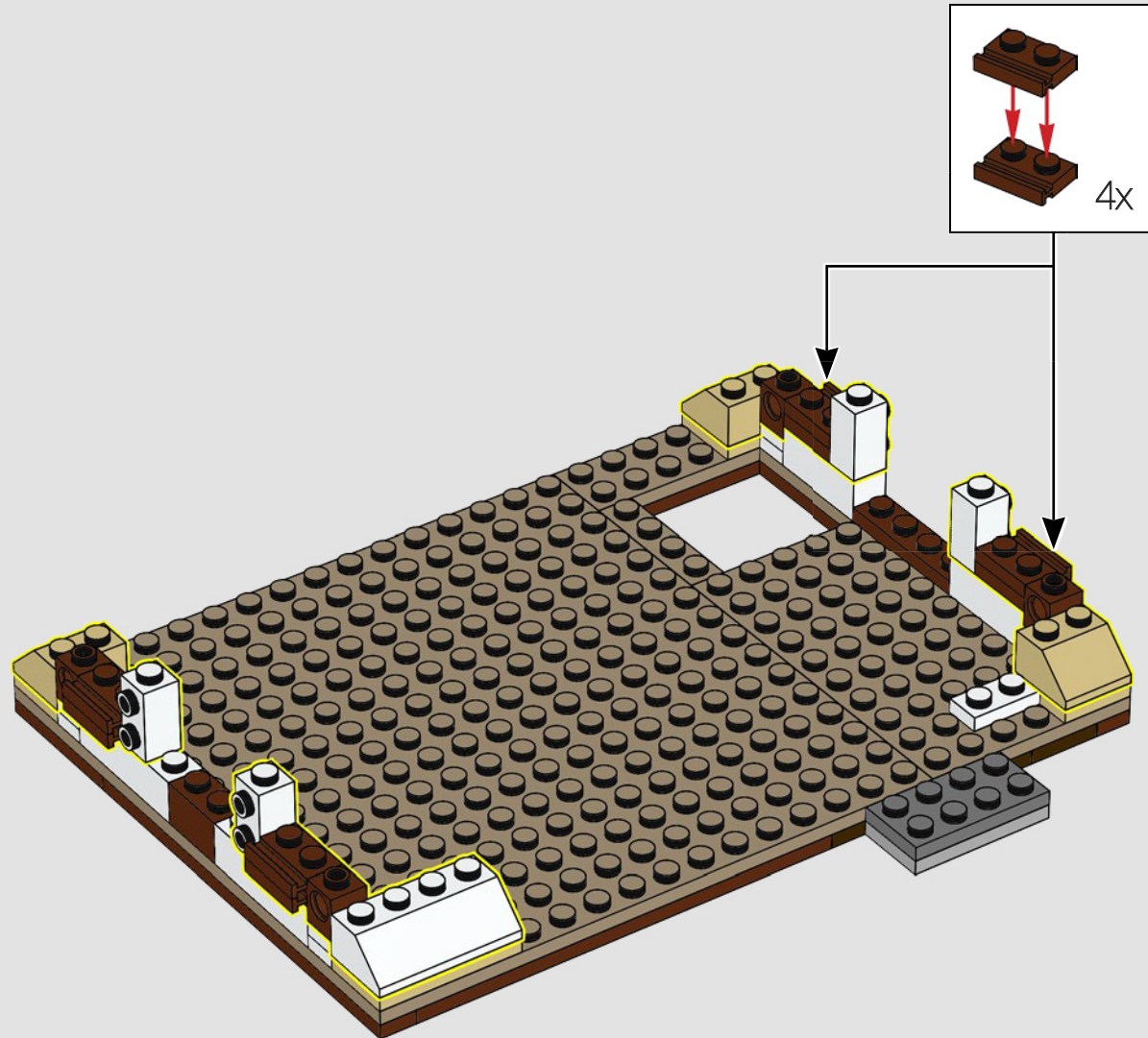

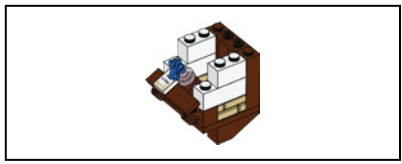

158

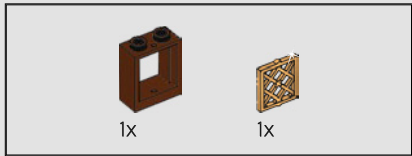
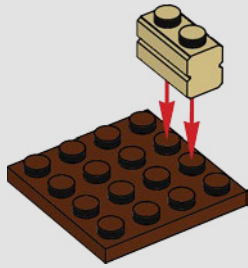

159

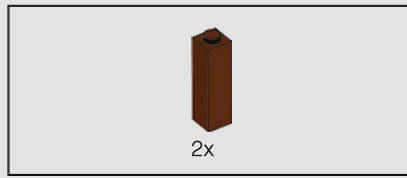
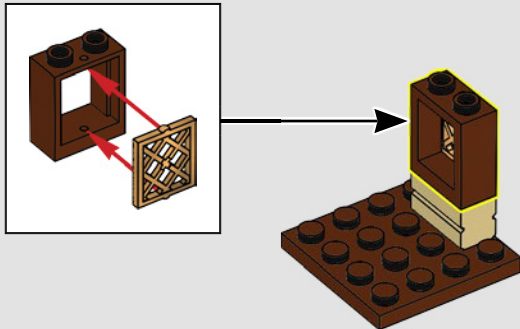

160

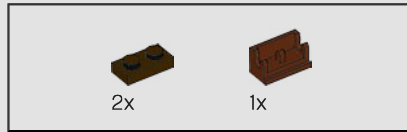
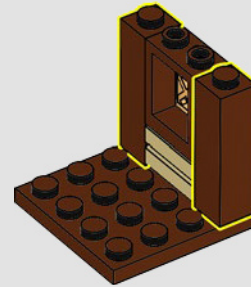

161

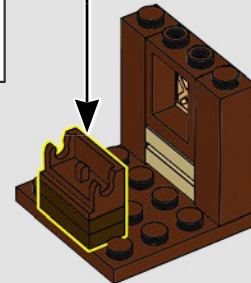
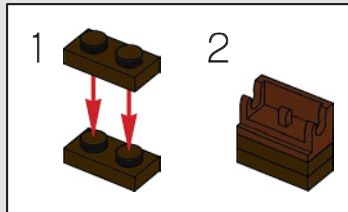

162

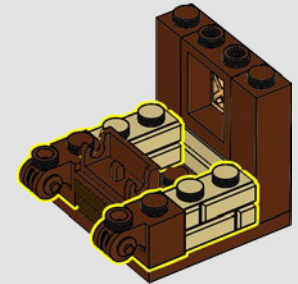

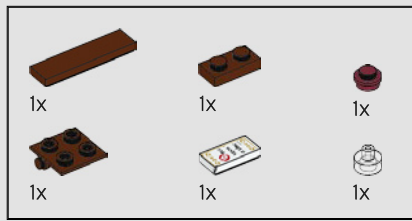

163

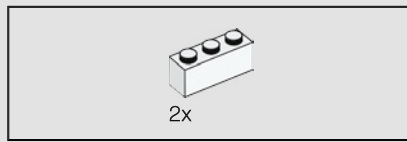
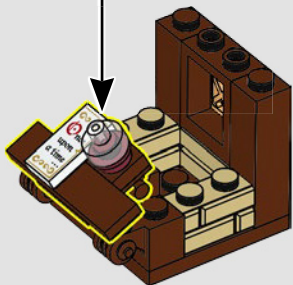
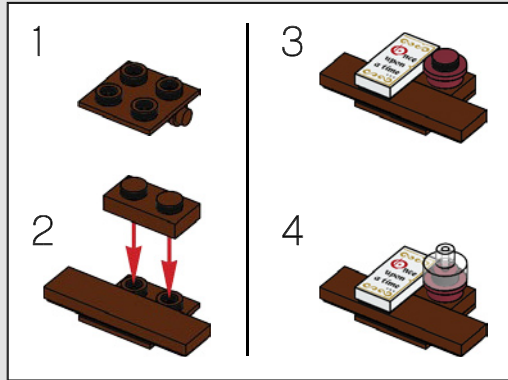

164

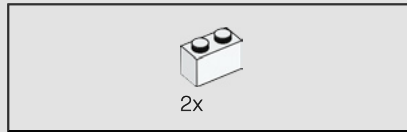
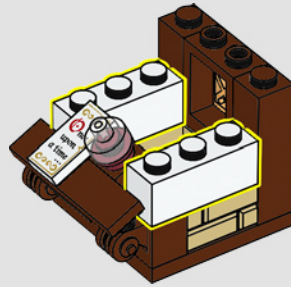

165

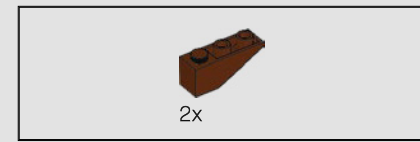
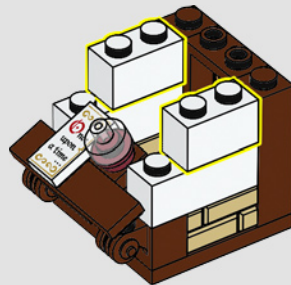

166

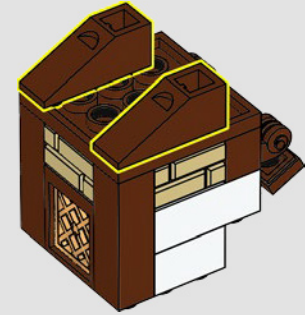
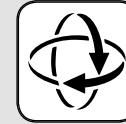

167

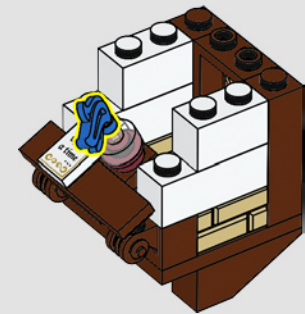
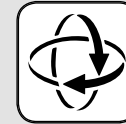

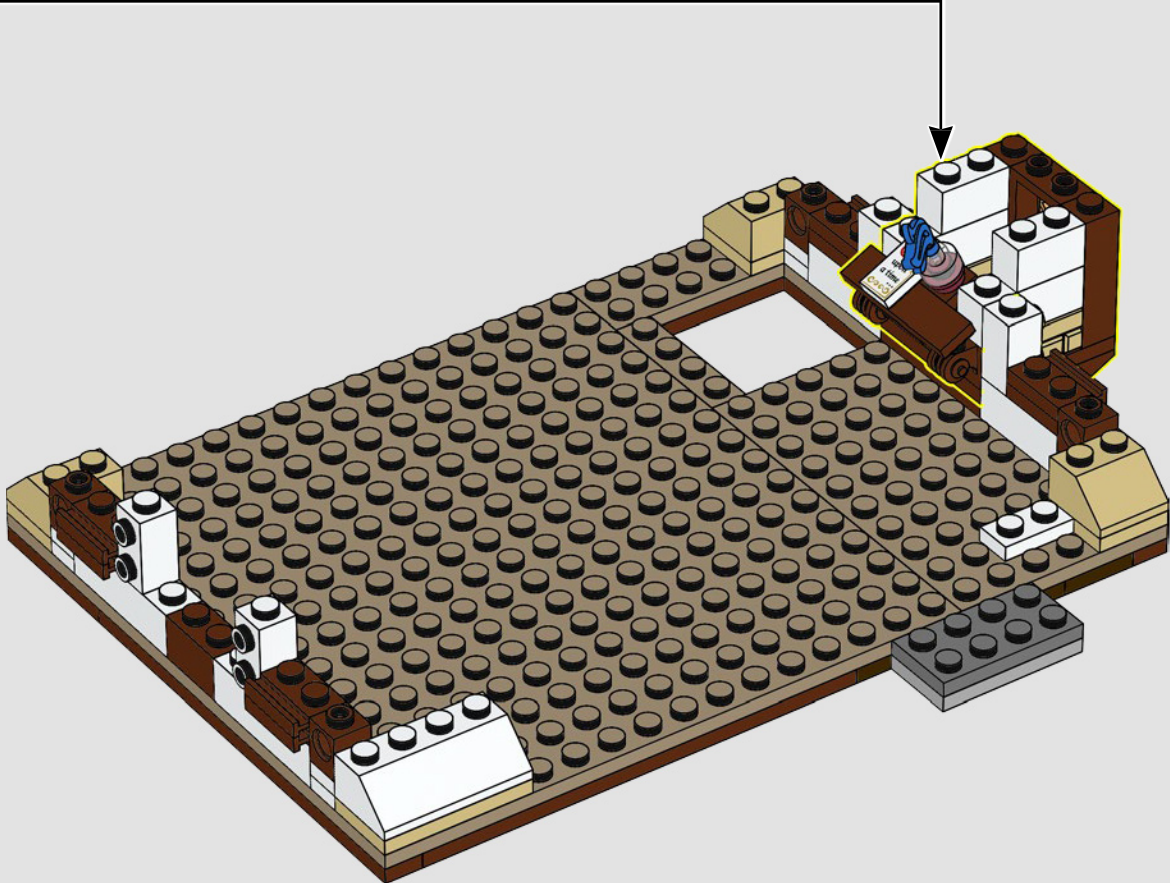

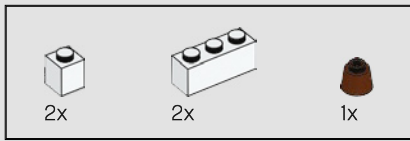

169

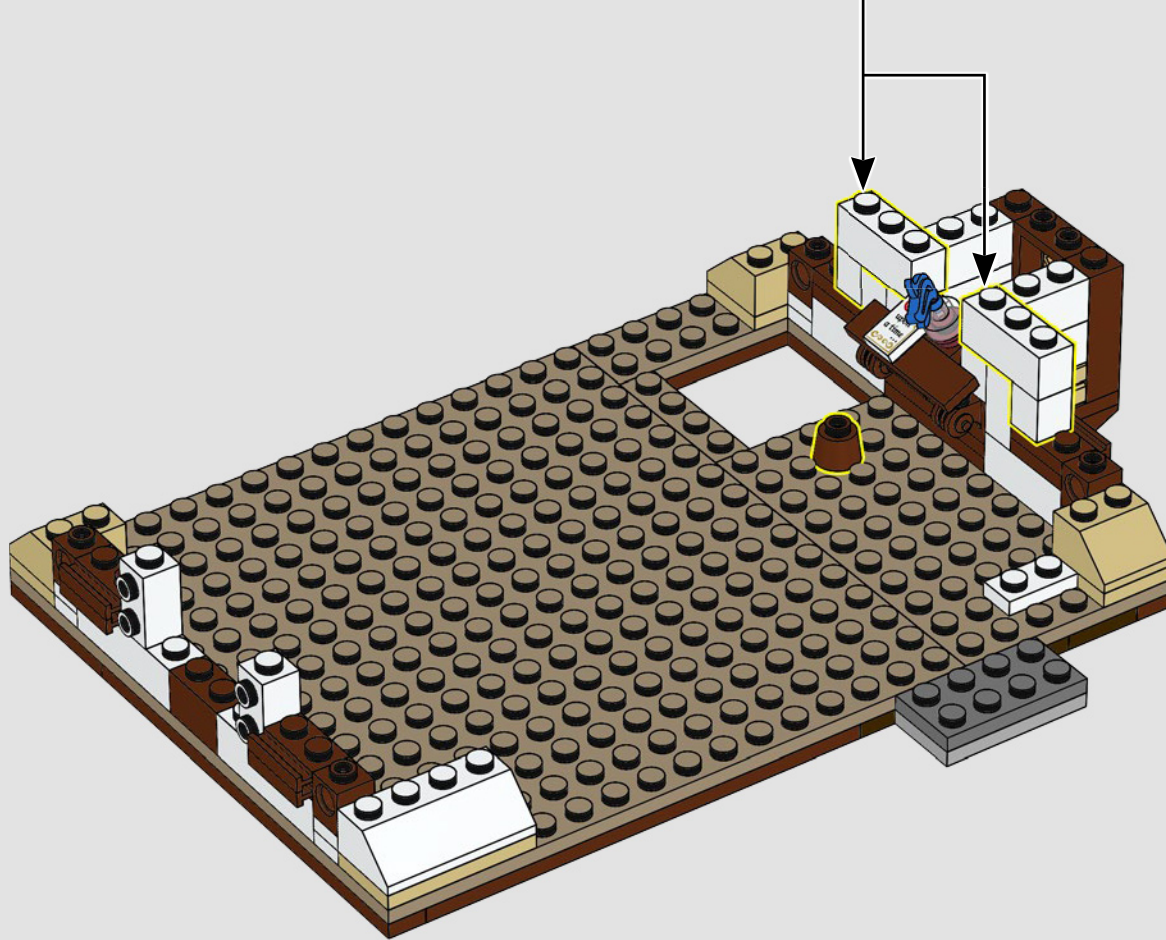
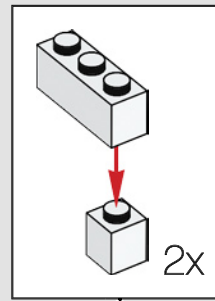

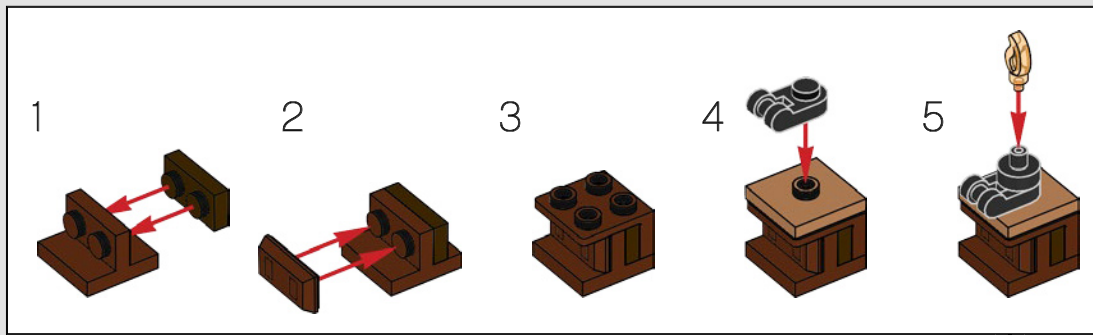
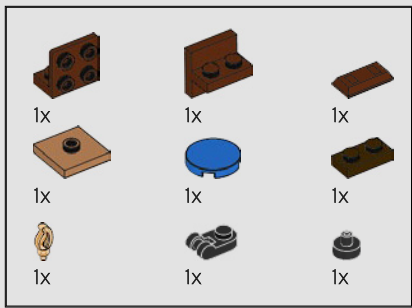

170

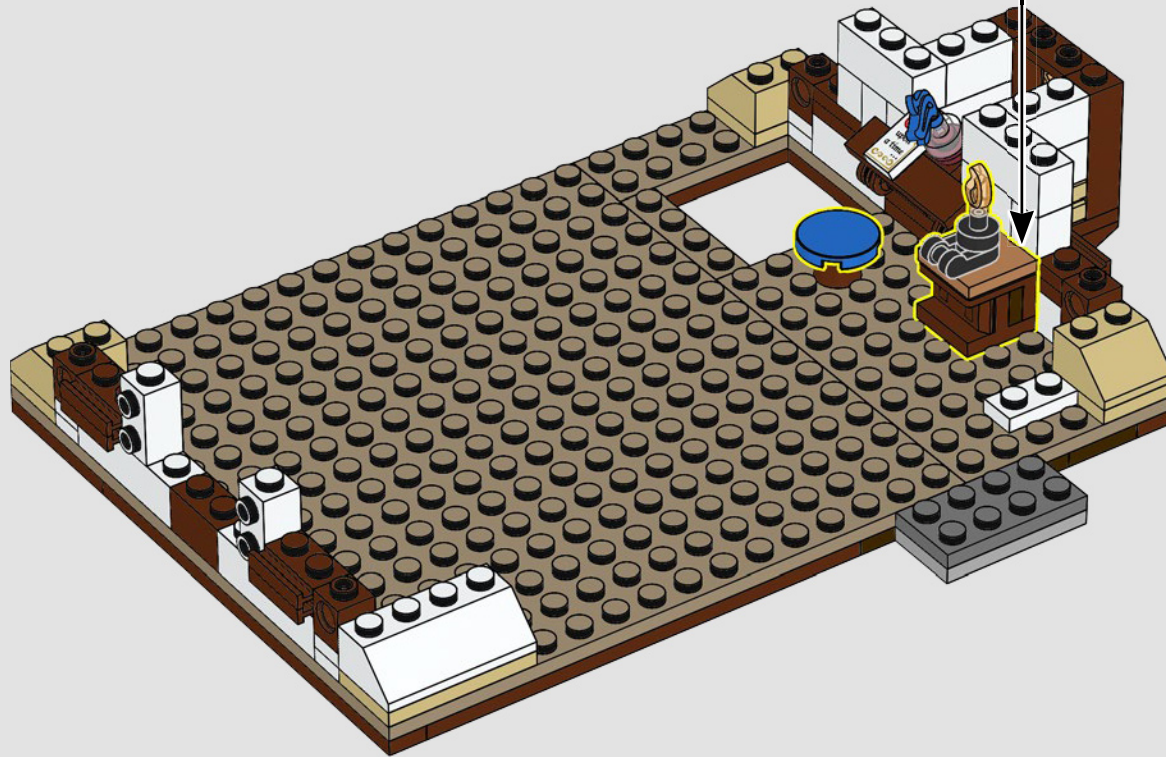

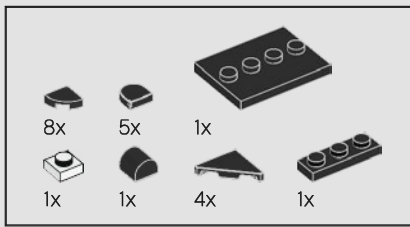

171

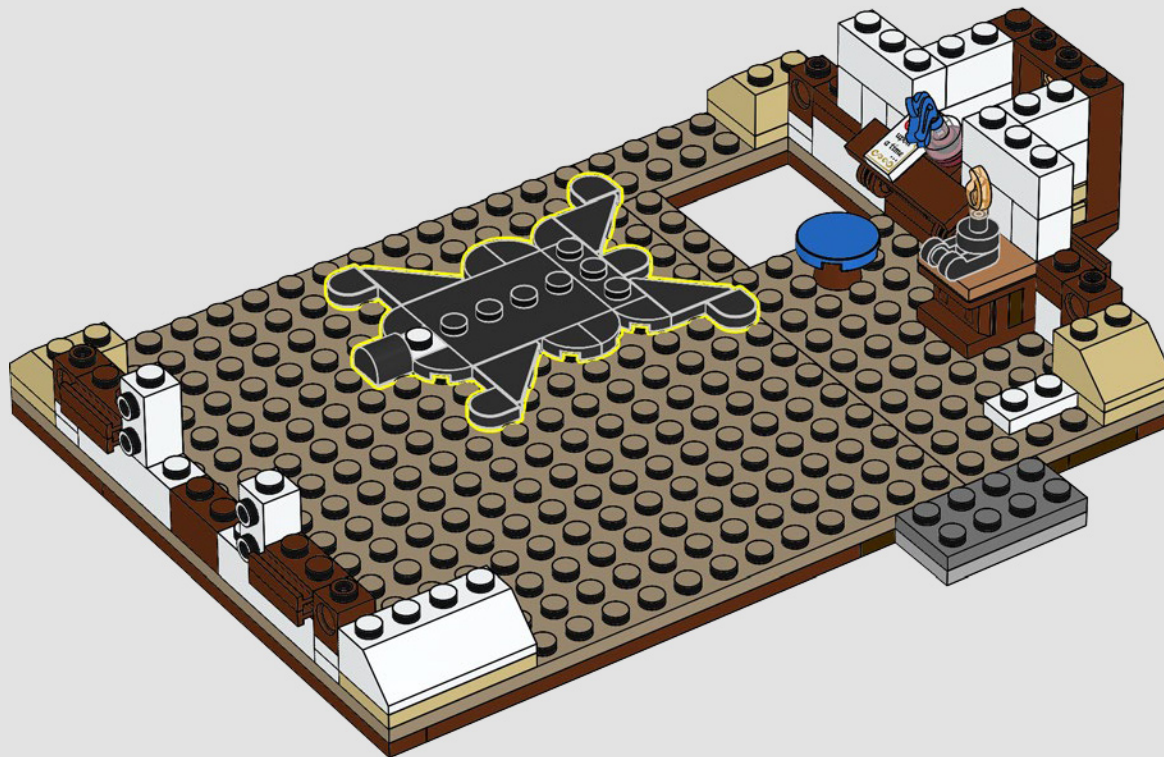

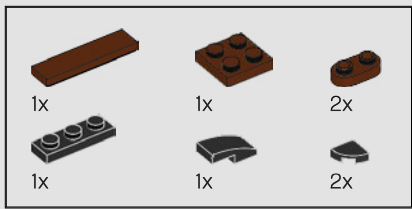

172

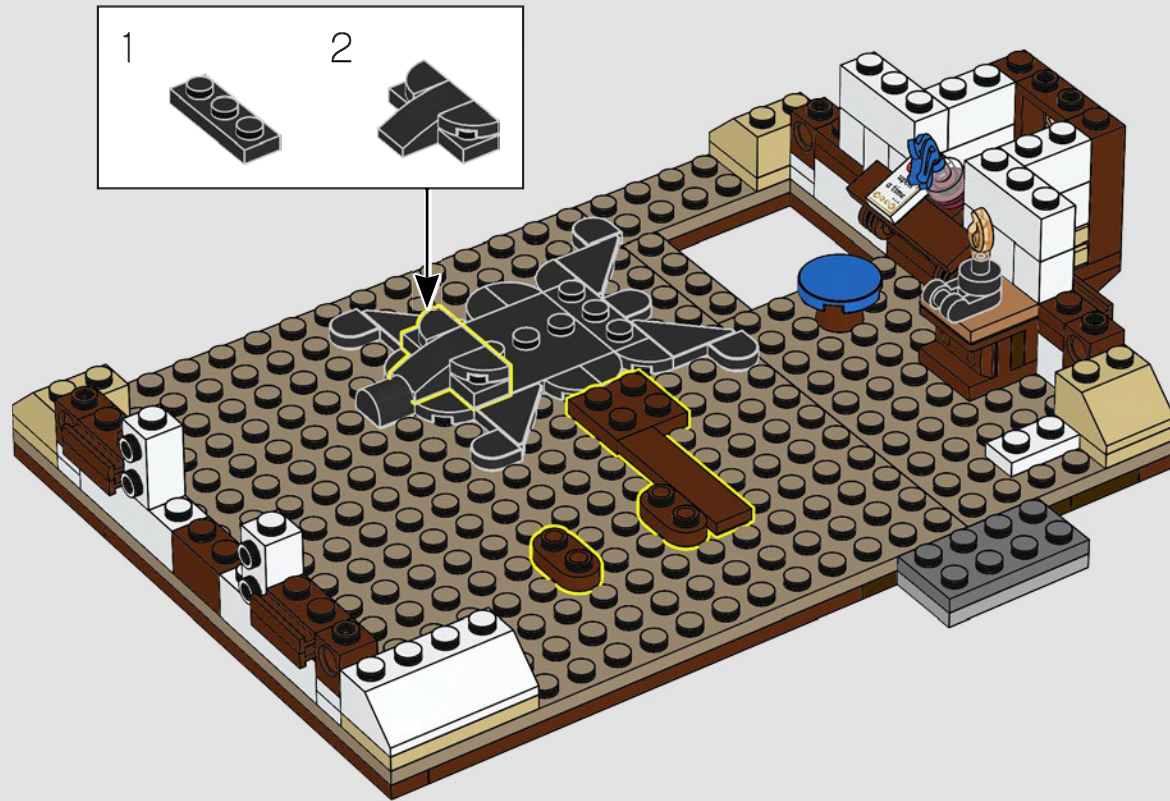

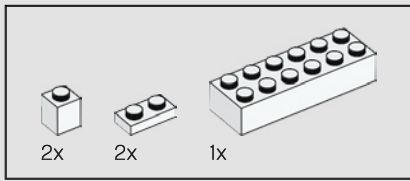

173

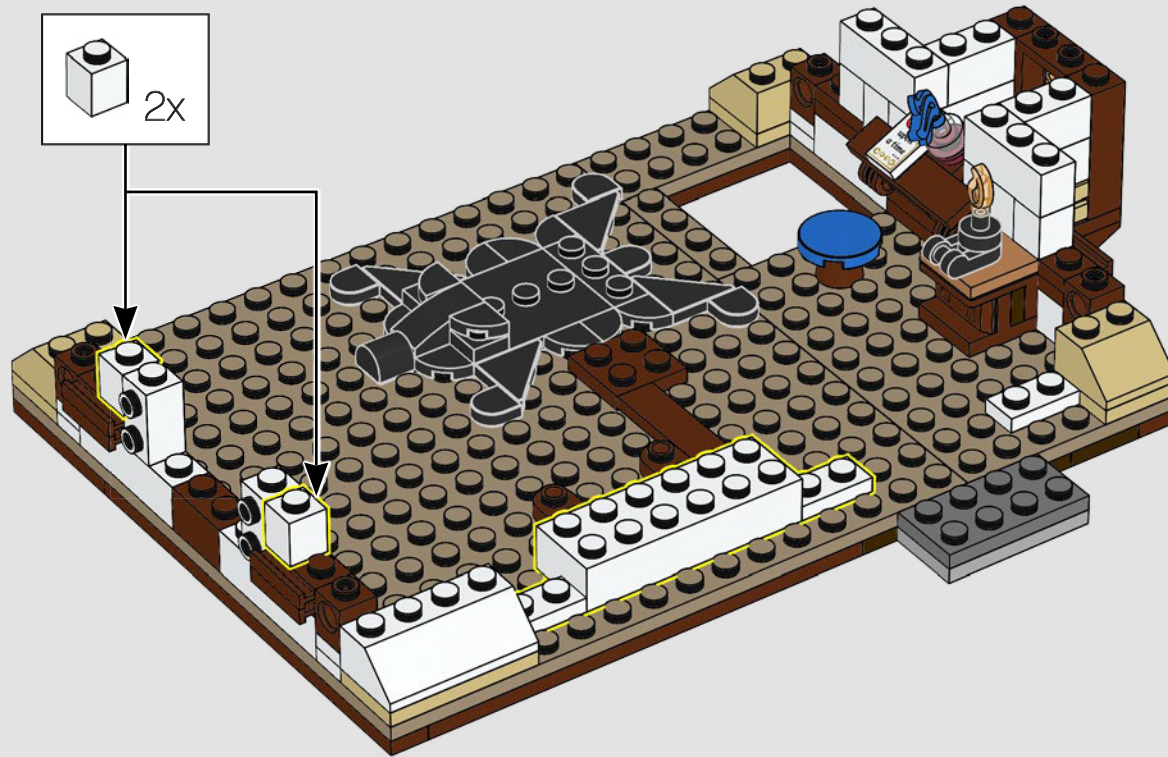

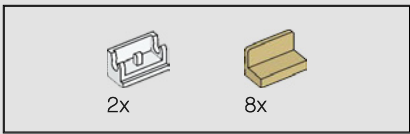

174

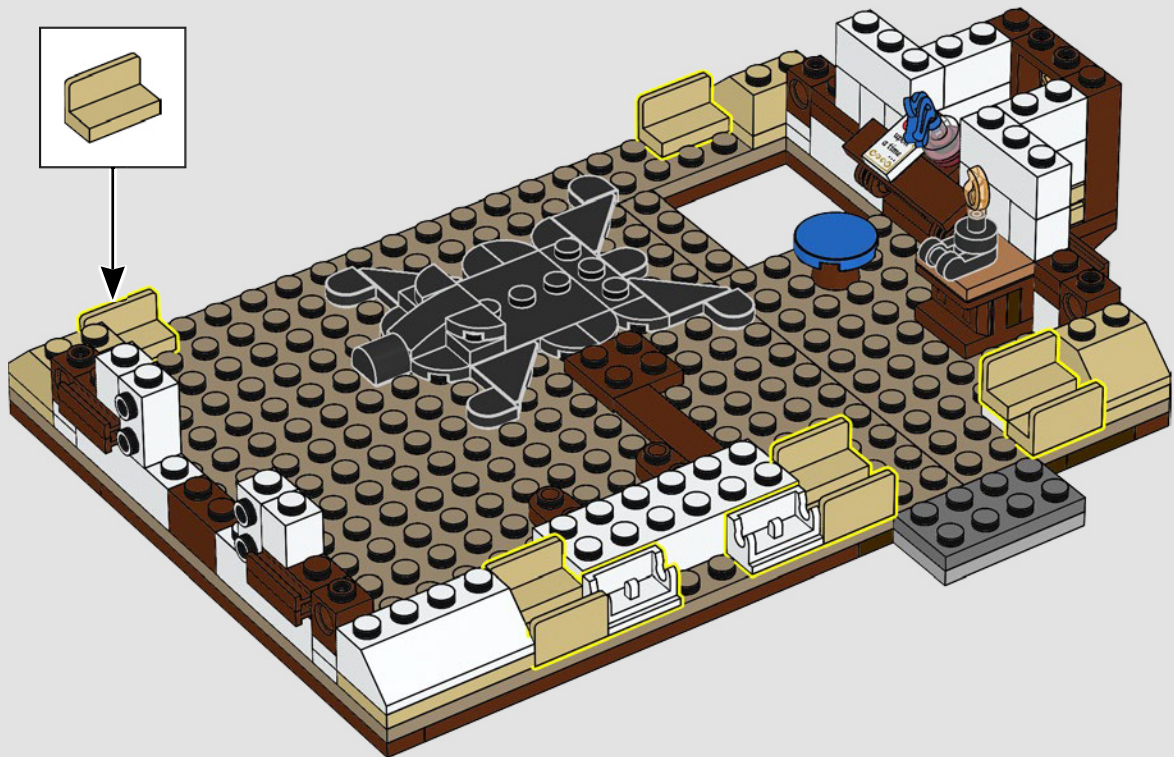

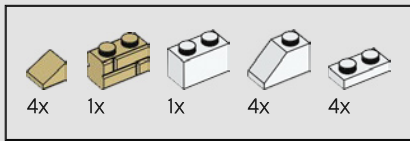

175

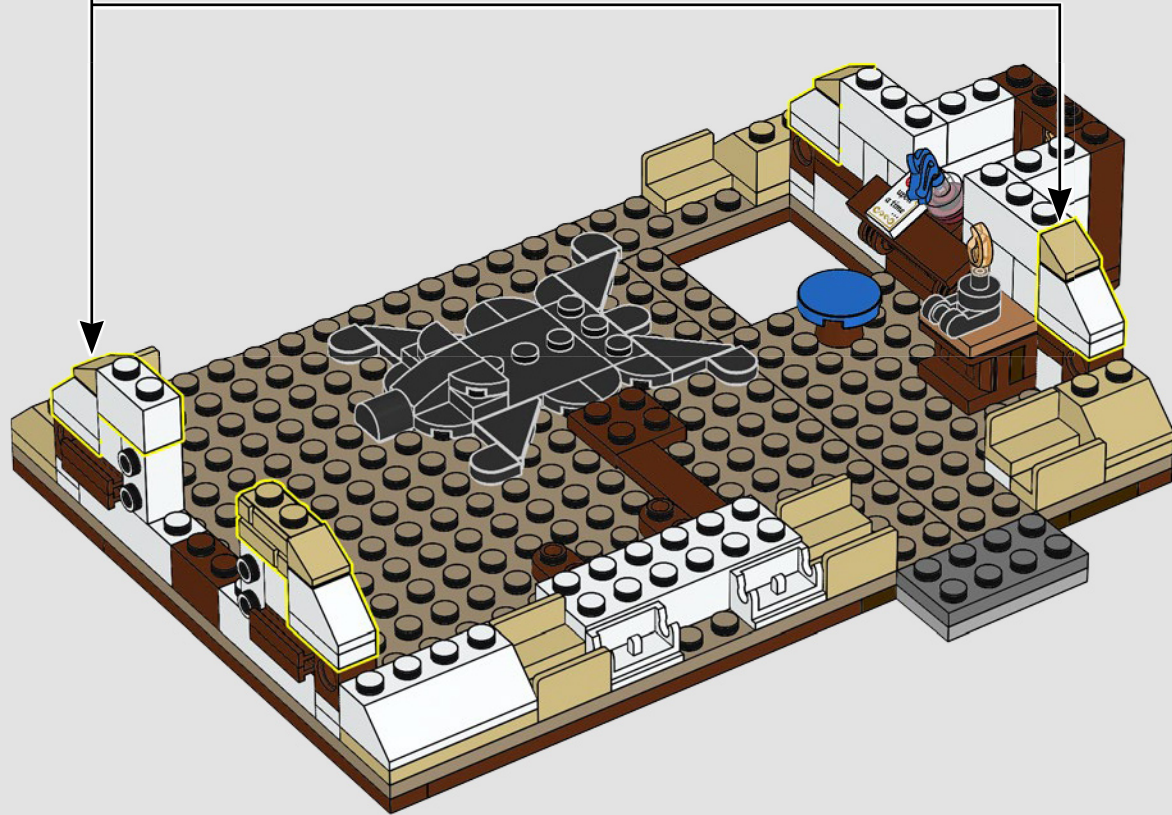
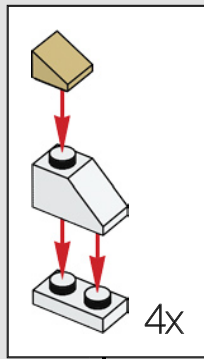

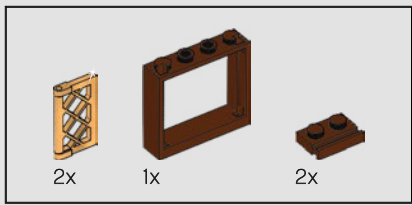

176

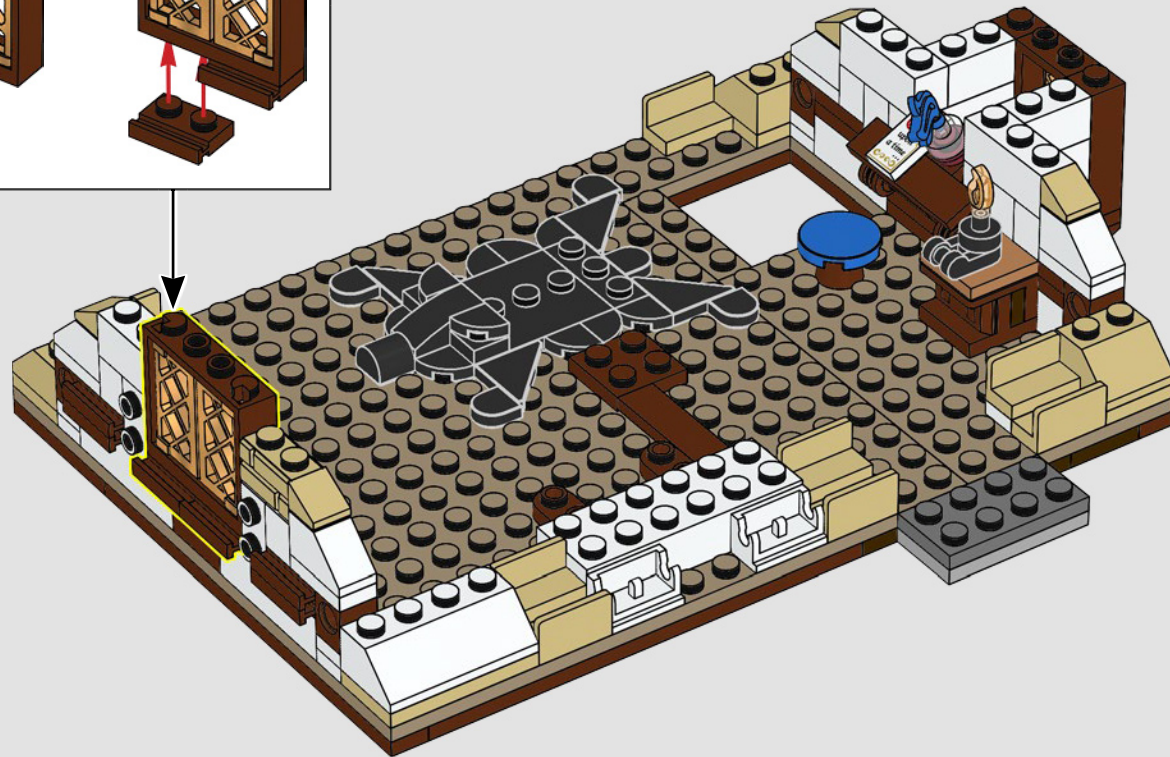
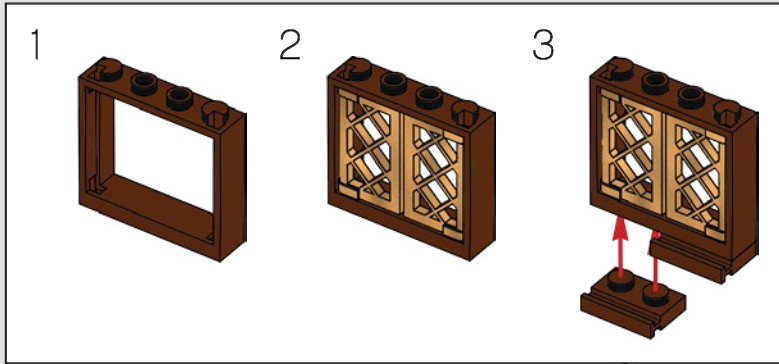

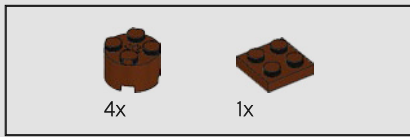

177

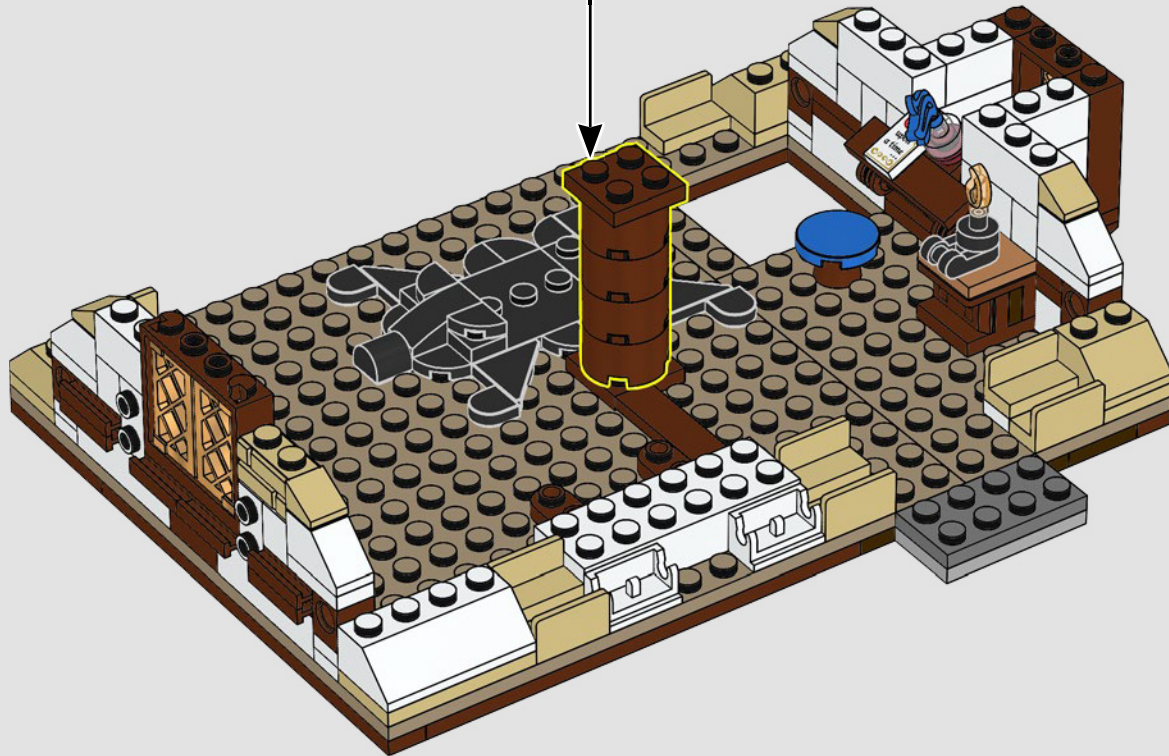
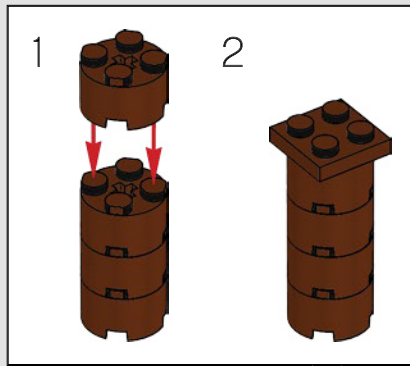

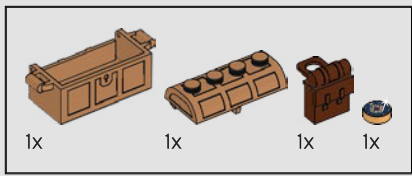

178

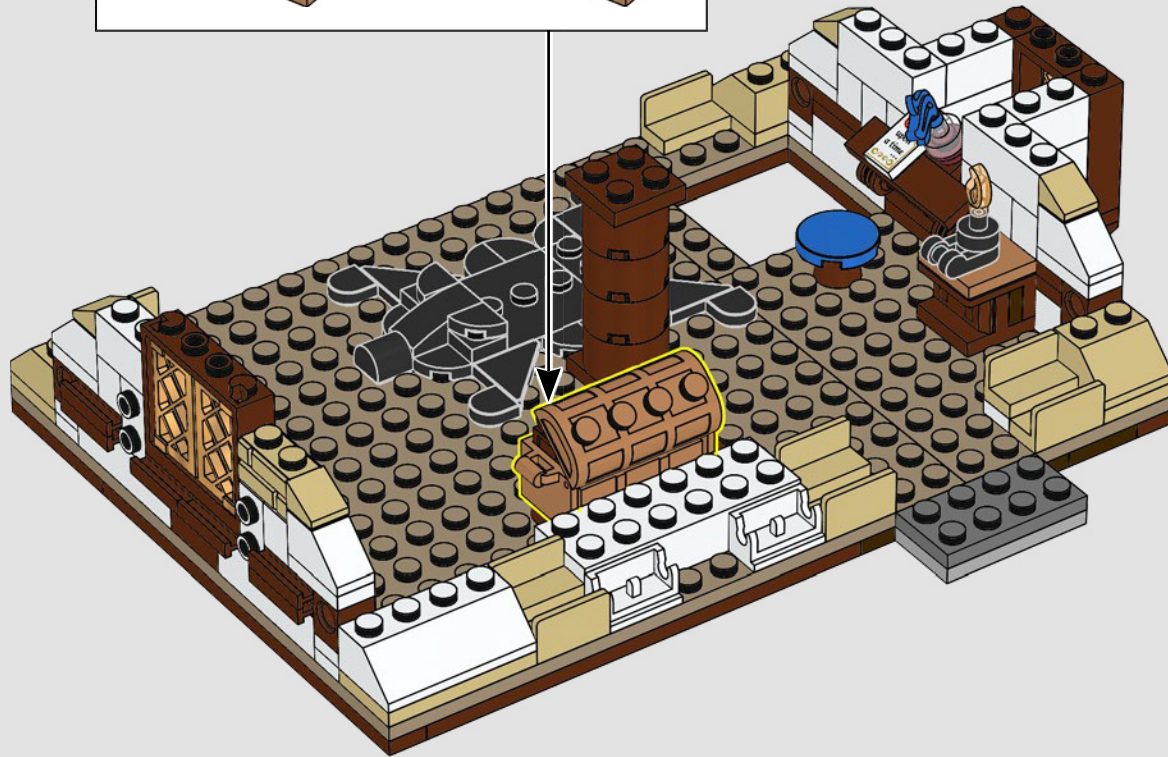
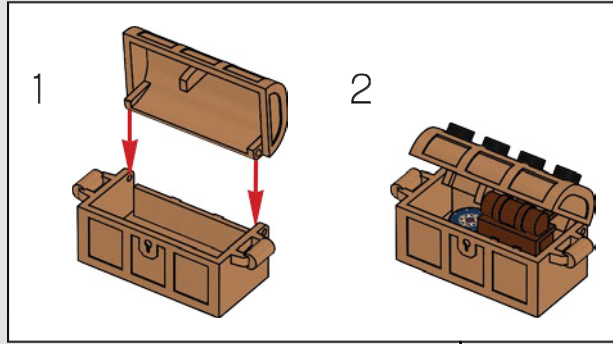

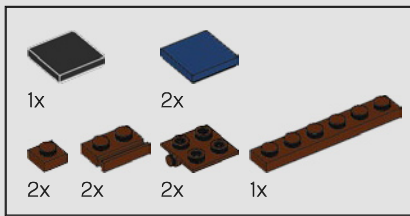

179

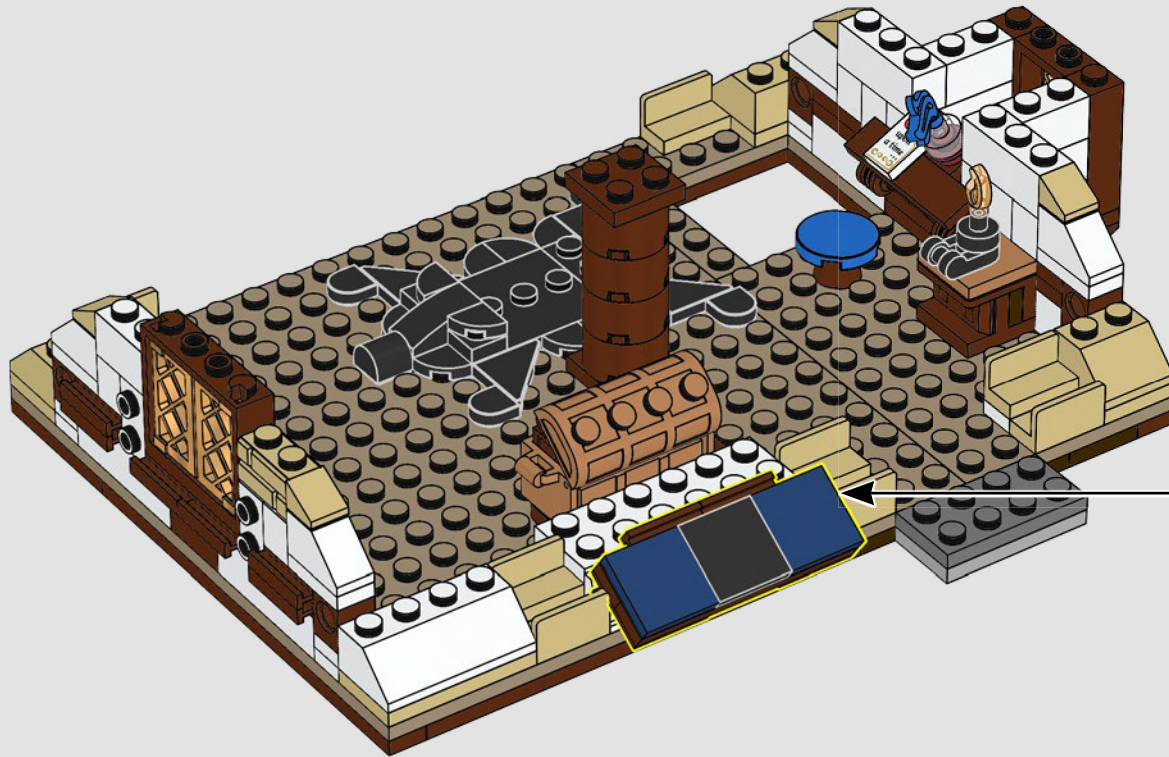
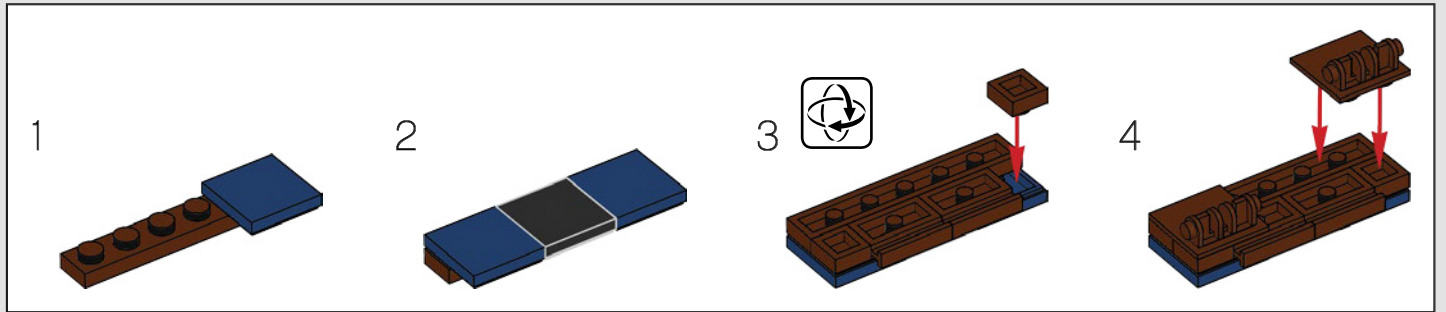



10

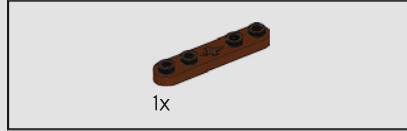
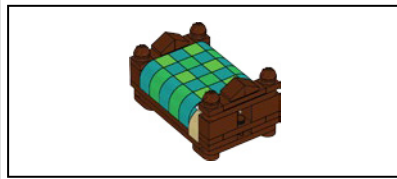
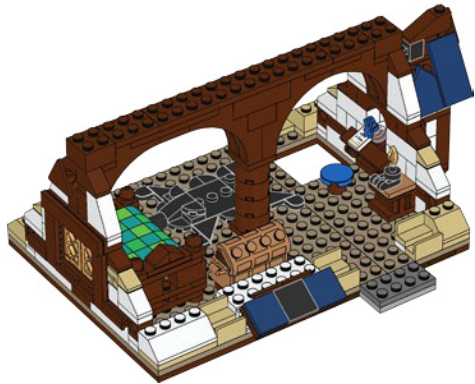
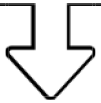

1x

180



2x

181

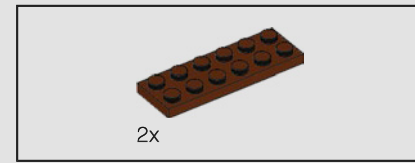
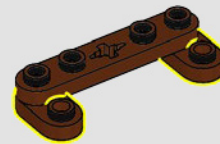

2x

182

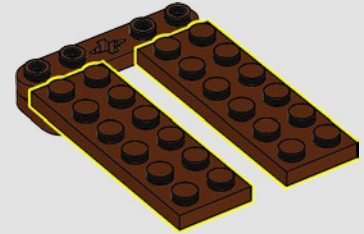

2x

183

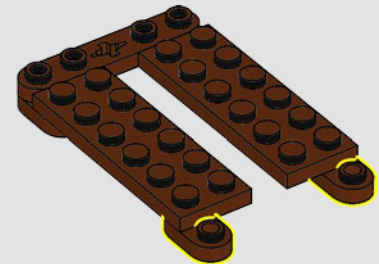

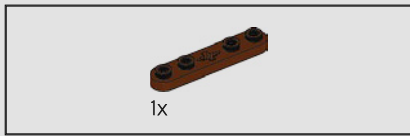

184

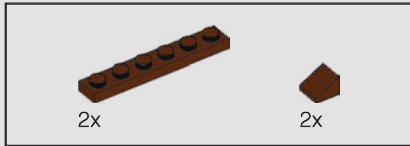
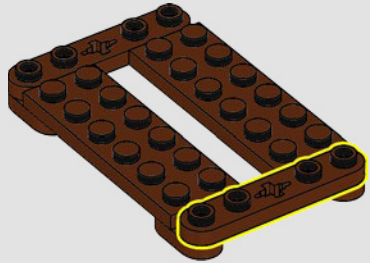

185

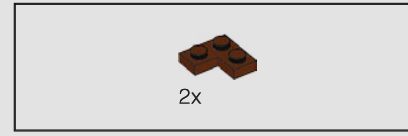
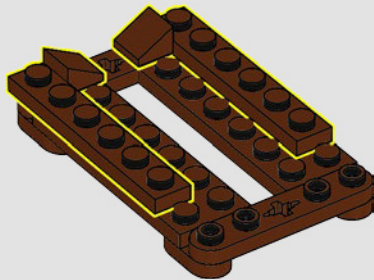

186

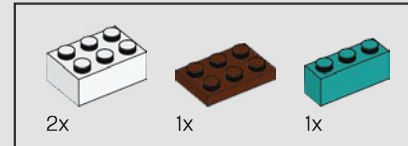
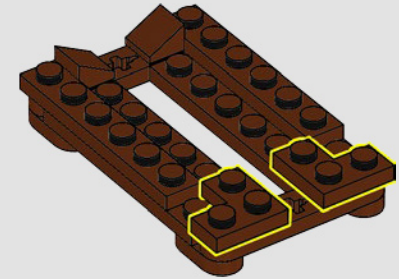

187

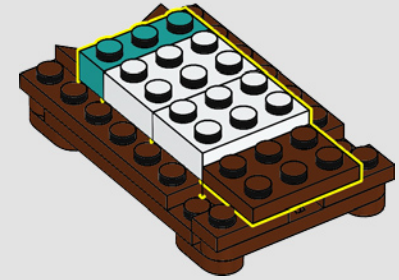

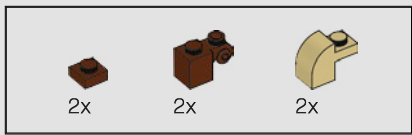

188

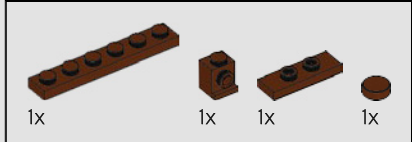
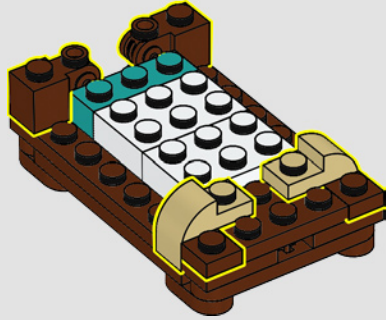

189

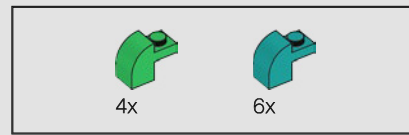
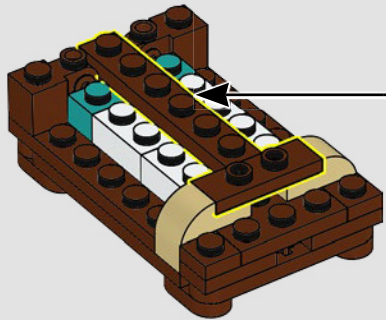
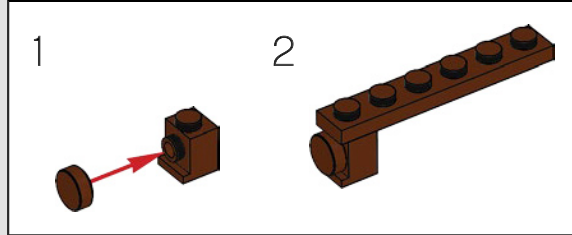

190

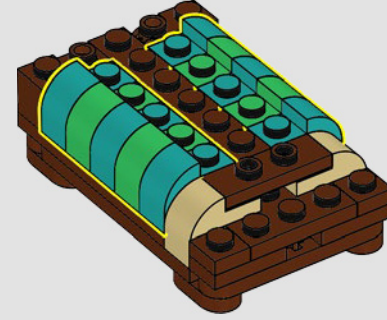

191

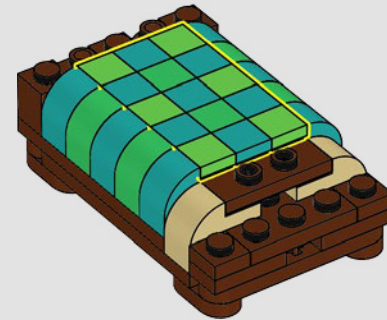

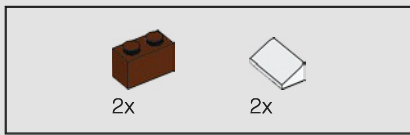

192

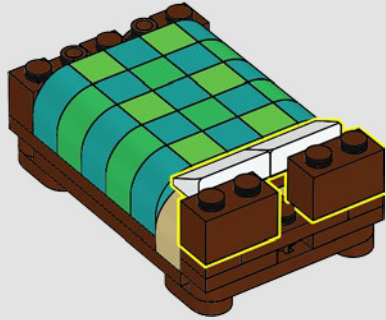

193

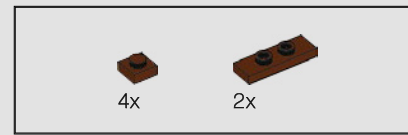
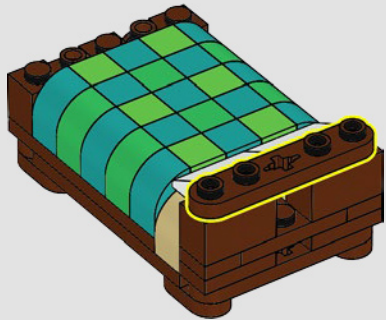

194

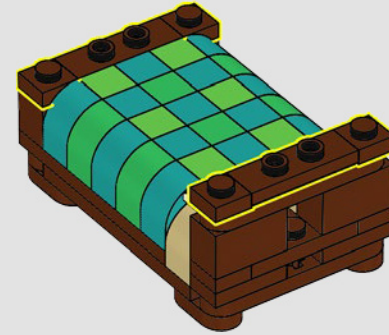

195

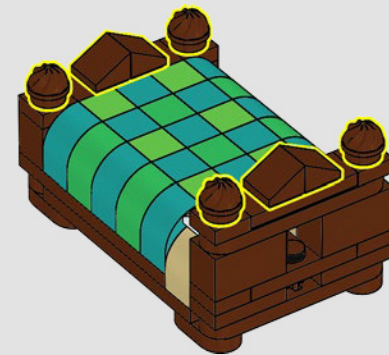

196

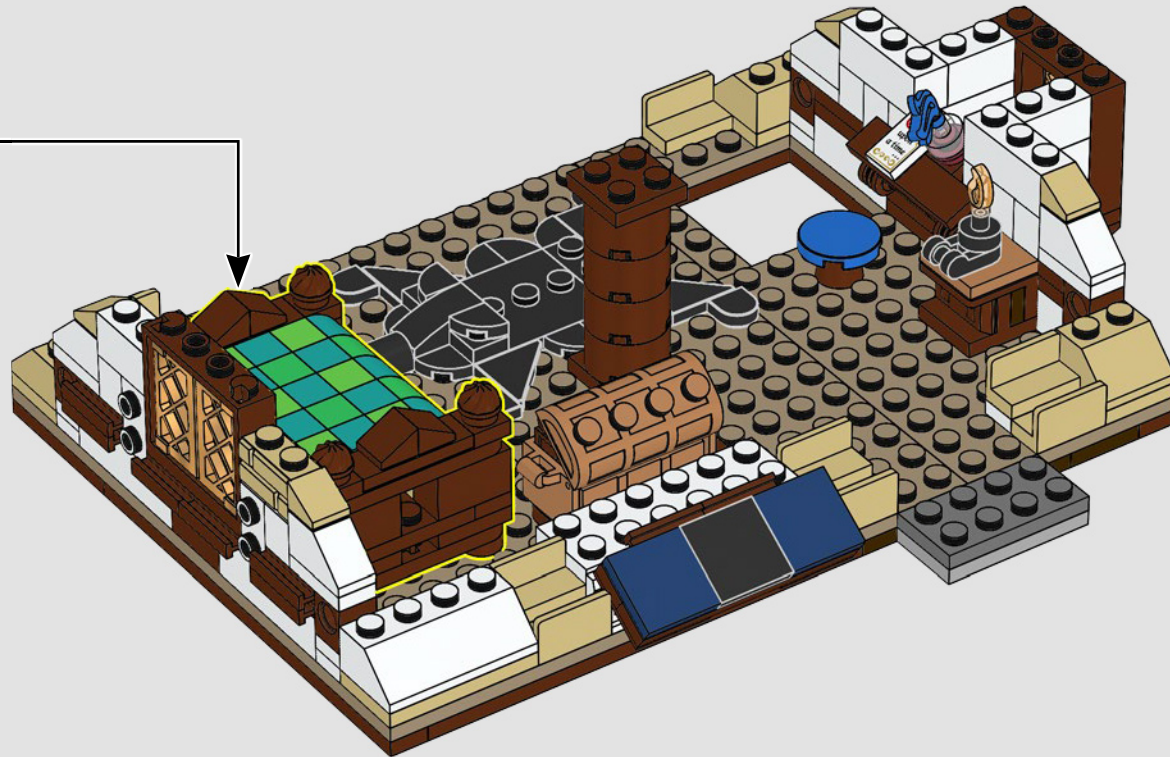

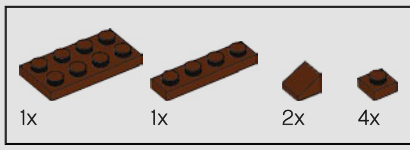

197

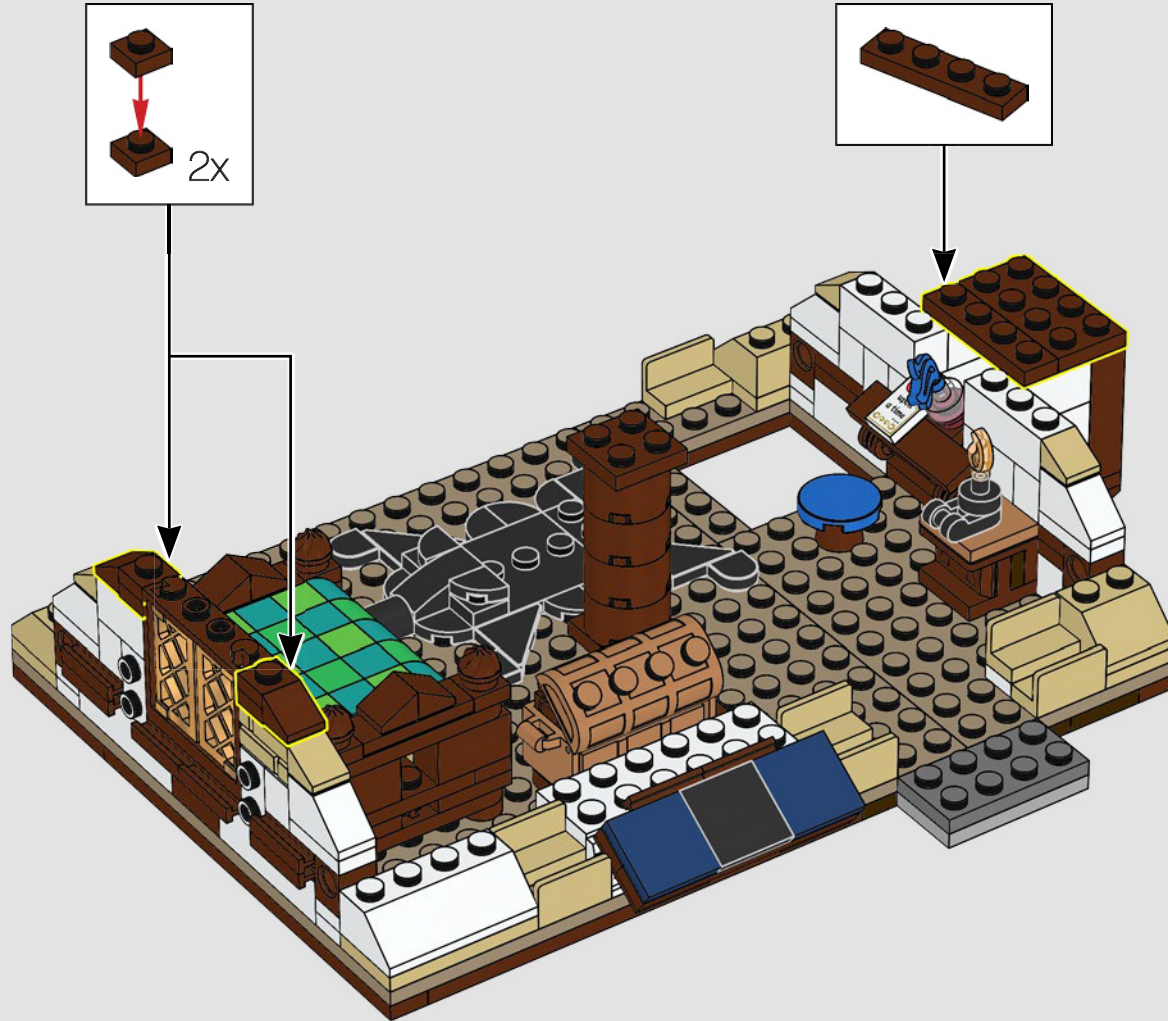

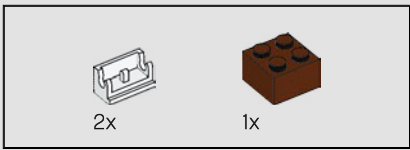

198

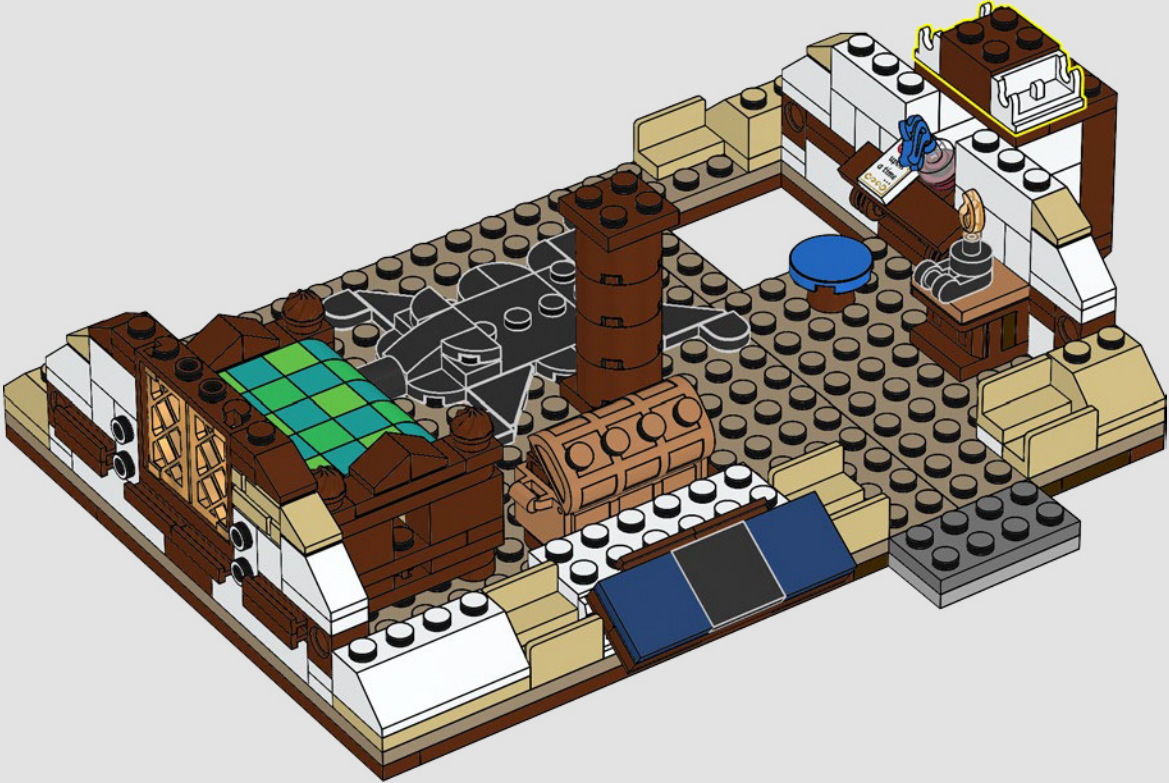

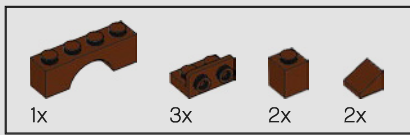

199



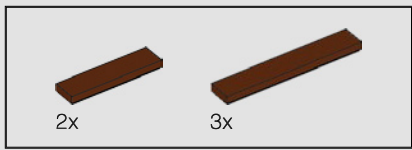

200

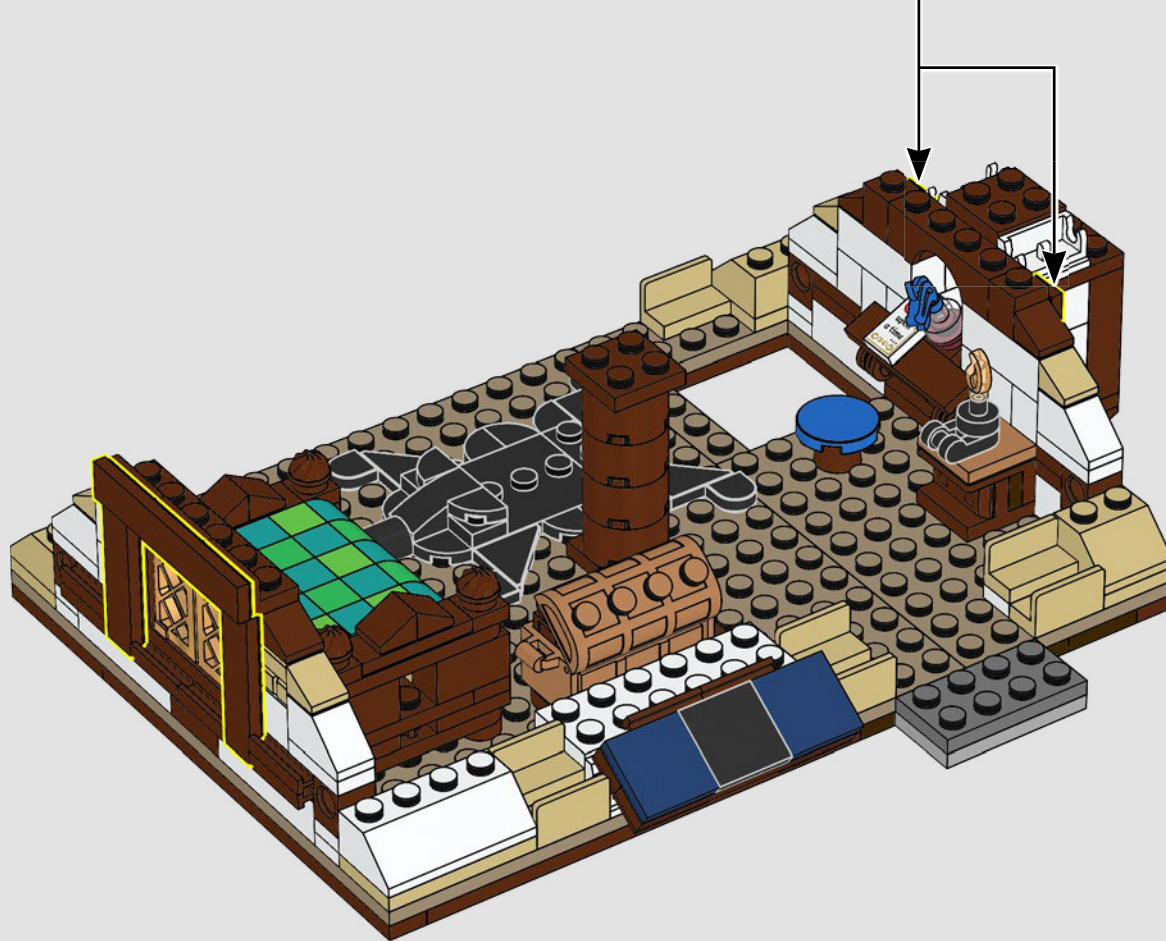
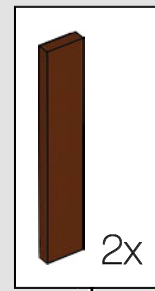

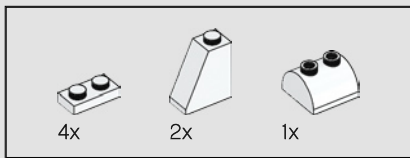

201



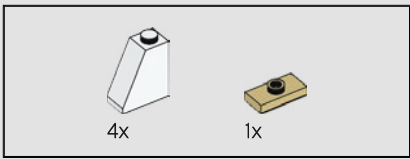

202

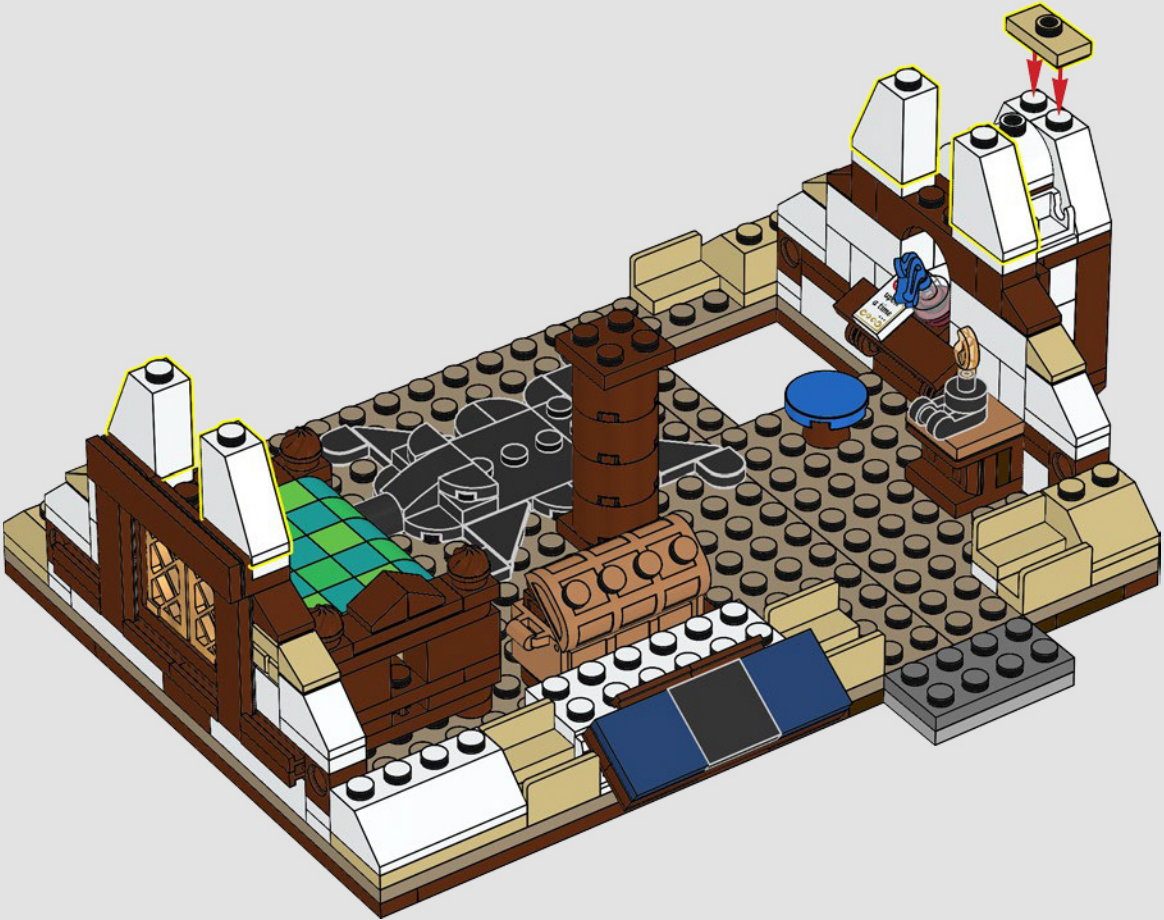

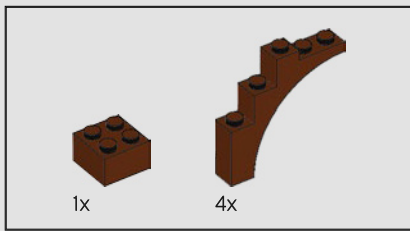

203

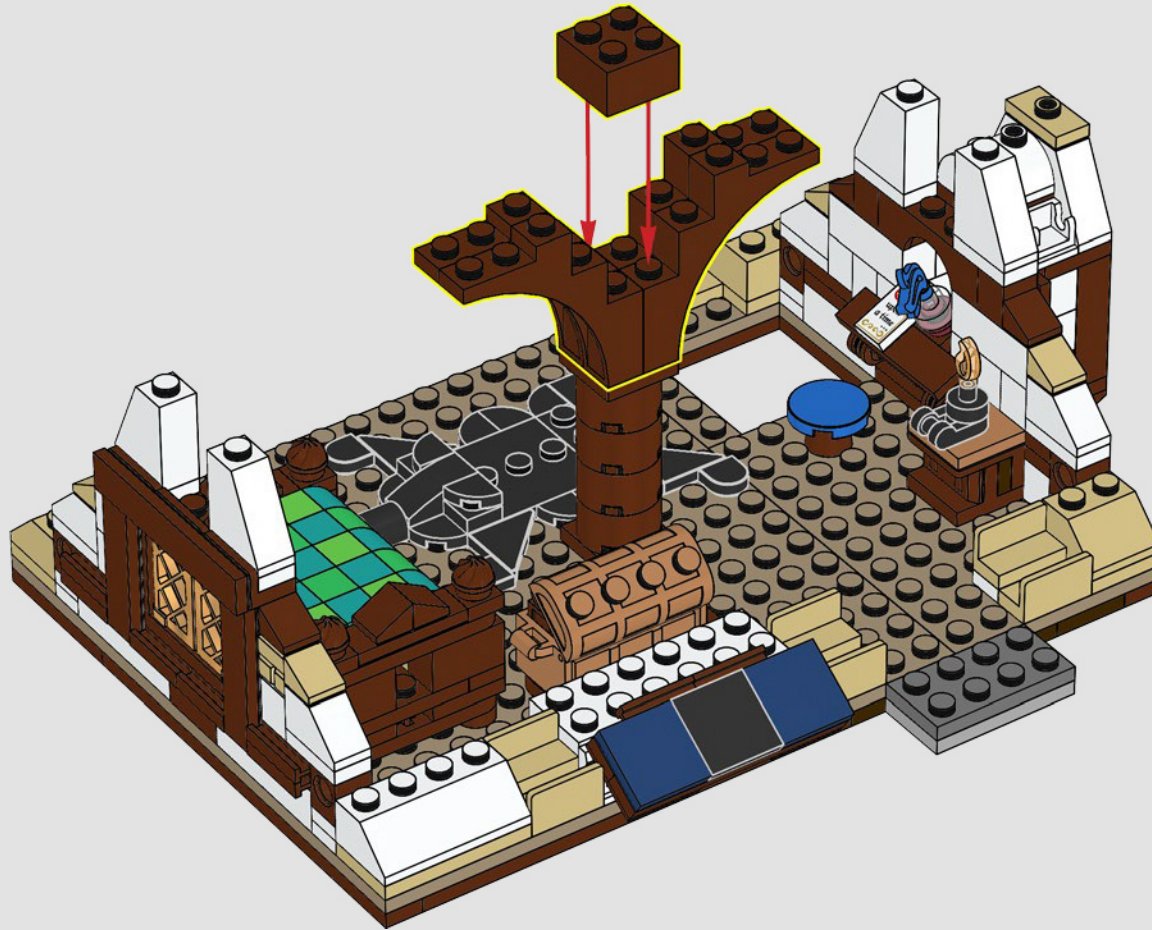

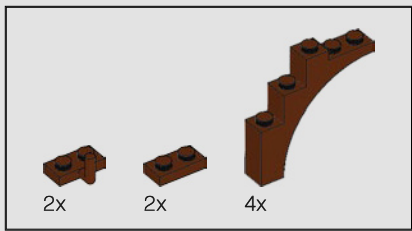

204

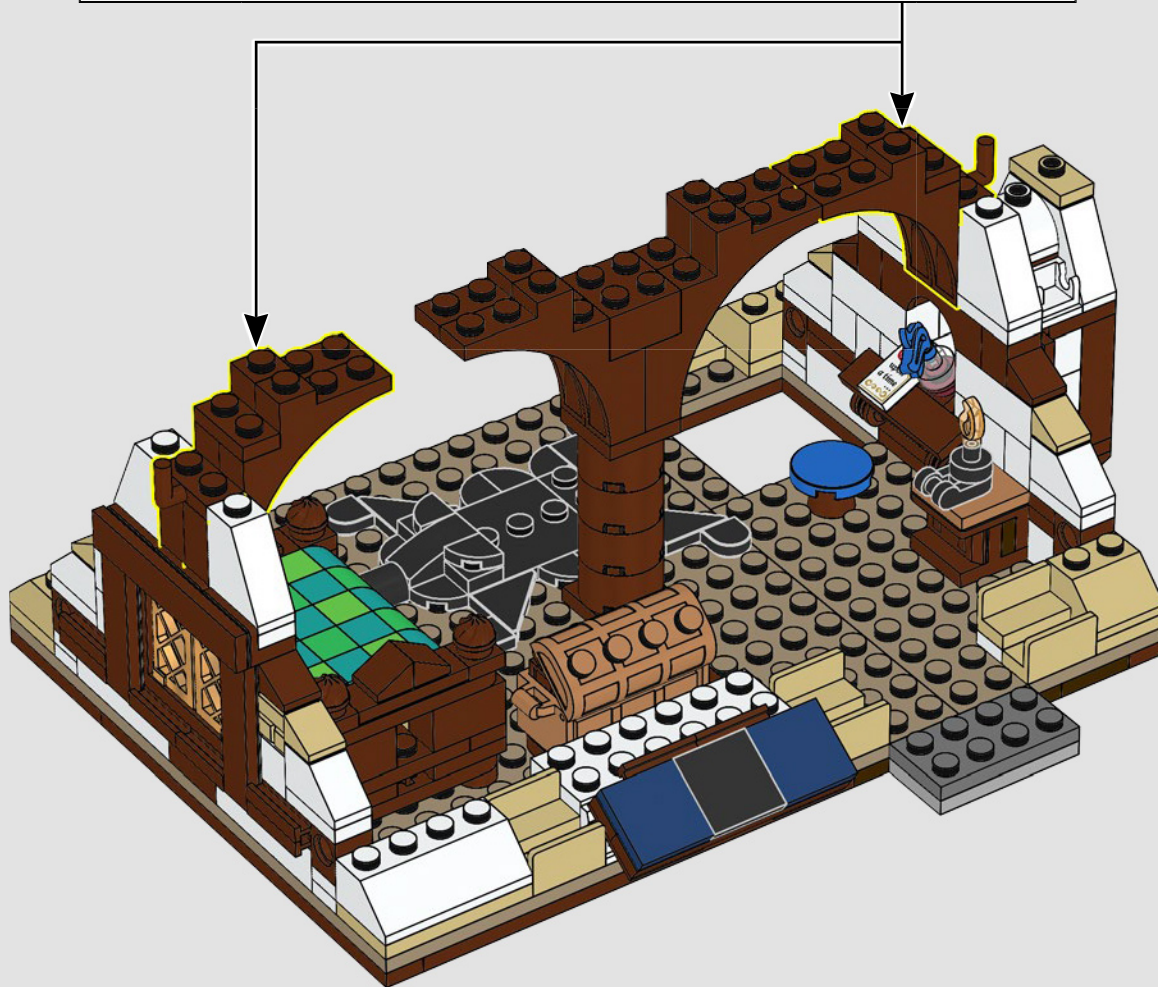
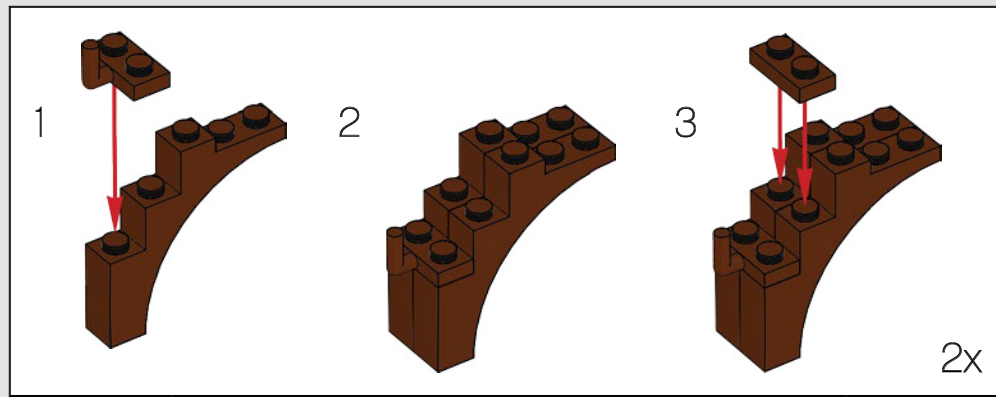

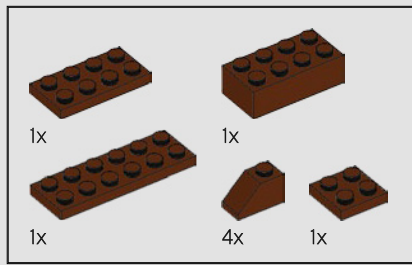

205

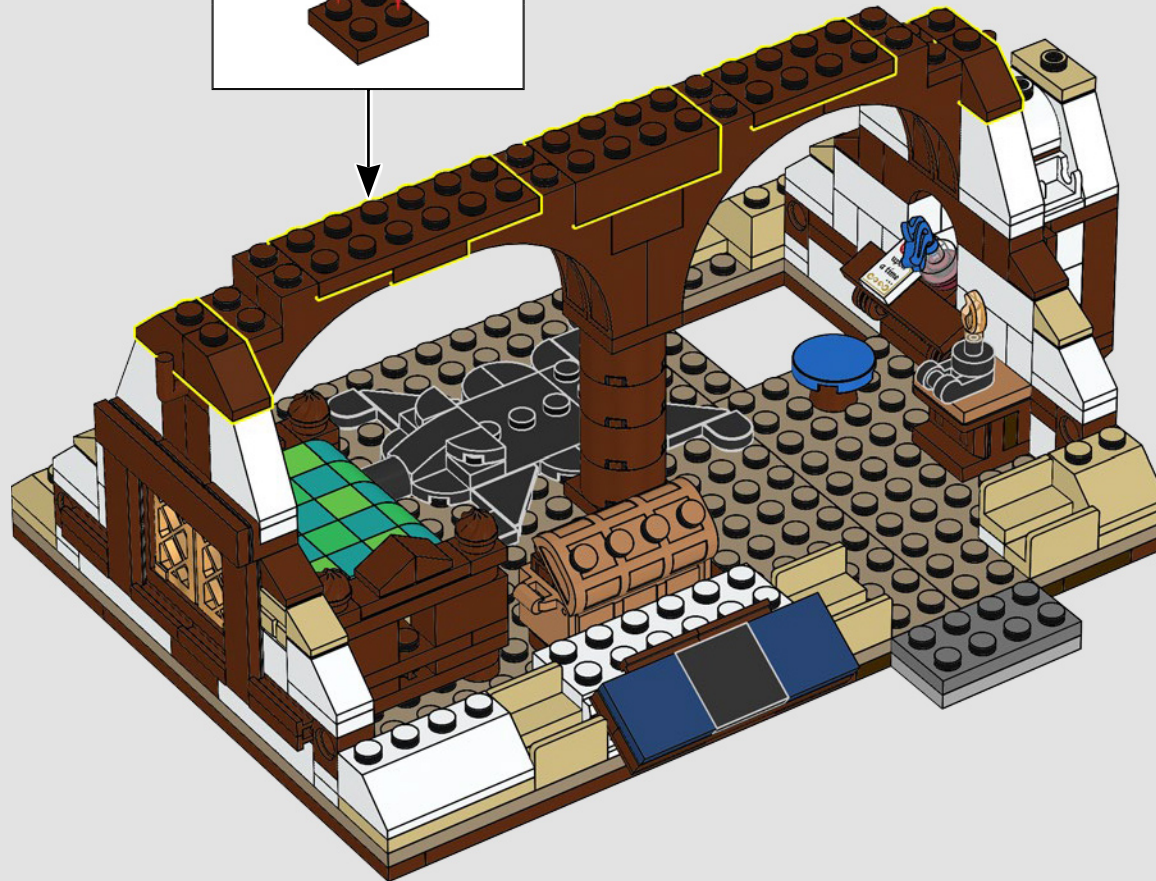
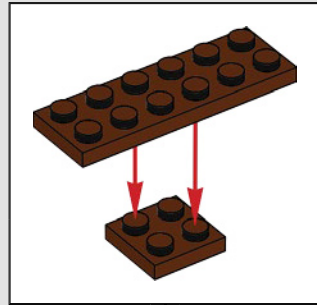

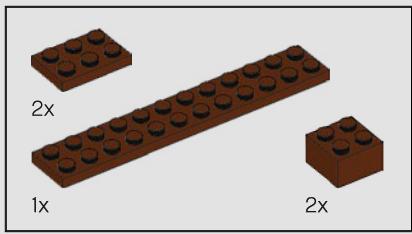

206



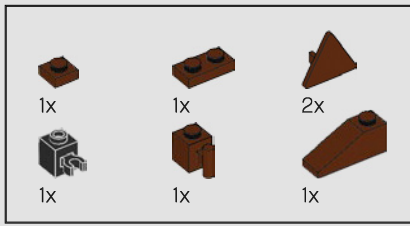

207

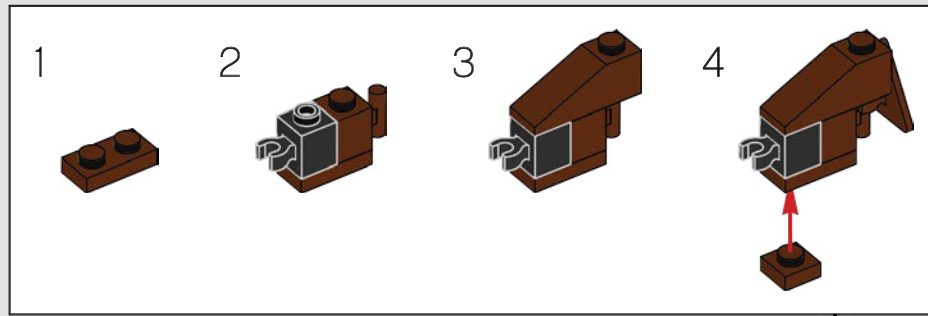

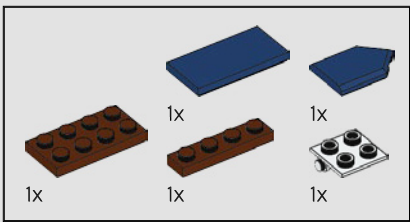

208

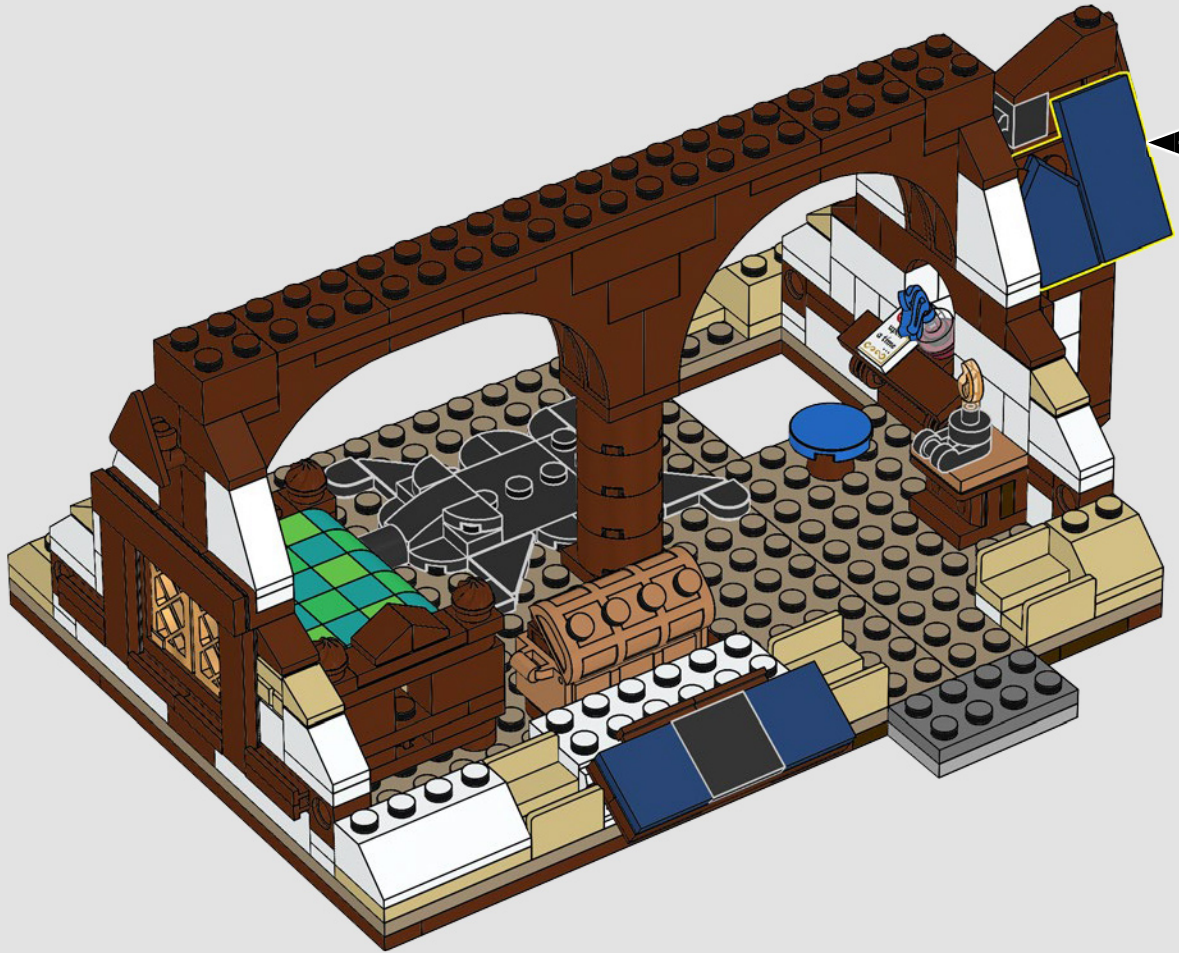
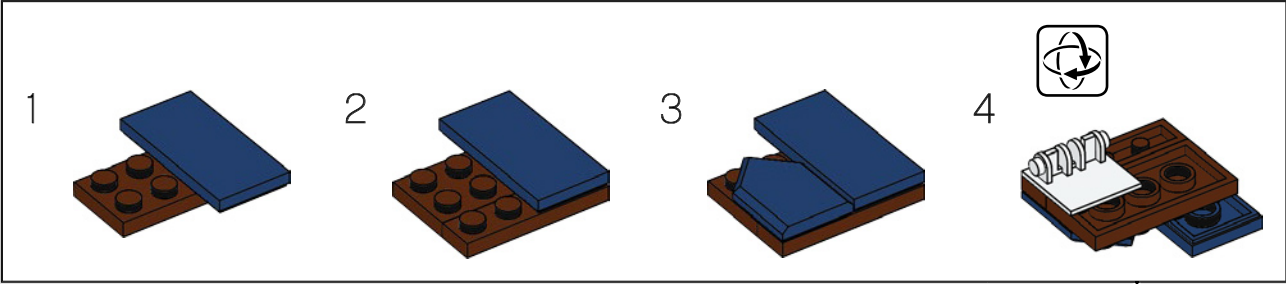

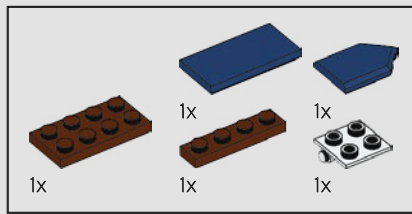

209

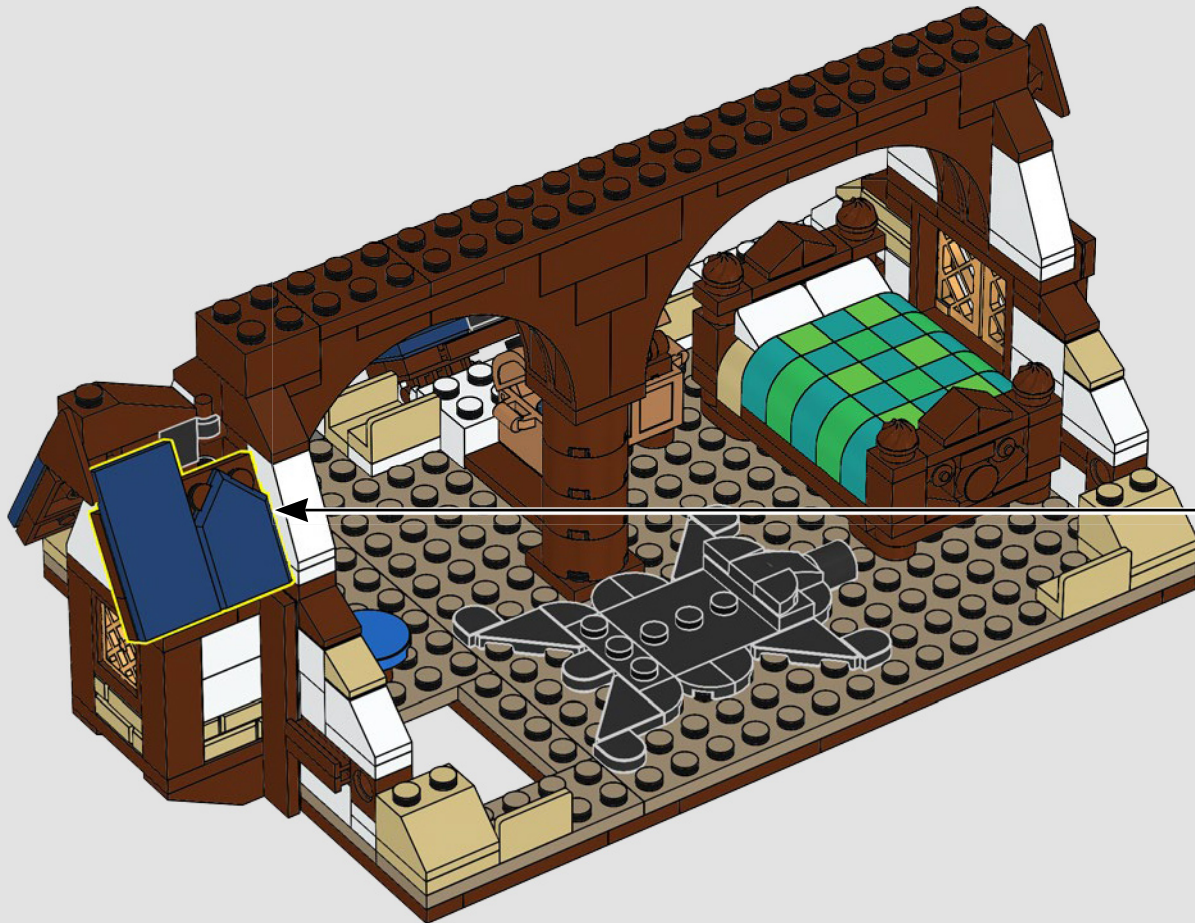
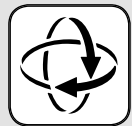
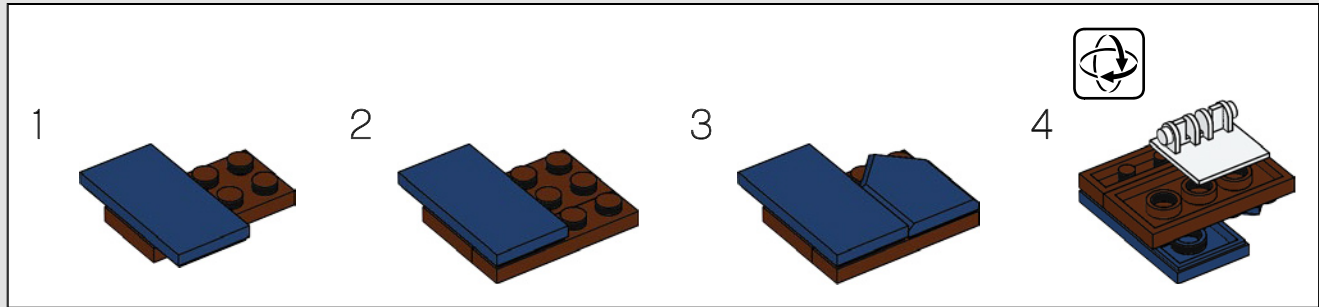

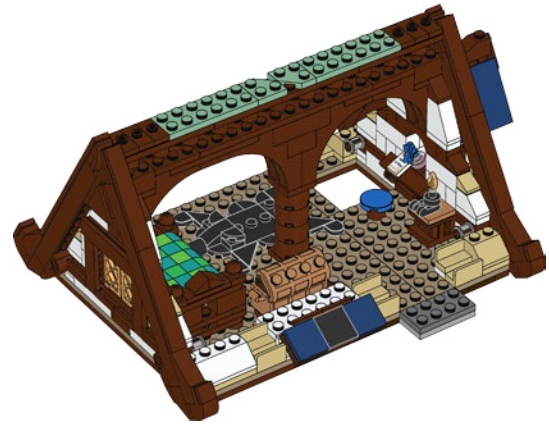

210

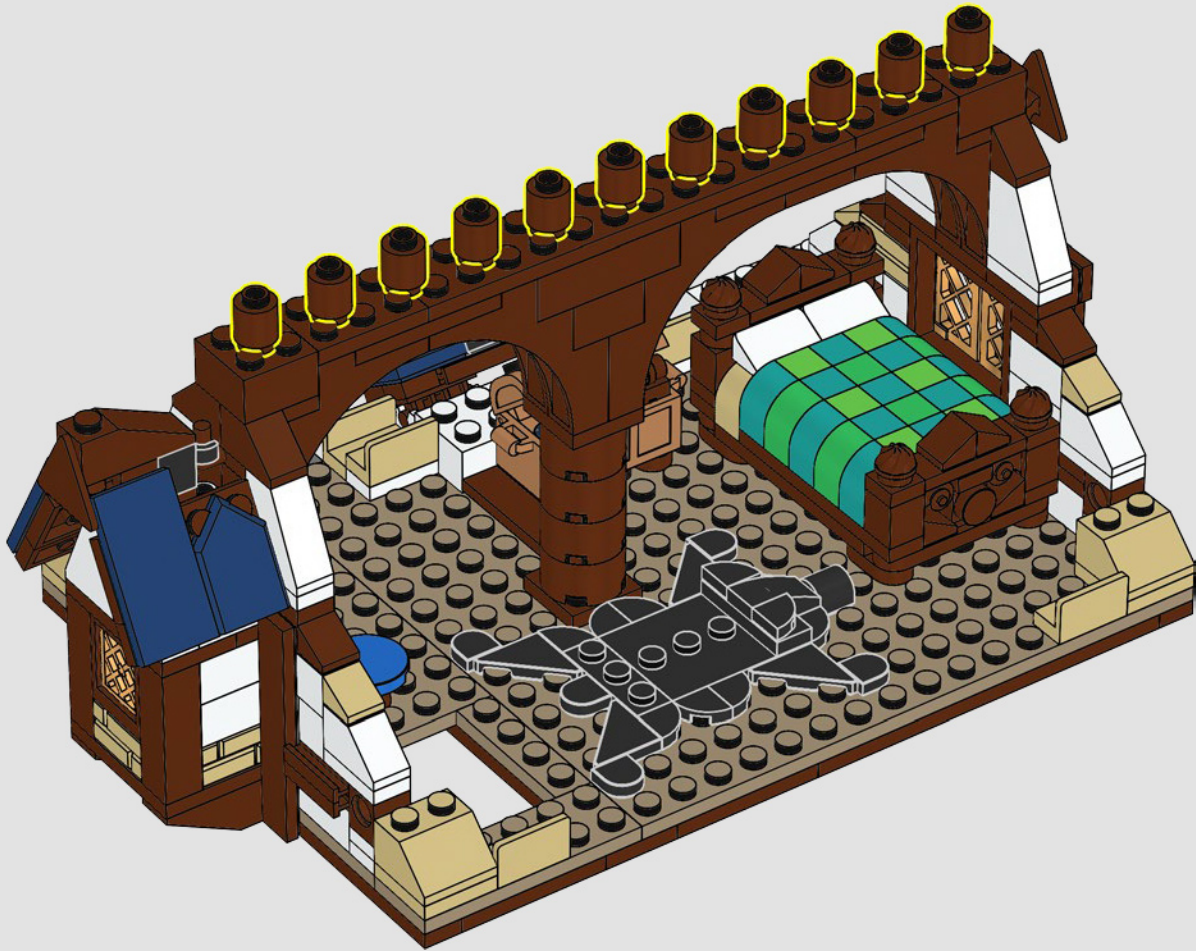

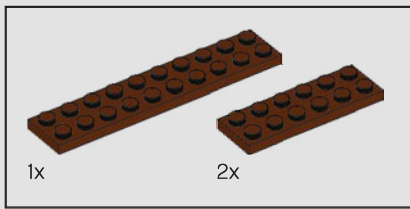

211

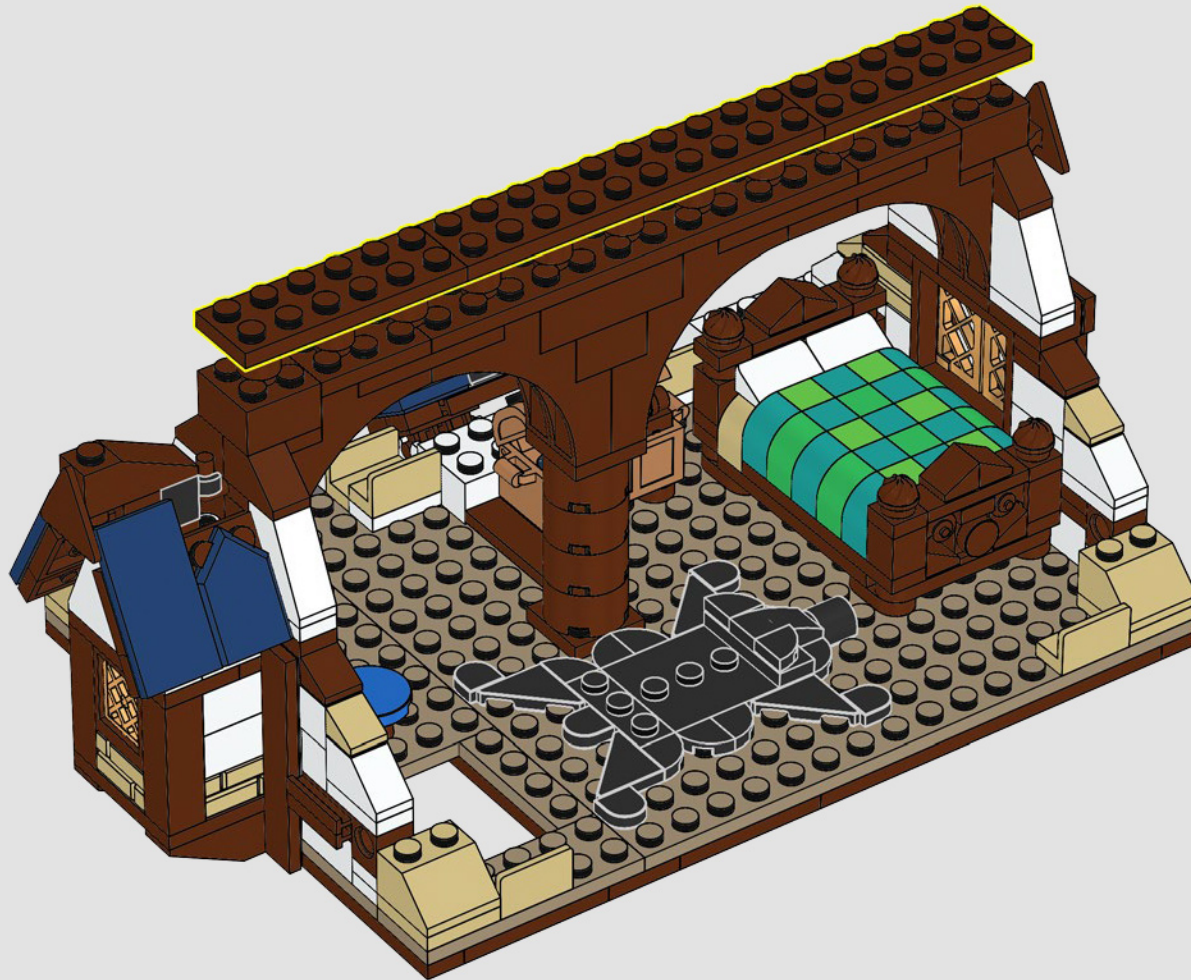

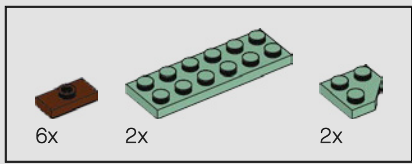

212

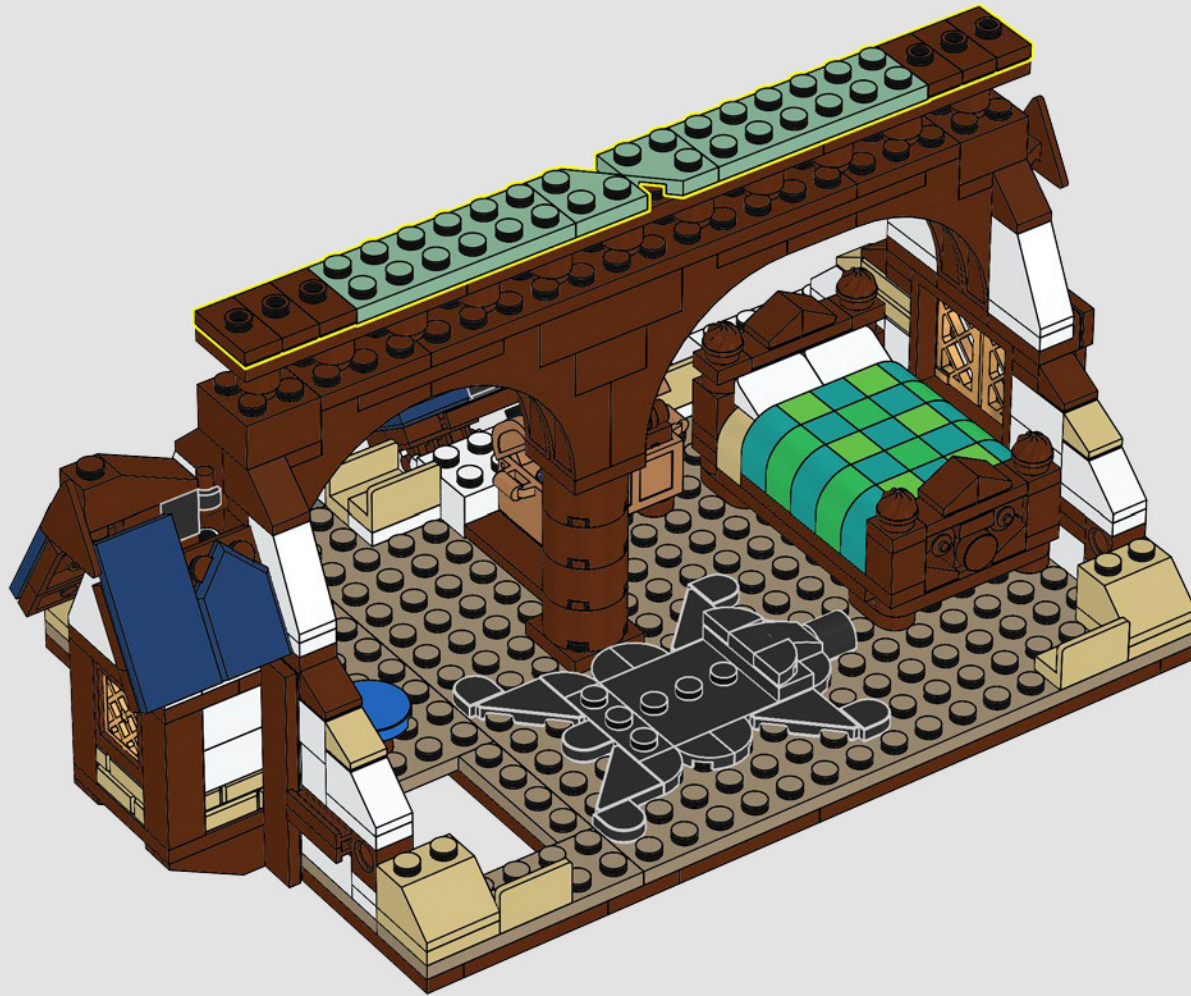

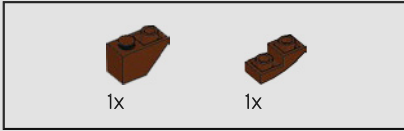

213

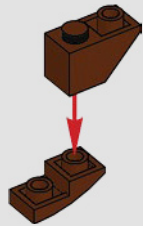

214

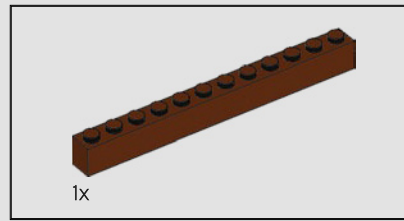
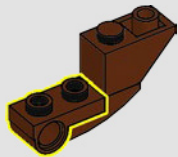

215

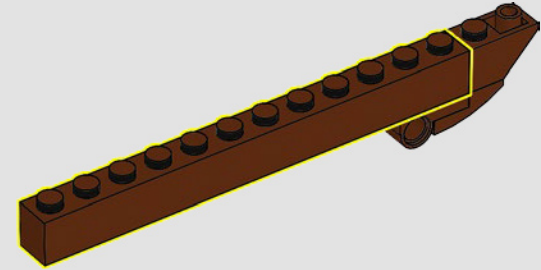

216

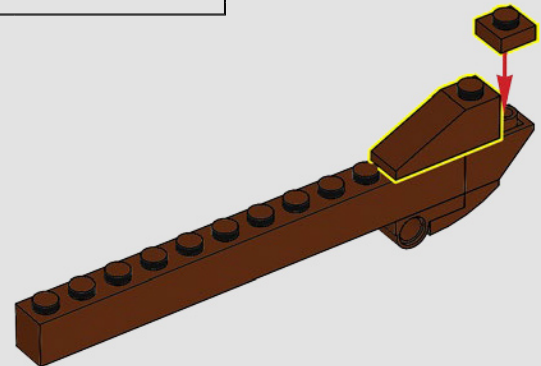

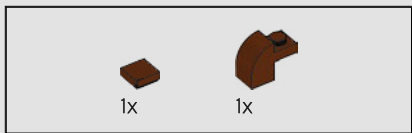

217

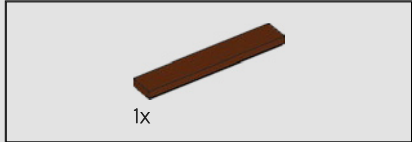
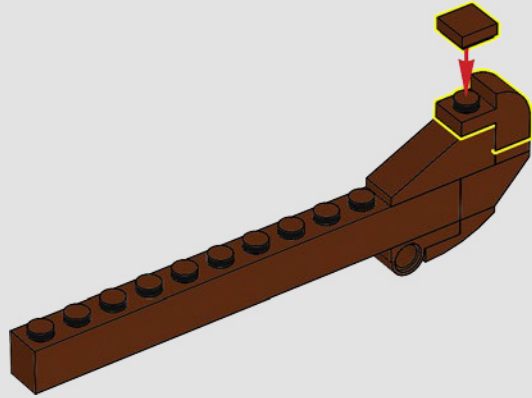

218

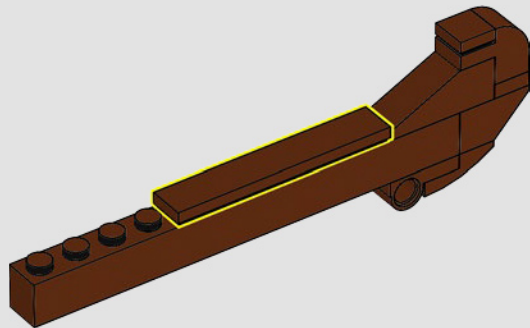

219

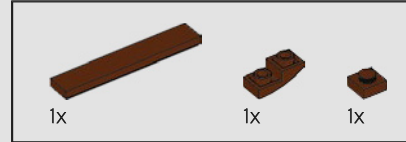
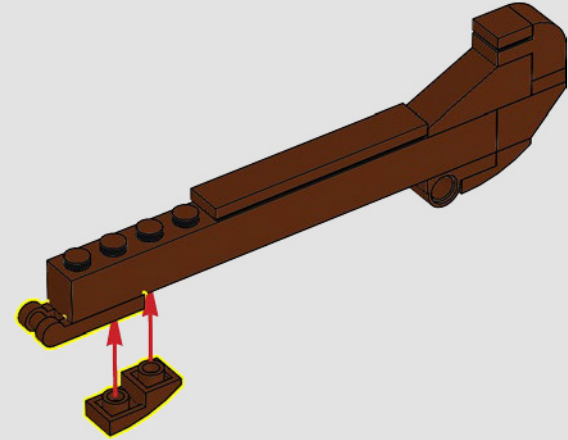

220

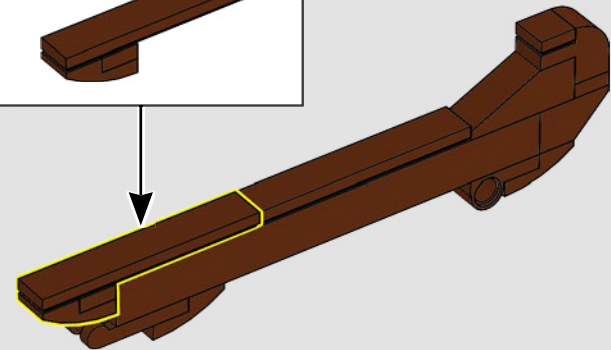
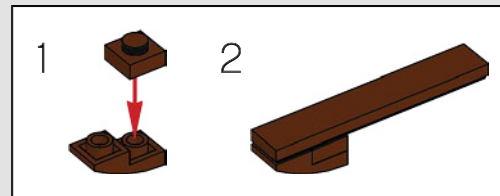

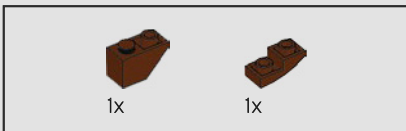
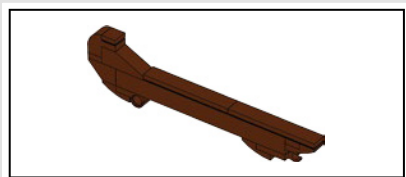

221

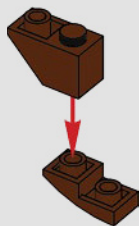

222

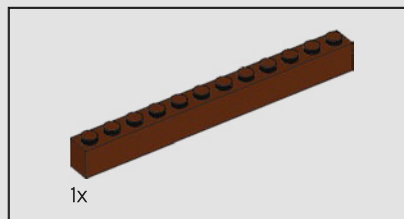
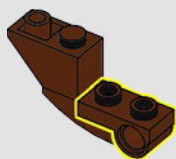

223

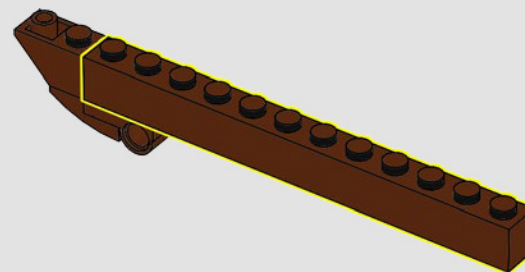

224

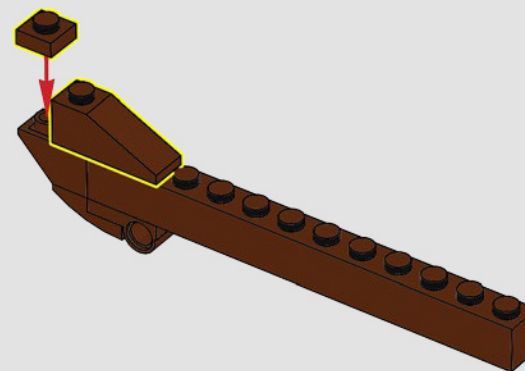

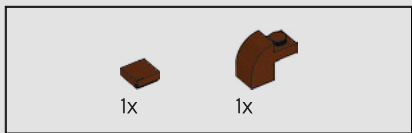

225

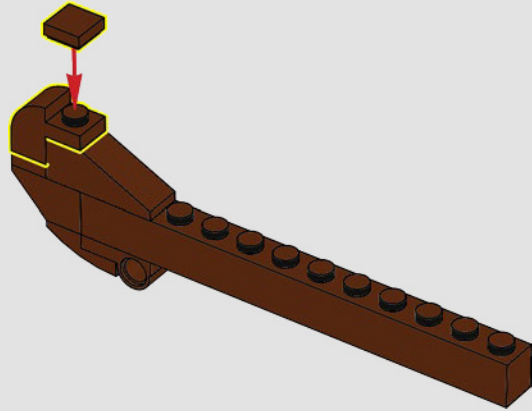

226

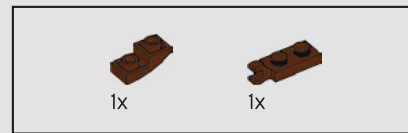
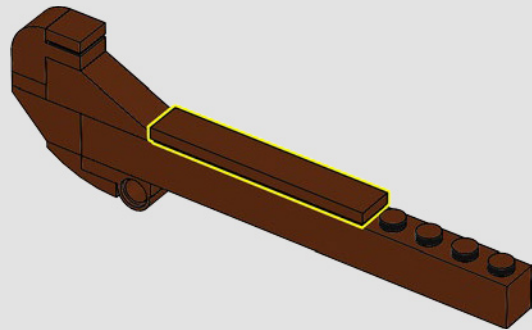

227

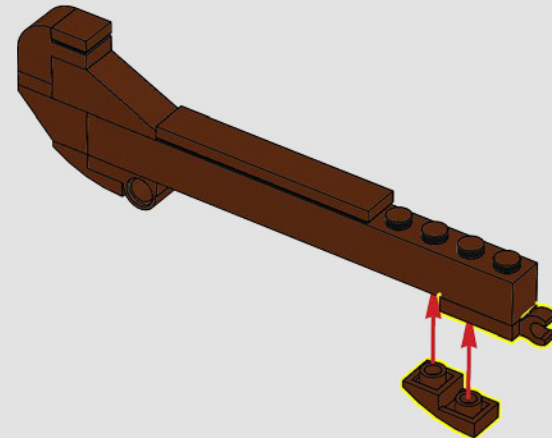

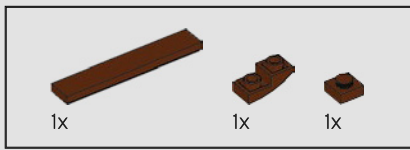

228

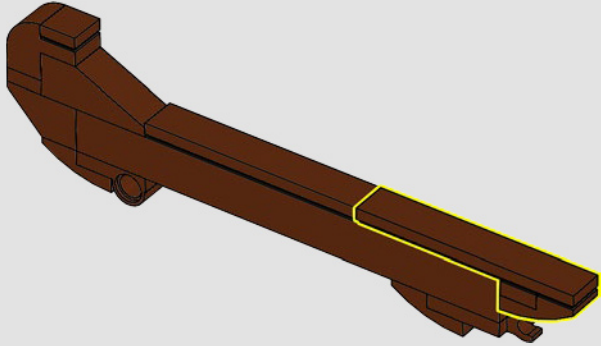
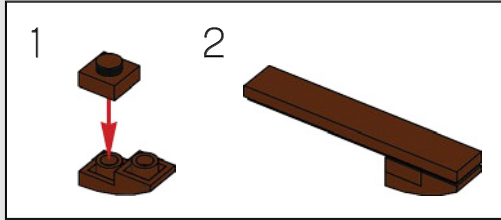

229

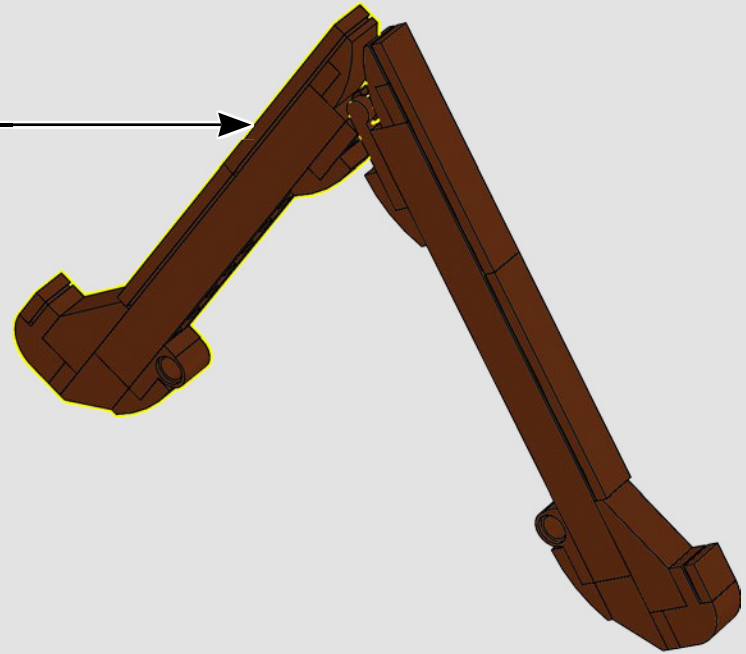

2x

230

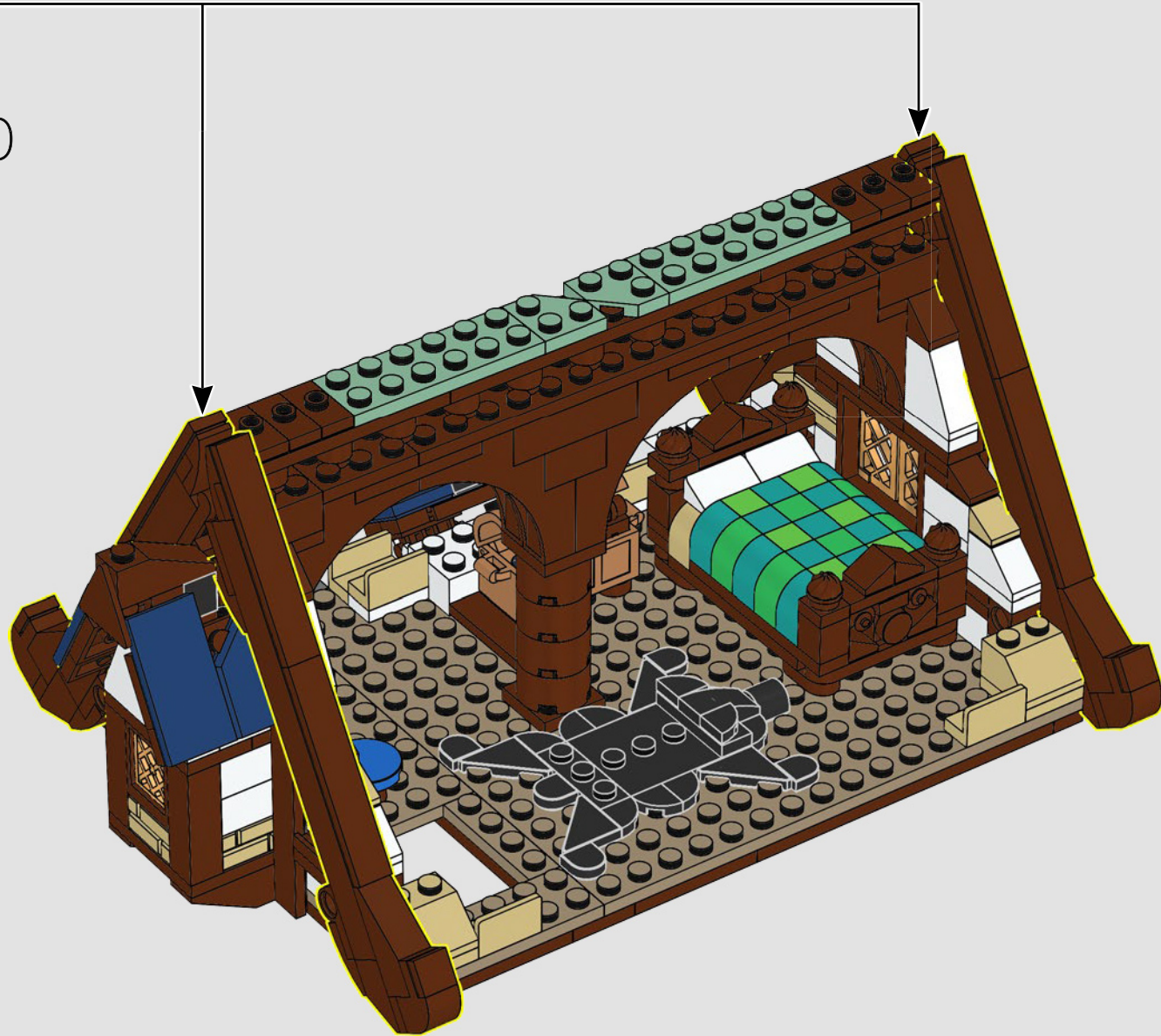

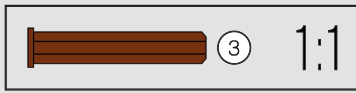
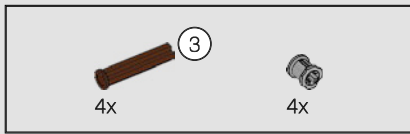

231

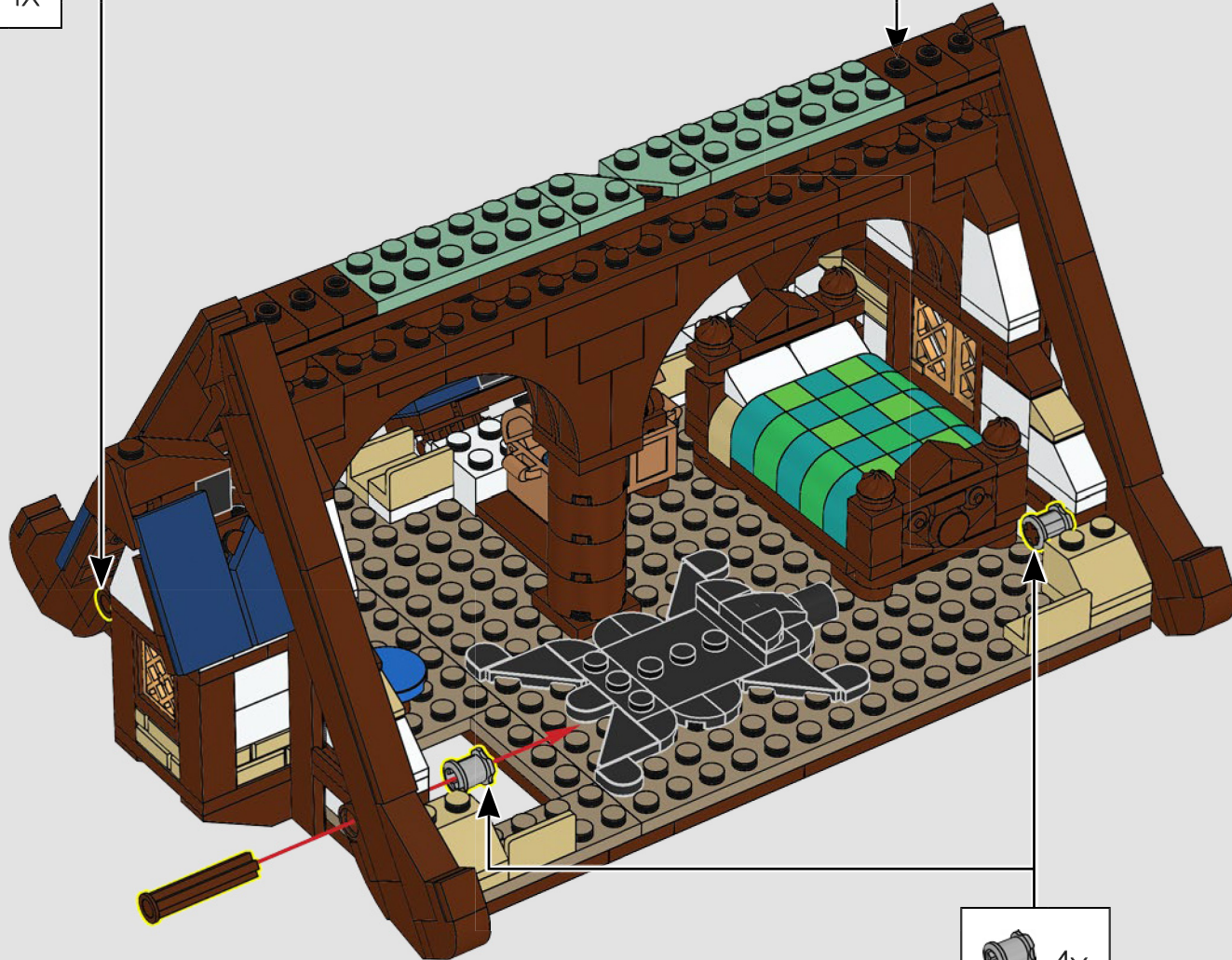
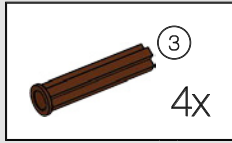

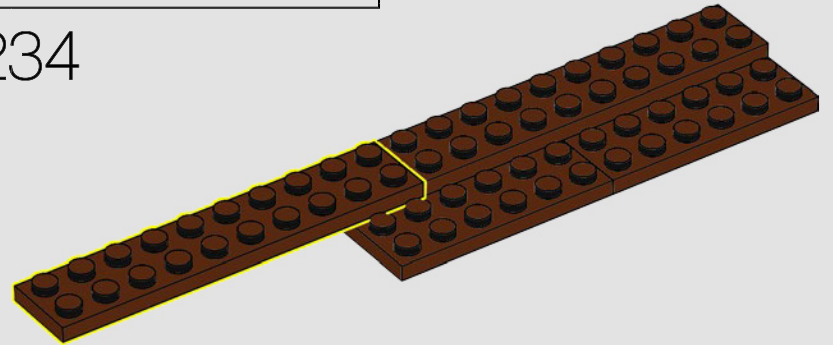
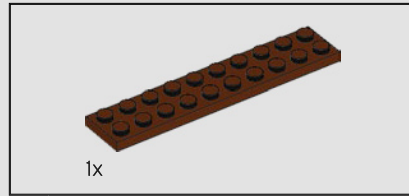
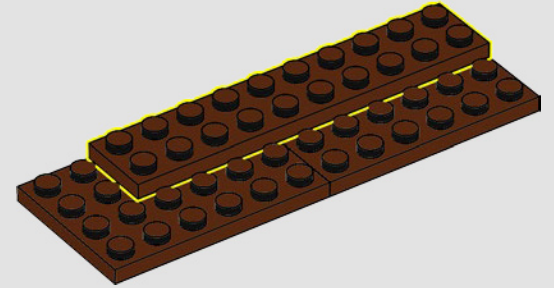
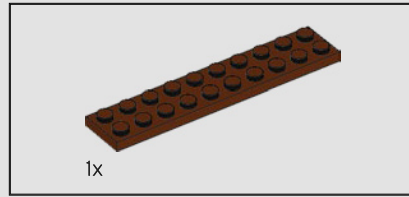
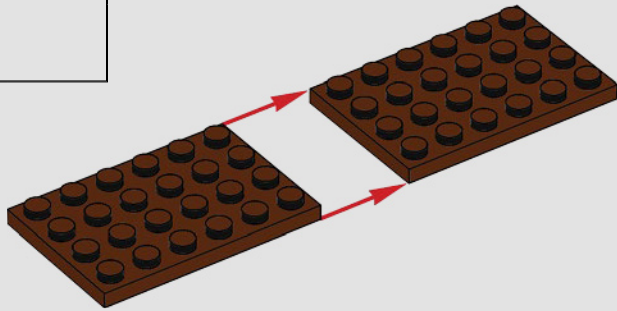
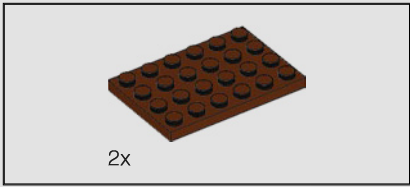
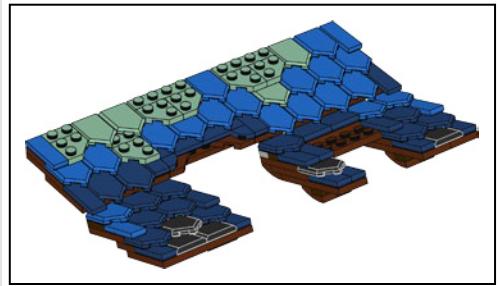
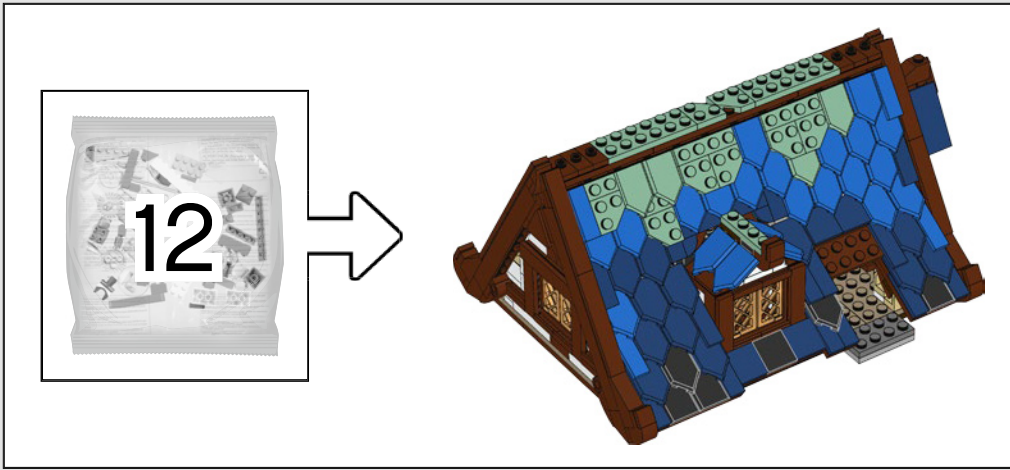

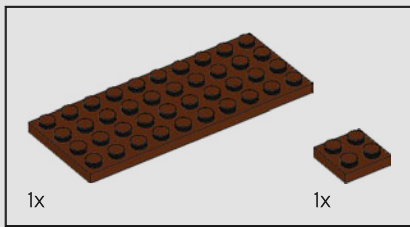

235

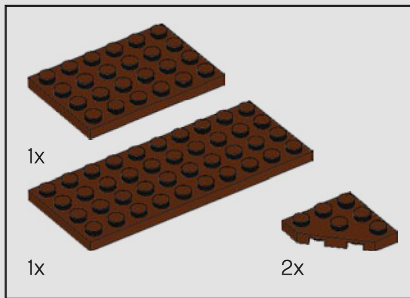
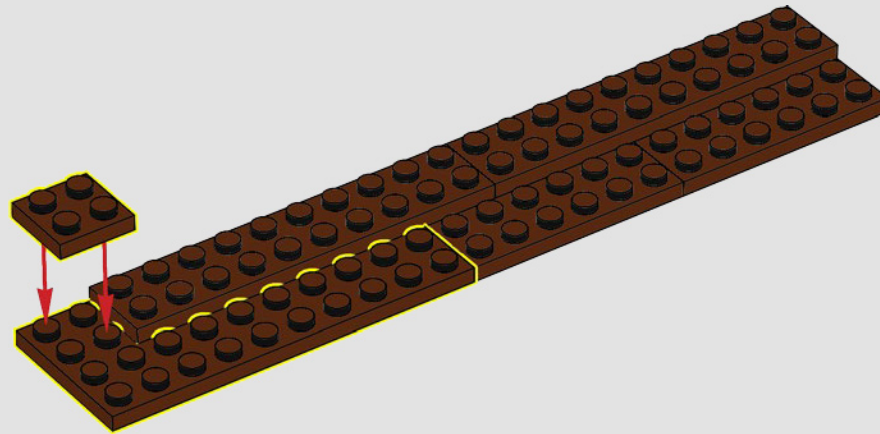

236

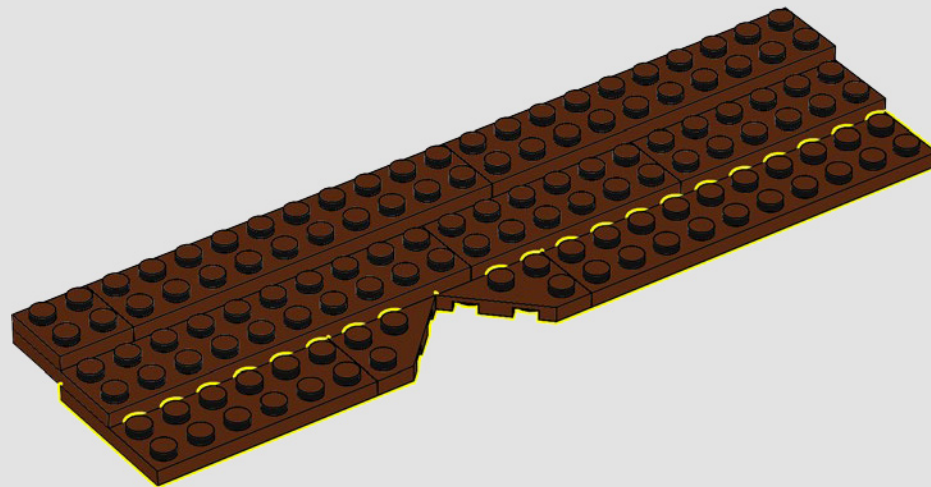

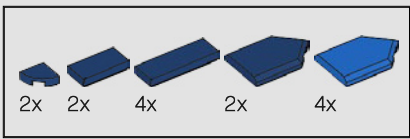

237

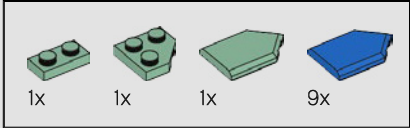
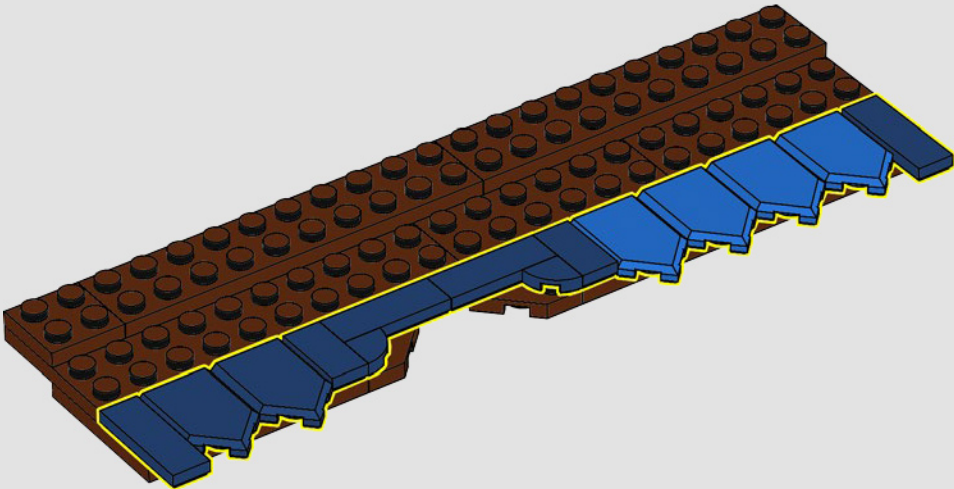

238

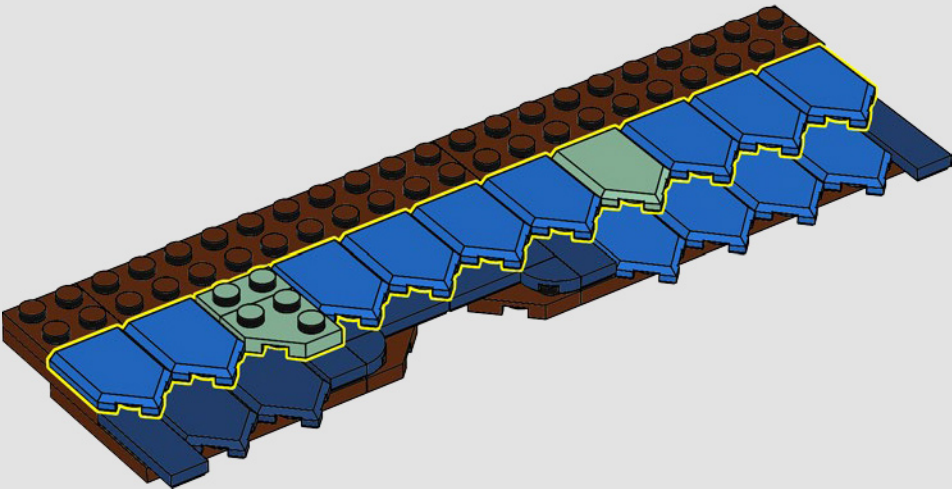

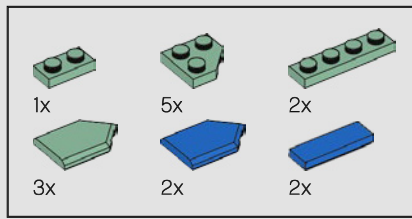

239

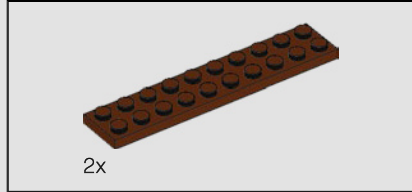
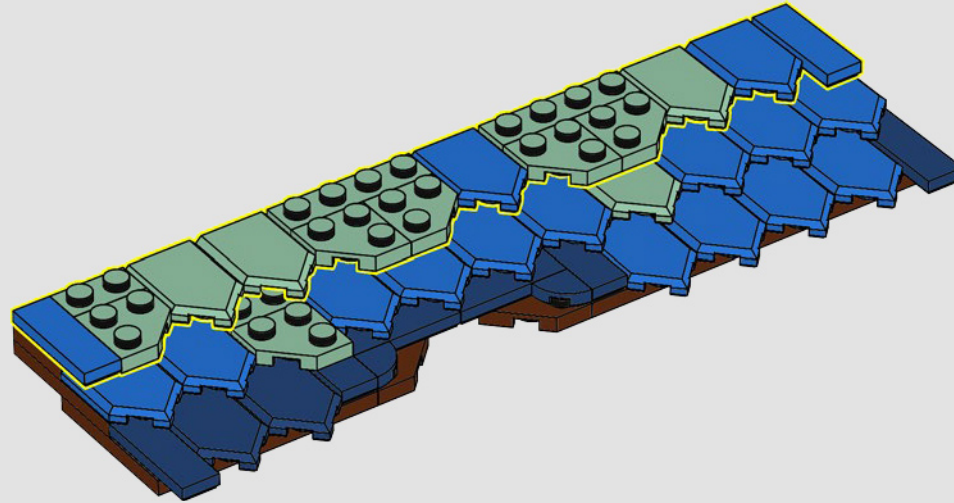

240

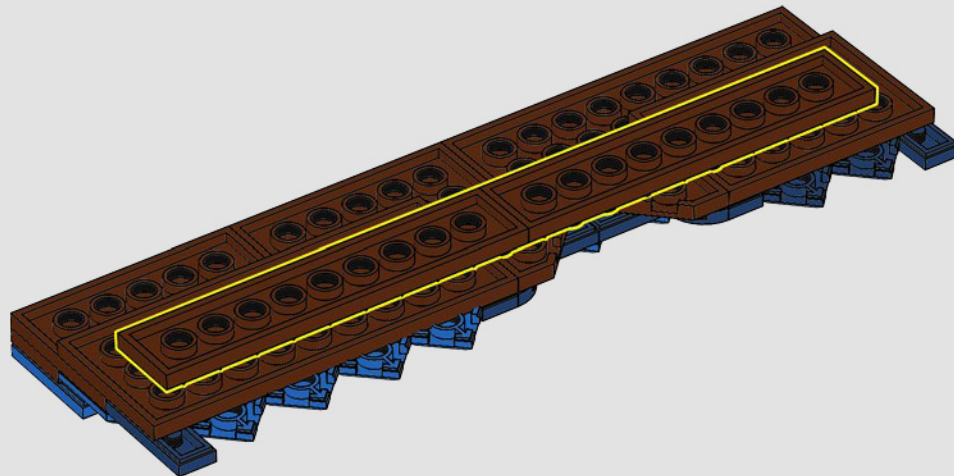
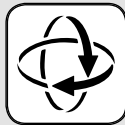

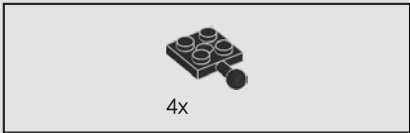

241

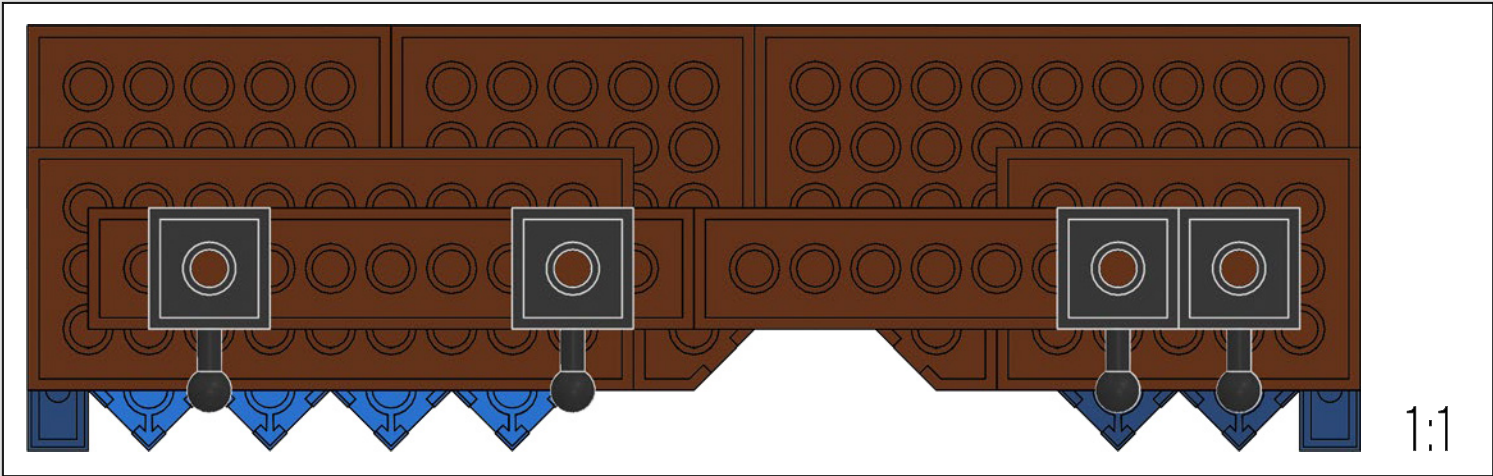
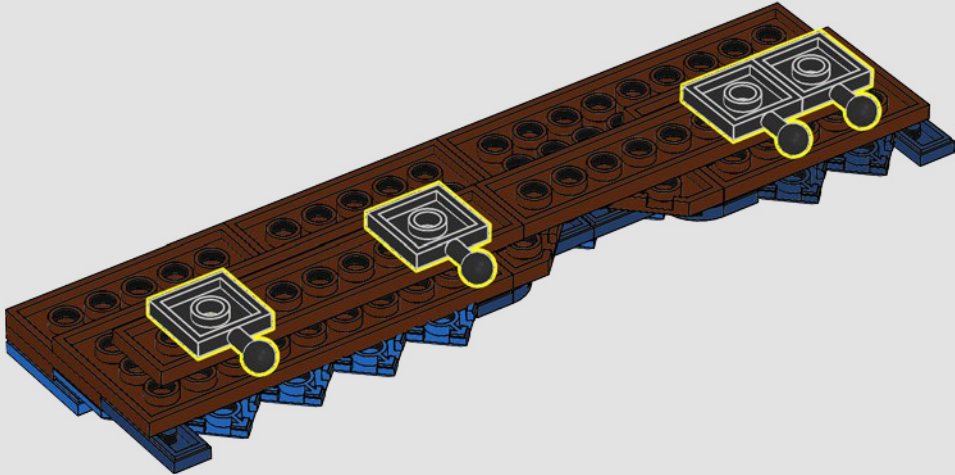

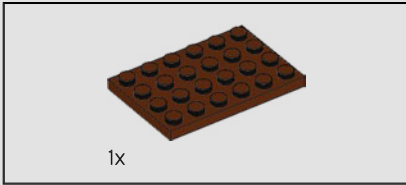
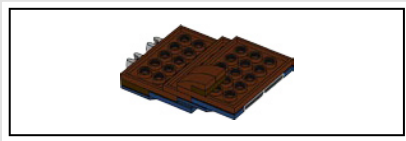

242

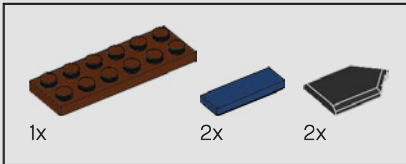
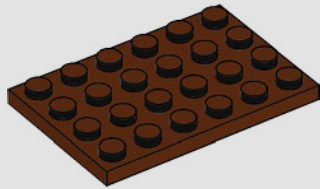

243

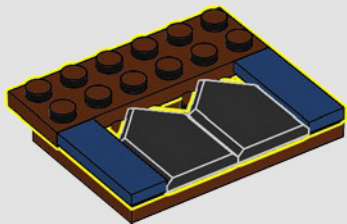

244

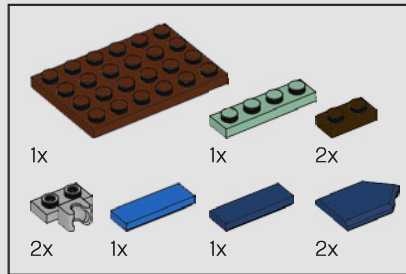
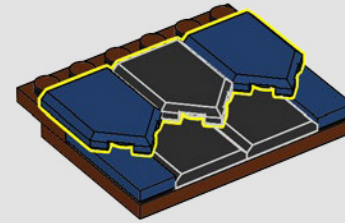

245

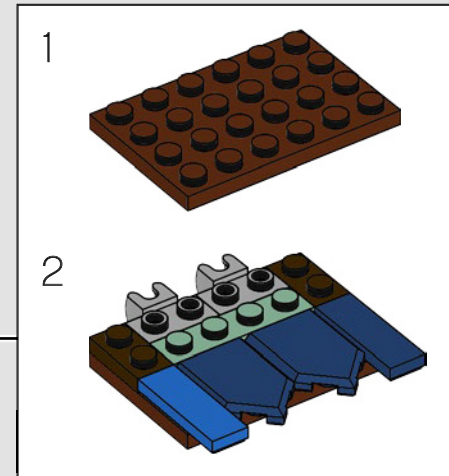
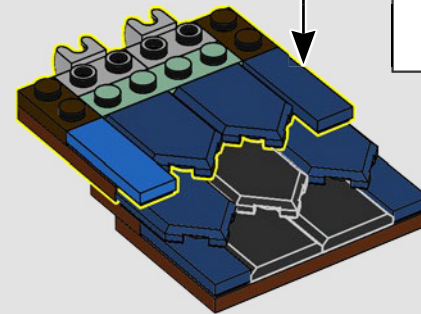

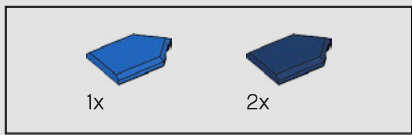

246

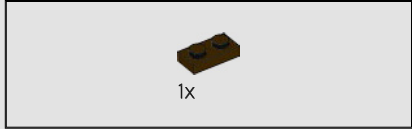
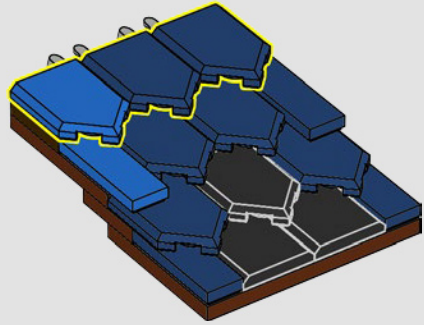

247

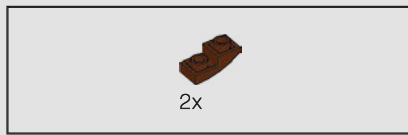
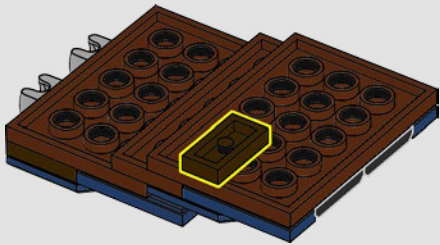

248

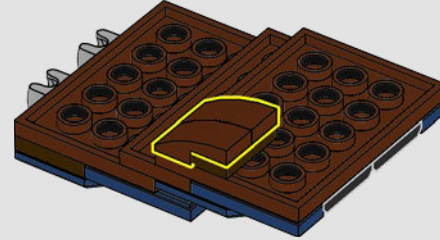

249

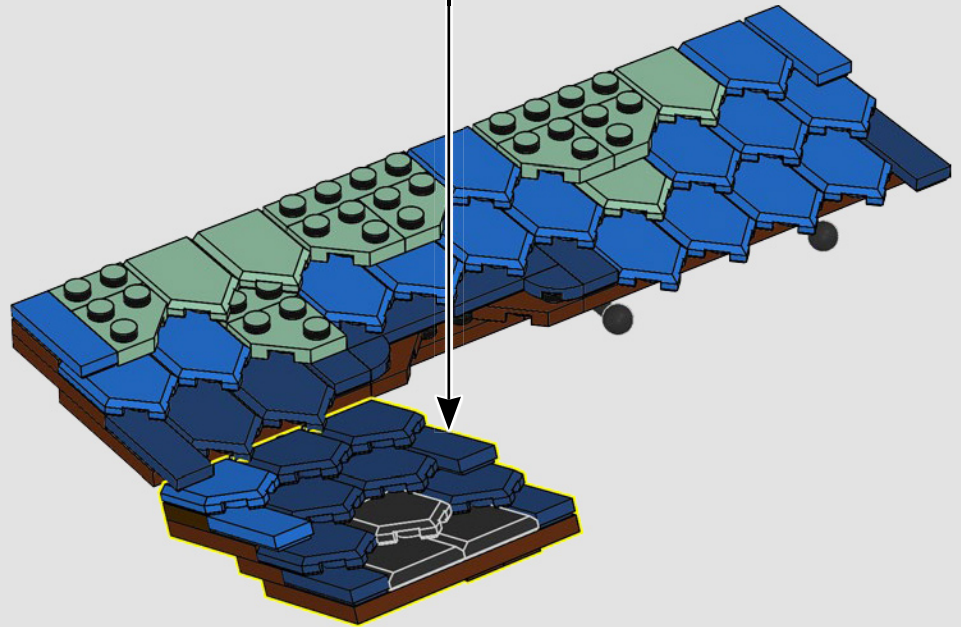
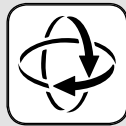

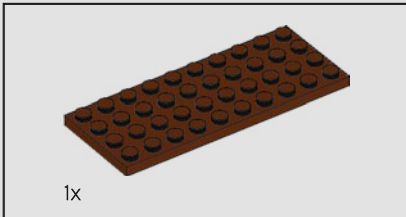
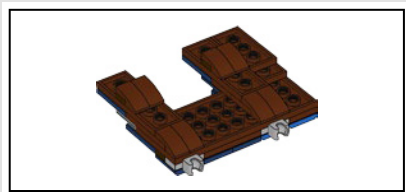

1x

250

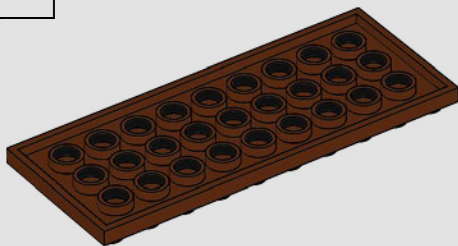

2x

1x

251

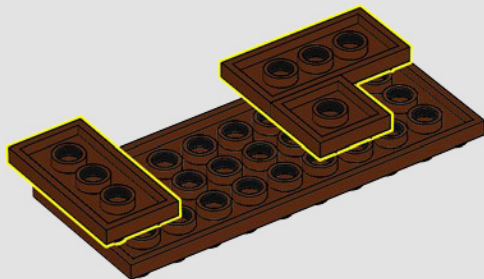

4x

252

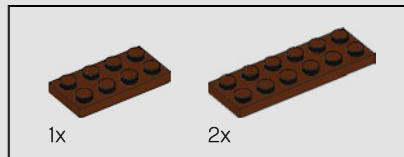
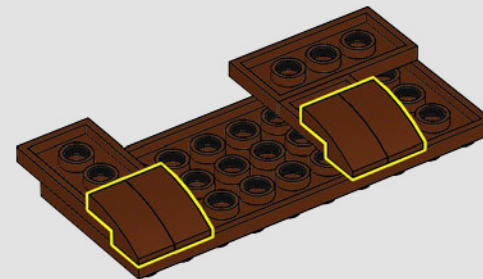

1x

2x

253

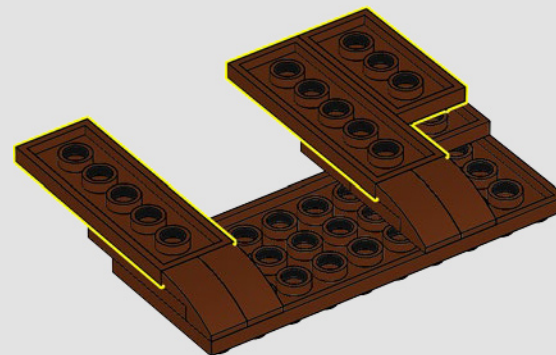

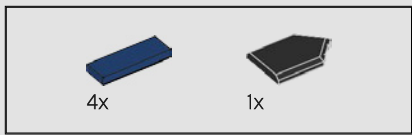

254

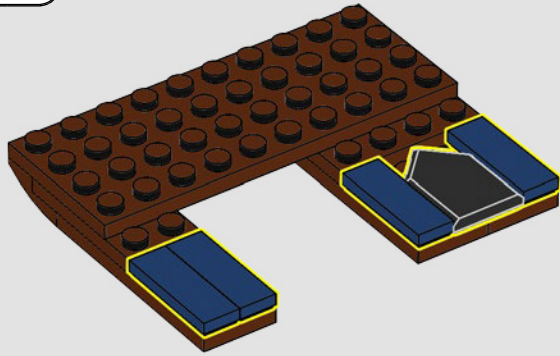

255

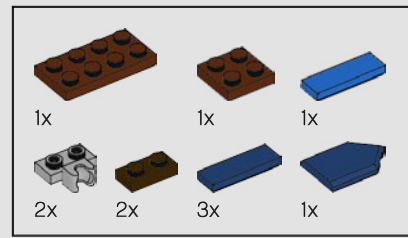
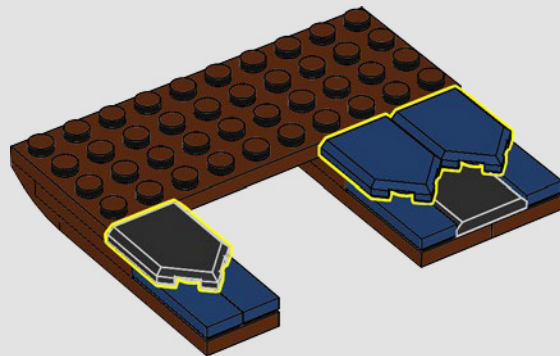

256

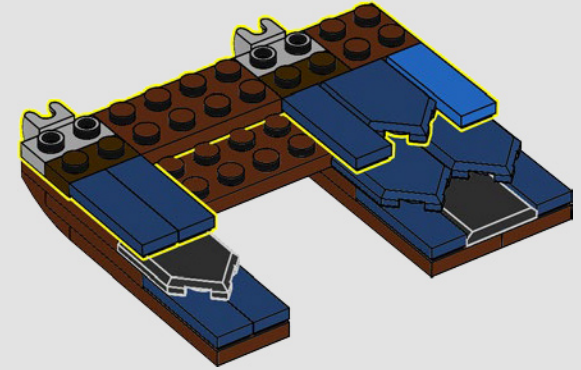

257

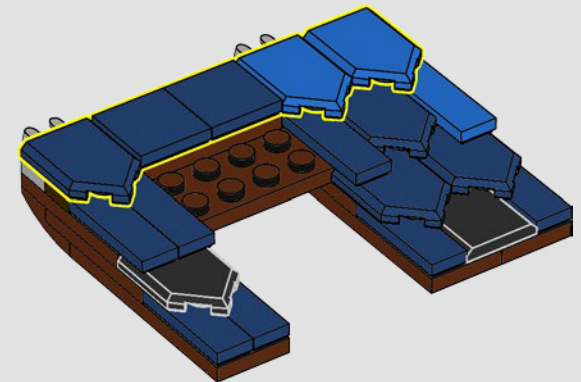



258

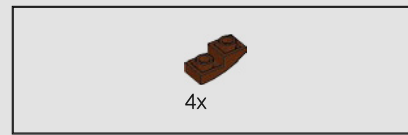
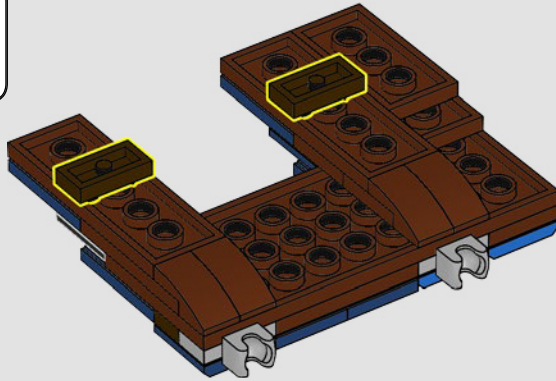

259

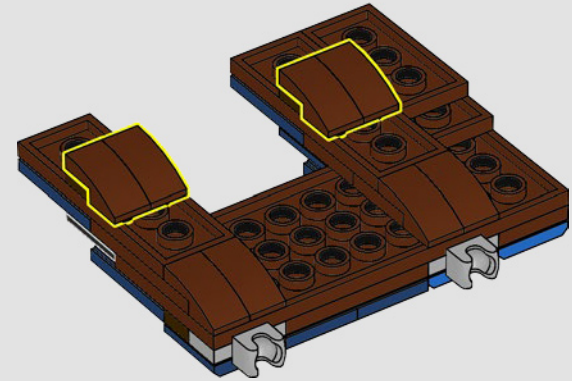

260

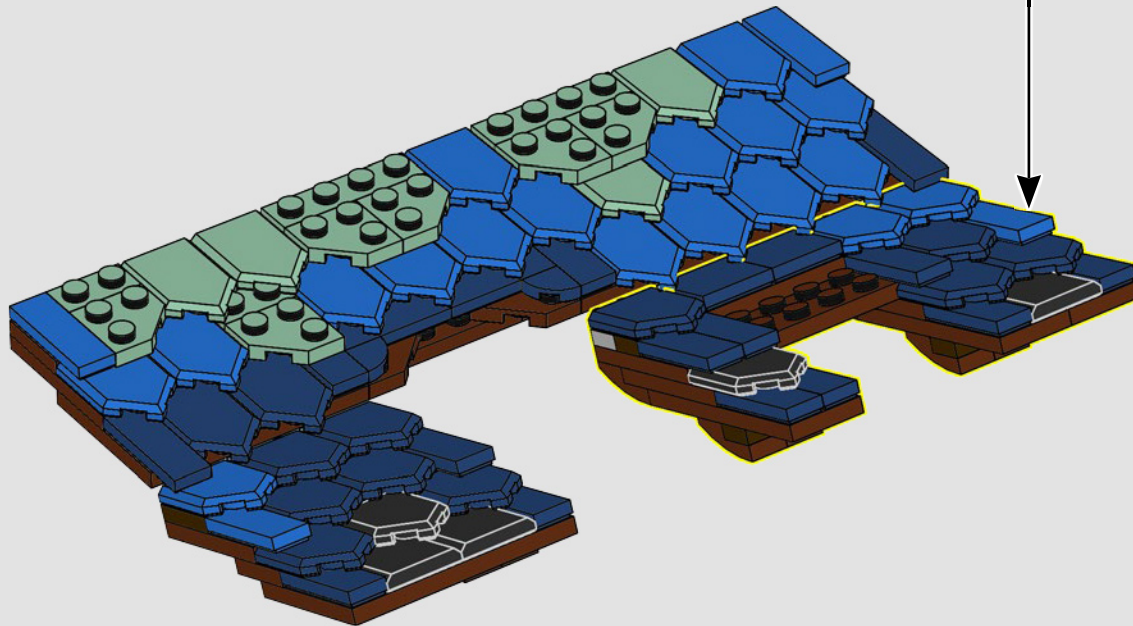

261

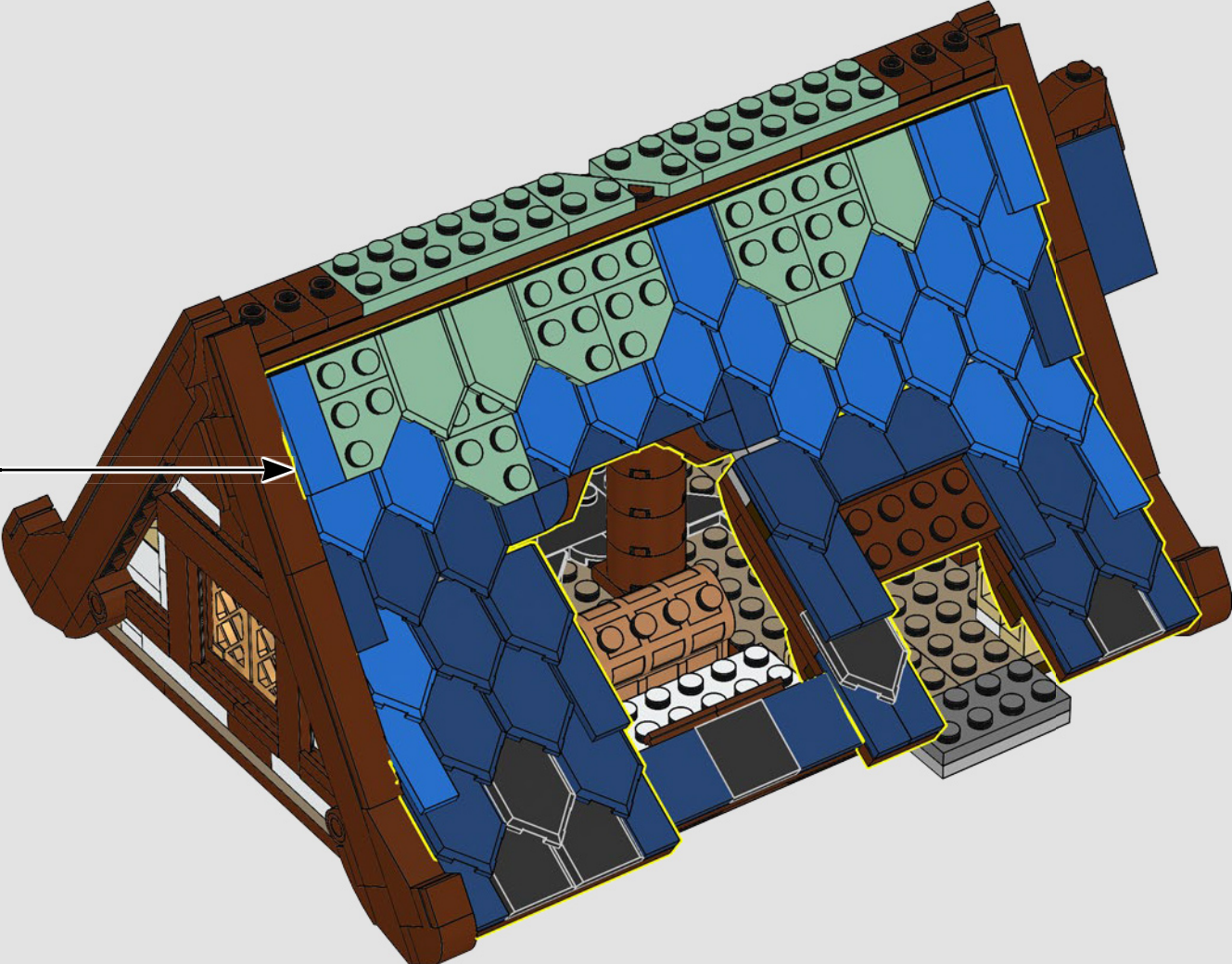

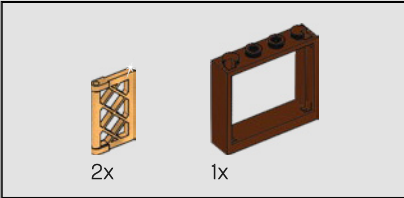
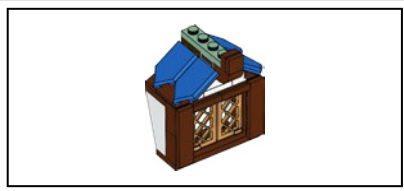

262

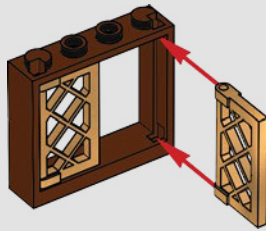

263

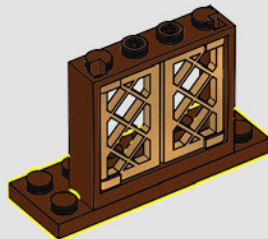

264

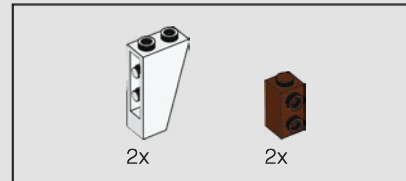
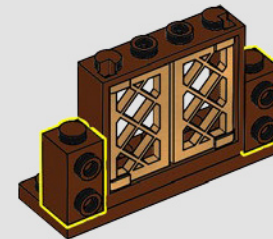

265

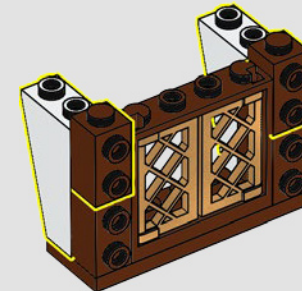

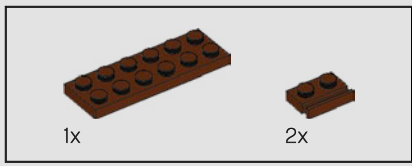

266

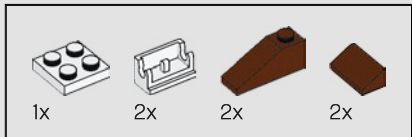
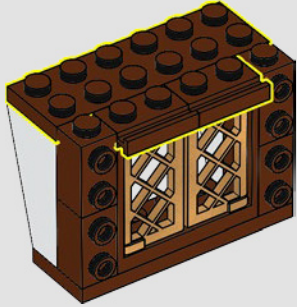

267

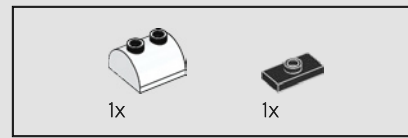
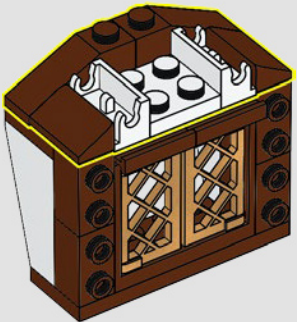

268

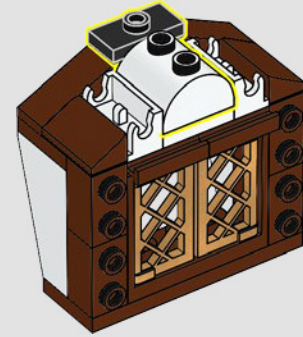

269

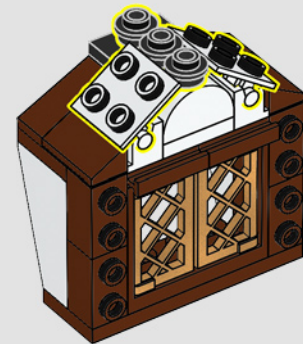



270

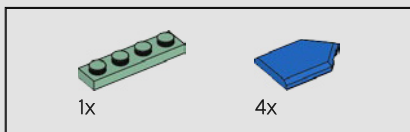
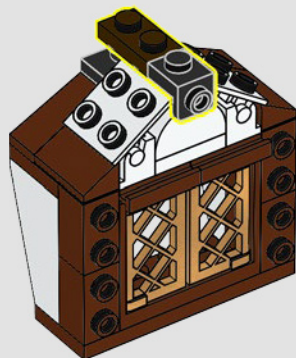

271

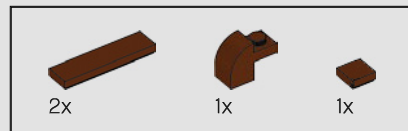
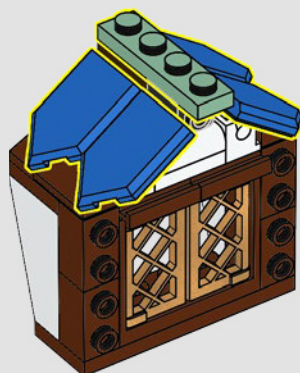

272

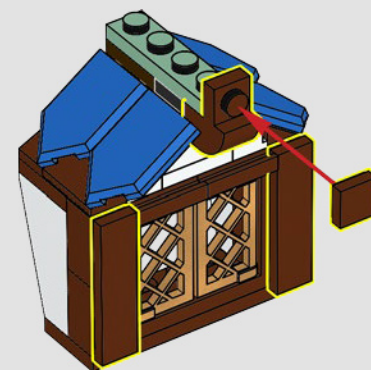

273

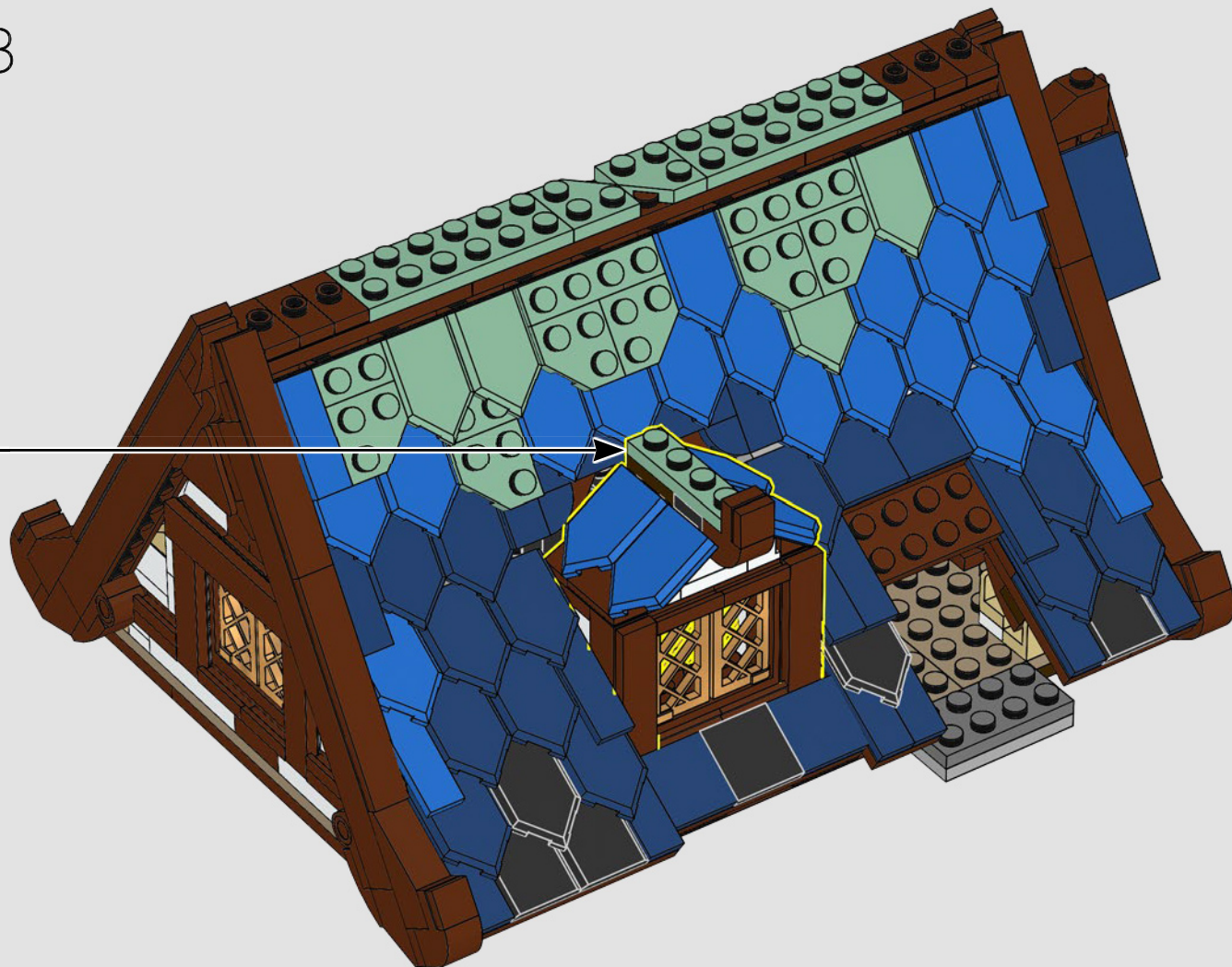

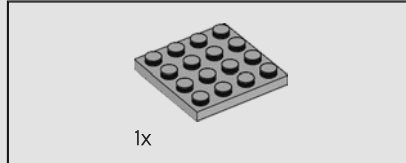
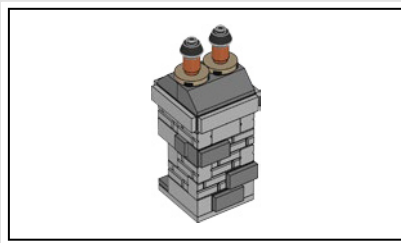
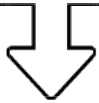

274

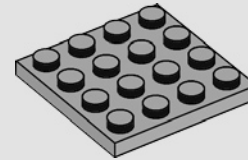

275

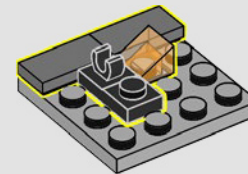

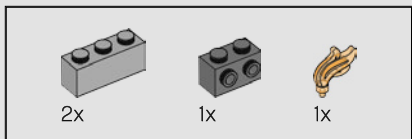

276

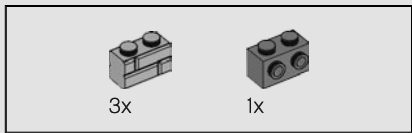
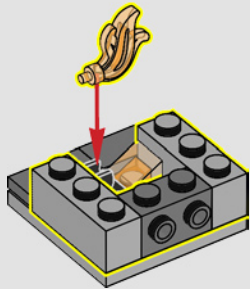

277

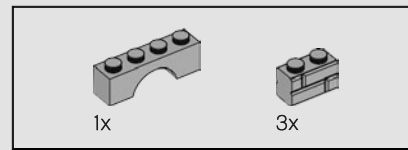
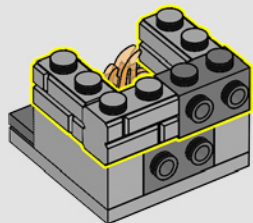

278

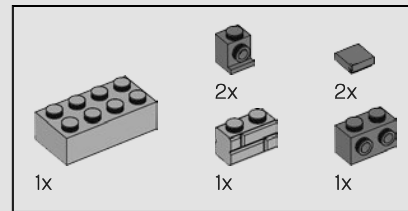
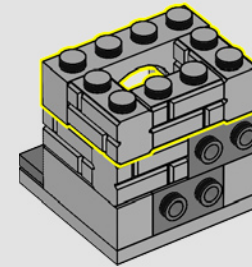

279

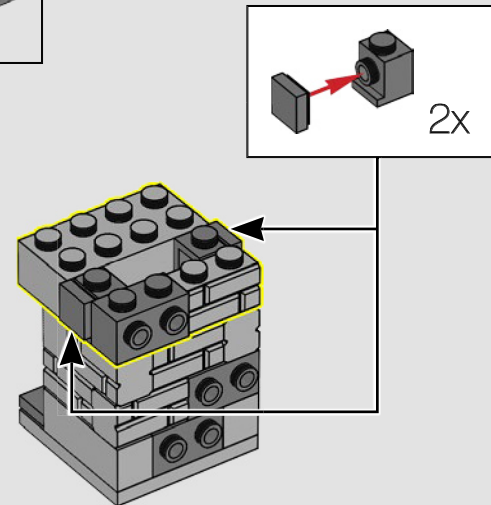

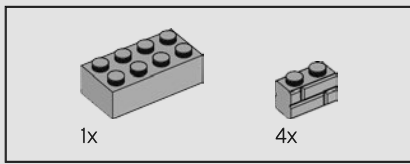

280

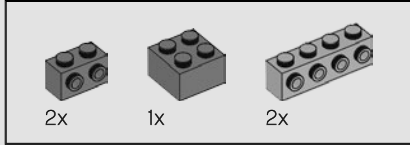
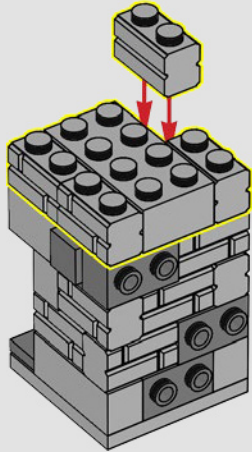

281

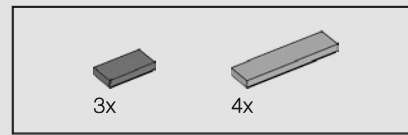
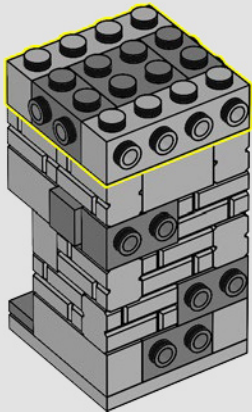

282

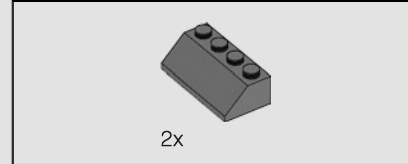
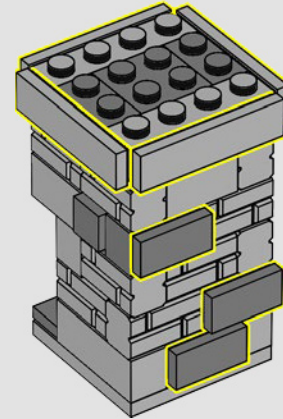

283

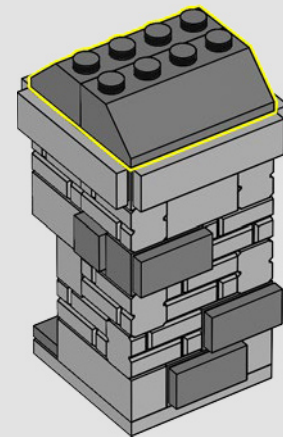



284

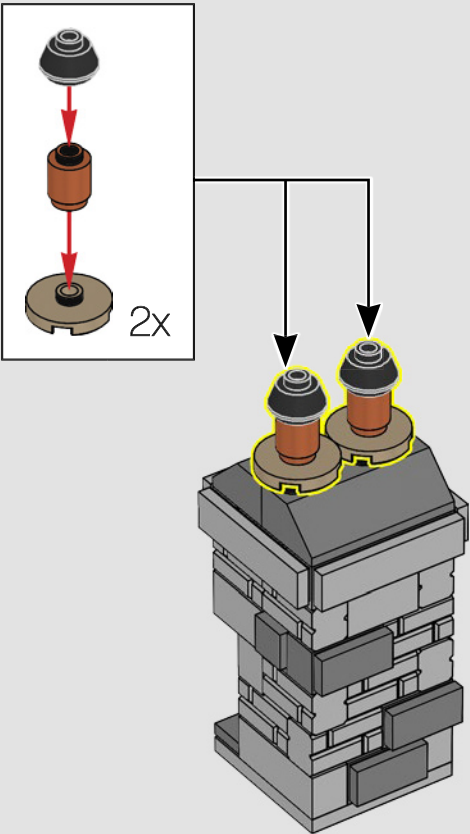

285

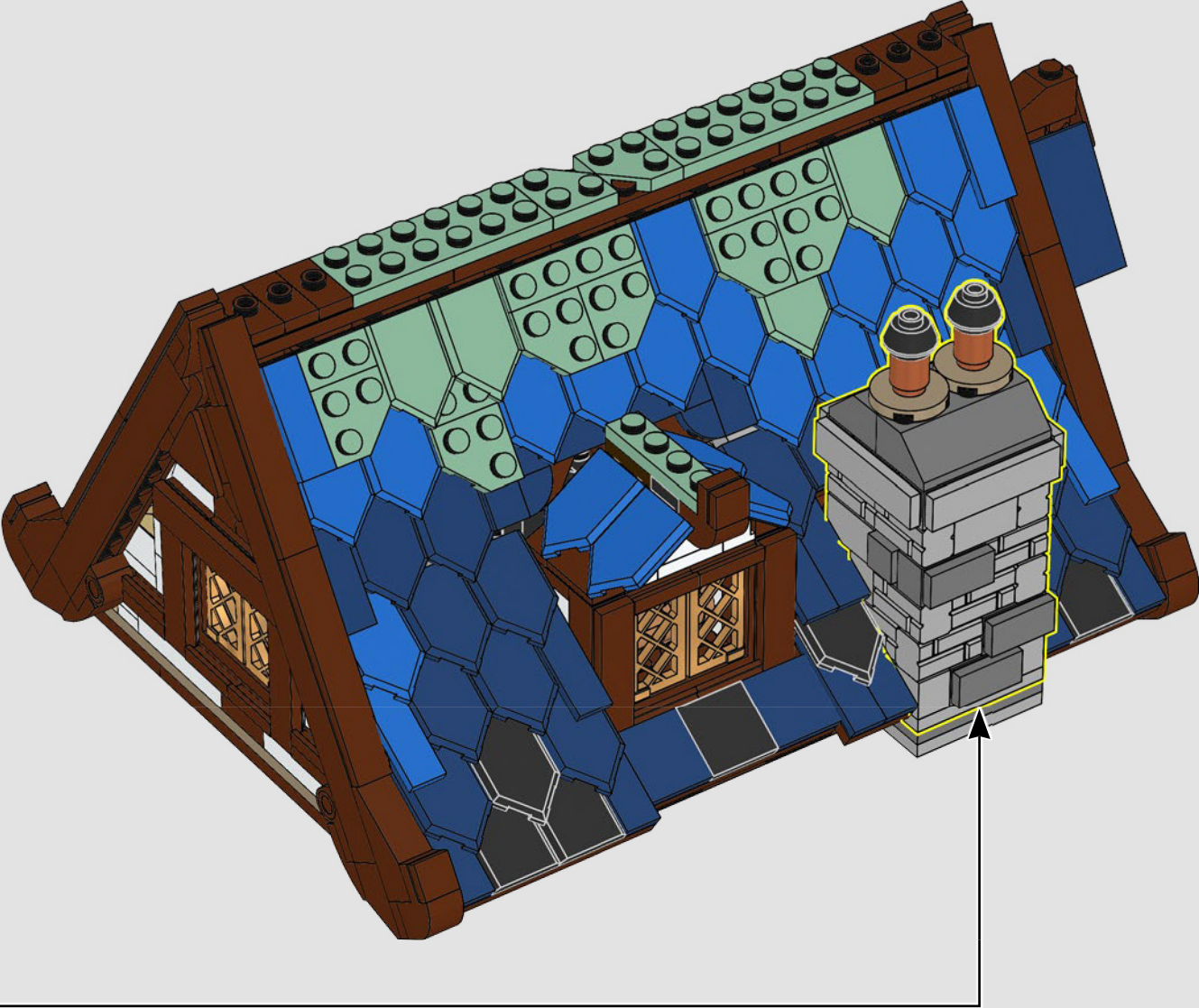

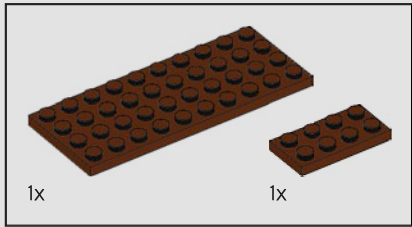
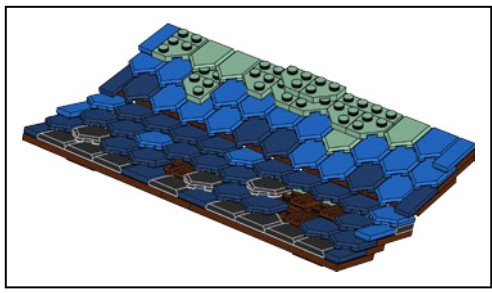

286

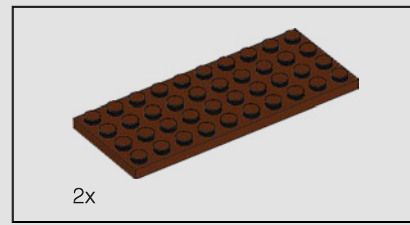
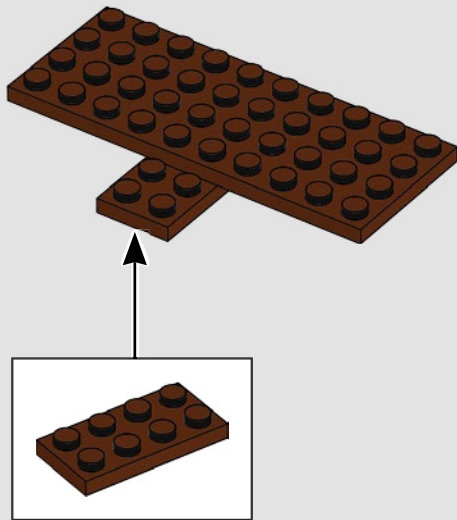

287

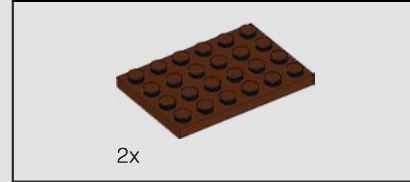
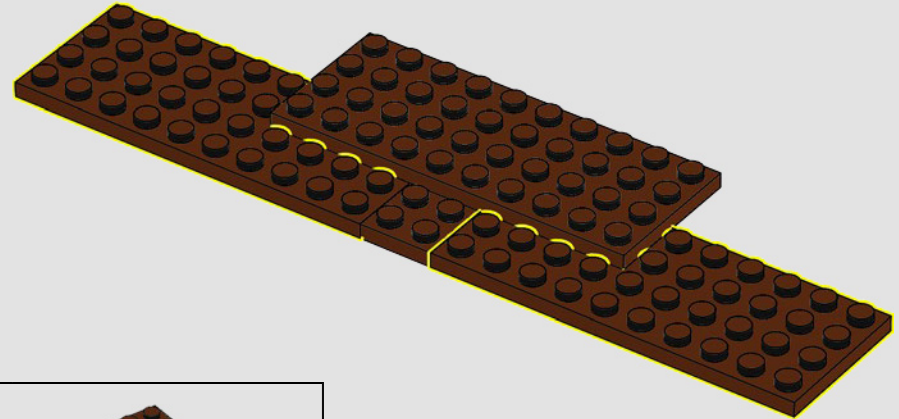

288

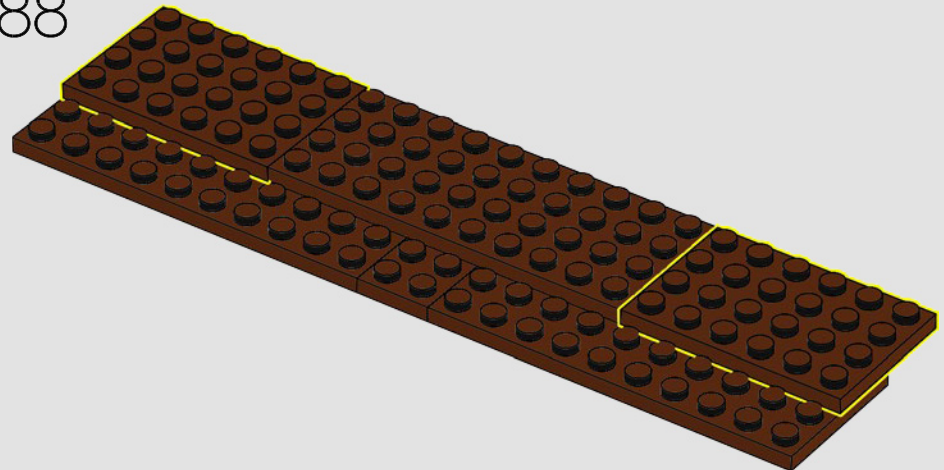

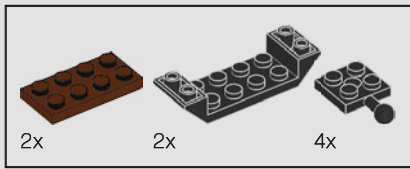

289

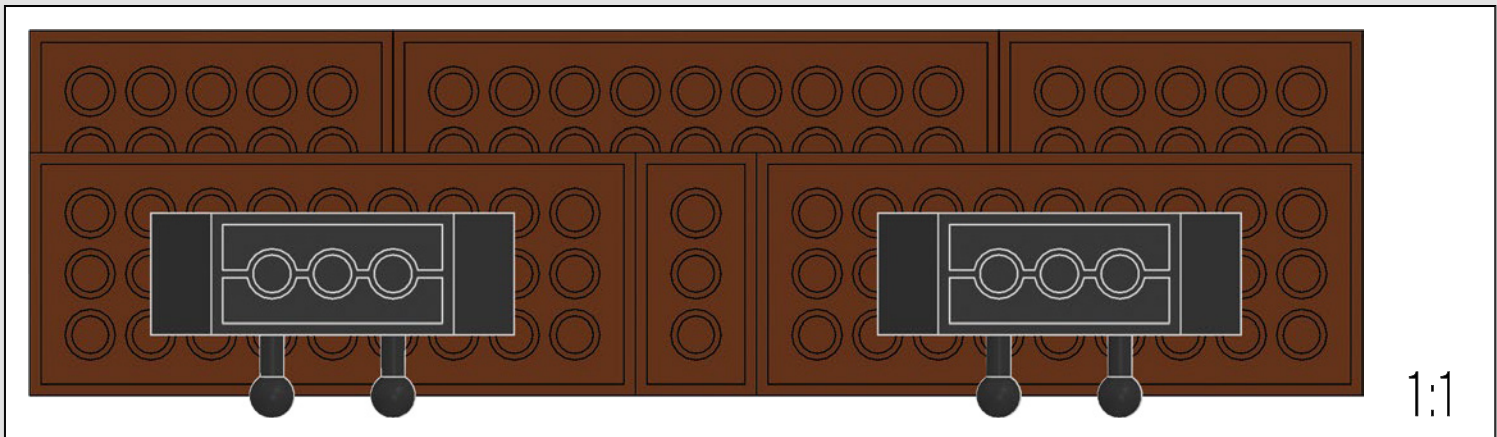
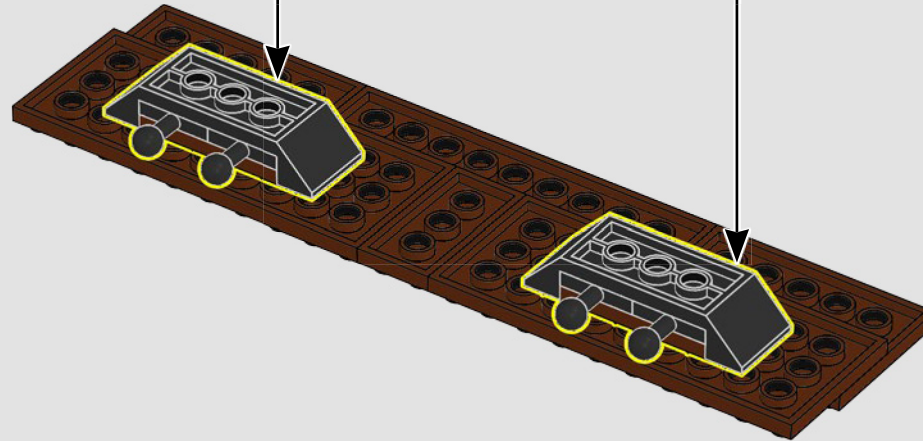
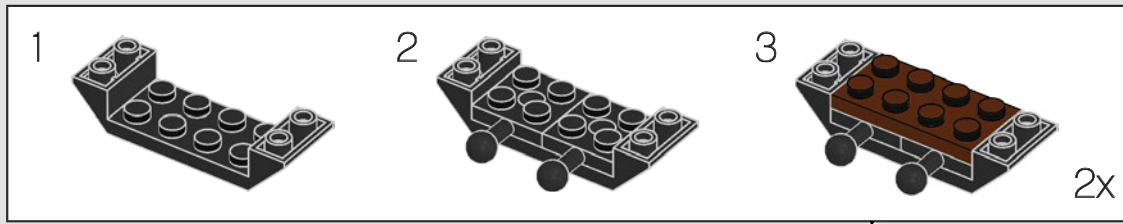



290

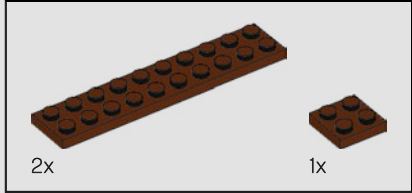
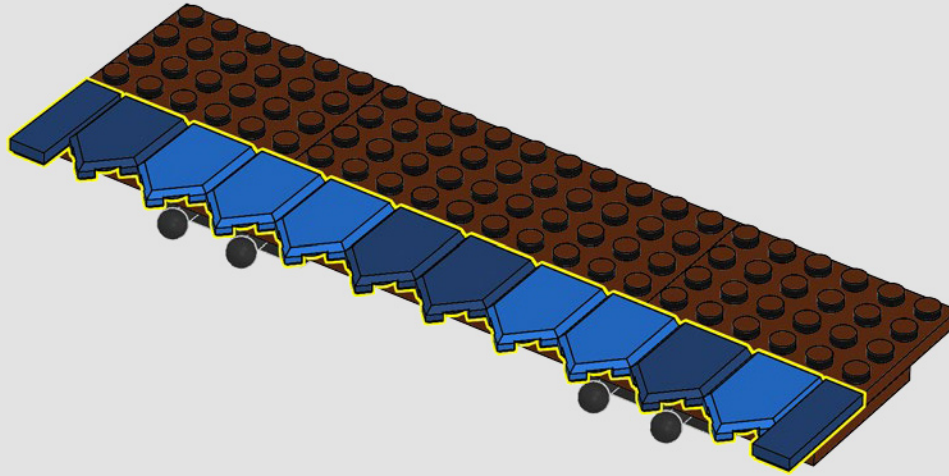

291

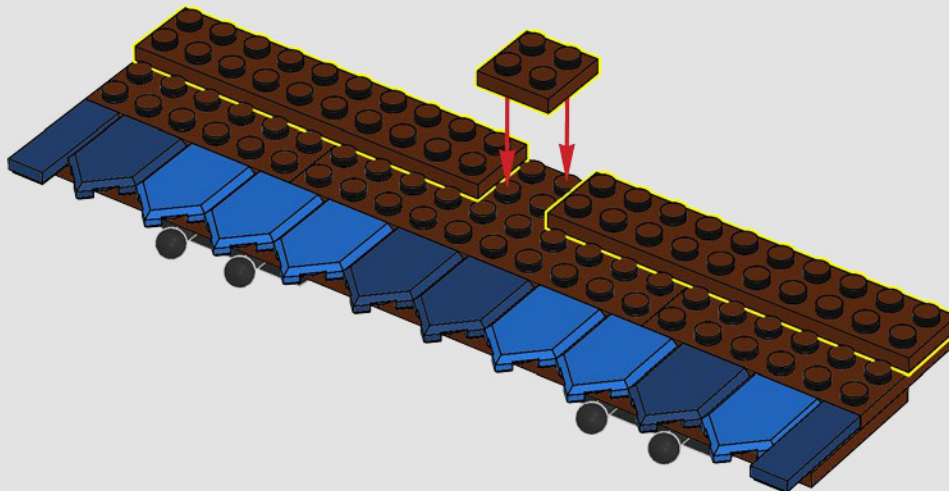

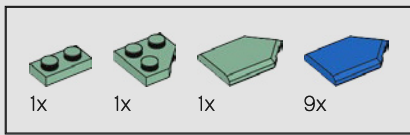

292

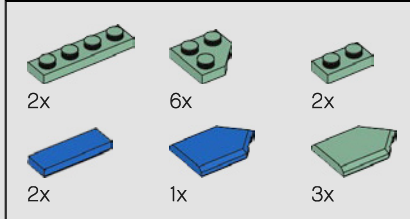
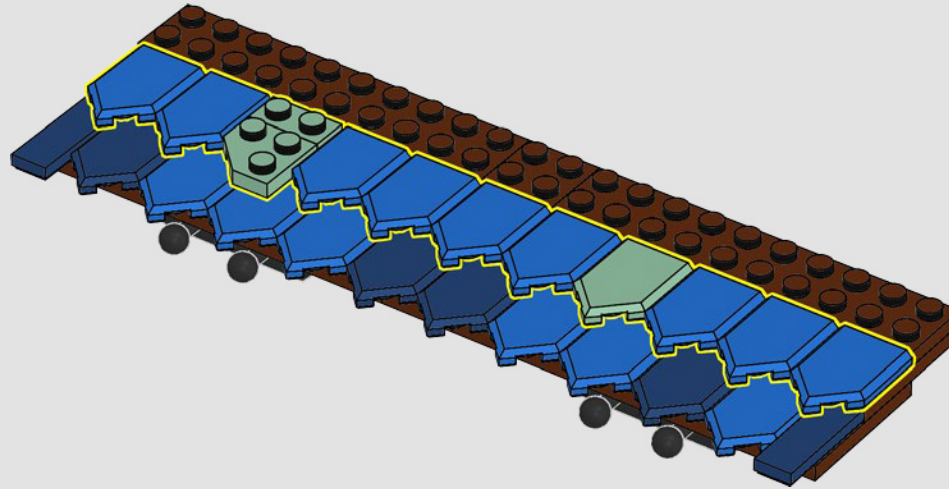

293

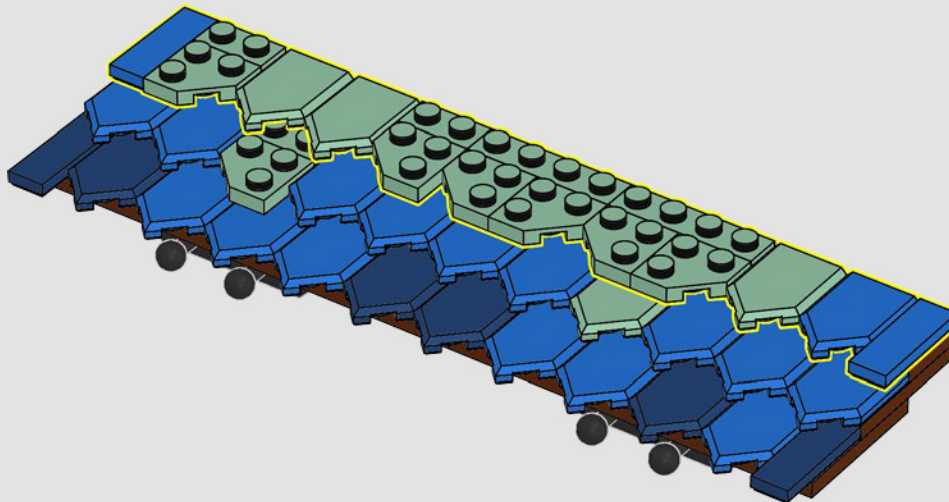



2x

294

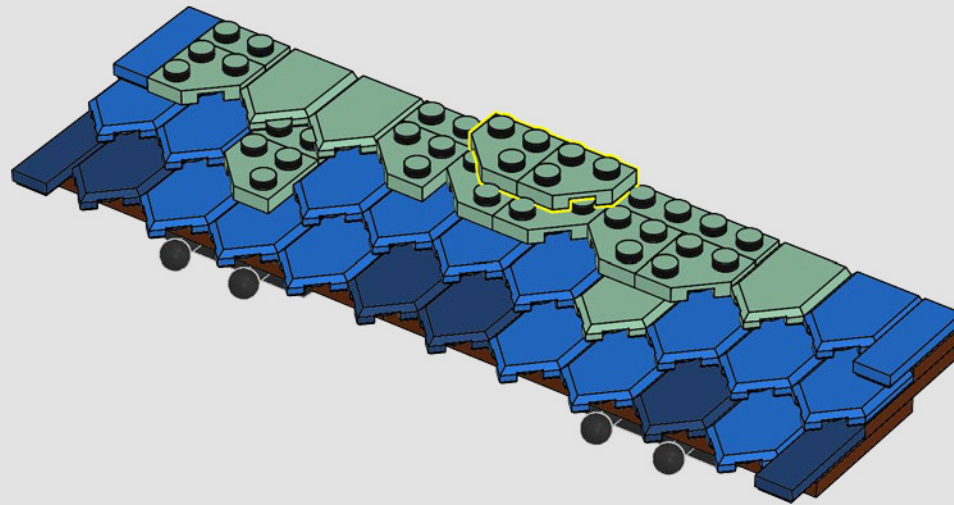

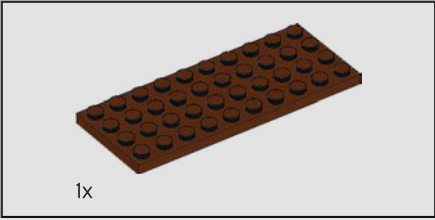
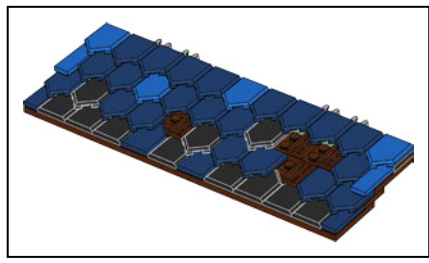

295

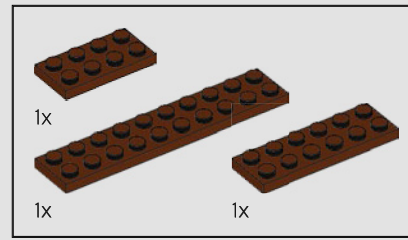
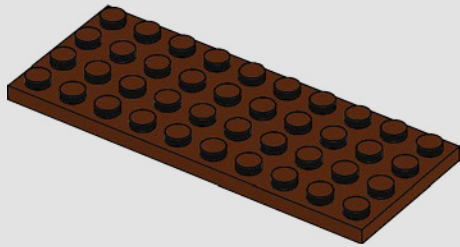

296

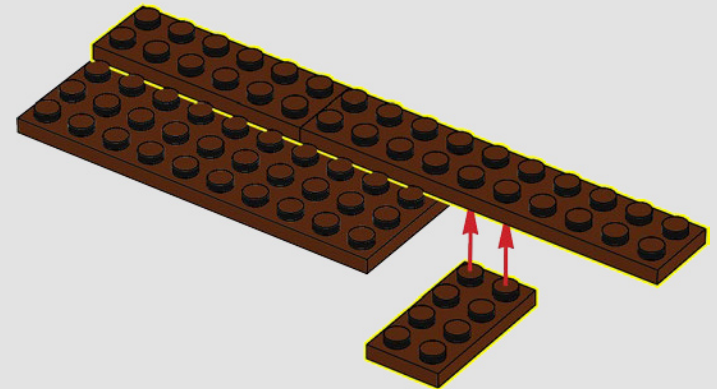

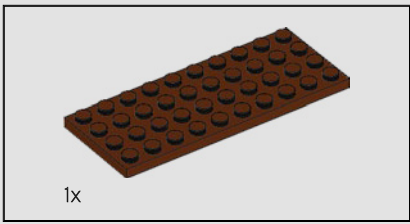

297

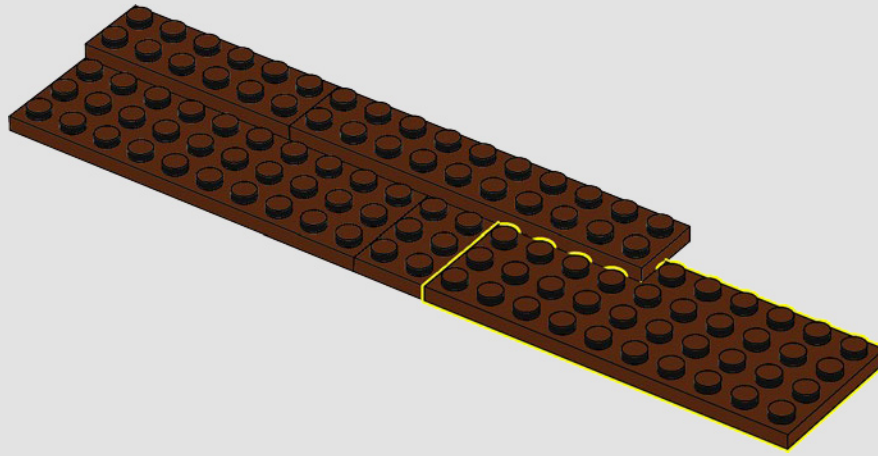

298

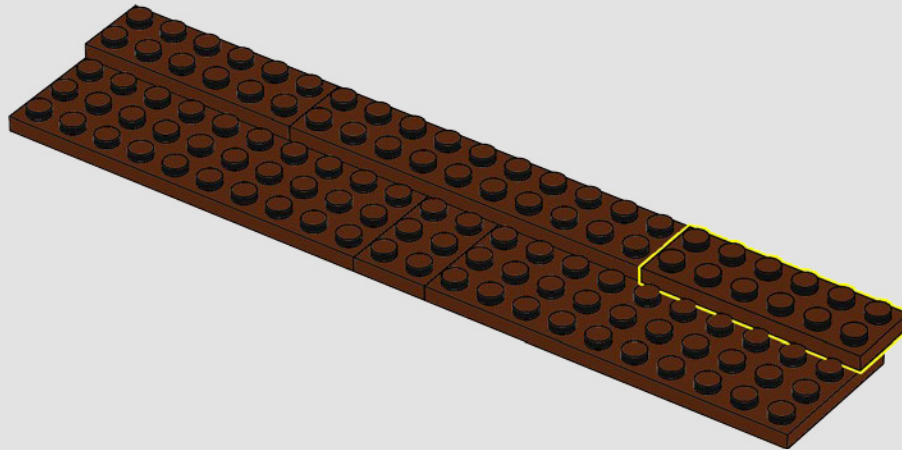



299

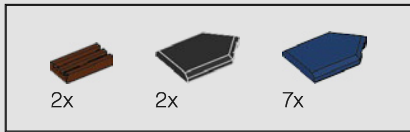
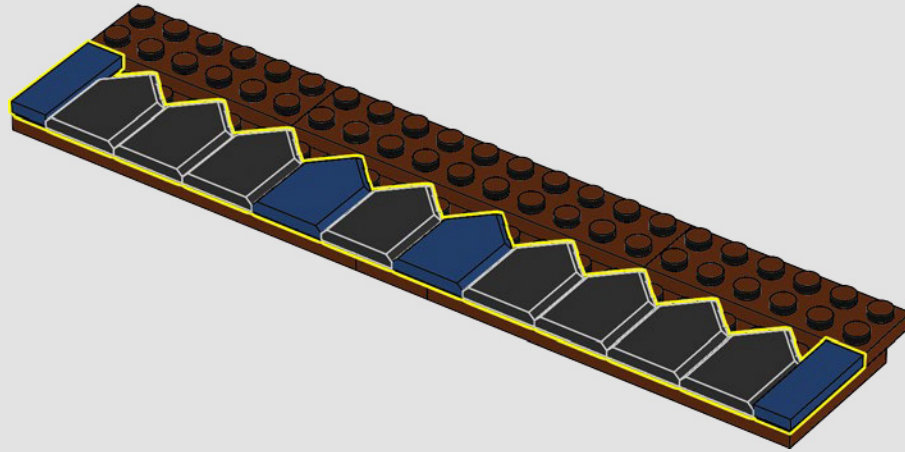

300

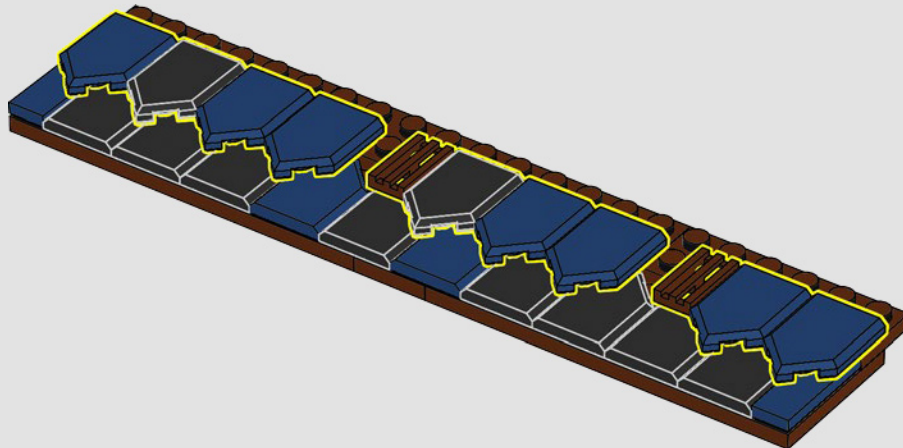

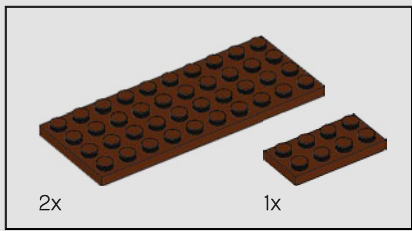

301

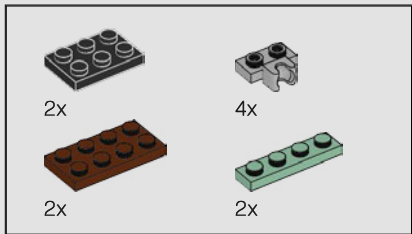
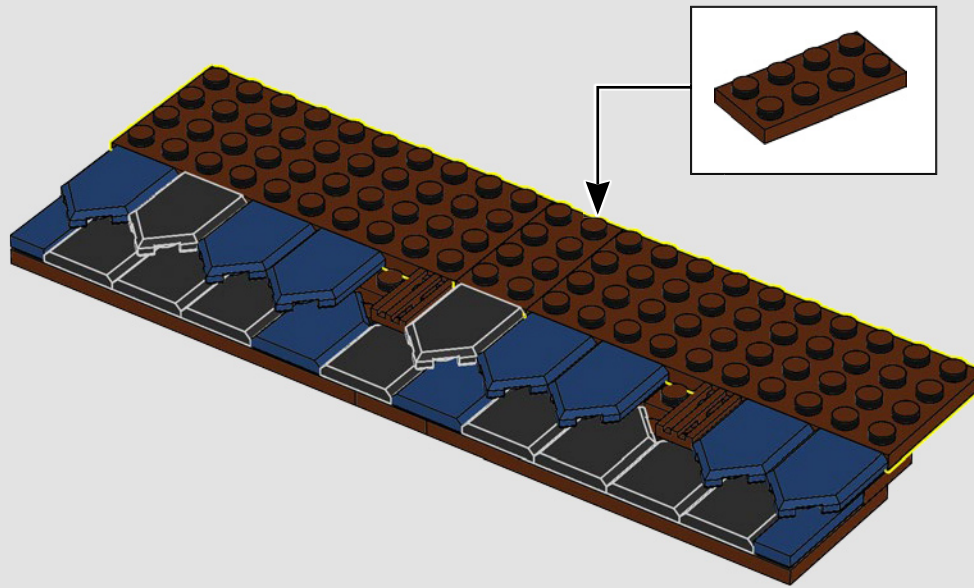

302

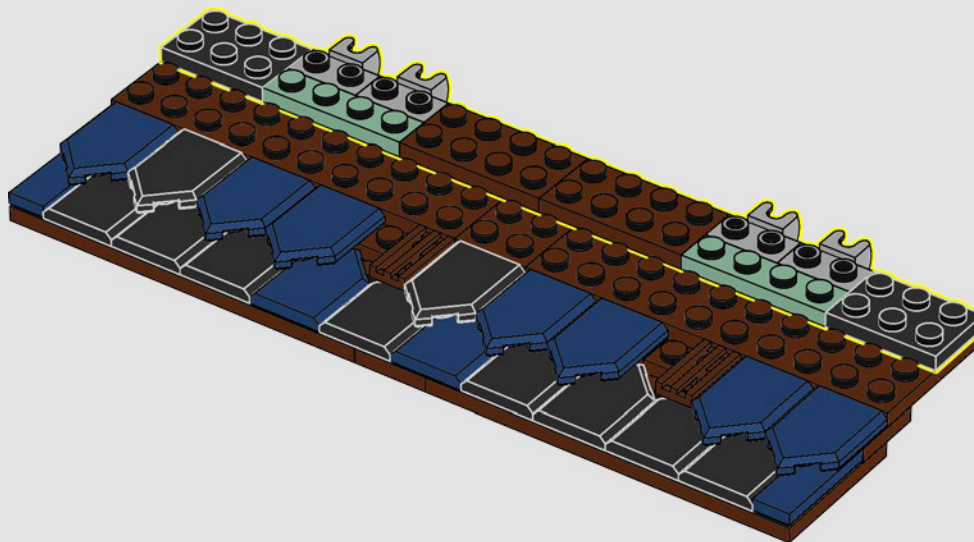

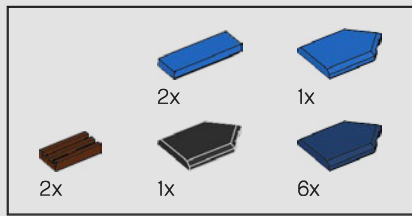

303

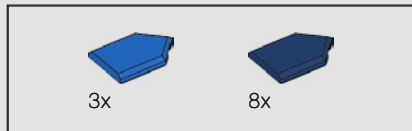
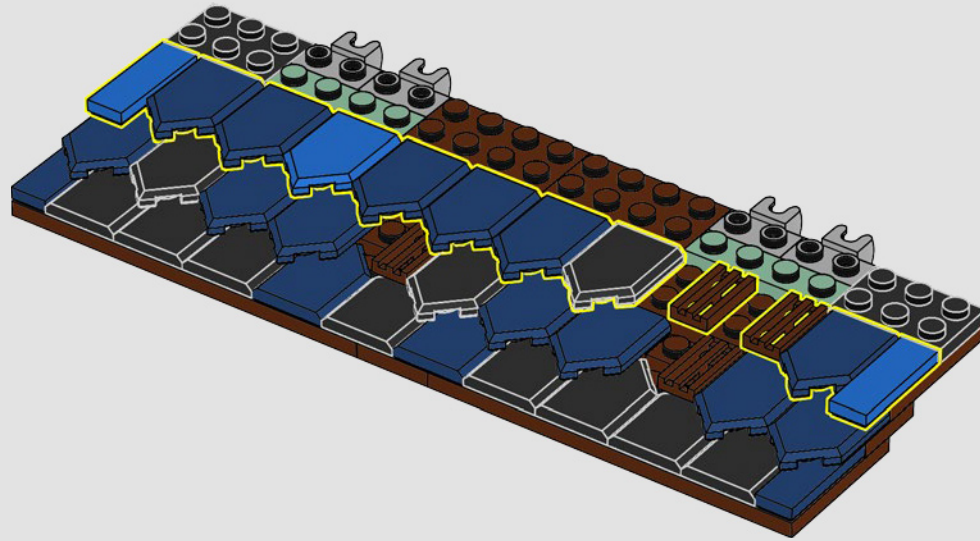

304

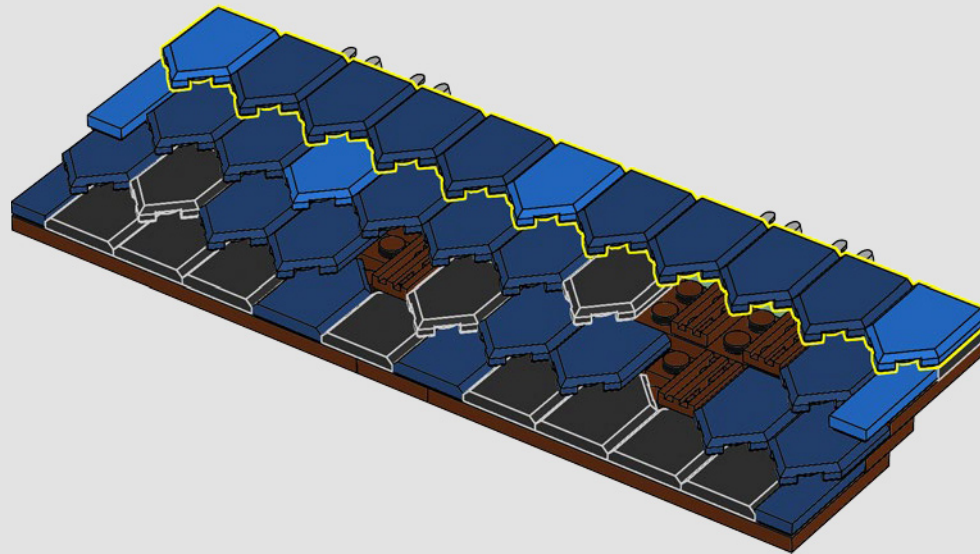

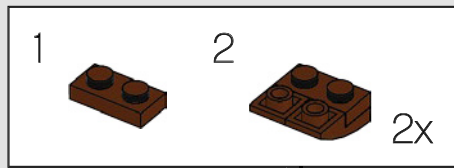
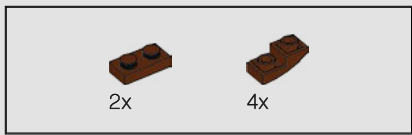

305

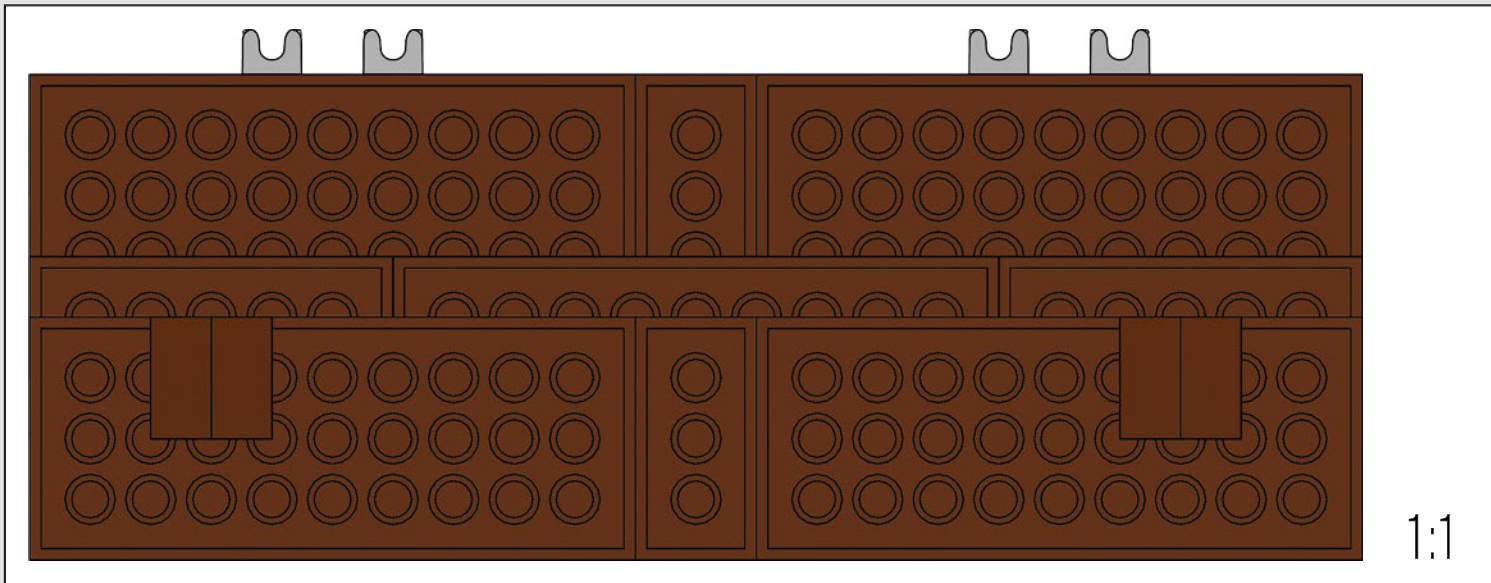
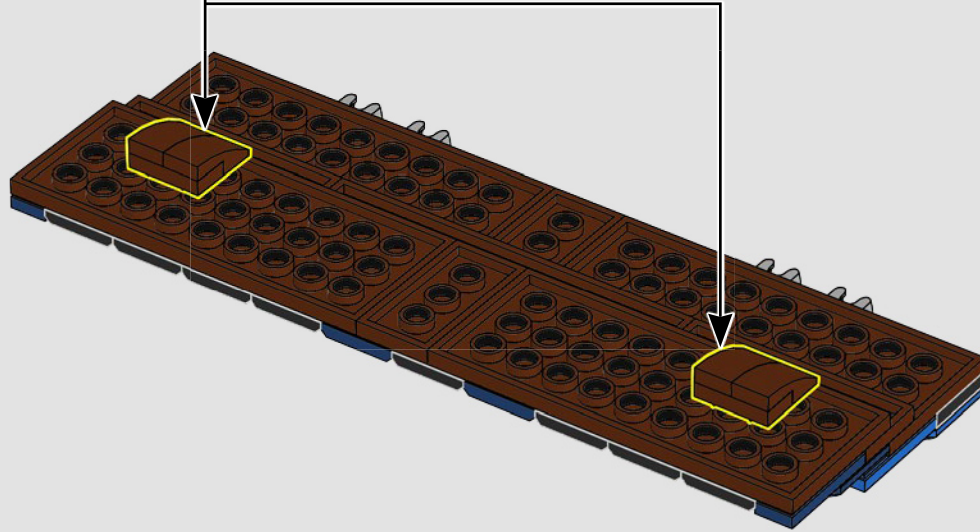

306

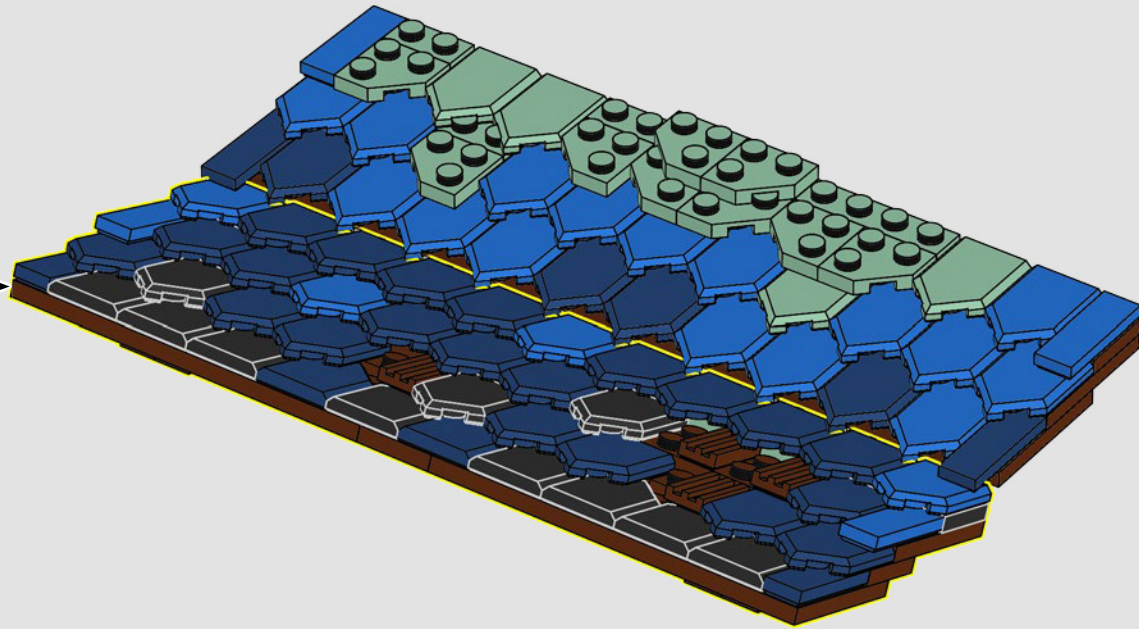

307

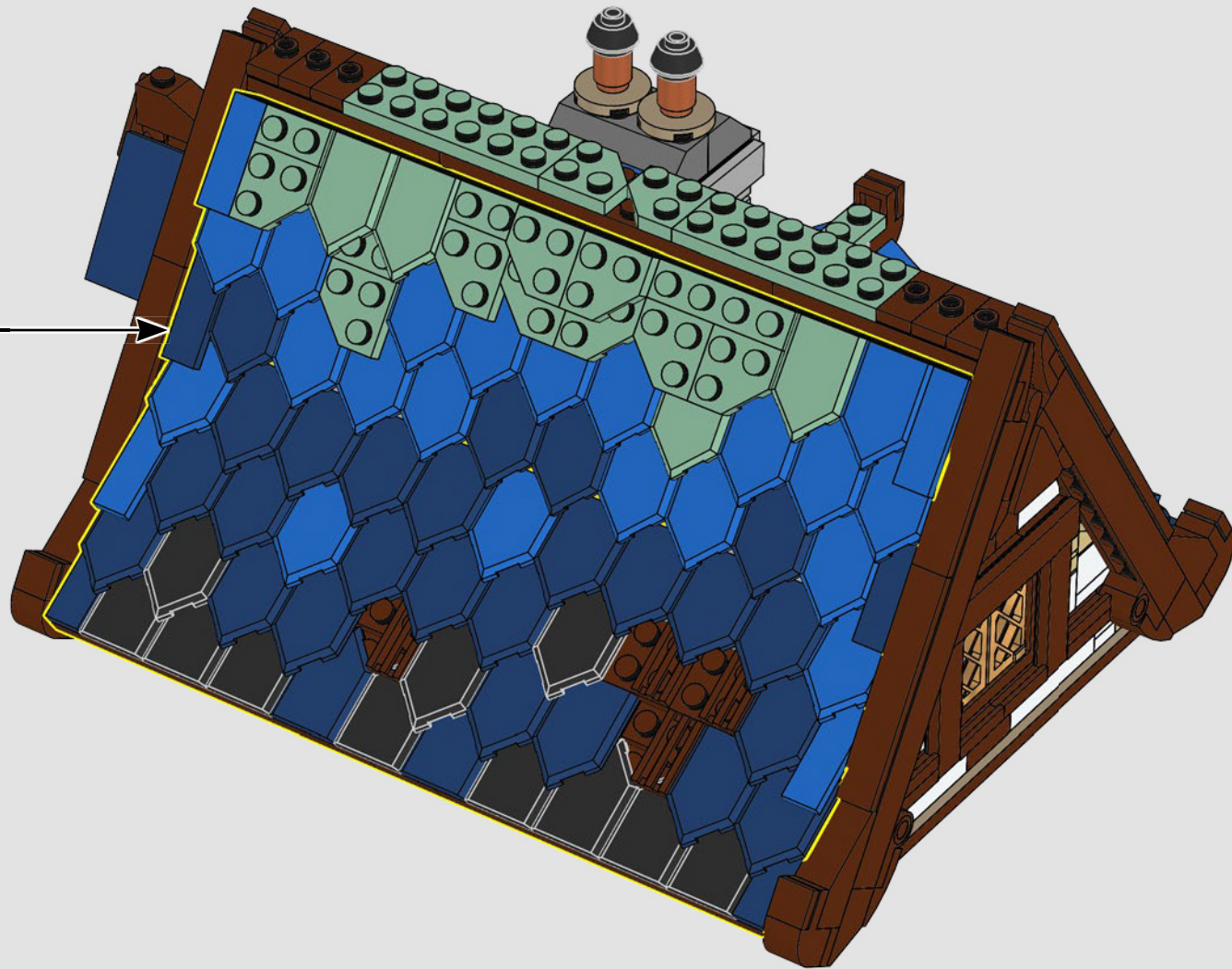

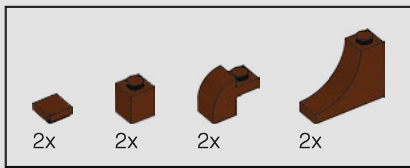

308

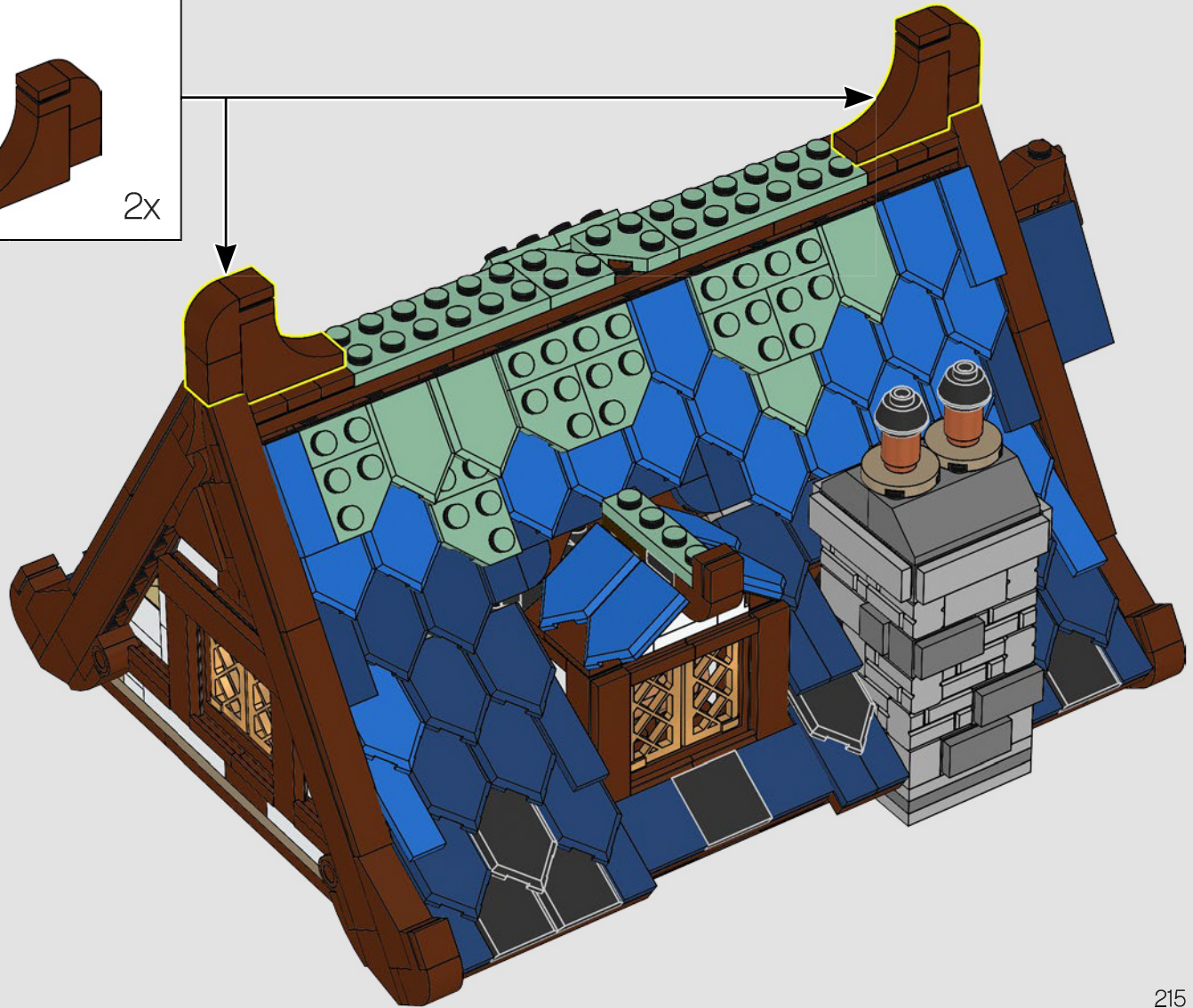
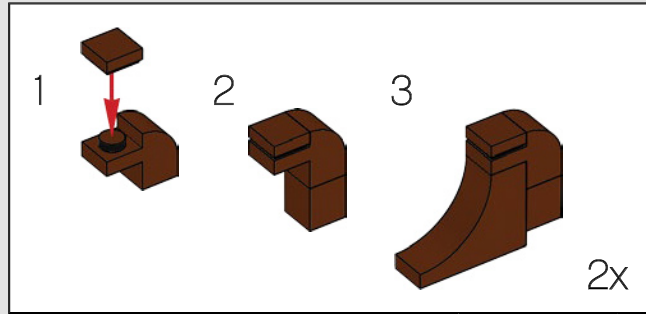

309

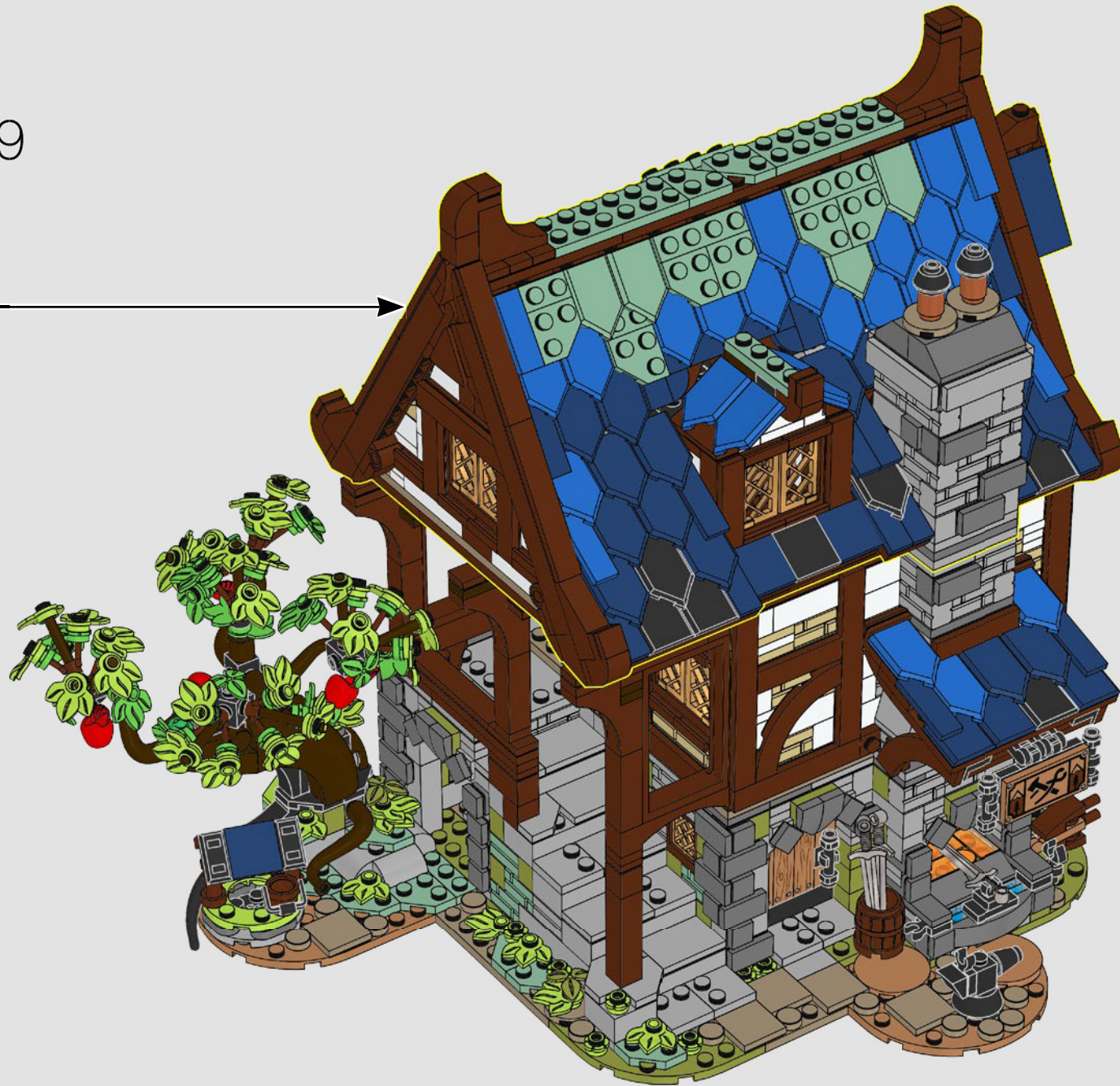

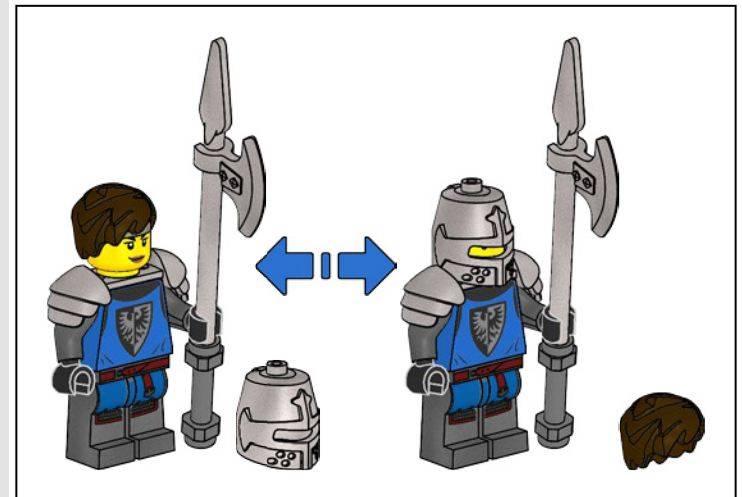
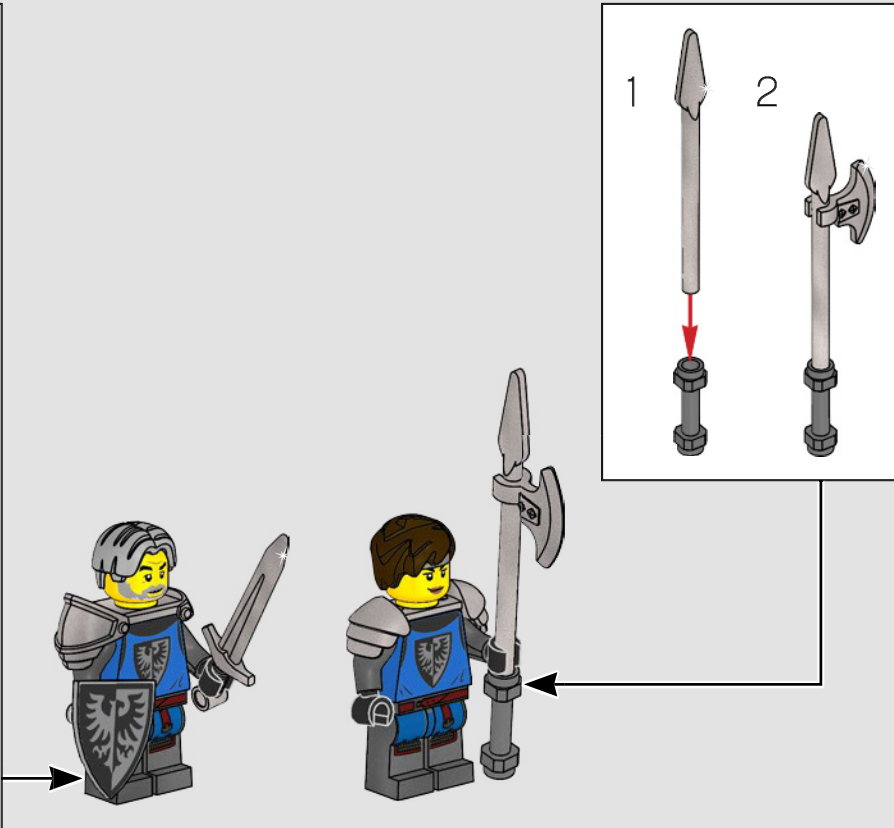
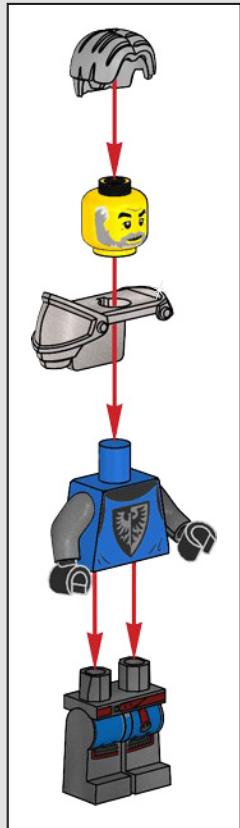
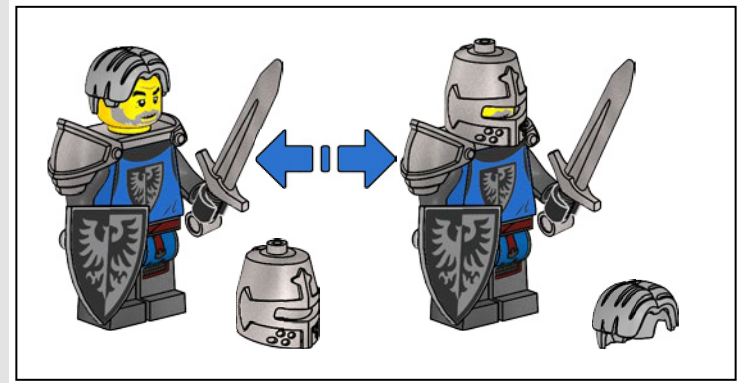
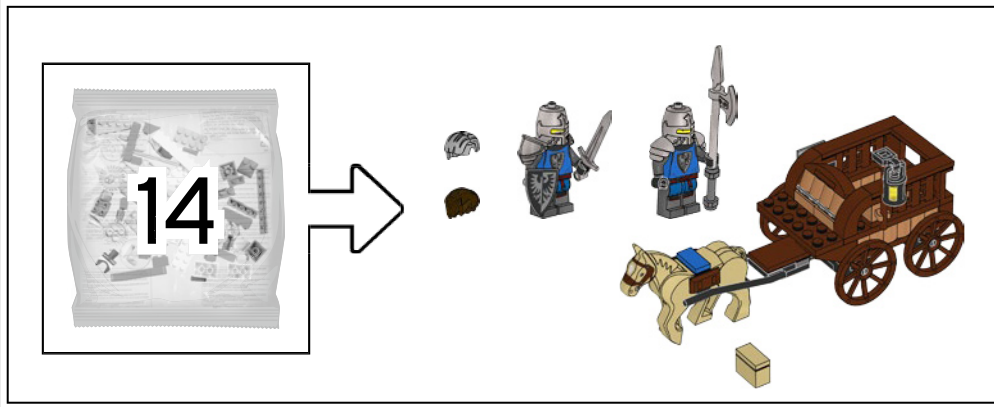

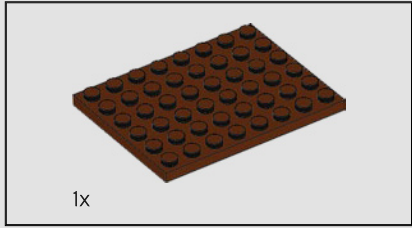
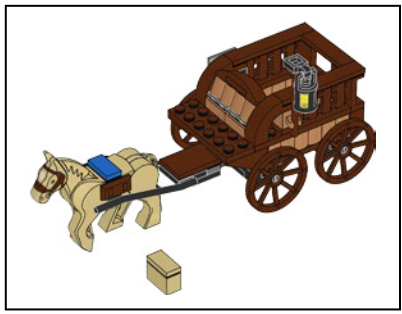

1

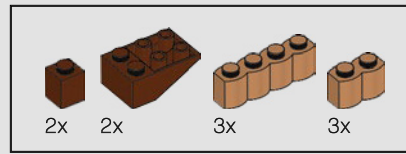
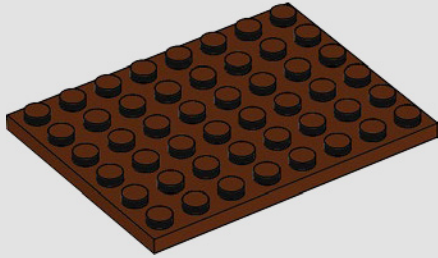

2

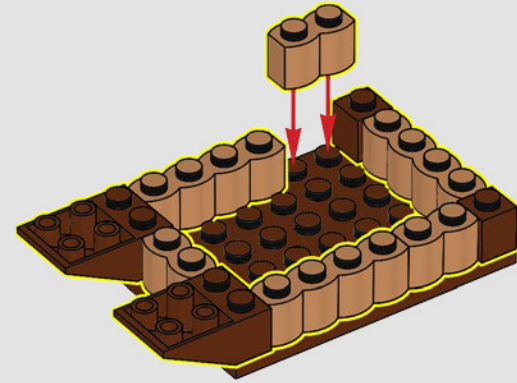



3

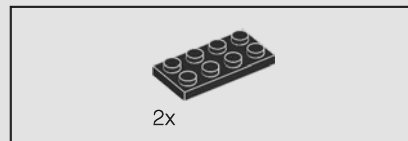
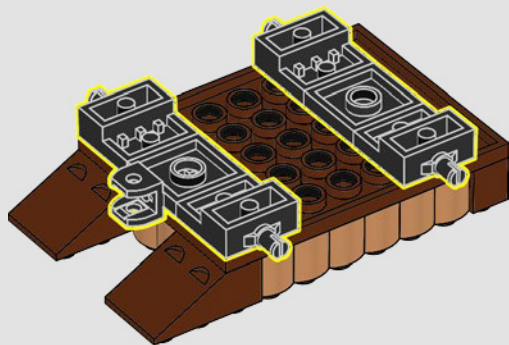

4

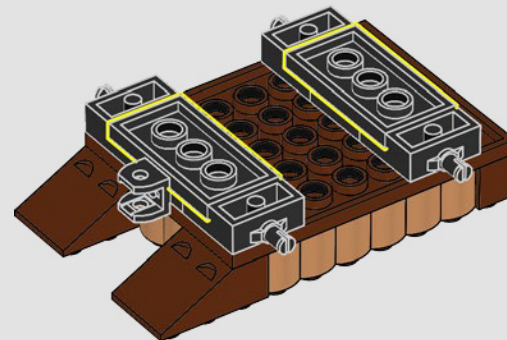

5

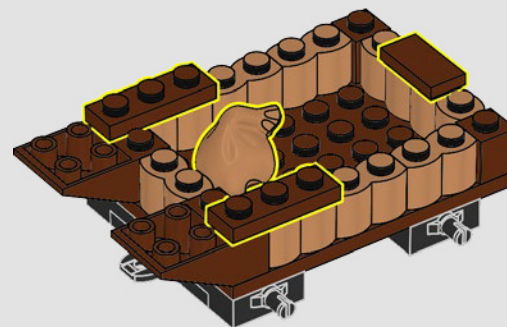

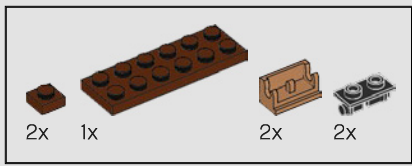

6

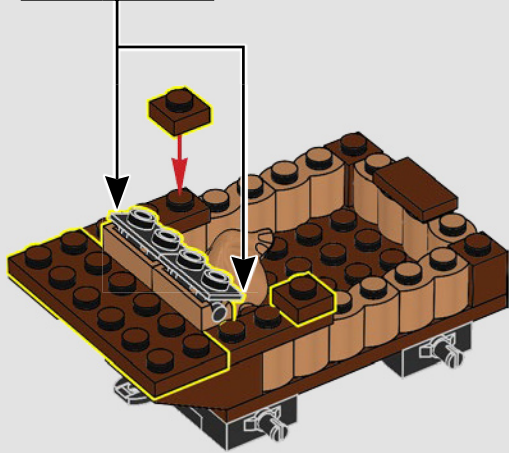
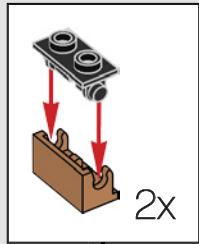

7

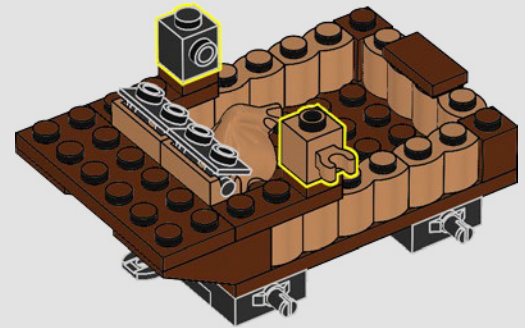

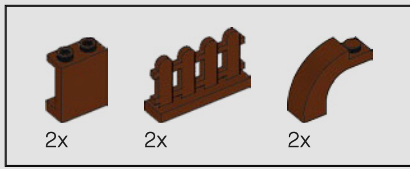

8

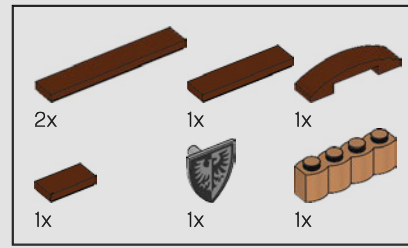
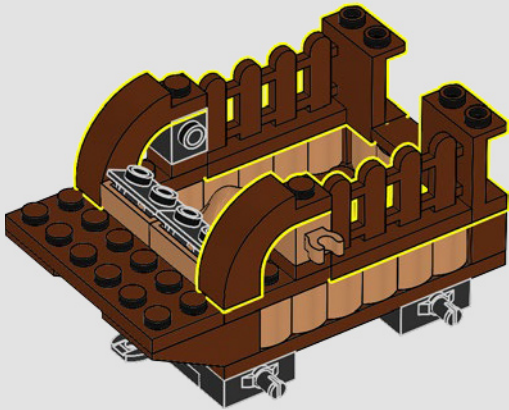

9

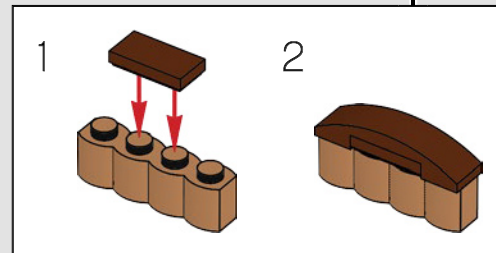
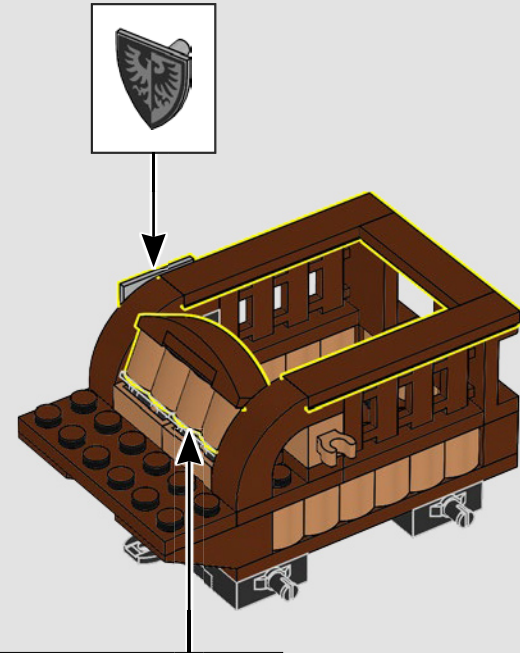

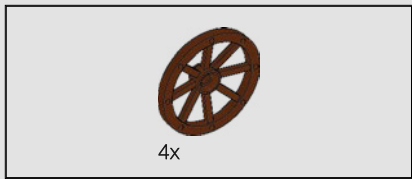

10

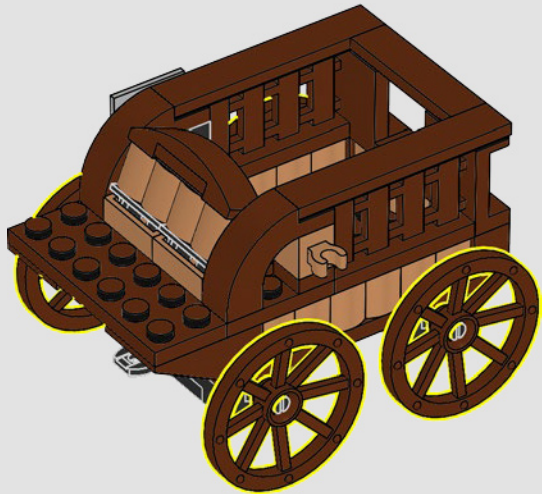

11

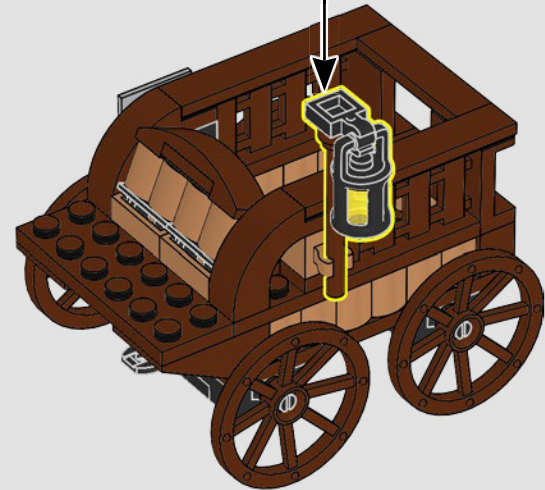
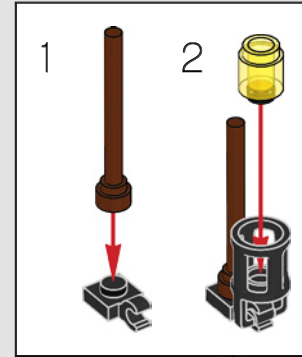

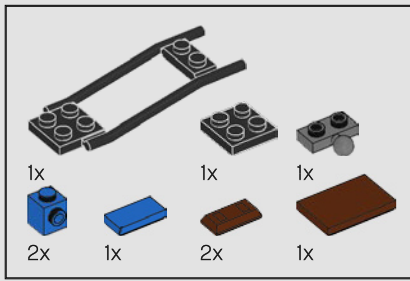

12

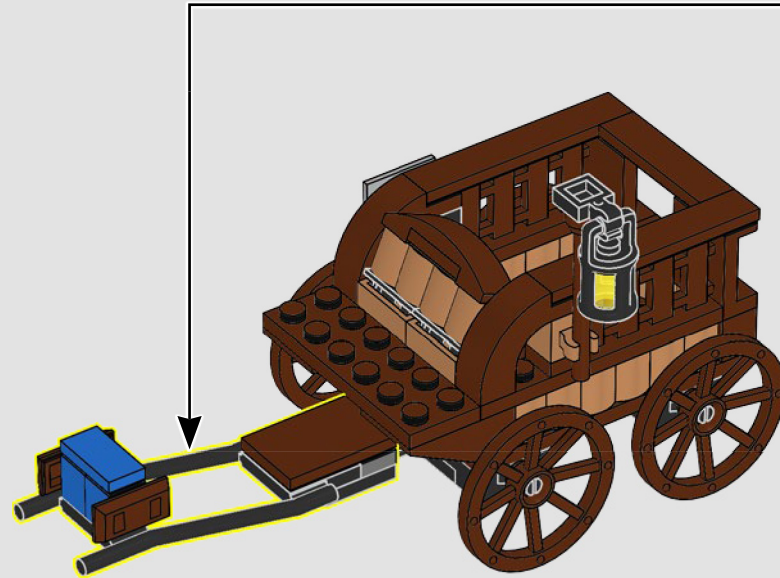
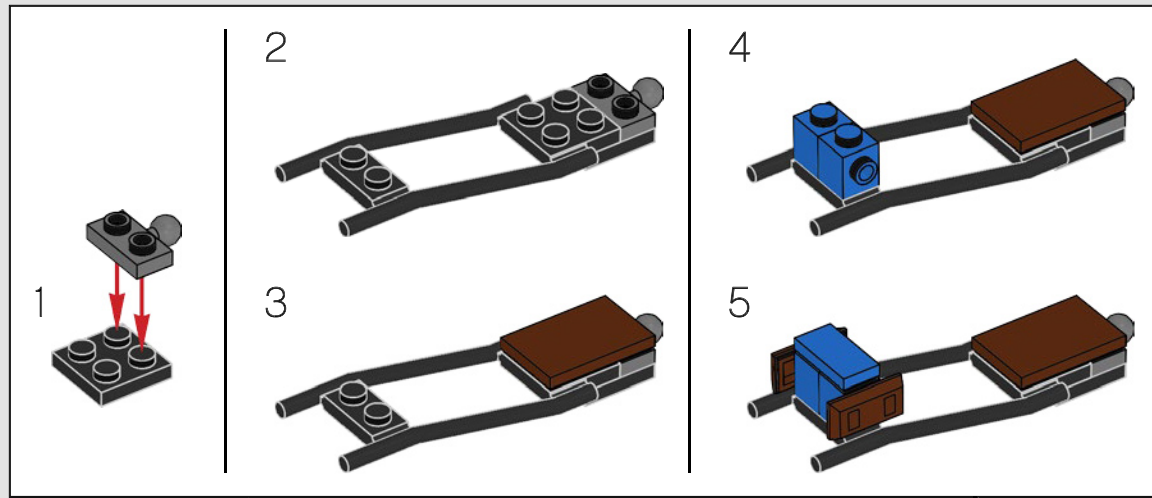

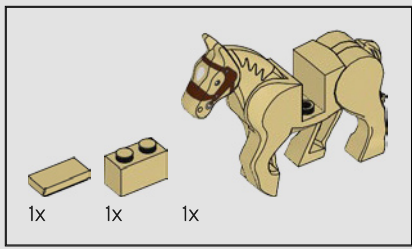

13

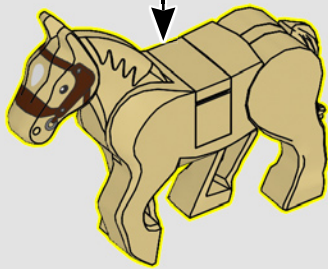
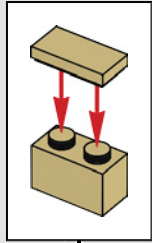

14

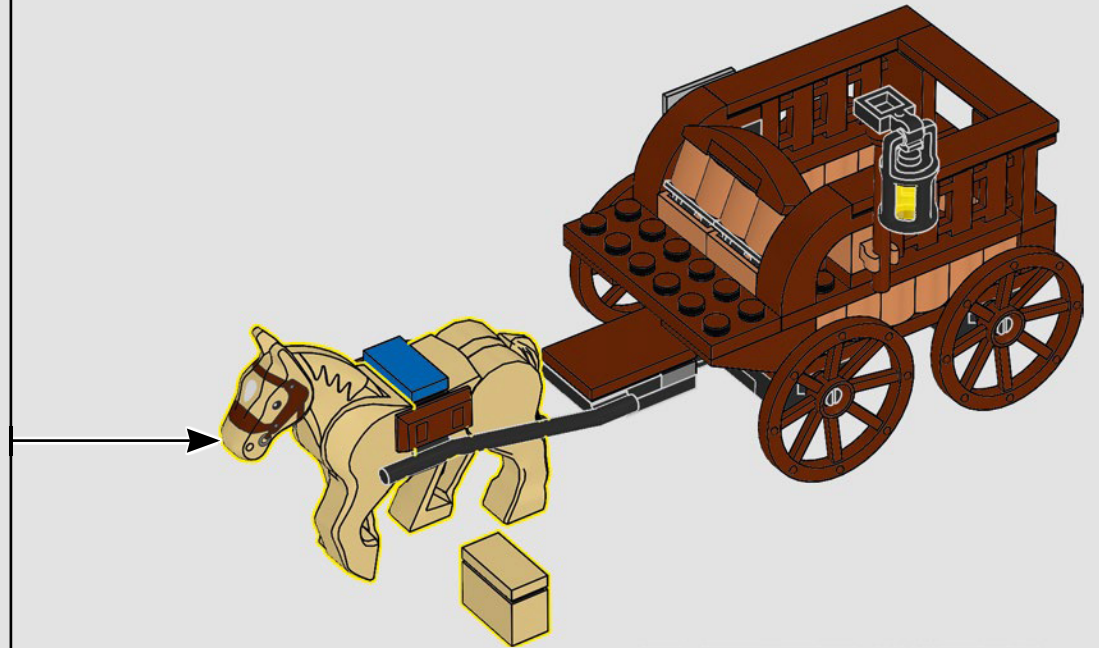



FEEDBACK AND WIN



FEEDBACK AND WIN

Your feedback will help shape the future development of this product series.

Please visit:

FEEDBACK UND GEWINNEN

Dein Feedback trägt zur Weiterentwicklung dieser Produktreihe bei.

Geh auf:

COMMENTEZ ET GAGNEZ

Vos commentaires nous aideront à concevoir les futurs produits de cette gamme.

Rendez-vous sur :

COMENTA Y GANA

Tu opinión nos ayudará a dar forma al desarrollo de esta serie de productos en el futuro.

Visita:

反馈有奖

您的反馈将有助于我们在今后改进本系列产品。

请访问：

[LEGO.com/productfeedback](https://www.lego.com/productfeedback)

By completing, you will automatically enter a drawing to win a LEGO® set.

Terms & Conditions apply.

Durch Ausfüllen nimmst du automatisch an der Verlosung eines LEGO® Preises teil.

Es gelten die Teilnahmebedingungen.

En envoyant vos commentaires, vous serez automatiquement inscrit(e) à un tirage au sort qui vous permettra de remporter un prix LEGO®.

Offre soumise à conditions.

Al contestar, participarás automáticamente en el sorteo y podrás ganar un set LEGO®.

Sujeto a Términos y Condiciones.

完成我们的反馈调查，即可自动进入抽奖环节，赢取乐高®套装。

适用《条款和条件》。



IDEAS

GATHER SUPPORT
HOL DIR UNTERSTÜTZUNG
RASSEMBLE DES VOTES
CHIEDI DI ESSERE SUPPORTATO
GANA APOYOS
OBTÉM APOIO
SZEREZZ TÁMOGATÁST
IEGŪSTI ATBALSTU
获得更多支持

SHARE YOUR IDEA
TEILE DEINE IDEE
PARTAGE TON IDÉE
CONDIVIDI LA TUA IDEA
COMPARTE TU IDEA
PARTILHA A TUA IDEIA
TEDD KÖZZÉ AZ ÖTLETED
DALIES AR SAVU IDEJU
分享您的观点

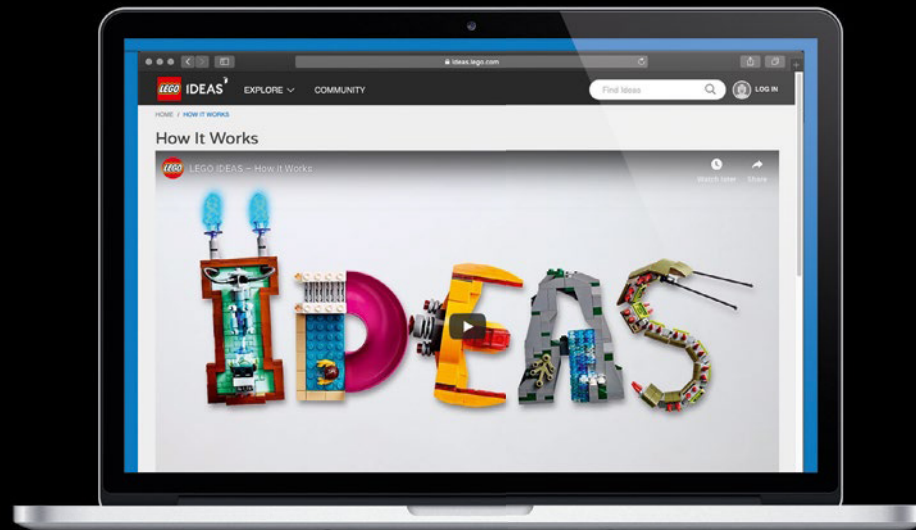
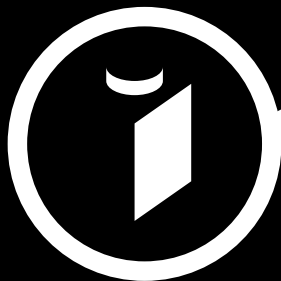
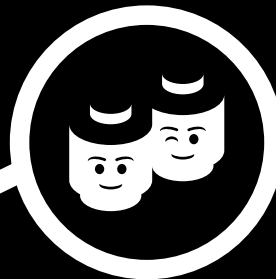

NEW LEGO® PRODUCT
NEUES LEGO® PRODUKT
NOUVEAU PRODUIT LEGO®
NUOVO PRODOTTO LEGO®
NUEVO PRODUCTO LEGO®
NOVO PRODUTO LEGO®
ÚJ LEGO® TERMÉK
JAUNS LEGO® PRODUKTS
新的乐高® 产品

LEGO® REVIEW
LEGO® PRÜFUNG
EXAMEN PAR LEGO®
REVIEW LEGO®
REVISIÓN DE LEGO®
AVALIAÇÃO LEGO®
LEGO® VÉLEMÉNYEZÉS
LEGO® RECENZIA
乐高® 评论

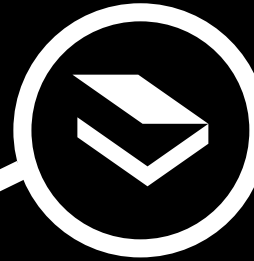

Ideas.LEGO.com

Sesame Street® and associated characters, trademarks and design elements are owned and licensed by Sesame Workshop.
© 2020 Sesame Workshop. All rights reserved.

EN

Important information about batteries

Never use different types of batteries together, or a combination of old and new batteries. Always remove the batteries if the product is not to be used for a long time or if the batteries have run down. Never use damaged batteries. Only use alkaline type batteries. Insert the batteries so that the poles are correctly positioned. Never attempt to recharge non-rechargeable batteries. Never short-circuit the battery holder.

DE

Wichtige Informationen zu Batterien

Benutzen Sie niemals unterschiedliche Arten von Batterien oder alte und neue gleichzeitig. Nehmen Sie stets die Batterien heraus, wenn mit dem Modell längere Zeit nicht gespielt wird oder wenn die Batterien leer sind. Verwenden Sie niemals beschädigte Batterien. Verwenden Sie ausschließlich Alkali-Batterien. Achten Sie beim Einsetzen der Batterien auf die richtige Polung. Versuchen Sie unter keinen Umständen, „normale“ Batterien wieder aufzuladen. Schließen Sie das Batteriefach niemals kurz.

FR

Informations importantes concernant les piles

Ne jamais utiliser un mélange de différents types de piles, ou de piles neuves et de piles anciennes ou déjà utilisées. Toujours retirer les piles si le produit n'est pas utilisé durant une période prolongée ou si les piles sont vides. Ne jamais utiliser de piles endommagées. N'utiliser que des piles alcalines. En insérant les piles, respecter scrupuleusement le sens d'orientation des pôles (+/-). Ne jamais essayer de recharger des piles non rechargeables. Ne jamais court-circuiter le compartiment des piles.

IT

Importanti informazioni sulle batterie

Non usare mai contemporaneamente batterie di tipo diverso o batterie nuove e usate insieme. Rimuovere sempre le batterie qualora il prodotto non venga utilizzato per periodi prolungati, oppure se le batterie sono esauste. Non utilizzare mai batterie danneggiate. Utilizzare solo batterie di tipo alcalino. Inserire le batterie avendo cura che la loro polarità sia corretta. Non tentare mai di ricaricare batterie non ricaricabili. Non cortocircuitare mai il portabatterie.

NL

Belangrijke informatie over batterijen

Gebruik nooit verschillende soorten of een combinatie van oude en nieuwe batterijen tegelijkertijd. Verwijder de batterijen altijd als je het product lange tijd niet wilt gebruiken of als batterijen leeg zijn. Gebruik nooit beschadigde batterijen. Gebruik alleen alkalinebatterijen. Plaats de batterijen met de polen in de juiste richting. Probeer nooit niet-oplaadbare batterijen opnieuw op te laden. Laat de batterijhouder nooit kortsluiten.

ES

Información importante acerca de las pilas

No use pilas de diferentes tipos ni pilas nuevas y antiguas para alimentar el producto. Extraiga las pilas del producto si este va a permanecer sin uso durante un período prolongado de tiempo o aquellas se han agotado. No use pilas dañadas. Use solo pilas alcalinas. Inserte las pilas de modo que los polos queden situados en las posiciones correctas. No trate de cargar pilas no recargables. No cortocircuite el compartimento de las pilas.

DA

Vigtige oplysninger om batterier

Brug aldrig forskellige batterityper sammen eller en kombination af gamle og nye batterier. Fjern altid batterierne, hvis produktet ikke skal bruges i lang tid, eller hvis batterierne er flade. Brug aldrig beskadigede batterier. Brug kun alkaliske batterier. Sæt batterierne i, så polerne vender den rigtige vej. Forsøg aldrig at oplade ikke-genopladelige batterier. Kortslut aldrig batteriholderen.

IS

Mikilvægar upplýsingar um rafhlöður

Aldrei skal nota mismunandi gerðir rafhlaðna samtímis, né nýjar og eldri rafhlöður samtímis. Ef ekki á að nota tækið í lengri tíma eða ef rafhlöðurnar eru orðnar tómar skal fjarlægja rafhlöðurnar. Aldrei skal nota rafhlöður sem hafa skemmt. Eingöngu má nota alkaline-rafhlöður. Setja skal rafhlöðurnar í þannig að plús- og mínusskaut þeirra snúi rétt. Aldrei skal reyna að endurhlaða rafhlöður sem ekki eru endurhlaðanlegar. Aldrei ætti að valda skammhlaupi í rafhlöðuhöfnu.

FI

Tärkeää tietoa paristoista

Älä koskaan käytä erityyppisiä paristoja yhdessä. Älä myöskään käytä samassa laitteessa sekä vanhoja että uusia paristoja. Poista paristot tuotteen ainoastaan, kun se on pitemmän aikaa käyttämättä, tai kun paristot ovat tyhjentyneet. Älä koskaan käytä viallisia paristoja. Käytä vain alkaliparistoja. Aseta paristot siten, että navat osoittavat oikeaan suuntaan. Älä koskaan aiheuta oikosulkua pariston kosketintien välillä.

SV

Viktig information om batterier

Använd aldrig olika sorters batterier samtidigt, och inte heller en kombination av gamla och nya batterier. Ta alltid ur batterierna om produkten inte ska användas under en längre tid eller om batterierna är slut. Använd aldrig skadade batterier. Använd endast alkaliska batterier. Sätt i batterierna så att polerna hamnar i rätt läge. Försök aldrig ladda icke-laddningsbara batterier. Kortslut aldrig batteriutrymmets kontaktytor.

NO

Viktig informasjon om batterier

Bruk aldri ulike typer batterier sammen og heller aldri gamle og nye batterier sammen. Ta alltid ut batteriene hvis produktet ikke skal brukes på lang tid, eller hvis batteriene er brukt opp. Bruk aldri skadde batterier. Bruk bare alkaliske batterier. Sett inn batteriene med polene vendt riktig vei. Forsøk aldri å lade opp ikke-oppladbare batterier. Kortslett aldri batteriholderen.

PT

Informação importante sobre as pilhas

Nunca use diferentes tipos de pilhas em simultâneo, ou uma combinação de pilhas usadas e novas. Retire sempre as pilhas se o produto não for usado durante muito tempo ou se as pilhas já não tiverem carga. Nunca use pilhas danificadas. Use apenas pilhas alcalinas. Insira as pilhas de forma a que os polos fiquem corretamente posicionados. Nunca tente recarregar pilhas não recarregáveis. Nunca deixe o compartimento das pilhas entrar em curto-circuito.

EL

Σημαντικές πληροφορίες για τις μπαταρίες

Μην χρησιμοποιείτε ποτέ διαφορετικούς τύπους μπαταριών μαζί και μην συνδυάζετε παλιές και καινούργιες μπαταρίες. Αφαιρείτε πάντα τις μπαταρίες αν δεν σκοπεύετε να χρησιμοποιήσετε το προϊόν για αρκετό καιρό ή αν οι μπαταρίες έχουν αδειάσει. Ποτέ μην χρησιμοποιείτε μπαταρίες που έχουν φθορές. Χρησιμοποιείτε μόνο αλκαλικές μπαταρίες. Τοποθετήστε τις μπαταρίες με τους πόλους στη σωστή θέση. Μην επιχειρήσετε ποτέ να επαναφορτίσετε μη επαναφορτιζόμενες μπαταρίες. Ποτέ μην βραχυκυκλώνετε τη θήκη των μπαταριών.

JA

電池取扱いに関する重要事項

異なるタイプの電池や古い電池を混ぜて使用しないでください。商品を長時間使用しないときや電池が切れたときは、電池を必ず取り外してください。不具合のある電池は絶対に使用しないでください。アルカリタイプの電池のみを使用してください。電極を確認して電池を正しい向きに入れてください。充電式ではない電池は絶対に充電しないでください。電池ホルダをショートさせないでください。

ZH

电池使用注意事项

请勿同时使用不同类型的电池，或把新旧程度不同的电池混合使用。如果产品将有很长时间不会使用，或者电池已经没电，请注意取出电池。切勿使用已破损的电池。仅可使用碱性电池。装入电池时请注意正负极。请勿尝试给非充电电池充电。切勿对电池仓进行短路连接。

KO

배터리 사용 시 주의사항

다른 종류의 배터리를 함께 사용하거나, 새 전지와 오래된 전지를 혼용하지 마세요. 배터리가 방전되었거나 장기간 제품을 작동하지 않을 때에는 반드시 배터리를 분리하세요. 파손된 배터리는 사용하지 마세요. 알칼라인 타입의 배터리만을 사용하세요. 양극과 음극의 위치를 잘 맞춰서 넣으세요. 일반 배터리는 충전해서 사용할 수 없습니다. 배터리 홀더의 접촉부에 배터리를 정확히 끼워서 사용하세요.

RU

Необходимая информация об элементах питания

Ни в коем случае не используйте одновременно элементы питания различных типов, а также элементы питания с разным сроком годности. В обязательном порядке вынимайте элементы питания из терминалов в случае, если вы не пользуетесь прибором в течение долгого времени, либо в случае, если в элементах питания закончился заряд. Ни в коем случае не используйте поврежденные элементы питания. Используйте только элементы питания щелочного типа. Установите элементы питания, соблюдая указанную полярность. Ни в коем случае не пытайтесь подзаряжать неперезаряжаемые элементы питания. Ни в коем случае не пытайтесь замкнуть полюса в устройстве для элементов питания.

PL

Ważne informacje dotyczące baterii

Nigdy nie należy stosować razem różnych rodzajów baterii ani stosować równocześnie starych i nowych baterii. Jeżeli produkt nie jest używany przez dłuższy czas lub jeżeli baterie się wyczerpały, należy wyjąć baterie. Nigdy nie należy stosować uszkodzonych baterii. Należy używać wyłącznie baterii alkalicznych. Przy wkładaniu baterii należy zwrócić uwagę na właściwe położenie biegunów. Nigdy nie należy próbować ładowania baterii jednorazowych. Nigdy nie należy doprowadzać do zwarcia w gnieździe baterii.

CZ

Důležité informace o bateriích

Nikdy nepoužívejte najednou různé typy baterií nebo kombinaci starých a nových baterií. Nebude-li se výrobek delší dobu používat nebo jsou-li baterie vybité, vždy je vyjměte z výrobku. Nikdy nepoužívejte poškozené baterie. Používejte pouze alkalické baterie. Baterie instalujte se správnou orientací pólů. Nikdy se nesnažte nabíjet baterie, které nejsou nabíjitelné. Nikdy nezkratujte kontakty v prostoru pro baterie.

SK

Dôležitá informácia o batériách

Nikdy nepoužívajte naraz odlišné typy batérií ani nekombinujte staré batérie s novými. Batérie vždy vyberte, ak sa výrobok nebude dlhšie používať, alebo ak sa batérie vybili. Nikdy nepoužívajte poškodené batérie. Používajte iba alkalické batérie. Batérie vkladajte so správnou orientáciou pólou. Nikdy sa nesnažte nabíjať batérie, ktoré nie sú nabíjateľné. Nikdy neskratuje kontakty v priestore pre batérie.

HU

Fontos tudnivalók az elemekről

Soha ne használjon különböző típusú elemeket, illetve ne használjon vegyesen új és használt elemeket. Mindig távolítsa el az elemeket, ha a készüléket előre láthatóan hosszabb ideig nem fogják használni, vagy ha az elemek lemerültek. Soha ne használjon megrongálódott elemeket. Csak alkáli elemeket használjon! Az elemeket helyesen helyezze be, a polaritásuknak megfelelően. Soha ne próbálja meg feltölteni a nem tölthető elemeket. Soha ne hozzon létre rövidzárlatot az elemtartó kivezetésein.

UA

Необхідна інформація про батарейки

Ніколи не використовуйте одночасно батарейки різних типів або батарейки з різним терміном придатності. Обов'язково вилучайте батарейки з приладу, якщо довго не користуєтесь ним, або якщо в батарейках уже скінчився заряд. Ніколи не використовуйте пошкоджені батарейки. Використовуйте лише лужні батарейки. Вставляйте батарейки, враховуючи задану полярність. У будь-якому випадку не намагайтеся підзарядити батарейки, що не підлягають підзарядці. У будь-якому випадку не намагайтеся зробити коротке замикання в приладі для батарей.

HR

Važne obavijesti o bateriji

Nikada nemoj koristiti različite vrste baterija zajedno, isto tako ni kombinaciju starih i novih baterija. Uvijek izvadi baterije ako dugo nećeš koristiti proizvod ili ako su one potrošene. Nikada nemoj koristiti oštećene baterije. Upotrebjavajte samo alkalne baterije. Umetni baterije pazeci da dobro okreneš polove. Nikada ne pokušavaj puniti baterije koje nisu predviđene za punjenje. Nikada ne izlazivaj kratki spoj u držaču baterija.

SR

Важне информације о батеријама

Nikada ne koristite različite tipove baterija zajedno niti kombinaciju starih i novih baterija. Uvek izvadite baterije ukoliko proizvod nećete dugo vreme koristiti ili ukoliko su baterije prazne. Nikada ne koristite oštećene baterije. Koristite samo alkalne baterije. Stavite baterije tako da su polovi pravilno pozicionirani. Nikada ne pokušavajte da punite baterije koje ne mogu da se pune. Nikada ne izazivajte kratak spoj u kuhištu za baterije.

MK

Важни информации за батериите

Nikogash ne koristete različni tipovi baterii zaedno ili kombinacija od stari i novi baterii. Sekogash odstranuvajte gi bateriite dokolku ne go koristite proizvodot podolgo vreme ili dokolku se potrošile. Nikogash ne koristete ošteteni baterii. Koristete samo alkalni baterii. Vmetnete gi bateriite taka što točno ke gi namestite polovite. Nikogash ne obiduvajte se da gi polnite bateriite za ednogkratna upotreba. Nikogash ne predizvikuuvajte kratak spoj na držačot za baterii.

SL

Pomembne informacije o baterijah

Nikoli ne uporabljajte skupaj različnih baterij ali kombinacije starih in novih baterij. Vedno odstranite baterije, če izdelka dlje časa ne boste uporabljali ali če so iztrošene. Nikoli ne uporabljajte poškodovanih baterij. Uporabljajte le alkalne baterije. Baterije vstavite tako, da so njihovi polji pravilno obrnjeni. Nikoli ne poskušajte polniti baterij, ki niso akumulatorske. Pazite, da ležišč za baterije ne boste spravili v kratek stik.

RO

Informații importante despre baterii

Nu folosiți niciodată împreună tipuri diferite de baterii, sau o combinație de baterii vechi și noi. Îndepărtați întotdeauna bateriile dacă produsul nu este folosit timp îndelungat sau dacă bateriile s-au epuizat. Nu folosiți niciodată baterii deteriorate. Utilizați numai baterii de tip alcalin. Introduceți bateriile astfel ca polii să fie poziționați corect. Nu încercați niciodată să reîncărcați baterii nereîncărcabile. Nu scurtcircuitați niciodată suportul bateriei.

BG

Важна информация за батериите

Nикога не използвайте едновременно различни типове батерии или комбинация от стари и нови батерии. Винаги изваждайте батериите, ако изделието няма да се използва продължително време или ако батериите са се изтощили. Никога не използвайте повредени батерии. Използвайте само алкални батерии. Поставете батериите така, че полюсите да са разположени правилно. Никога не опитвайте да зареждате батерии,

LV

Svarīga informācija par baterijām

Nekad vienlaikus nelietojiet dažādu tipu, kā arī vecas un jaunas baterijas. Vienmēr izņemiet baterijas, ja tās ir izlādējušās vai ja produkts ilgāku laiku netiek lietots. Nekad nelietojiet bojātas baterijas. Izmantojiet tikai sārma tipa baterijas. Ievietojot baterijas, ievērojiet pareizu polaritāti. Nekad nemēģiniet uzlādēt baterijas, kas nav uzlādējamas. Nepieļaujiet īssavienojumu bateriju nodalījumā.

ET

Oluline teave patareide kohta

Āra kunagi kasuta koos erinevat tüüpi patareisid, samuti vanu ja uusi patareisid. Kui mänguasja ei kasutata pika aja jooksul, võta patarei sellest välja. Āra kunagi kasuta kahjustatud patareisid. Kasuta ainult leelispatareisid. Pane patareid mänguasja sisse nii, et pluss- ja miinus клемми asend oleks õige. Āra kunagi proovi akulaadijaga laadida tavalisi patareisid. Patareipesa клеммide vahel ei tohi tekkida lühist.

LT

Svarbi informacija apie elementus

Vienu metu nenaudokite skirtingų elementų, taip pat su naujais elementais nenaudokite senų. Jei nenaudosite gaminio ilgesnį laiką arba jei elementai išseko, visuomet išimkite juos iš gaminio. Niekada nenaudokite pažeistų elementų. Naudokite tik šarminius elementus. Elementus dėkite atsižvelgdami į jų poliškumą. Niekada nebandykite įkrauti vienkartinių elementų. Saugokitės, kad elementų dėkle nesukeltumėte trumpojo jungimo.

TR

Piller hakkında önemli bilgiler

Hiçbir zaman farklı tipte pilleri ya da eski pillerle yeni pilleri bir arada kullanmayın. Ürün uzun süre kullanılmayacaksa ya da piller bitmişse, pilleri ürünün içinden çıkarın. Hiçbir zaman zedelenmiş piller kullanmayın. Sadece alkalin piller kullanın. Pilleri kutuları doğru konumda olacak şekilde yerleştirin. Hiçbir zaman, şarj edilebilir olmayan pilleri şarj etmeye çalışmayın. Hiçbir zaman pil kutusuna kısa devre yaptırmayın.

AR

معلومات مهمة عن البطاريات

يحظر استخدام أنواع مختلفة من البطاريات معا أو مزيج من البطاريات القديمة و الجديدة. احرص دائما على نزع البطاريات في حال عدم استخدام المنتج لفترة طويلة او إذا نفذت طاقة البطاريات. تجنب استخدام البطاريات التالفة. لا تستخدم إلا البطاريات القلوية فقط. قم بتكيب البطاريات بحيث تكون الأقطاب في موضعها الصحيح. يحظر إعادة شحن البطاريات غير القابلة لإعادة الشحن. تجنب إحداث دائرة قصر في حامل البطارية.

ID

Informasi penting tentang baterai

Jangan gunakan baterai yang jenisnya berlainan, atau mencampur baterai lama dan baterai baru. Lepas baterai jika produk tidak akan digunakan untuk waktu lama atau jika baterai sudah lemah. Jangan gunakan baterai yang rusak. Gunakan hanya baterai alkali. Masukkan baterai dengan posisi kutub yang tepat. Jangan pernah coba mengisi ulang baterai biasa. Jangan pernah membuat arus pendek pada dudukan baterai.

MS

Maklumat penting tentang bateri

Jangan guna jenis bateri yang berbeza bersama-sama, atau gabungan bateri baharu dan lama. Tanggalkan bateri jika produk tidak akan digunakan untuk tempoh masa yang lama atau jika bateri telah kehabisan kuasa. Jangan guna bateri yang rosak. Guna bateri jenis alkali sahaja. Selitkan bateri supaya paksi berada pada kedudukan yang betul. Jangan cuba untuk mengecas semula bateri yang tidak boleh dicaskan semula. Jangan pintas litar pemegang bateri.



EN

Protect the environment by not disposing of this product with your household waste.

Check with your local authority for recycling advice and facilities.

DE

Schützen Sie die Umwelt und entsorgen Sie dieses Produkt nicht mit Ihrem Hausmüll.

Informationen zu Recycling-Möglichkeiten erhalten Sie bei den örtlichen Behörden.

FR

Protégez l'environnement : ne jetez pas ce produit avec vos autres déchets ménagers.

Contactez les autorités locales pour obtenir des informations sur le recyclage et connaître les points de collecte.

IT

Proteggi l'ambiente! Non smaltire questo prodotto con i rifiuti domestici.

Per consulenza sul riciclaggio dei rifiuti e le strutture di riciclaggio, rivolgersi alle proprie autorità locali.

NL

Bescherm het milieu: gooi dit product niet samen met het andere huisvuil weg.

Raadpleeg de plaatselijke instanties voor locaties van milieustations en advies over hergebruik.

ES

Proteja el medio ambiente no deshaciéndose de este producto junto con sus residuos domésticos.

Solicite asesoramiento e información sobre instalaciones de reciclaje a las autoridades locales.

DA

Beskyt miljøet! Smid ikke dette produkt ud sammen med husholdningsaffaldet.

Få vejledning om genbrug og genbrugsstationer hos din kommune.

IS

Stuðlið að umhverfisvernd með því að farga þessari vöru ekki með heimilissorpi.

Leitið upplýsinga um endurvinnslu- og förgunarstaði hjá yfirvöldum á hverjum stað.

FI

Tämä tuote on hävitettävä ympäristöstävällisesti ja erillään muusta talousjätteestä.

Tietoja kierrätyksestä ja keräyspisteiden sijainnista saat paikkakuntasi teknisestä virastosta.

SV

Skydda miljön genom att inte kasta denna produkt bland ditt hushållsavfall.

Kontakta din kommun för frågor om återvinning och miljöstationer.

NO

Beskytt miljøet. Ikke kast dette produktet i husholdningsavfallet.

Kontakt kommunen for veiledning om gjenbruk og miljøstasjoner.

PT

Proteja o ambiente não eliminando este produto com o seu lixo doméstico.

Consulte as autoridades locais para informação sobre reciclagem e sistemas de recolha.

EL

Προστατέψτε το περιβάλλον. Μην πετάτε αυτό το προϊόν μαζί με τα συνηθισμένα οικιακά απορρίμματα.

Επικοινωνήστε με τις τοπικές αρχές σχετικά με συμβουλές και εγκαταστάσεις ανακύκλωσης.

JA

環境保護のため、本製品は家庭ごみとは別に処分してください。

リサイクルに関する指示や施設については、お住まいの地方自治体にお問い合わせください。

ZH

注意保护环境，请勿将本产品与生活垃圾一起丢弃处理。

请咨询当地相关部门，了解与回收相关的设施与建议。

KO

환경 보호를 위해 이 제품을 생활폐기물과 함께 버리지 마십시오.

재활용 방법 및 시설에 관한 사항은 현지 관계 당국에 문의하십시오.

RU

Позаботьтесь об окружающей среде: не утилизируйте этот продукт вместе с бытовым мусором.

Узнайте в органах местного самоуправления правила вторичной переработки и утилизации таких отходов.

PL

Aby chronić środowisko naturalne, nie należy wyrzucać tego produktu wraz z odpadkami z gospodarstwa domowego.

W celu uzyskania wskazówek dotyczących recyklingu oraz adresów zakładów należy skontaktować się z lokalnym urzędem.

CZ

Nevyhazujte tento produkt do domácího odpadu, chráňte životní prostředí.

Zjistěte si prosím u místních úřadů možnosti recyklace a dostupná zařízení.

SK

Nevyhadzujte tento produkt do domáceho odpadu, chráňte životné prostredie.

Zistite si na miestnych úradoch možnosti recyklácie a dostupné zariadenia.

HU

Környezetét óvja, ha ettől a terméktől nem a háztartási hulladékkal együtt válik meg.

Érdeklődjék a lakóhelyéhez közel eső hatóságnál az újrahasznosítás módjáról és lehetőségeiről.

UA

Допоможіть захистити довкілля: не утилізуйте цей виріб разом із побутовим сміттям.

Вказівки з утилізації та відомості про пункти прийому з'ясуєте в місцевих компетентних органах.

HR

Zaštitite okoliš tako da ovaj proizvod ne odložite u otpad zajedno s kućanskim otpadom.

Od lokalnih vlasti zatražite savjet ili informacije o pogonima za recikliranje.

SR

Zaštitite životnu sredinu tako što nećete da odložete ovaj proizvod sa kućnim otpadom.

Raspitajte se kod lokalnog nadležnog organa o načinu reciklaže i o sabirnom centru.

MK

Zaštitete ja okolinata taka što nema da se oslobodite od proizvodot co domashniot otpad.

Konsultirajte se so lokalnite vlasti za da doznaete za sovetite i objektite za recikliranje.

SL

Zaščitite okolje! Okolje varujte tako, da tega izdelka ne zavržete skupaj z gospodinjiskimi odpadki.

Pri krajevni upravi preverite, kakšne možnosti in kateri obrati za recikliranje obstajajo v vaši okolici.

RO

Protejați mediul înconjurător și nu vă debarașați de acest produs împreună cu deșeurile menajere

Consultați autoritățile locale pentru îndrumări și facilități de reciclare.

BG

Защитете околната среда и не изхвърляйте този продукт заедно с битовите си отпадъци.

Свържете се с местните власти относно съвети и съоръжения за рециклиране.

LV

Lai saudzētu vidi, neizmetiet šo izstrādājumu kopā ar sadzīves atkritumiem.

Vērsieties vietējās varas iestādēs, lai noskaidrotu, kur un kā tas nododams pārstrādei.

ET

Keskikonda saate kaitsta nii, et ei kõrvalda seda toodet koos olmejäätmetega.

Nõuandeid toote taaskasutusse võtmise ja ümbertöötlemispunktide kohta saate asjaomasealt kohalikult asutuselt.

LT

Saugokite aplinką: nemeskite šio produkto kartą su buitiniėmis atliekomis.

Atsižvelkite į savo vietos valdžios rekomendacijas dėl pakartotinio panaudojimo ir sąlygas.

TR

Bu ürünü, evsel atıklarla birlikte atmayarak çevreyi koruyun.

Gerİ dönüŖüm tavsiyeleri ve tesisler hakkında bilgi için yerel yönetimle iletişimi kurun.

AR

احم البيئة بعدم التخلص من هذا المنتج مع الخلفات المنزلية.

استشر السلطة المحلية لديك للحصول على نصح بخصوص إعادة تدوير الخلفات ومرافقها.

ID

Jagalah lingkungan dengan tidak membuang produk ini bersama sampah rumah tangga Anda.

Periksa peraturan pemerintah setempat tentang saran dan fasilitas daur ulang.

MS

Lindungi alam sekitar dengan tidak melupuskan produk ini bersama sisa isi rumah anda.

Rujuk pihak berkuasa tempatan anda tentang nasihat dan kemudahan kitar semula.



EN

WARNING: This product contains a Button or Coin Cell Battery. A swallowed Button or Coin Cell battery can cause internal chemical burns in as little as two hours and lead to death. Dispose of used batteries immediately. Keep new and used batteries away from children. If you think batteries might have been swallowed or placed inside any part of the body, seek immediate medical attention.

DE

ACHTUNG: Dieses Produkt enthält eine Knopfzellenbatterie. Eine verschluckte Knopfzellenbatterie kann innere chemische Verbrennungen verursachen und in weniger als zwei Stunden zum Tod führen. Entsorge umgehend gebrauchte Batterien. Halte neue und gebrauchte Batterien von Kindern fern. Wenn du glaubst, dass Batterien verschluckt wurden oder sich in einem Körperteil befinden, hole umgehend medizinische Hilfe.

FR

AVERTISSEMENT : Ce produit contient une pile bouton. L'ingestion d'une pile bouton peut provoquer des brûlures chimiques internes en seulement deux heures et provoquer la mort. Jeter immédiatement les piles usagées. Conserver les piles neuves et usagées hors de portée des enfants. Si vous suspectez l'ingestion d'une pile ou sa présence où que ce soit à l'intérieur du corps, consultez immédiatement un médecin.

IT

ATTENZIONE: questo prodotto contiene una batteria a bottone. Se inghiottita, una batteria a bottone può causare ustioni chimiche interne in sole due ore, con possibile morte. Smaltire immediatamente le batterie usate. Tenere le batterie nuove e usate lontano dai bambini. Se si pensa che una batteria sia stata inghiottita o inserita in una parte del corpo, rivolgersi immediatamente a un medico.

NL

WAARSCHUWING: dit product bevat een knoopcelbatterij. Als een knoopcelbatterij wordt ingeslikt, kan deze binnen twee uur chemische brandwonden veroorzaken in het lichaam. Het inslikken van een dergelijke batterij kan zelfs leiden tot overlijden. Gooi gebruikte batterijen onmiddellijk weg. Bewaar nieuwe en gebruikte batterijen buiten bereik van kinderen. Als je denkt dat een kind batterijen heeft ingeslikt of ze in een lichaamsopening heeft gestopt, raadpleeg je direct een arts.

ES

ADVERTENCIA: Este producto contiene una pila de botón. Ingerir una pila de botón puede dar lugar a quemaduras químicas internas en tan sólo dos horas y provocar la muerte. Las pilas usadas deben desecharse inmediatamente. Mantenga las pilas nuevas y usadas fuera del alcance de los niños. Si sospecha de la ingestión o la introducción de pilas en cualquier parte del cuerpo, busque atención médica inmediatamente.

DA

ADVARSEL: Dette produkt indeholder et knap- eller møntcellebatteri. Hvis et knap- eller møntcellebatteri sluges, kan det forårsage indvendige ætsninger på blot to timer og medføre døden. Bortskaf brugte batterier omgående. Hold både både nye og brugte batterier uden for børns rækkevidde. Hvis du har mistanke om, at batterierne kan være blevet slugt eller kommet ind i nogen del af kroppen, skal du omgående søge lægehjælp.

IS

VIÐVÖRUN: Þessi vara inniheldur hnapparaflöðu eða flata raflöðu. Ef hnapparaflaða eða flöt raflaða er gleypt getur hún valdið innvortis efnabruna á innan við tveimur klukkustundum og leitt til dauða. Fargaðu notuðum raflöðum tafarlaust. Geymdu nýjar og notaðar raflöður þar sem börn ná ekki til. Ef þú telur að raflöður hafi verið gleyptar eða á annan hátt komist inn í einhvern hluta líkamans skaltu tafarlaust leita læknaaðstoðar.

FI

VAROITUS: Tämä tuote sisältää pienen tai isokokaisen nappipariston. Nieletynä pieni tai isokokoinen nappiparisto voi aiheuttaa sisäisiä kemiallisia palovammoja jo kahden tunnin kuluessa ja johtaa kuolemaan. Käytetyt paristot on toimitettava heti keräyspisteeseen. Pidä uudet ja käytetyt paristot poissa lasten ulottuvilta. Jos epäilet jonkun nieleensä pariston tai laittaneensa pariston kehoonsa, vie hänet välittömästi lääkäriin.

SV

VARNING: Denna produkt innehåller ett knapp- eller myntcells batteri. Förtäring av ett knapp- eller myntcells batteri kan orsaka inre kemiska brännskador på så kort tid som två timmar och leda till döden. Kassera förbrukade batterier omedelbart. Förvara nya och använda batterier utom räckhåll för barn. Om du tror att batterierna kan ha svalts eller placerats inuti någon del av kroppen, sök omedelbart läkarvård.

NO

ADVARSEL: Dette produktet inneholder et knapp- eller myntcellebatteri. Ved svelging kan knapp- eller myntcellebatterier gi kjemisk brannskade innvendig på bare to timer og føre til død. Brukte batterier skal avhendes øyeblikkelig. Nye og brukte batterier skal oppbevares utlignelig for barn. Hvis du tror at batterier har blitt svelget eller puttet inn andre steder i kroppen, må du kontakte lege øyeblikkelig.

PT

AVISO: Este produto contém uma pilha tipo botão ou moeda. Uma pilha tipo botão ou moeda que tenha sido engolida pode provocar queimaduras químicas internas em menos de duas horas e levar à morte. Elimine as pilhas usadas imediatamente. Mantenha as pilhas novas e usadas fora do alcance das crianças. Se pensa que as pilhas podem ter sido engolidas ou colocadas no interior de alguma parte do corpo, procure de imediato assistência médica.

EL

ΠΡΟΕΙΔΟΠΟΙΗΣΗ: Αυτό το προϊόν περιέχει μία Στρογγυλή Μπαταρία Μεγέθους Κουμπού ή Κέρματος. Η κατάποση μιας Στρογγυλής Μπαταρίας Μεγέθους Κουμπού ή Κέρματος μπορεί να προκαλέσει εσωτερικά χημικά εγκαύματα σε μόλις δύο ώρες και να οδηγήσει σε θάνατο. Πιπέστε αμέσως τις χρησιμοποιημένες μπαταρίες. Κρατήστε τις καινούργιες και τις χρησιμοποιημένες μπαταρίες μακριά από τα παιδιά. Εάν νομίζετε ότι κάποια μπαταρία έχει καταποθεί ή τοποθετηθεί εντός οποιουδήποτε μέρους του σώματος, ζητήστε αμέσως ιατρική βοήθεια.

JA

警告：本製品には、ボタン型またはコイン型の電池が使用されています。ボタン型またはコイン型電池は誤飲すると2時間以内に体内で科学火傷を起こし、死に至る恐れがあります。使用済みの電池は直ちに廃棄してください。新しい電池および使用済み電池は、どちらもお子様の手の届かないところに保管してください。電池を誤飲した恐れがある、または電池が身体のどこかに入った恐れがある場合は、直ちに医師の診察を受けてください。

ZH

警告：本品内含一颗纽扣电池。吞咽的纽扣电池仅在两小时内就会引起体内化学灼伤并导致死亡！请立即处理使用过的电池。请将新、旧电池放置到儿童接触不到的地方。如果电池被不慎吞下，或被置入身体的任何一个部位，请立即就医！

KO

경고: 이 제품에는 버튼 또는 코인 셀 배터리가 포함되어 있습니다. 코인 셀 배터리를 삼킬 경우, 빠르면 2시간 이내에 체내에서 화학적 화상이 일어나고 심하면 사망에 이를 수 있습니다. 다 쓴 배터리는 즉시 폐기하십시오. 배터리를 어린이의 손에 닿지 않는 곳에 보관하십시오. 배터리를 삼켰거나 신체 어느 부위에든 들어간 것으로 판단될 경우, 즉각 의사의 도움을 구하십시오.

RU

ПРЕДОСТЕРЕЖЕНИЕ: Эта игрушка работает от батарейки таблеточного или кнопочного типа.

Проглатывание батарейки таблеточного или кнопочного типа может (в течение двух часов) вызвать химические ожоги внутренних органов и привести к летальному исходу. Своевременно утилизируйте использованные батарейки. Храните новые и использованные батарейки в местах, недоступных для детей. Если у вас есть основания полагать, что ребенок проглотил батарейку или она попала внутрь какой-либо части его тела, немедленно обратитесь за медицинской помощью.

PL

OSTRZEŻENIE: w tym produkcie znajduje się płaska okrągła bateria. Połknięcie takiej baterii może spowodować chemiczne oparzenia wewnętrzne już po dwóch godzinach, a także doprowadzić do śmierci. Gdy bateria się zużyje, należy ją natychmiast zutylizować. Nowe i używane baterie należy przechowywać z dala od dzieci. W przypadku stwierdzenia, że baterie mogły zostać połknięte lub inaczej trafić do organizmu, należy natychmiast poszukać pomocy lekarskiej.

CZ

VAROVÁNÍ: Tento výrobek obsahuje knoflíkovou nebo mincovou baterii. Spolknutí knoflíkové nebo mincové baterie může během pouhých 2 hodin způsobit vnitřní poleptání sliznice a v některých případech mít za následek smrt. Použité baterie ihned vyjměte a zlikvidujte. Nové i použité baterie uchovávejte mimo dosah dětí. V případě spolknutí či uviznutí baterie v některé části těla okamžitě vyhledejte lékařskou pomoc.

SK

UPOZORNENIE: Tento produkt obsahuje gombíkovú alebo mincovú batériu. Prehltutie gombíkovej alebo mincovej batérie môže spôsobiť vnútorné chemické popáleniny už do dvoch hodín a viesť k úmrtiu. Použitú batériu ihneď vyhodte. Nové aj použité batérie uchovávajte mimo dosahu detí. Ak si myslíte, že mohli dôjsť k prehltnutiu batérie alebo sa batéria mohla dostať do vnútra ktorejkoľvek časti tela, okamžite vyhľadajte lekársku pomoc.

HU

FIGYELMEZTETÉS: Ez a termék gombelemet illetve lapos gombelemet tartalmaz! A lenyelt gombelem vagy lapos gombelem akár két óra alatt is belső vagy sérüléseket okozhat, ami halálhoz vezethet. Az elhasznált elemeket azonnal dobja ki! Az új és a használt elemeket ne adja gyermeknek kezébe! Ha úgy gondolja, hogy valaki lenyelt egy elemet, vagy bekerült valakinek valamely testrészébe, akkor azonnal kérjen orvosi segítséget!

UA

ОБЕРЕЖНО. Продукт містить мініатюрну батарейку типу «таблетка». Якщо проковтнути мініатюрну батарейку, вона може спричинити внутрішні хімічні опіки протягом двох годин і призвести до смерті. негайно утилізуйте використані батарейки. Зберігайте нові та використані батарейки недоступними для дітей. Якщо вам здається, що дитина проковтнула батарейку чи вона опинилася в будь-якій частині тіла дитини, негайно зверніться до лікаря.

HR

OPROZORENJE: Ovaj proizvod sadrži gumbastu bateriju ili bateriju oblika kovanice. Ako se gumbasta baterija ili baterija oblika kovanice proguta, za samo dva sata može uzrokovati unutarnje kemijske opekline i izazvati smrt. Iskorištene baterije odmah odložite u otpad. Čuvajte nove i stare baterije dalje od djece. Ako mislite da je baterija progutana ili je dospjela u bilo koji dijel tijela, odmah zatražite liječničku pomoć.

SR

УПОЗОРЕЊЕ: Овај производ садржи дугмасту батерију. Прогутана дугмаста батерија може да доведе до интерних хемијских опекотина већ за два сата и доводи до смрти. Одмах одложите искоришћене батерије у отпад. Чувајте нове и искоришћене батерије ван домаћаја деце. Ако мислите да је дошло до гутања батерија или стављања у било који део тела, одмах потражите помоћ лекара.

MK

ПРЕДУПРЕДУВАЊЕ: Овој производ садржи батерија тип копче или тип монета.

Проголтавањето на батерија тип копче или тип монета може да предизвика внатрешно хемиско горење во рок од два часа и да доведе до смрт. Искористете ги веднаш искористените батерији. Држете ги новите и користените батерији подалеку од деца. Ако мислите дека е можно батериите да се проголтани или поставени во кој било дел на телото, веднаш побарајте медицинска помош.

SL

OPROZORILO: Ta izdelek vsebuje gumbasto baterijo. Če oseba požre gumbasto baterijo, lahko to povzroči kemične opekline notranjih organov že v dveh urah po zaužitju. Tvrstne poškodbe lahko vodijo v smrt. Iztrošene baterije takoj zavrzite. Pazite, da nove ali iztrošene baterije ne bodo v dosegu otrok. Če menite, da je oseba zaužila baterijo ali si jo vstavila v kateri koli del telesa, takoj poiščite zdravniško pomoč.

RO

AVERTIZARE: Acest produs conține o baterie de tip pastilă. Înghițirea unei baterii de tip pastilă poate cauza arsuri chimice interne în doar două ore, ducând la deces. Debarasați-vă imediat de bateriile uzate. Nu lăsați bateriile noi și uzate la îndemâna copiilor. Dacă credeți că bateriile ar fi putut fi înghițite sau ar fi putut ajunge în interiorul oricărei părți a corpului, solicitați imediat asistență medicală.

BG

ПРЕДУПРЕЖДЕНИЕ: Този продукт съдържа батерия тип „копче“ или „монета“. При поглъщане батериите тип „копче“ или „монета“ могат да предизвикат вътрешни химически изгаряния в рамките на по-малко от два часа и да доведат до смърт. Незабавно изхвърляйте използваните батерии. Дръжте новите и стари батерии далеч от деца. Ако смятате, че е възможно батериите да са били погълнати или да са попаднали където и да е вътре в тялото, потърсете незабавно медицинска помощ.

LV

BRĪDINĀJUMS. Šim produktam ir pogas jeb monētas tipa akumulators. Ja pogas jeb monētas tipa akumulators tiek norīts, tas jau divu stundu laikā var izraisīt iekšējus ķīmiskus apdegumus un izraisīt nāvi. Nekavējoties utīlizējiet izlietotos akumulatorus. Jaunus un lietotus akumulatorus glabāiet bērniem nepieejamā vietā. Ja uzskatāt, ka akumulators varētu būt norīts vai ievietots kādā ķermeņa daļā, nekavējoties vērsieties pēc medicīniskās palīdzības.

ET

HOIATUS! See toode sisaldab nõõp- või müntpatareid.

Alla neelatud nõõp- või müntpatarei võib tekitada sisemisi keemilisi põletusi kõigest kahe tunniga ning põhjustada surma. Kõrvaldage kasutatud patareid viivitamatult. Hoidke uusi ja kasutatud patareisiid lastele kättesaamatus kohas. Kui arvate, et keegi on patareid alla neelanud või need on sattunud mõnda kehaosasse, pöörduge kohe arsti poole.

LT

JSPĖJIMAS. Šiame gaminyje yra sagos arba monetos formos baterija.

Praryta sagos arba monetos formos baterija gali sukelti vidinius cheminius nudeginimus greičiau nei per dvi valandas ir galiausiai sukelti mirtį. Panaudotas baterijas nedelsiant utilizuokite. Naujas ir panaudotas baterijas laikykite atokiau nuo vaikų. Jei manote, kad vaikas galėjo praryti arba įsprausti bateriją sau į kūną, nedelsdami kreipkitės medicininės pagalbos.

TR

UYARI: Bu ürün bir düğme pil içerir.

Yutulmuş düğme pil, iki saat gibi kısa bir sürede iç kimyasal yanıklara neden olabilir ve ölüme yol açabilir. Kullanılmış pilleri derhal atın. Yeni ve kullanılmış pilleri çocuklardan uzak tutun. Pillerin yutulmuş ya da vücudun başka bir yerine sokulmuş olabileceğini düşünüyorsanız derhal doktora başvurun.

AR

تحذير: يحتوي هذا المنتج على بطارية خلايا قهرصية أو بطارية خلايا على شكل عملة. قد يؤدي ابتلاع بطارية خلايا قهرصية أو بطارية خلايا على شكل عملة إلى حدوث حروق كيميائية داخلية خلال فترة قصيرة لا تتجاوز ساعتين وقد يؤدي إلى الوفاة. يرجى التخلص من البطاريات المستعملة على الفور. مع الاحتفاظ بالبطاريات الجديدة والمستعملة بعيداً عن متناول الأطفال. إذا كنت تعتقد أن البطاريات تم ابتلاعها أو إدخالها إلى أي جزء من أجزاء الجسم، فاطلب المساعدة الطبية على الفور.

ID

PERINGATAN: Produk ini berisi Baterai Sel Kancing.

Baterai Sel Kancing yang tertelan dapat mengakibatkan luka bakar kimiawi dalam tubuh minimal setelah dua jam dan dapat mengakibatkan kematian. Segera buang baterai yang sudah tidak digunakan. Jauhkan baterai baru maupun bekas dari jangkauan anak-anak. Jika Anda curiga baterai telah tertelan atau masuk ke dalam tubuh, segeralah minta bantuan dokter.

MS

AMARAN: Produk ini mengandungi Baterai Sel Butang atau Syiling.







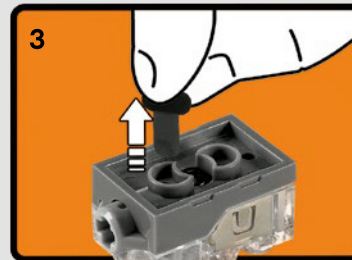
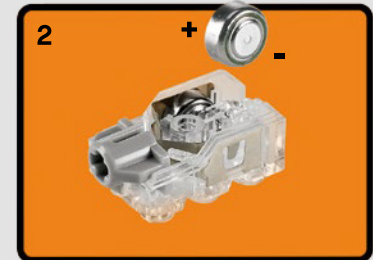





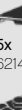

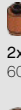

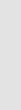
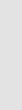
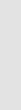

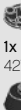
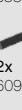

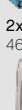
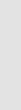
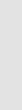
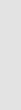

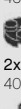

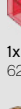

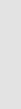
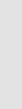
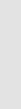

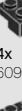

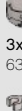
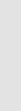
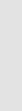
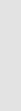



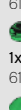

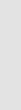
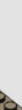



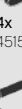
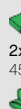

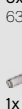
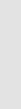

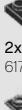
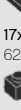



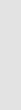

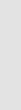
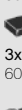
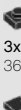
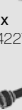
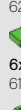
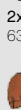
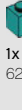
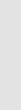
Tertelan bateri Sel Butang atau Syiling boleh mengakibatkan lecuran kimia dalaman dalam tempoh sekurang-kurangnya dua jam dan menyebabkan kematian. Buang bateri terpakai dengan serta-merta. Jauhkan bateri baharu dan terpakai daripada kanak-kanak. Jika anda mendapati bateri mungkin telah ditelan atau termasuk ke dalam mana-mana bahagian badan, dapatkan rawatan perubatan dengan segera.

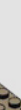
EN Please retain the leaflet and packaging as they contain important information
 DE Broschüre und Verpackung bitte aufbewahren, sie enthalten wichtige Informationen
 FR Veuillez conserver le dépliant et l'emballage, car ils contiennent des informations importantes
 IT Conserva l'opuscolo e la confezione in quanto contengono informazioni importanti
 NL Bewaar a.u.b. de folder en verpakking: die bevatten belangrijke informatie
 ES Conserve el folleto y el embalaje; contienen información importante
 DA Gem hæftet og emballagen, da de indeholder vigtige oplysninger
 IS Geymið bæklinginn og umbúðirnar þar sem þau innihalda mikilvægar upplýsingar
 FI Säilytä esite ja pakkaus, koska ne sisältävät tärkeää tietoa
 SV Spara broschyren och förpackningen eftersom de innehåller viktig information
 NO Heftet og emballasjen inneholder viktig informasjon og skal beholdes
 PT Por favor guarde o folheto e a embalagem, pois contém informações importantes
 EL Κρατήστε το φυλλάδιο και τη συσκευασία γιατί περιέχουν σημαντικές πληροφορίες
 JA 説明書とパッケージには重要な情報が含まれていますので保管しておいてください
 ZH 说明书和包装均包含重要信息, 请妥善保管
 KO 중요한 정보가 담겨 있으므로 리플릿과 포장을 보관해주세요
 RU Пожалуйста, сохраните эту брошюру и упаковку, поскольку они содержат важную информацию
 PL Prosimy zachować ulotkę i opakowanie, ponieważ zawierają one ważne informacje
 CZ Ponechte si prosím leták i obal, neboť obsahují důležité informace
 SK Ponechajte si prosím leták aj obal, pretože obsahujú dôležité informácie
 HU Kérjük, őrizze meg a szórólapot és a csomagolást, mert fontos tudnivalókat tartalmaznak
 UA Будь ласка, зберігайте вкладки та упаковку, оскільки вони містять важливу інформацію
 HR Spremite letak i ambalažu jer sadrže važne obavijesti
 SR Молимо да сачувате упутство и паковање јер се на њима налазе важне информације
 MK Чувајте ги брошурата и амбалажата бидејќи содржат важна информација
 SL Prosimo, da brošurico in embalažo shranite, saj vključujeta pomembne informacije
 RO Vă rugăm să păstrați prospectul și ambalajul întrucât conțin informații importante
 BG Запазете листовката и опаковката, тъй като съдържат важна информация
 LV Lūdzu, saglabājiet bukletu un iepakojumu, jo uz tā ir norādīta svarīga informācija
 ET Hoidke infoleht ja pakend alles, sest nendele on märgitud oluline teave
 LT Išsaugokite informacinį lapelį ir pakuotę, nes ant jų pateikiama svarbi informacija
 TR Önemli bilgiler içerdiği için broşürü ve ambalajı saklayın
 AR الرجاء الاحتفاظ بالنشرة والغلاف لاحتوائهما على معلومات هامة
 ID Harap simpan brosur dan kemasan ini karena berisi informasi penting
 MS Sila simpan risalah dan pembungkusan kerana ia mengandungi maklumat penting

LEGO System A/S
 Aastvej 1
 DK-7190 Billund

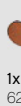

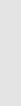
1:1
 2x LR 41 1.5V

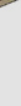
 2x 6170421	 10x 6330189	 5x 6214807	 1x 6186867	 2x 6074890	 6x 6151658	 19x 6322841	 2x 6199890	 3x 6236437
 5x 6331084	 1x 6157554	 2x 6336989	 10x 6209692	 1x 6322840	 4x 6150307	 1x 6132790	 2x 4528488	 1x 6245265
 9x 6284070	 1x 4278359	 2x 6093525	 37x 6286831	 1x 6145153	 2x 4655243	 3x 6132767	 5x 4205004	 1x 6252040
 10x 4529236	 2x 4653822	 1x 306826	 1x 6258413	 1x 6239416	 4x 6295400	 1x 6227249	 46x 6245268	 2x 6314353
 3x 6186675	 2x 403226	 2x 302226	 1x 4187743	 1x 6239416	 2x 6107389	 6x 4507045	 28x 6058242	 4x 6251306
 16x 6168646	 1x 452926	 4x 6092658	 1x 6167801	 6x 6284582	 3x 6327809	 2x 4626904	 2x 6285465	 1x 6240217
 1x 6153591	 2x 452826	 4x 6092658	 1x 6167801	 1x 6267125	 1x 6292957	 1x 4550329	 9x 6016483	 2x 6212994
 2x 6196548	 2x 6092585	 1x 6273226	 1x 6120224	 1x 6149656	 1x 6301362	 1x 6167894	 11x 6024722	 1x 6201587
 1x 6347310	 2x 6313116	 2x 6166859	 1x 6135287	 1x 6103249	 3x 6327807	 2x 6096215	 4x 6273296	 1x 6097503
 2x 6196548	 3x 4523339	 4x 4515368	 2x 4558593	 1x 4121739	 1x 4611883	 1x 6114515	 3x 6218088	 1x 6020073
 1x 6347310	 8x 6051038	 2x 452226	 3x 6229130	 1x 4121739	 7x 6213782	 1x 6114515	 1x 6109751	 1x 6020073
 5x 6156991	 17x 6245251	 2x 6174917	 4x 6100223	 2x 6153593	 6x 6213785	 1x 6114515	 3x 6218088	 2x 6341968
 2x 6174243	 2x 6328095	 2x 6174917	 27x 6206150	 2x 6153593	 1x 6213783	 1x 6114515	 1x 6109751	 11x 4211183
 2x 393826	 3x 362326	 1x 4227392	 6x 6172375	 2x 6335666	 6x 6213785	 1x 6114515	 1x 6109751	 4x 6060731
 3x 6047276	 3x 362326	 1x 4227392	 6x 6172375	 1x 6290250	 1x 6213783	 1x 6114515	 1x 6109751	 5x 6284586
 1x 4505757	 2x 6199908	 1x 395726	 6x 6235080	 1x 6290250	 1x 6213783	 1x 6114515	 1x 6109751	 9x 6285623
 2x 6016172	 1x 6250020	 2x 302026	 13x 6182261	 1x 6247204	 1x 6254100	 3x 4613196	 1x 6109751	 3x 4216581

1x 4626196
11x 4211242
1x 6149677
12x 4211288
2x 6348057
37x 4221744
12x 4504376
1x 4225469
41x 6201911
4x 4620075
1x 4226966
5x 6177699
8x 6062574
1x 6170570

2x 6186673
2x 6306775
2x 6317561
4x 6278989
2x 6035291
1x 6268828
3x 6102360
4x 4211166
9x 6269973
4x 6172757
4x 4211222
2x 6064188
1x 6186045
7x 6335567
6x 4595814

2x 6261359
4x 6192310
6x 4211150
1x 6069984
4x 4224243
29x 6172922
7x 6092590
5x 4211149
6x 4211151
9x 6261744
4x 4211199
4x 6310449
4x 6226436
5x 6174856
1x 6290983
36x 4645103

1x 6173143
2x 6338135
7x 4216695
1x 6280160
2x 6196221
4x 4211200
4x 4211210
4x 4211257
3x 6167644
2x 6221608
4x 6135494
2x 6102975
5x 6100769
2x 6299939
5x 6251470

3

1x 6268960
2x 6133833
7x 6055086
7x 4211197
2x 6116613
2x 6311441
3x 4211189
2x 4508616
4x 4211279
2x 6150305
1x 4658005
2x 6092659

6x 6248944
7x 4211152
2x 4211195
2x 6257604
7x 4211190
18x 4211194
6x 4595889
2x 6262952
3x 6075207
3x 6280388
1x 4538252
19x 4211186
3x 4211201

1x 6177697
8x 6044725
21x 4211204
9x 4221590
1x 4655611
2x 4243838
8x 6176608
14x 4211247
1x 6268855
3x 4216945
21x 4585337
1x 4263776

7x 4271874
1x 4277751
1x 4211207
11x 4211214
1x 4223729
3x 6055145
4x 4222627
10x 4225715
1x 4225700



Customer Service
Kundenservice
Service Consommateurs
Servicio Al Consumidor
LEGO.com/service or dial



