



# IDEAS

21315



# Meet the Fan Designers:

Connected by a love of LEGO® building, Jason and Grant collaborated across national borders (albeit in North America!) in designing the amazing pop-up book. An engineering student, Grant has long been fascinated by pop-up books, and wanted to apply some of the same mechanical ideas to LEGO bricks and then encase them in a LEGO brick book. Jason, a computer software developer, then joined the project. After several iterations and two years of tweaking, they arrived at a design to submit as a LEGO Ideas project.

Both guys have been designing and building custom LEGO sets for years. Jason's interests are in machines, robots and kinetic sculptures ([jkbrickworks.com](http://jkbrickworks.com)), while Grant's childhood obsession with pirate-themed designs can be seen on his Flickr page at [flickr.com/photos/93970753@N05](http://flickr.com/photos/93970753@N05).

So what does it feel like to have their project chosen as an official LEGO Ideas set? "I was ecstatic!" says Grant, while Jason felt like he was "walking on a cloud all day."



"My favorite LEGO® element?  
The cheese slope as it is the most  
versatile LEGO piece ever!"  
(part 54200)



"The 850 Fork-Lift Truck  
released in 1977 was my  
first Technic set and  
completely blew my mind"

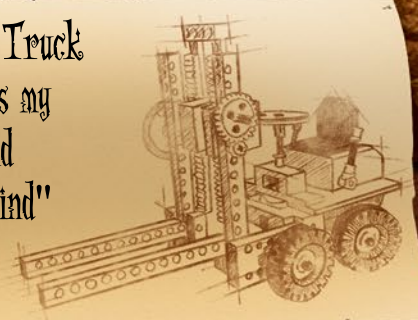

# Meet the LEGO® Designers:

Wesley Alan Talbott and Crystal Marie Fontan were the LEGO® designers who took up the mantle from Jason and Grant and used their 'LEGO insider' know-how to help develop the (already brilliant) idea into the LEGO pop-up book that you now own.

For model designer Wesley, the project was particularly exciting and meaningful, as he had worked on his own LEGO Ideas set before when the project was still known as Cuusoo. It was this very process that led to him rekindling his interest in building with LEGO bricks, and eventually getting his job as a LEGO designer. He was eager to collaborate with Jason and Grant, and work together to get the pop-up book ready for production.

As for graphic designer Crystal, this was her first LEGO Ideas project and, as a fan of storybooks and fairy tales, she couldn't wait to design the set's graphics and characters; seeing the opportunity to give something old and iconic a fresh new twist, while designing some of her favorite fairy-tale personalities as minifigures.



# Pop-Up Books in Time

Pop-up books have a long and fascinating history that actually pre-dates printing culture, going all the way back to the 13th century. Interestingly, the early incarnations of pop-up books were not storytelling devices at all, and certainly not aimed at children.

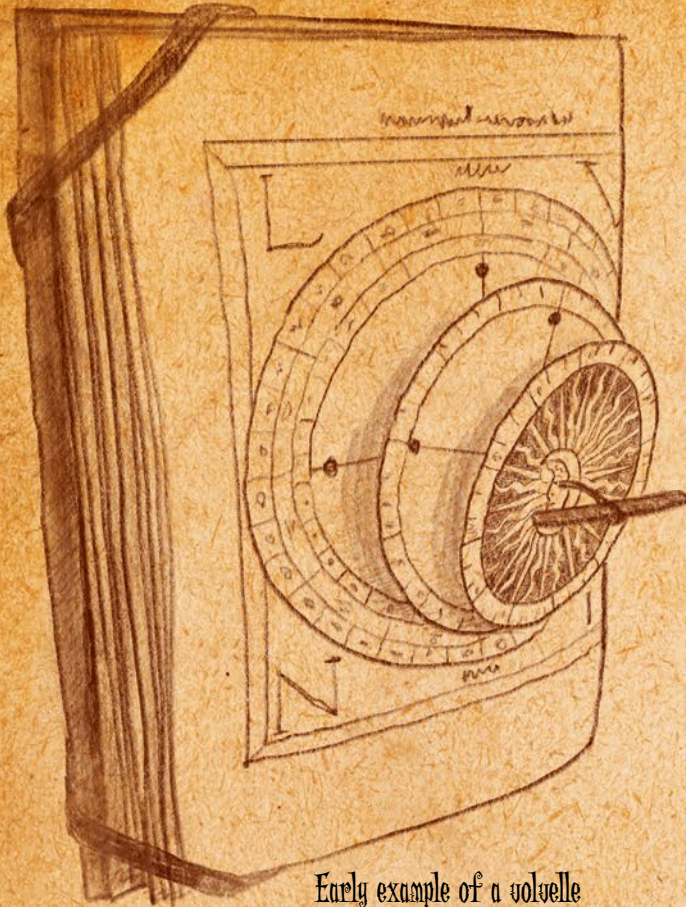

Early example of a volvelle

Some say that it was Ramon Lull (ca. 1232-1315), a Catalan mystic and poet who first created interactive paper constructions with moving mechanisms known as a volvelle, to illustrate his philosophical journey to find truth. His version was known as a Lullian Circle.



The Lullian Circle

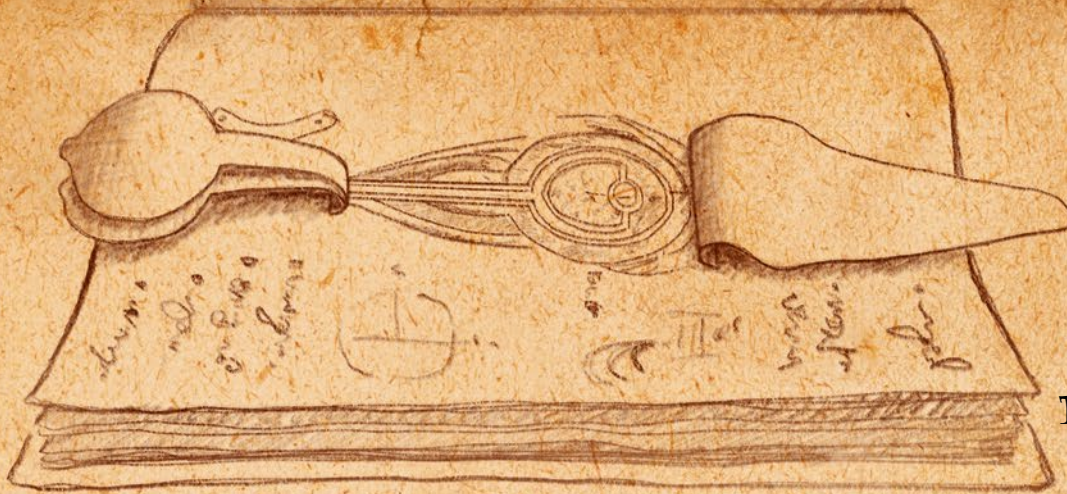

The 14th century saw the development of "turn-up"-style books, which were popular for medical students learning human anatomy, vividly illustrating the inner workings of the body.

Turn-up Book

Dating from the mid-18th century and inspired by theater stage sets, tunnel or 'peepshow books' were a set of bound pages with concertinaed strips along the side and a hole in the cover. Through this hole, one could 'peep' inside and see the entire book front to back, revealing the dimensional story inside.

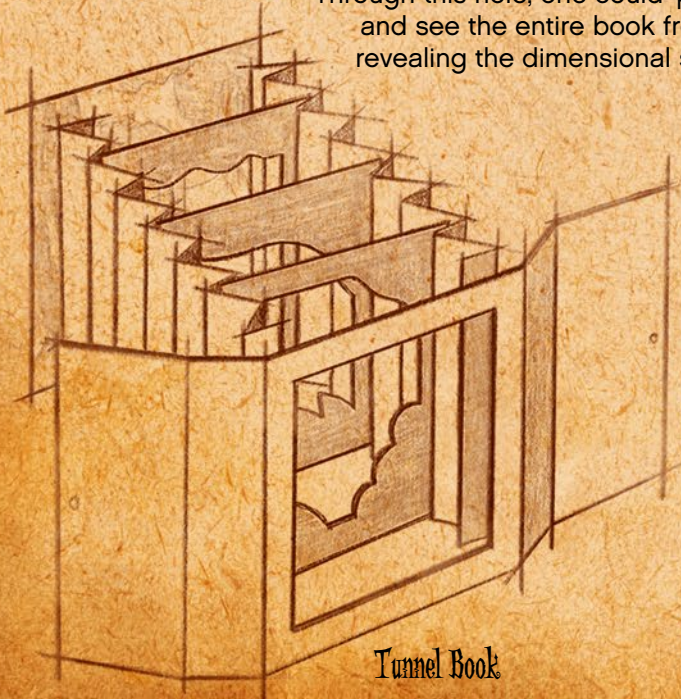

Tunnel Book

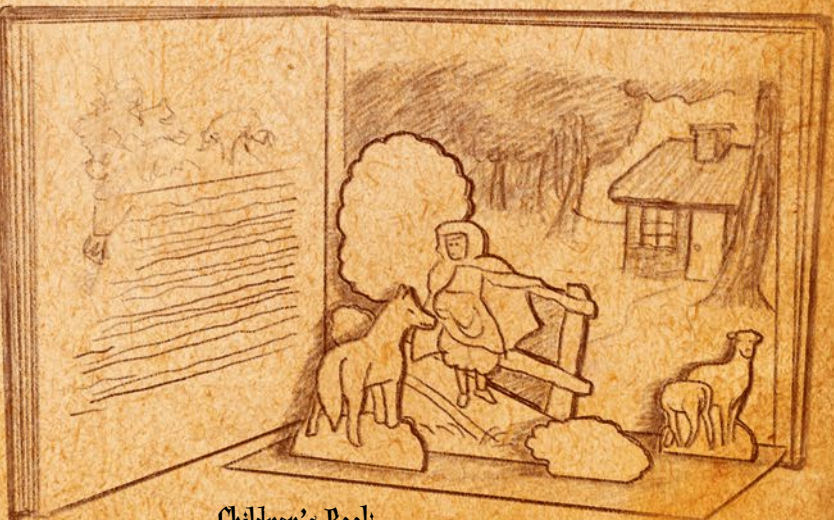

Children's Book

It was not until the very late 18th century that pop-up or 'paper architecture' techniques were applied to books designed for entertainment and eventually for children, as the children's literature genre developed at the time.

# Little Red Riding Hood

The story of the little girl in the red cape goes back to the 10th century and has roots in several European folktales. The first printed version was written by Charles Perrault, and later revised by the Brothers Grimm, who developed and collated these old tales and were key players in creating fairy tales as a genre. There are a few versions of Little Red Riding Hood, some much darker than others. The overall story involves

a little girl in a red hooded cape going to visit her grandmother in the woods, but along the way she encounters a wolf disguised as her grandparent instead. In this set, you will find all the elements needed to re-enact the story in exactly the way you want to. What happens next? That's up to you...

Create your fairy tale!



# Jack and the Beanstalk

An old English fairy tale, Jack and the Beanstalk is actually only one of the 'Jack' tales featuring the character. Some say that the story originates over 5,000 years ago in a folkloric tale referred to as The Boy Who Stole the Ogre's Treasure.

In the story, Jack takes the family cow to the market to be sold but instead swaps the cow for some magic beans. The family is impoverished, so his mother is very angry when he



returns home with a handful of beans instead of money. She throws them on the ground in anger and the next day a huge beanstalk has grown in their garden. Jack climbs up, finds a giant's castle and steals his treasure... Fee Fi Fo Fum! What happens to Jack afterwards, when the giant finds out... is up to you!

Build your own story...



# Rencontre avec les concepteurs amateurs :

Liés par leur amour pour les constructions LEGO®, Jason et Grant ont travaillé ensemble et franchi des frontières nationales (en Amérique du Nord) pour concevoir l'incroyable livre animé. Grant, un étudiant en génie, a longtemps été fasciné par les livres animés et a voulu appliquer quelques-unes des mêmes idées mécaniques aux briques LEGO, pour les mettre dans un livre en briques LEGO. Jason, un concepteur de logiciels, s'est ensuite ajouté au projet. Après plusieurs itérations et deux années de peaufinage, ils sont parvenus à soumettre leur création comme projet LEGO Ideas.



Les deux hommes créent et construisent des ensembles LEGO personnalisés depuis des années. Jason s'intéresse aux machines, aux robots et aux sculptures cinétiques ([jkbrickworks.com](http://jkbrickworks.com)). Grant, quant à lui, est passionné par les créations sur le thème des pirates depuis son enfance, comme nous pouvons le voir sur sa page Flickr ([flickr.com/photos/93970753@N05](https://www.flickr.com/photos/93970753@N05)).

Comment vous êtes-vous sentis quand vous avez su que votre projet était choisi comme l'un des ensembles officiels de LEGO Ideas ?  
« J'étais fou de joie ! », dit Grant, tandis que Jason avait l'impression de « marcher sur un nuage toute la journée ».

« L'élément LEGO® que je préfère ?

La brique en forme de fromage, car c'est la pièce LEGO la plus polyvalente qui soit ! »  
(pièce 54200)

« Le chariot élévateur 850, mis en vente en 1977, a été mon premier ensemble Technic et il m'a époustoufflé ! »

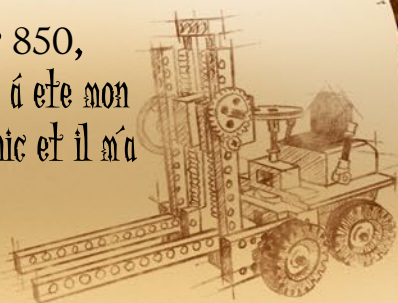



# Rencontre avec les concepteurs LEGO® :

Wesley Alan Talbott et Crystal Marie Fontan sont les concepteurs LEGO® qui ont pris le flambeau de Jason et Grant et qui ont utilisé leur savoir-faire LEGO pour aider à développer l'idée (déjà brillante) du livre animé LEGO que tu as maintenant entre les mains.

Pour Wesley, un concepteur de modèles, le projet a été particulièrement passionnant et significatif, puisqu'il a déjà travaillé sur ses propres ensembles LEGO Ideas, alors que le projet était encore connu sous le nom de Cuusoo. C'est ce processus qui lui a permis de retrouver son intérêt pour la construction avec les briques LEGO et, par la suite, d'obtenir le poste de concepteur LEGO. Il était impatient de collaborer avec Jason et Grant pour permettre la production de ce livre animé.

En ce qui concerne Crystal, une graphiste, c'était son premier projet LEGO Ideas et, en tant qu'amatrice d'histoires et de contes de fées, elle était impatiente de créer les graphiques et les personnages de l'ensemble. Elle y voyait l'occasion de donner une touche de fraîcheur à des classiques, tout en créant des petites figurines de ses personnages de contes de fées favoris.



# Les livres animés au fil du temps

Les livres animés ont une histoire longue et fascinante qui précède la culture d'impression, ce qui nous amène au XIIIe siècle. Étonnamment, les premières incarnations de livres animés n'étaient pas conçues pour raconter des histoires et elles n'étaient pas du tout destinées aux enfants.

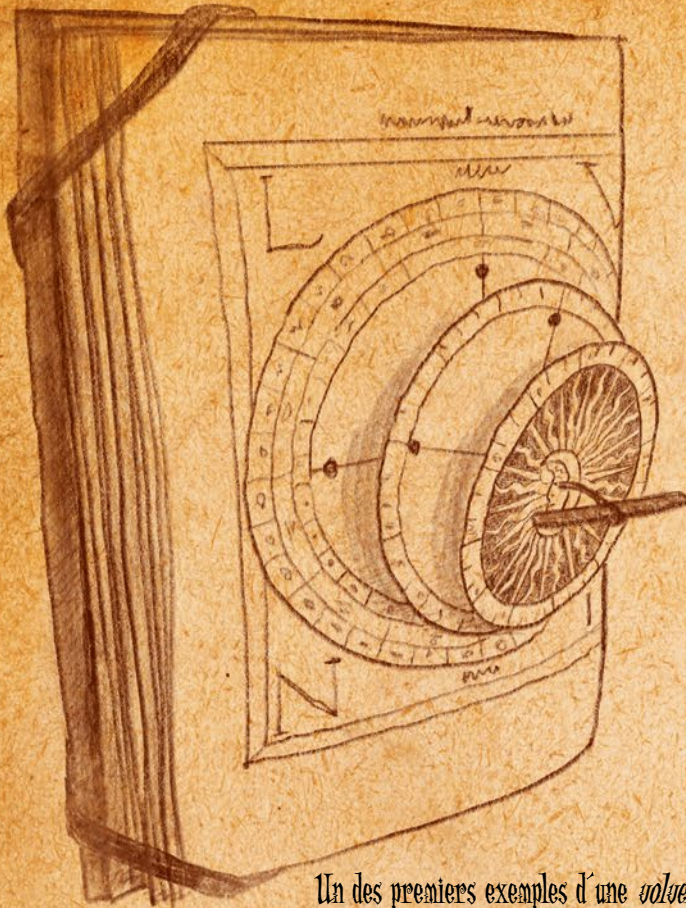

Un des premiers exemples d'une *volvelle*

Certains disent que Raymond Lulle (vers 1232-1315), un mystique et poète catalan, a été le premier à créer des constructions de papier interactives avec des mécanismes mobiles, connues sous le nom de *volvelles*, pour illustrer sa quête philosophique qui visait à trouver la vérité. Sa version était connue en tant que machine logique.



La machine logique

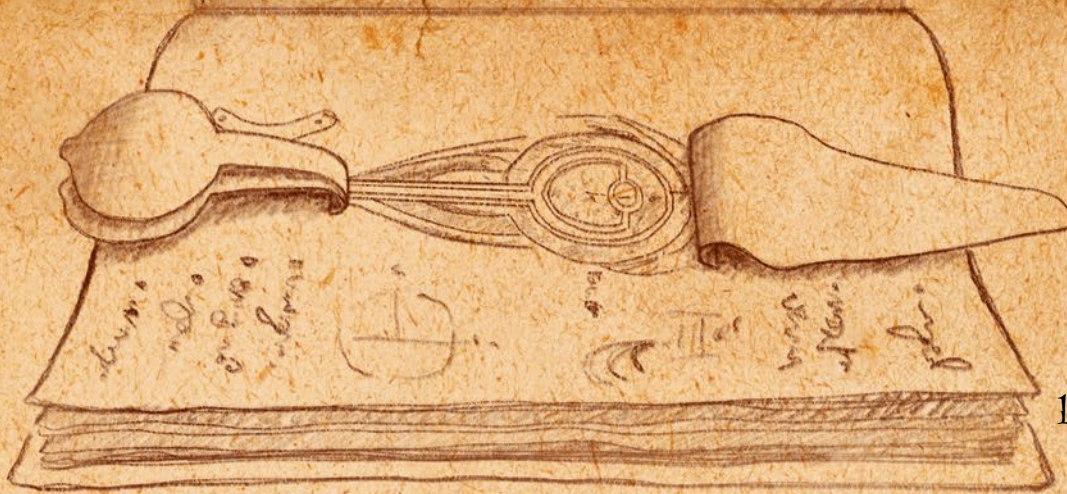

Le XIV<sup>e</sup> siècle a vu le développement des livres « superposés », qui étaient populaires chez les étudiants en médecine qui étudiaient l'anatomie humaine, car ils illustraient de manière vivante le fonctionnement interne du corps.

Livre superposé

Datant du milieu du XVIII<sup>e</sup> siècle et inspirés par les décors de théâtre, les livres tunnel étaient constitués d'un ensemble de pages et de bandes en accordéon sur le côté, et la page couverture était munie d'un trou. Par ce trou, on pouvait jeter un œil à l'intérieur et voir l'ensemble du livre, du début à la fin, de sorte à révéler son histoire dimensionnelle.

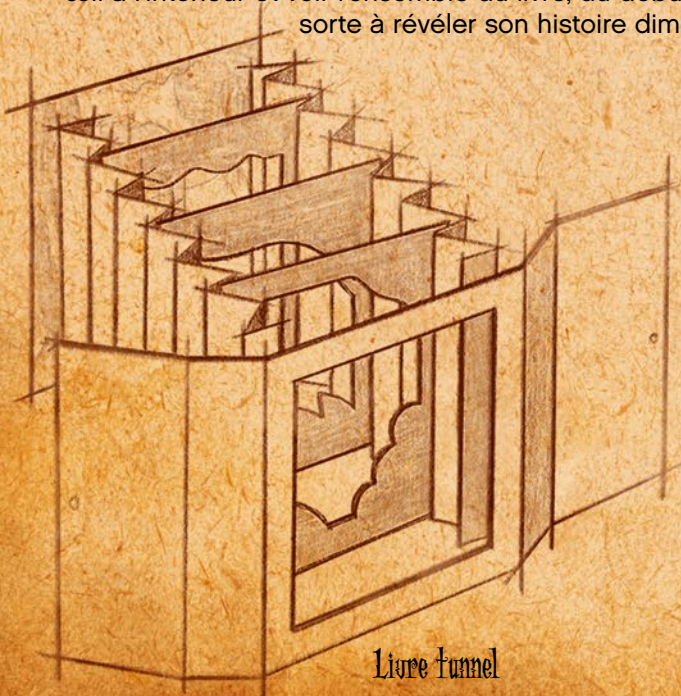

Livre tunnel

Ce n'est qu'à la fin du XVIII<sup>e</sup> siècle que des techniques de relief, ou d'architecture de papier, ont été appliquées à des livres conçus pour le divertissement et, éventuellement, pour les enfants, puisque la littérature jeunesse se développait à ce moment.



Livre pour enfant

# Le Petit chaperon rouge

L'histoire de la petite fille à la cape rouge remonte au Xe siècle et trouve ses origines dans plusieurs contes folkloriques européens. La première version imprimée a été écrite par Charles Perrault, et a plus tard été révisée par les frères Grimm, qui ont développé et rassemblé ces vieux contes. Ils ont grandement contribué à faire du conte de fées un genre littéraire. Il existe quelques versions du Petit chaperon rouge, dont certaines sont beaucoup plus sombres que d'autres.



L'histoire générale présente une petite fille portant une cape à capuchon rouge qui va rendre visite à sa grand-mère dans les bois. Sur son chemin, elle rencontre un loup déguisé comme sa grand-mère. Dans cet ensemble, tu trouveras tous les éléments nécessaires pour reproduire l'histoire exactement comme tu le souhaites. Que se passera-t-il ? C'est à toi de décider.

Crée ton conte de fées !



# Jack et le haricot magique

Jack et le haricot magique, un vieux conte de fées anglais, est en fait seulement l'un des contes mettant en vedette le personnage de Jack. Certains disent que l'histoire trouve ses origines dans un conte folklorique appelé « Le garçon qui vole le trésor de l'ogre », qui a plus de 5 000 ans.

Dans l'histoire, Jack amène la vache qui appartient à sa famille au marché afin de la vendre, mais il décide plutôt de l'échanger contre une poignée de haricots magiques. Sa mère est très en colère quand il revient à la maison



avec des haricots et non de l'argent, puisque la famille est pauvre. Elle les jette donc furieusement au sol. Le lendemain, on découvre qu'une énorme tige de haricot a poussé dans le jardin. Jack grimpe, trouve le château d'un géant et vole son trésor... Fe Fi Fo Fum ! Ce qui arrive à Jack, quand le géant le retrouve, ne dépend que de toi !

Build your own story...



# Conoce a los fans diseñadores:

Conectados por su amor por la construcción con LEGO®, Jason y Grant colaboraron más allá de las fronteras de sus países (ambos norteamericanos) en el diseño del asombroso Libro Desplegable. Estudiante de ingeniería, a Grant siempre le han fascinado los libros desplegables y quería aplicar algunas de sus ideas mecánicas a los bricks LEGO para envolverlas después en un modelo LEGO de un libro. Jason, programador de computadoras, se unió más tarde al proyecto. Luego de varias iteraciones y dos años de ajustes, obtuvieron un diseño que podían enviar como propuesta a LEGO Ideas.

Ambos llevan años diseñando y construyendo sus propios sets LEGO. Jason siente un particular interés por las máquinas, los robots y las esculturas cinéticas ([jkbrickworks.com](http://jkbrickworks.com)), mientras que la obsesión infantil de Grant con los diseños inspirados en el mundo de los piratas se descubre enseguida al visitar su página de Flickr ([flickr.com/photos/93970753@N05](http://flickr.com/photos/93970753@N05)).

¿Qué sintieron cuando supieron que su proyecto había sido elegido como set LEGO Ideas oficial? “¡Estaba emocionadísimo!”, explica Grant, mientras que, según Jason, fue como “caminar sobre una nube todo el día”.

“El set Fork-Lift Truck (850), de 1977, fue mi primer set Technic y cambió mi forma de ver las cosas”.

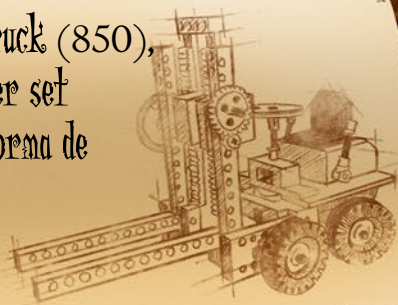

“¿Mi elemento LEGO® favorito?  
¡El quesito (referencia 54200)!  
Es la pieza LEGO más versátil de todas”.



# Conoce a los diseñadores de LEGO®:

Wesley Alan Talbott y Crystal Marie Fontan fueron los diseñadores de LEGO® que tomaron la estafeta de manos de Jason y Grant y usaron su experiencia como profesionales de LEGO para convertir la (ya brillante) idea en el Libro Desplegable LEGO que ahora tienes tú.

Para Wesley, diseñador de modelos, fue un proyecto apasionante y de gran significado, ya que él mismo había trabajado en su propio set LEGO Ideas cuando la iniciativa todavía se llamaba Cuusoo. Fue ese mismo proceso el que reavivó su interés por la construcción con bricks LEGO y, en última instancia, lo llevó a trabajar para LEGO como diseñador. Tenía mucho interés en trabajar con Jason y Grant en los preparativos para la producción del Libro Desplegable.

En cuanto a Crystal, diseñadora gráfica, era su primer proyecto LEGO Ideas y, como fan de las historias y los cuentos de hadas, tenía muchísimas ganas de diseñar los gráficos y personajes del set; quiso aprovechar la oportunidad para darle un toque de novedad a algo tan antiguo y emblemático, y disfrutó mucho convirtiendo en minifiguras a algunos de sus personajes de cuentos de hadas favoritos.



# Los libros desplegados a lo largo de la historia

La historia de los libros desplegados es larga y fascinante: son aun anteriores a la cultura de la imprenta y se remontan al siglo XIII. Curiosamente, los primeros libros desplegados no eran dispositivos de narración en absoluto y, desde luego, no estaban dirigidos a los niños.

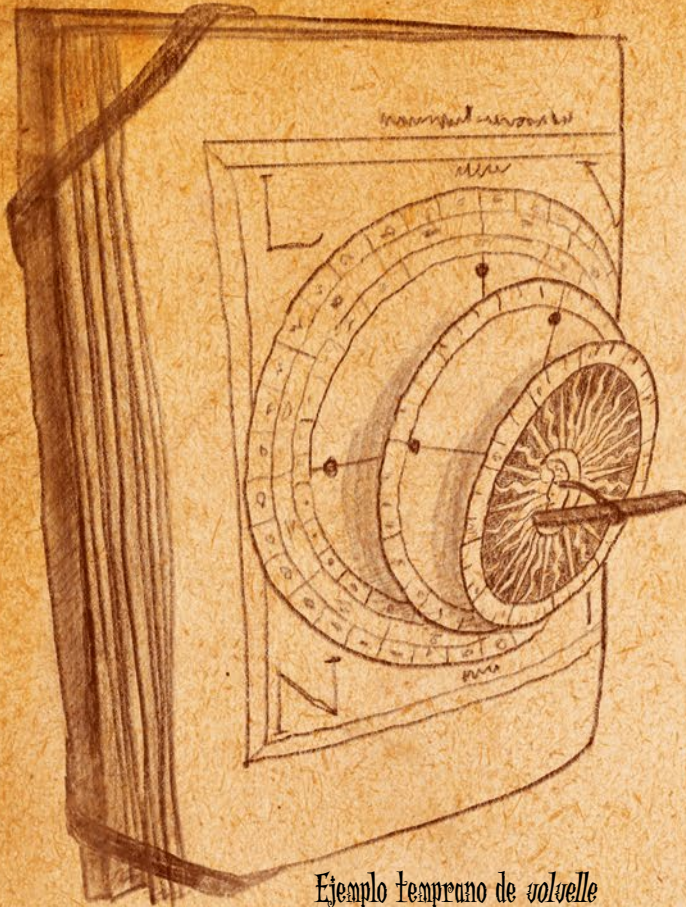

Ejemplo temprano de *volvelle*

En opinión de algunos, fue Ramón Llull (ca. 1232-1315), un místico y poeta catalán, quien creó las primeras estructuras interactivas de papel con mecanismos móviles conocidos como *volvelle* para ilustrar su aventura filosófica en busca de la verdad. Su versión se conoce como círculo luliano.



Círculo Luliano



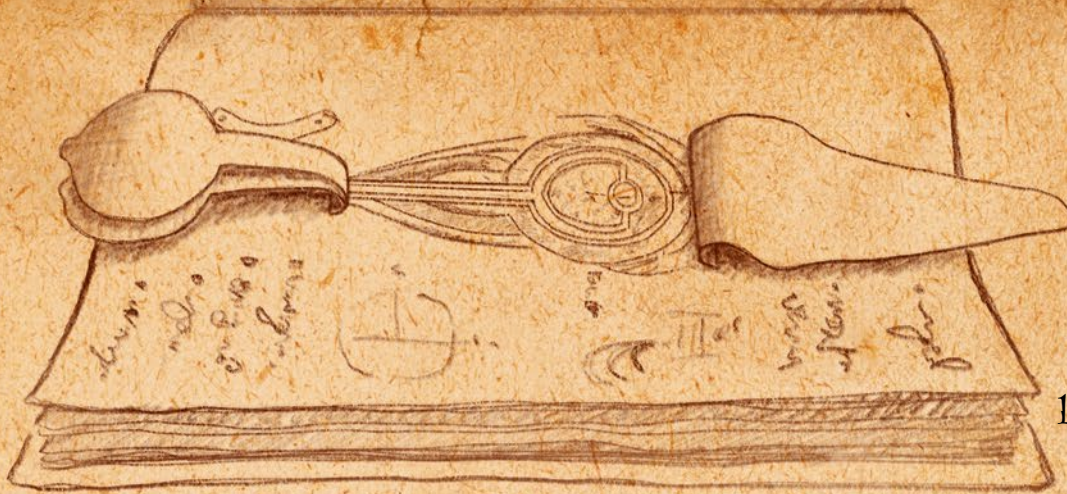

El siglo XIV fue testigo del desarrollo de libros con piezas dobladas, muy populares entre los estudiantes de medicina que querían aprender anatomía humana, pues ilustraban con viveza el funcionamiento interno del cuerpo.

Libro con piezas dobladas

De mediados del siglo XVIII e inspirados en los escenarios de las obras de teatro son los libros túnel o "para fisgones", compuestos por una serie de páginas unidas con tiras de papel en acordeón a los lados, con un agujero en la portada. A través de dicho agujero, uno podía "fisgar" dentro y ver todo el libro desde delante hacia atrás, descubriendo una historia dimensional en su interior.

No fue sino hasta casi acabado el siglo XVIII que se aplicaron técnicas desplegadas o de "ingeniería de papel" a libros diseñados para el entretenimiento y, por fin, para niños, coincidiendo con el desarrollo del género de la literatura infantil en aquella época.

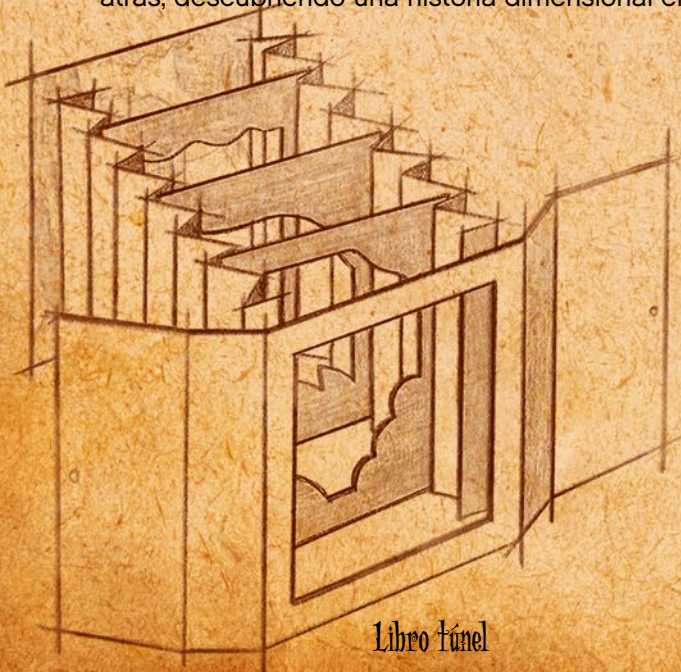

Libro túnel



Libro para niños

# Caperucita Roja

La historia de la joven de la capa roja tiene su origen en el siglo X y está profundamente arraigada en el folclore de muchos países europeos. La primera versión impresa fue escrita por Charles Perrault y posteriormente revisada por los hermanos Grimm, que ampliaron y cotejaron también otras historias antiguas como esta y contribuyeron en enorme medida al nacimiento del género de los cuentos de hadas. Existen varias versiones de esta popular historia, algunas

mucho más oscuras que otras. A grandes rasgos, habla de una joven vestida con una capa roja con capucha que va a visitar a su abuela en el bosque y se encuentra en el camino con un lobo disfrazado de su abuelo. Este set contiene todos los elementos necesarios para interpretar la versión de la historia que más te guste. ¿Qué sucederá a continuación? Tú decides...

¡Crea tu propio cuento de hadas!



# Jack y las habichuelas mágicas

Este antiguo cuento de hadas inglés es en realidad sólo uno de los muchos en los que aparece el personaje llamado Jack. Hay quien dice que la historia se basa en un relato folclórico de hace 5000 años, conocido como *El niño que robó el tesoro del ogro*.

En el cuento, Jack se lleva al mercado la vaca de la familia para venderla, pero, en lugar de eso, cambia la vaca por unas habichuelas mágicas. La familia es muy pobre, así que



su madre se enoja mucho cuando vuelve a casa con un puño de habichuelas en lugar de dinero. Furiosa, las arroja a la tierra y, al día siguiente, un enorme tallo de habichuelas ha crecido en su huerto. Jack lo escala, encuentra el castillo de un gigante y le roba su tesoro... Fee Fi Fo Fum! Lo que le pasa a Jack después, cuando el gigante lo descubre, ¡lo decides tú!

Construye tu propia historia...

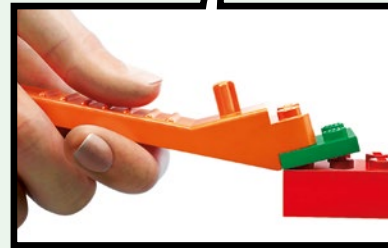
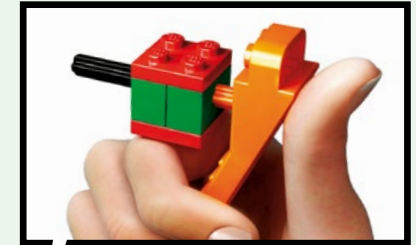
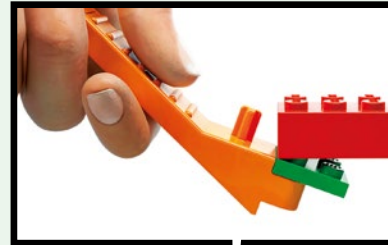

[LEGO.com/brickseparator](https://LEGO.com/brickseparator)

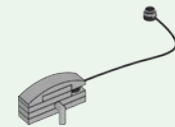
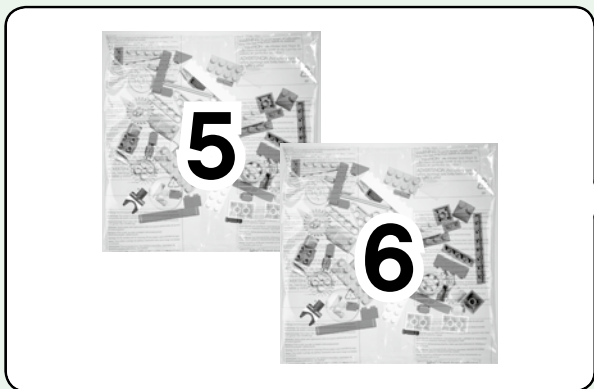
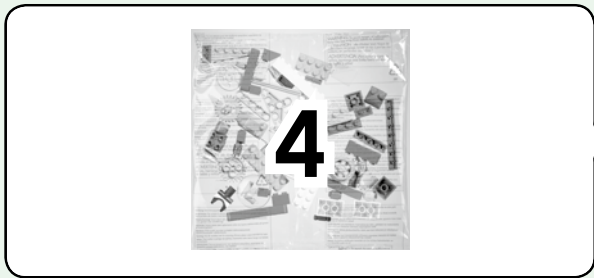
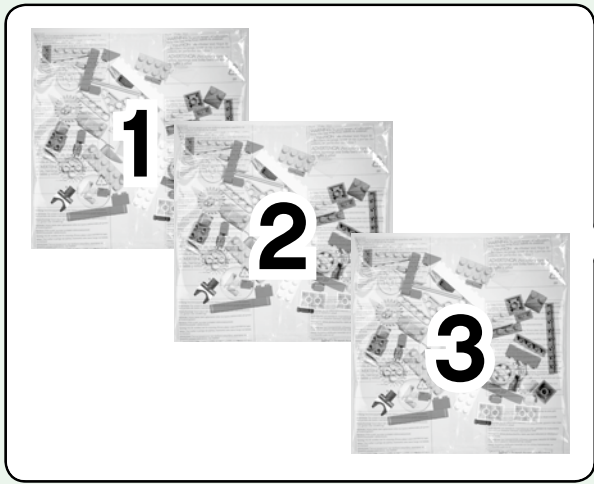

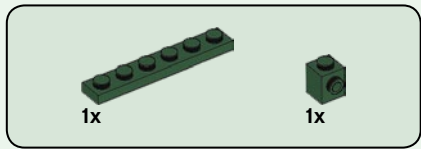
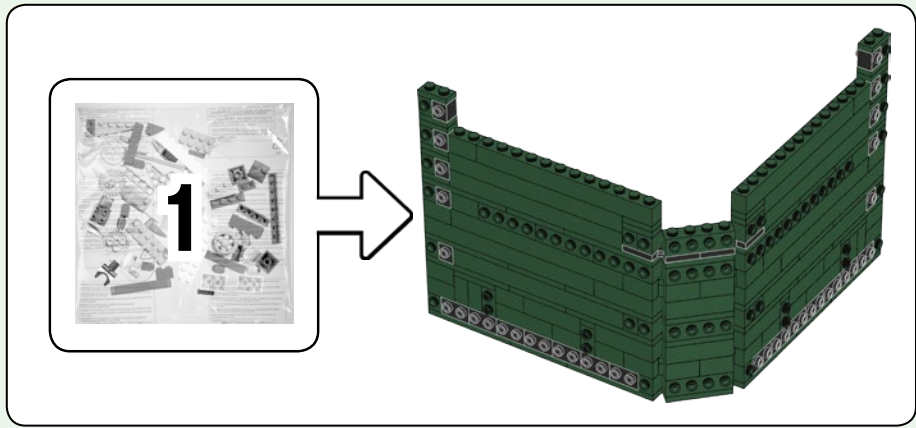

1

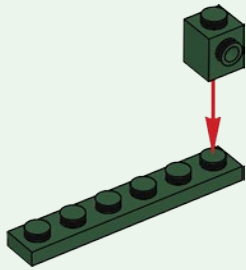

2

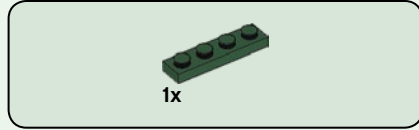
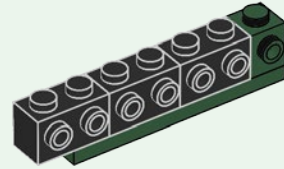

3

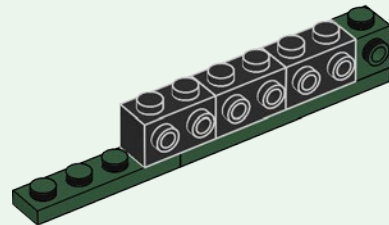

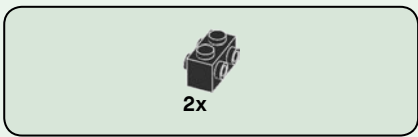

4

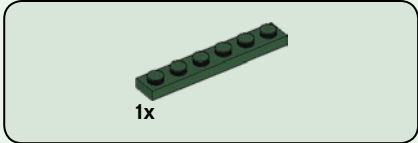
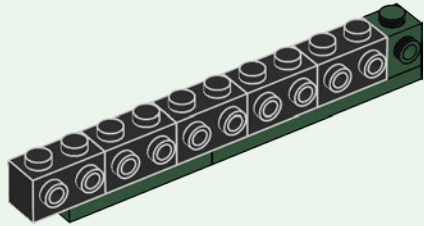

5

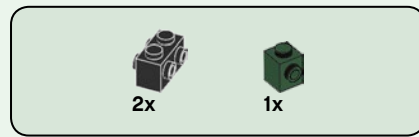
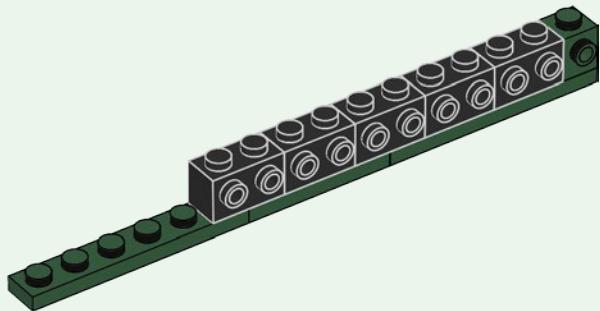

6

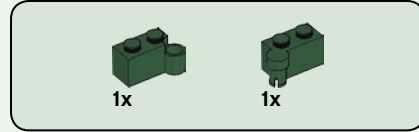
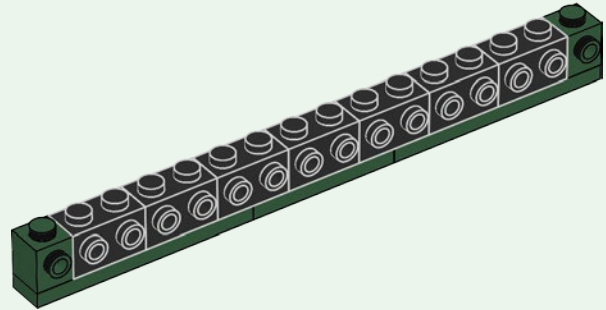

7

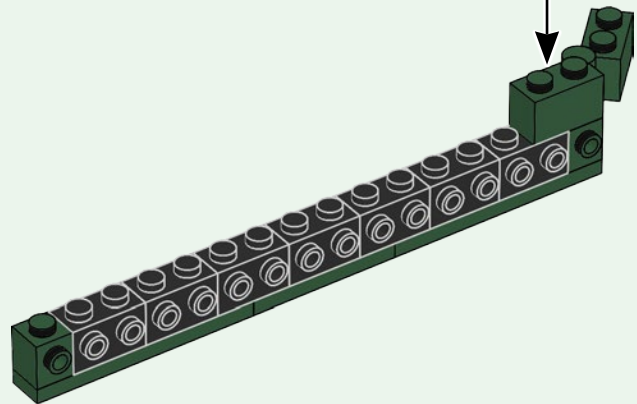
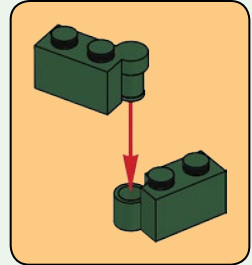

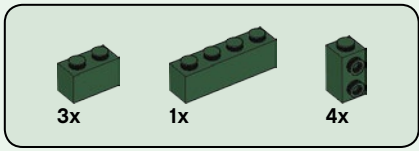

8

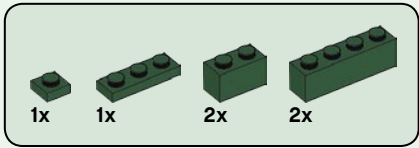
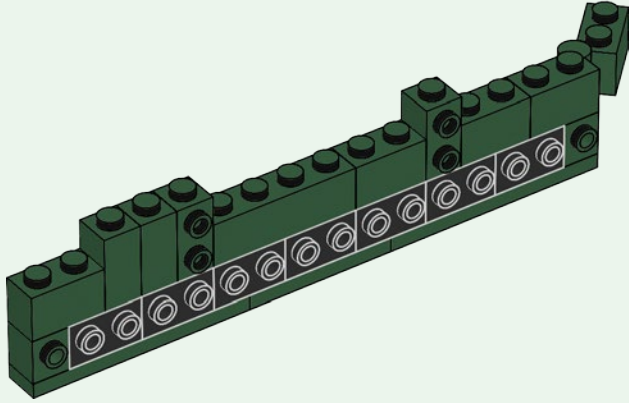

9

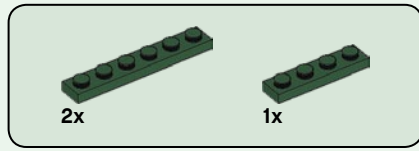
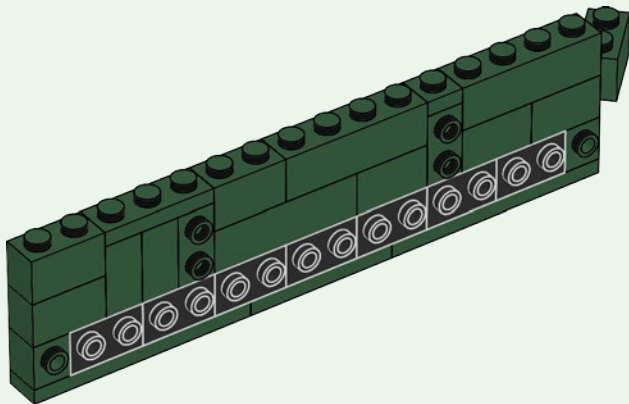

10

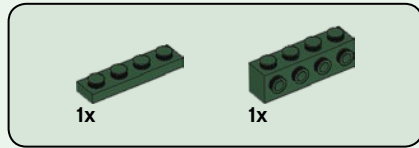
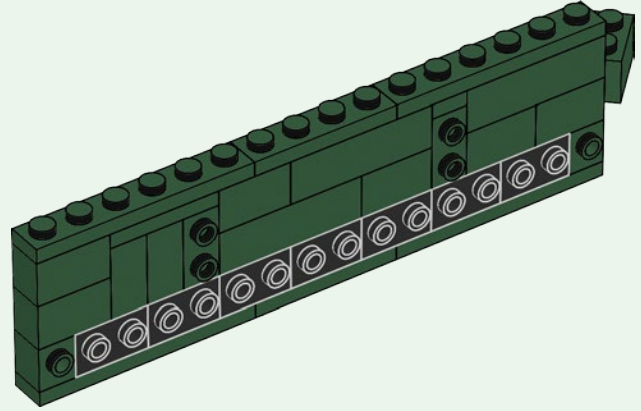

11

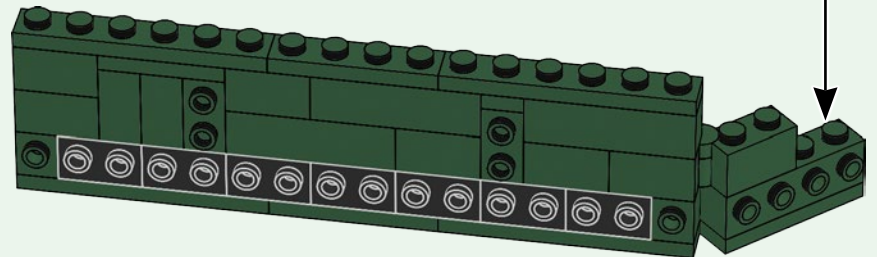
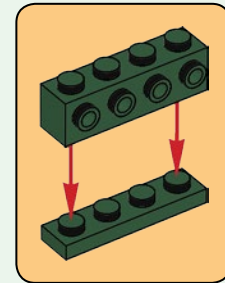



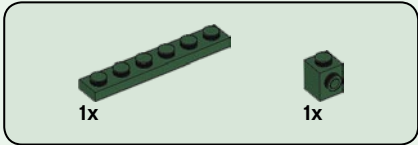
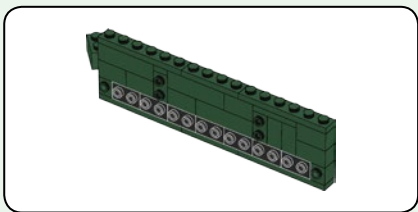

12

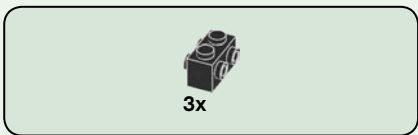
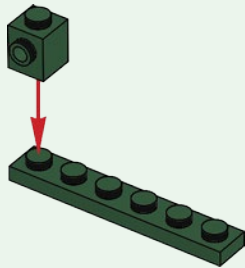

13

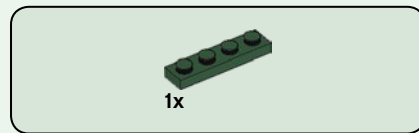
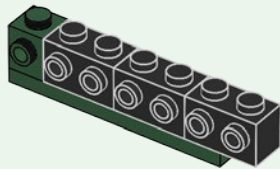

14

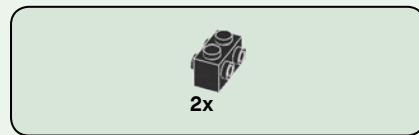
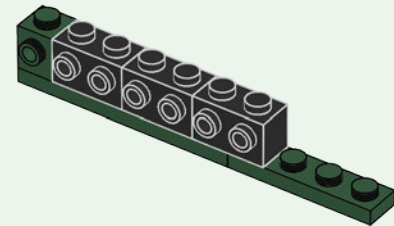

15

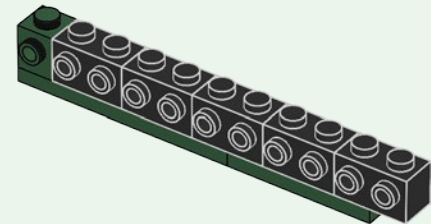

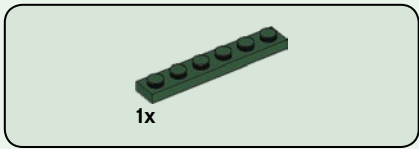

16

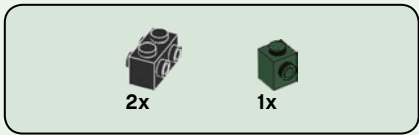
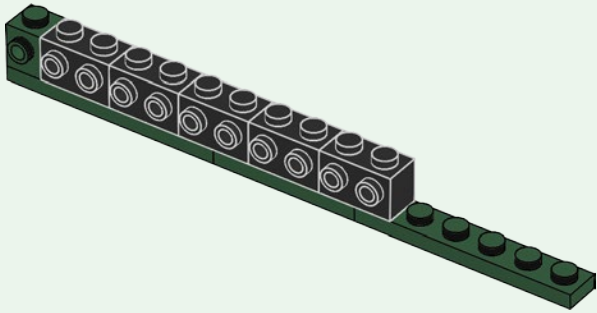

17

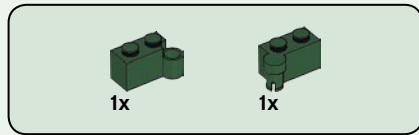
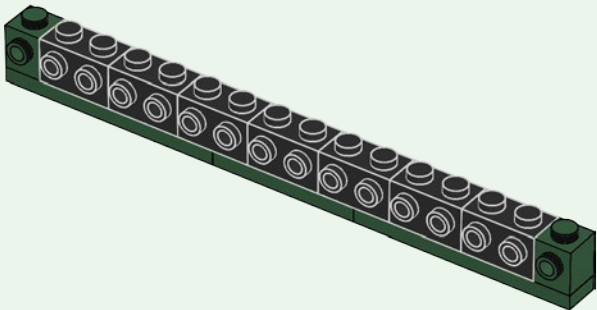

18

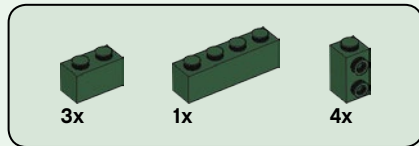
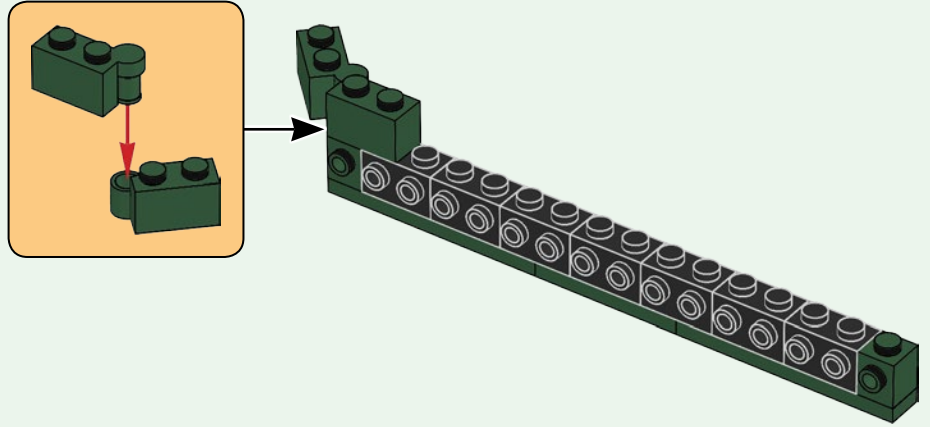

19

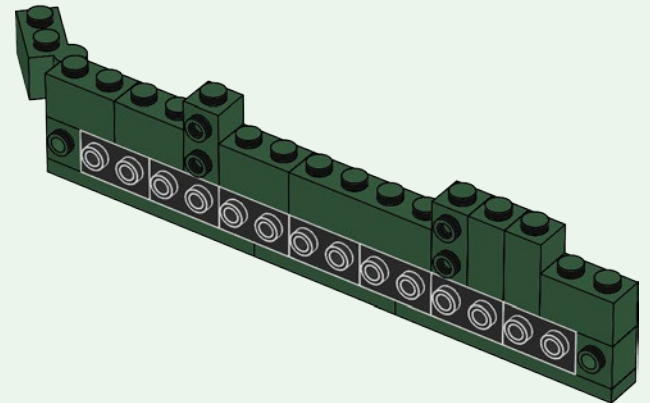

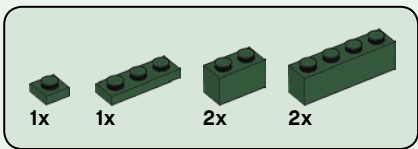

20

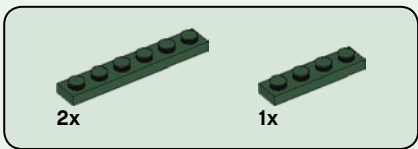
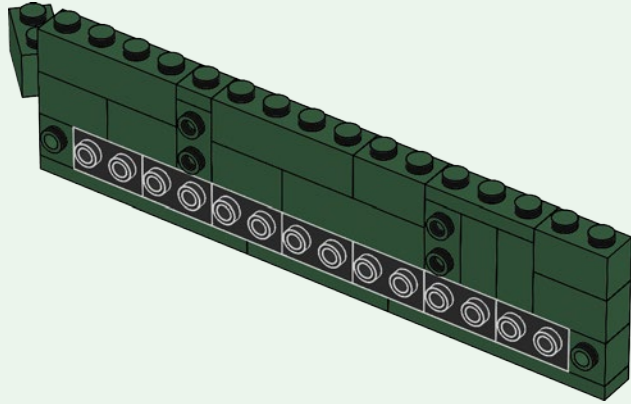

21

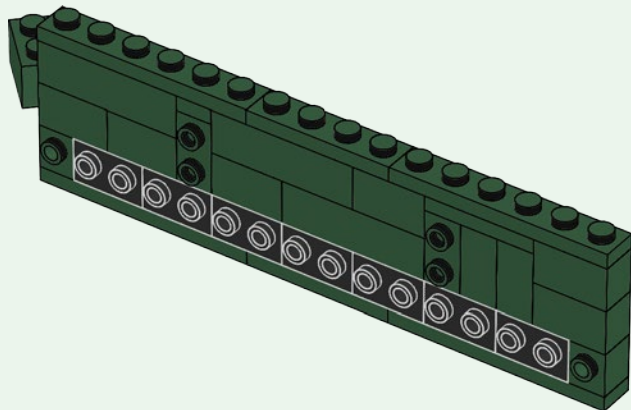

22

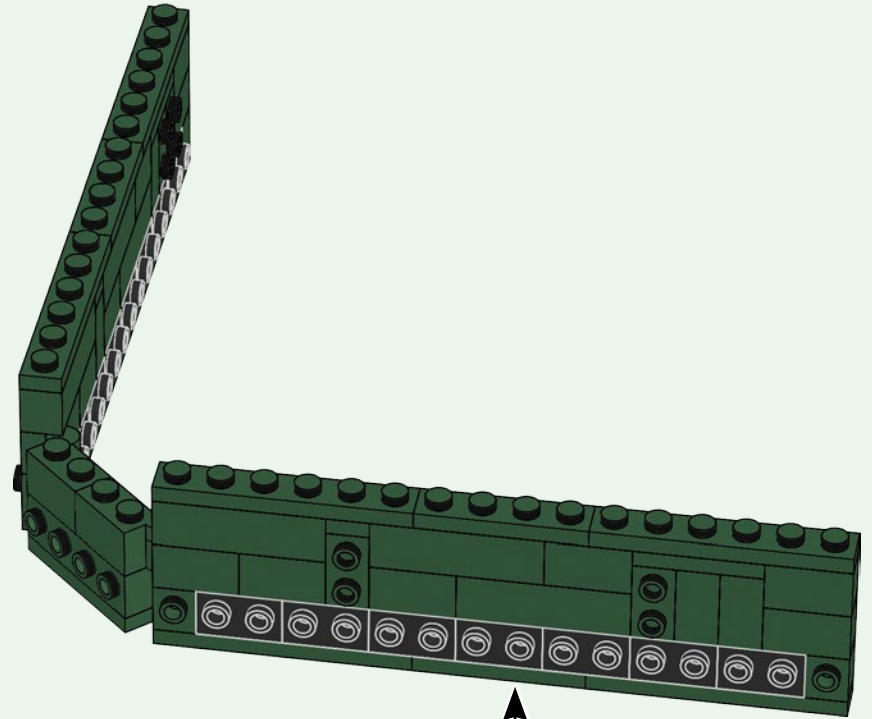

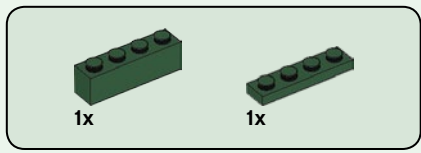

23

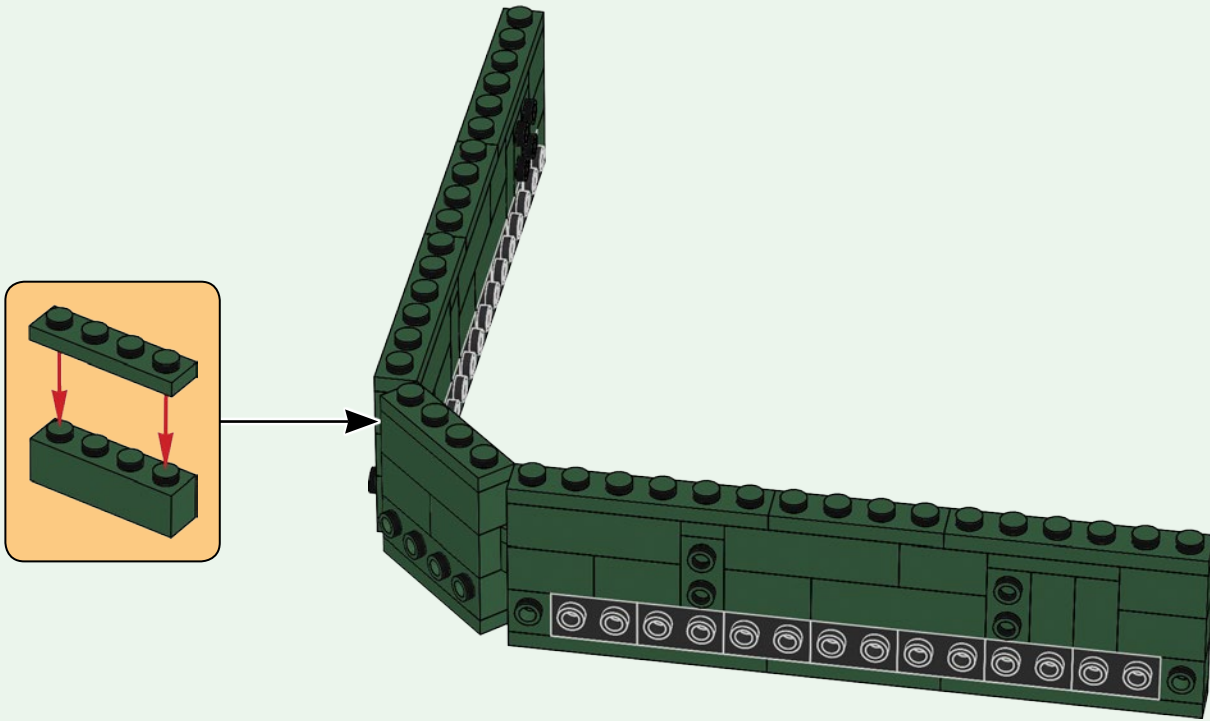

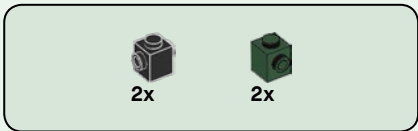

24

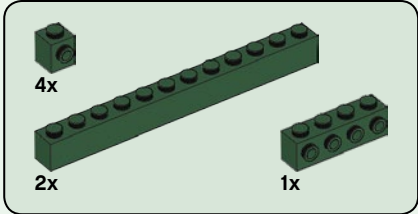
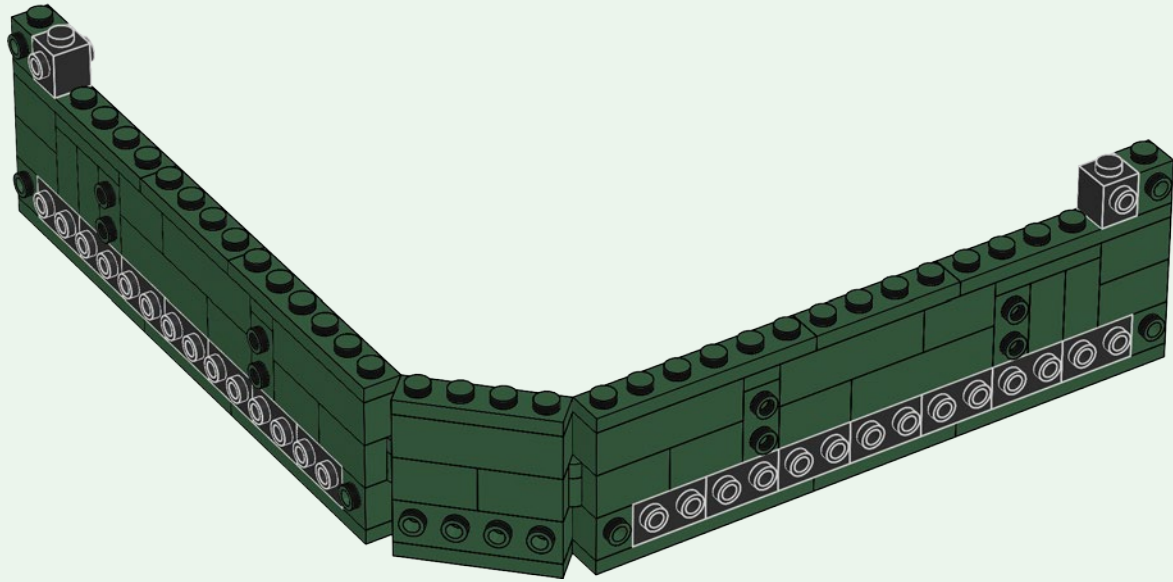

25

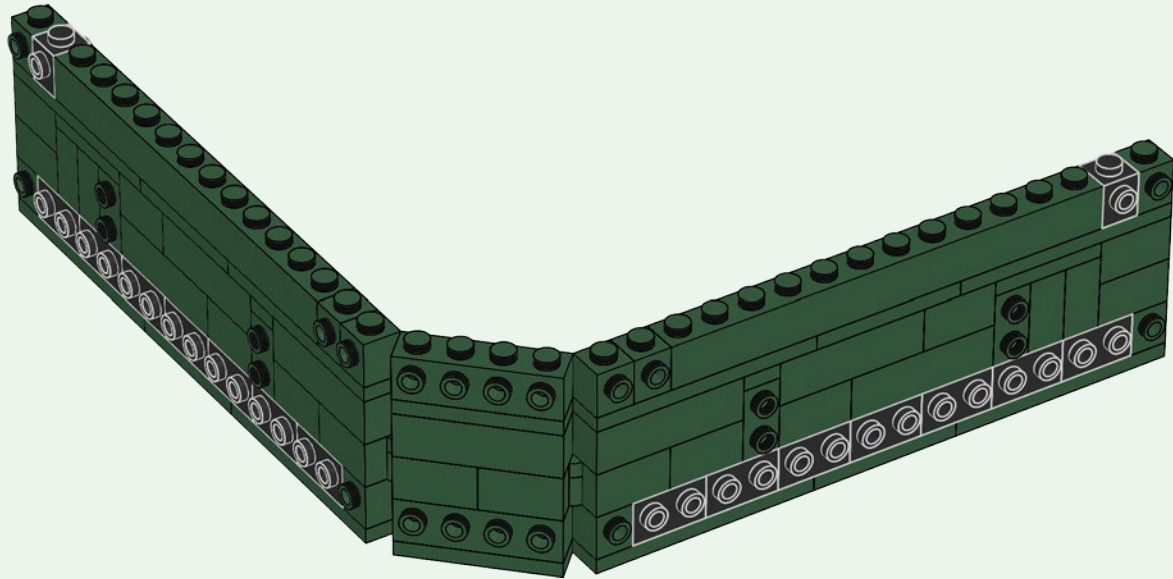

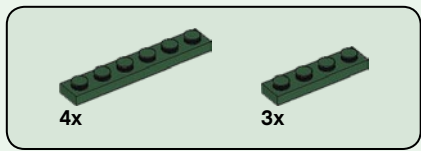

26

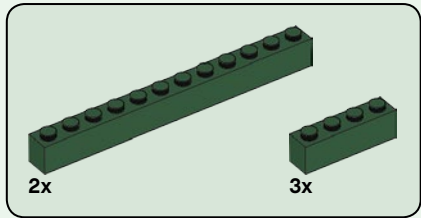
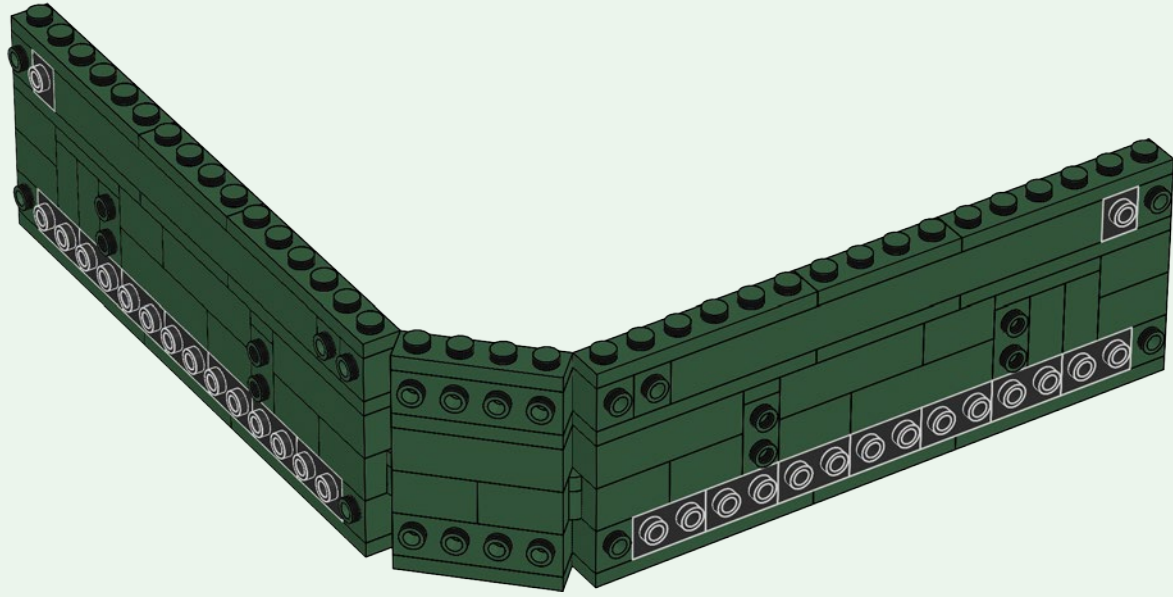

27

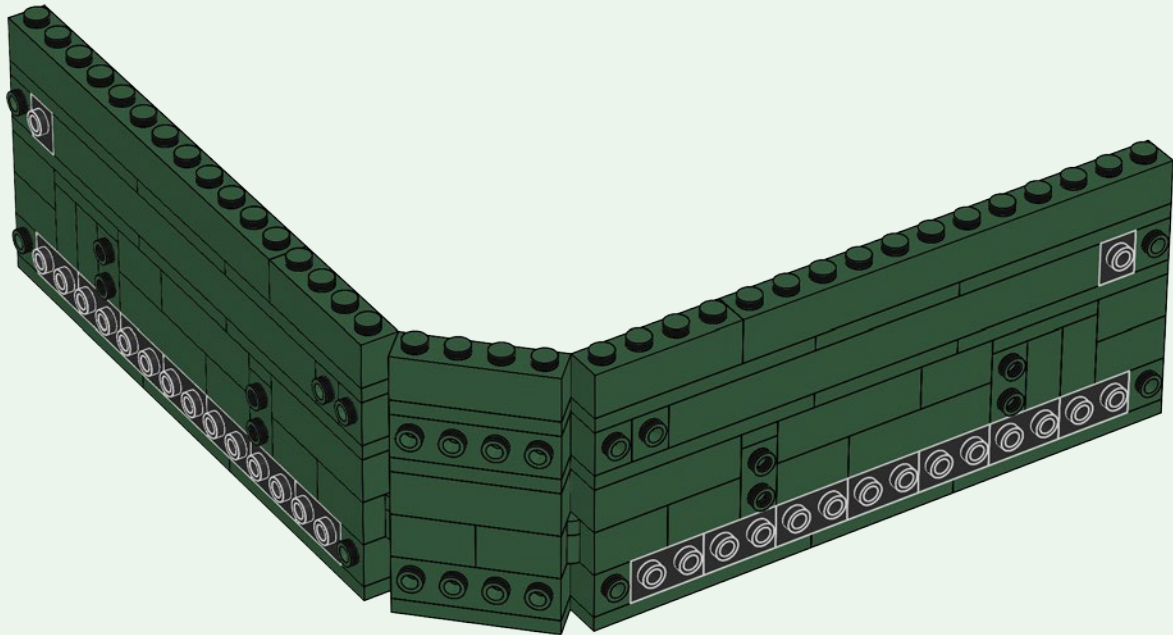

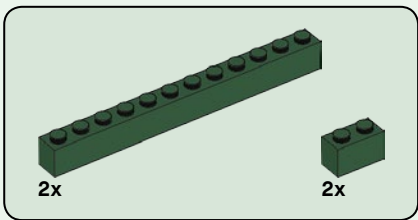

28

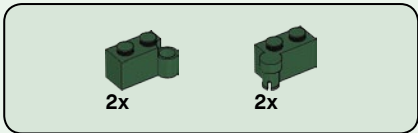
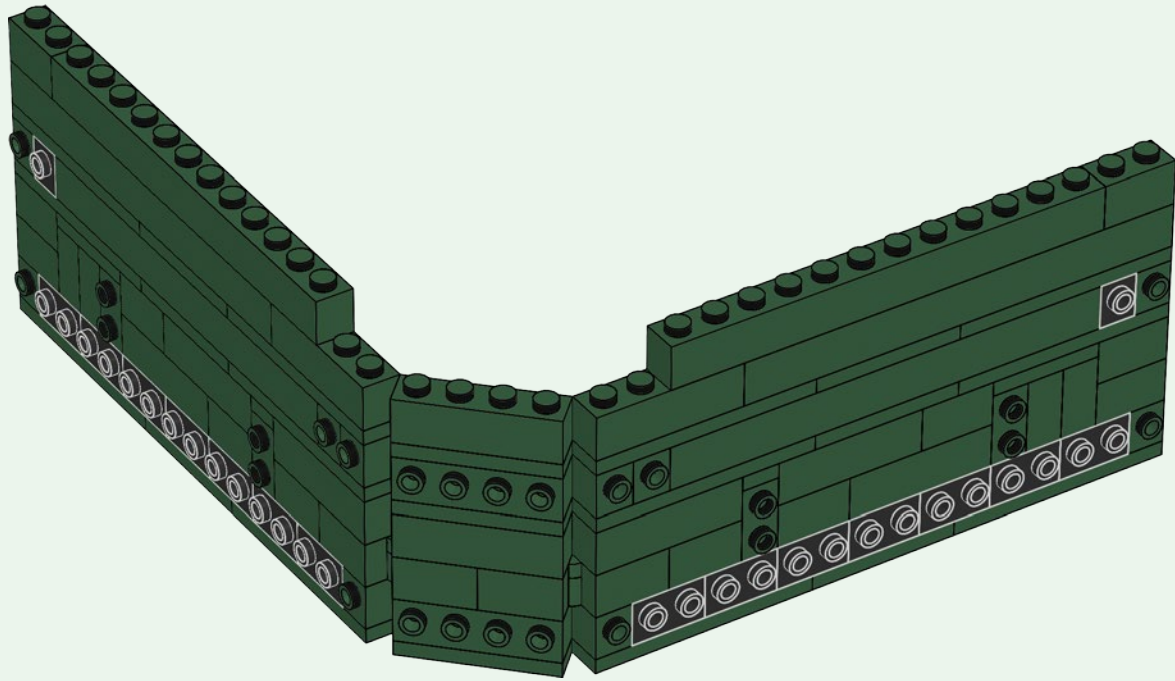

29

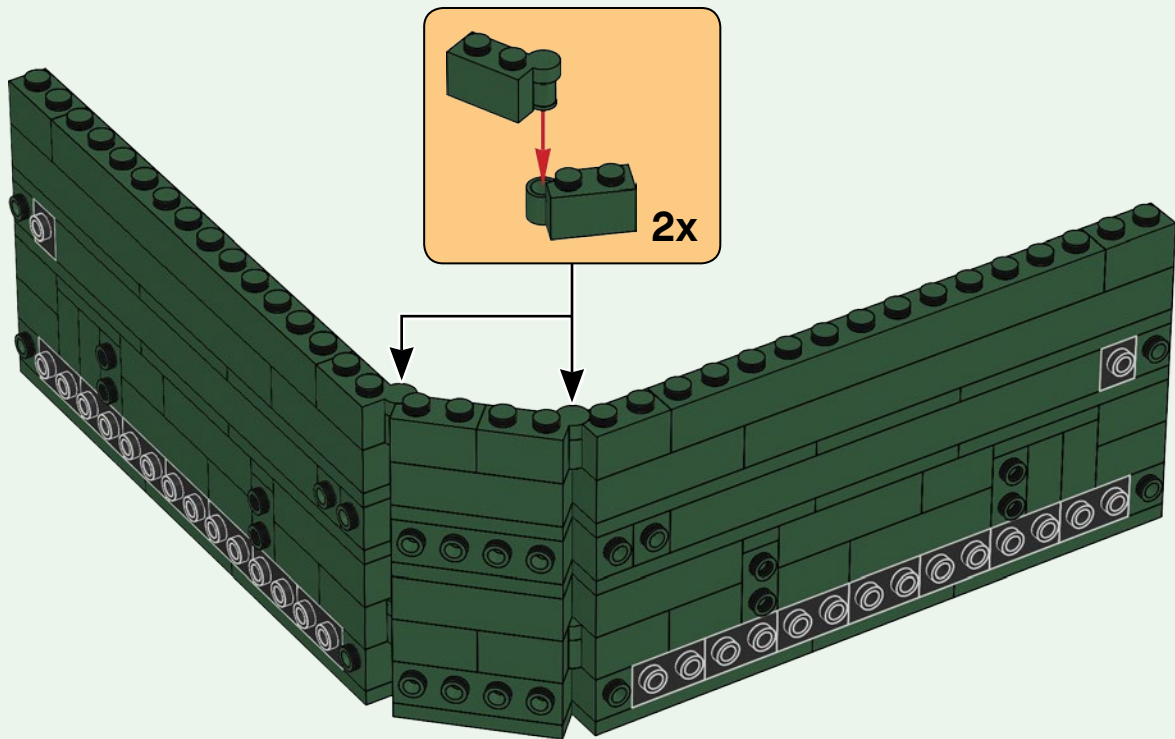

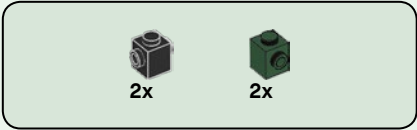

30

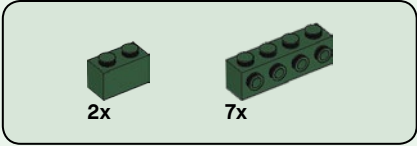
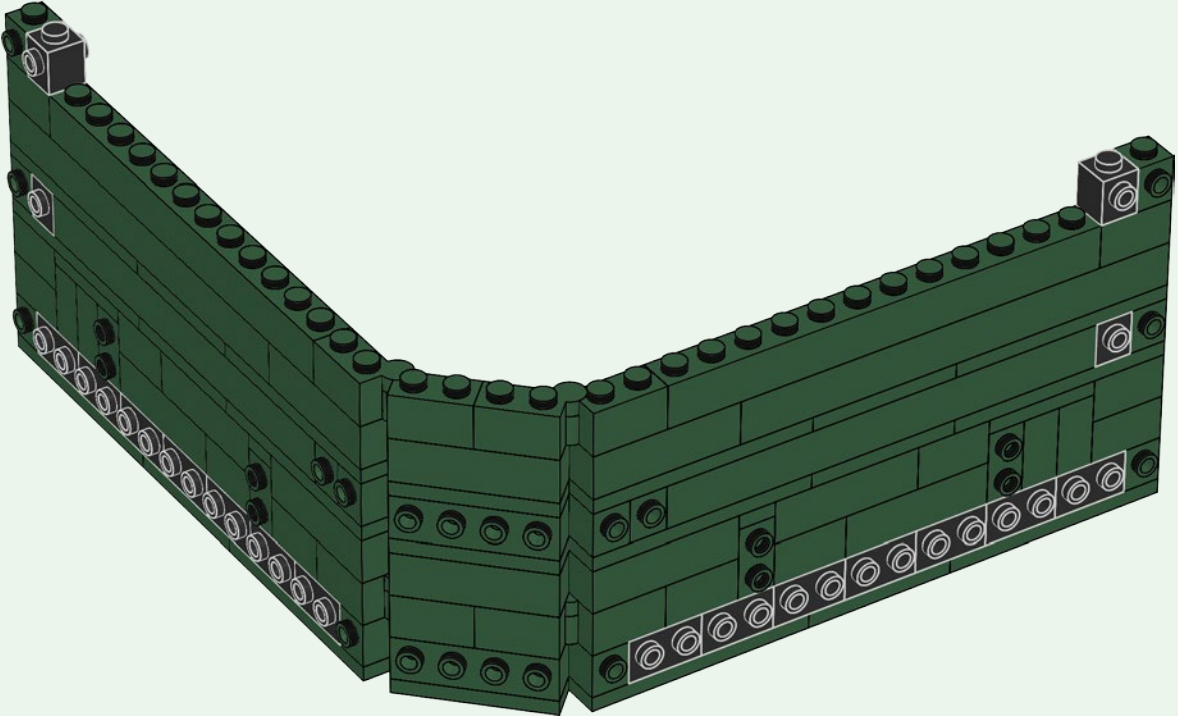

31

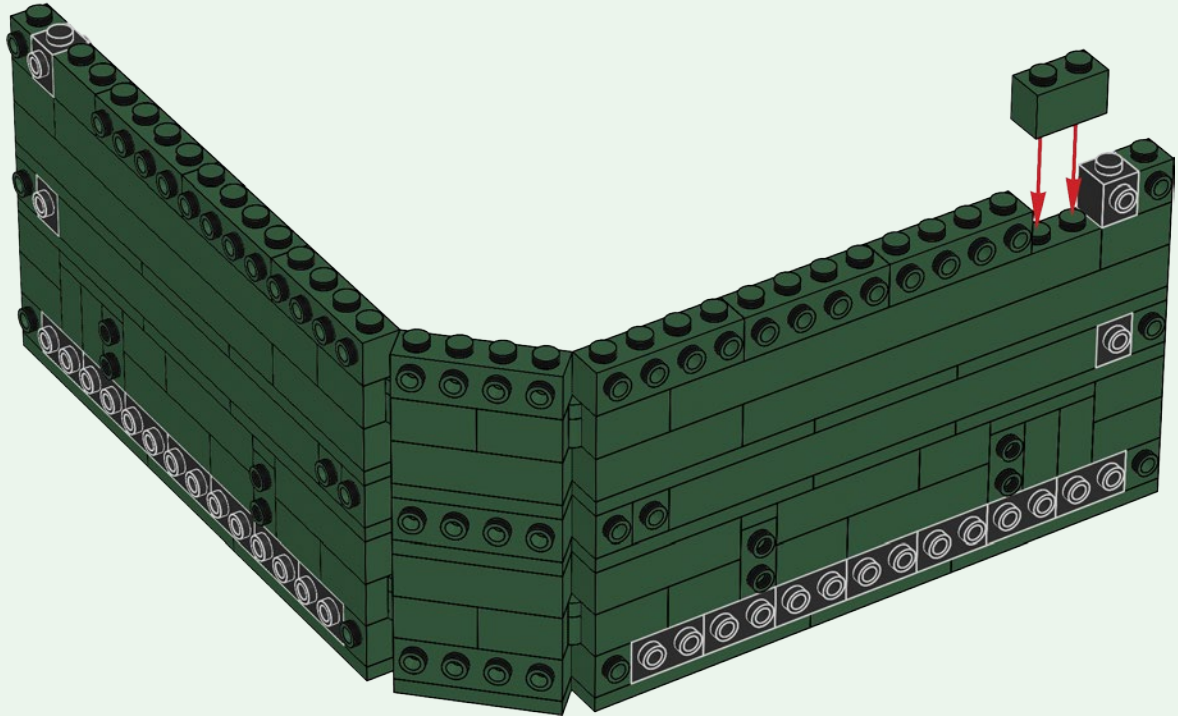



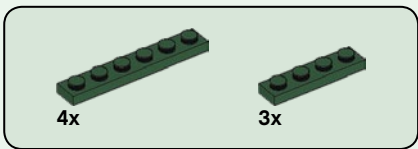

32

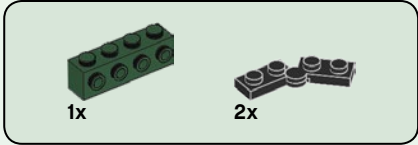
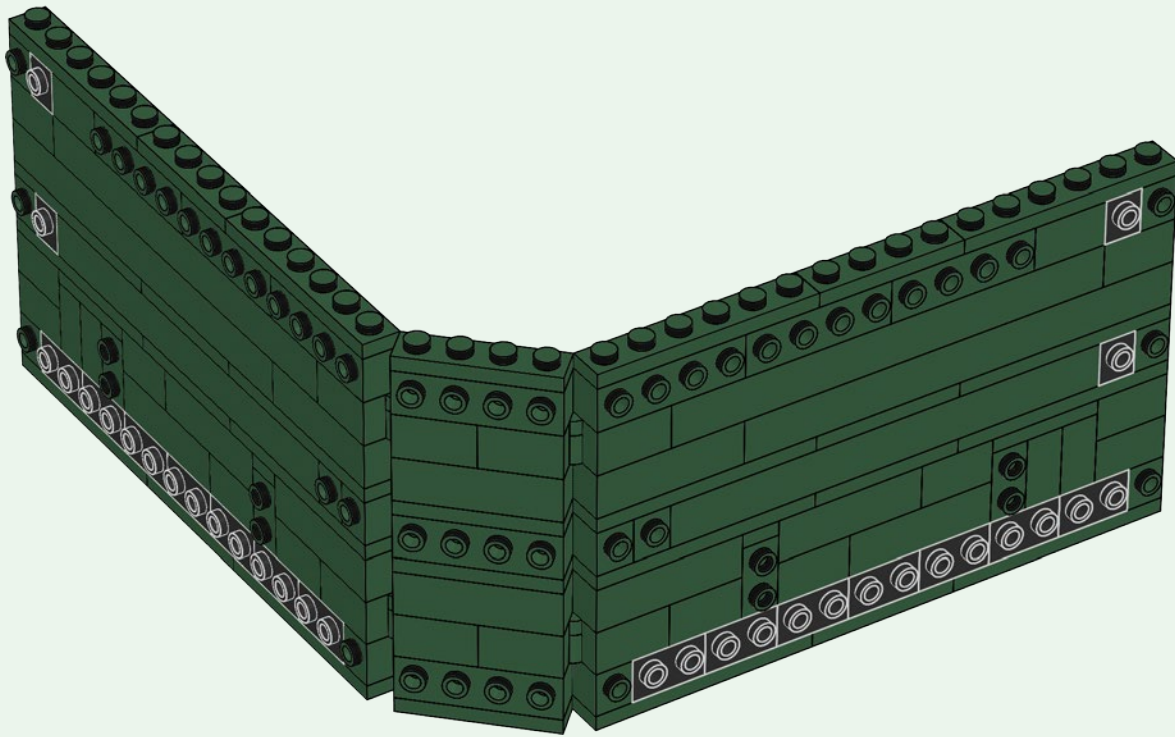

33

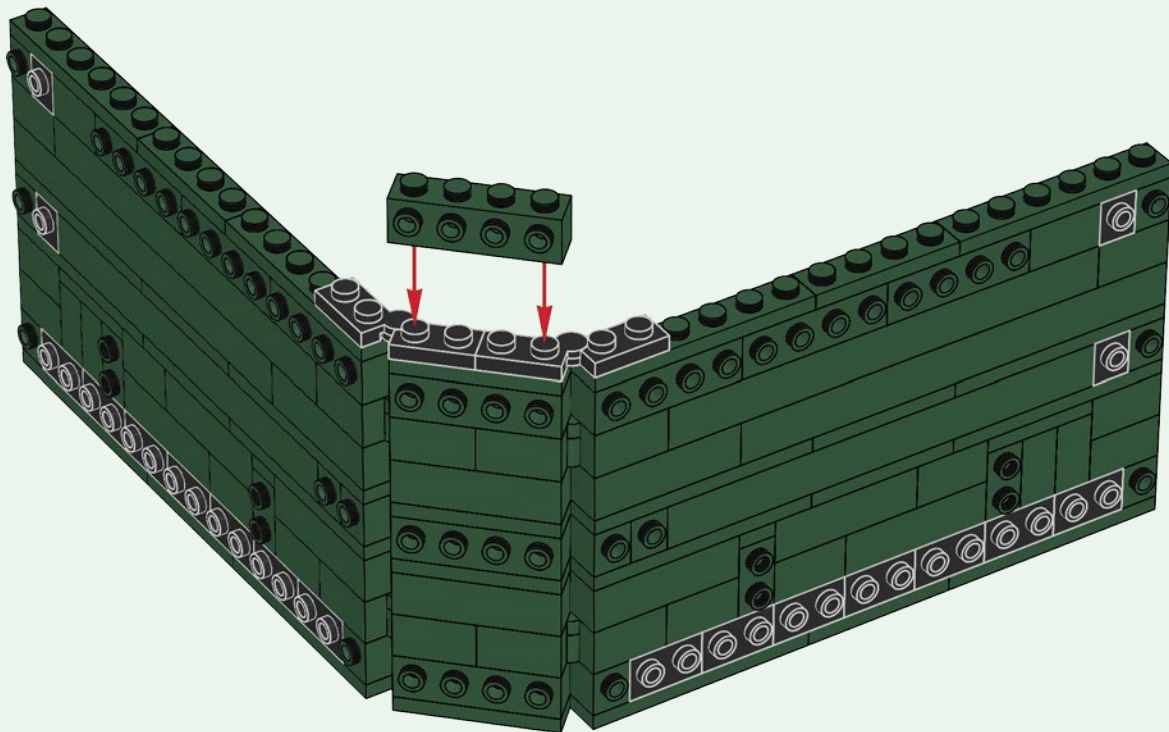

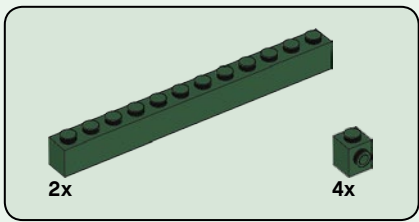

34

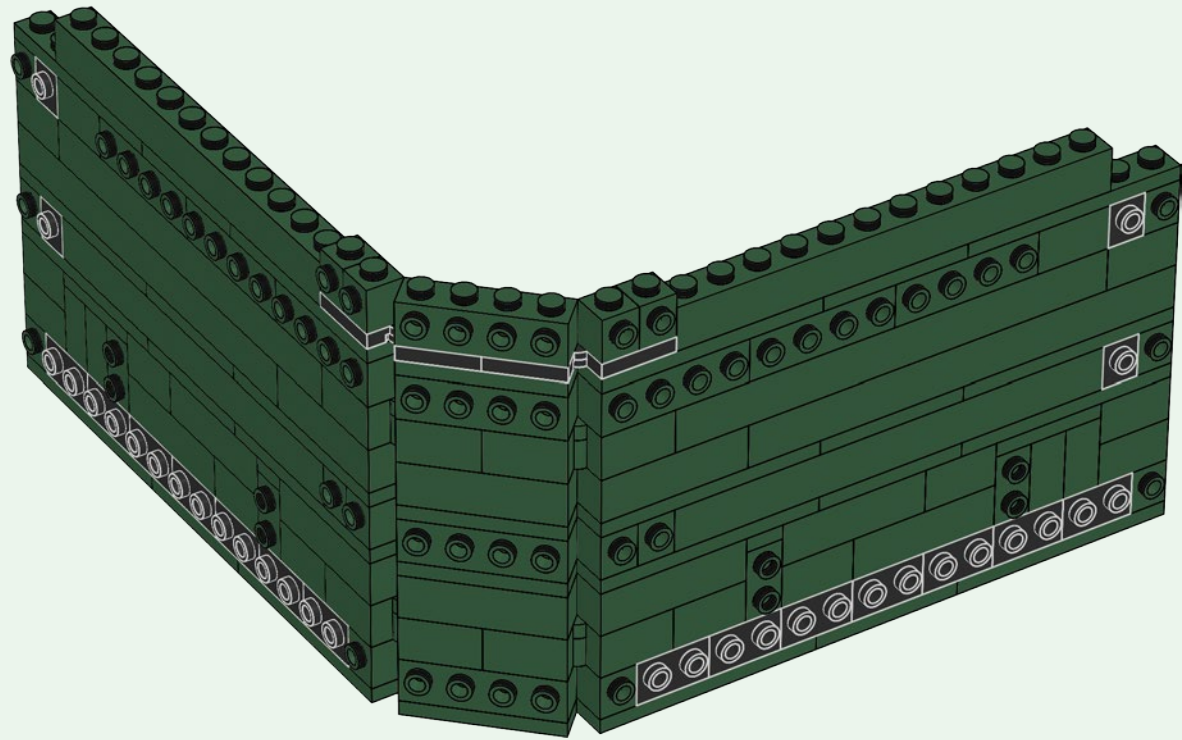

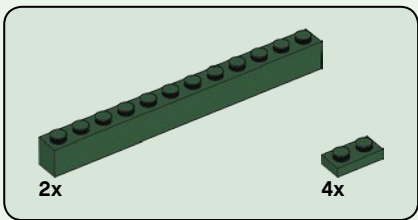

35

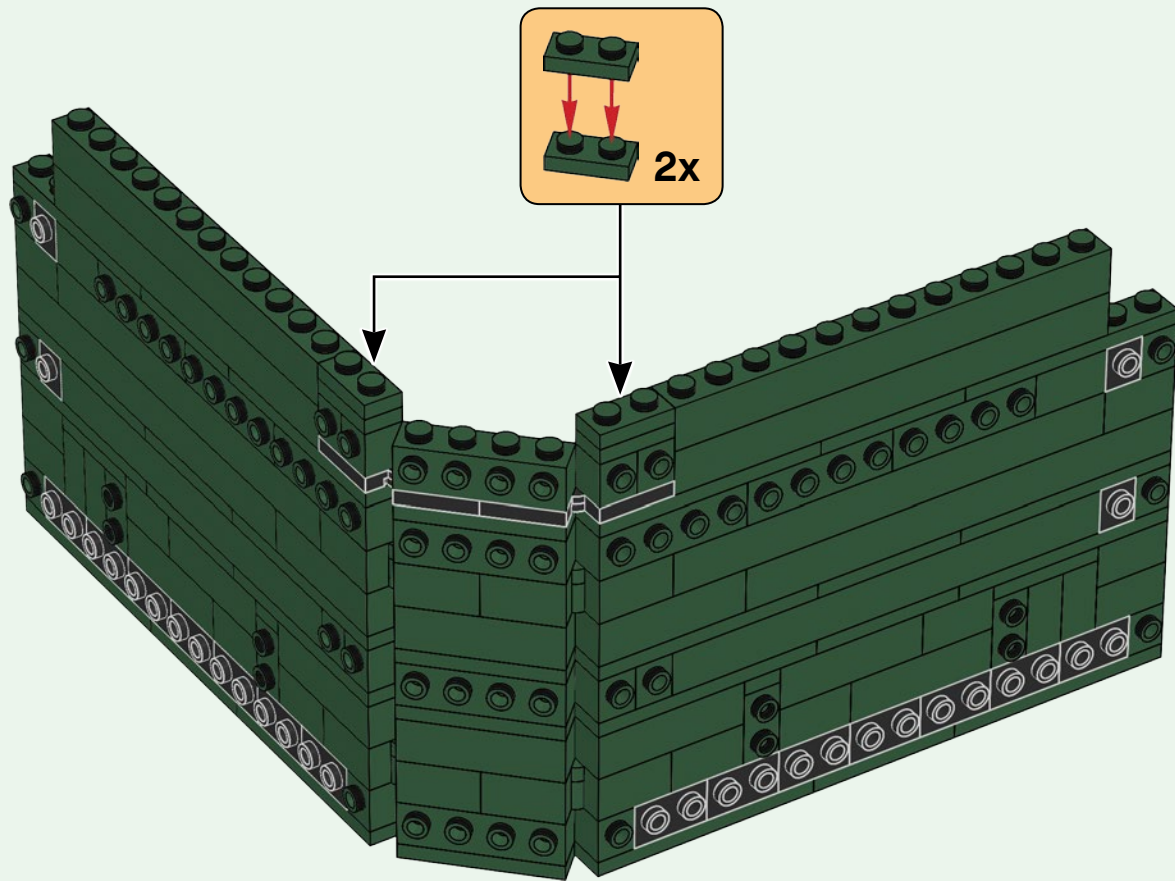

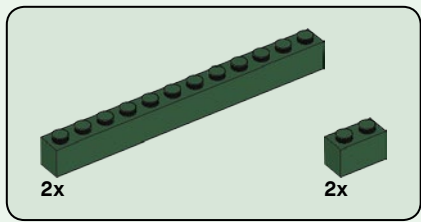

36

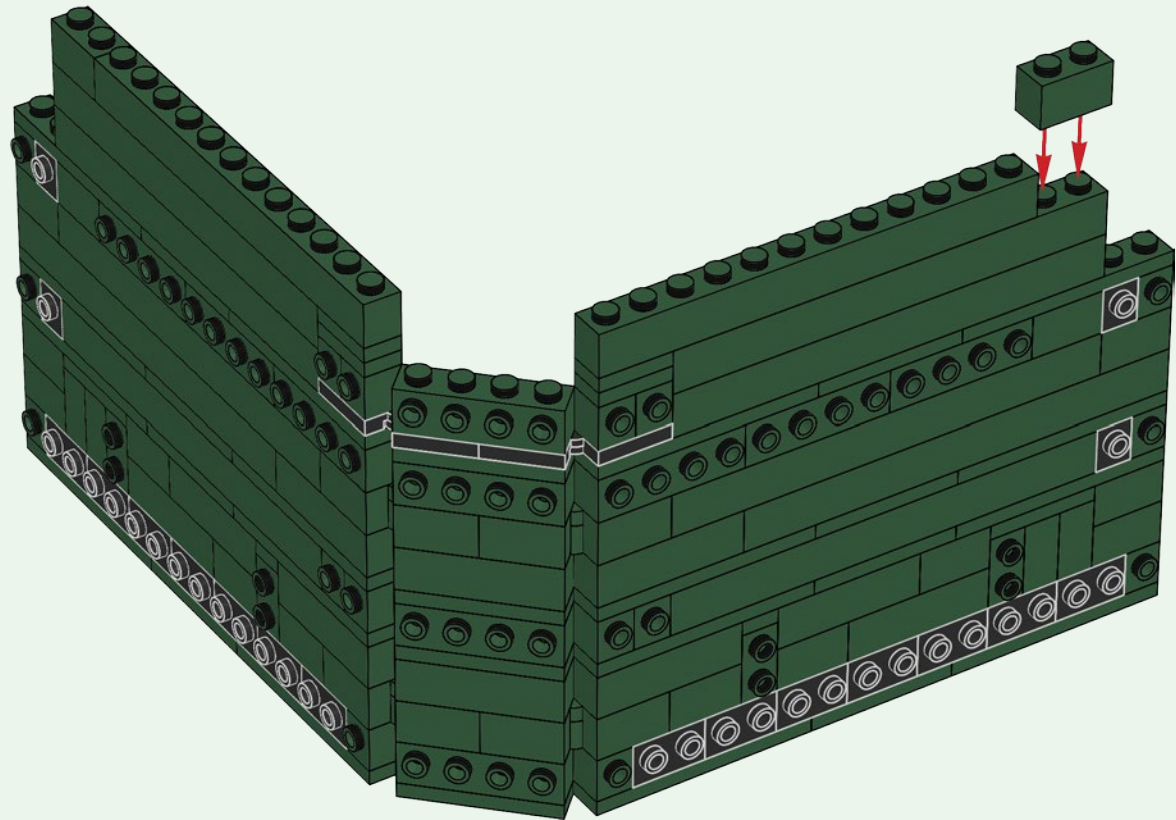

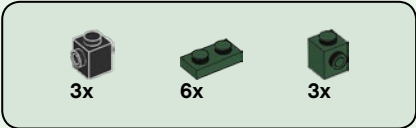

37

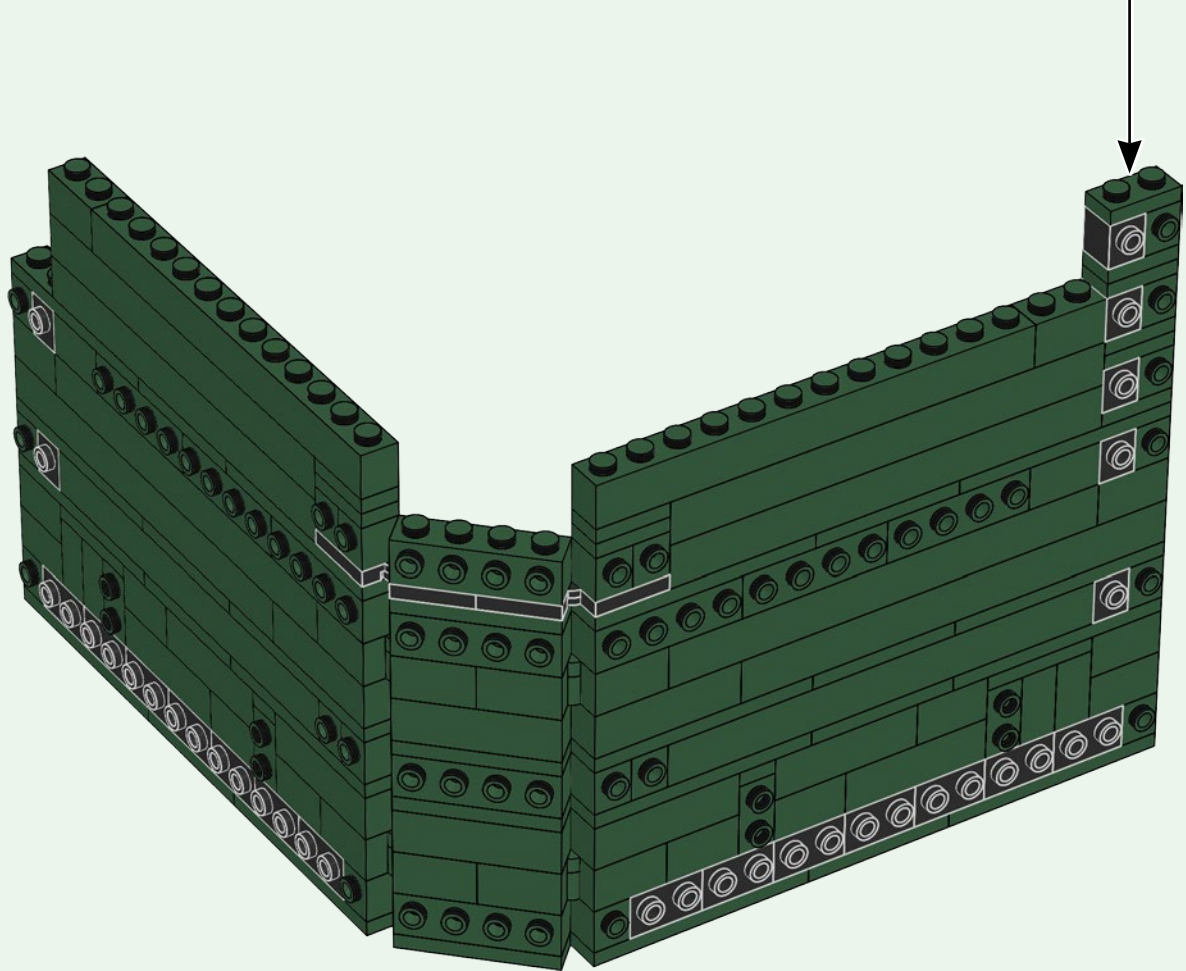
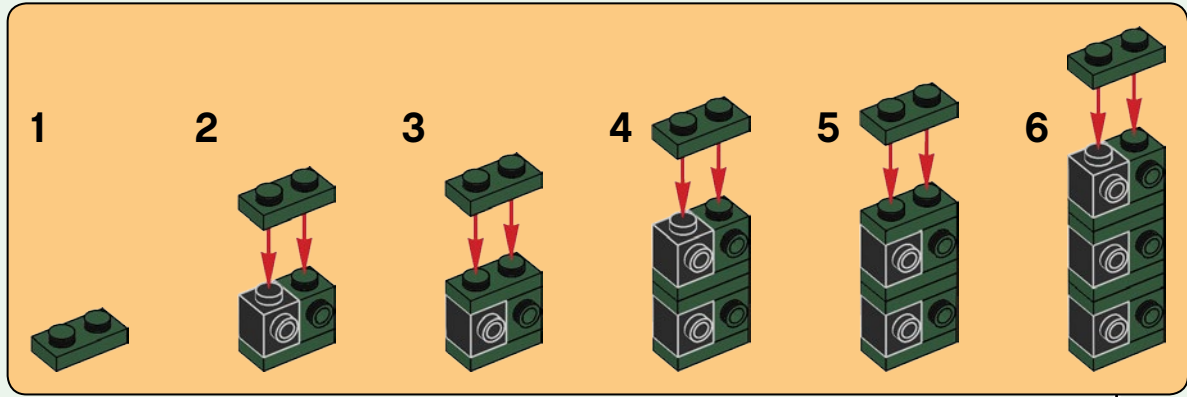

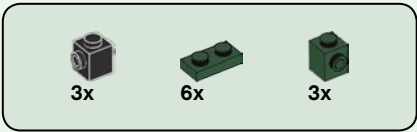

# 38

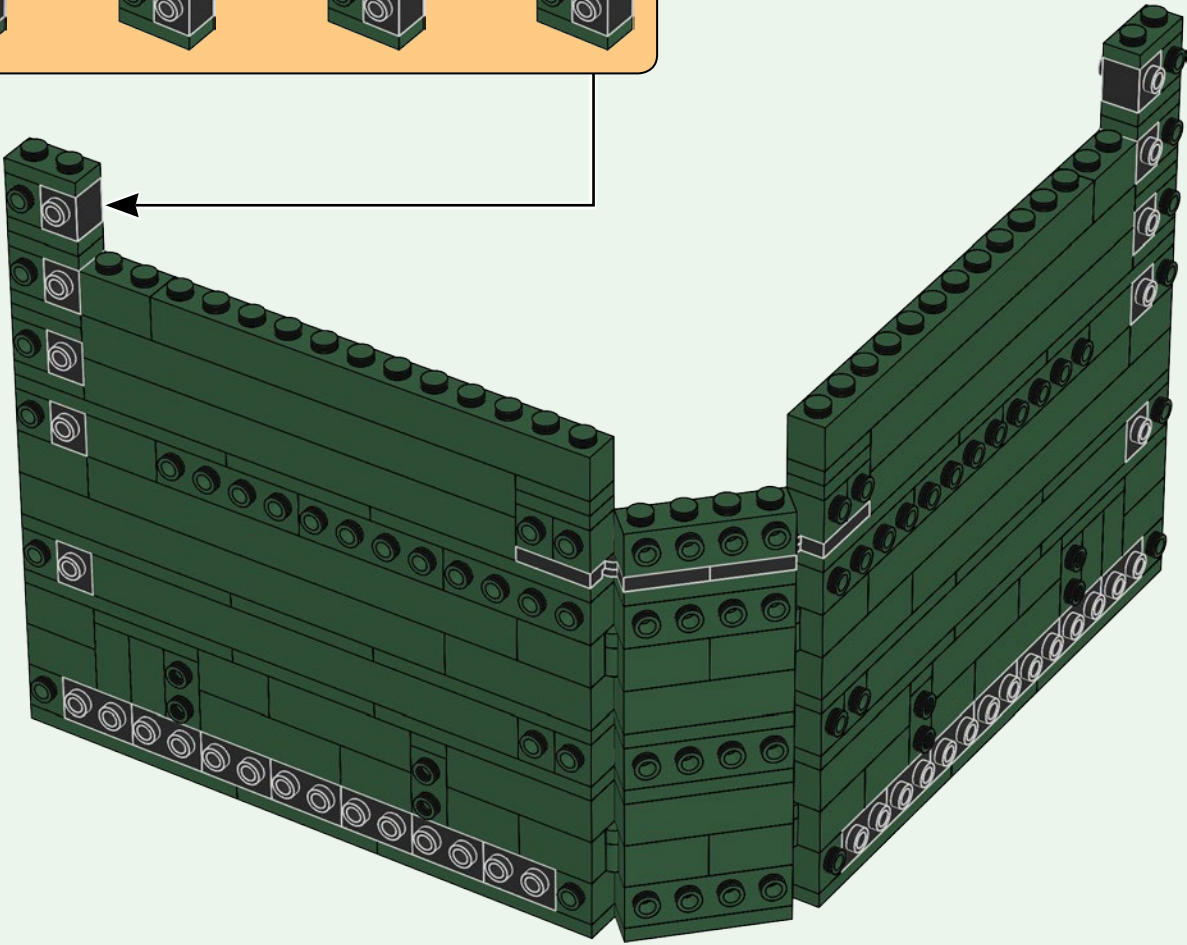
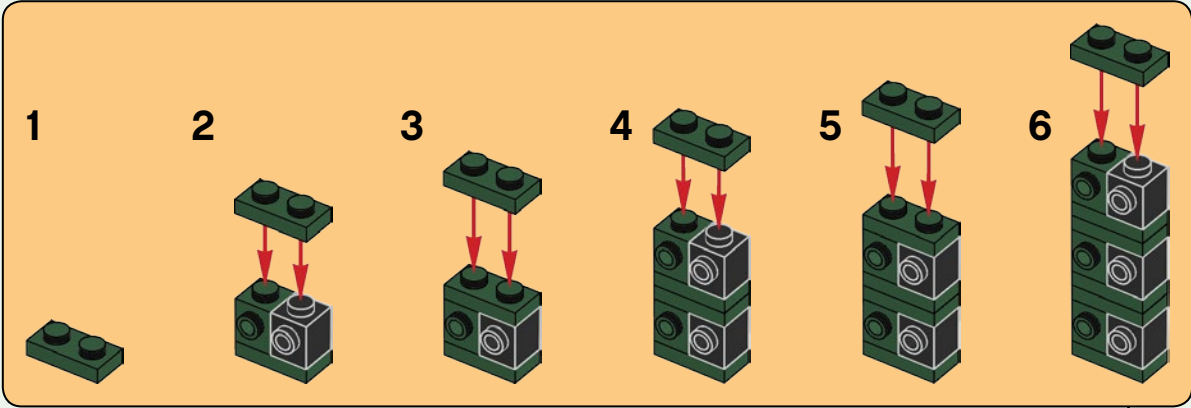

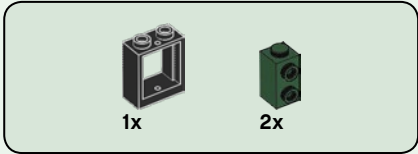
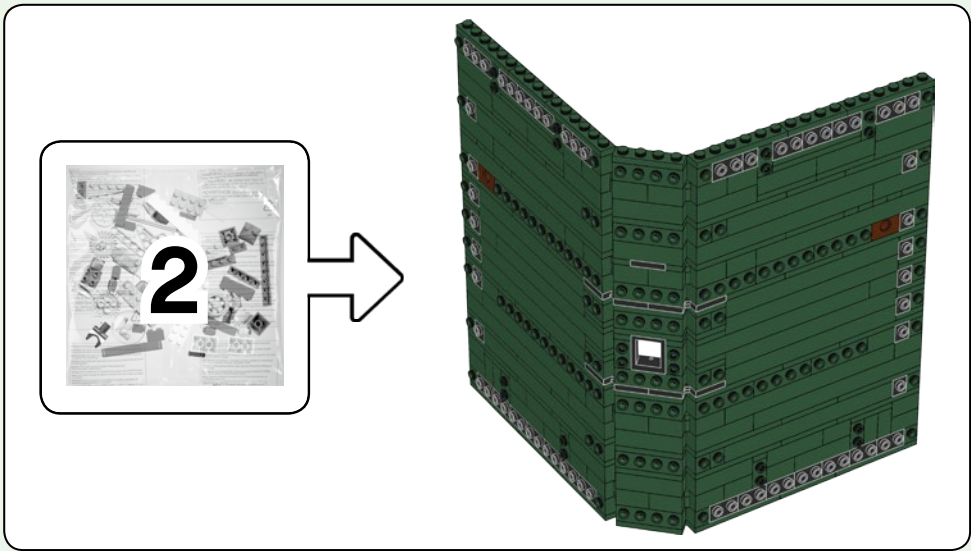

39

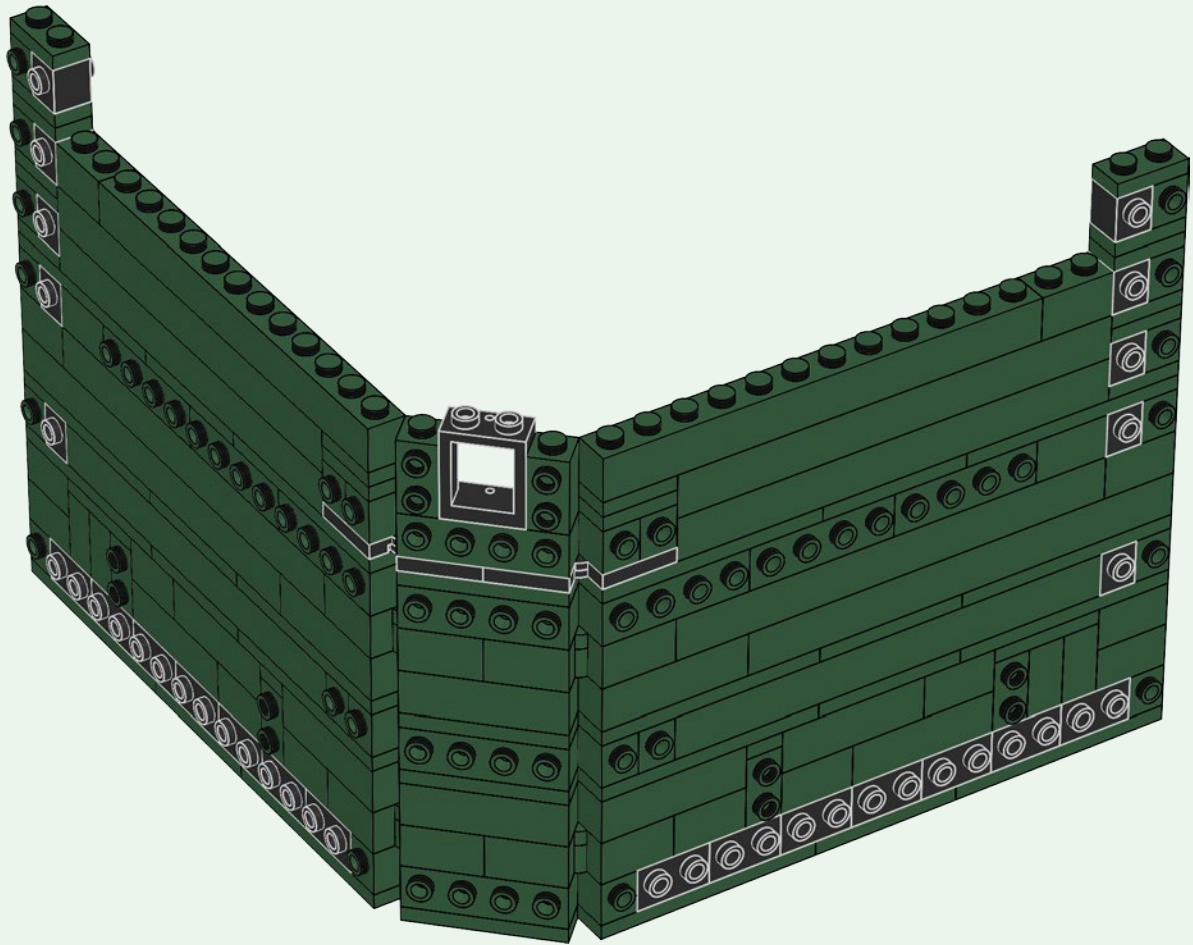

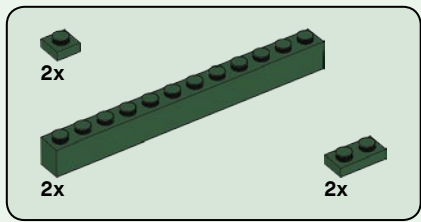

40

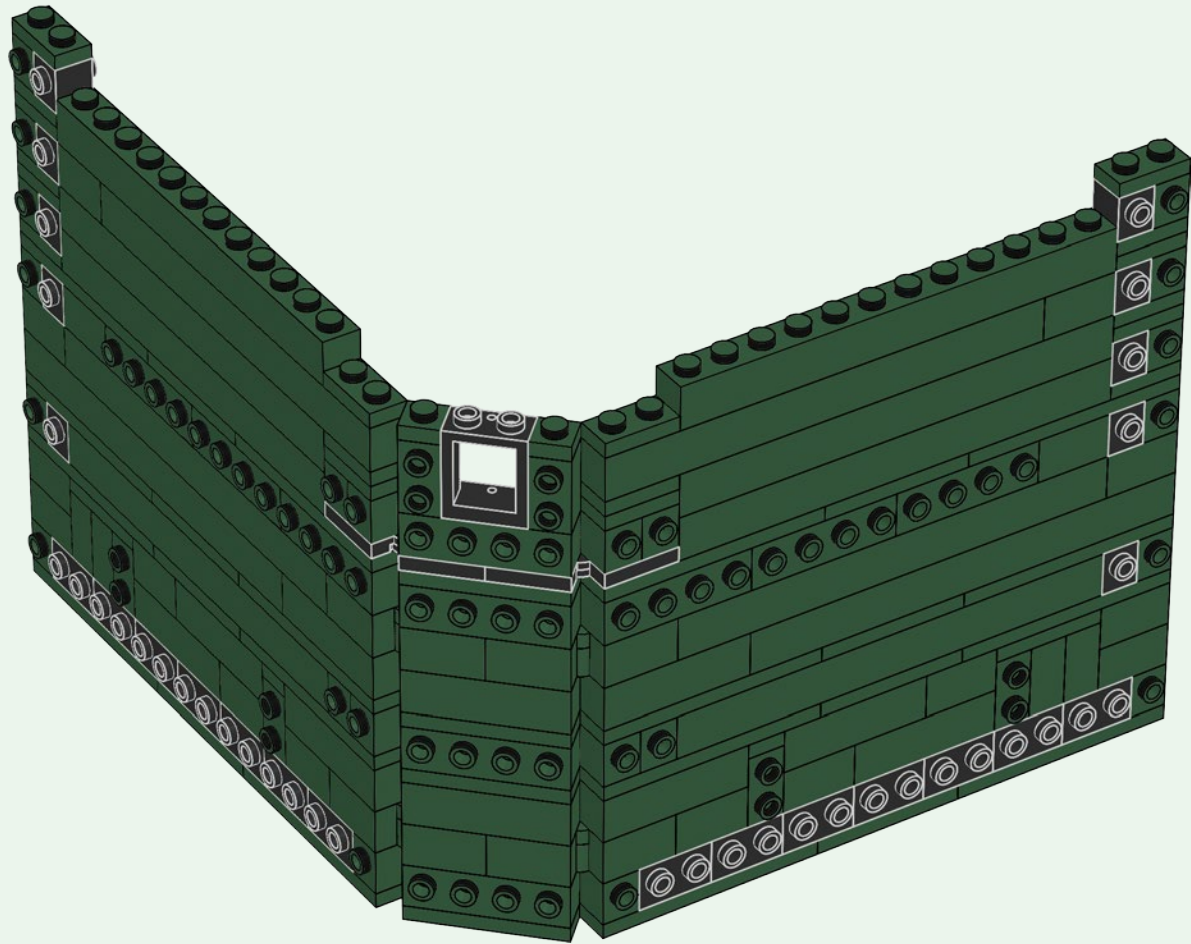



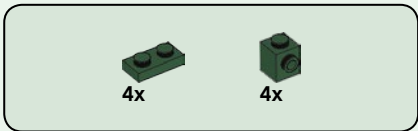

41

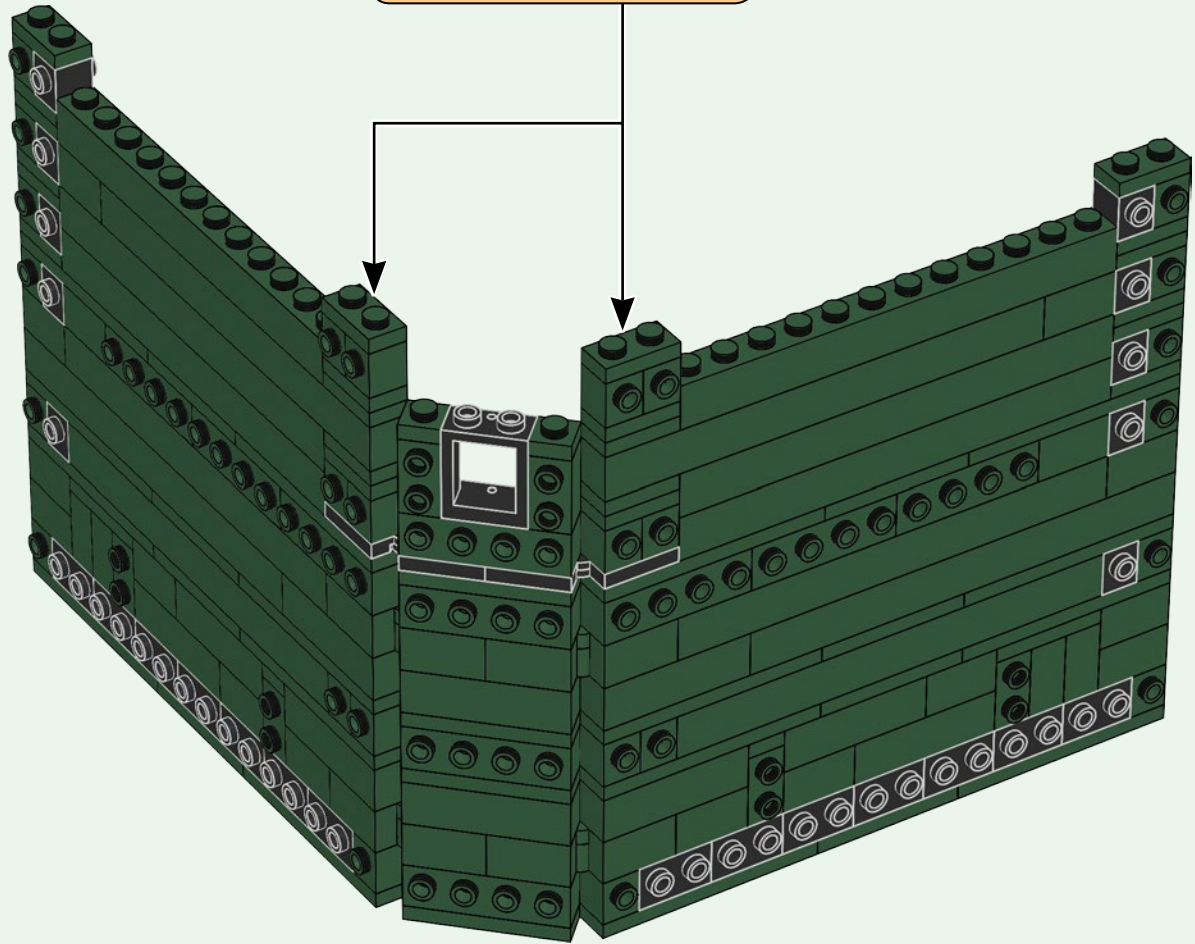
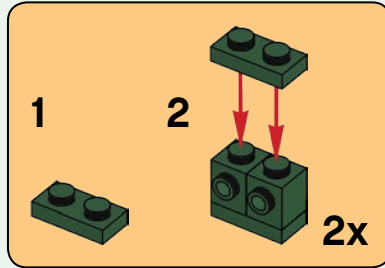

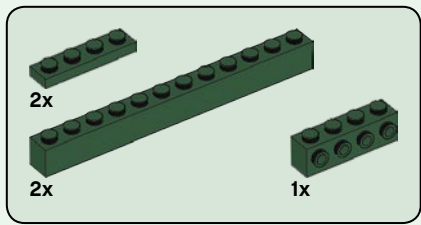

42

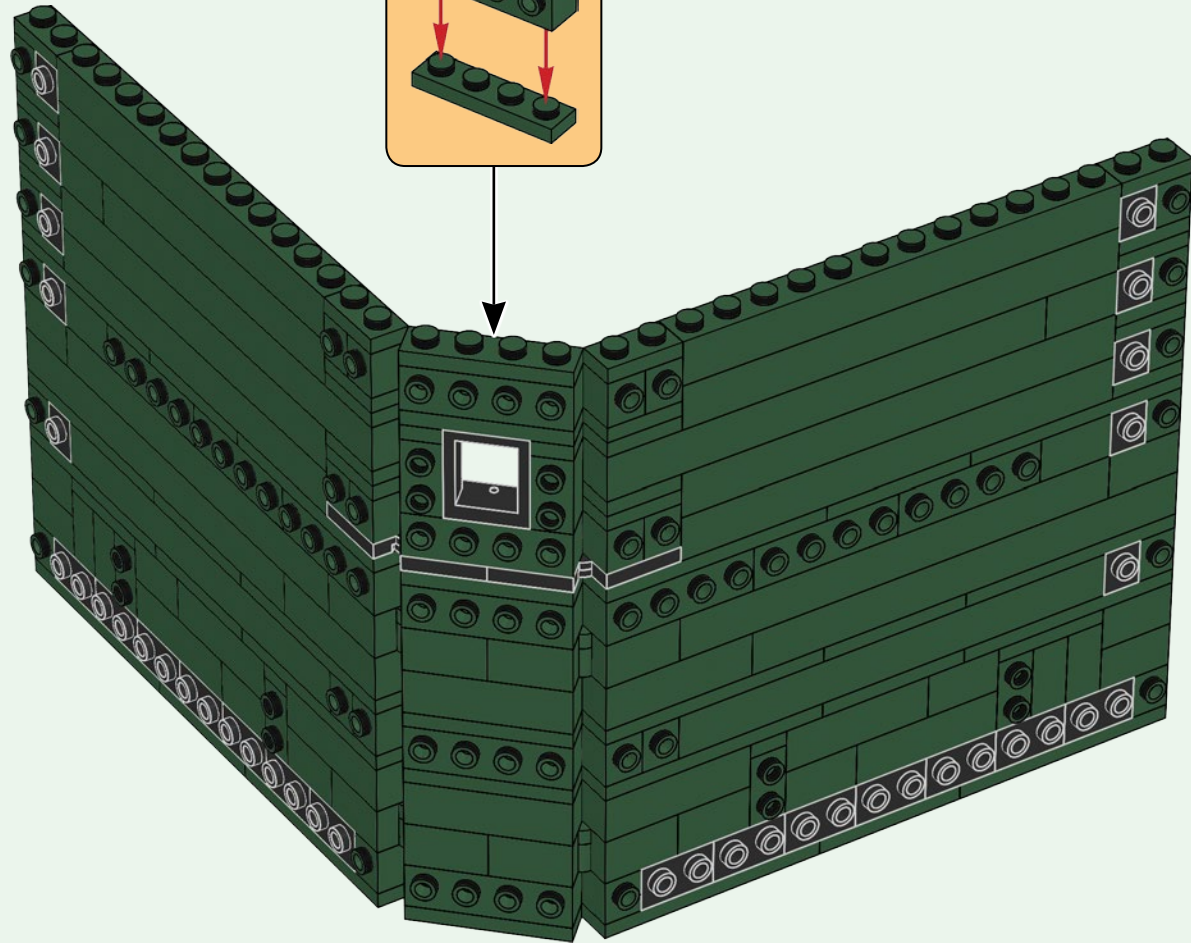
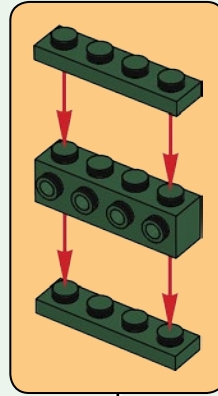

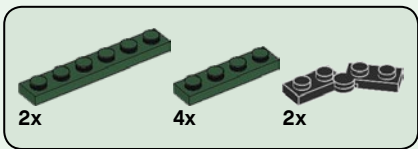

43

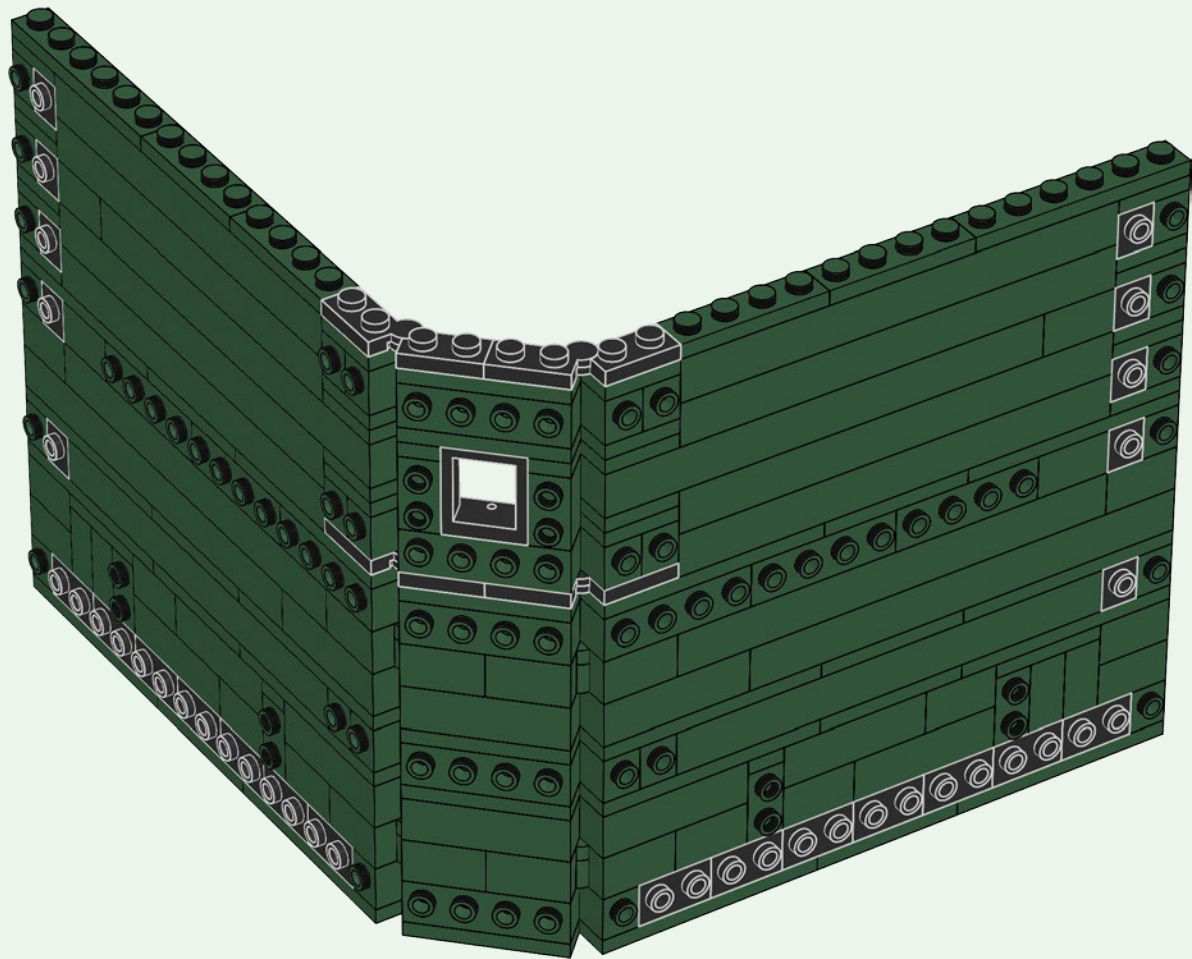

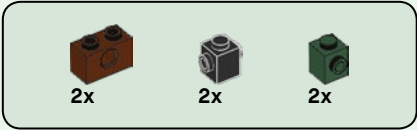

44

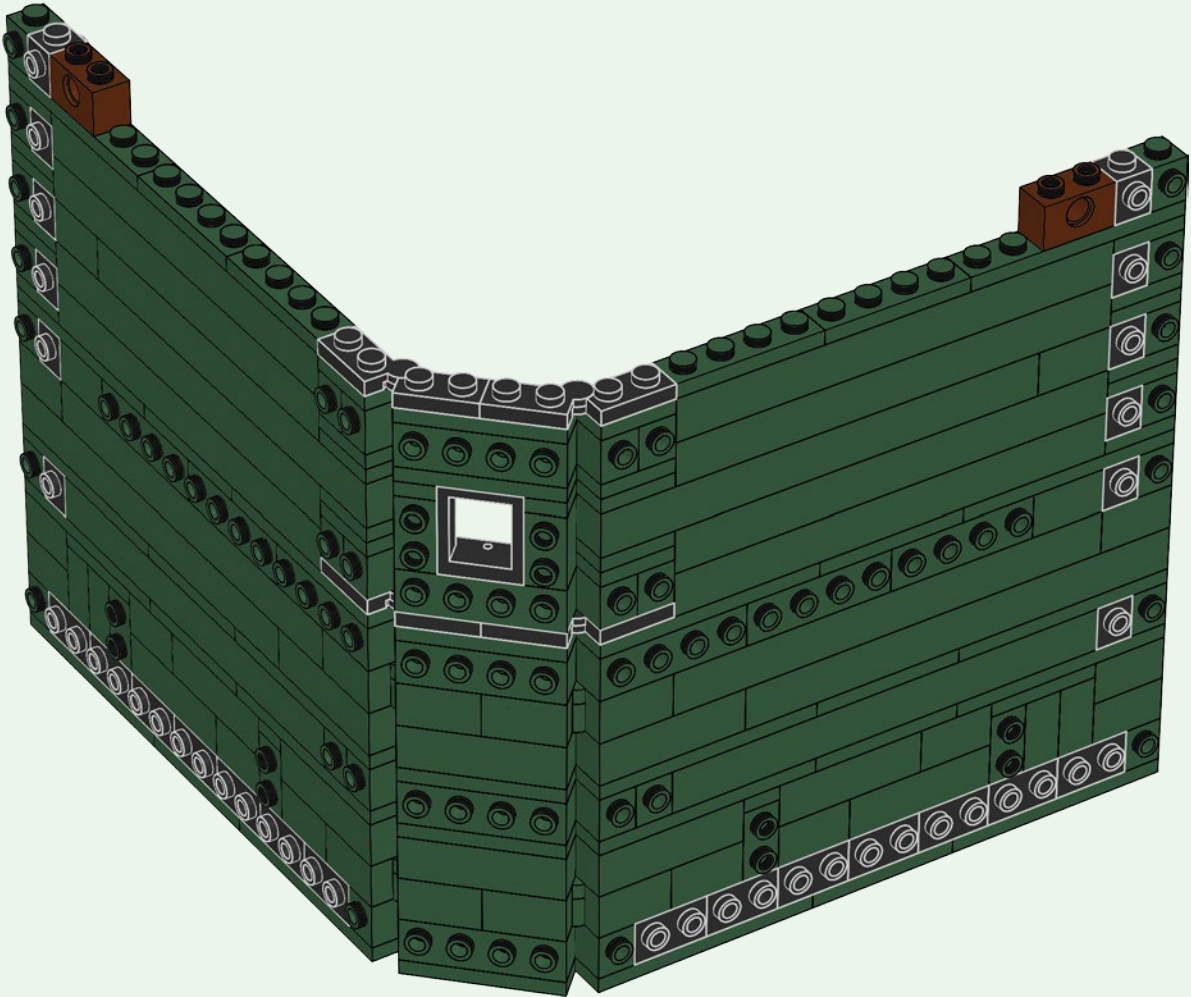



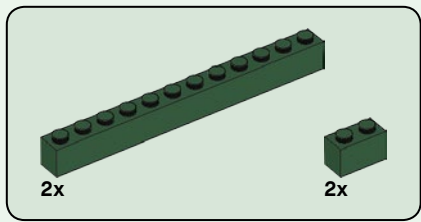

46

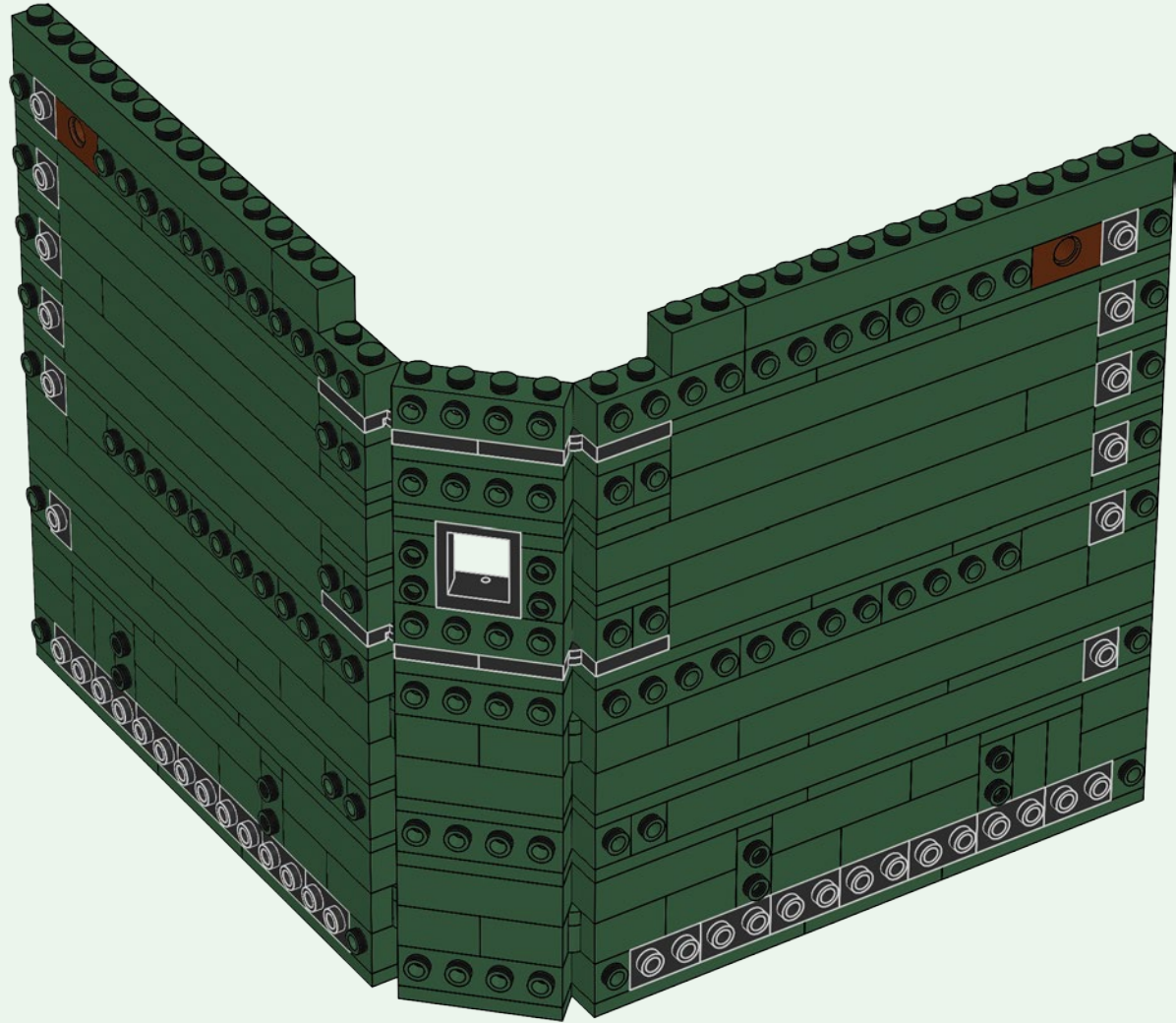

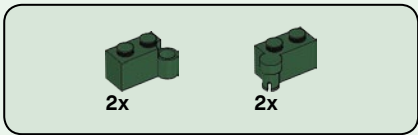

47

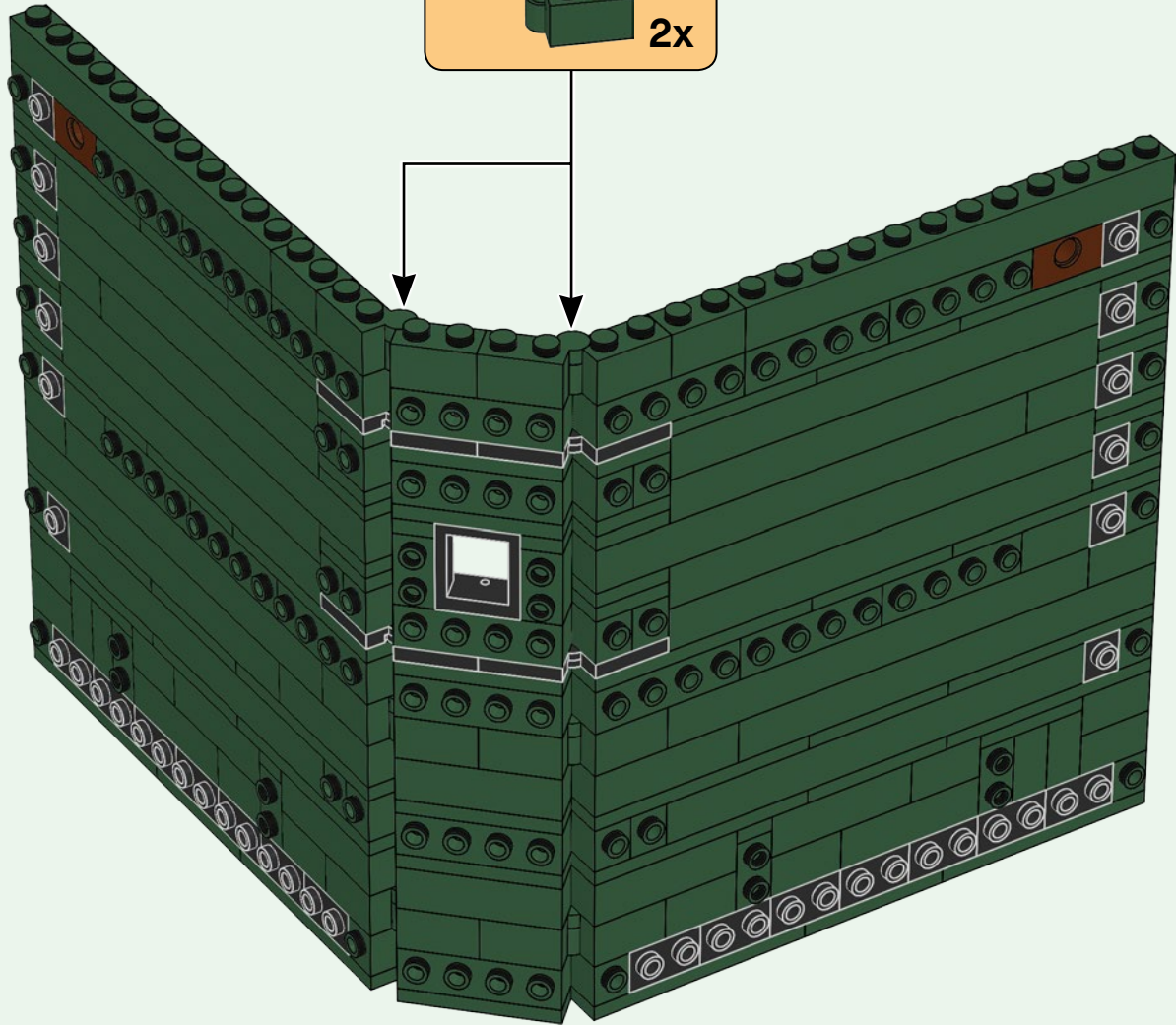
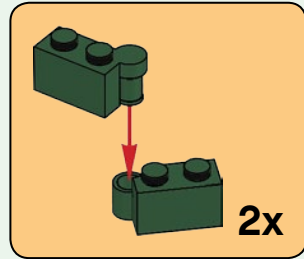

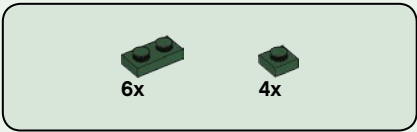

48

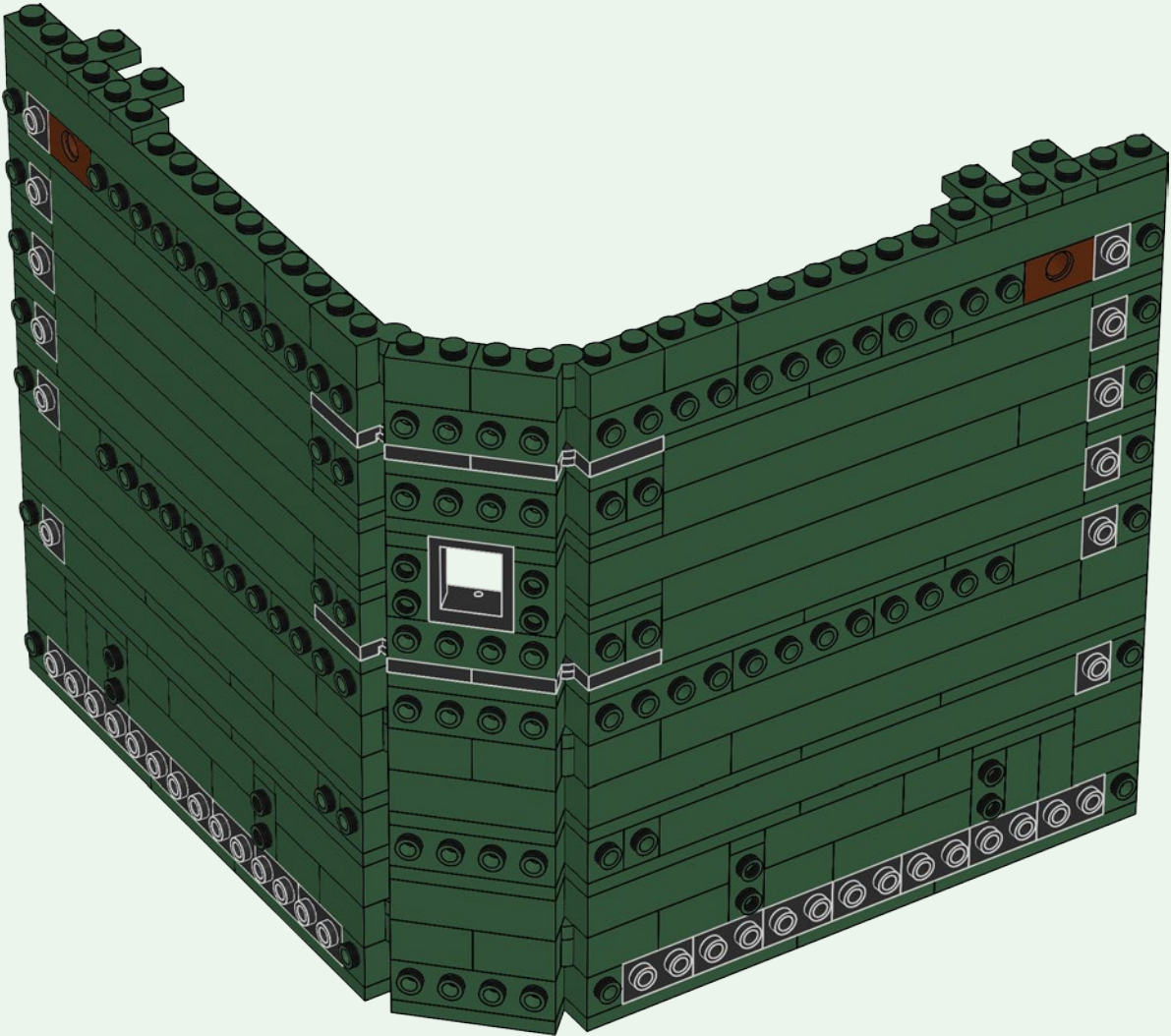



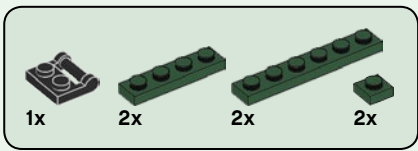

49

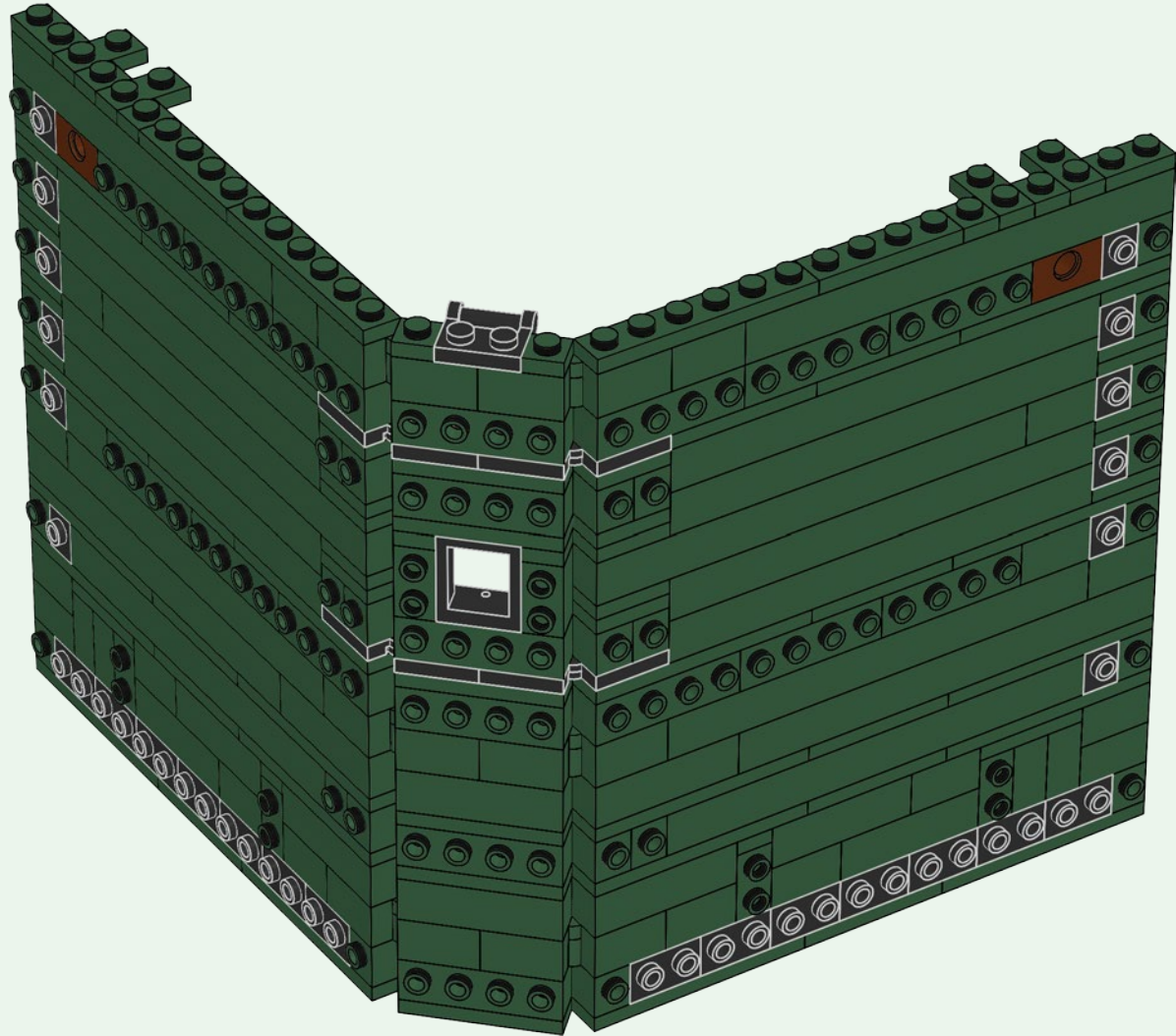

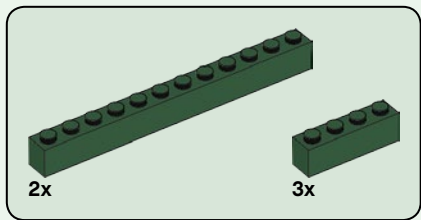

50

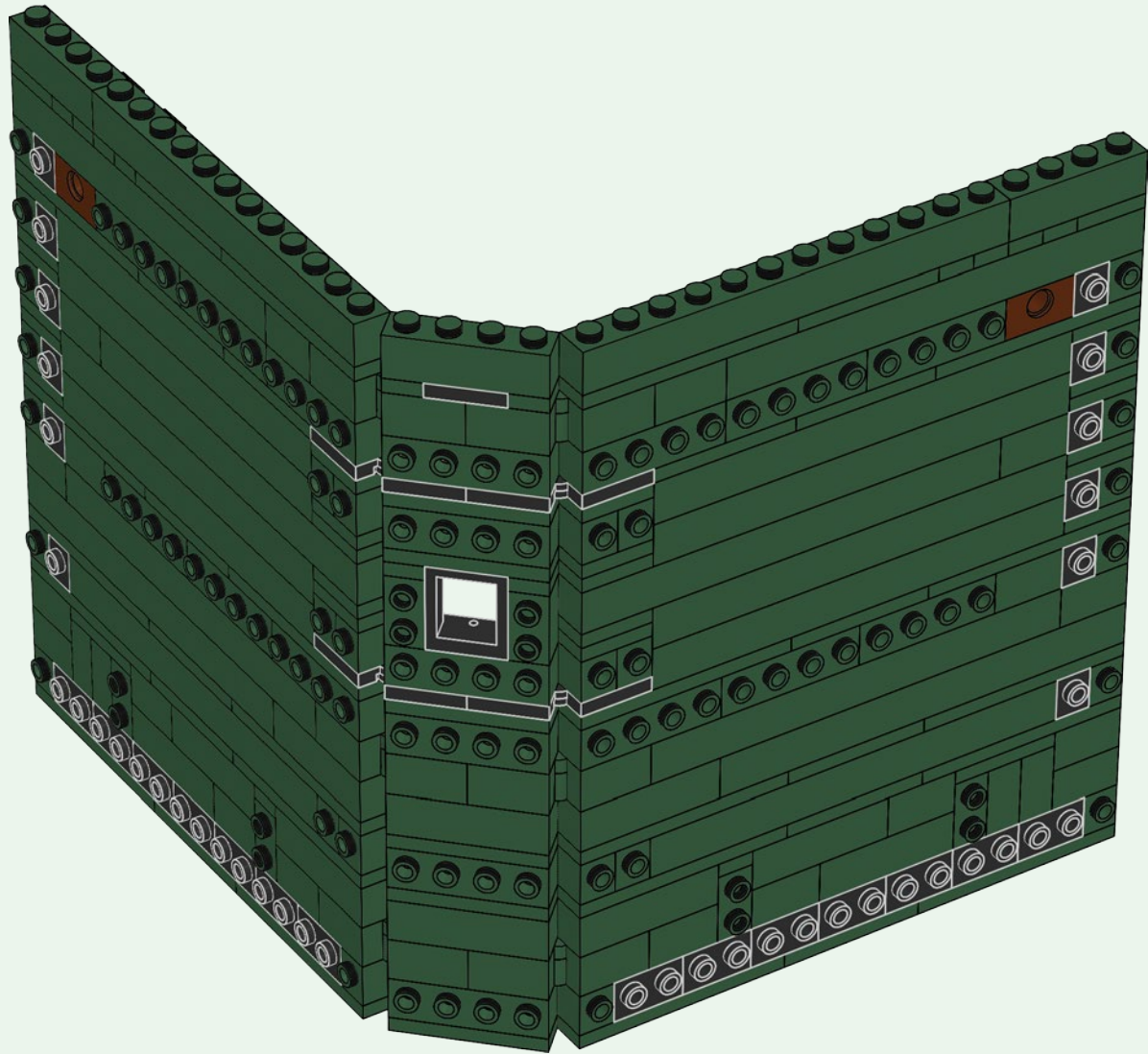



2x



2x

51

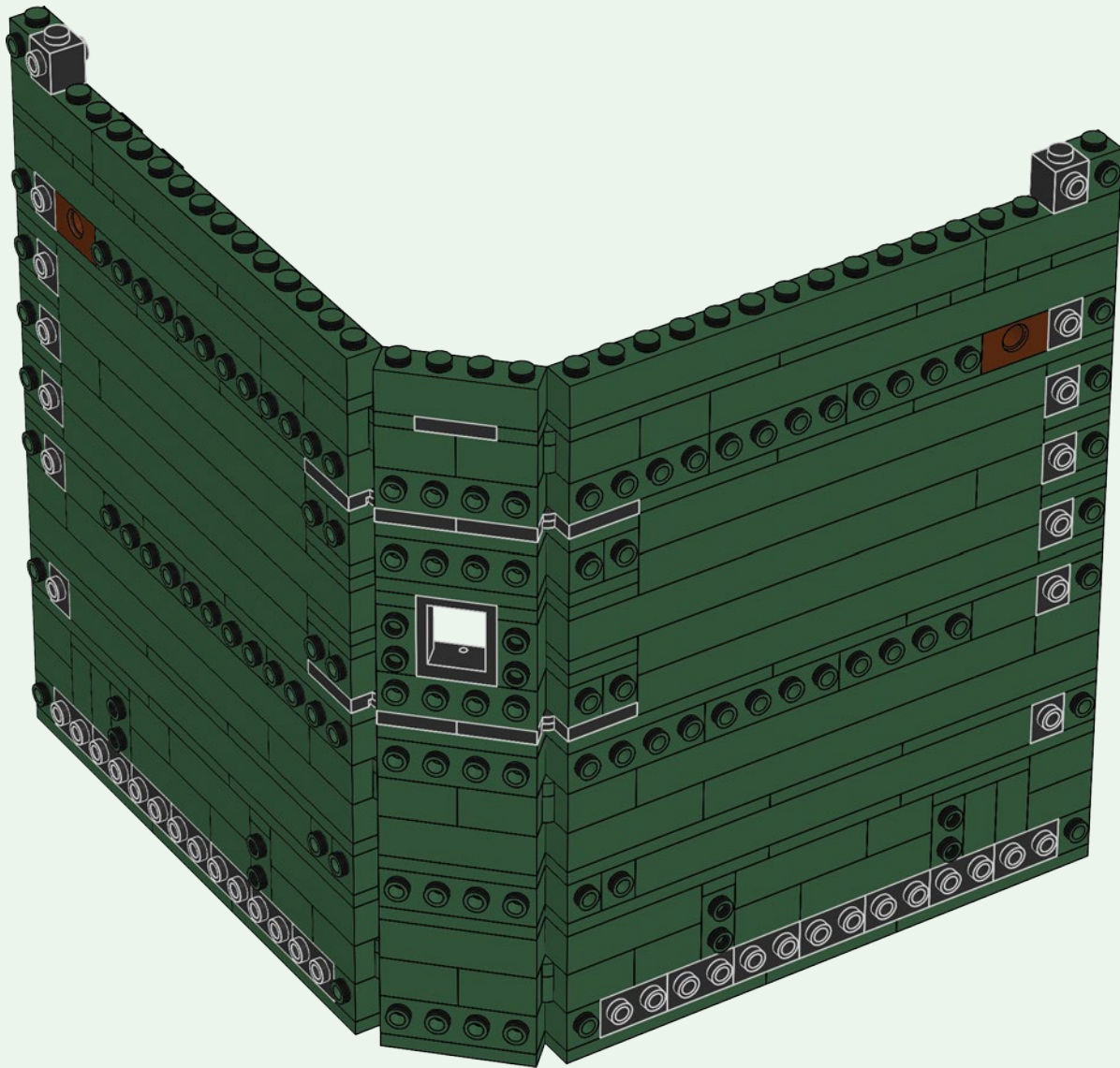

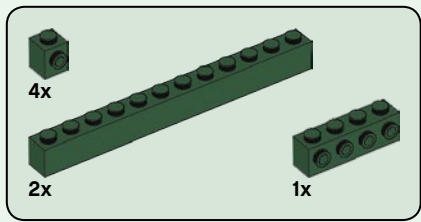

52

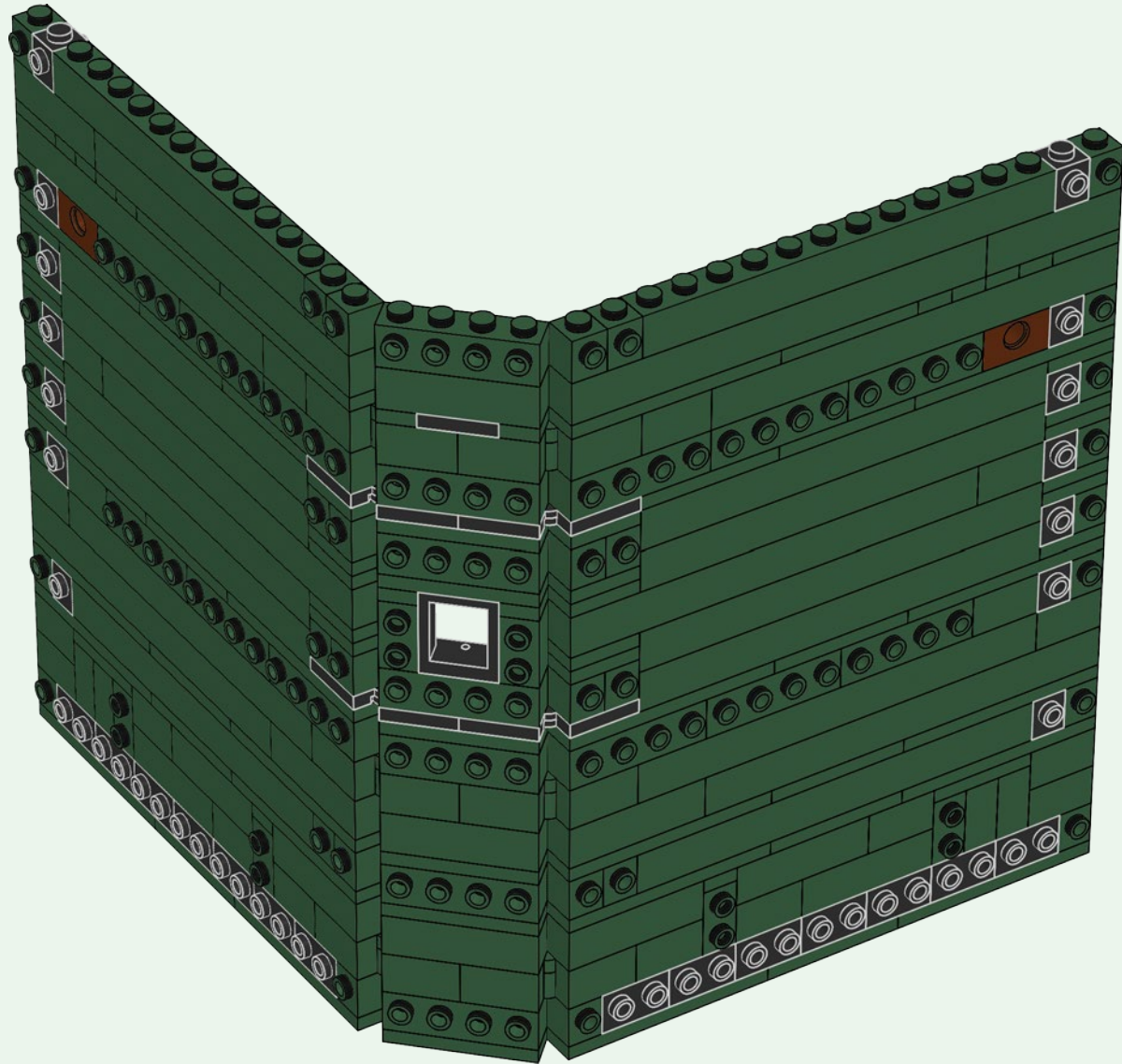

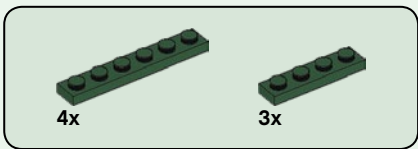

53

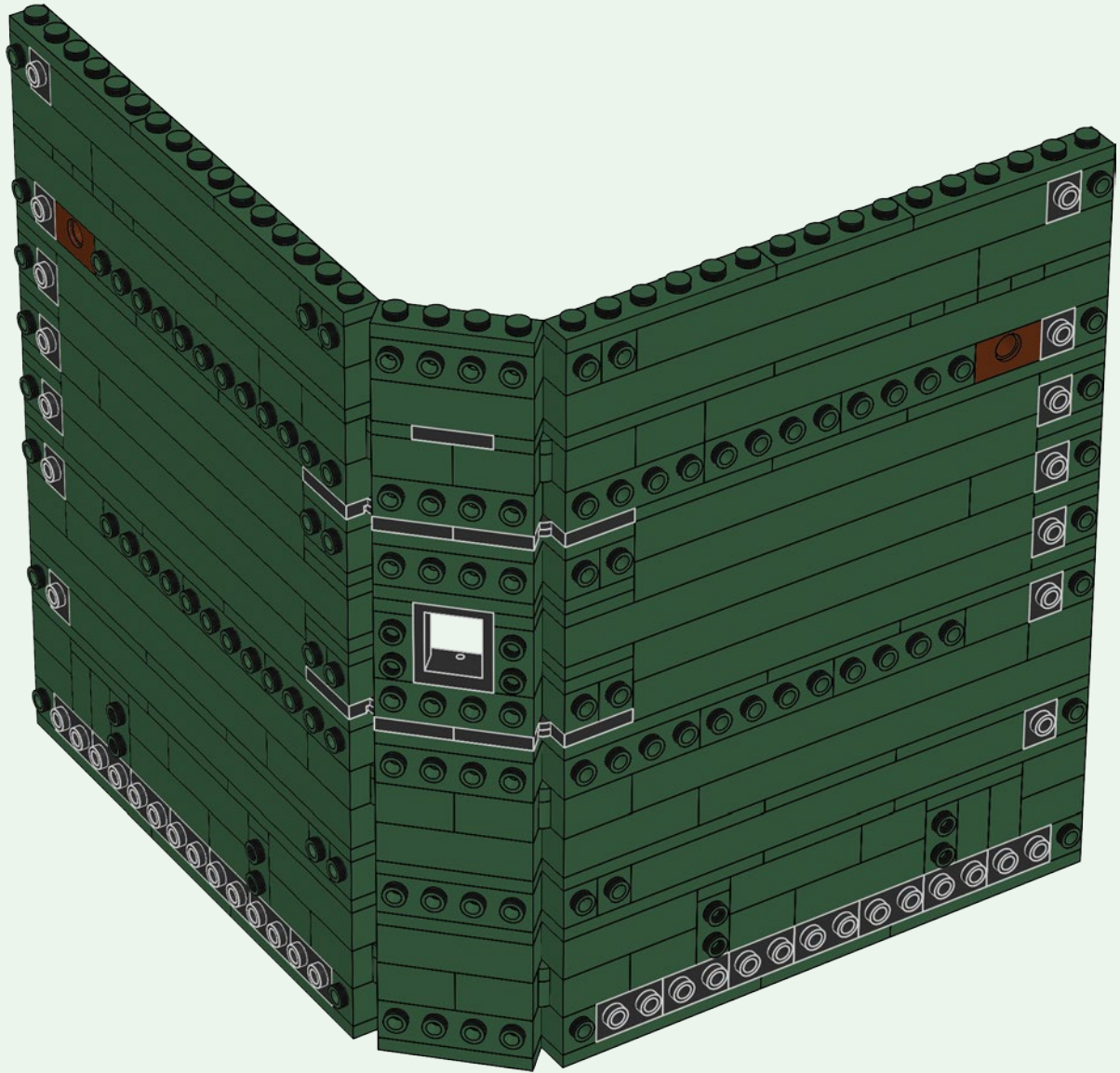

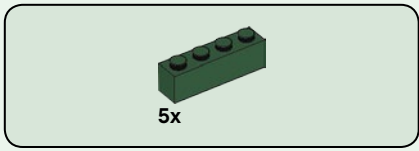

54

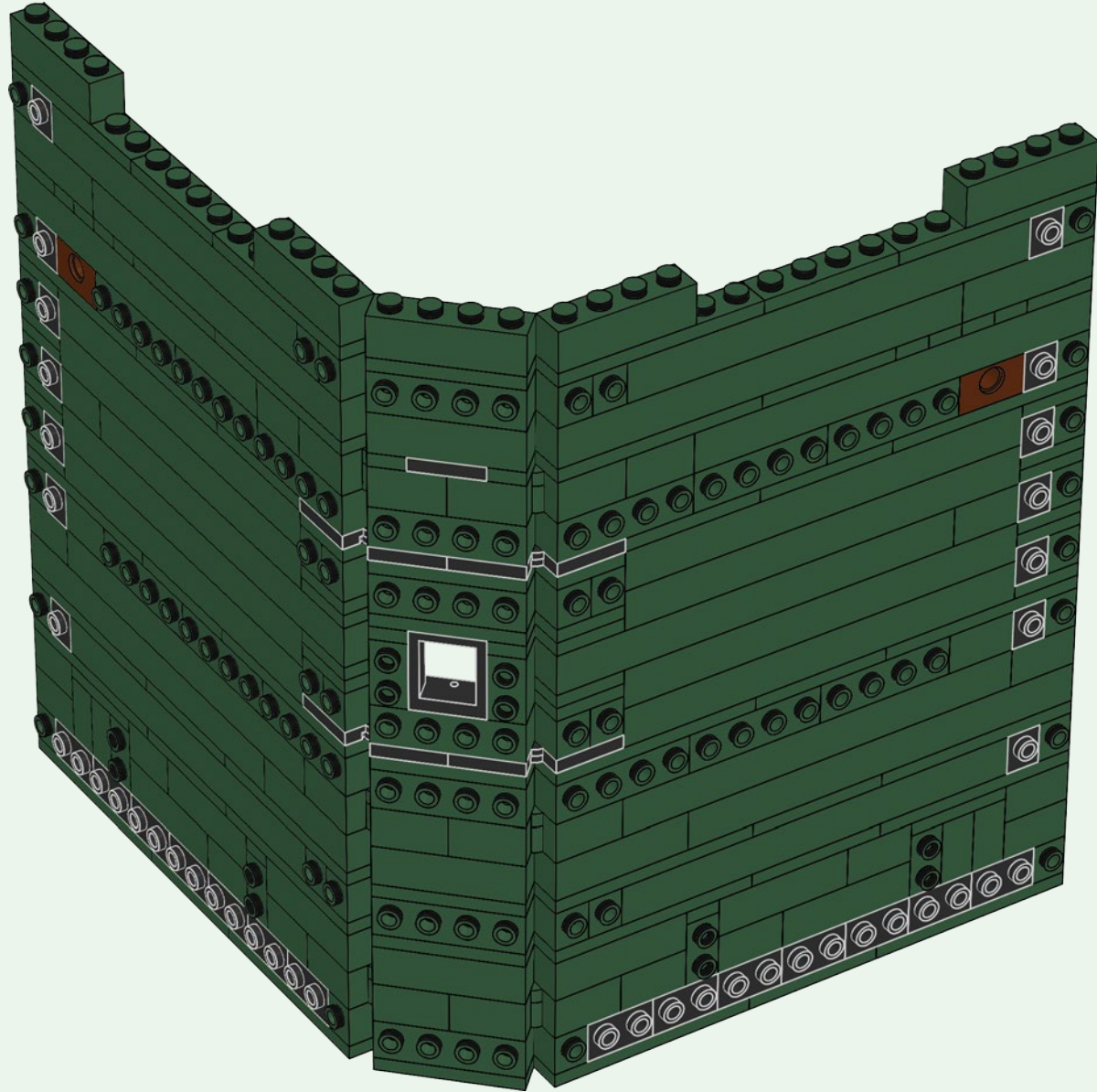

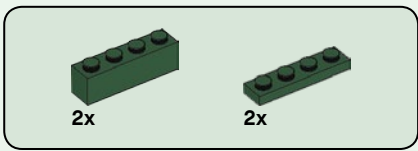

55

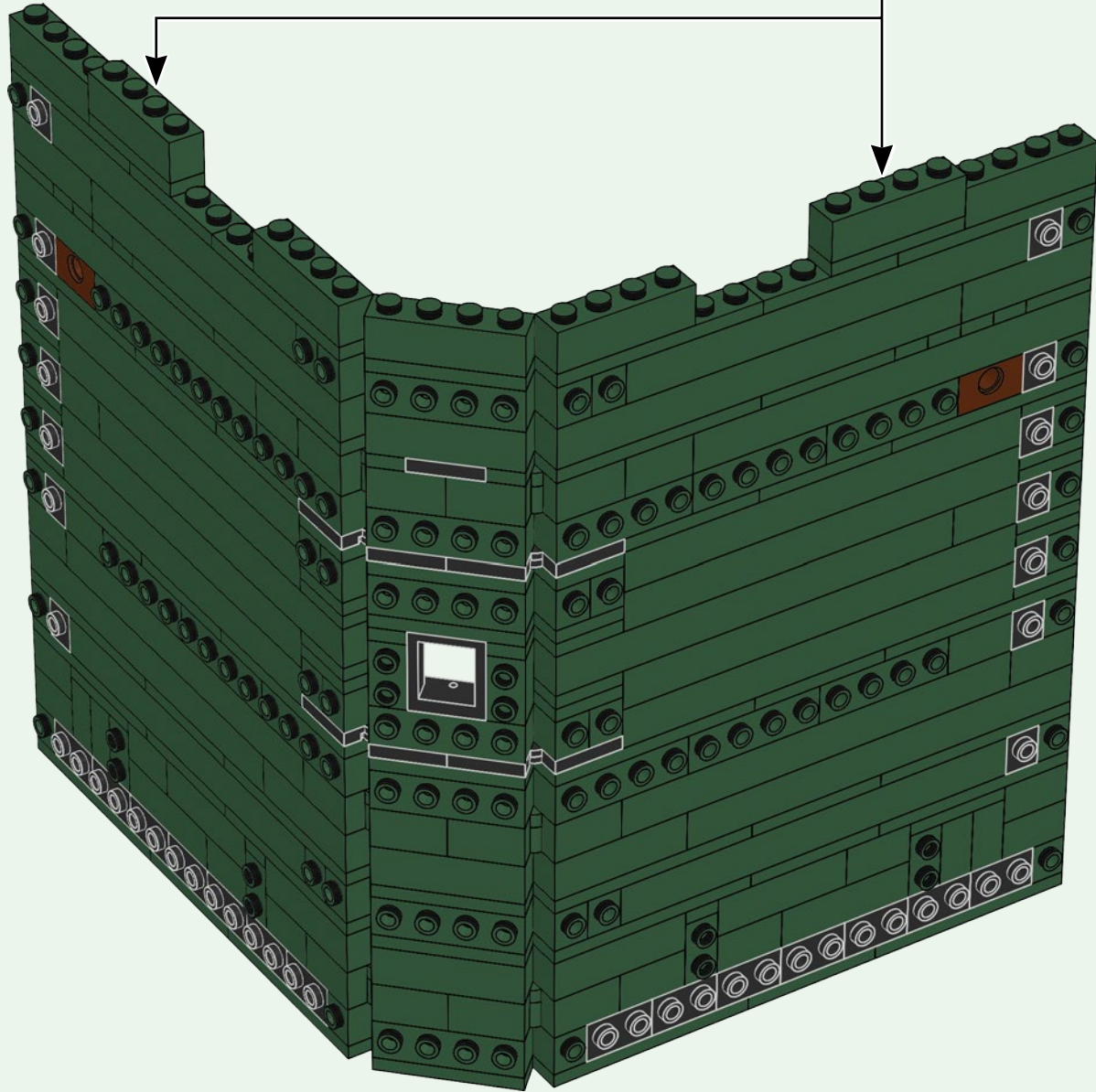
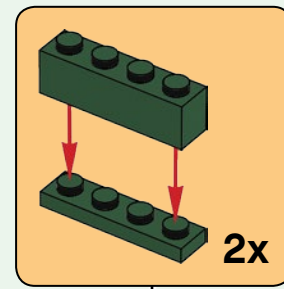

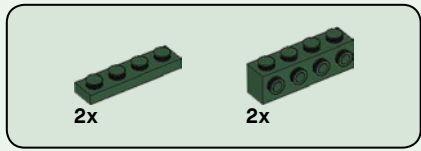

56

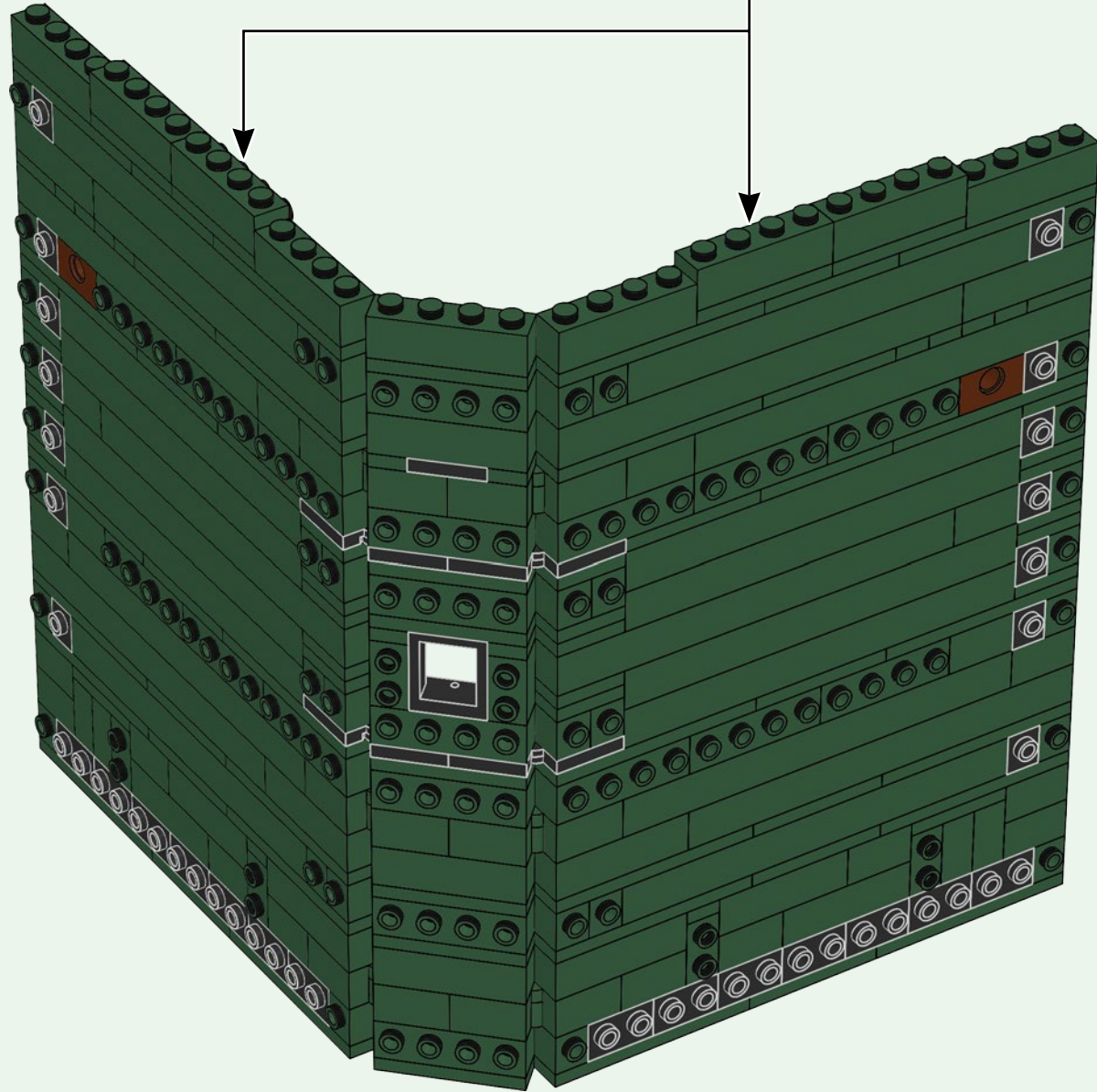
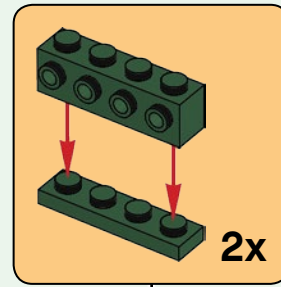



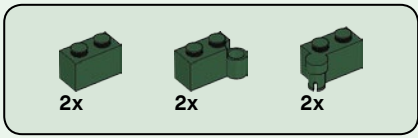

57

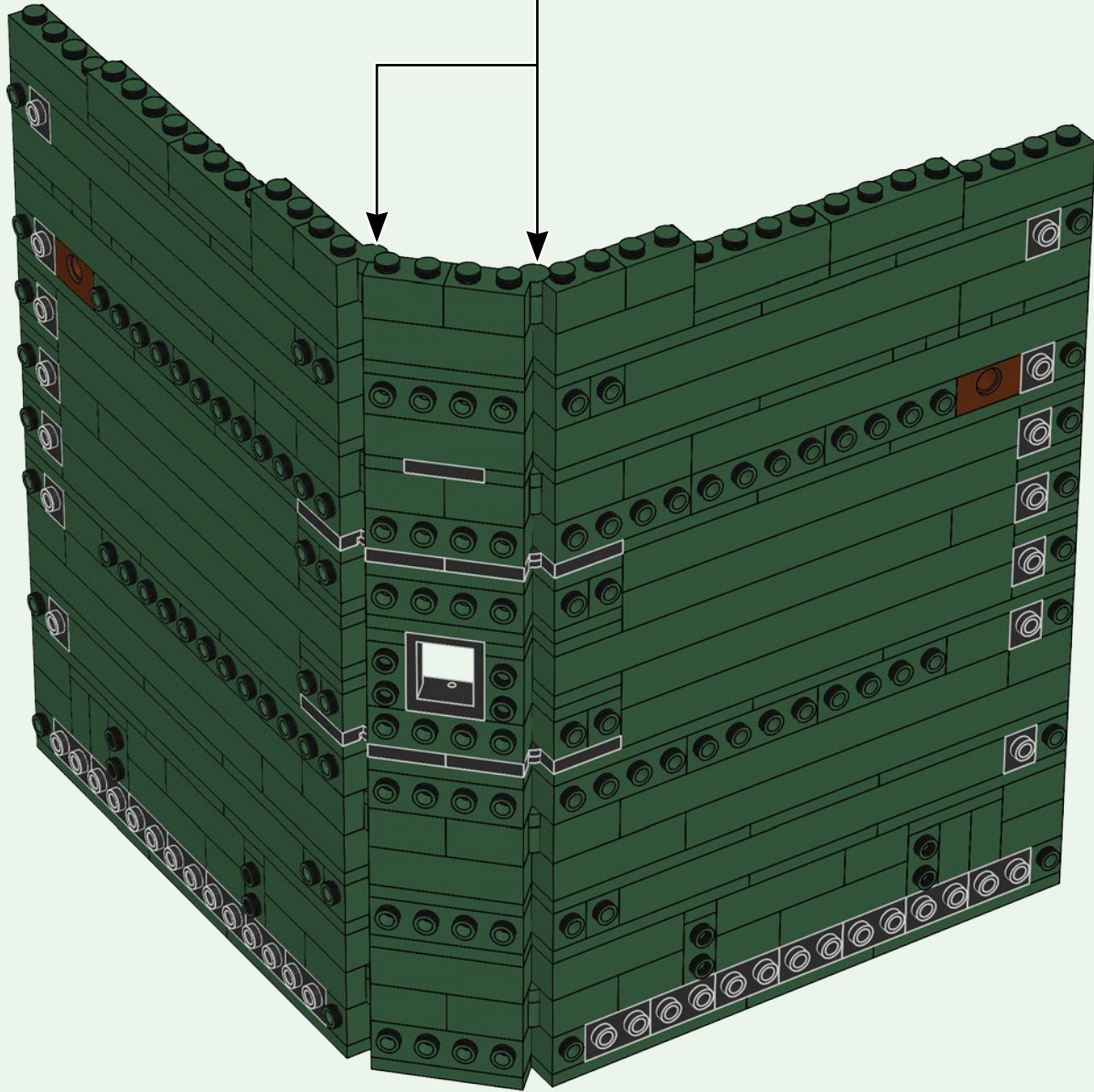
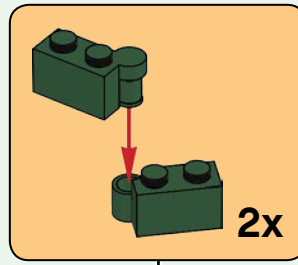

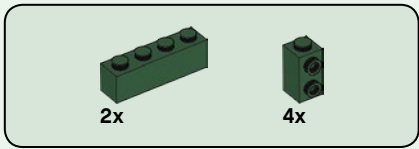

58

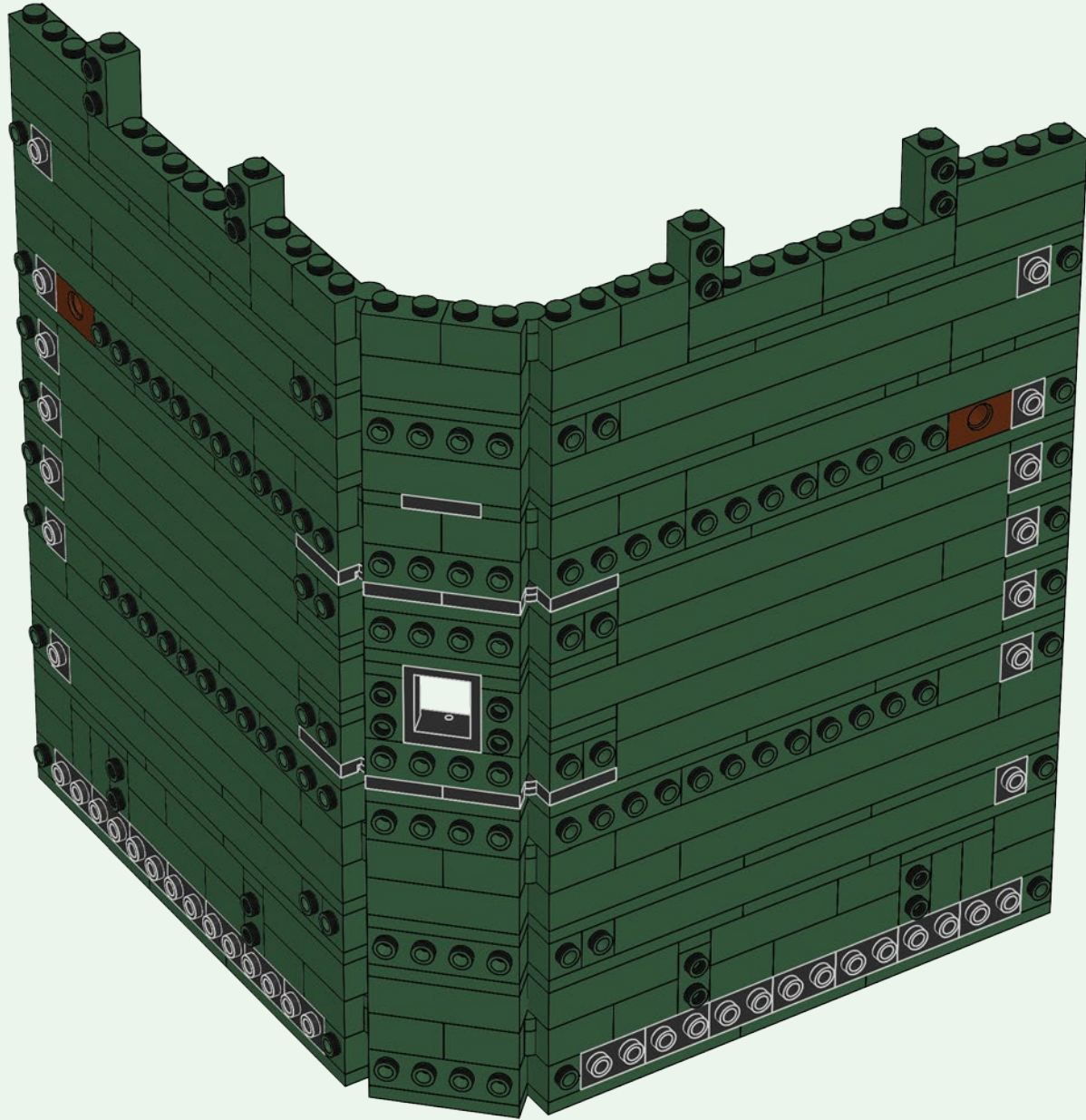

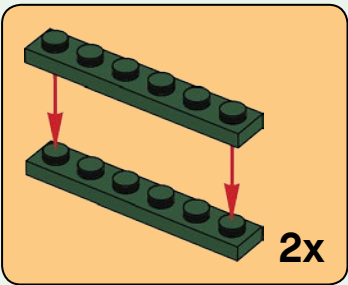
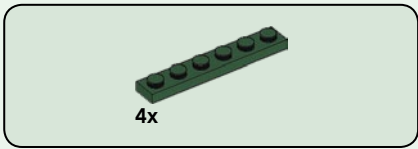

59

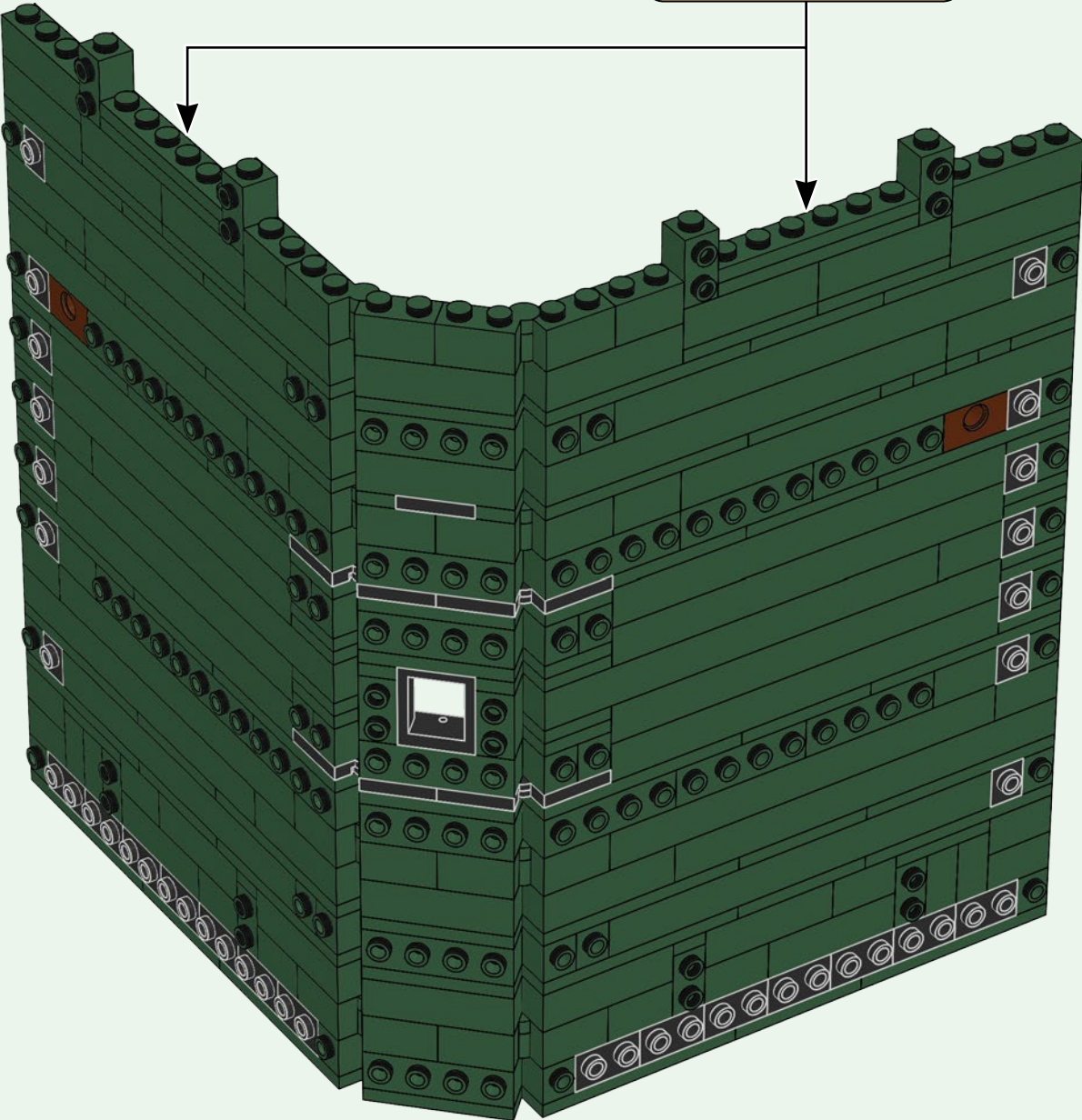



4x



4x

60

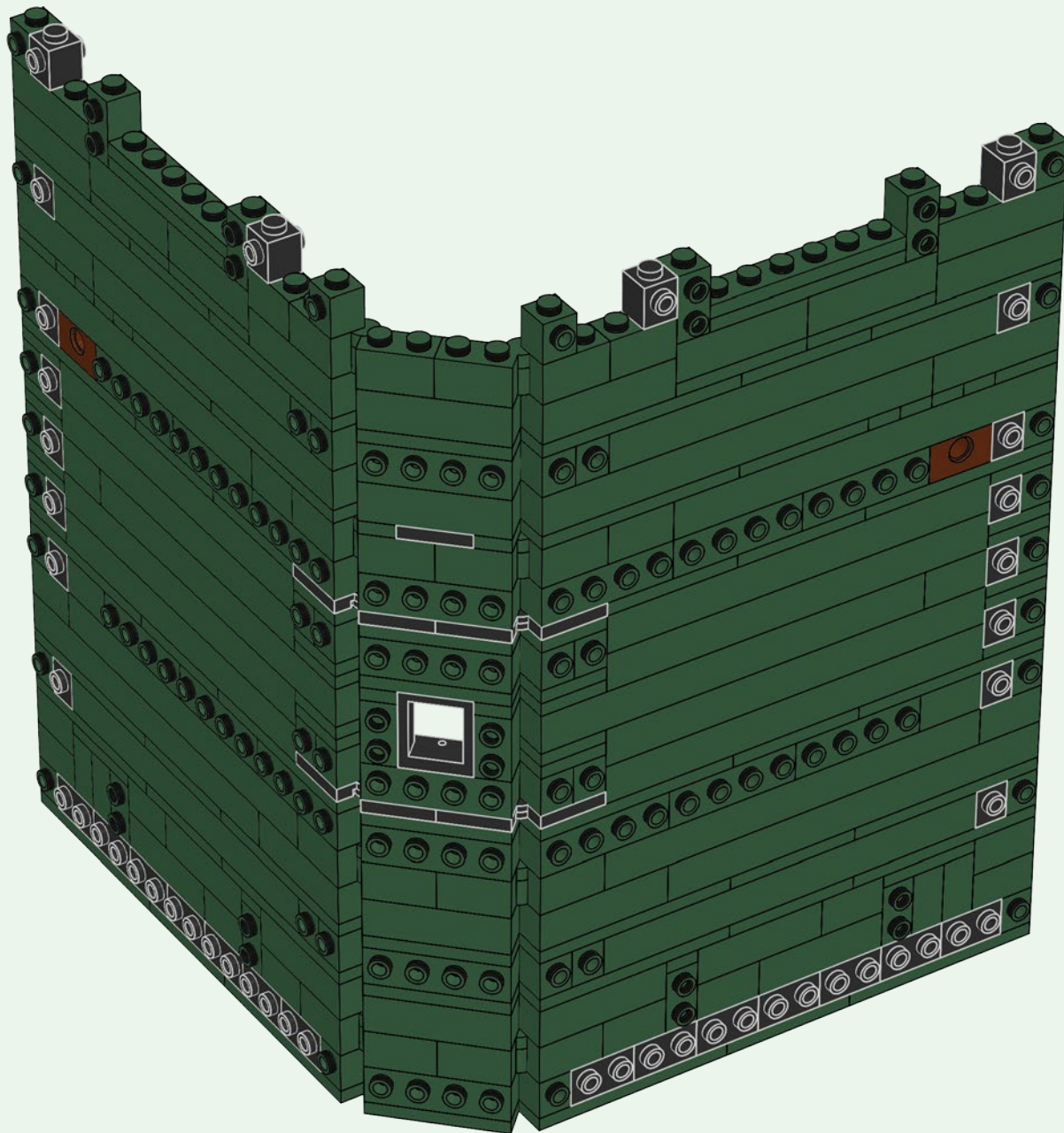

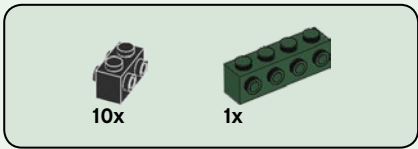

61

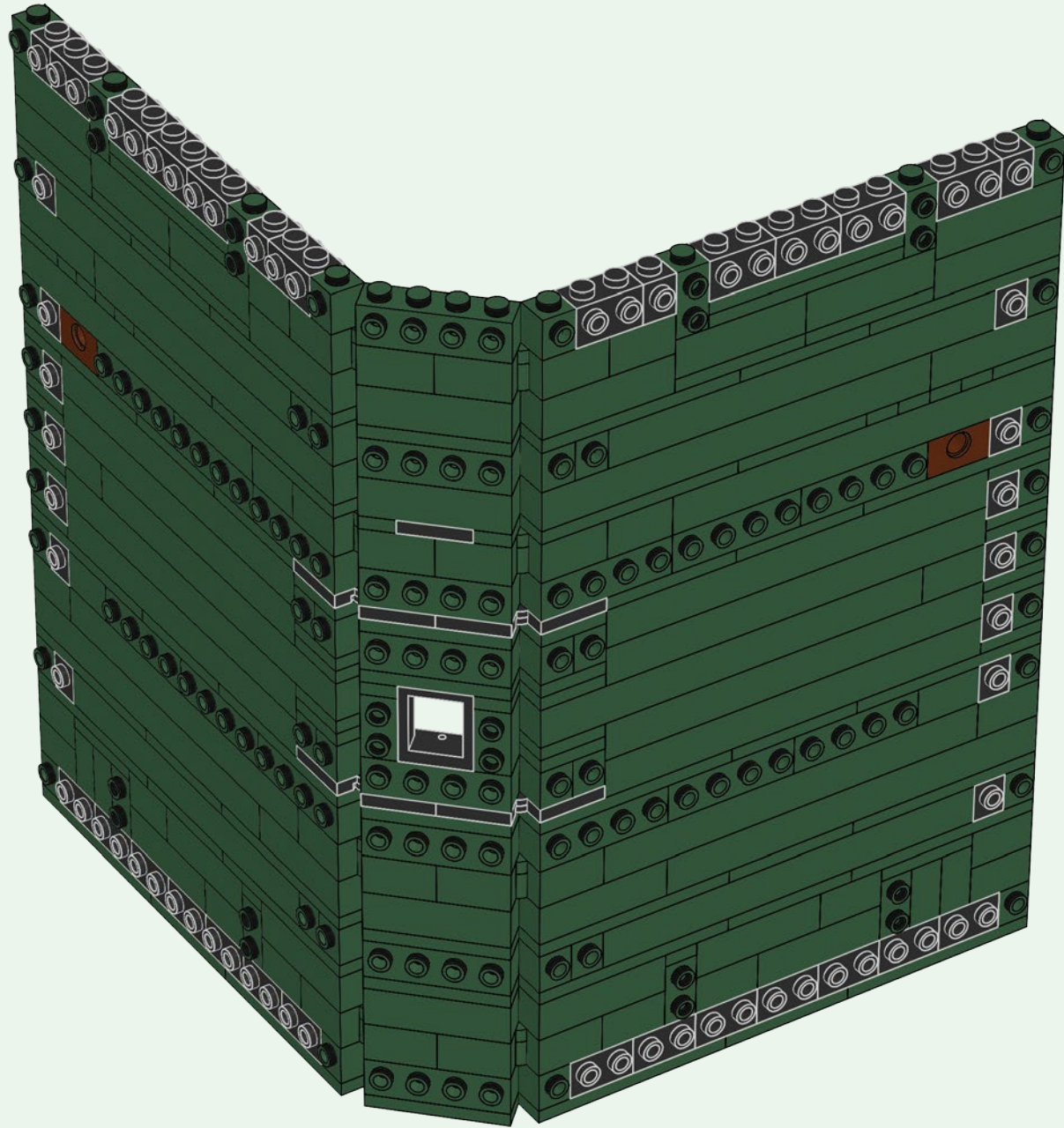



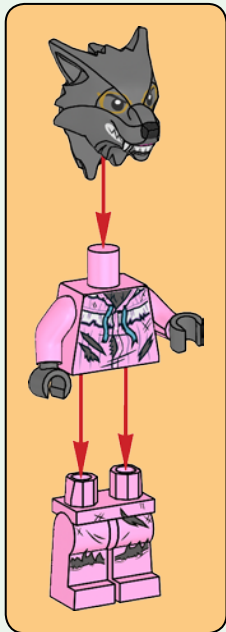
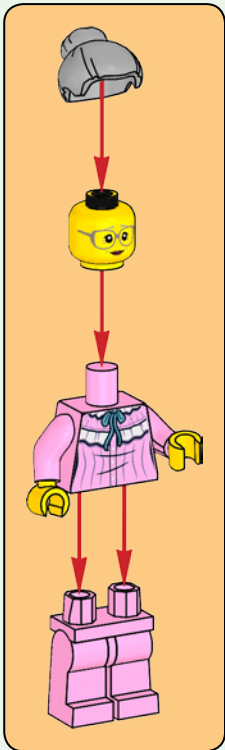
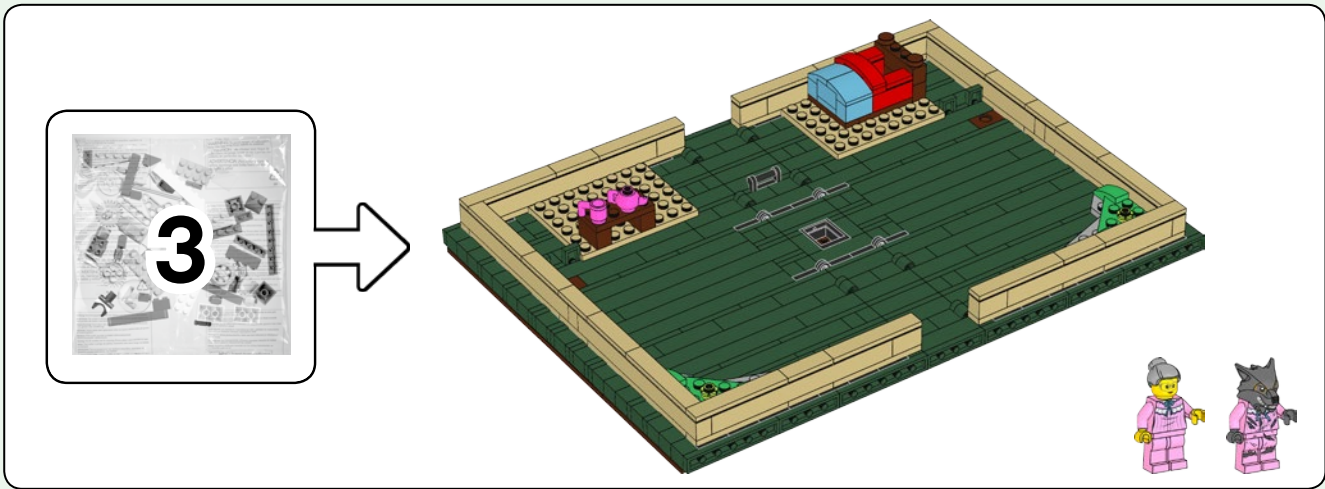

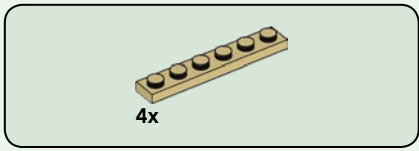

63

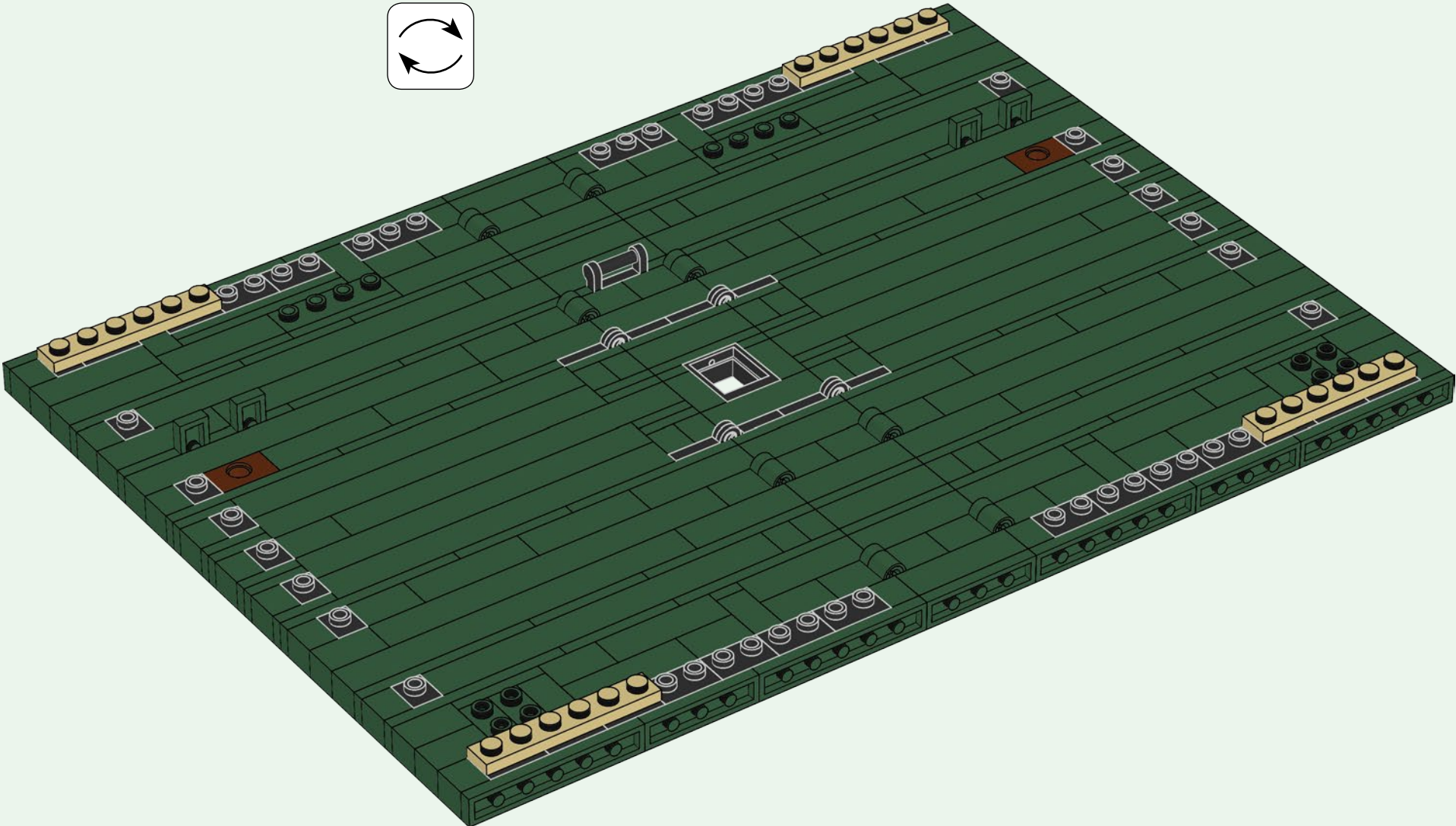
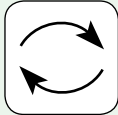



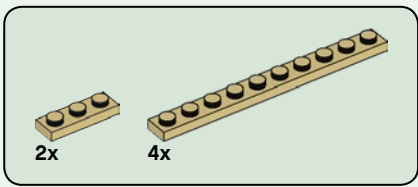

64

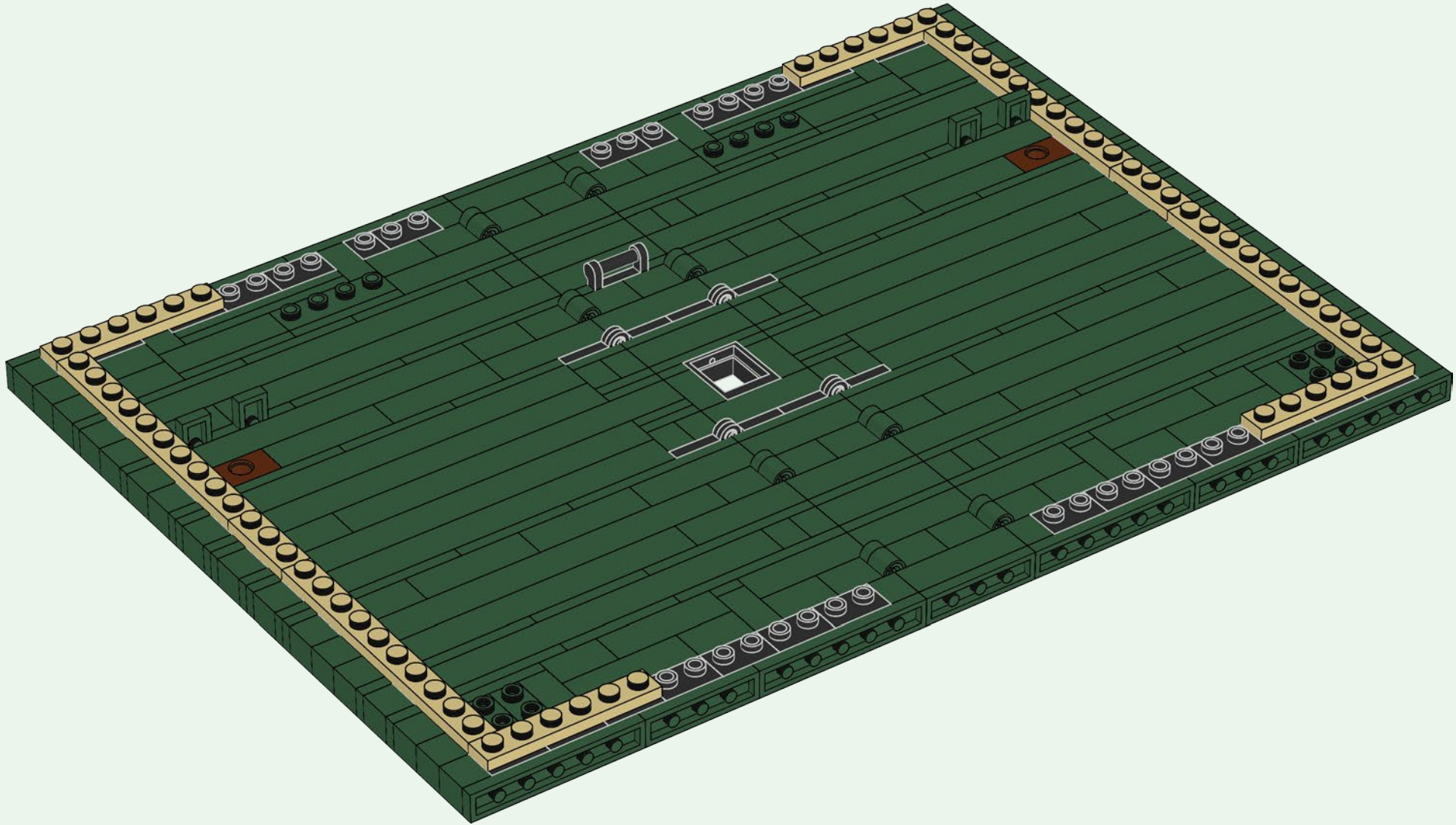

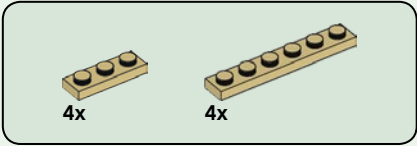

65

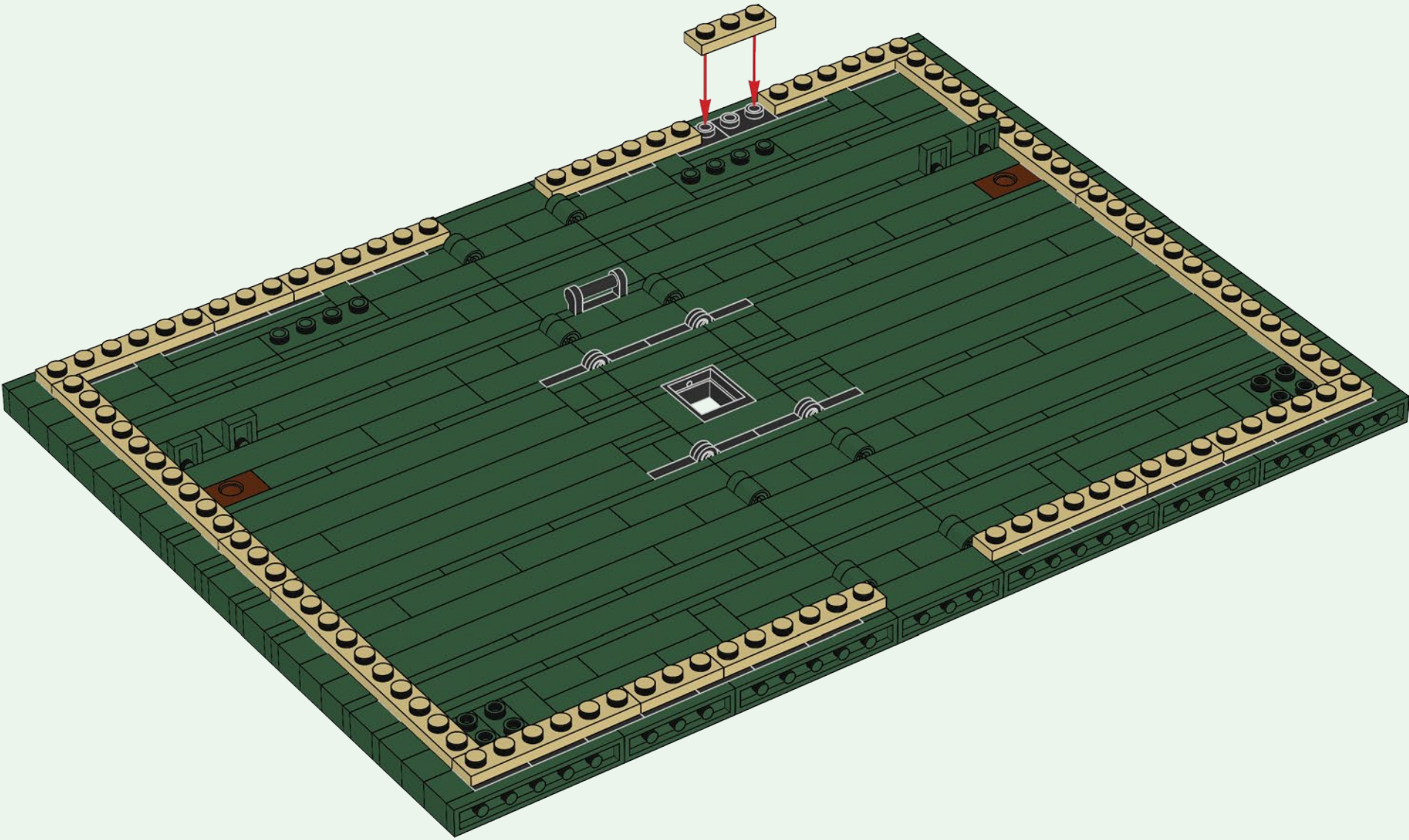

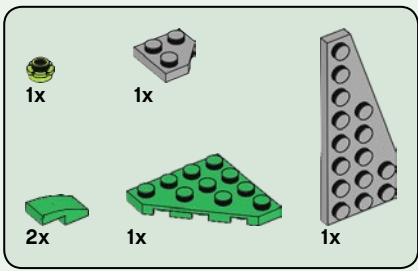

66

1

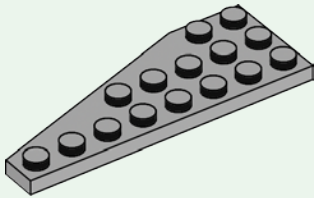

2

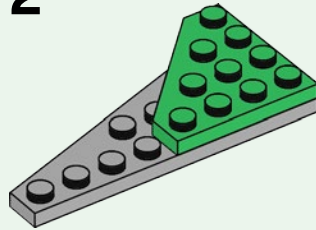

3

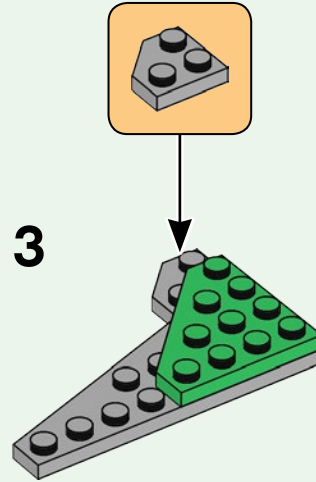

4

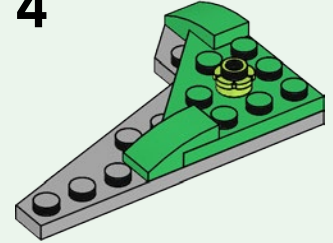

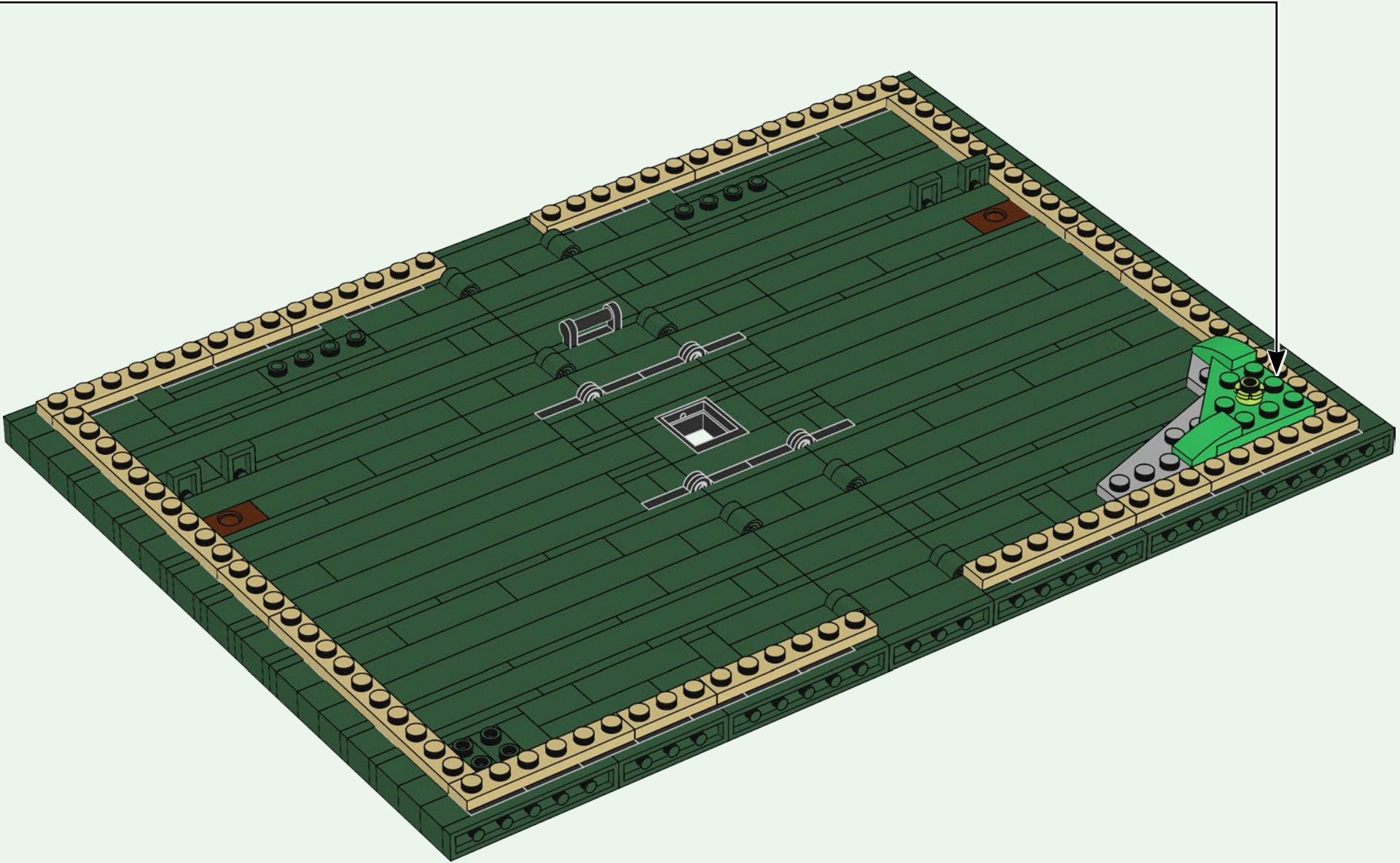

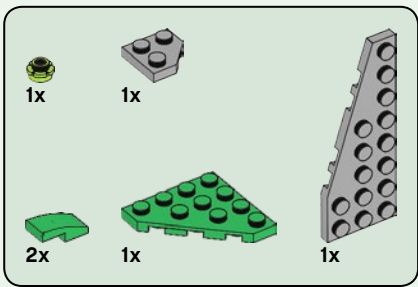

67

1

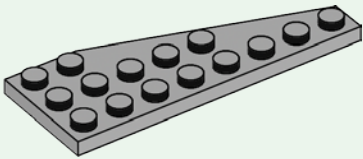

2

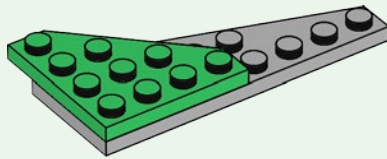

3

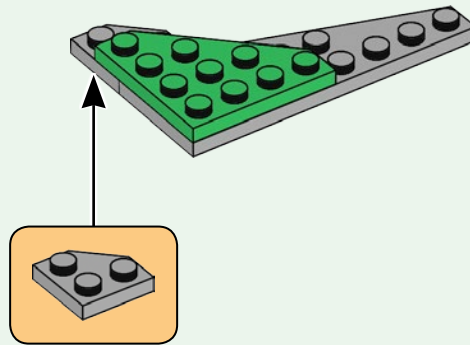

4

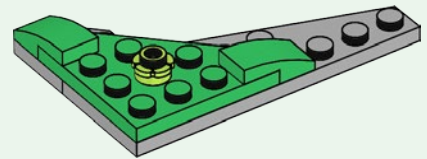

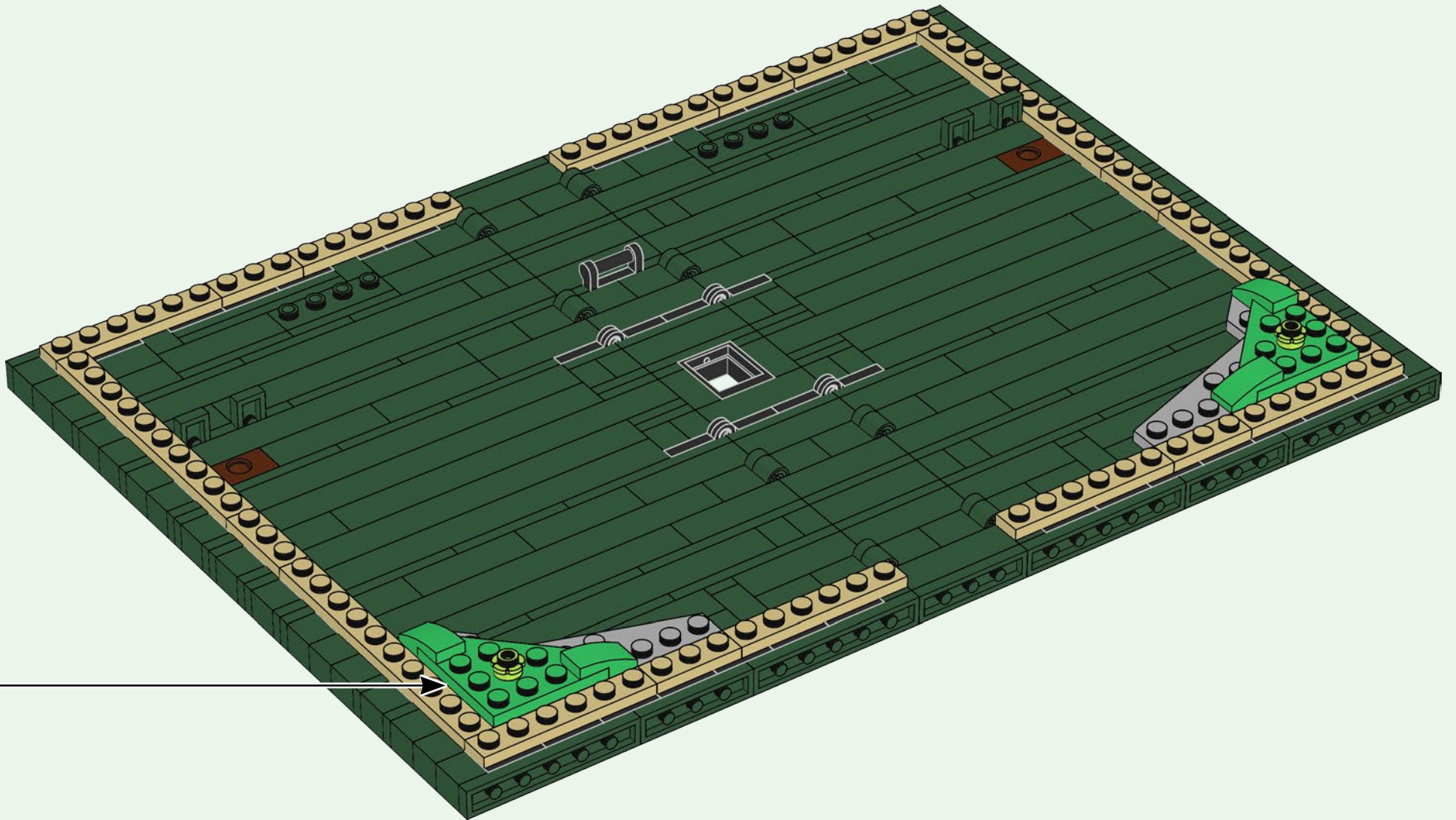

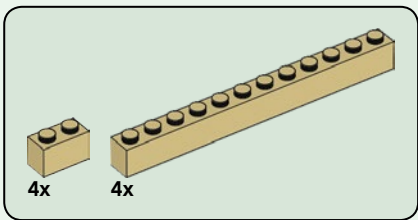

68

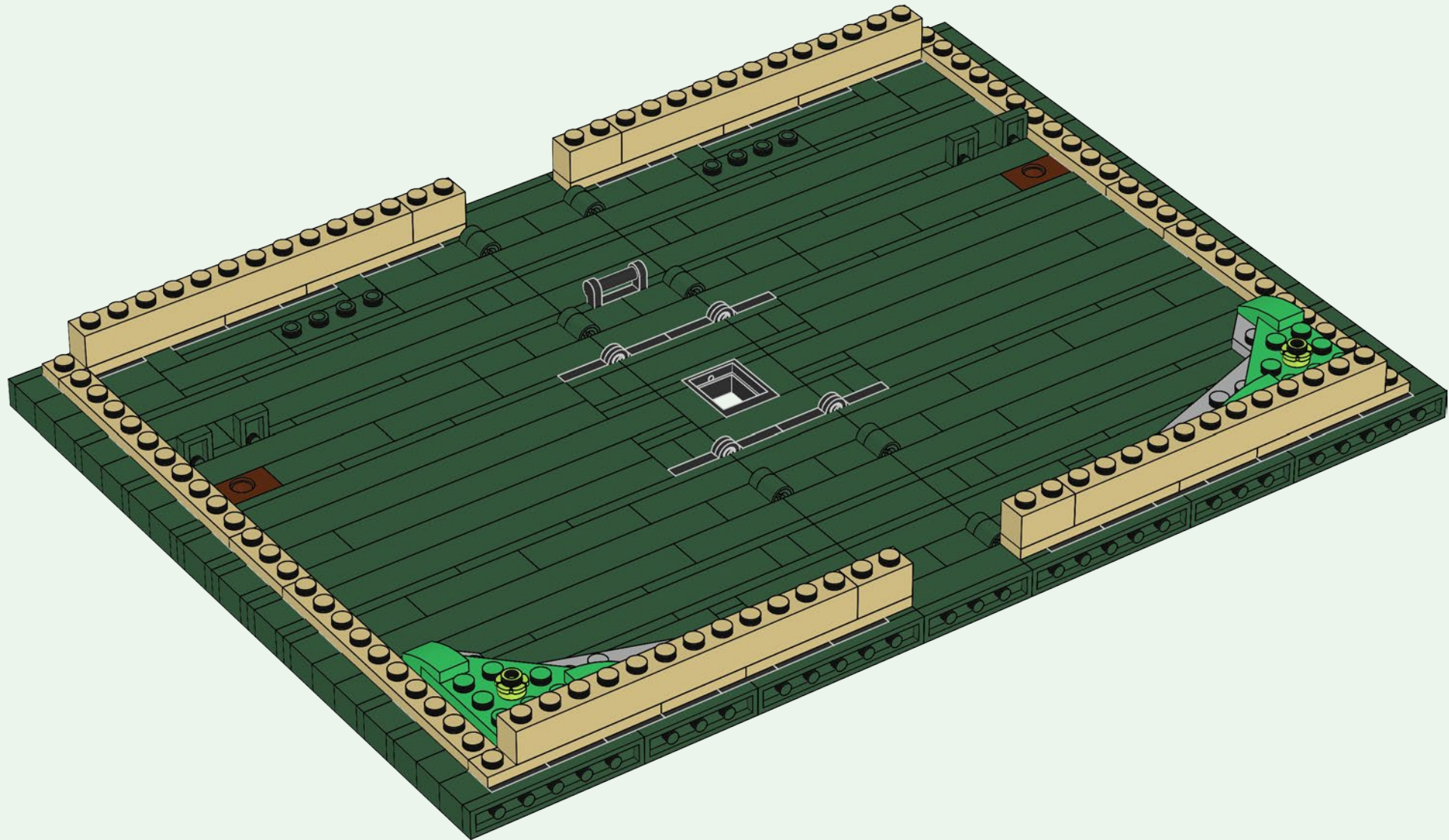

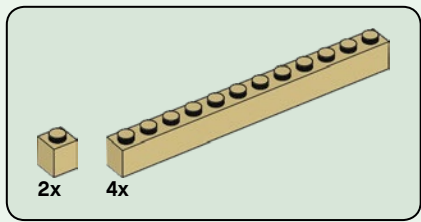

69

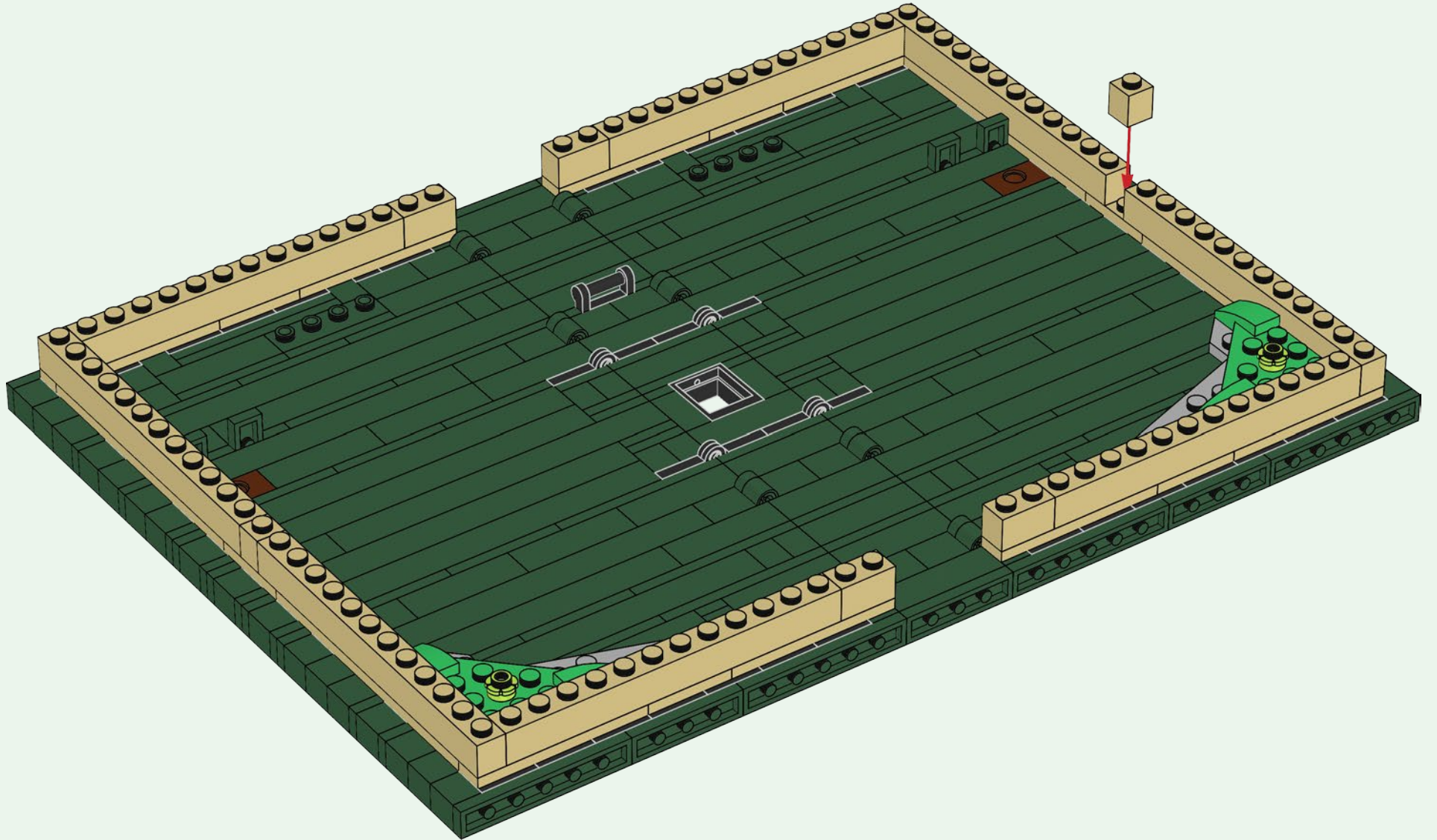



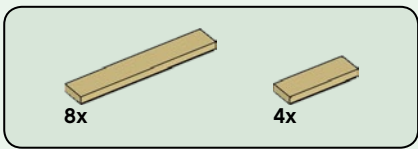

70

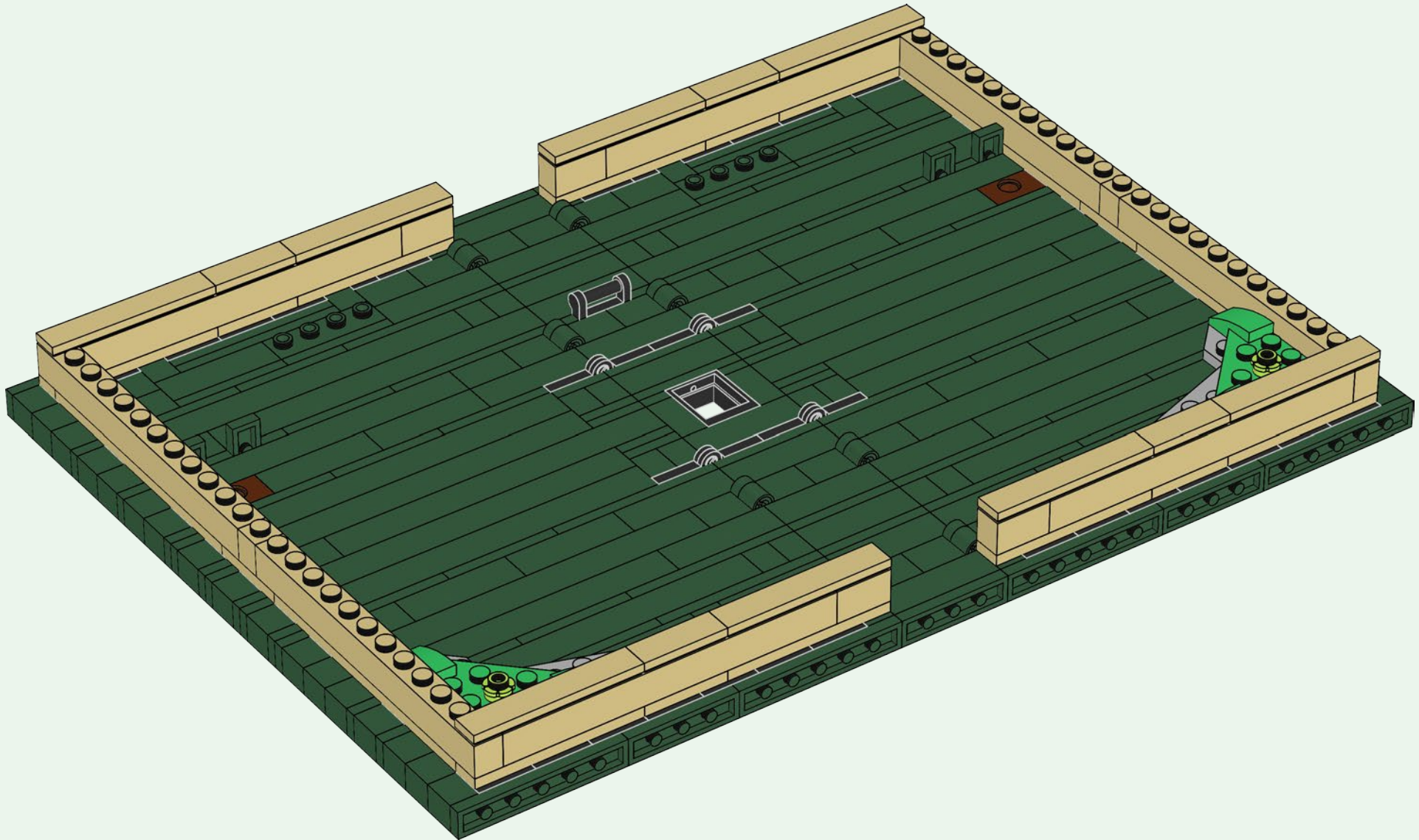

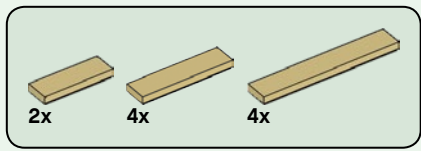

71

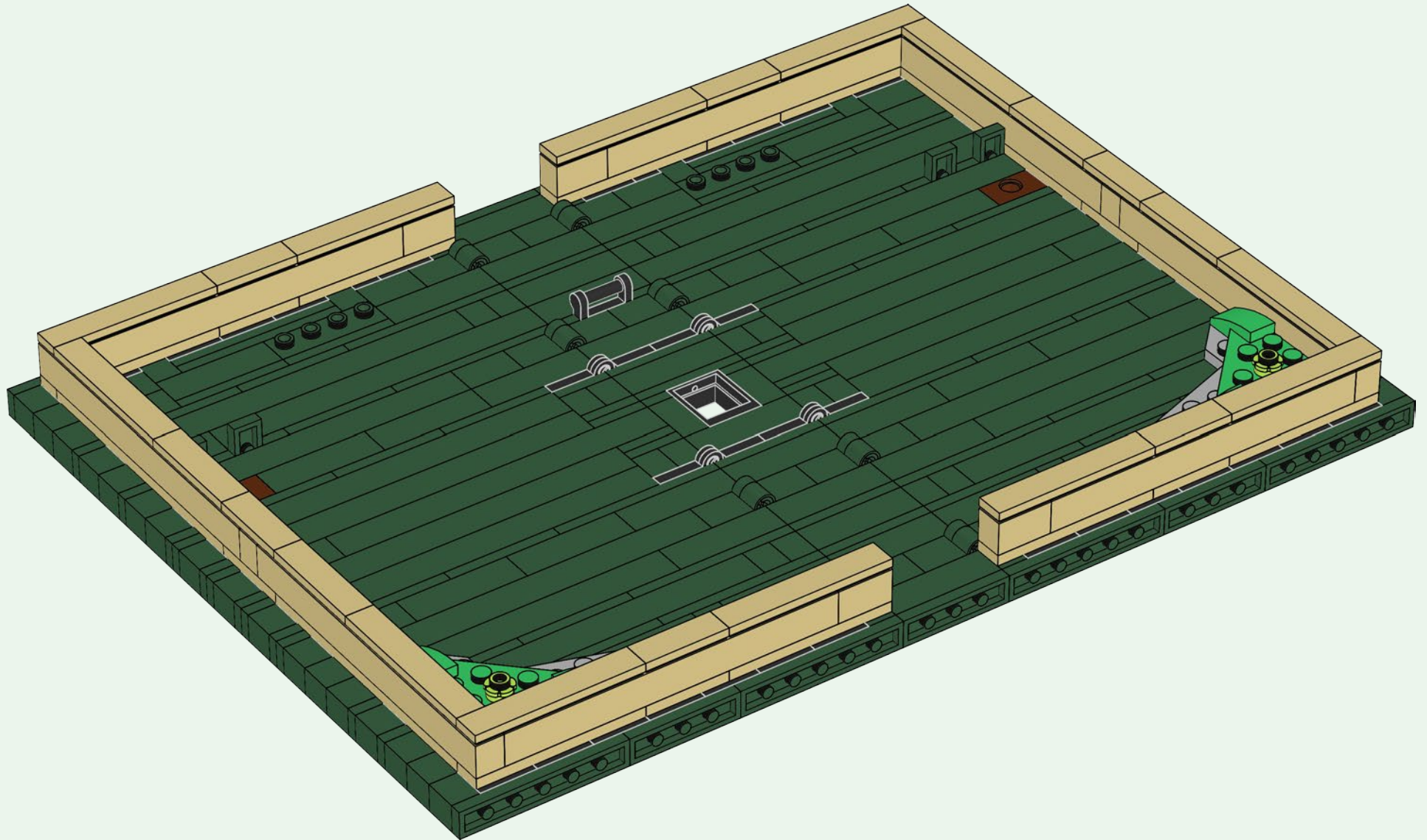

72

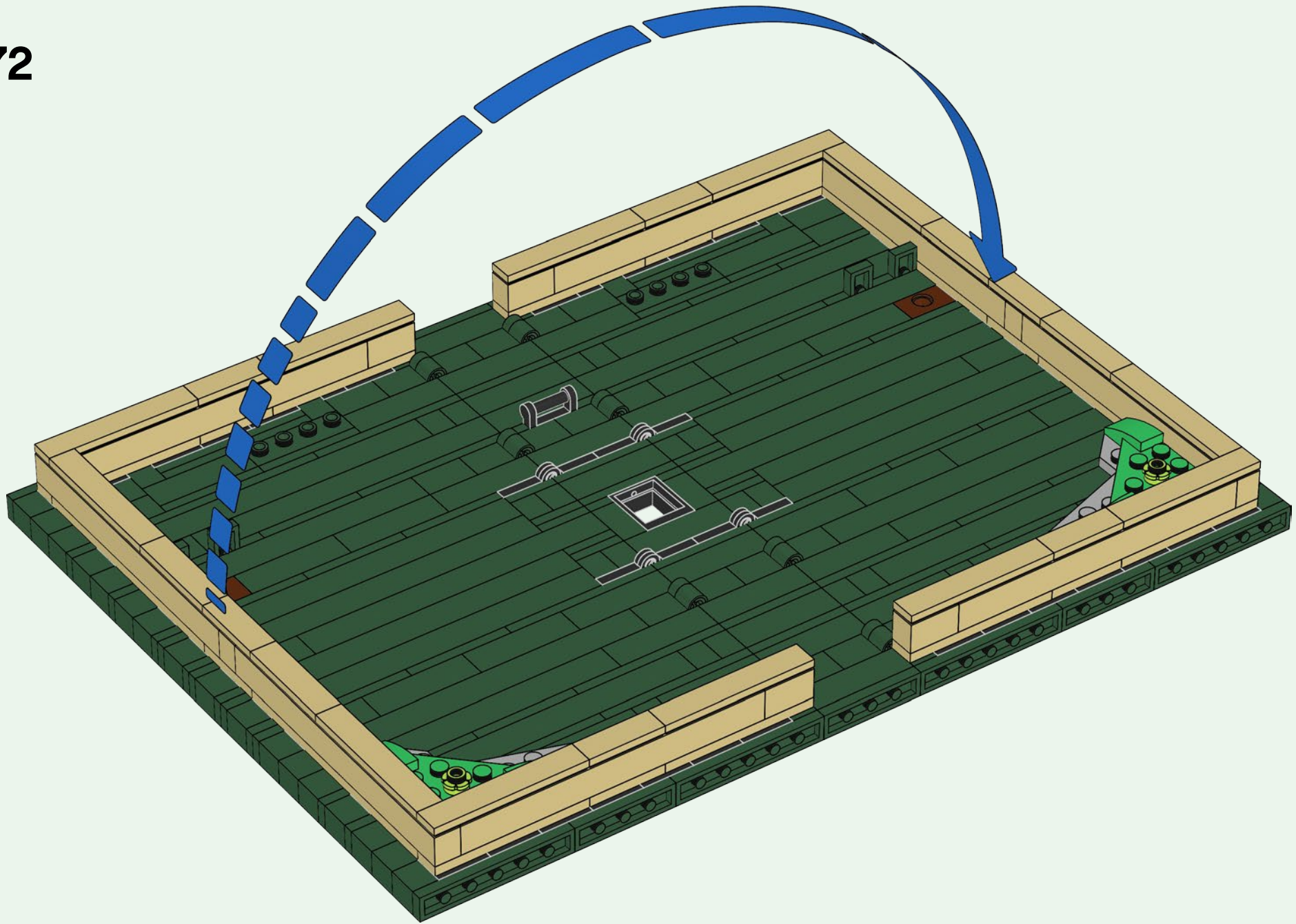



73

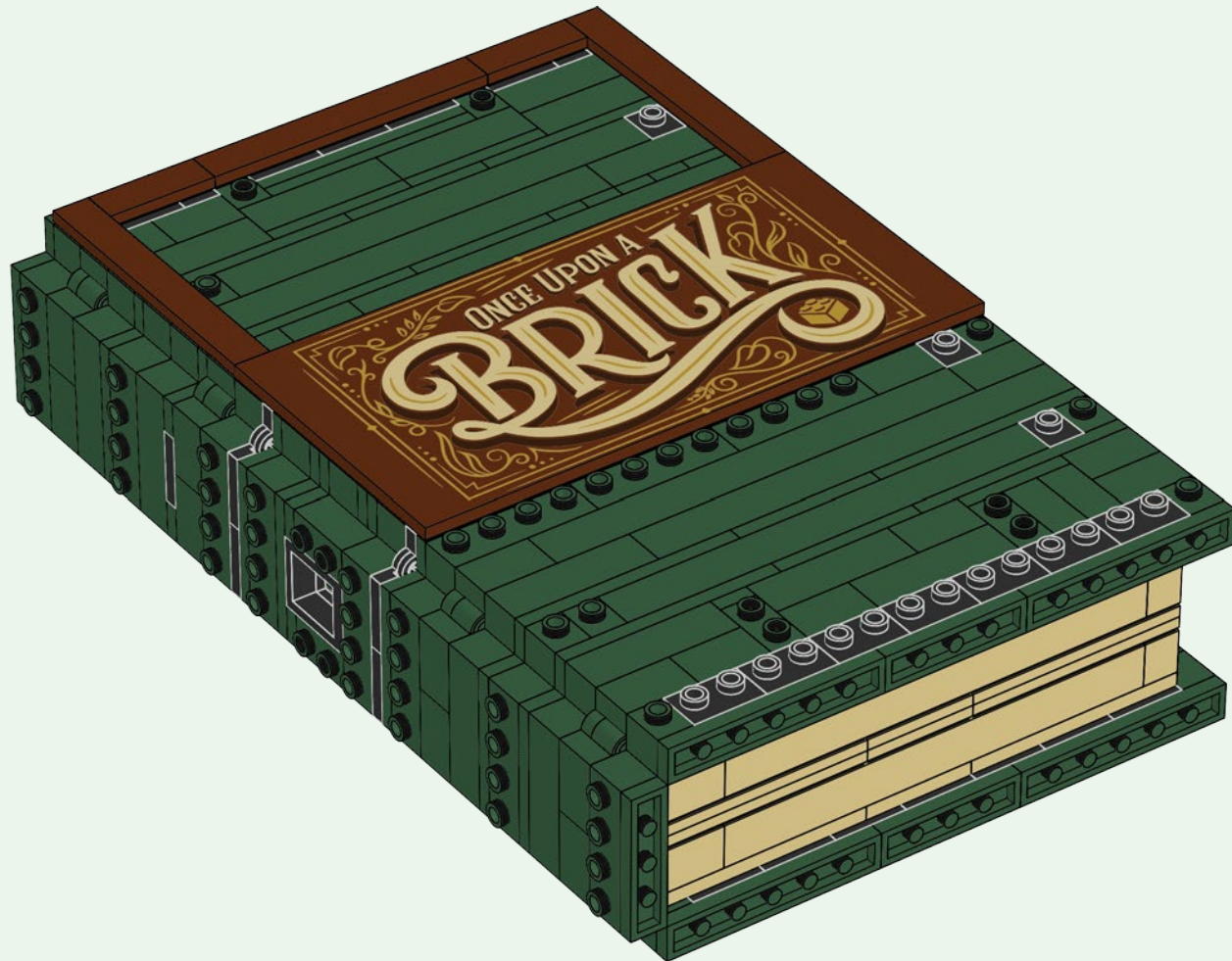

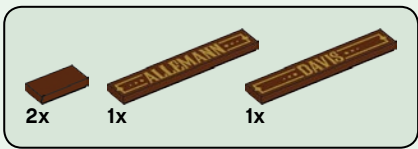

74



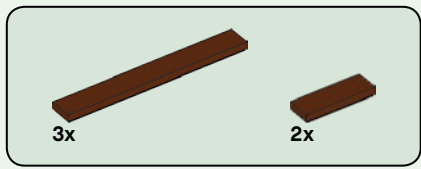

75

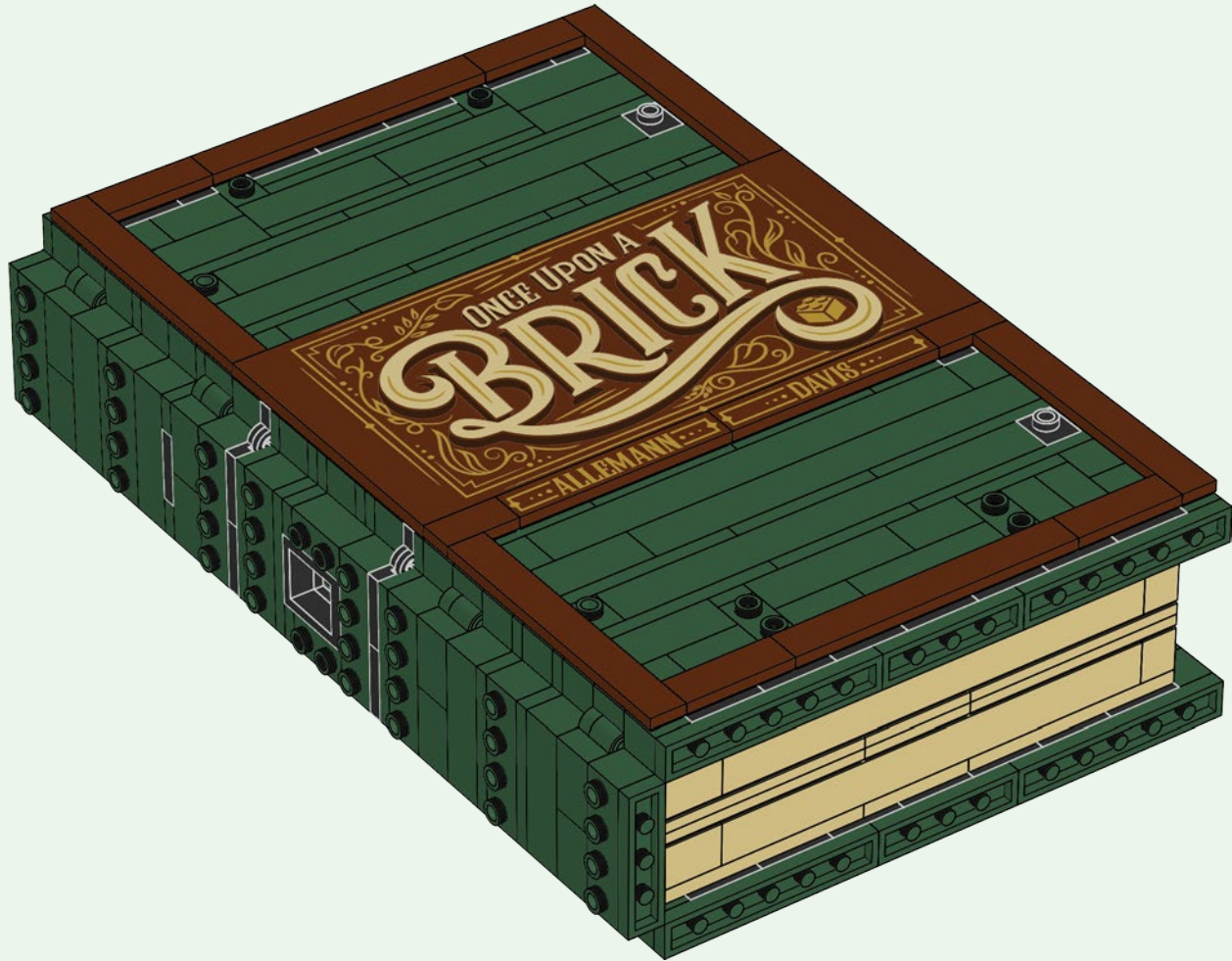

78



76



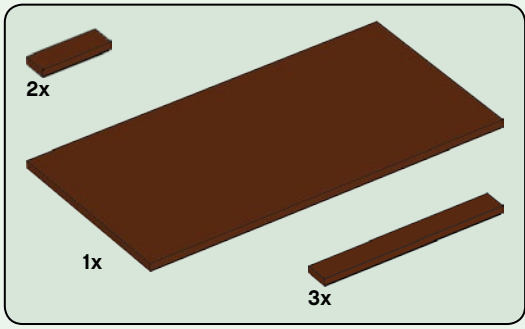

77

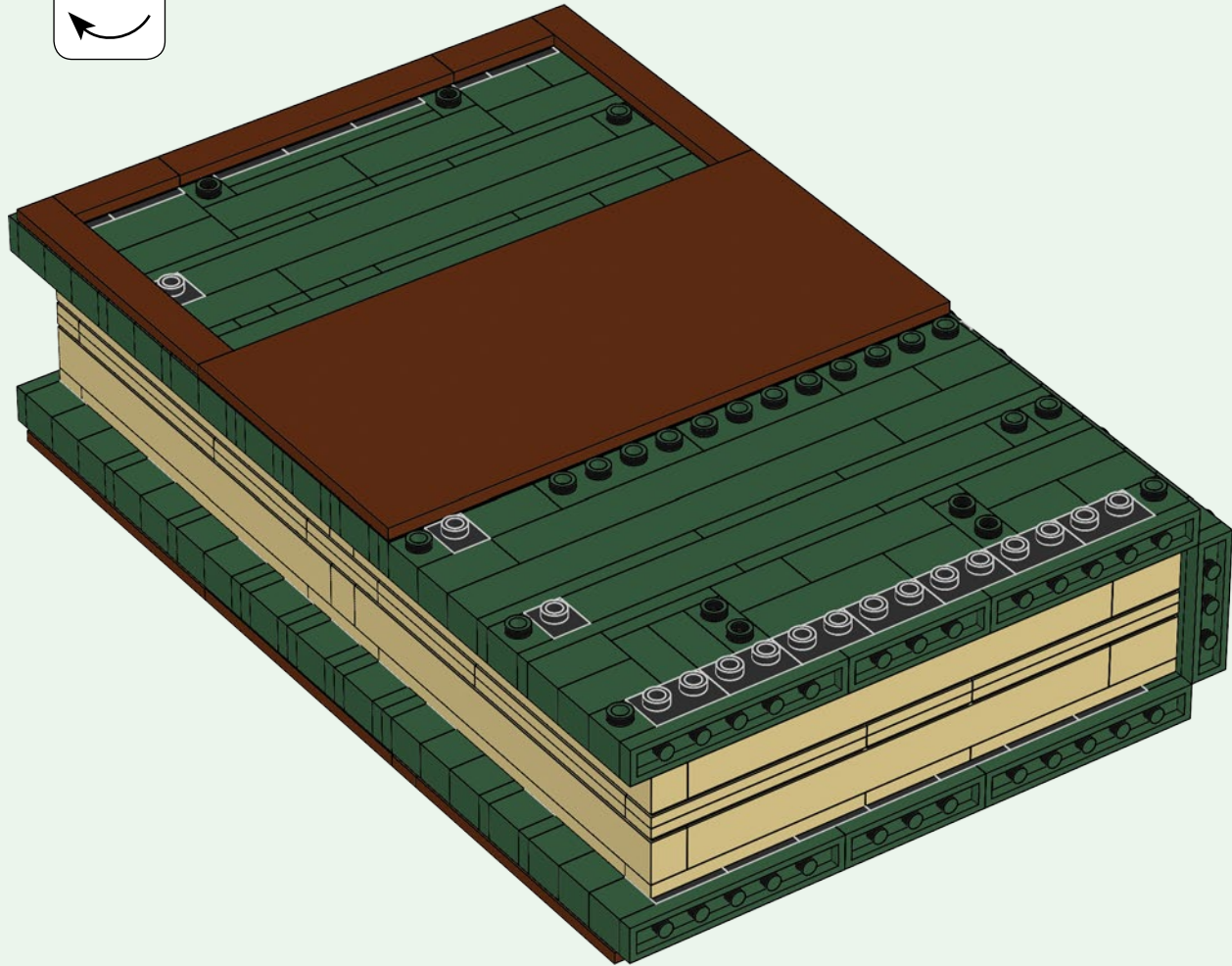
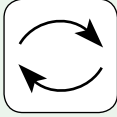



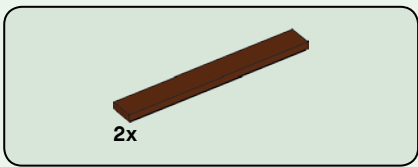

78

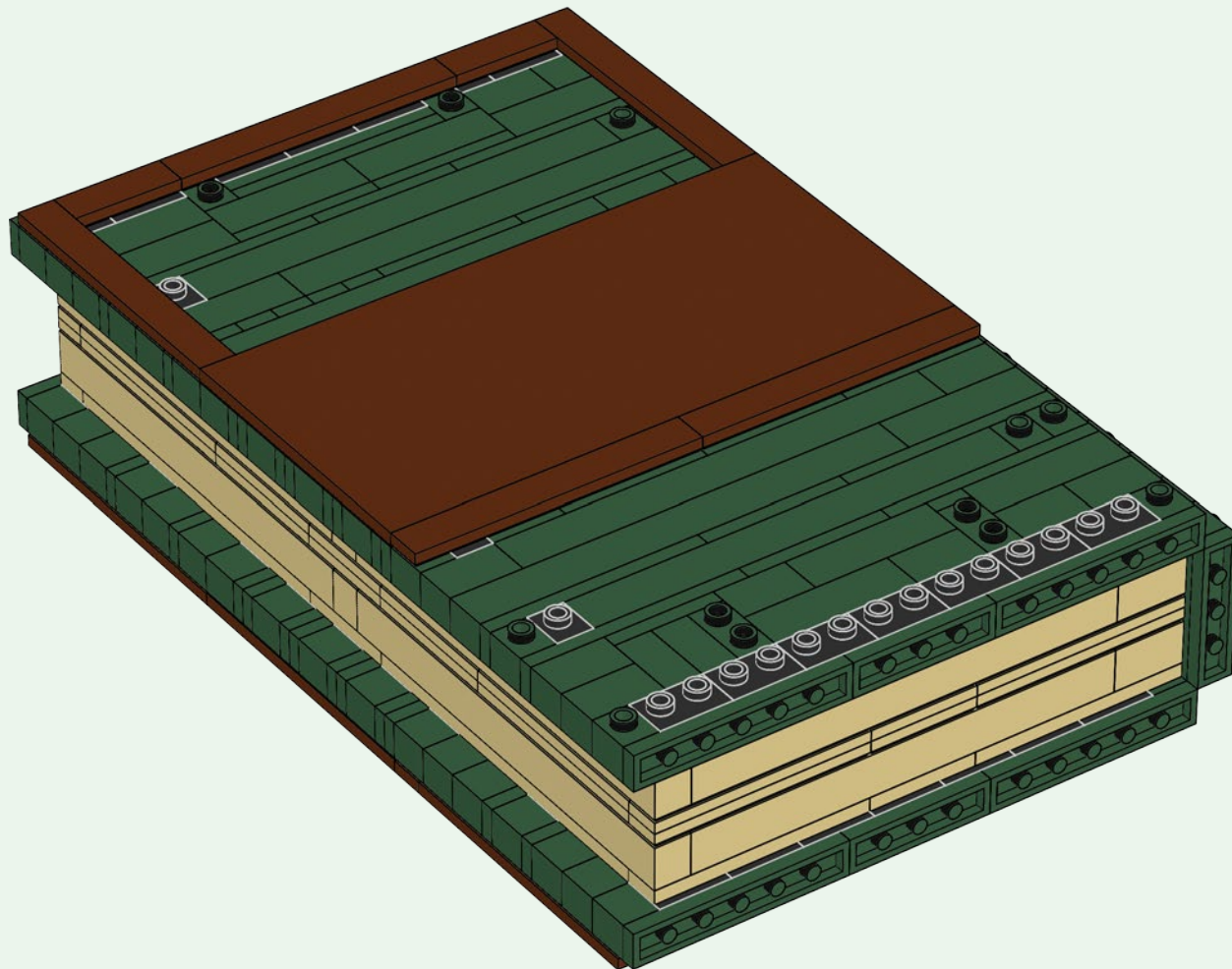

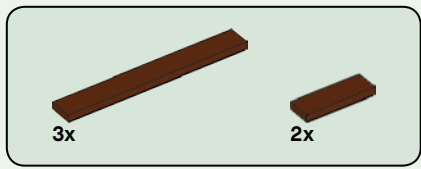

79

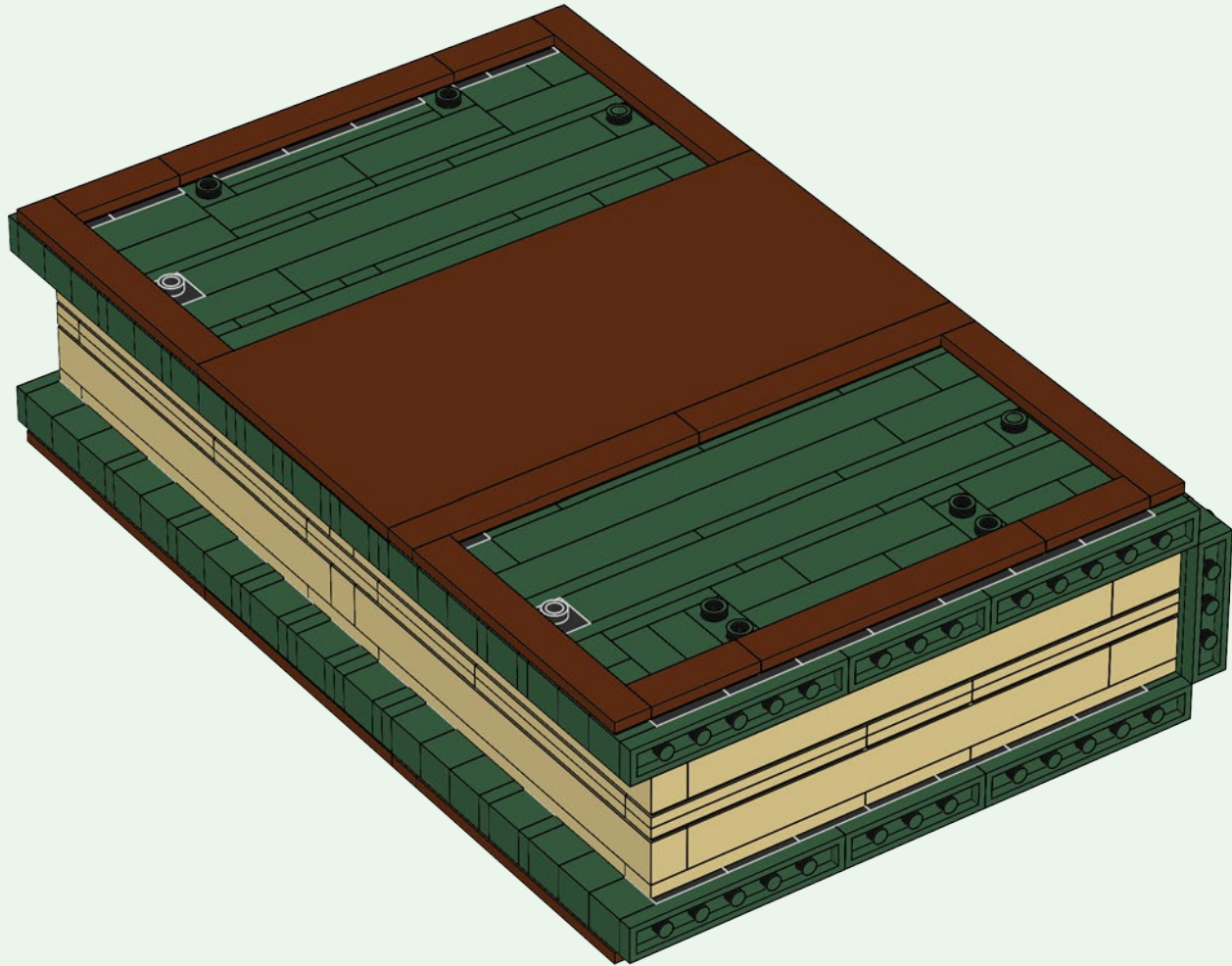

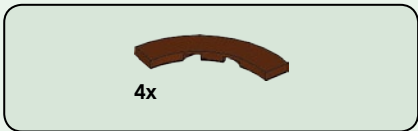

80

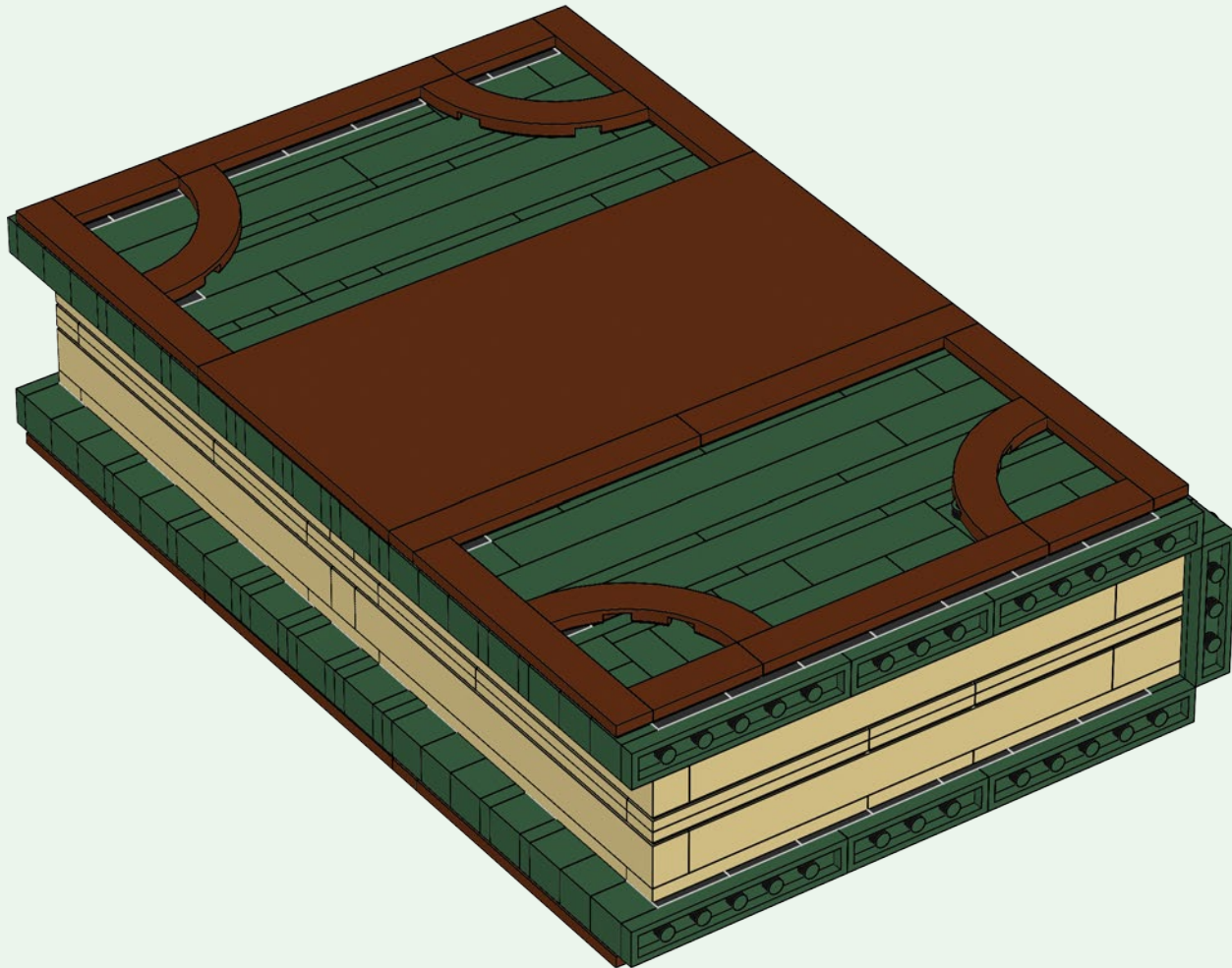

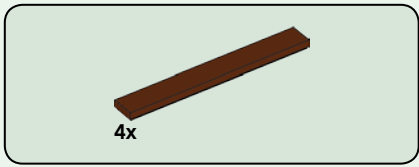

81

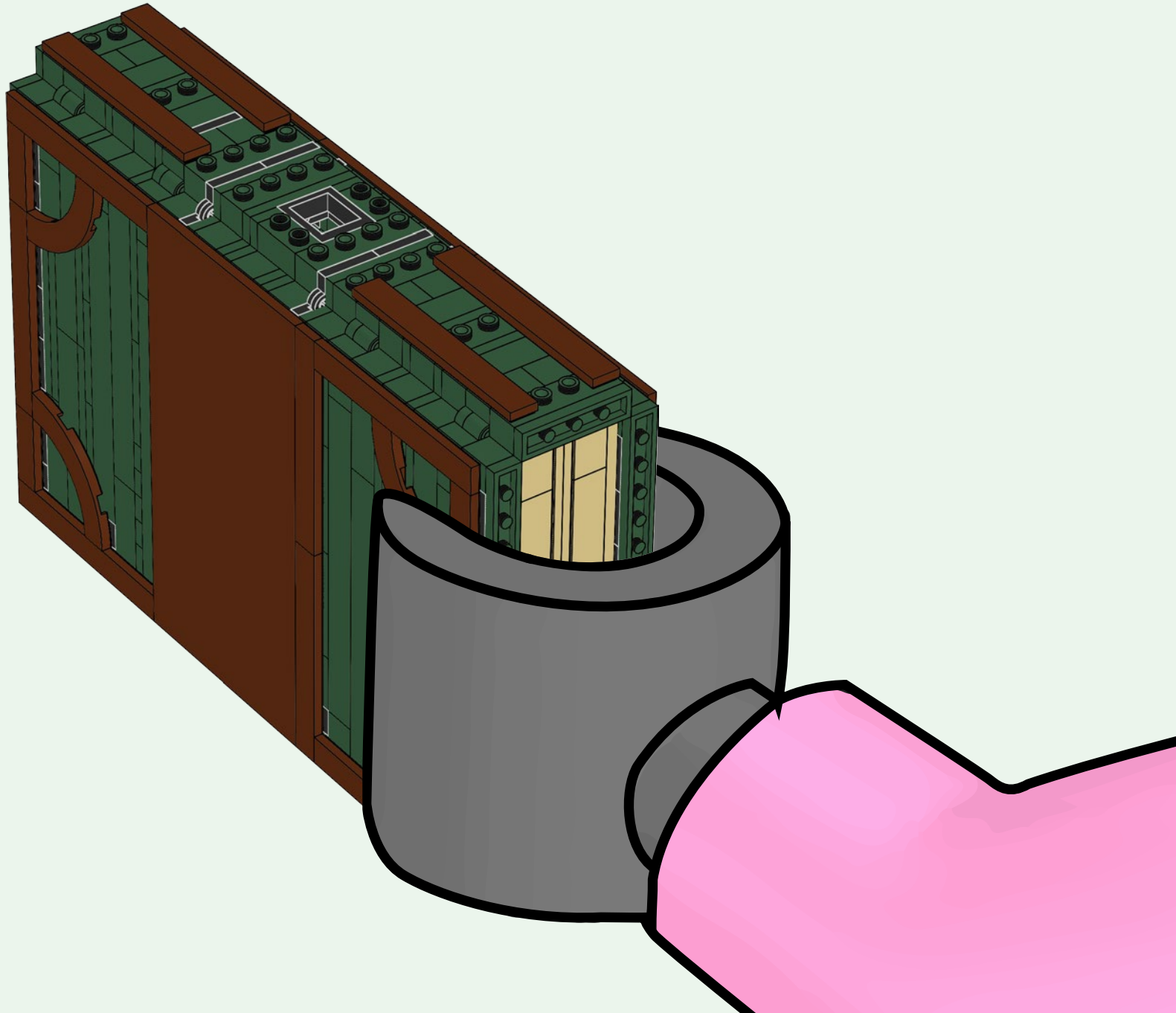
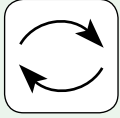

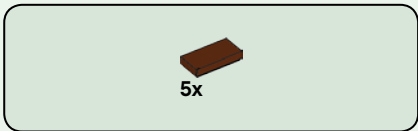

82

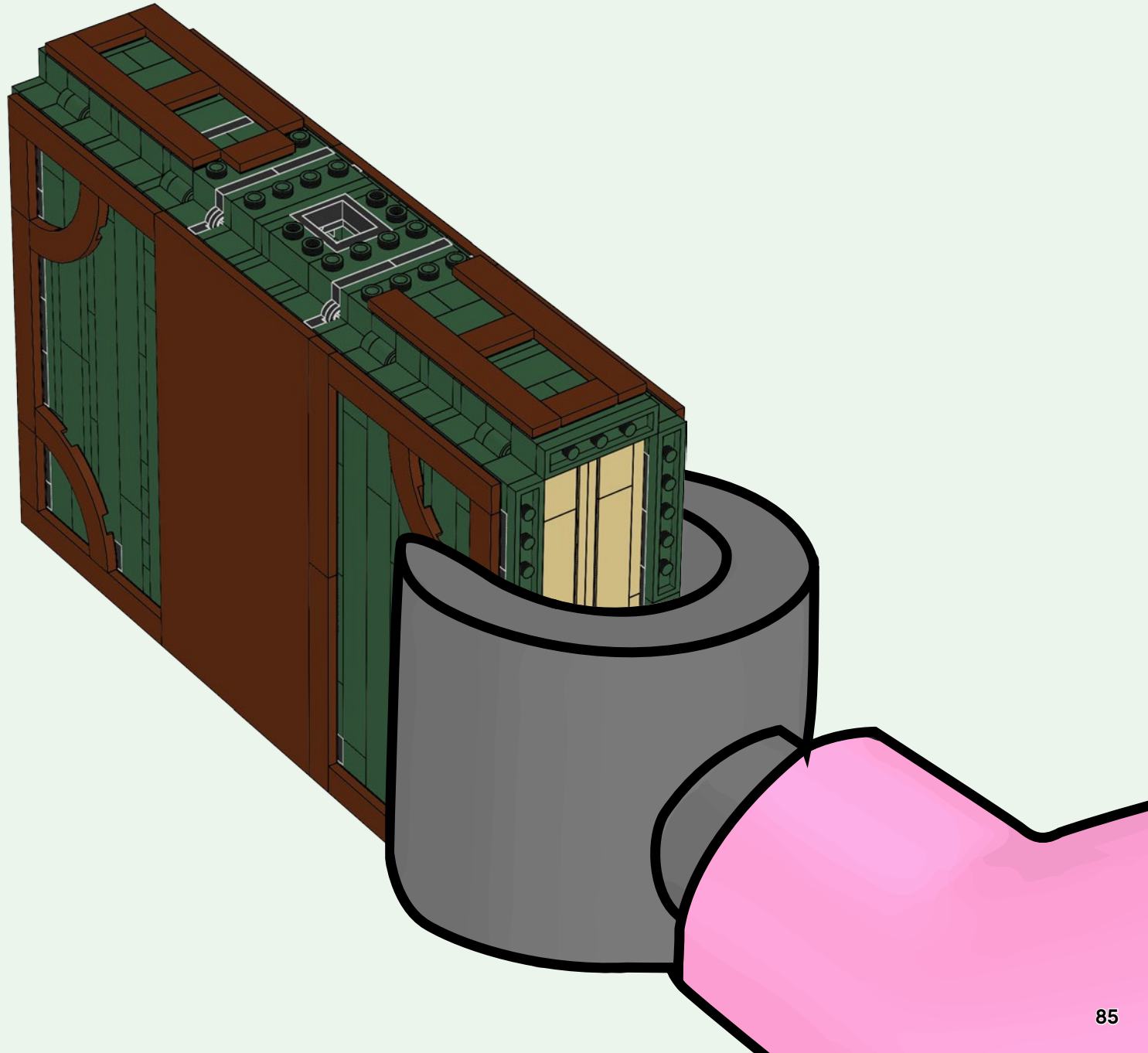

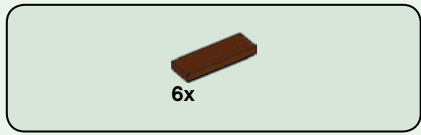

83

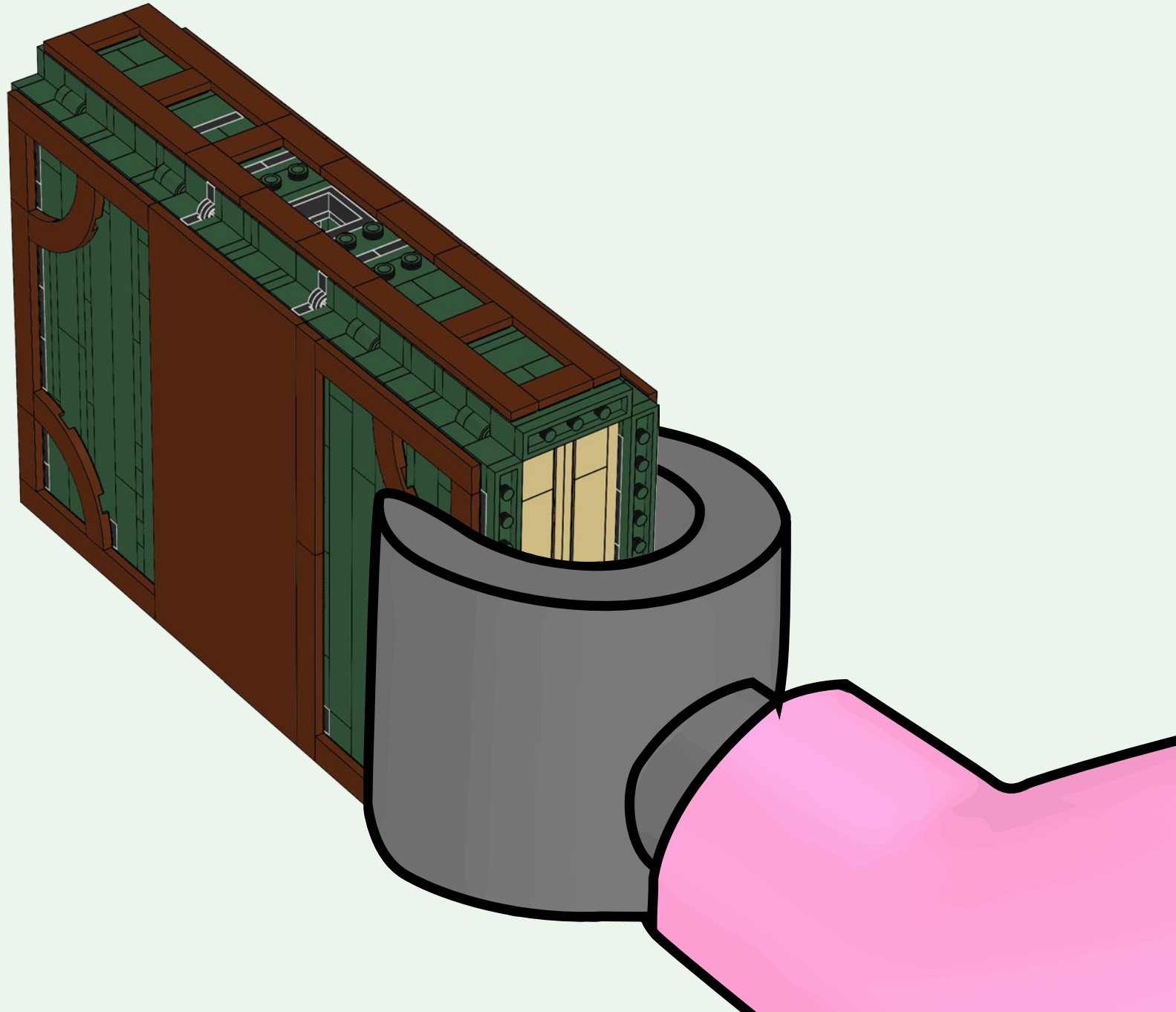

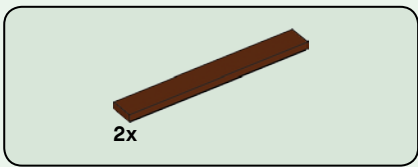

84

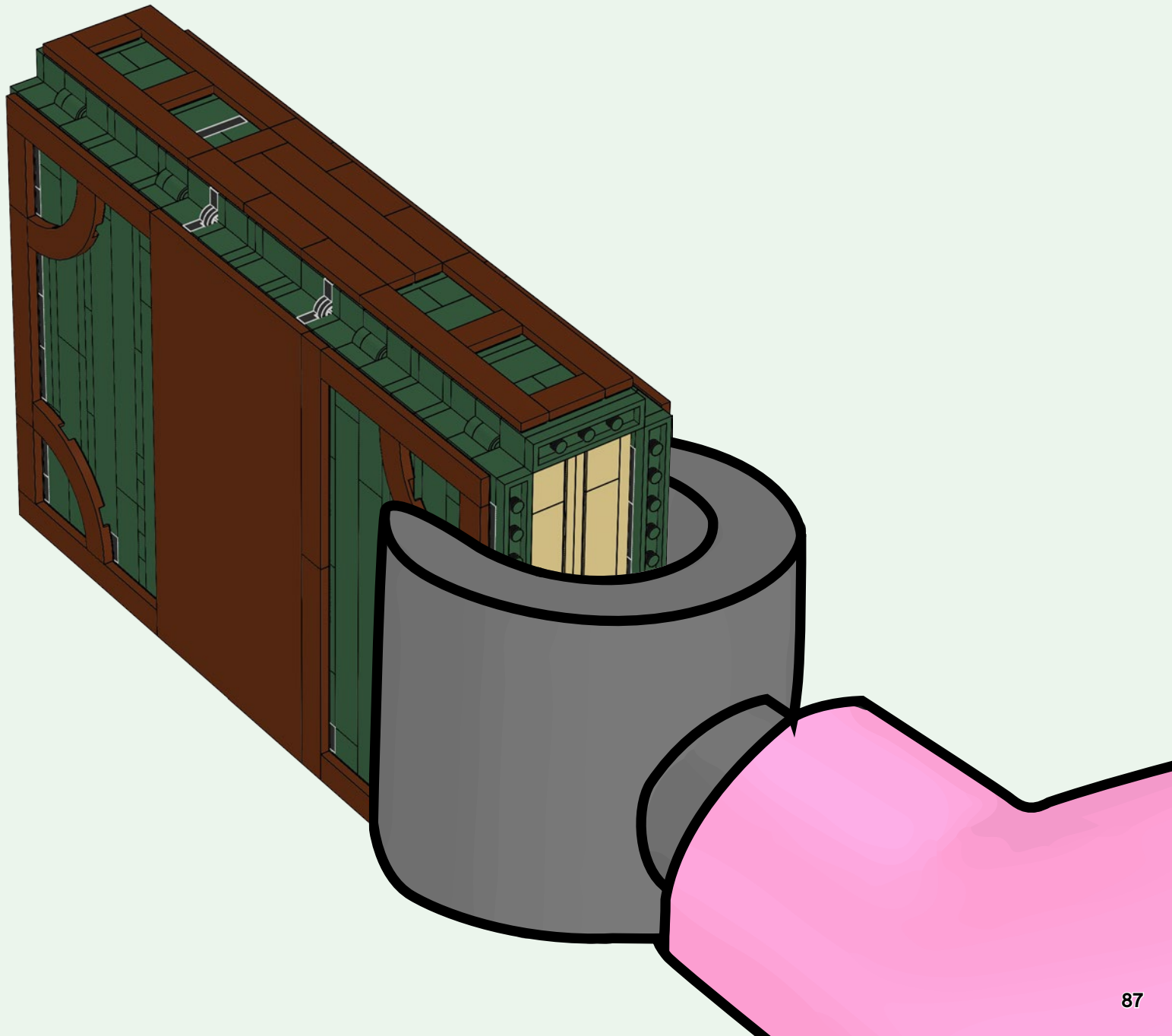

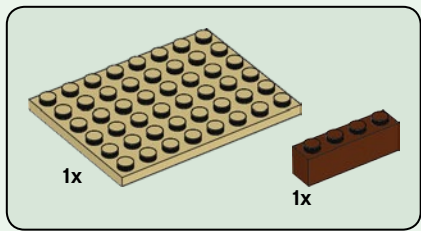

85

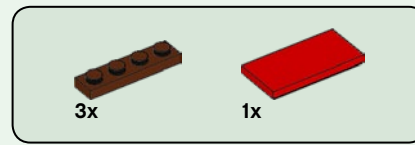
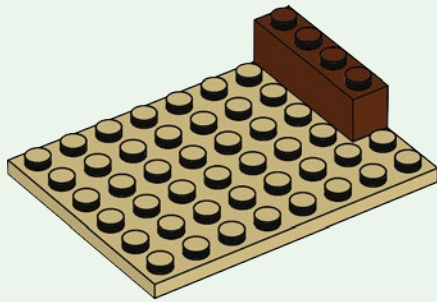

86

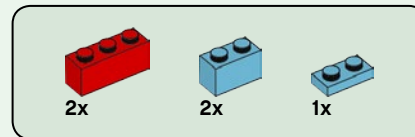
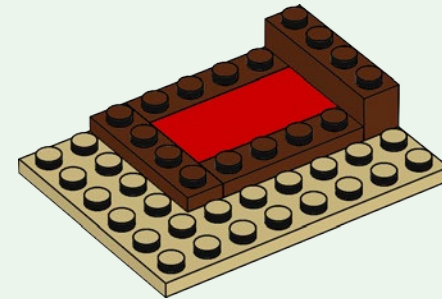

87

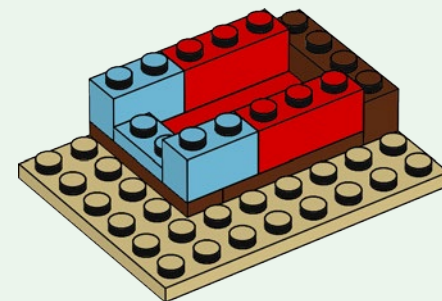



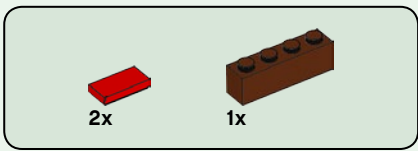

88

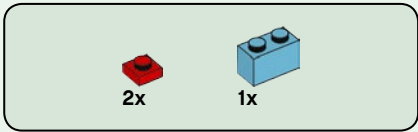
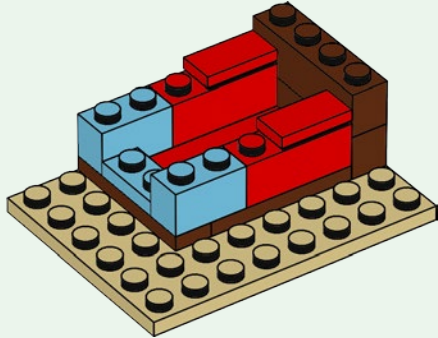

89

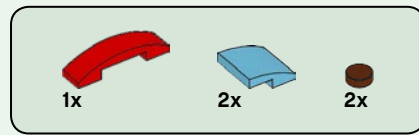
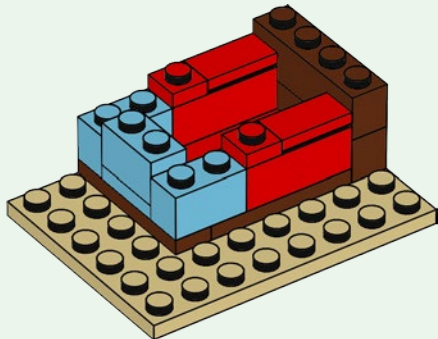

90

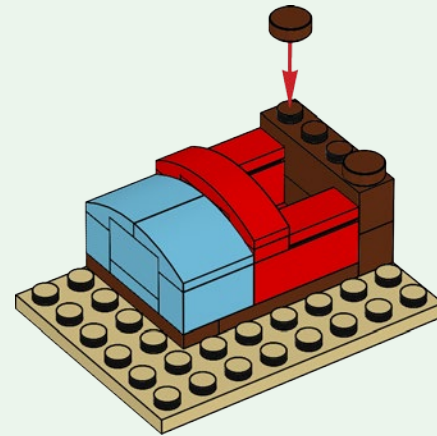

91

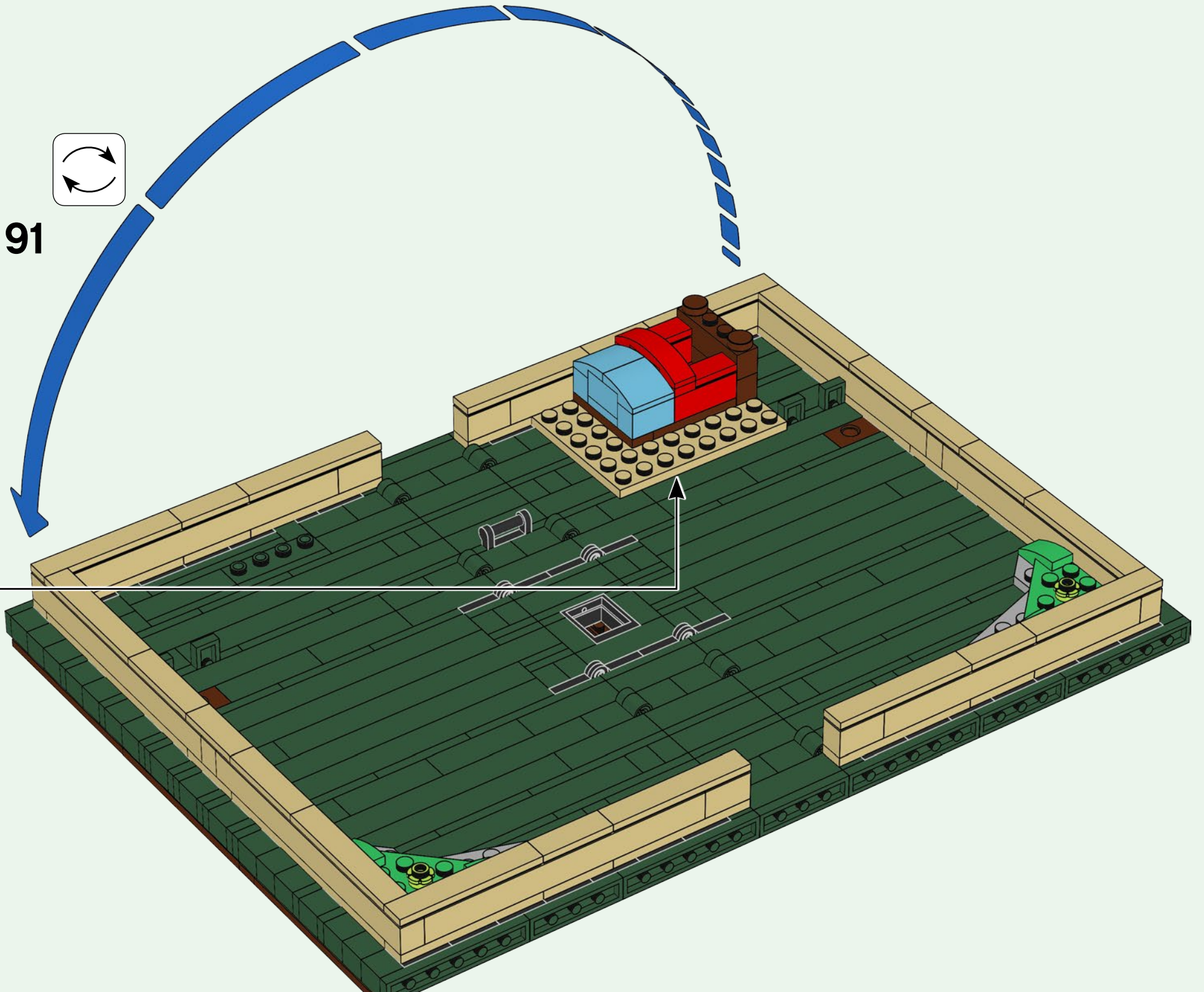

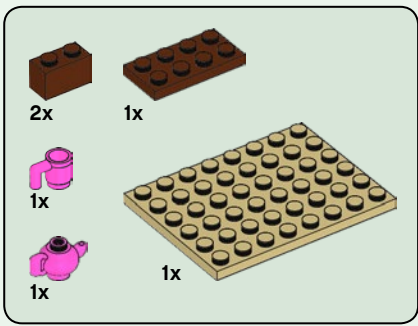

92

1

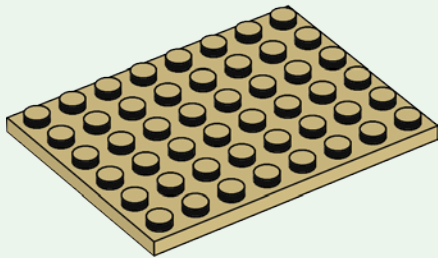

2

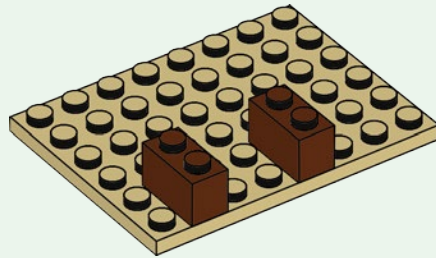

3

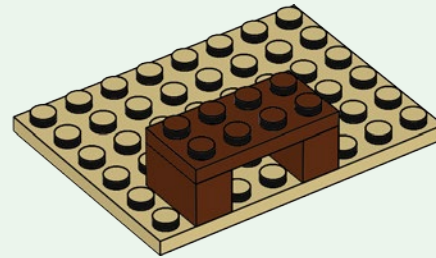

4

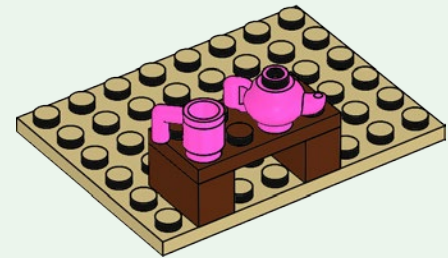

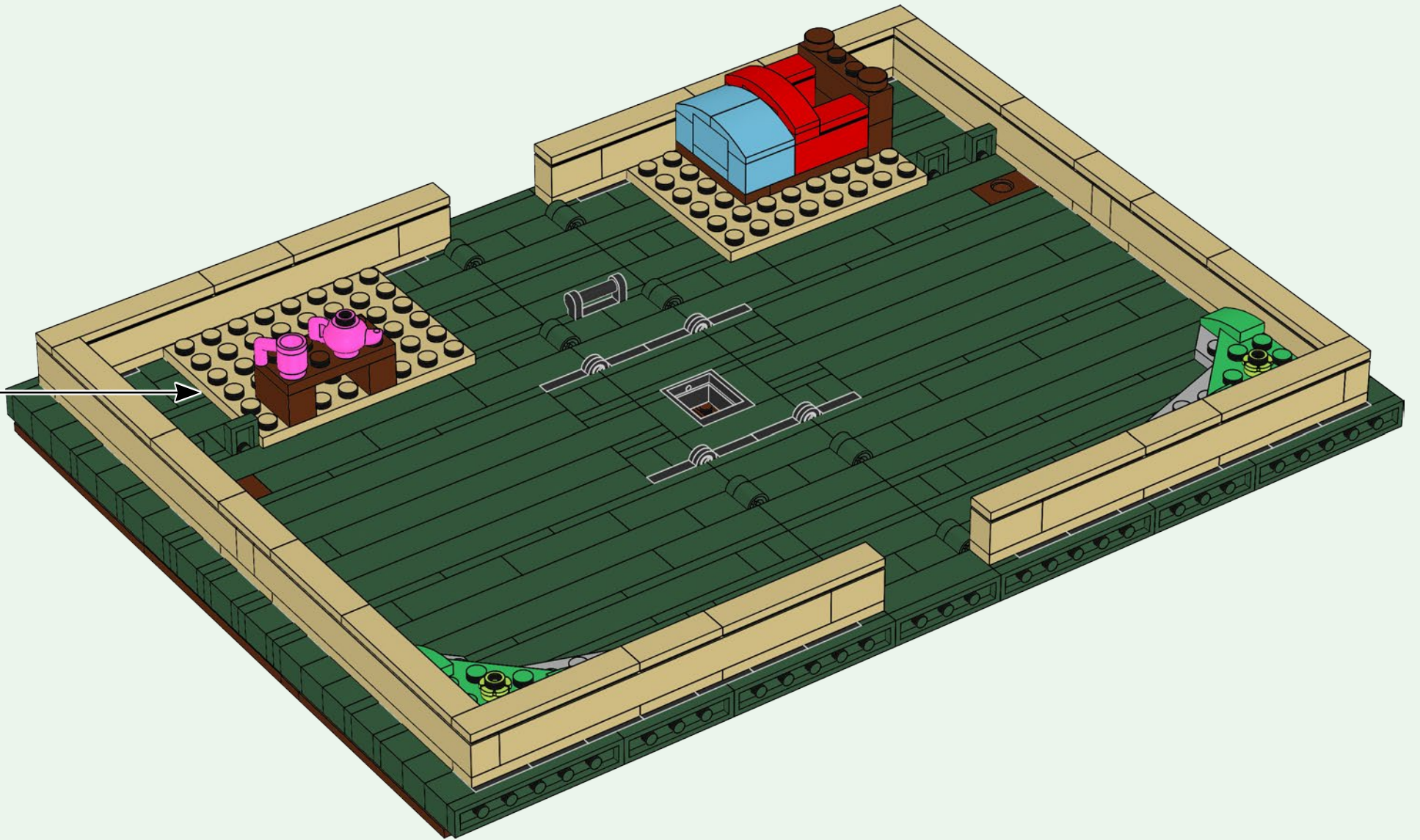

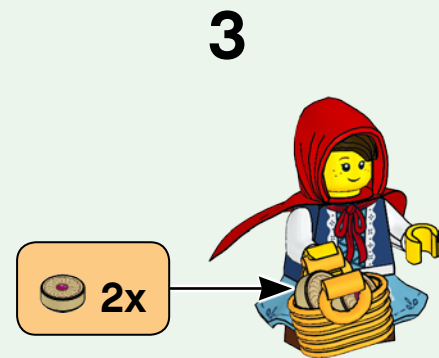
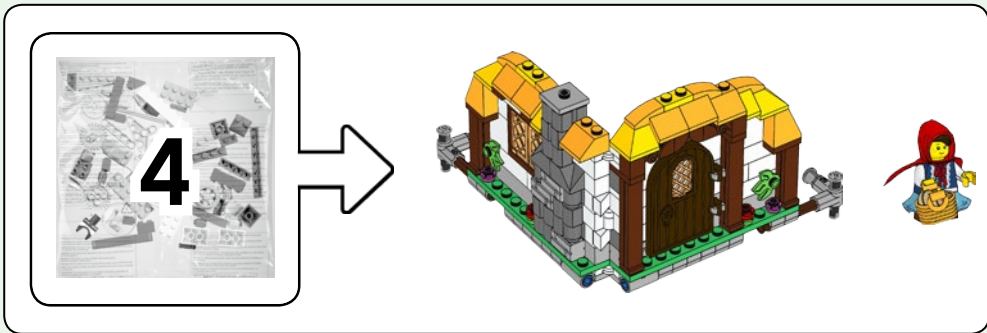

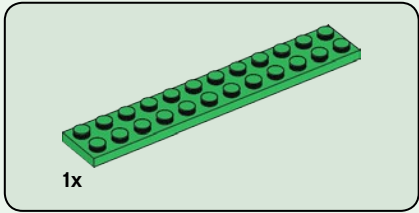
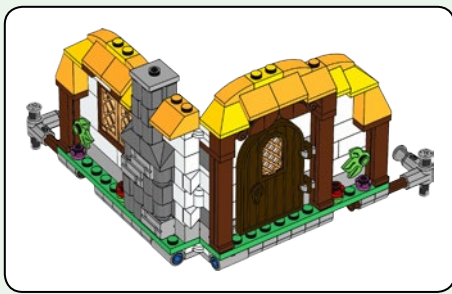

1x

93

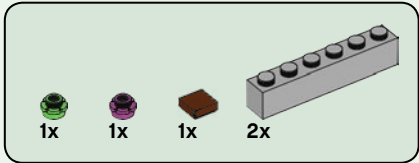
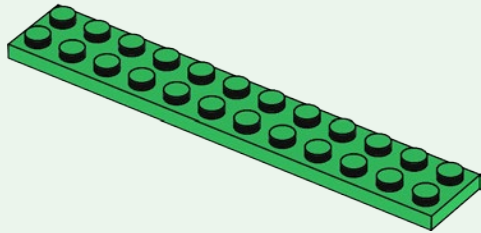

1x

1x

1x

2x

94

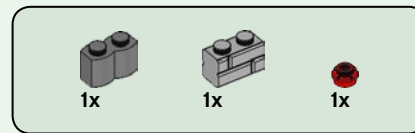
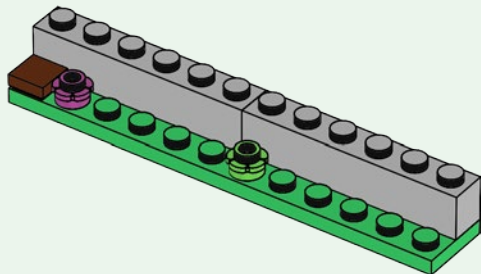

1x

1x

1x

95

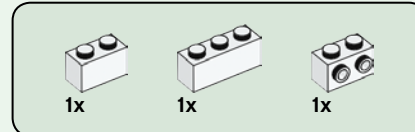
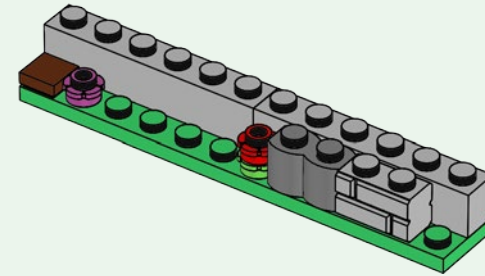

1x

1x

1x

96

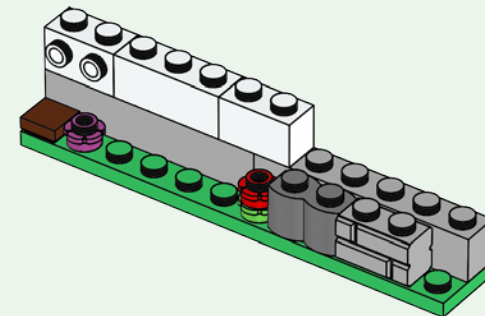

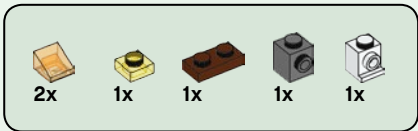

97

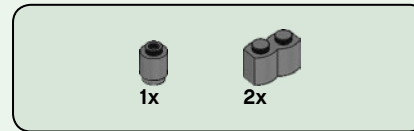
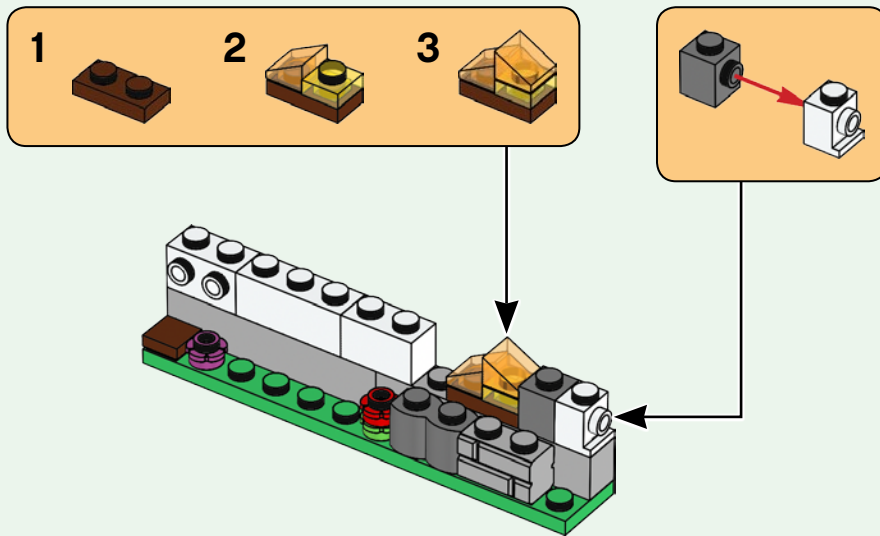

98

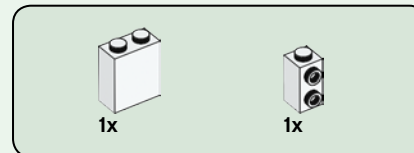
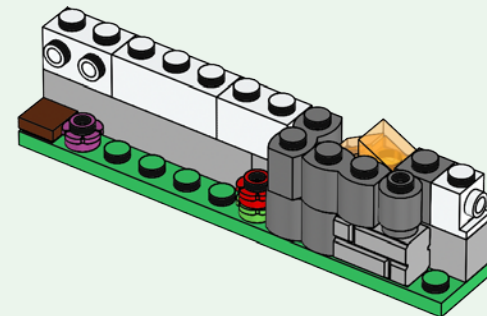

99

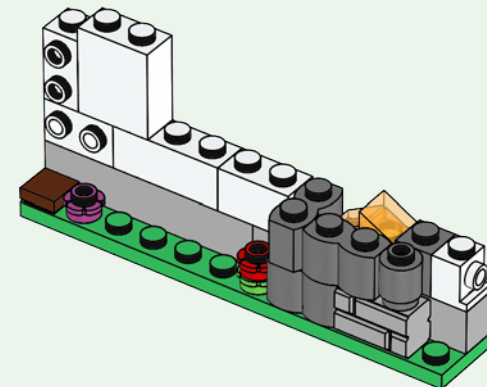

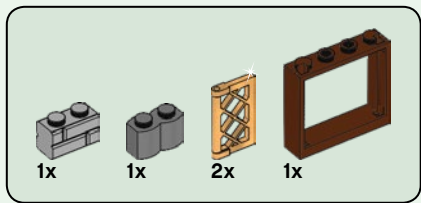

100

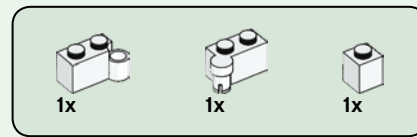
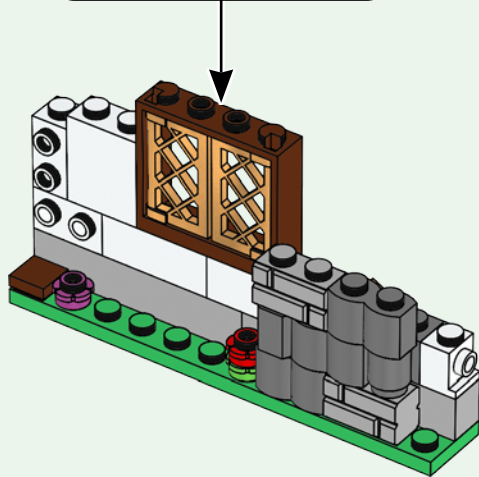
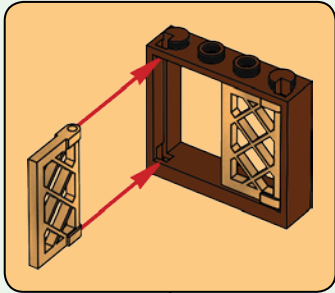

101

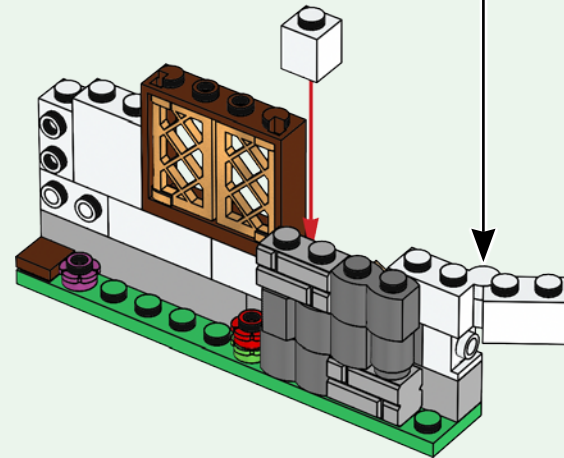
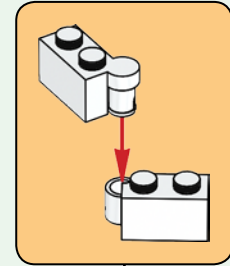



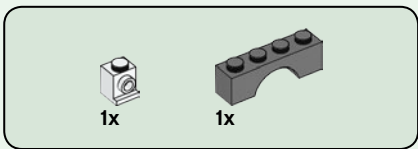

102

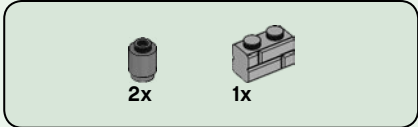
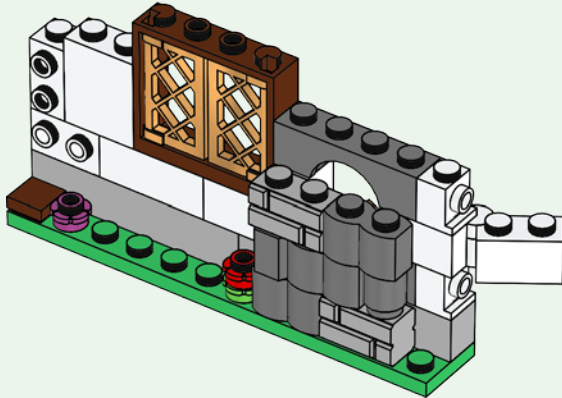

103

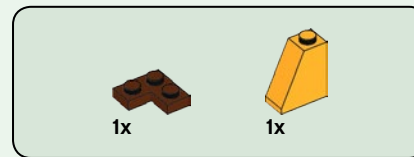
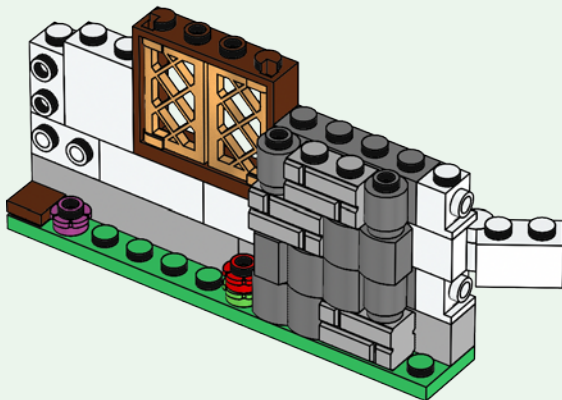

104

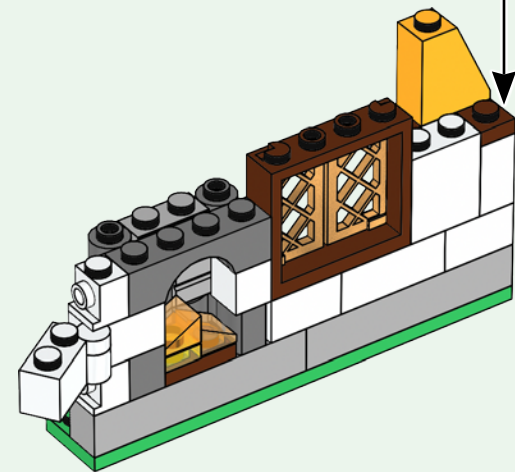
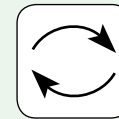
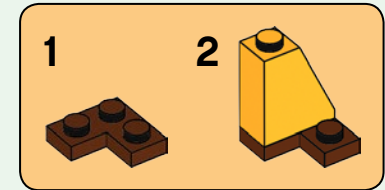

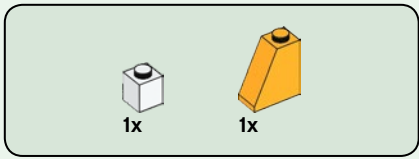

105

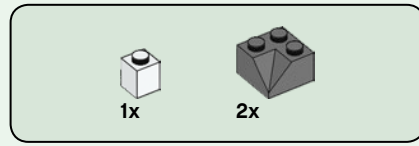
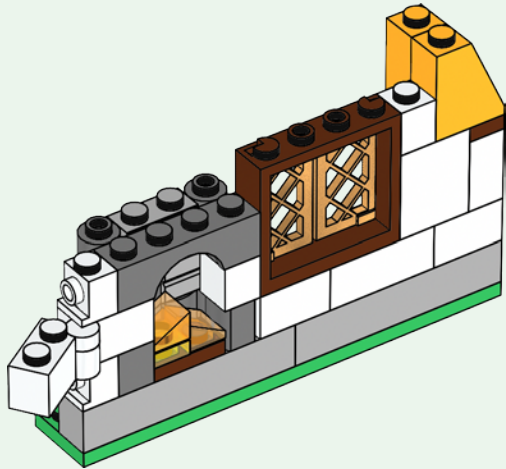

106

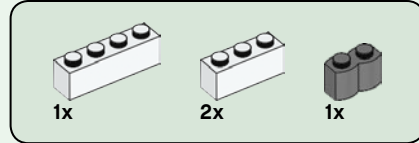
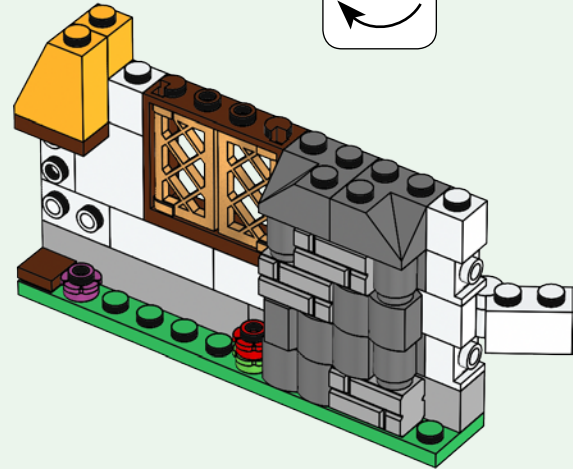

107

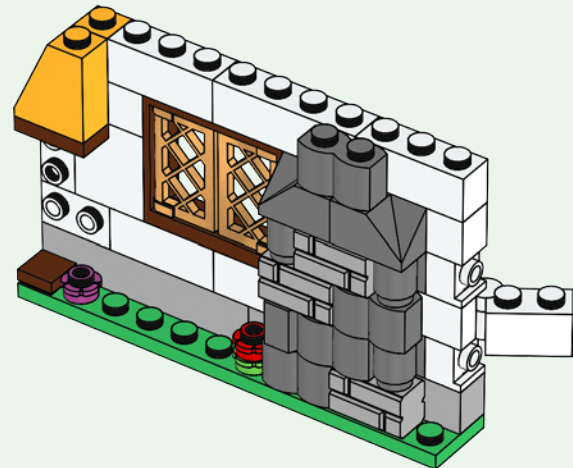

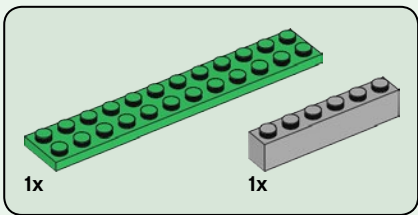

108

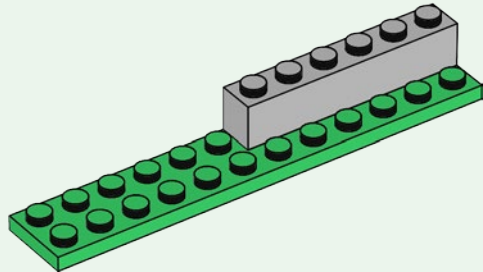

109

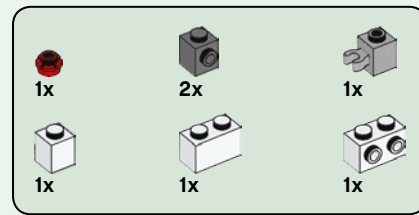
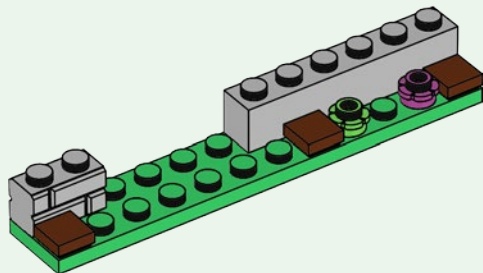

110

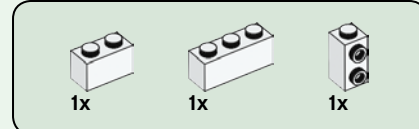
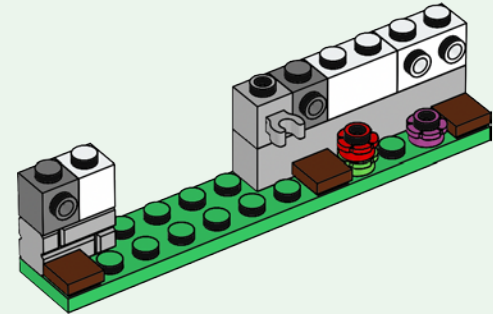

111

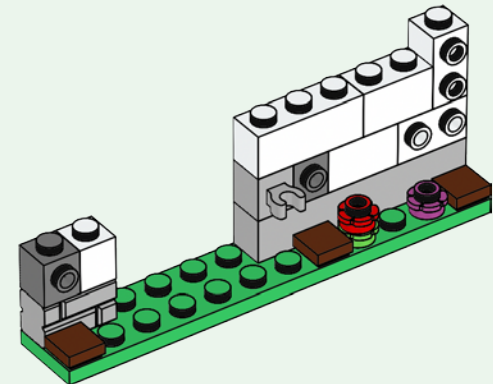

# 112

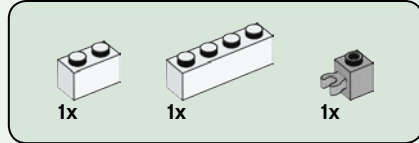
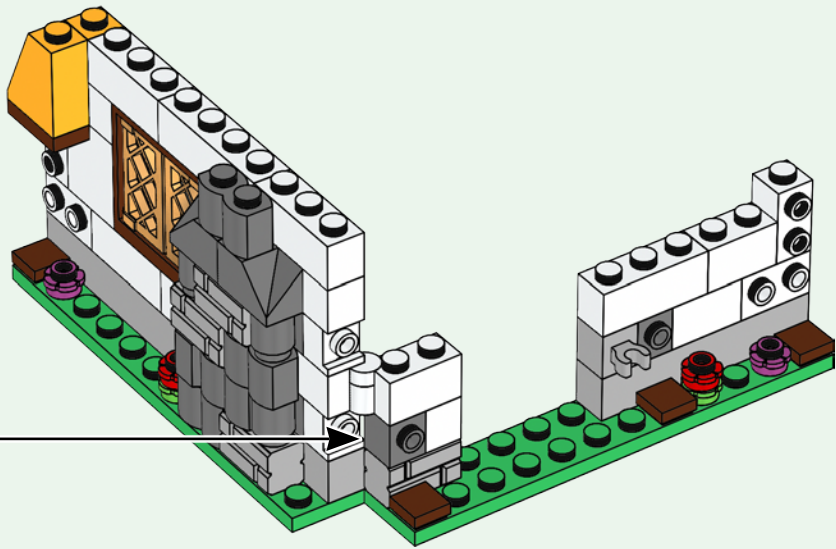

# 113

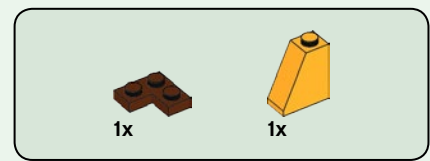
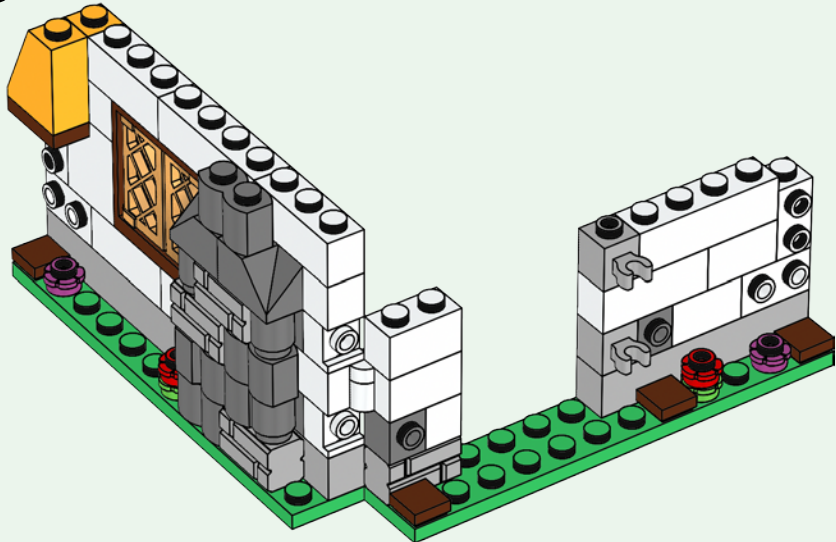

# 114

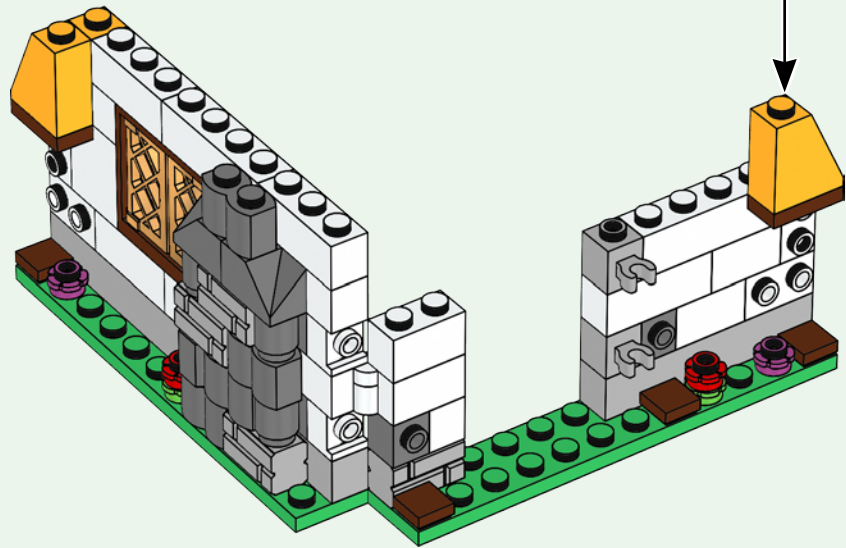

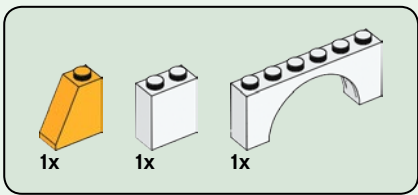

115

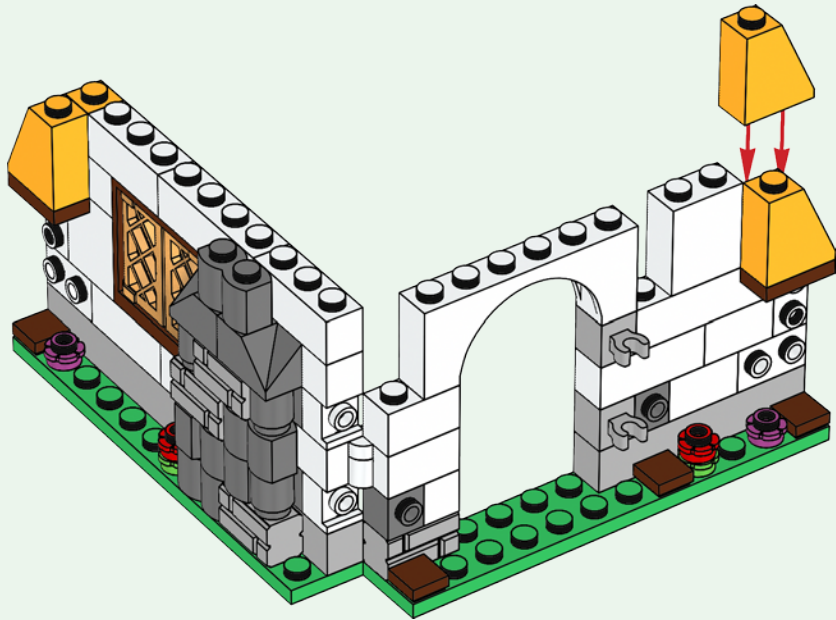

116

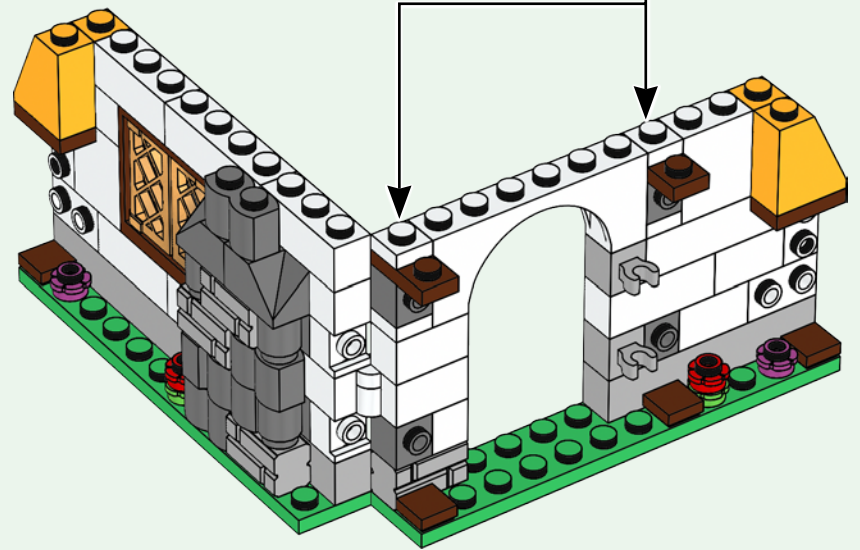
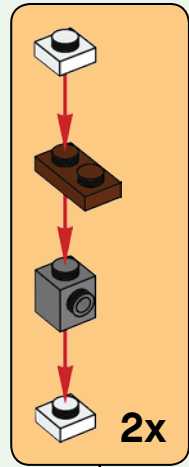

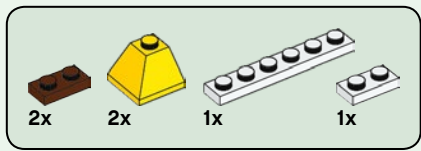

117

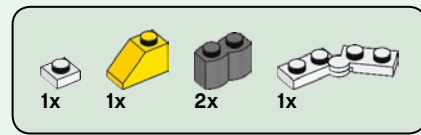
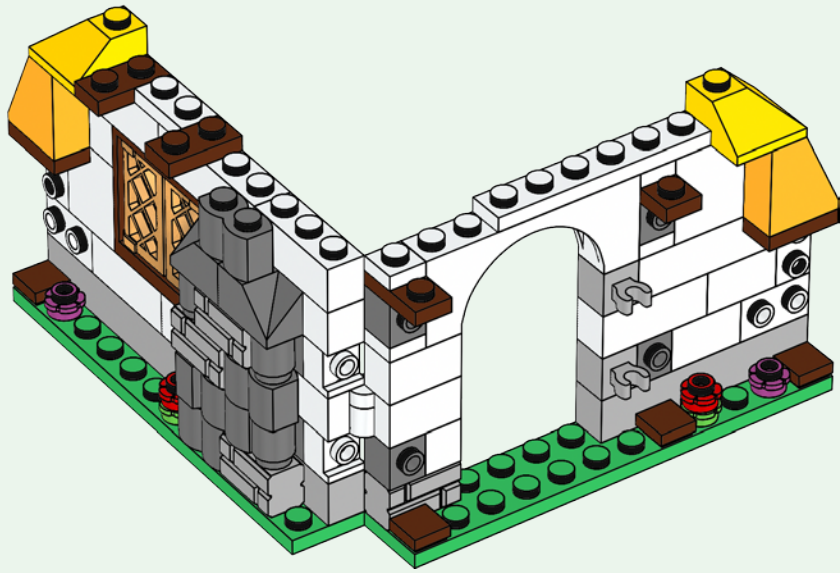

118

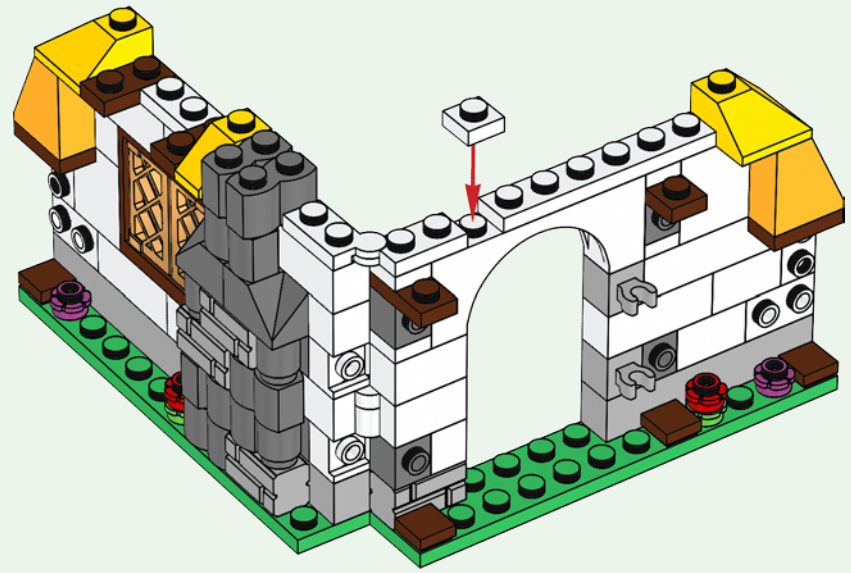

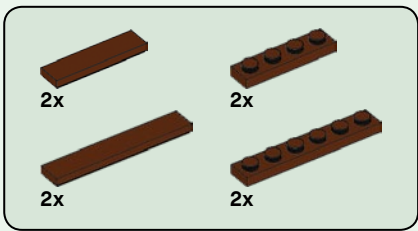

119

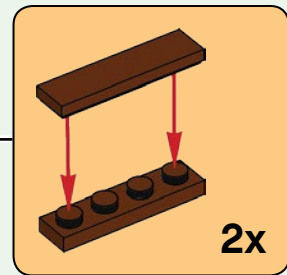
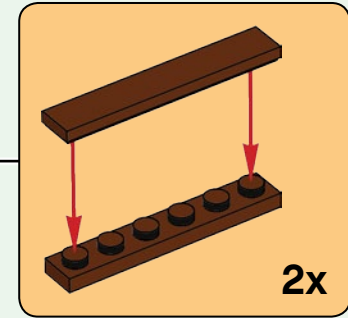
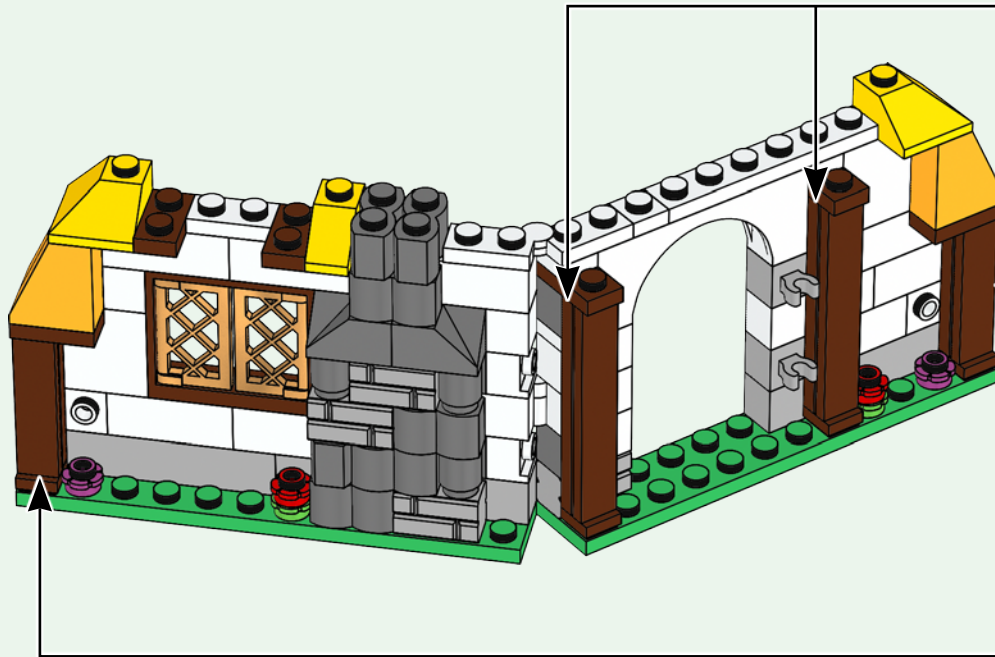

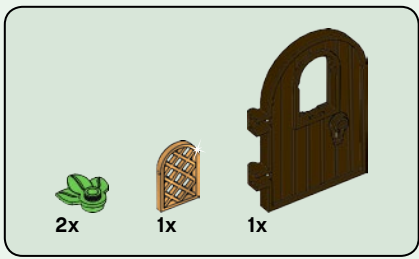

120

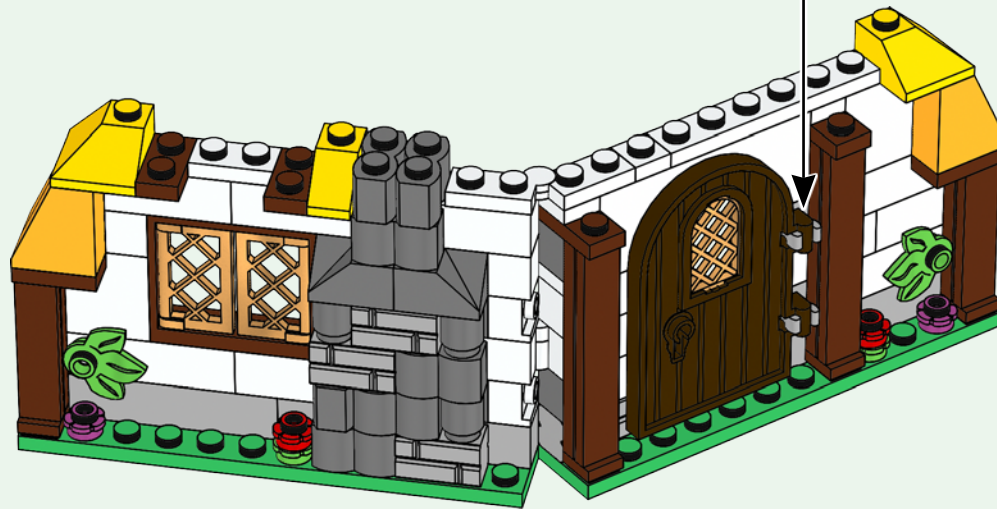
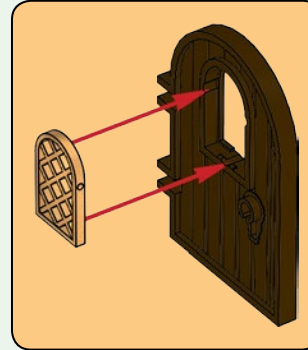



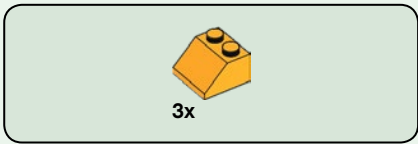

121

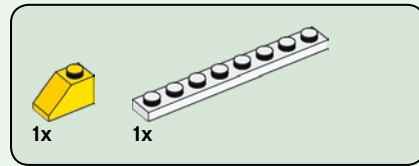
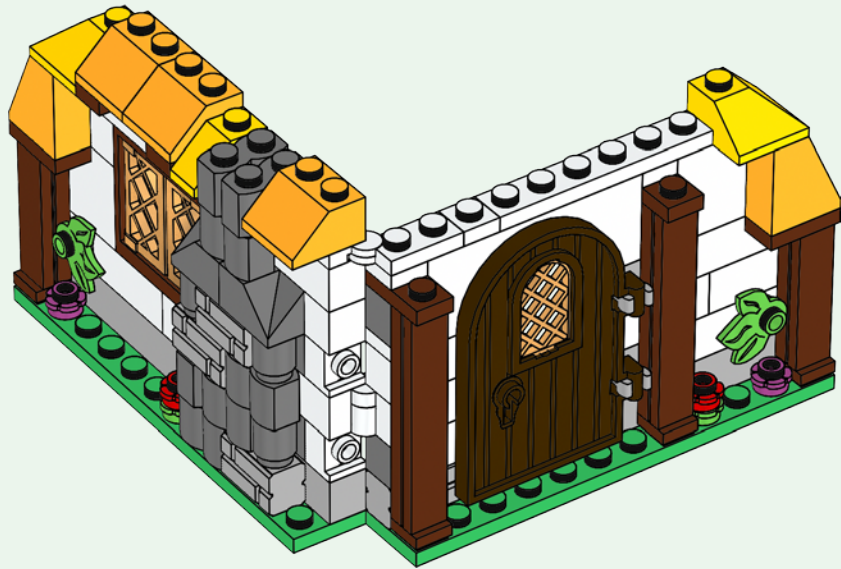

122

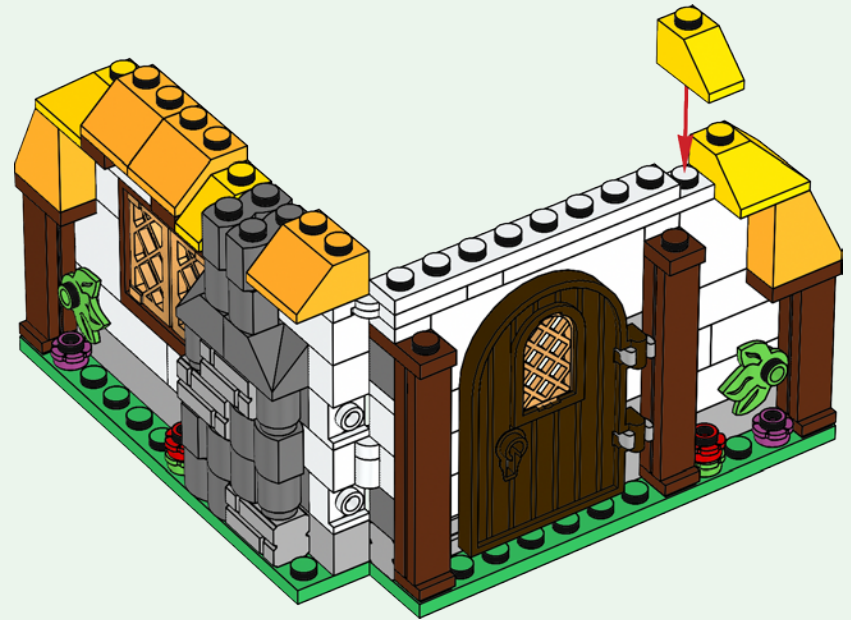



2x



2x

# 123

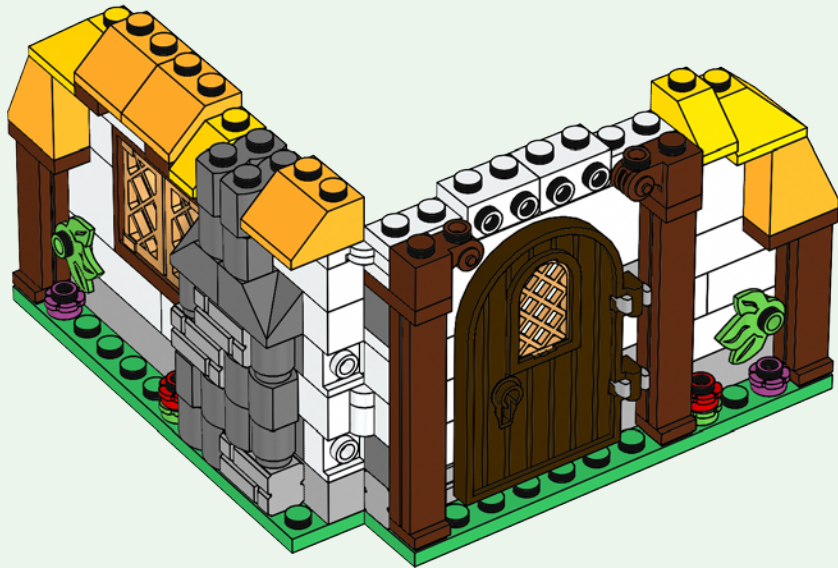

1x



1x

# 124

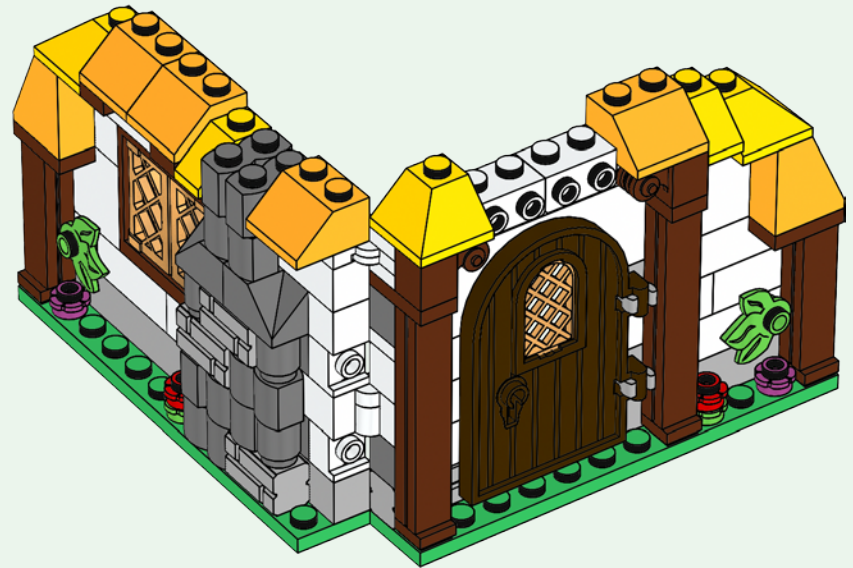

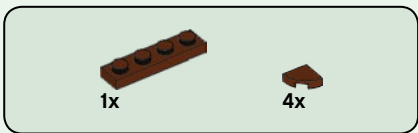

125

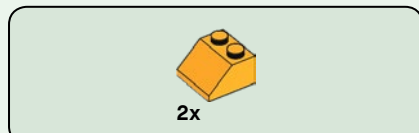
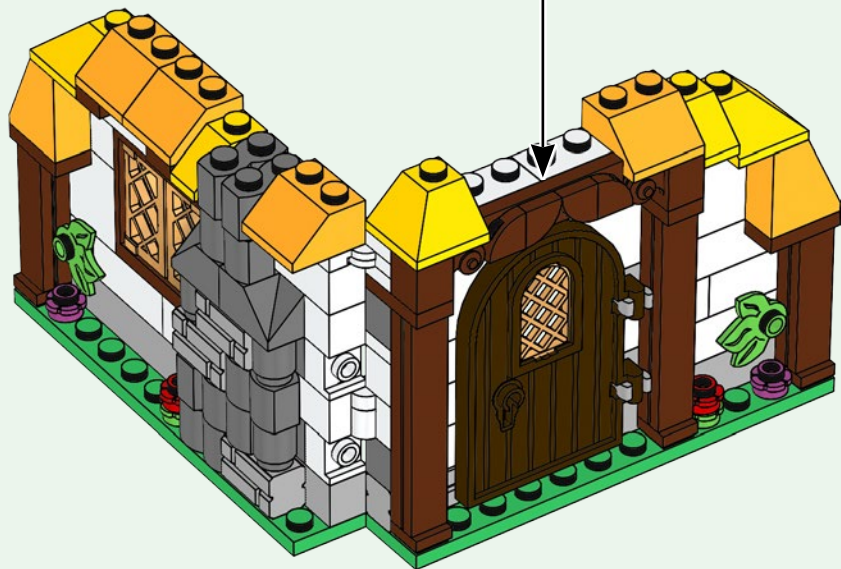
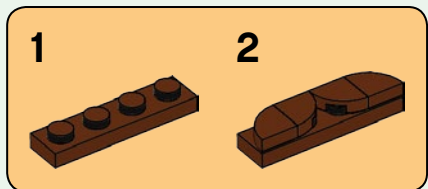

126

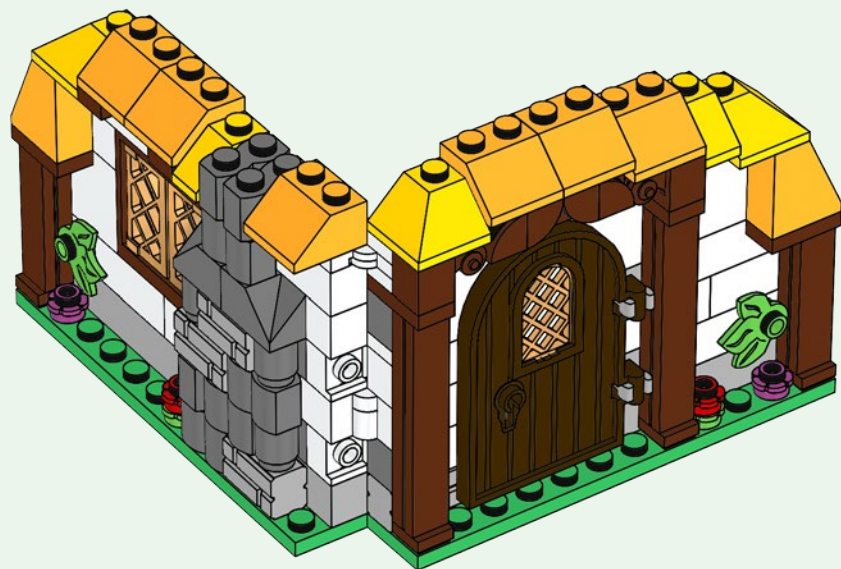



2x



5x

# 127

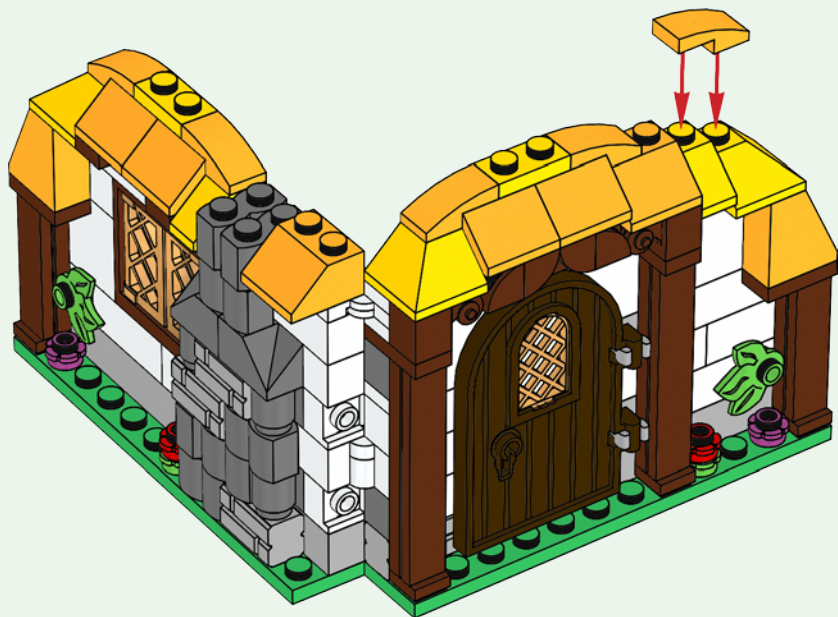

2x



1x

# 128

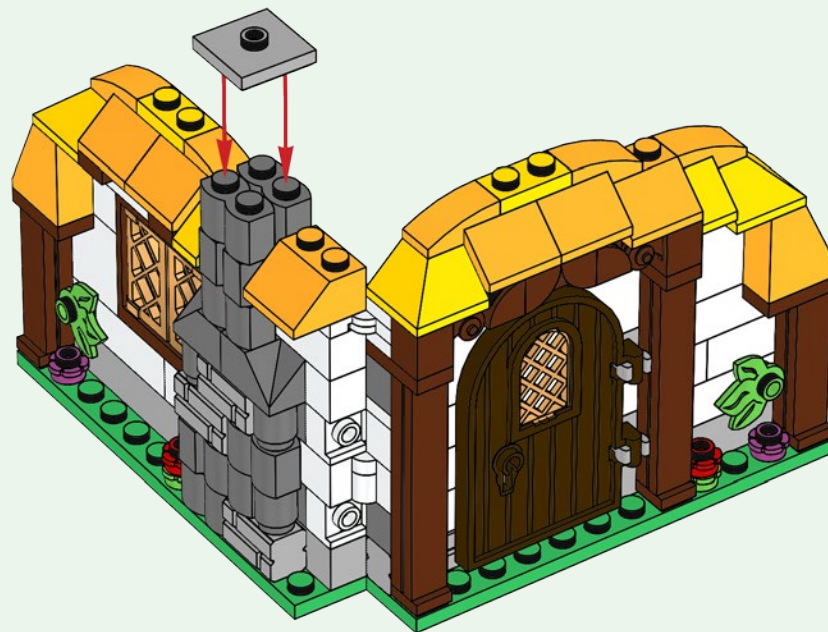

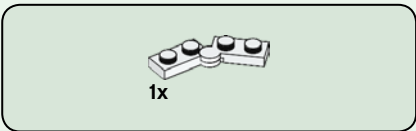

129

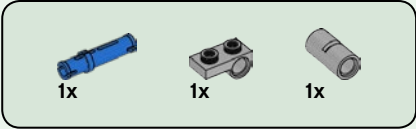
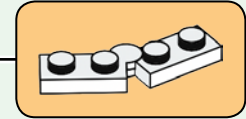
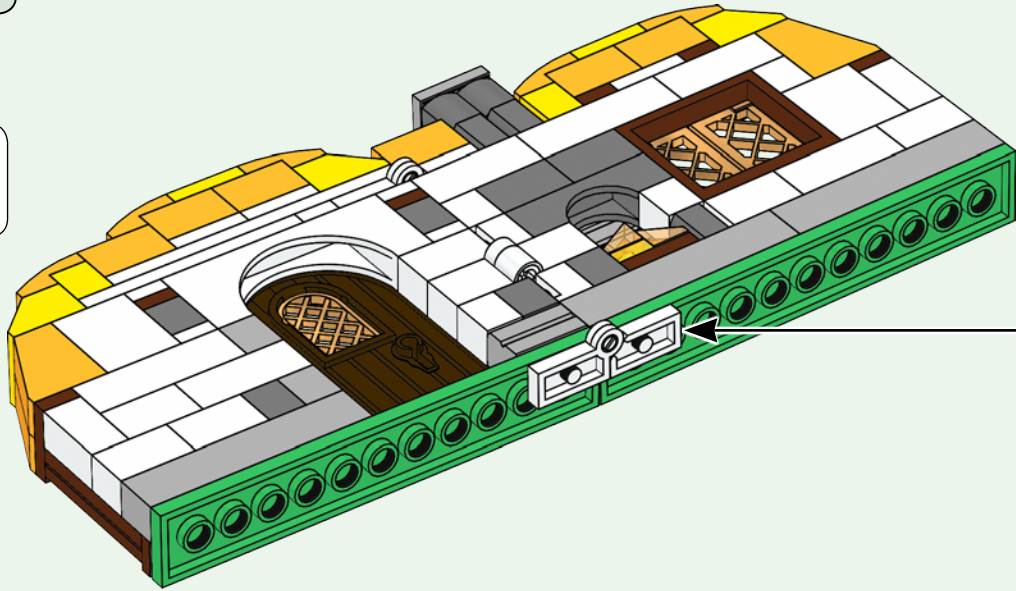
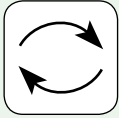

130

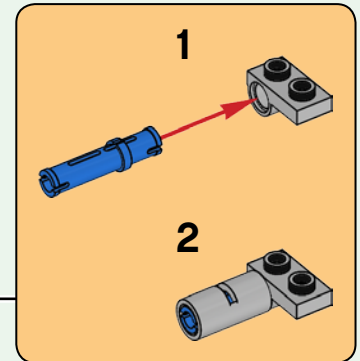
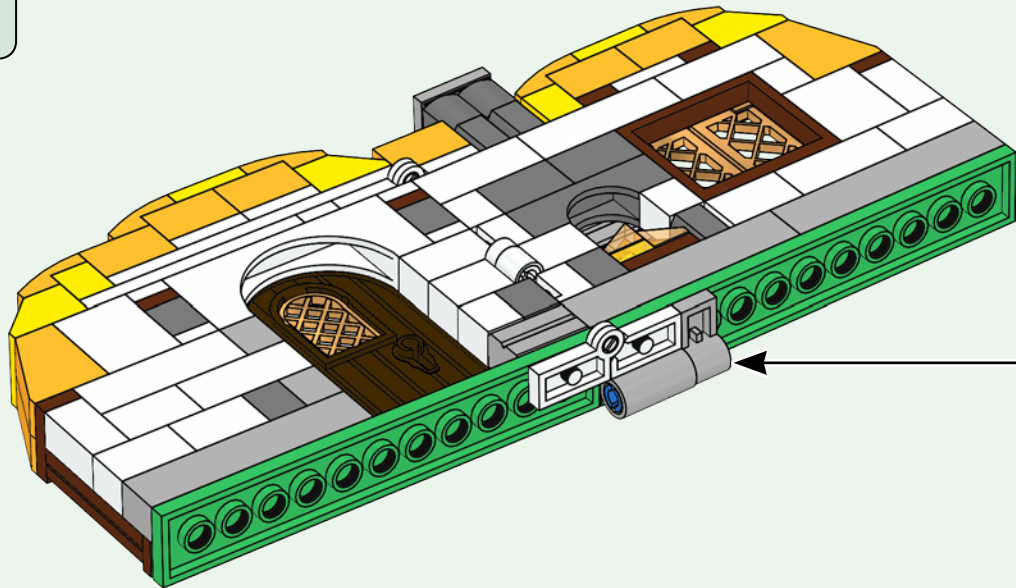

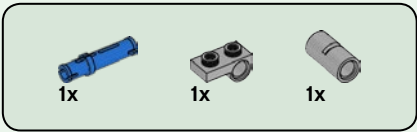

# 131

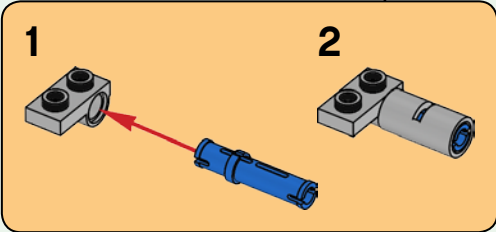
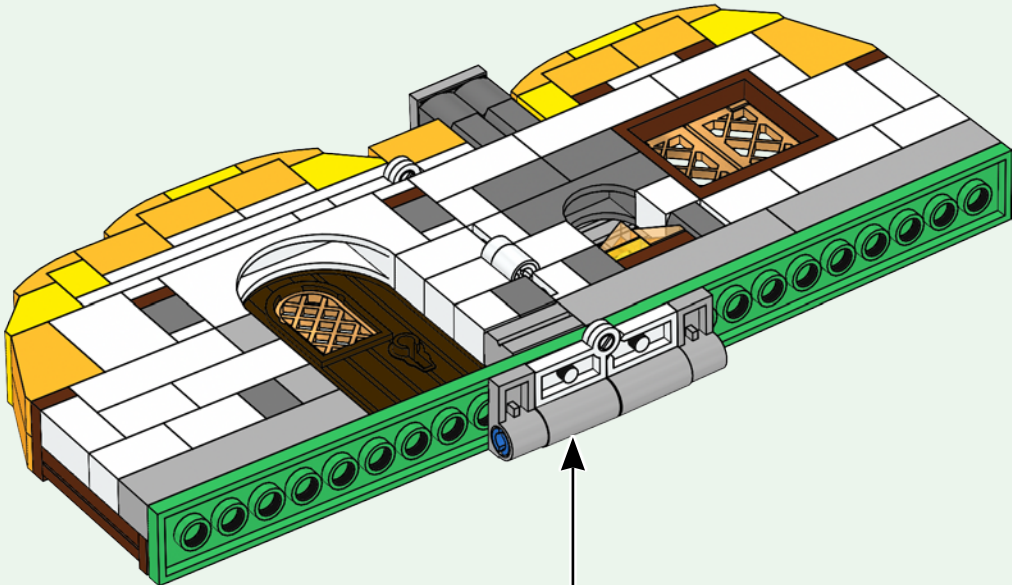



10x

132

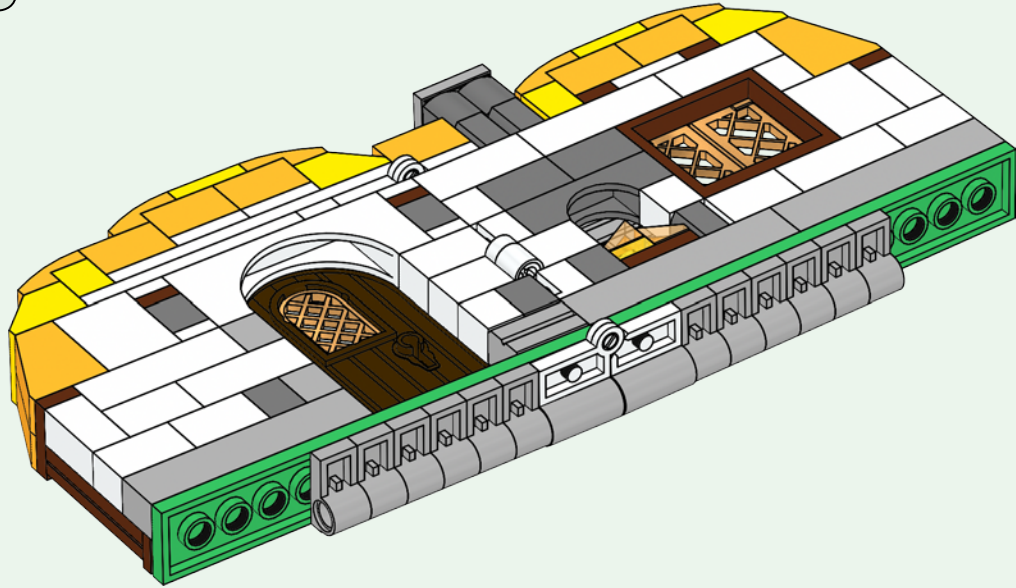

2x

133

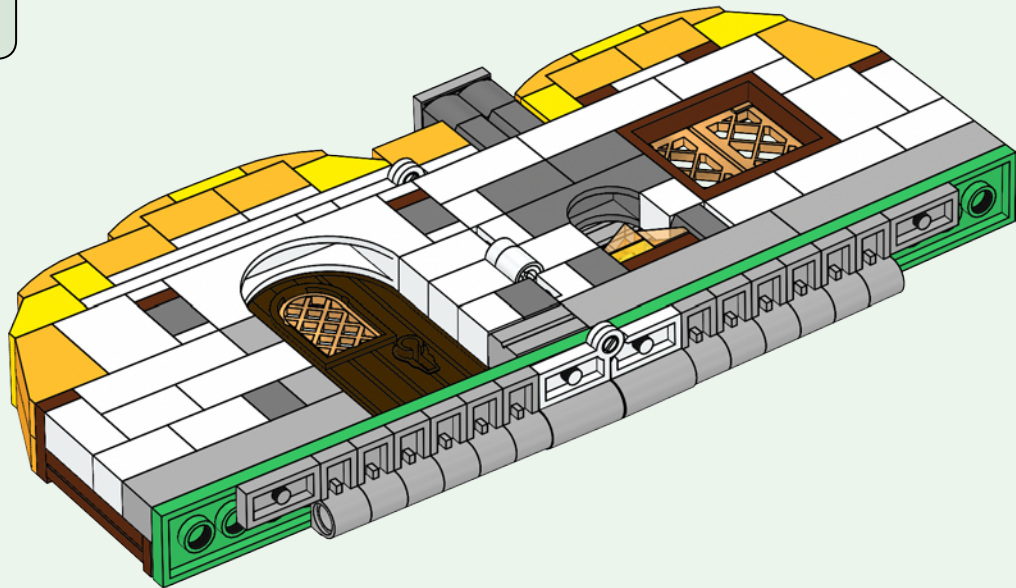

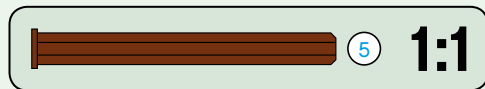
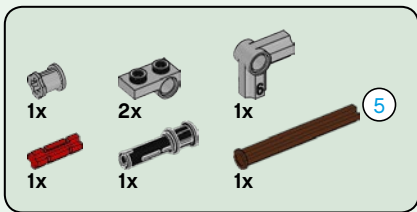

134

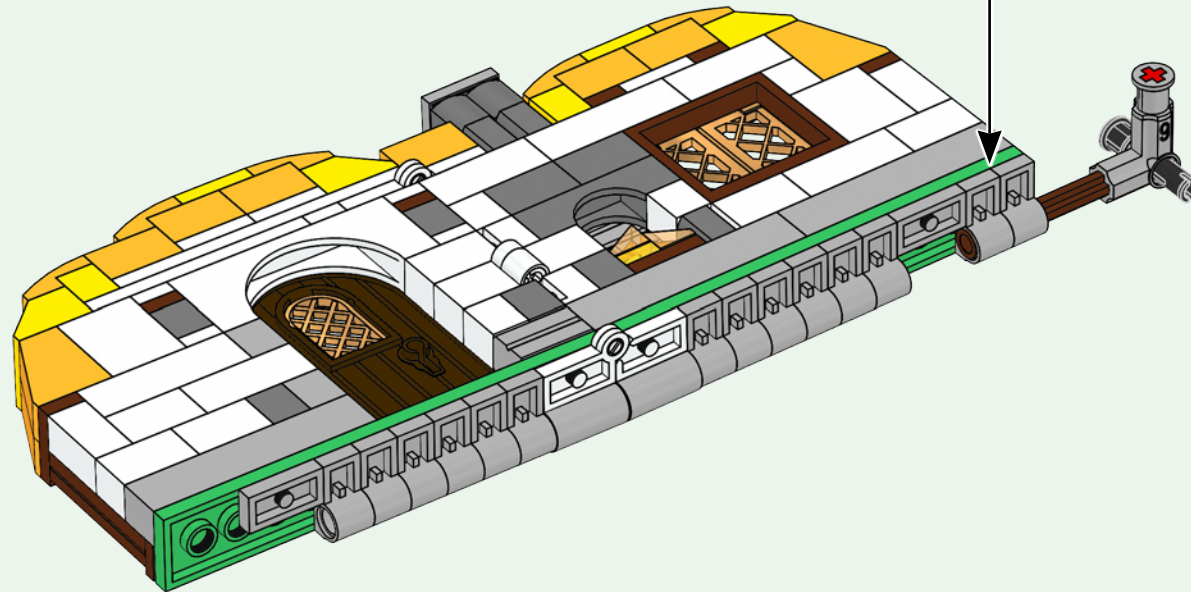
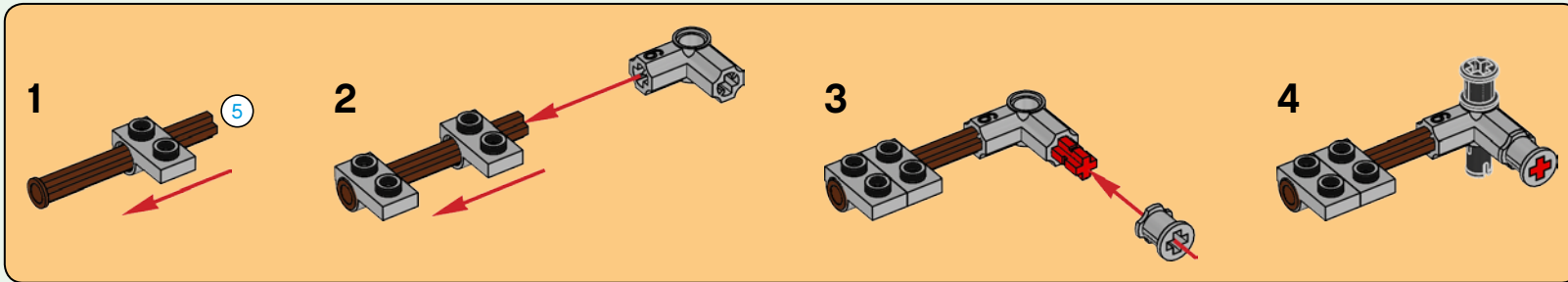



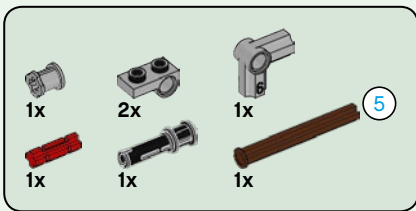

# 135

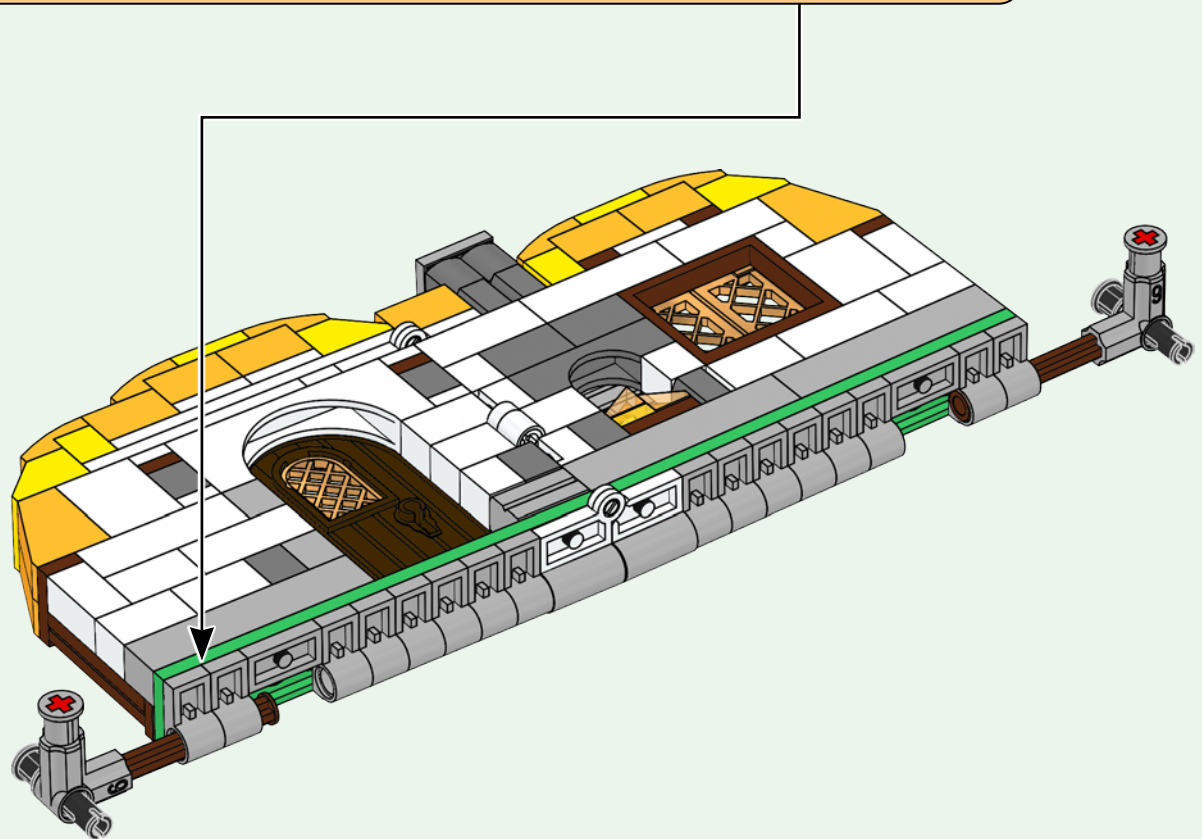
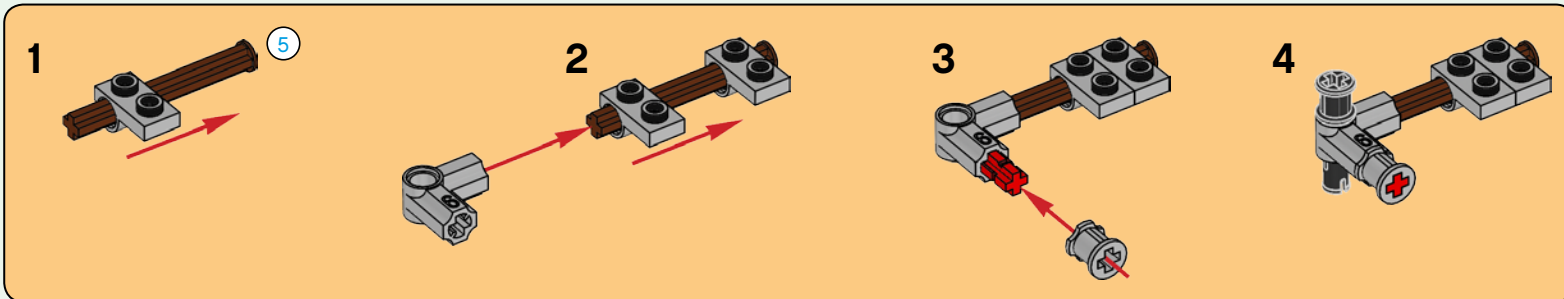

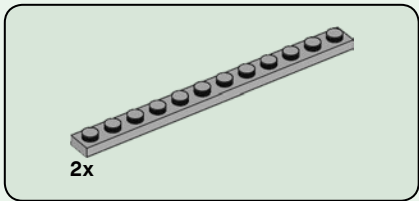

136

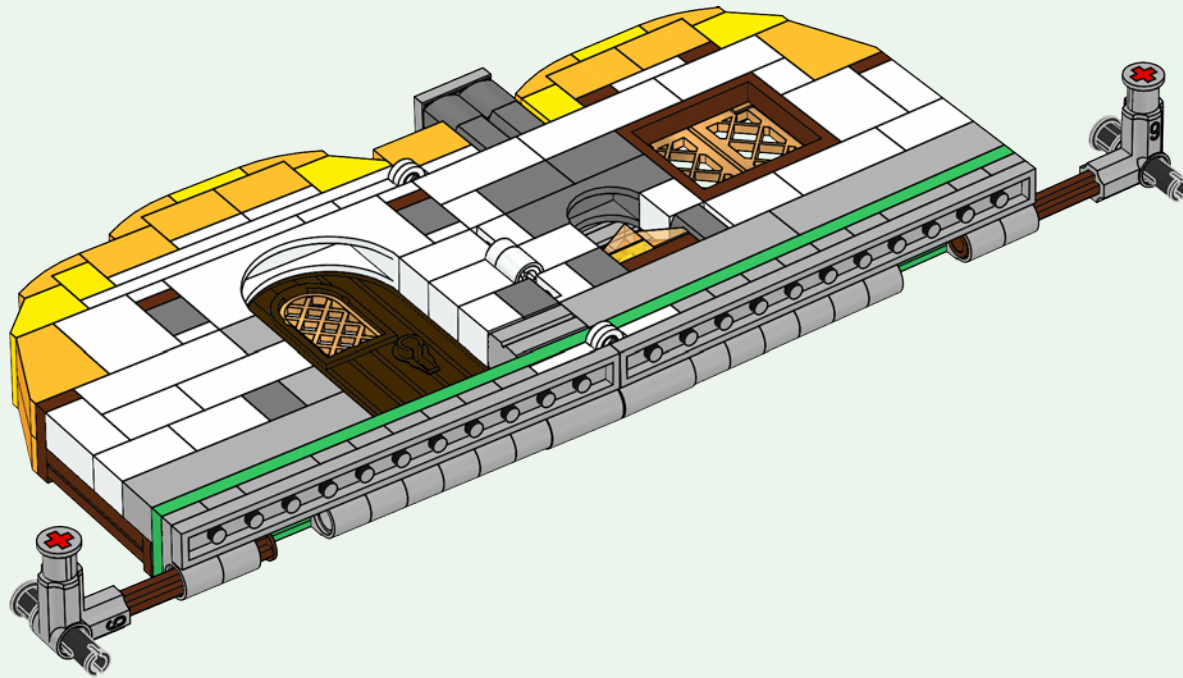

137

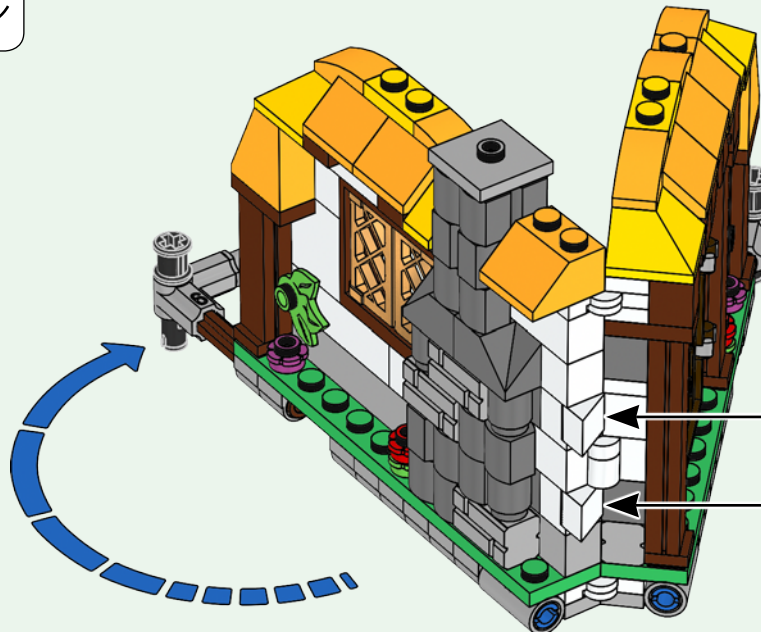
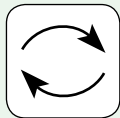

138

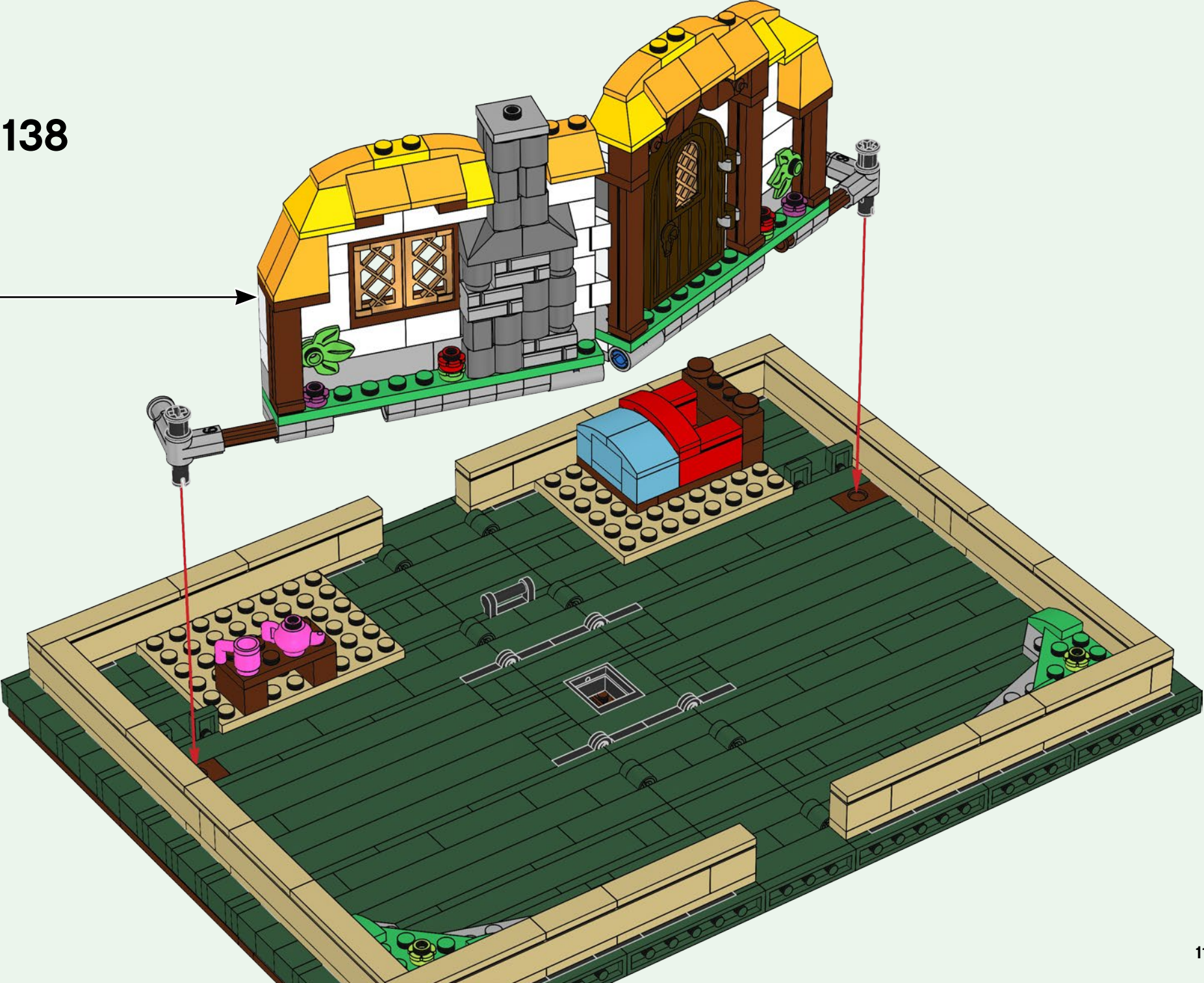



140

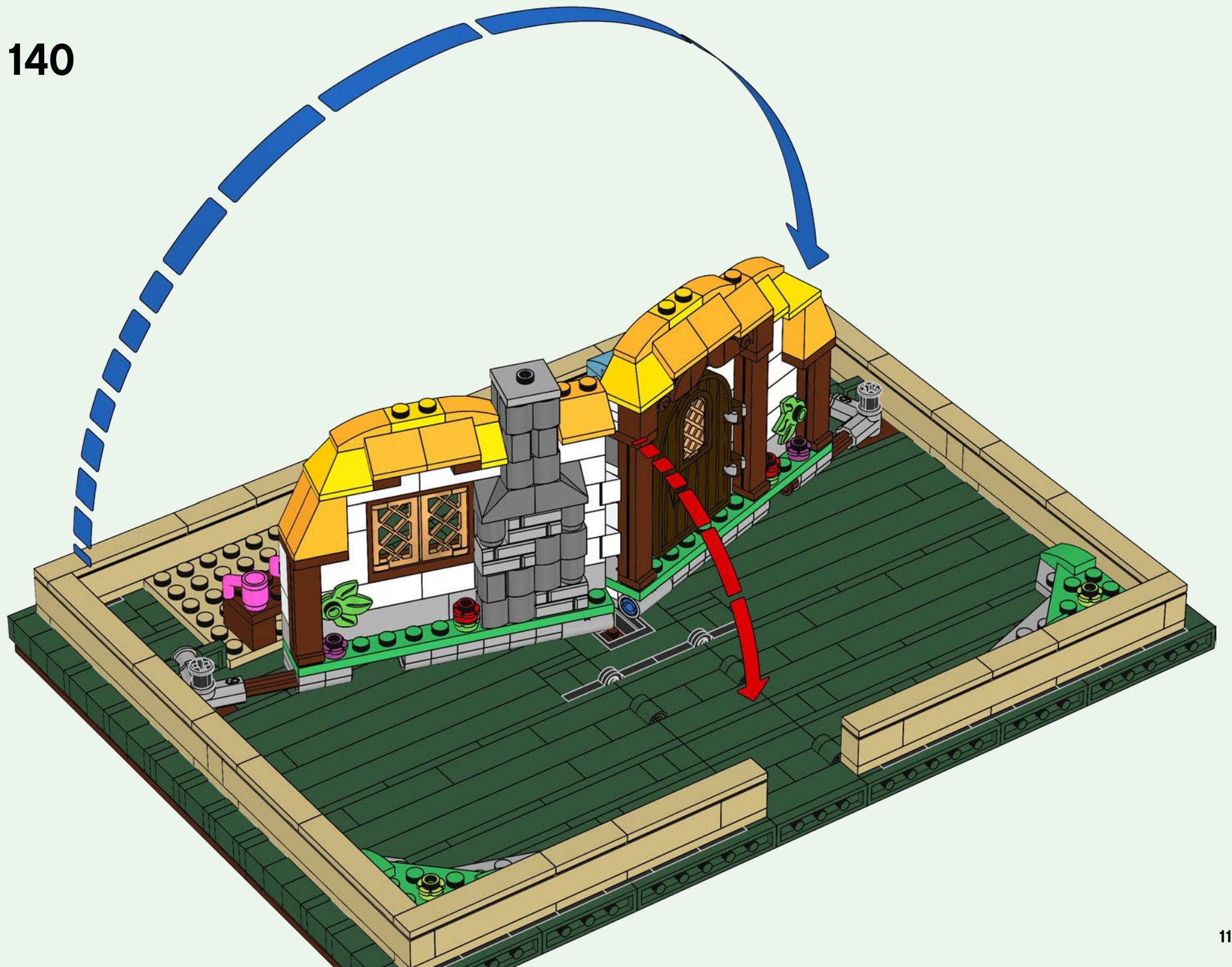

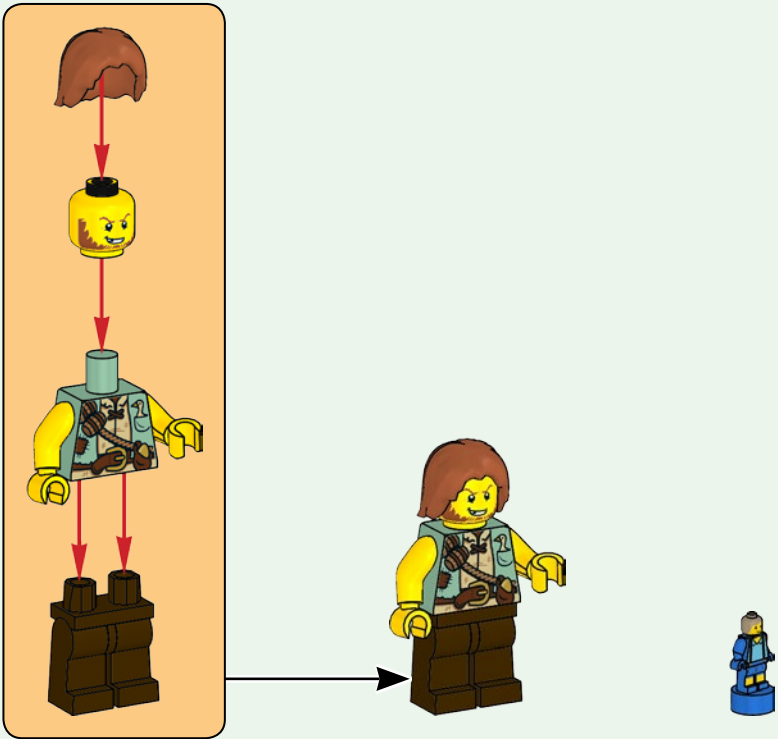
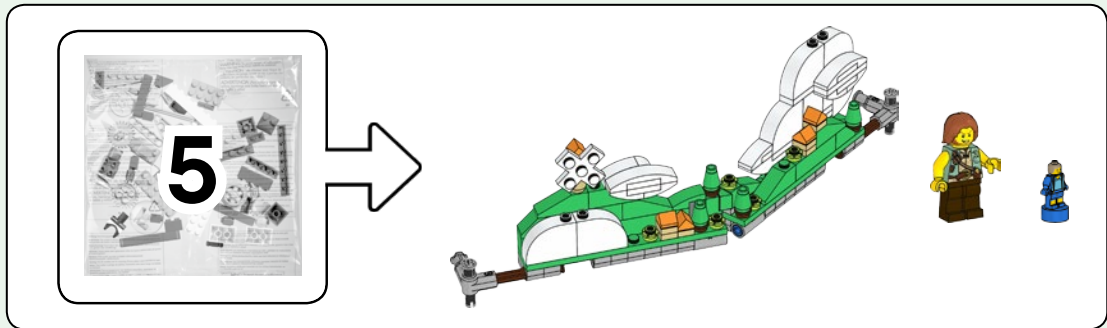

141



142

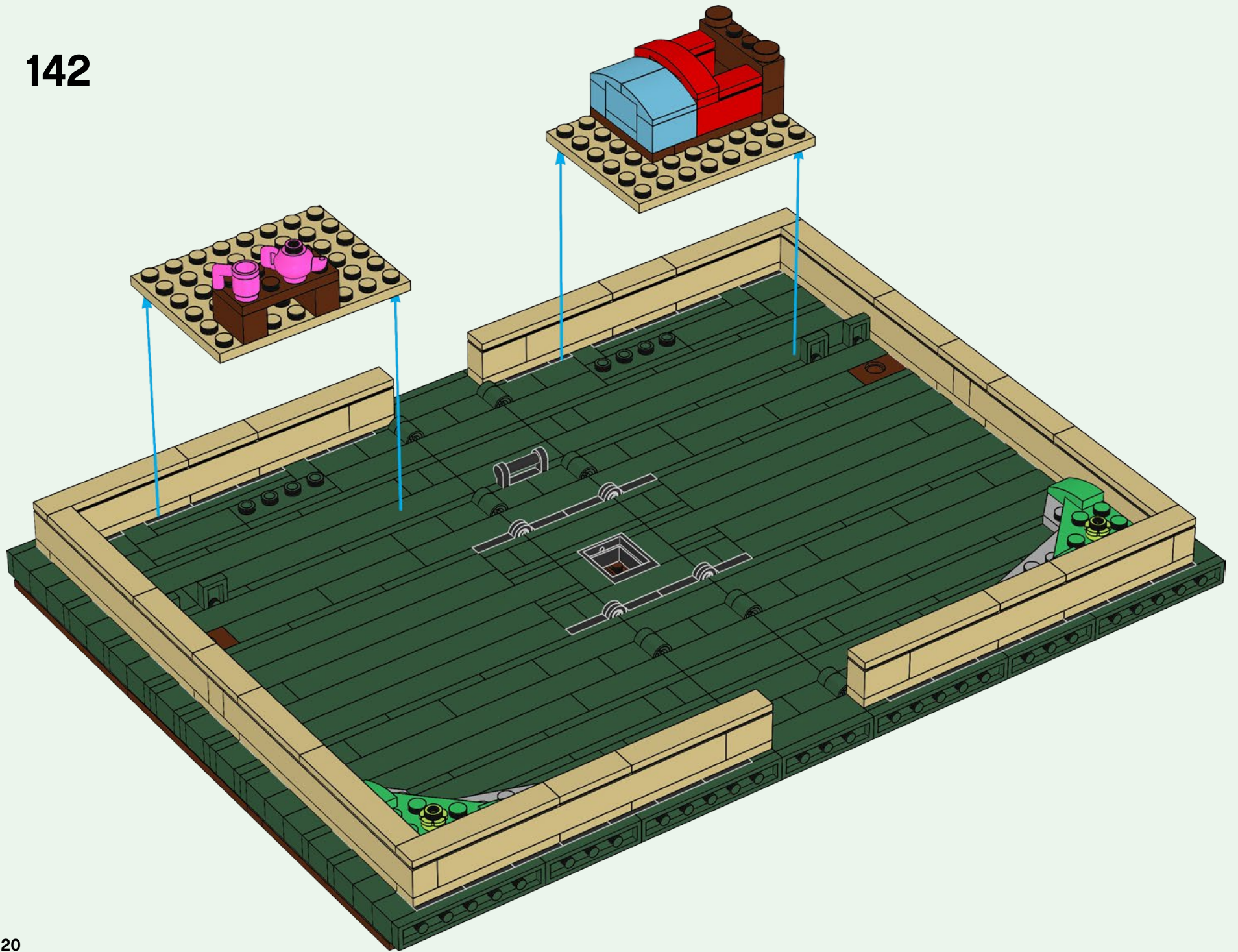



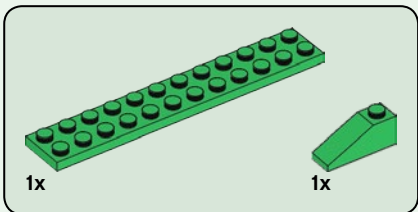
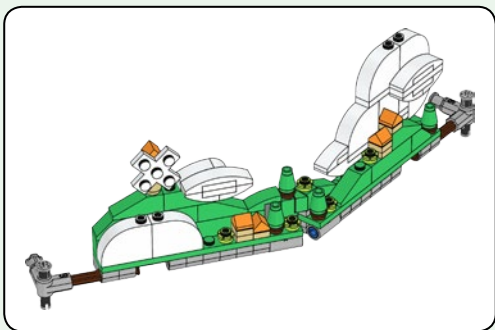

143

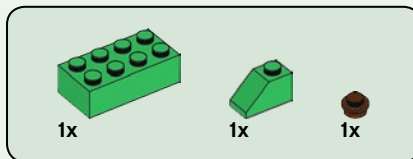
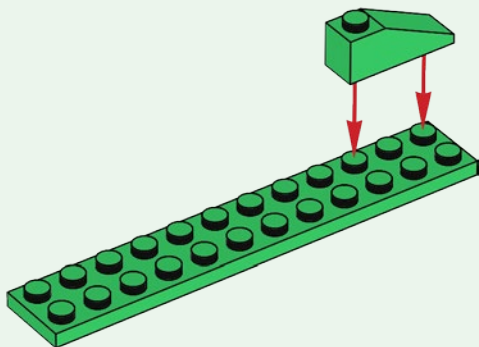

144

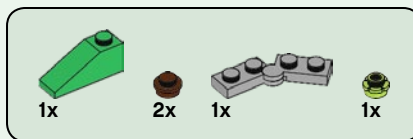
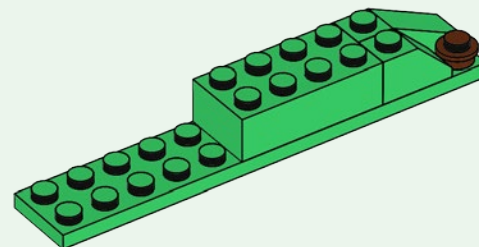

145

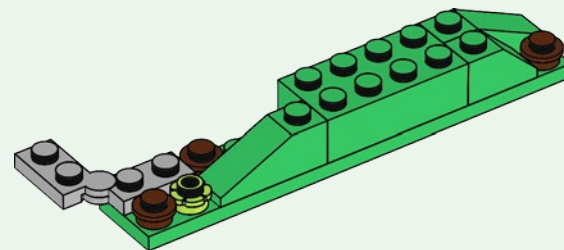

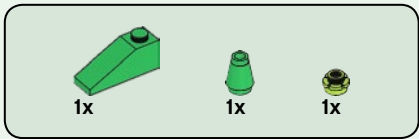

146

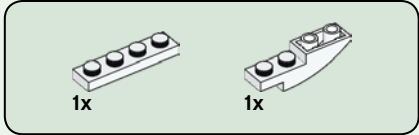
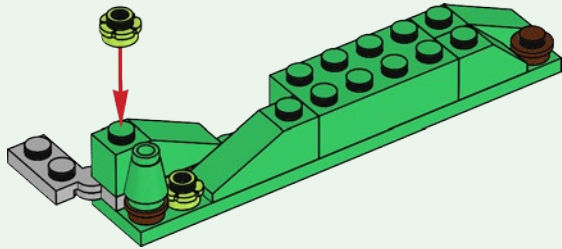

147

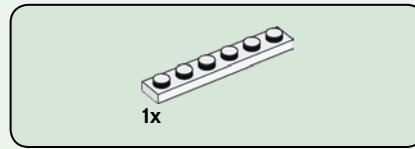
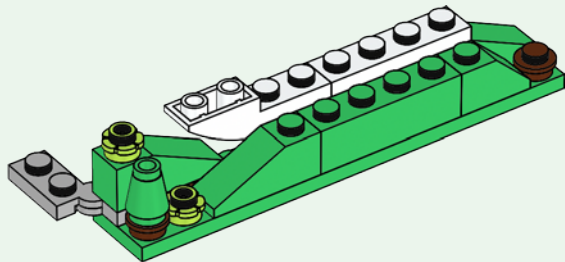

148

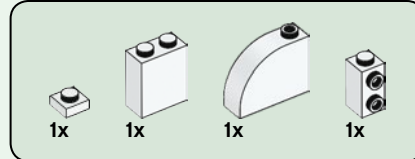
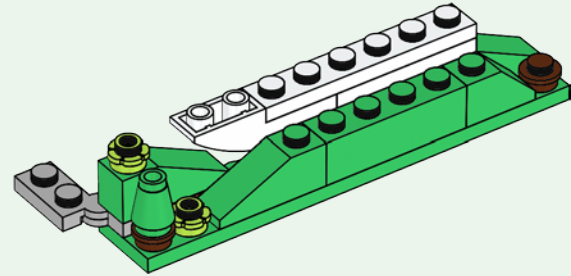

149

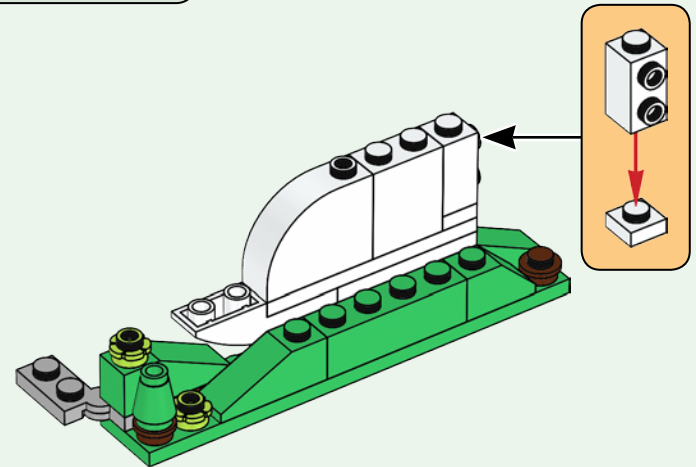

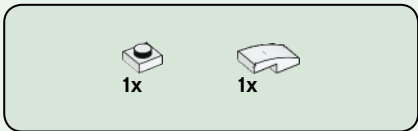

150

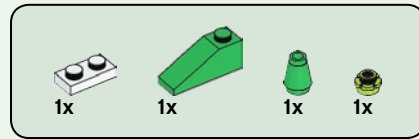
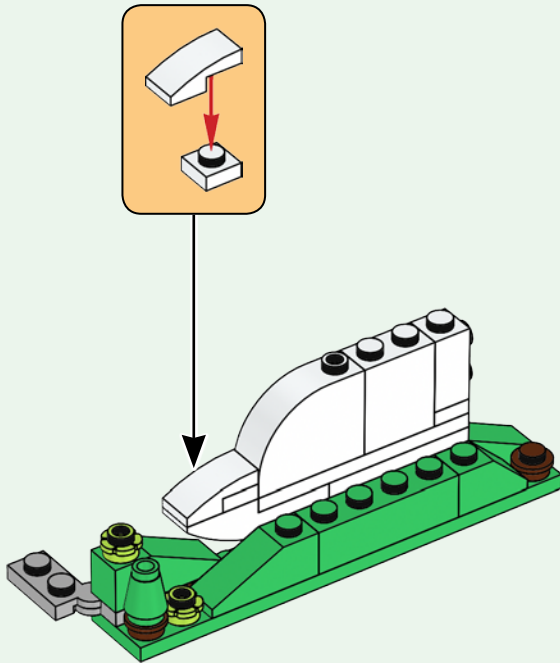

151

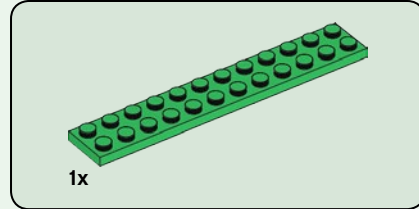
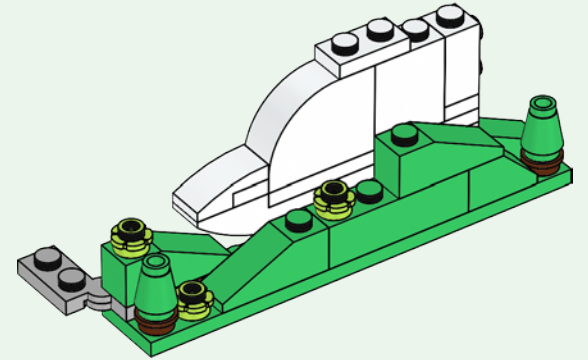

152

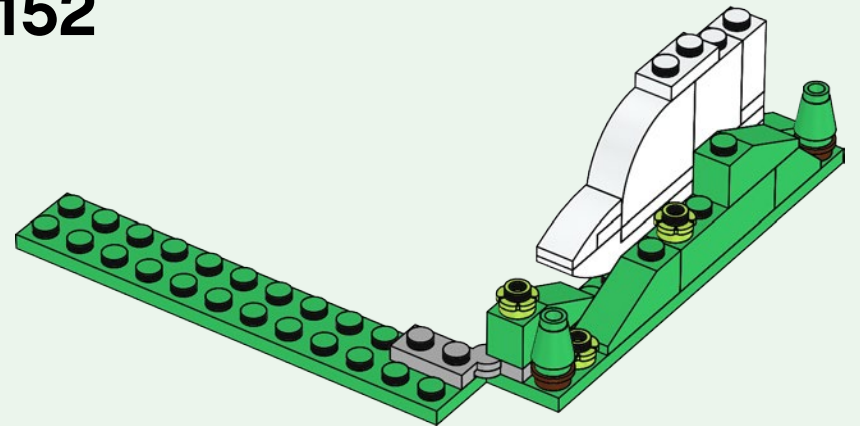

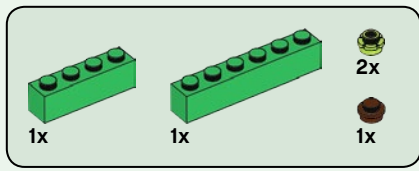

153

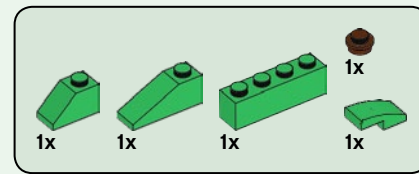
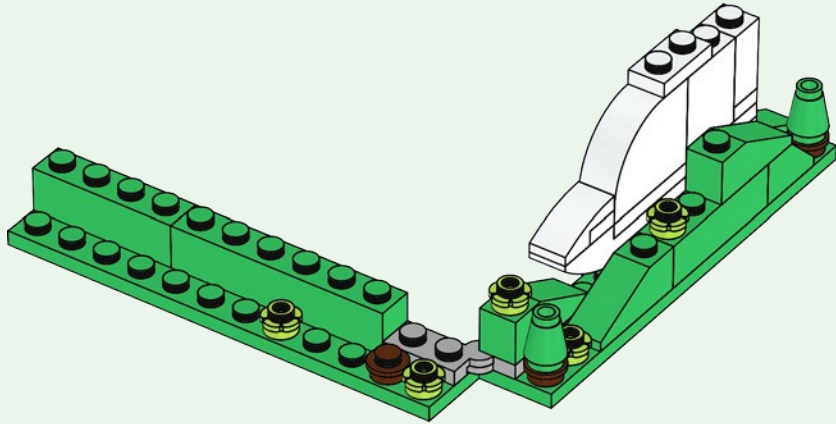

155

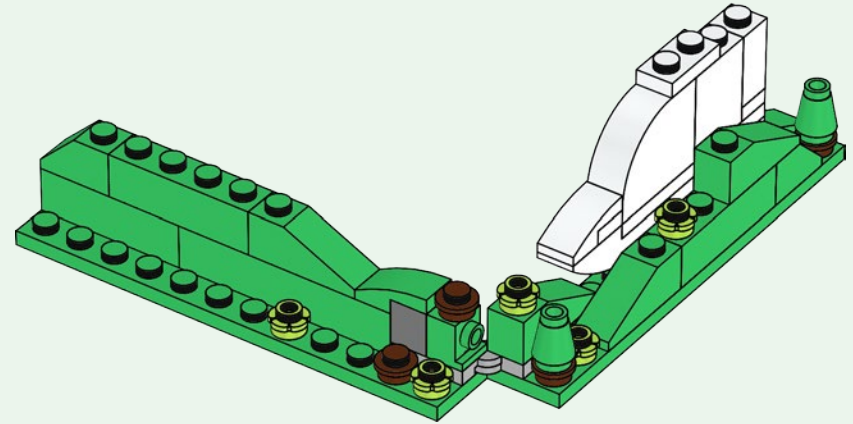

154

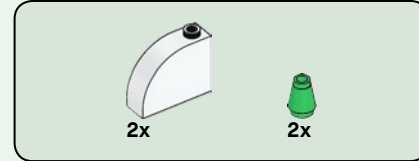
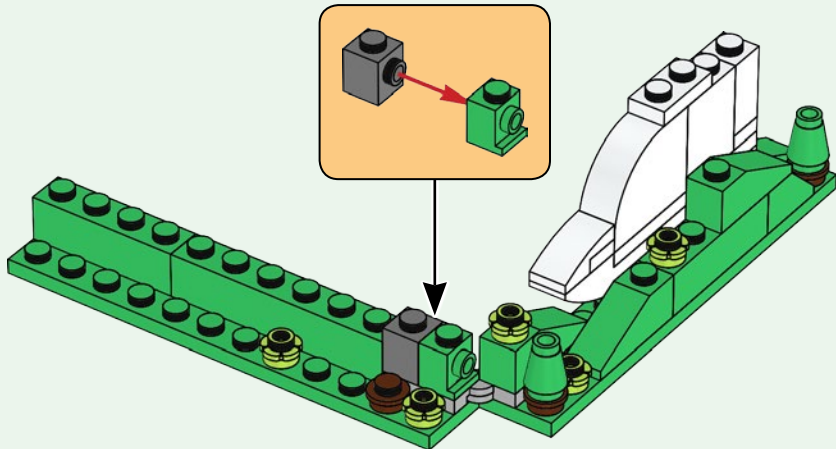

156

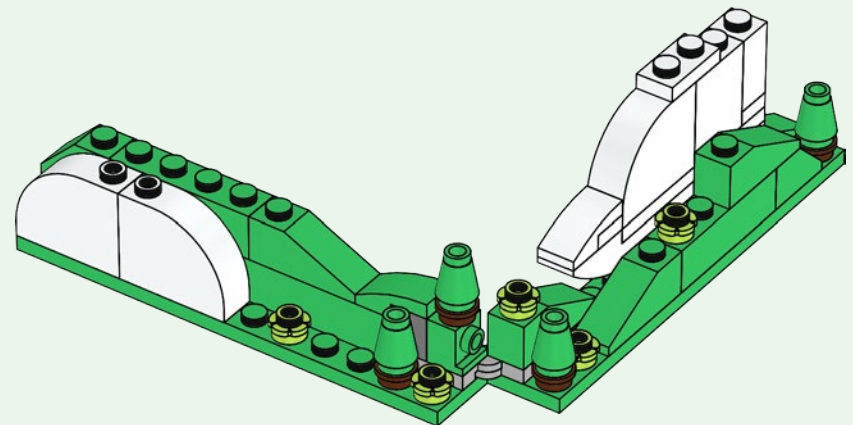

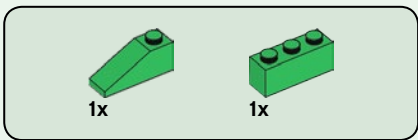

157

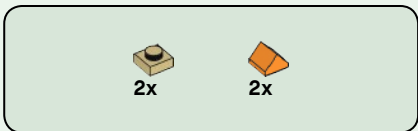
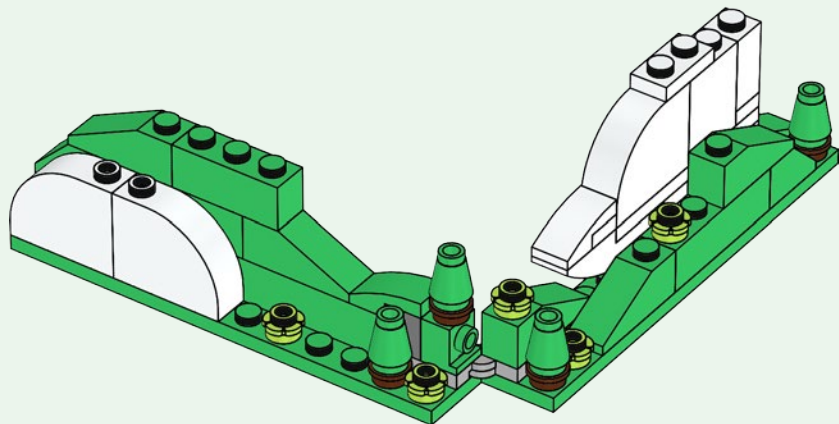

158

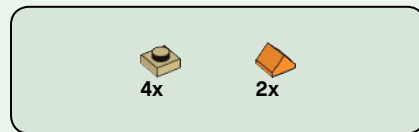
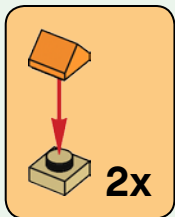
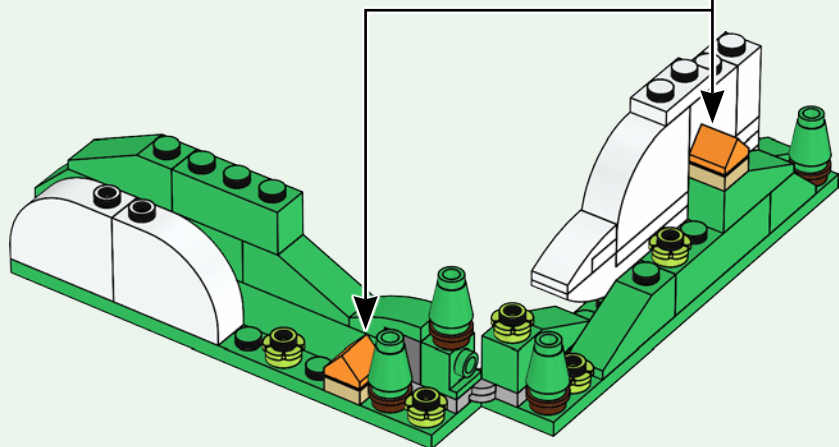

159

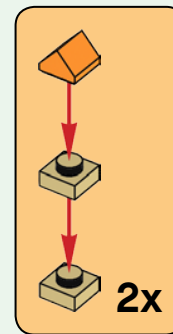
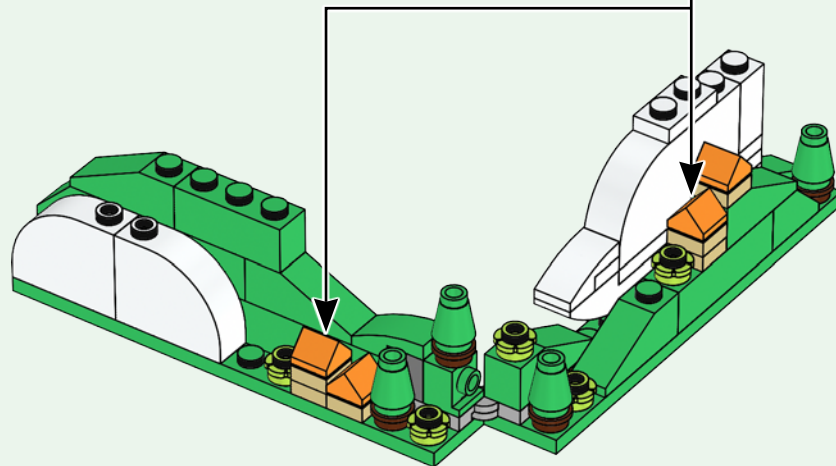

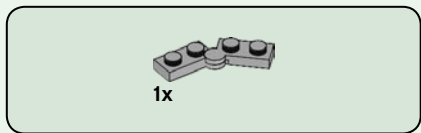

160

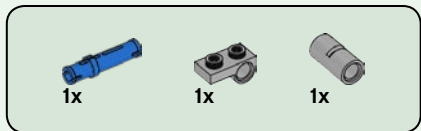
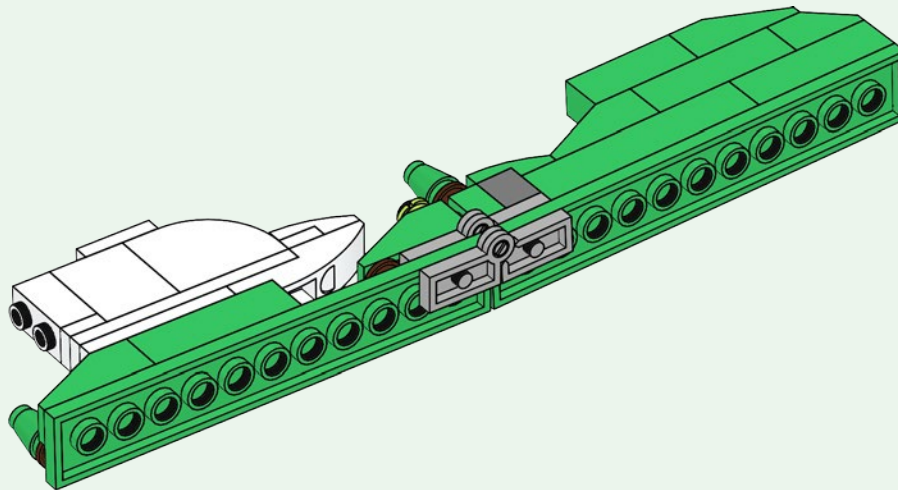
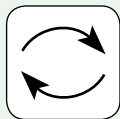

161

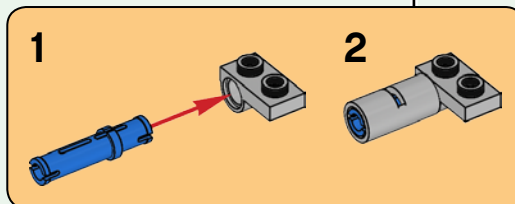
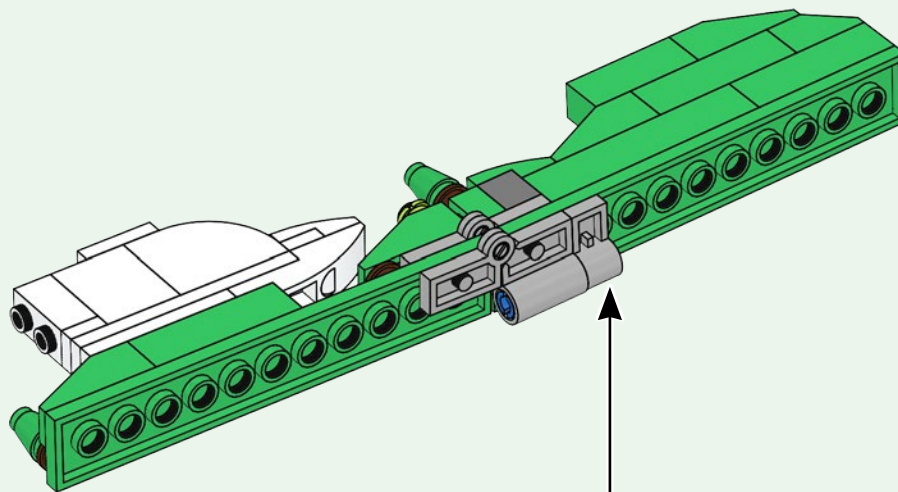

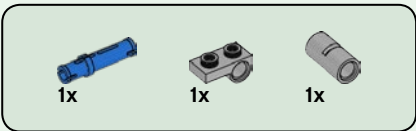

# 162

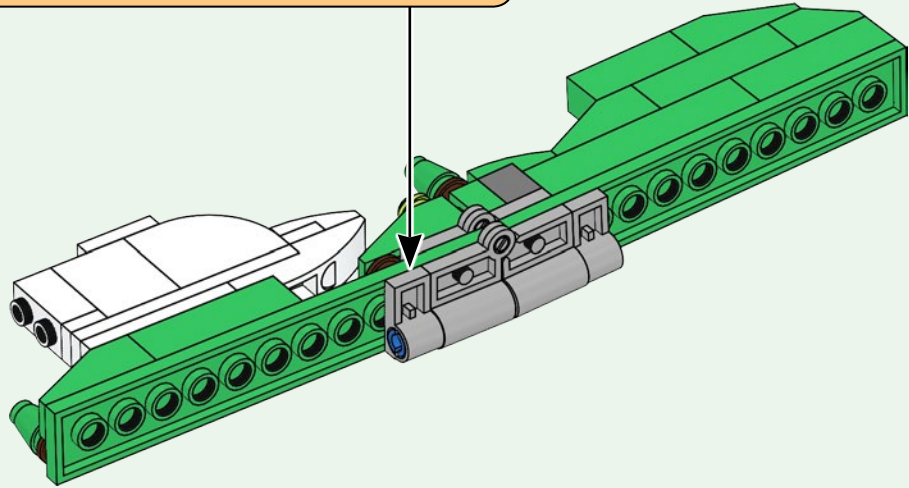
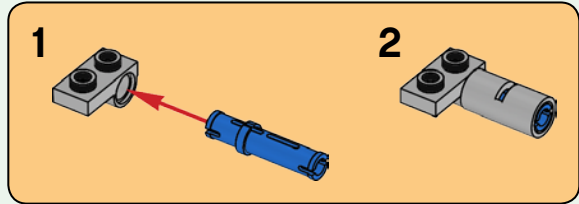



10x

163

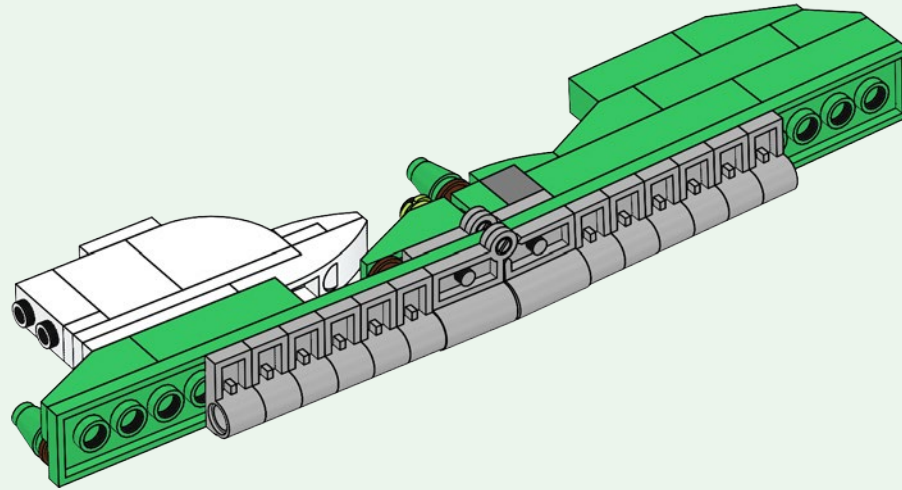

2x

164

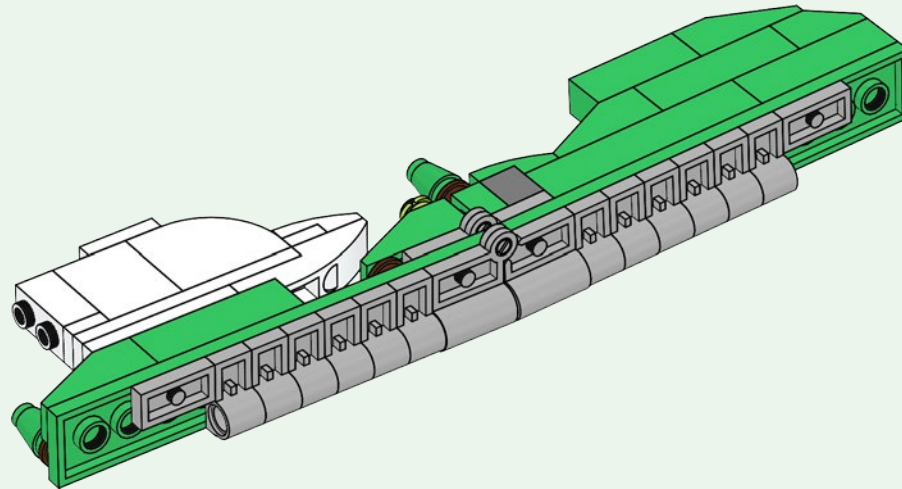



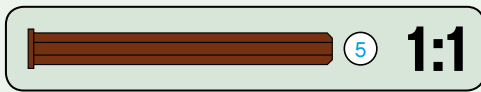
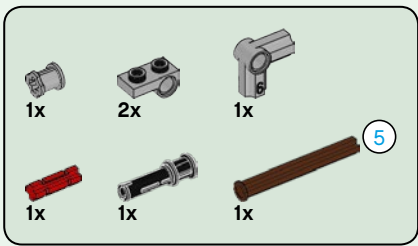

# 165

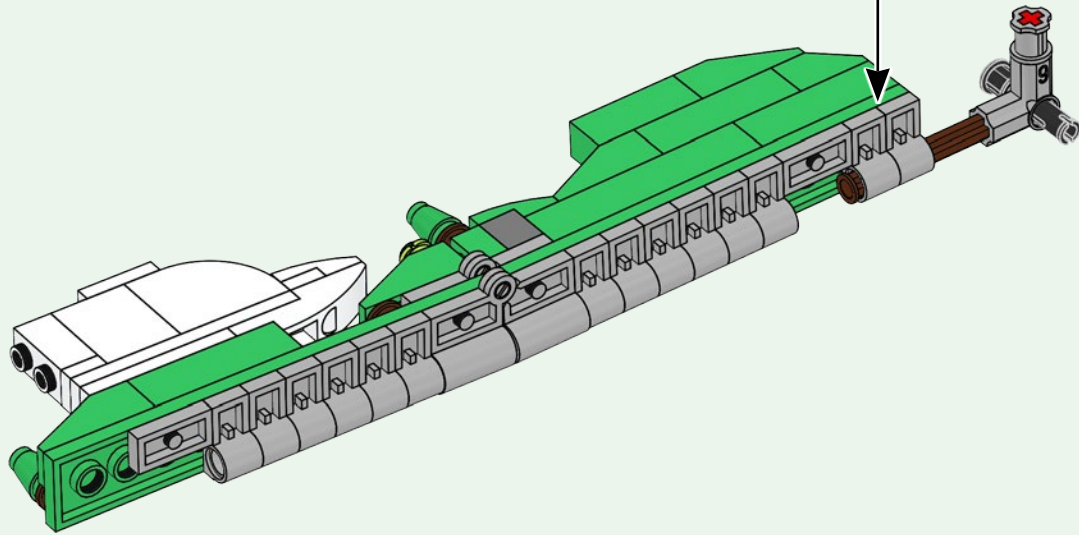
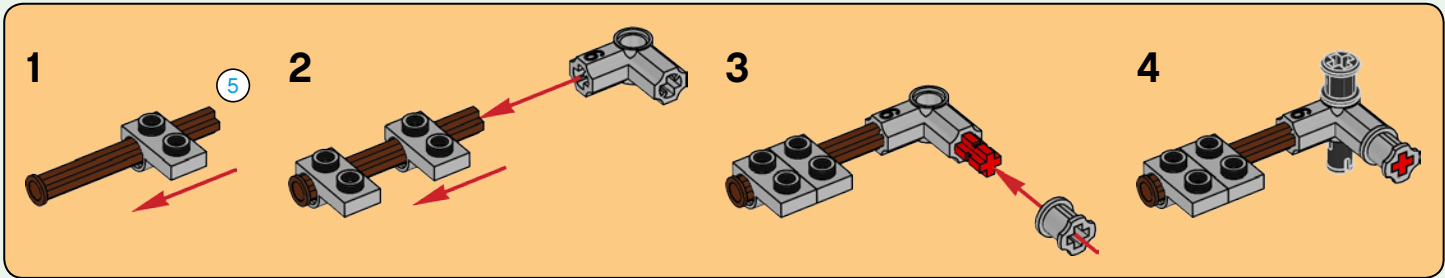

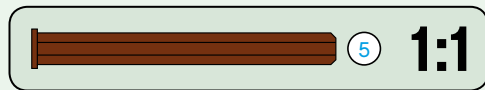
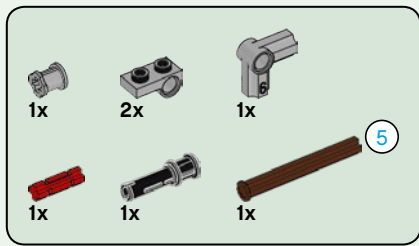

# 166

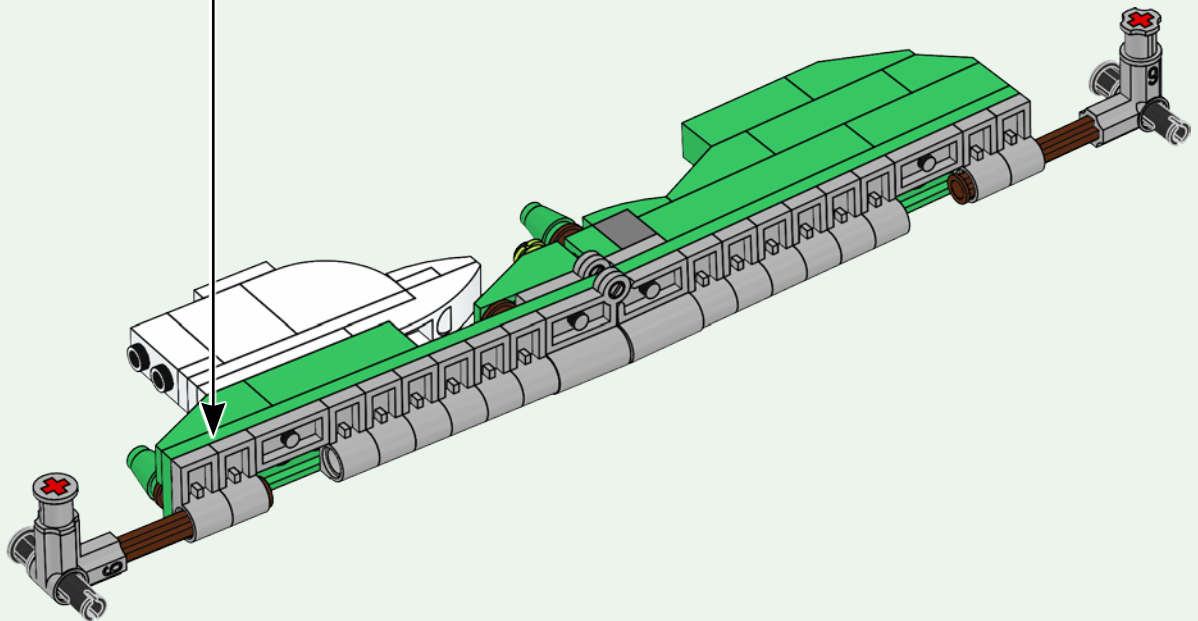
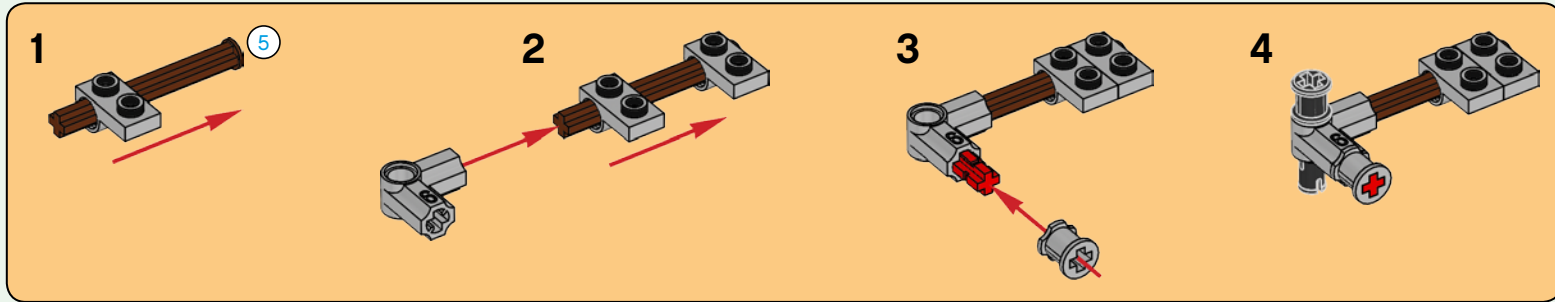

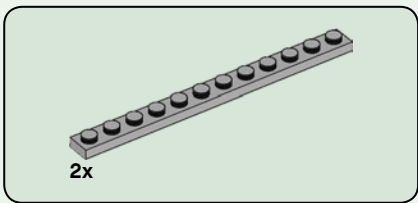

167

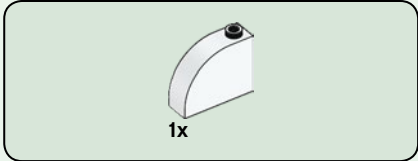
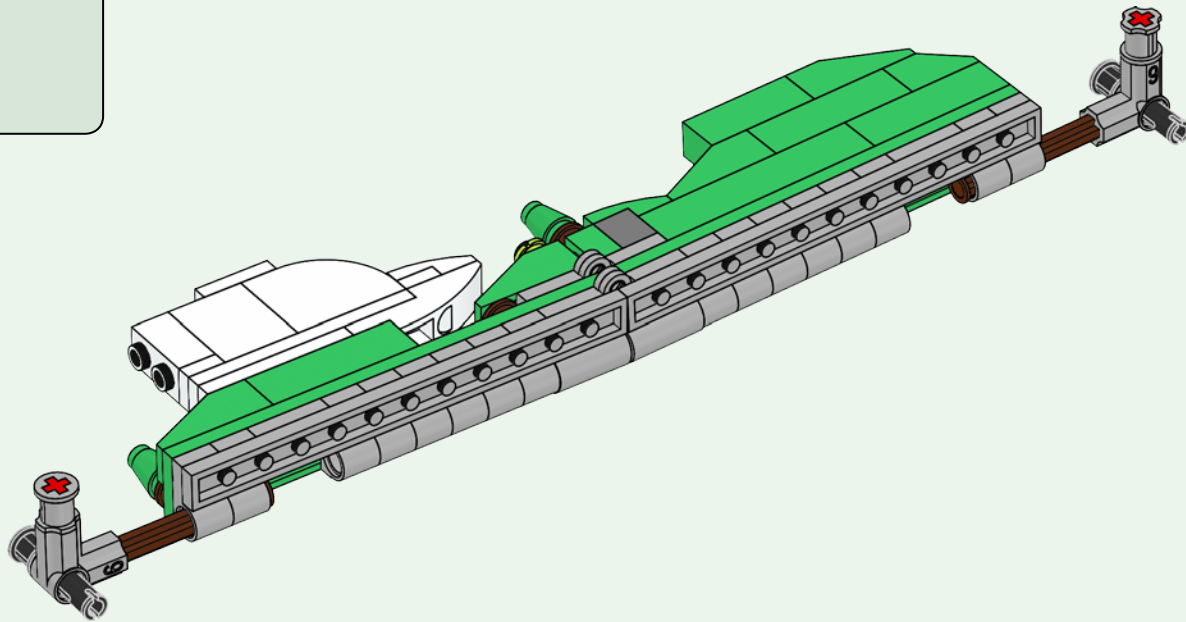

168

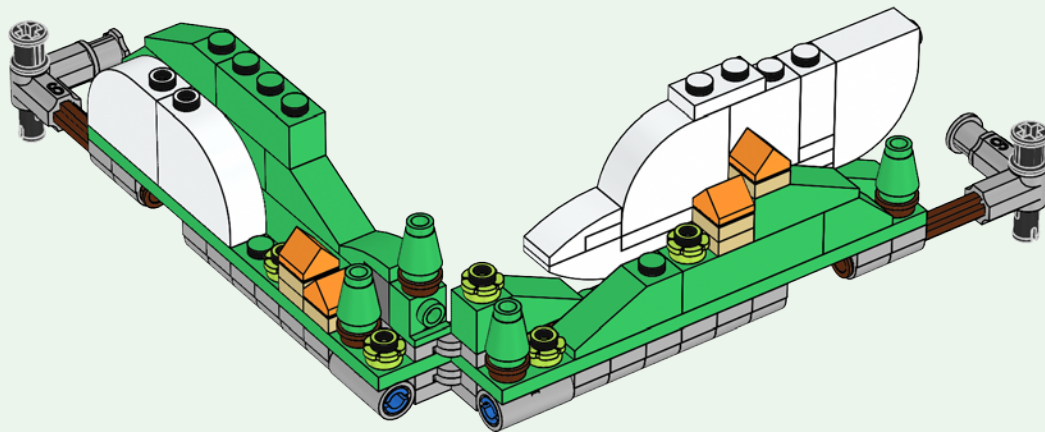
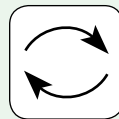

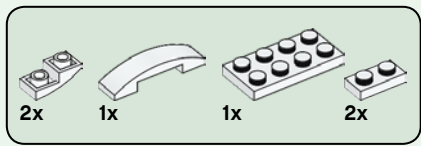

169

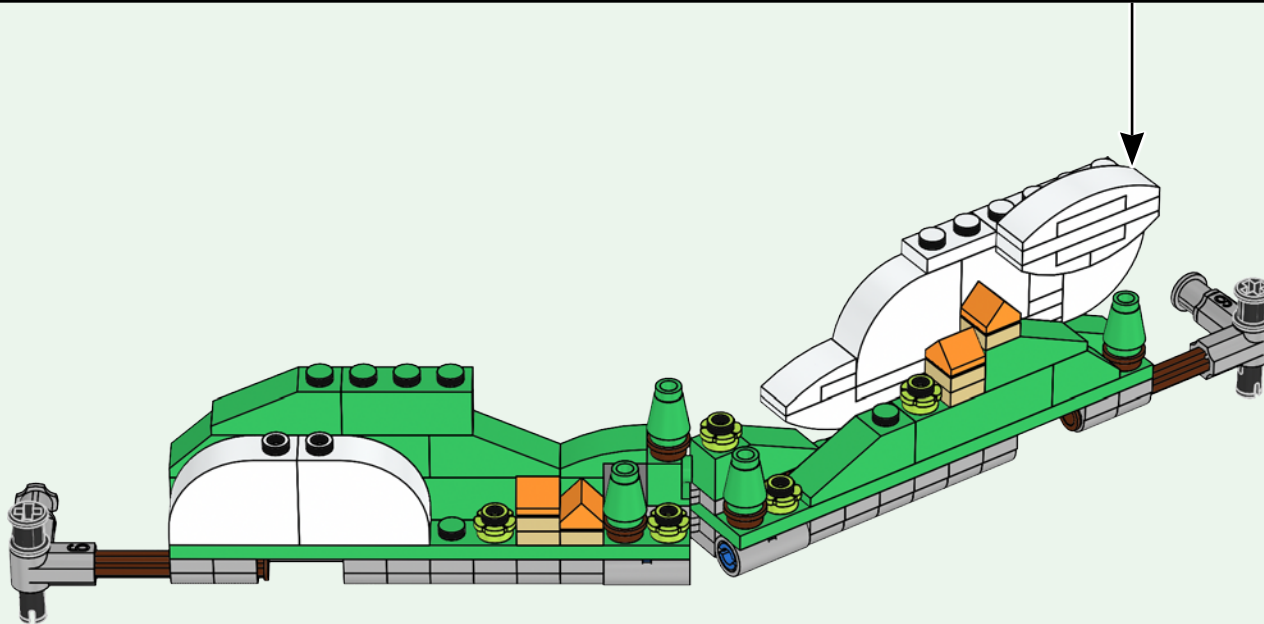
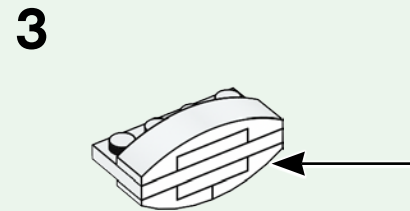
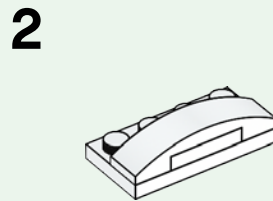
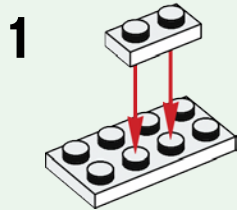

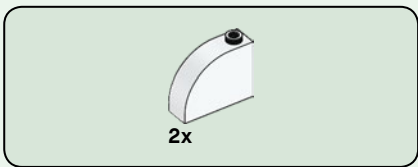

170

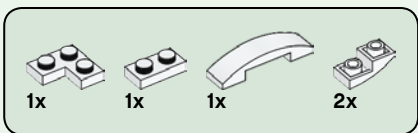
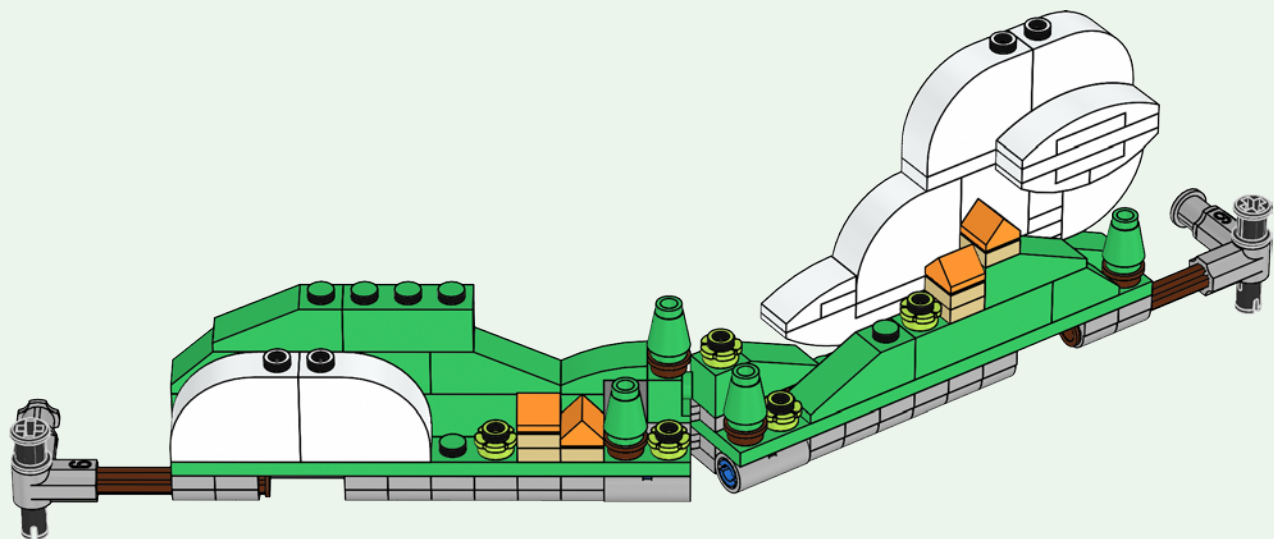

171

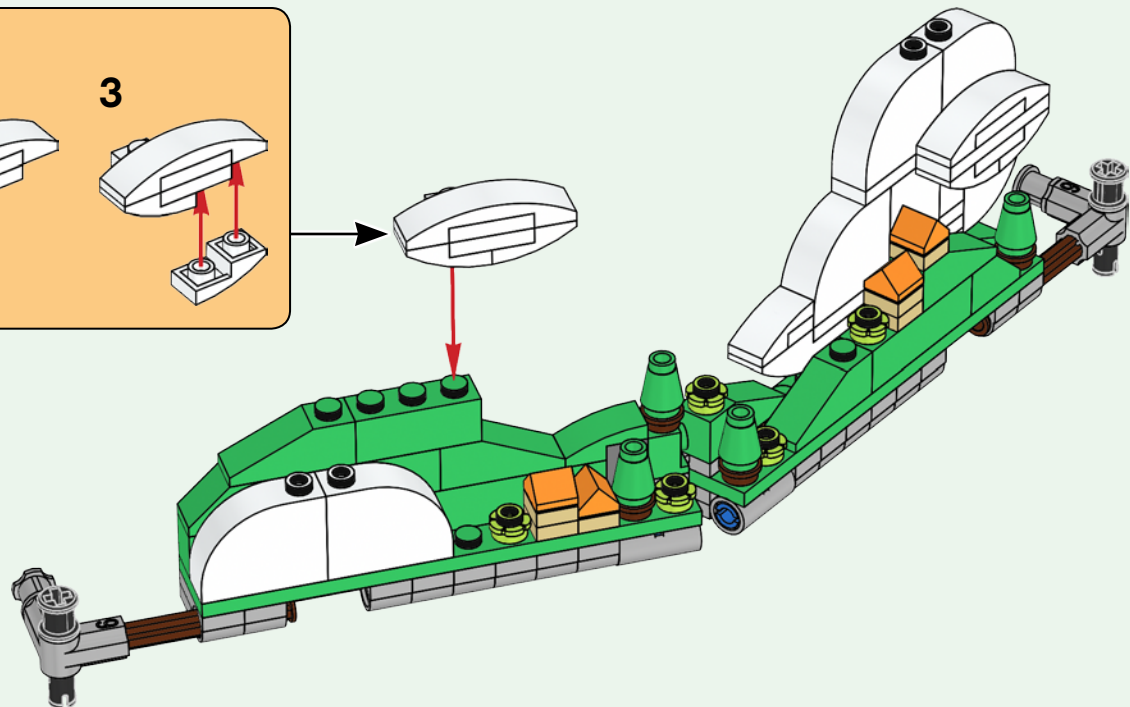
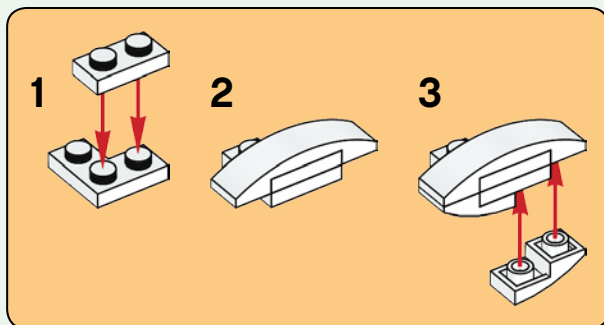

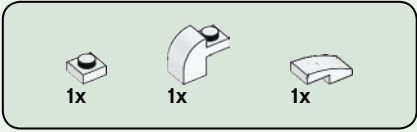

172

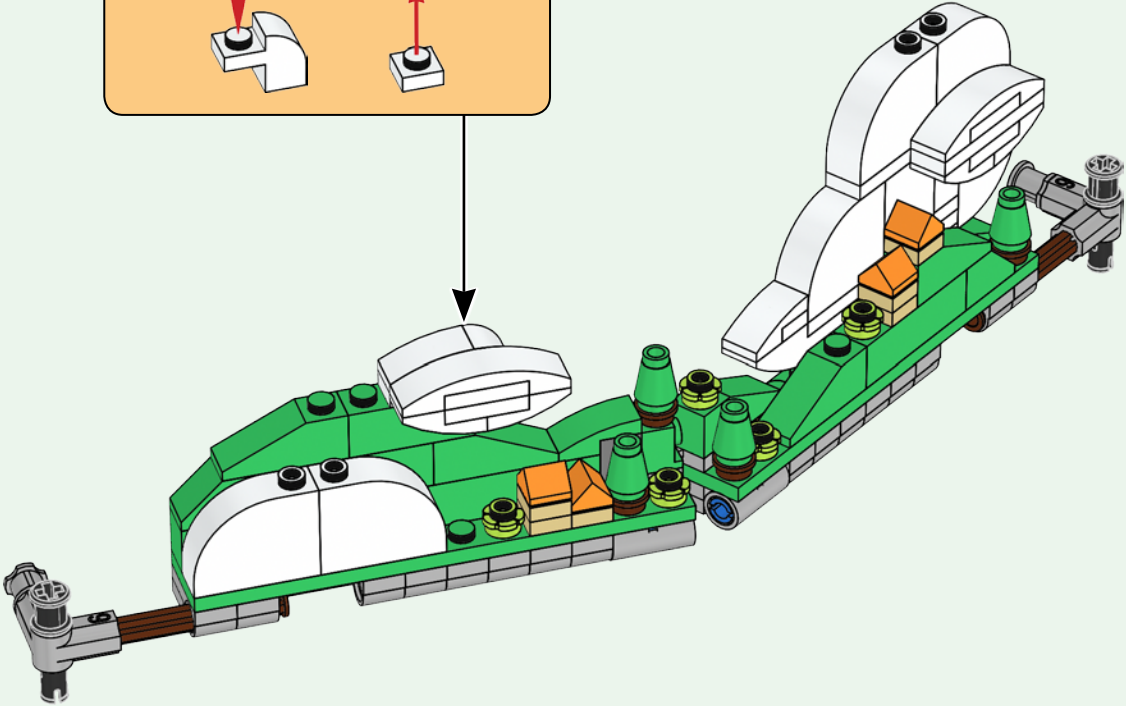
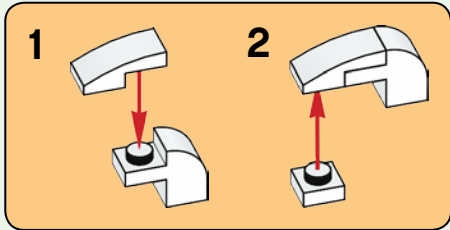

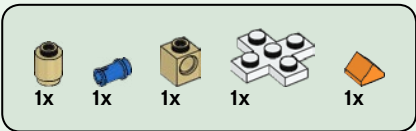

# 173

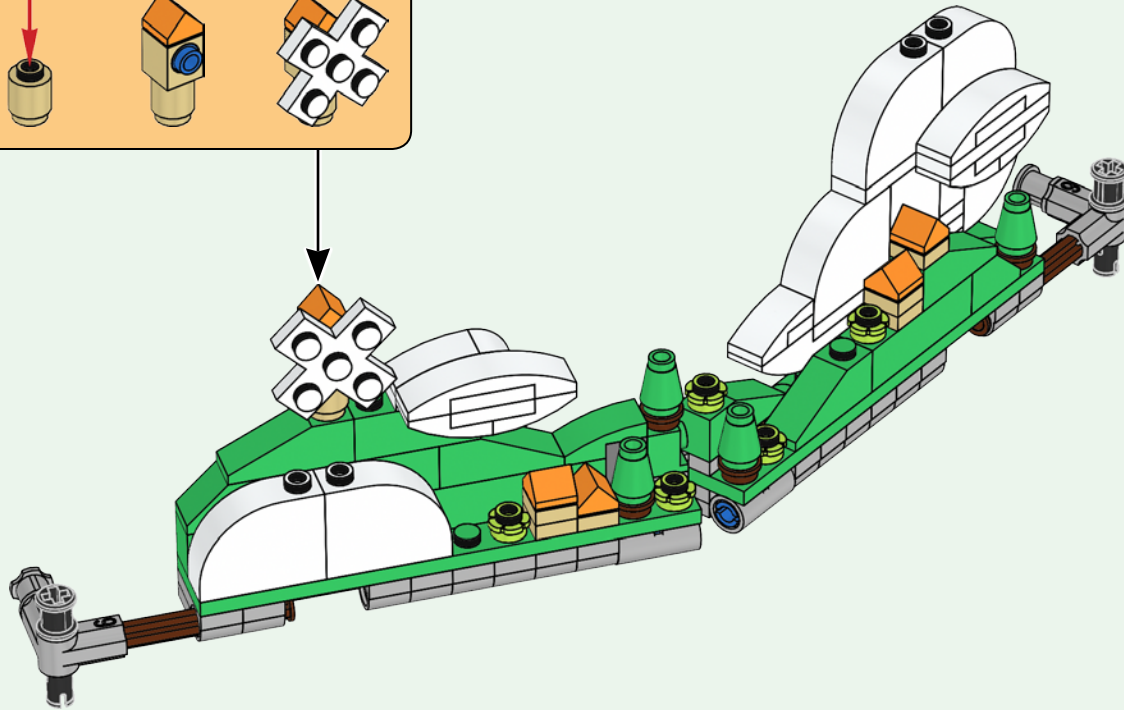
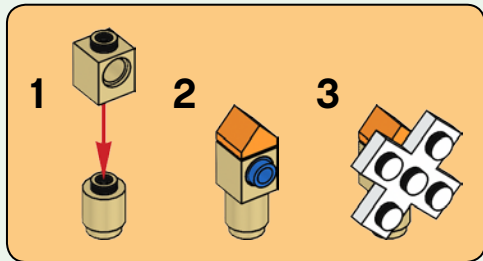



1x

174

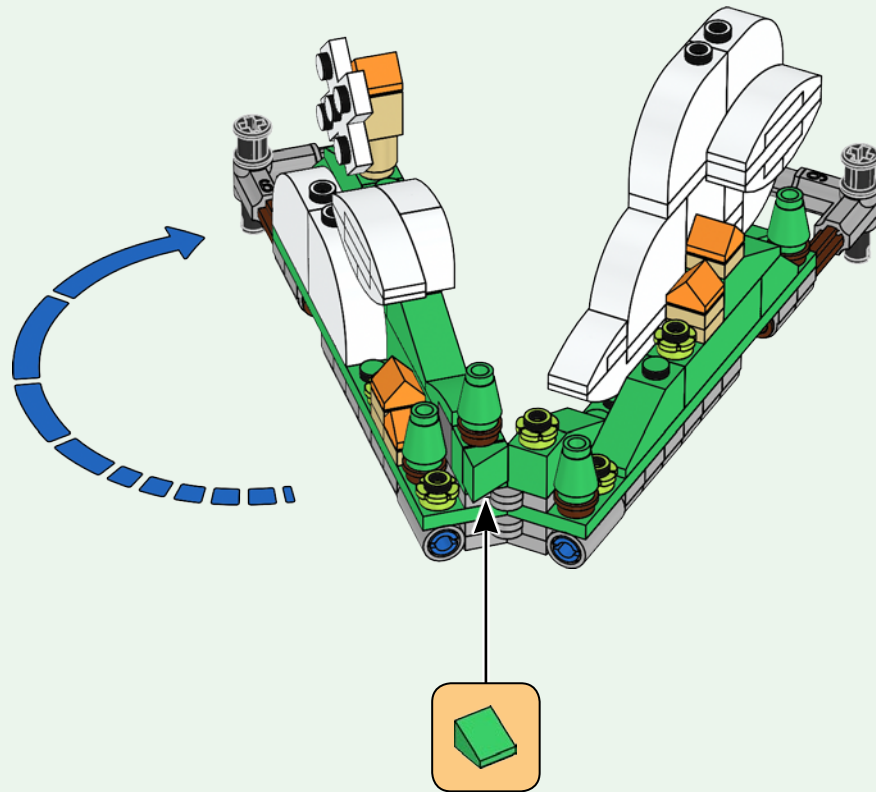



175

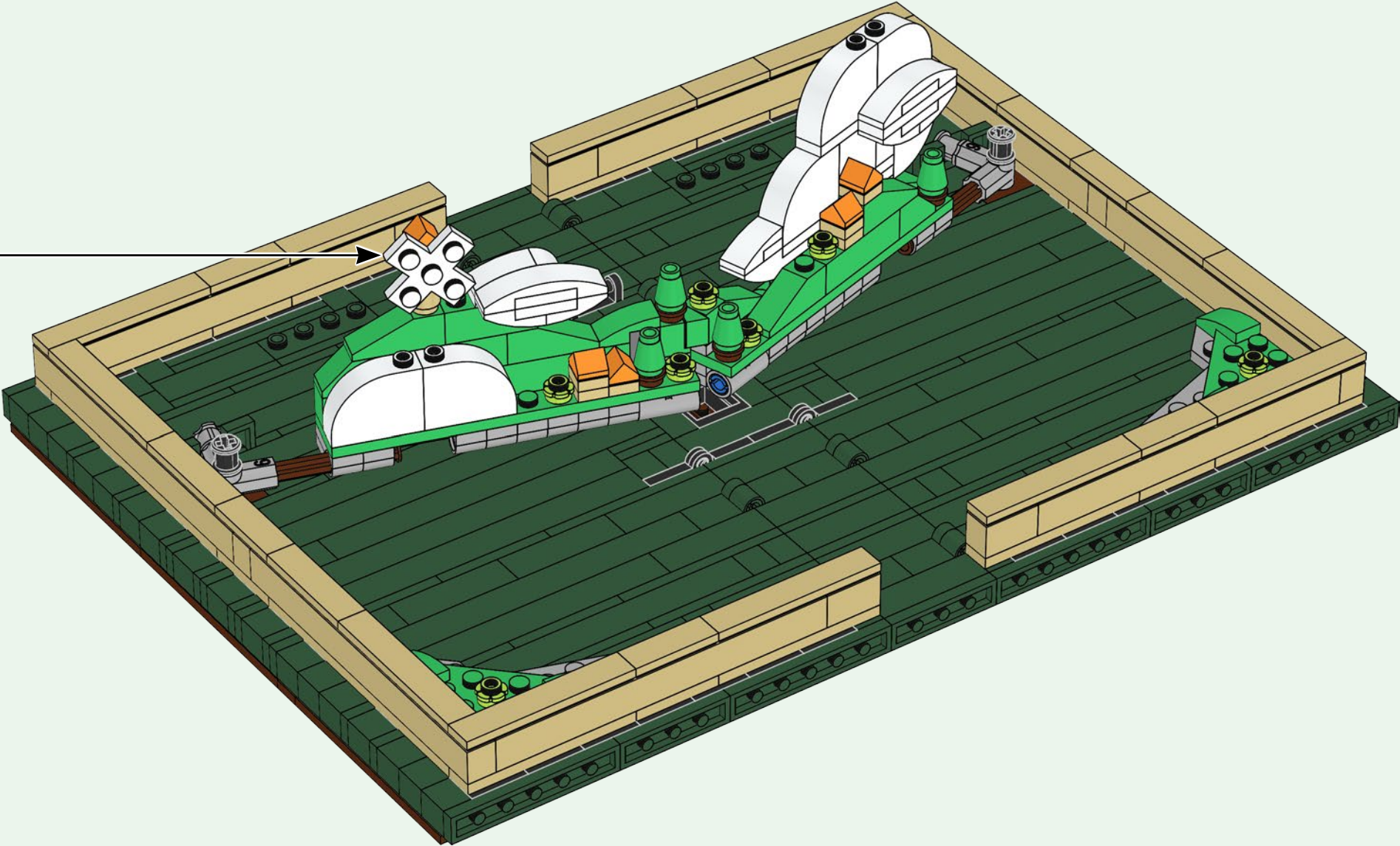

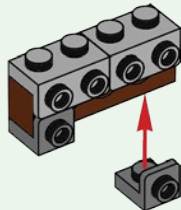
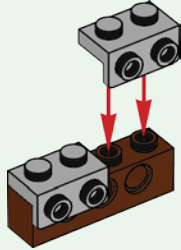
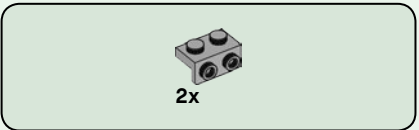
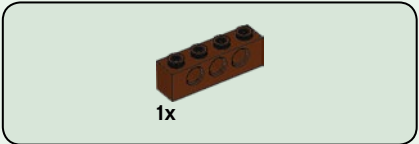
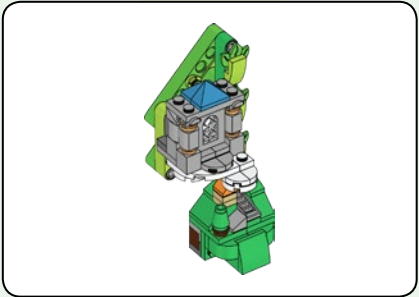
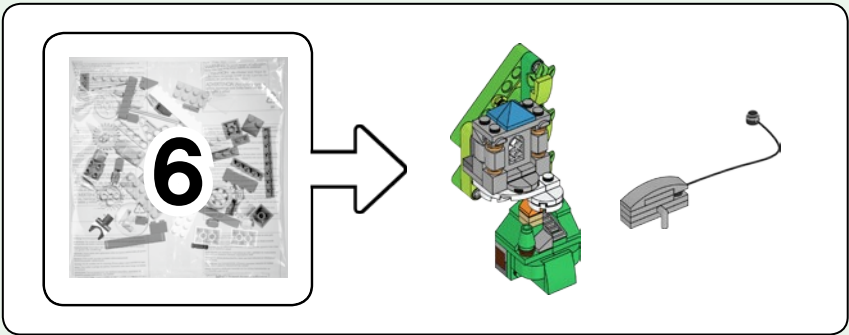

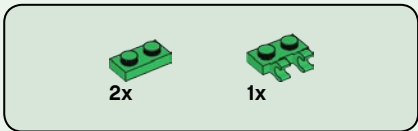

179

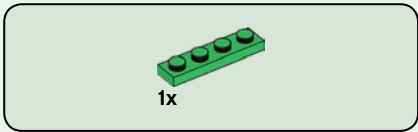
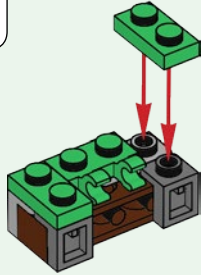
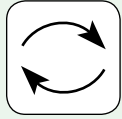

180

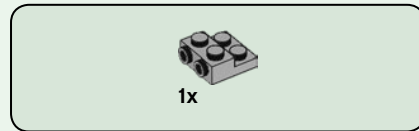
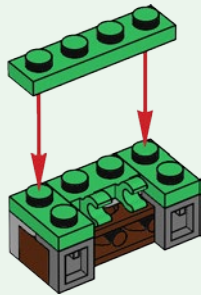

181

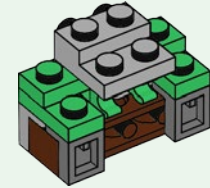

182

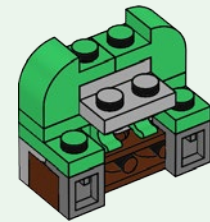

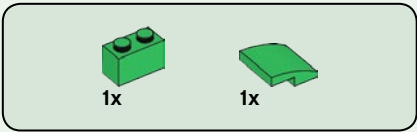

183

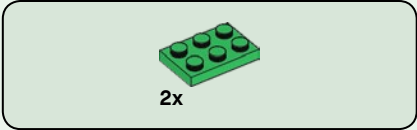
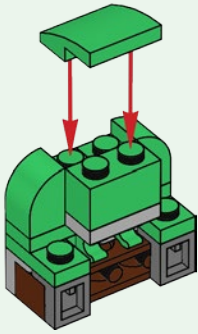

184

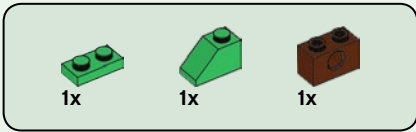
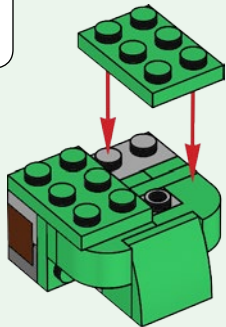
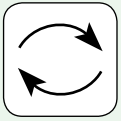

185

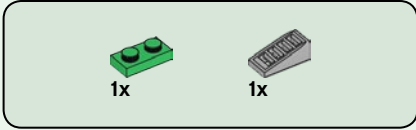
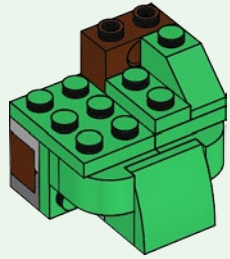

186

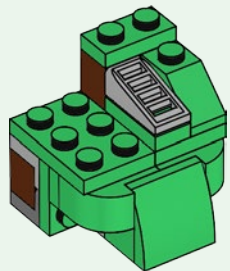

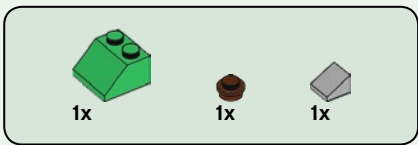

187

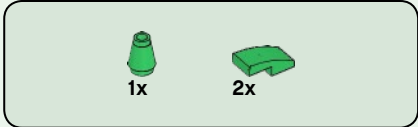
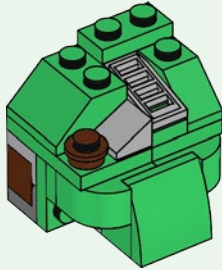

188

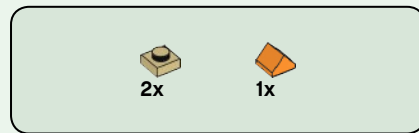
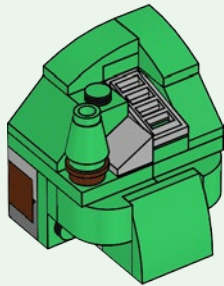

189

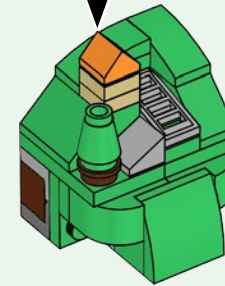
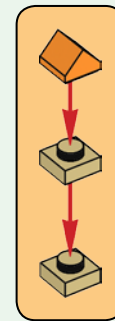

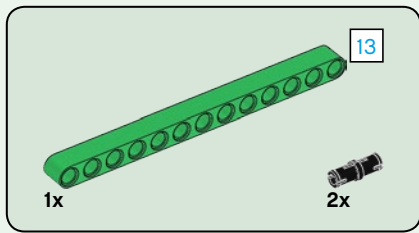

190

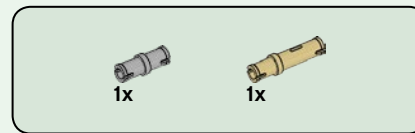
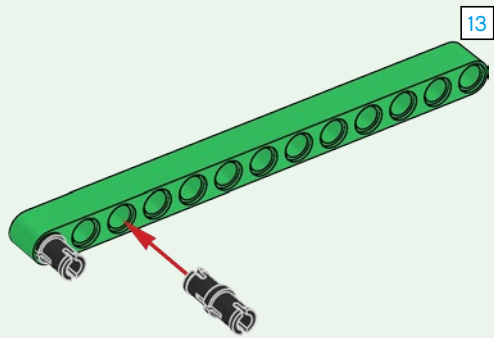

191

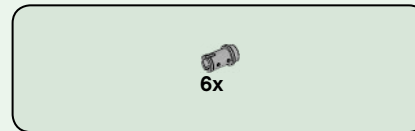
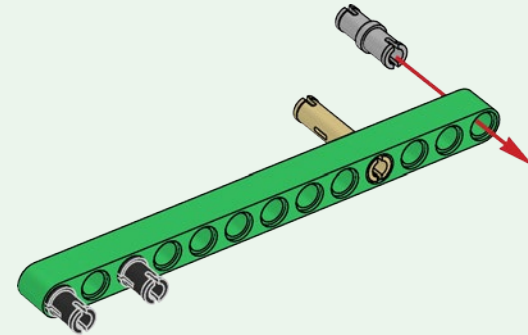

192

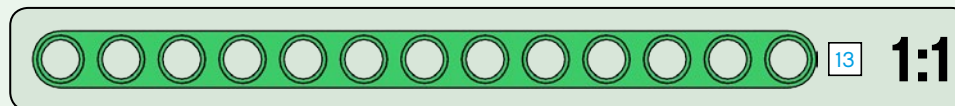
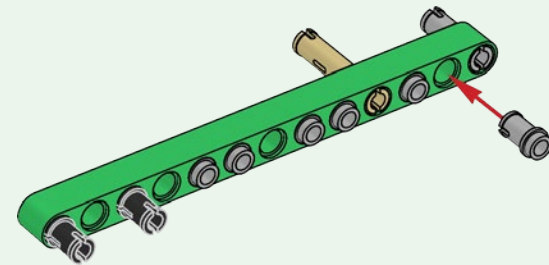



193

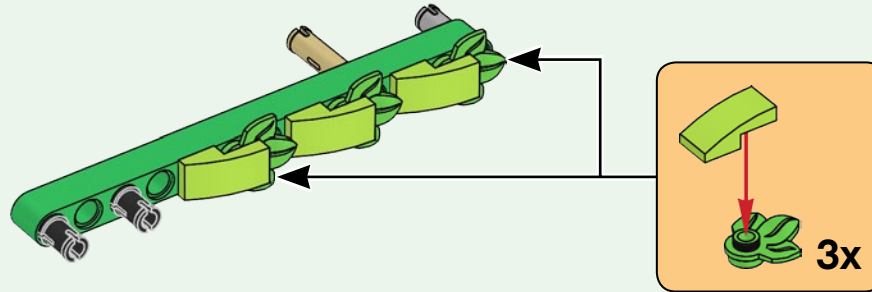

194

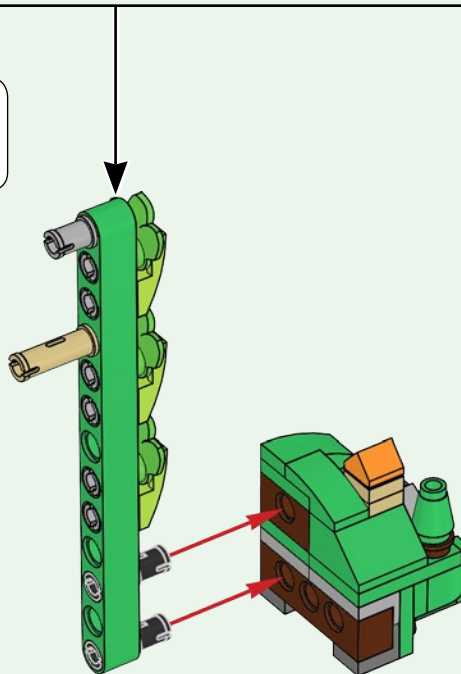
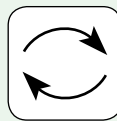

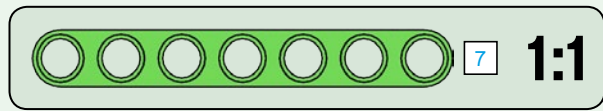
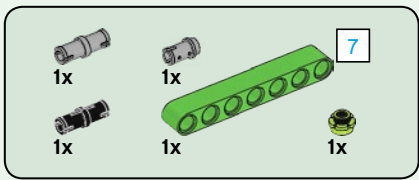

195

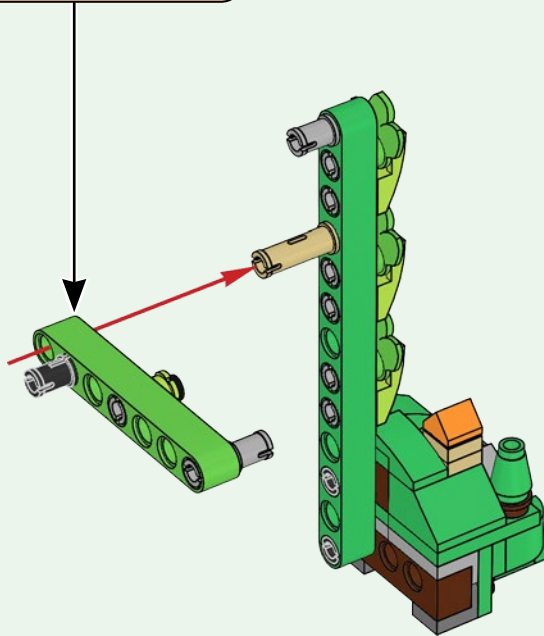
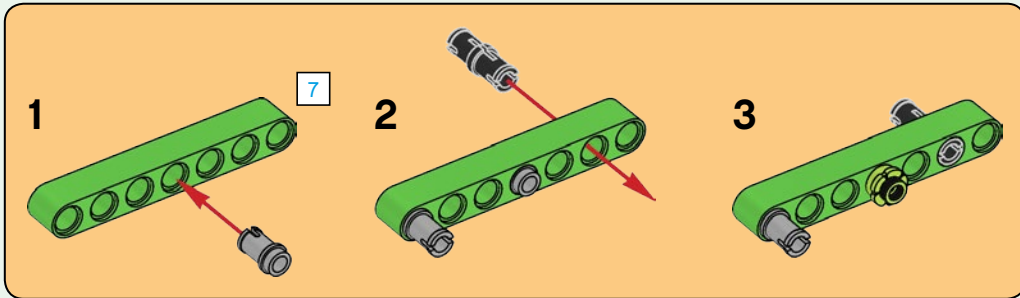



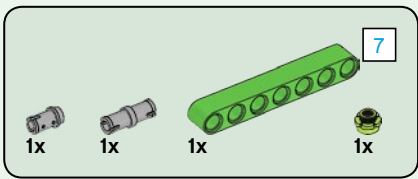

# 196

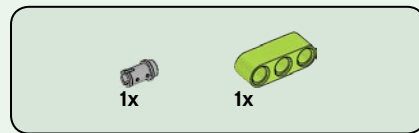
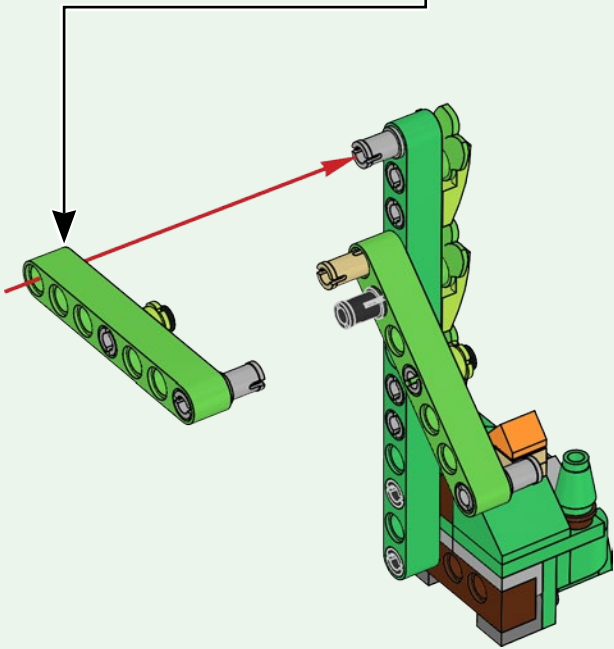
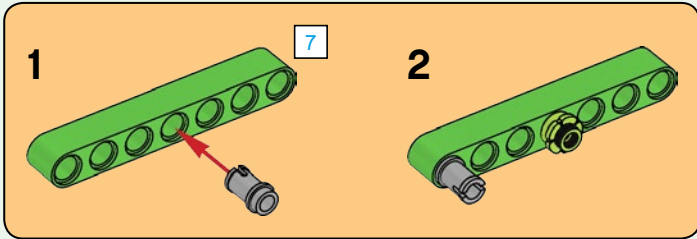

# 197

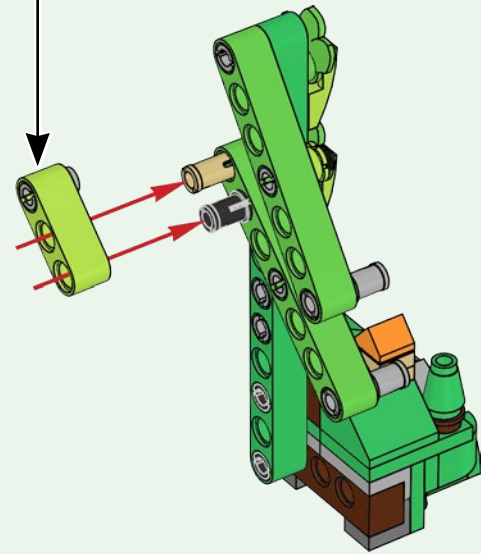
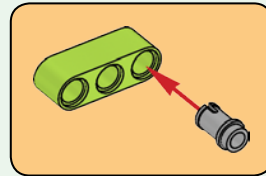

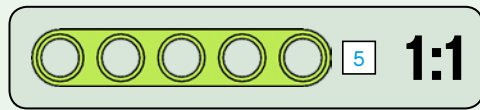
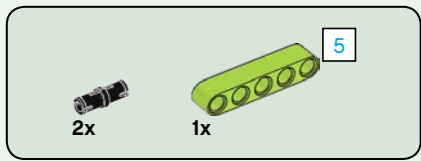

198

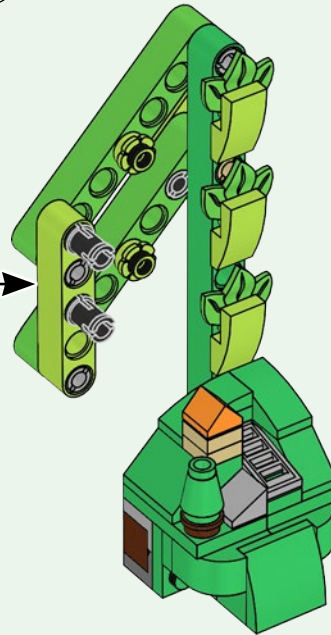
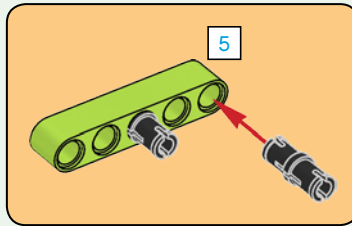
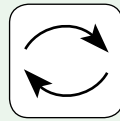

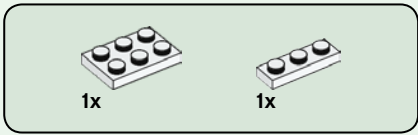
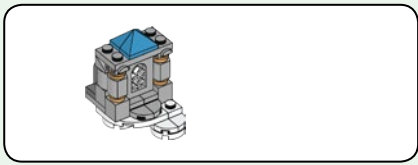

199

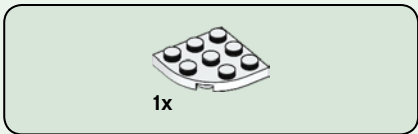
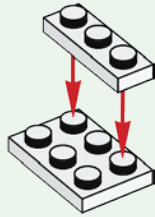

200

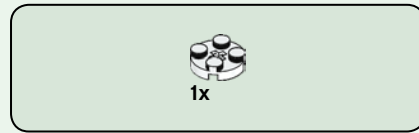

201

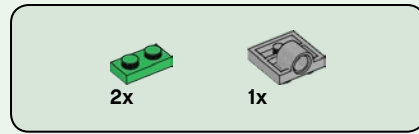
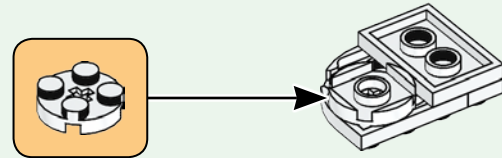
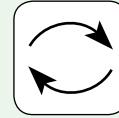

202

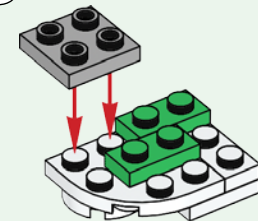
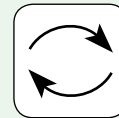



2x

# 203

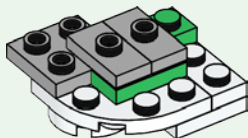

1x

# 204

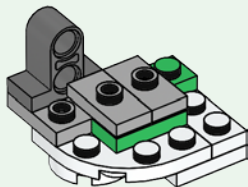

4x



2x

# 205

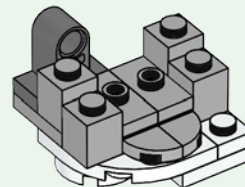

2x

# 206

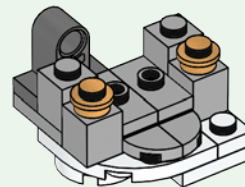

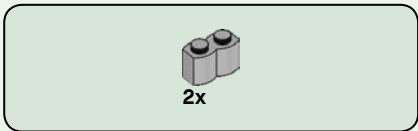

207

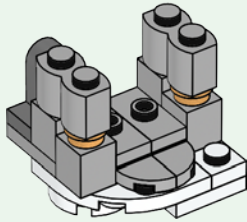

208

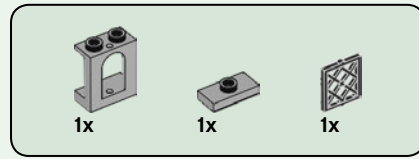
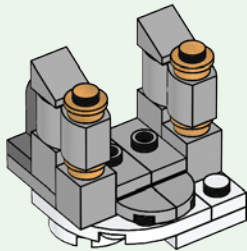

209

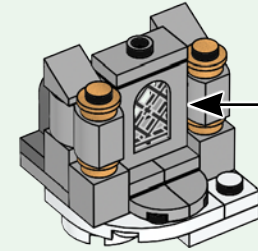
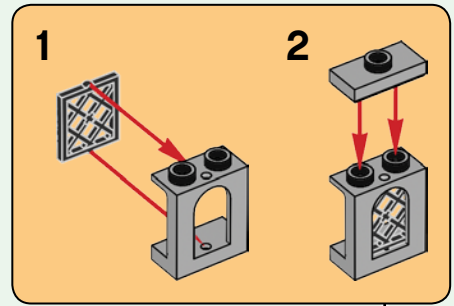

210

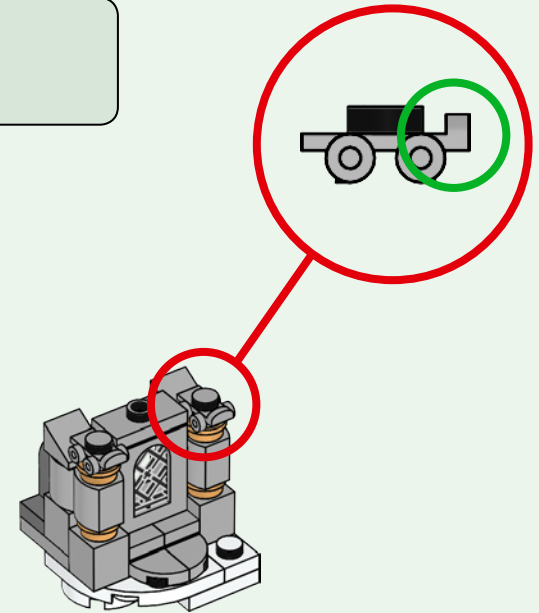



1x

## 211

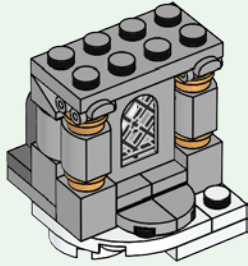

2x

## 212

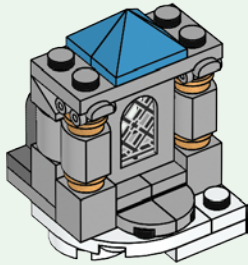

1x



2x

## 213

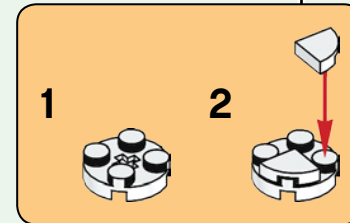
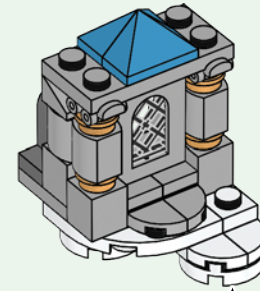

214

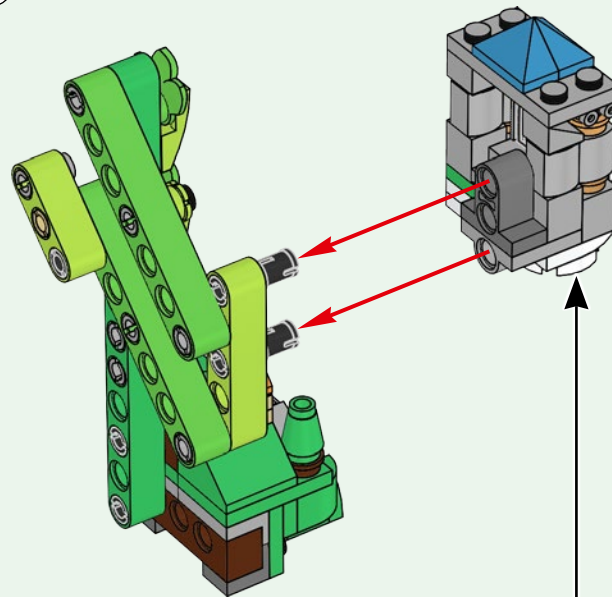
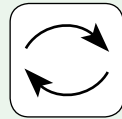

215

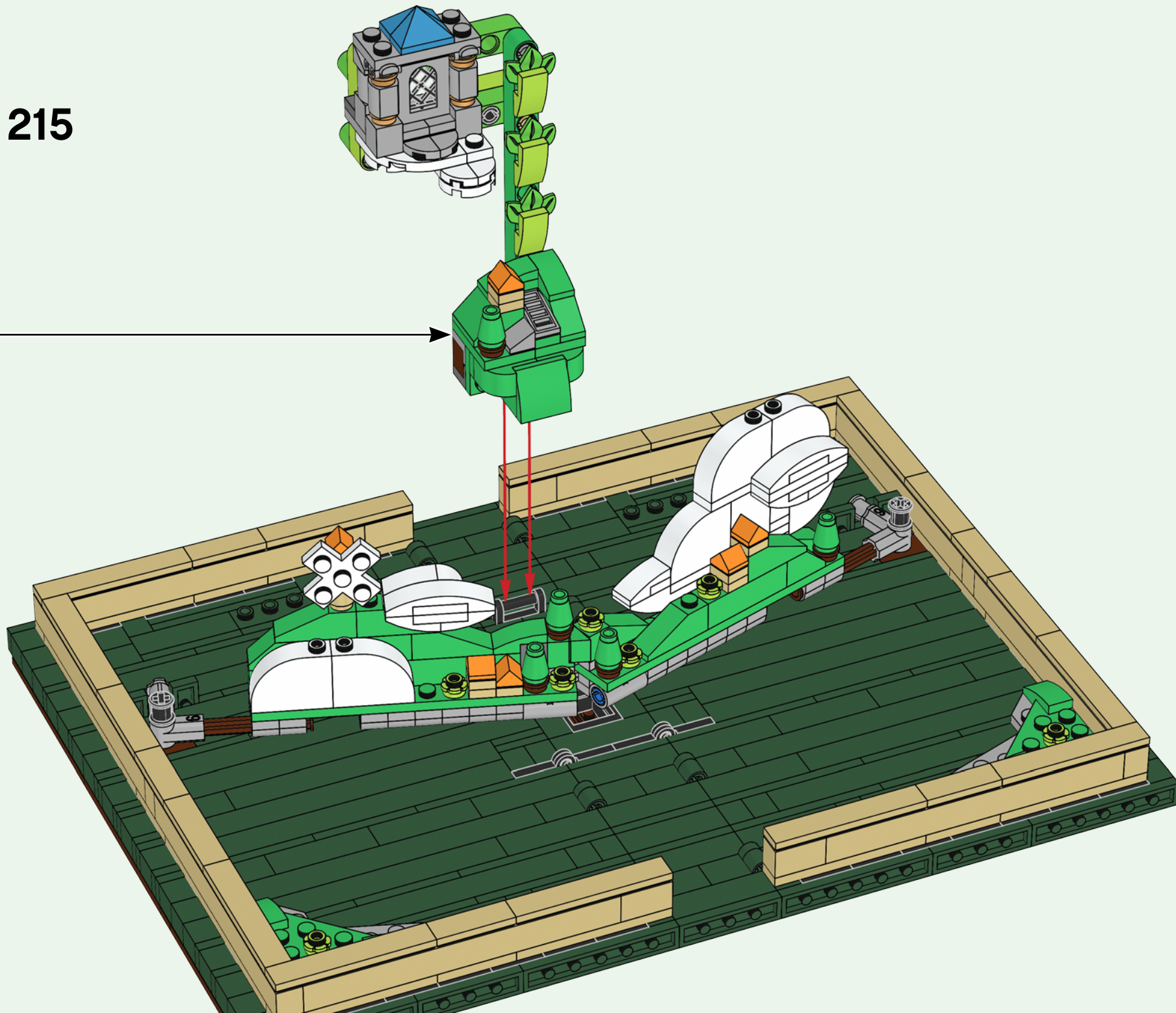



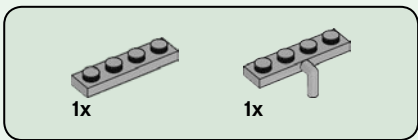

216

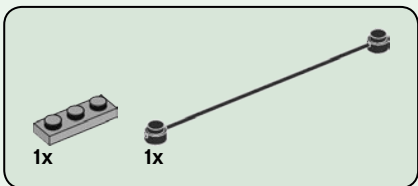
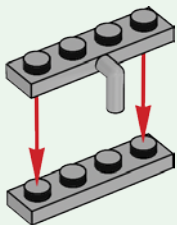

217

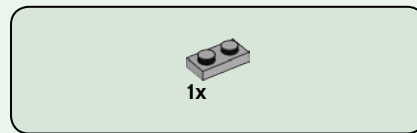
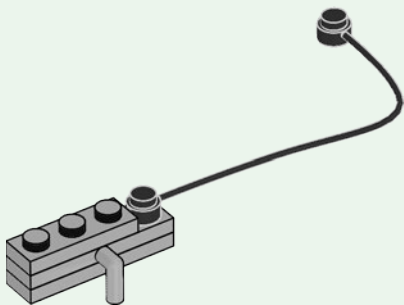

218

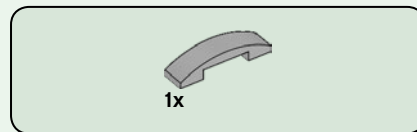
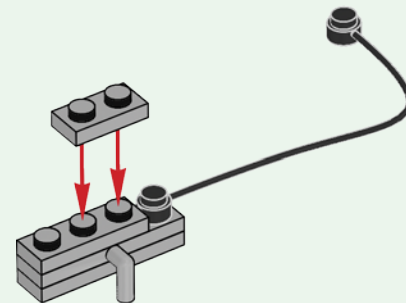

219

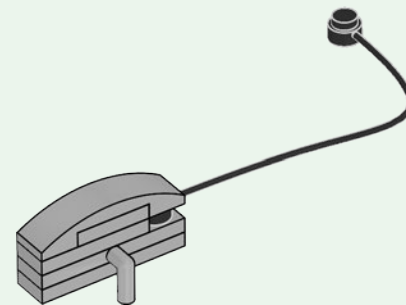

220

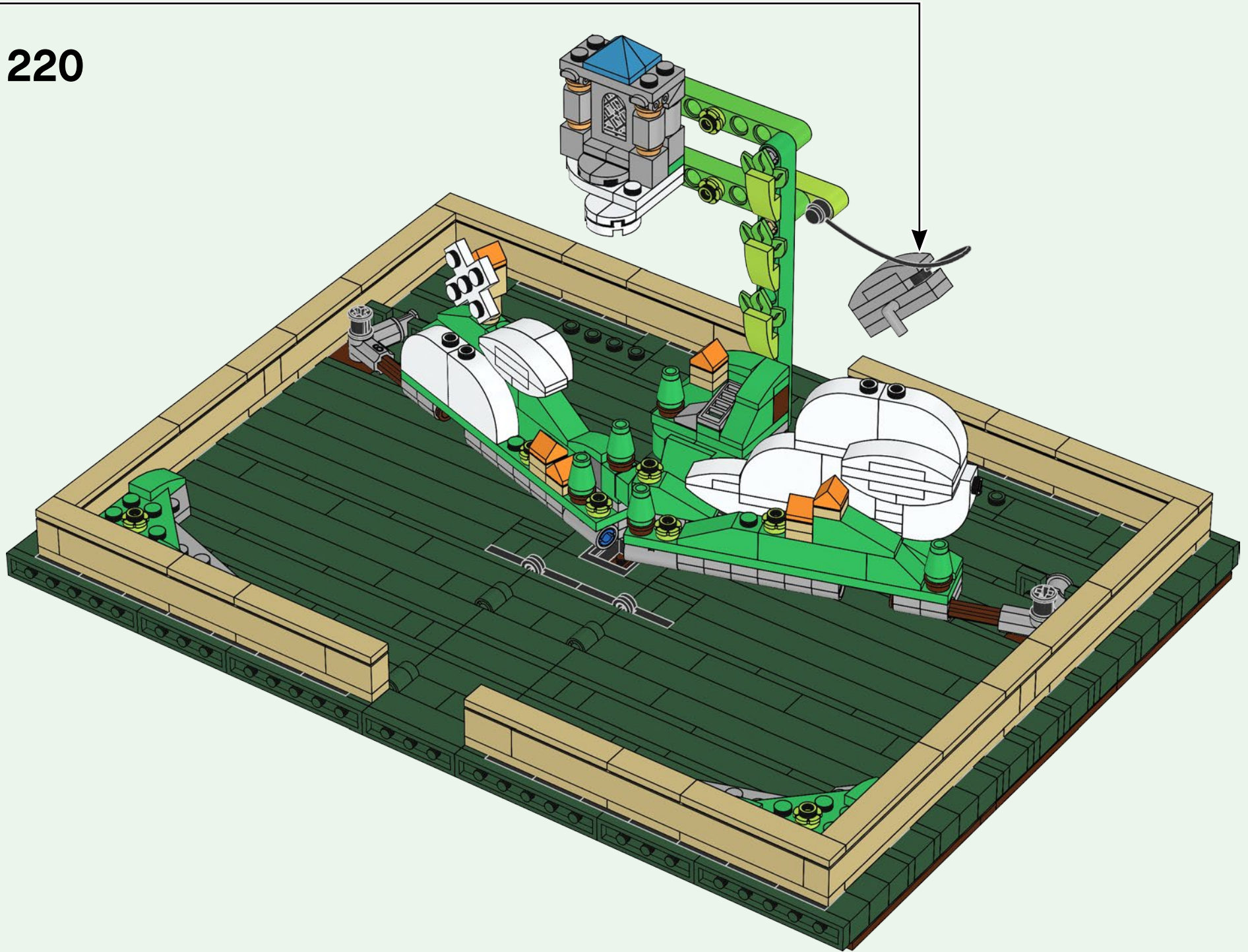

221

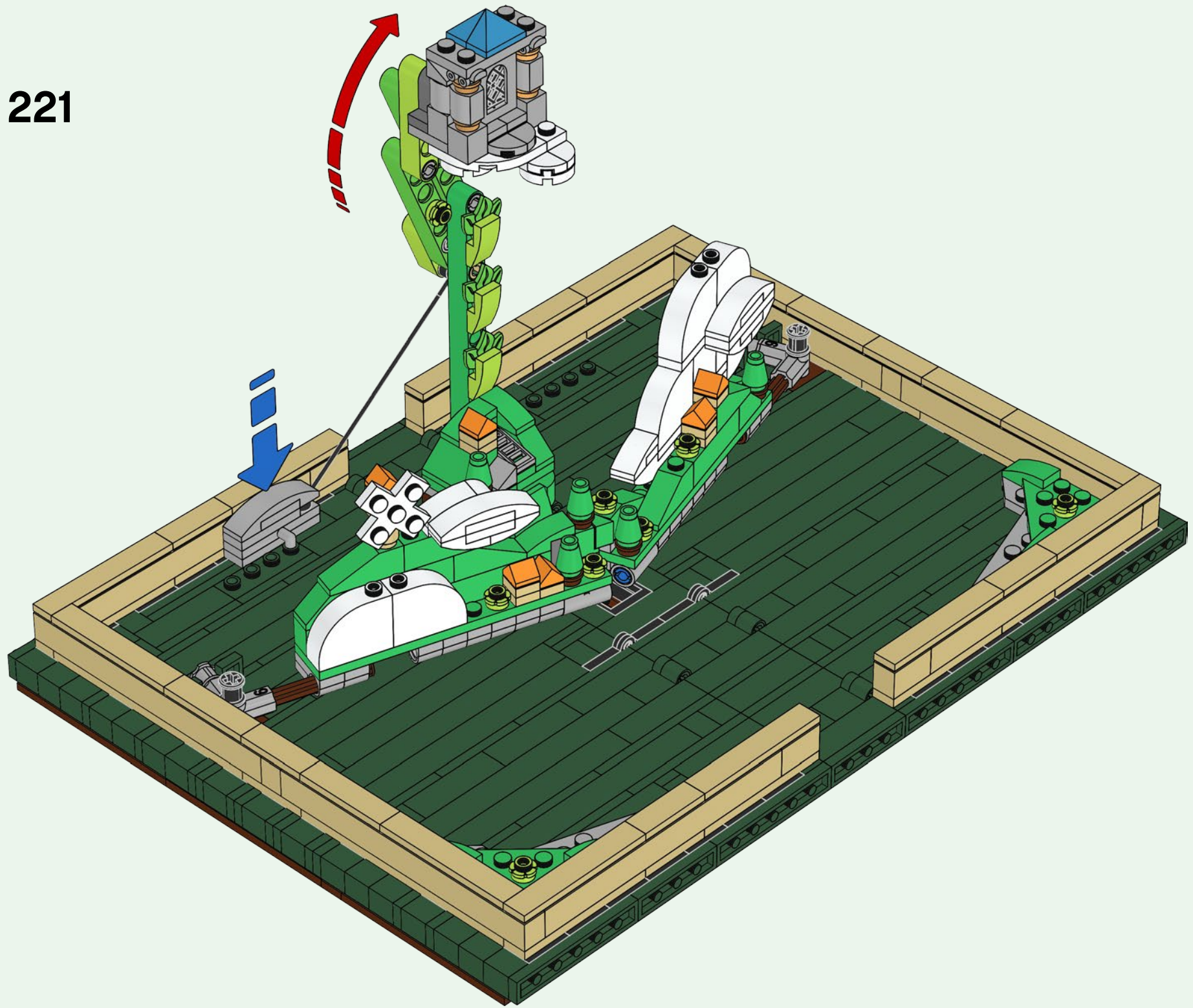

222

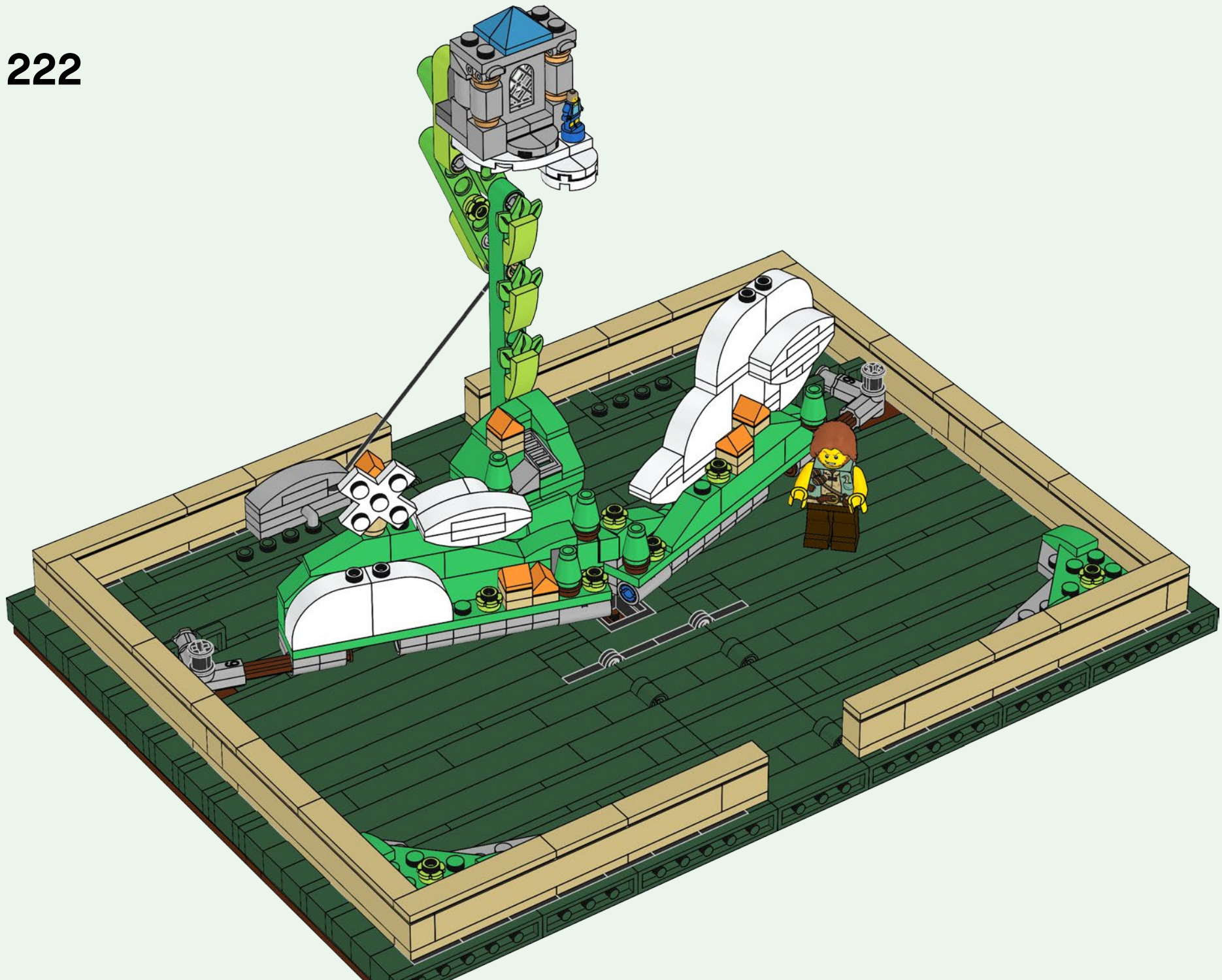

223

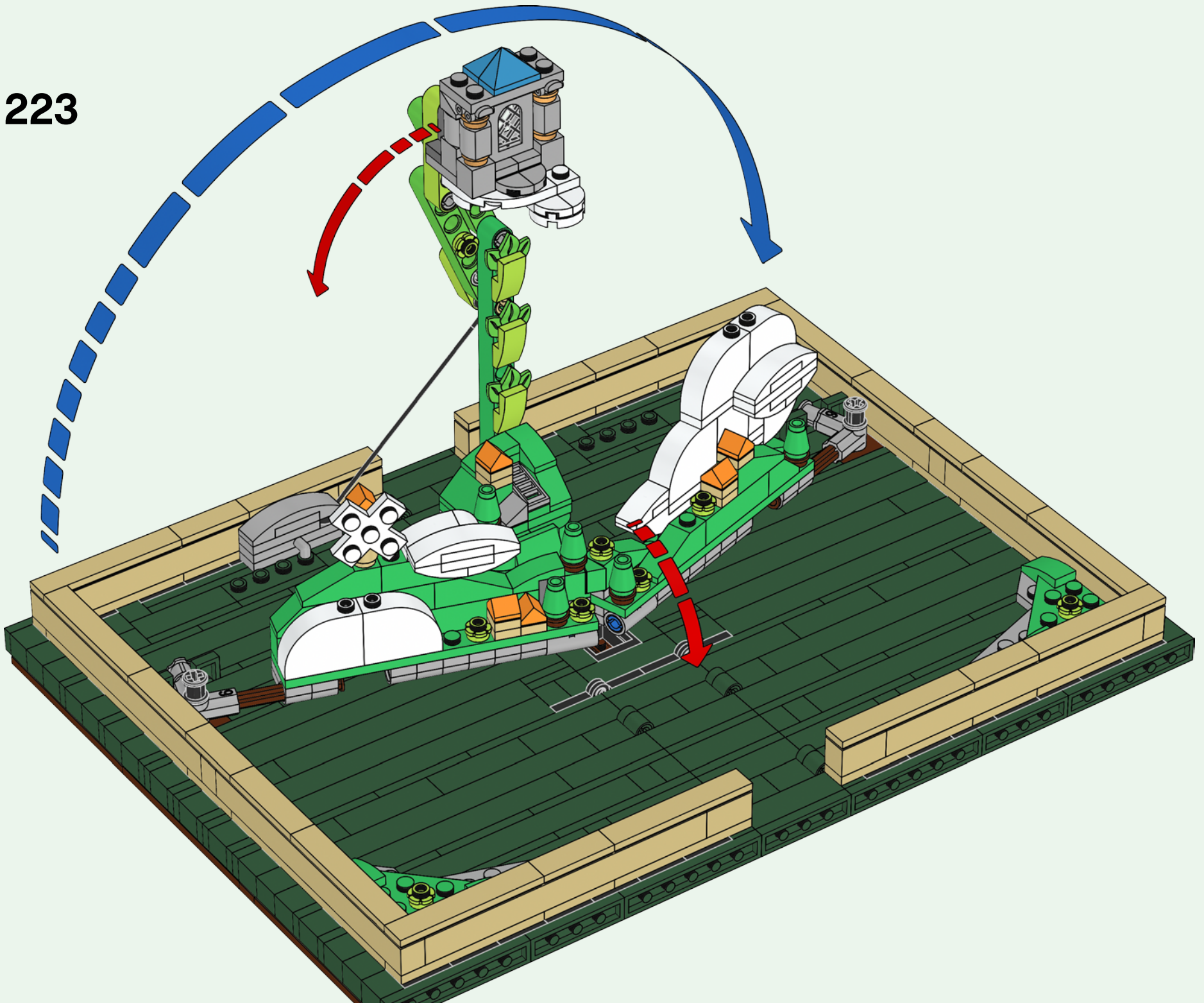



224

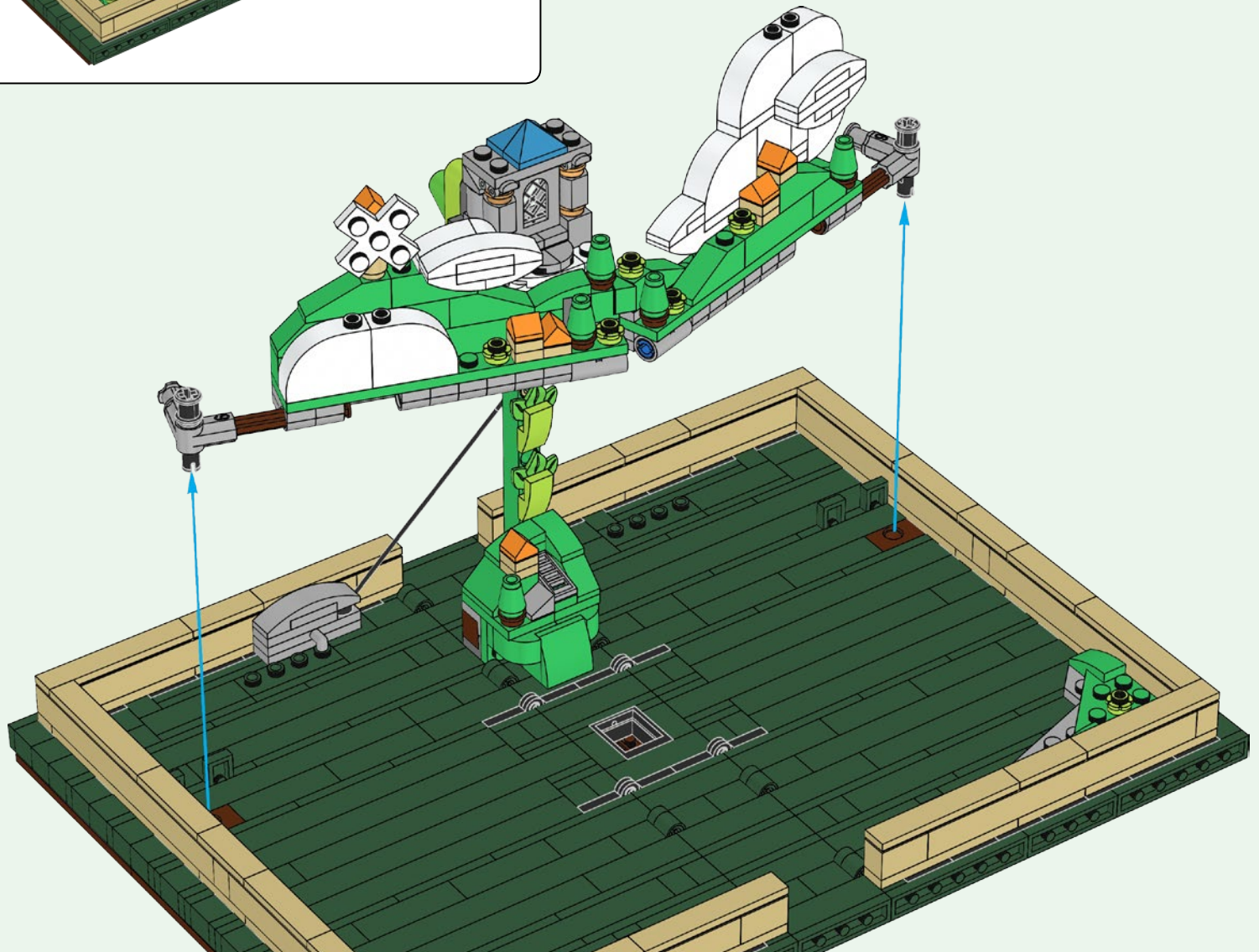

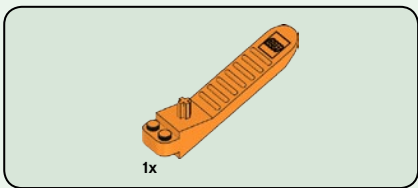

225

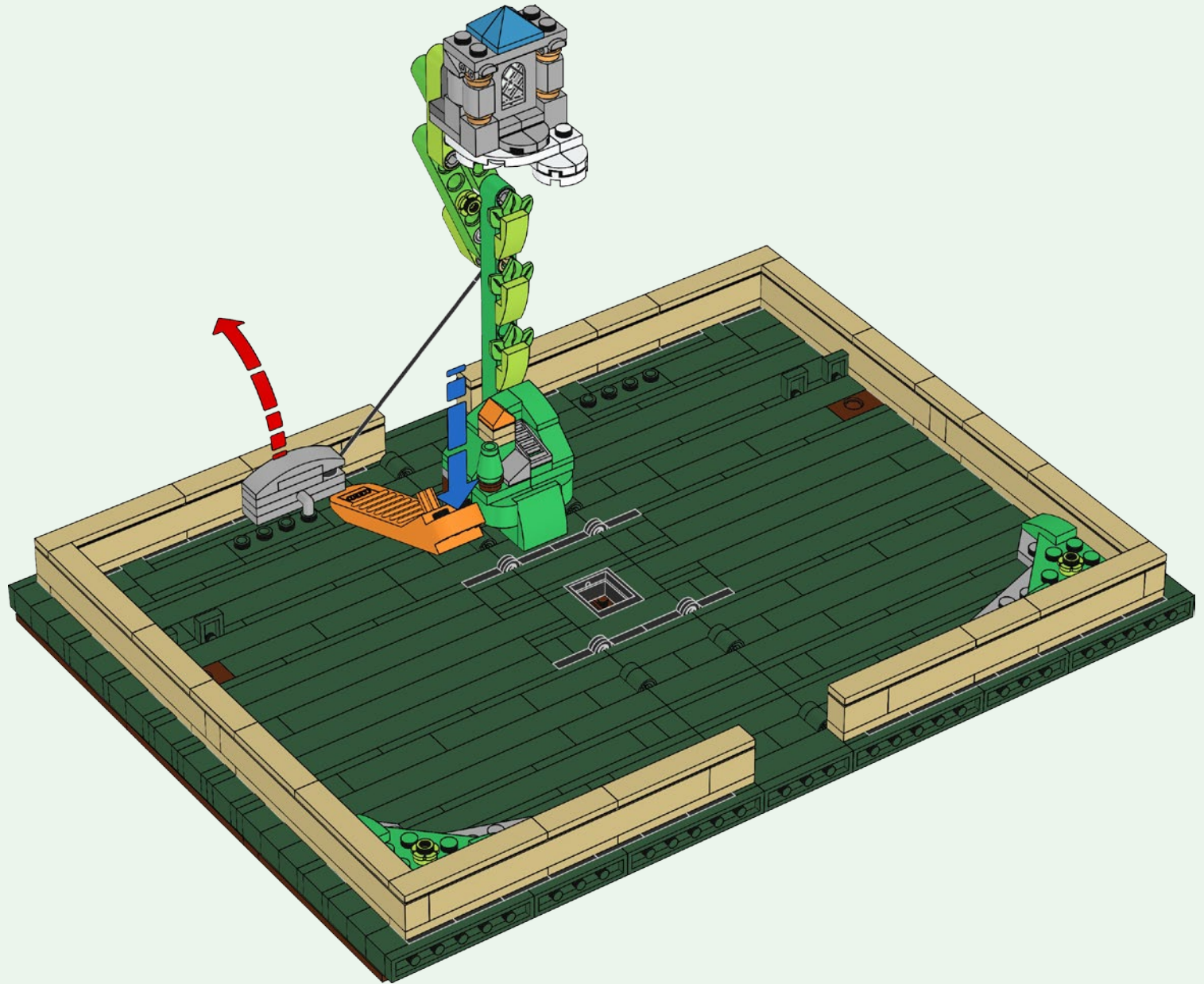

- 1x 4117070
- 2x 6139650
- 8x 4159553
- 1x 4179771
- 2x 4113915
- 4x 4109995
- 1x 4514554
- 6x 4121921
- 6x 6131896
- 4x 4550324
- 8x 4124067
- 12x 4157277
- 4x 4143409
- 2x 6070501
- 8x 6075179

160

- 1x 6252045
- 2x 6245265
- 1x 6096091
- 5x 6099728
- 9x 6209692
- 5x 6182261
- 3x 6069006
- 1x 6170474
- 1x 4661486
- 2x 6097392
- 2x 4112838
- 1x 4106356
- 1x 4111844
- 4x 6218146
- 1x 6036632

5

7

13

- 2x 6206150
- 5x 4529239
- 1x 4187334
- 1x 4546705
- 1x 4107736
- 7x 6047426
- 2x 6100223
- 3x 4121969
- 6x 302328
- 1x 4556159
- 1x 6116259
- 1x 303928
- 1x 4109679
- 6x 4107637
- 2x 302128
- 1x 371028
- 2x 4651215

- 1x 6251962
- 1x 4143005
- 4x 4514553
- 10x 6055169
- 14x 6252591
- 38x 6055222
- 20x 4245570
- 8x 6252590
- 28x 6013102
- 8x 6252589
- 2x 6013975
- 22x 4245571
- 22x 6055239
- 30x 6020923
- 32x 4245566
- 22x 6252592

- 2x 6151689
- 3x 6092674
- 1x 6097419
- 2x 6119126
- 1x 6252836
- 3x 4211090
- 2x 6225494
- 6x 4558955
- 1x 6234994
- 18x 4214559
- 24x 4253815
- 5x 4121715
- 1x 4521439
- 1x 4225201
- 4x 4140801
- 4x 6102782
- 1x 6096955

- 9x 4211095
- 1x 4210763
- 1x 6251969
- 2x 4210702
- 1x 4210999
- 1x 6254507
- 2x 6209682
- 1x 4618670
- 1x 6133667
- 1x 6254523
- 1x 6254948
- 2x 362221
- 1x 6210025
- 1x 4633914
- 1x 4560179

- 2x 6206148
- 2x 302421
- 1x 6251995
- 4x 4142865
- 2x 306921
- 6x 4216581
- 2x 6133854
- 4x 6149677
- 4x 4211288
- 2x 6172757
- 1x 4270443
- 3x 4211252
- 2x 4211149
- 5x 4211150
- 7x 4211151
- 2x 4211257
- 14x 6100769
- 2x 4211225
- 1x 4267994



6x  
4211190

2x  
4211194

1x  
4595889

1x  
4211186

4x  
6159763

1x  
6254441

1x  
6254450

2x  
4211204

2x  
4221590

8x  
6176608

20x  
4585337

1x  
6250298

1x  
6254400

9x  
4211483

2x  
6217791

4x  
4211622

2x  
6176433

3x  
4521921

4x  
4211389

1x  
6064026

2x  
4533772

4x  
6173127

2x  
4550325

3x  
4211807

4x  
4509886

2x  
6186657

3x  
6066097

32x  
6168633

4x  
6000066

1x  
4642934

5x  
4211398

1x  
6092111

2x  
4654582

1x  
4258273

1x  
4258275

1x  
6126082

1x  
6045988

1x  
4654577

1x  
4211429

1x  
4622803

1x  
4261605

1x  
4261605

1x  
4211445

2x  
6102769

1x  
4211395

3x  
4211393

4x  
4514846

8x  
302401

2x  
4504369

2x  
6172366

2x  
407001

3x  
6218841

4x  
300501

4x  
300501

2x  
403201

1x  
6011456

2x  
6058177

1x  
609101

5x  
302301

3x  
4113261

4x  
300401

2x  
6034044

4x  
6172927

1x  
383101

2x  
6018774

1x  
242001

4x  
362201

1x  
362301

1x  
6099412

6x  
4141668

1x  
302101

1x  
371001

2x  
301001

1x  
6034675

2x  
6023806

1x  
4550745

2x  
6102776

1x  
302001

1x  
6106183

6x  
6223631

1x  
6006514

1x  
6153221

1x  
6105708

1x  
6103921

2x  
302324

2x  
4121965

3x  
4271076

1x  
6254512

1x  
6254516

1x  
6254491

2x  
366601

1x  
346001

4x  
4523159

1x  
6173106

2x  
6186637

4x  
6020181

1x  
4529672

1x  
6254792

1x  
6240515

Customer Service

Kundenservice

Service Consommateurs

Servicio Al Consumidor

LEGO.com/service or dial



: 00800 5346 5555

: 1-800-422-5346



# IDEAS

GATHER SUPPORT  
OBTIENS DE L'APPUI  
OBTÉN APOYOS



SHARE YOUR IDEA  
PARTAGE TON IDÉE  
COMPARTE TU IDEA

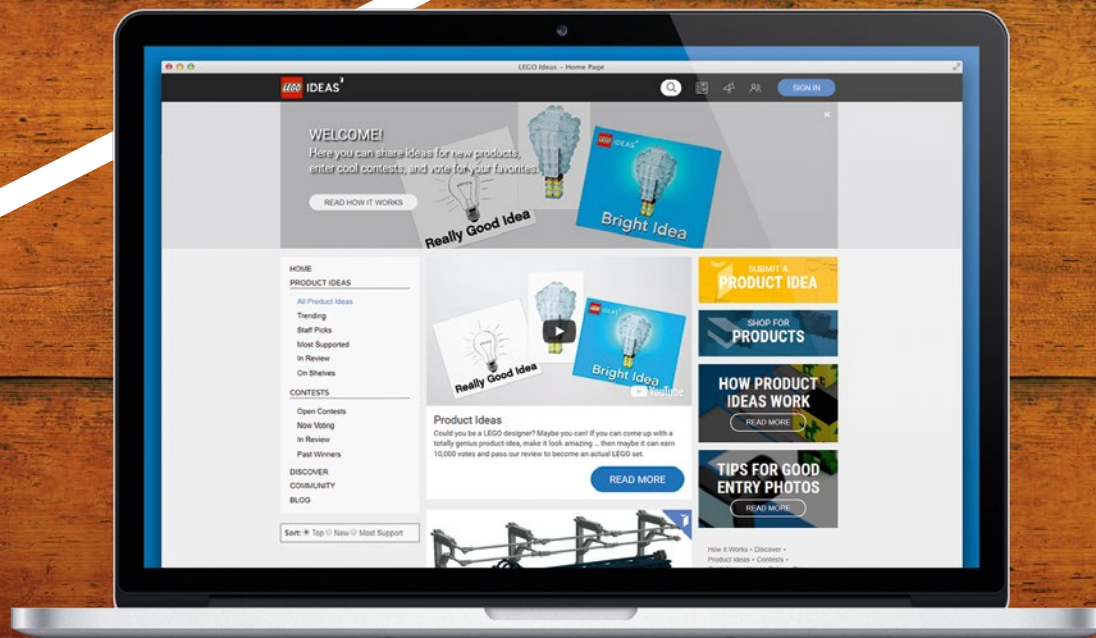

NEW LEGO® PRODUCT  
NOUVEAU PRODUIT LEGO®  
NUEVO PRODUCTO LEGO®

LEGO® REVIEW  
EXAMEN LEGO®  
REVISIÓN DE LEGO®





# IDEAS

## Do you like this LEGO® Ideas set?

The LEGO Group would like your opinion on the new product you have just purchased. Your feedback will help shape the future development of this product series.

Please visit:

[LEGO.com/productfeedback](https://www.lego.com/productfeedback)

By completing our short feedback survey, you will be automatically entered into a drawing to win a LEGO® prize.

Terms & Conditions apply.



## Aimez-vous cet ensemble LEGO® Ideas ?

Le Groupe LEGO aimerait connaître votre opinion sur le produit que vous venez d'acheter. Vos commentaires nous aideront à concevoir les futurs produits de cette gamme.

Veuillez visiter :

[LEGO.com/productfeedback](https://www.lego.com/productfeedback)

En remplissant ce court sondage sur le produit, vous serez automatiquement inscrit à un tirage au sort pour gagner un prix LEGO®.

Des conditions s'appliquent.

## ¿Te gusta este set LEGO® Ideas?

The LEGO Group quiere conocer tu opinión acerca del nuevo producto que acabas de comprar. Tus comentarios nos ayudarán a dar forma a los futuros productos de esta serie.

Visita:

[LEGO.com/productfeedback](https://www.lego.com/productfeedback)

Al contestar este breve cuestionario de opinión, participarás automáticamente en el sorteo de un producto LEGO®.

Sujeto a términos y condiciones.