



Architecture

21052

Dubai

United Arab Emirates

Dubāï

Émirats arabes unis

Dubái

Emiratos Árabes Unidos

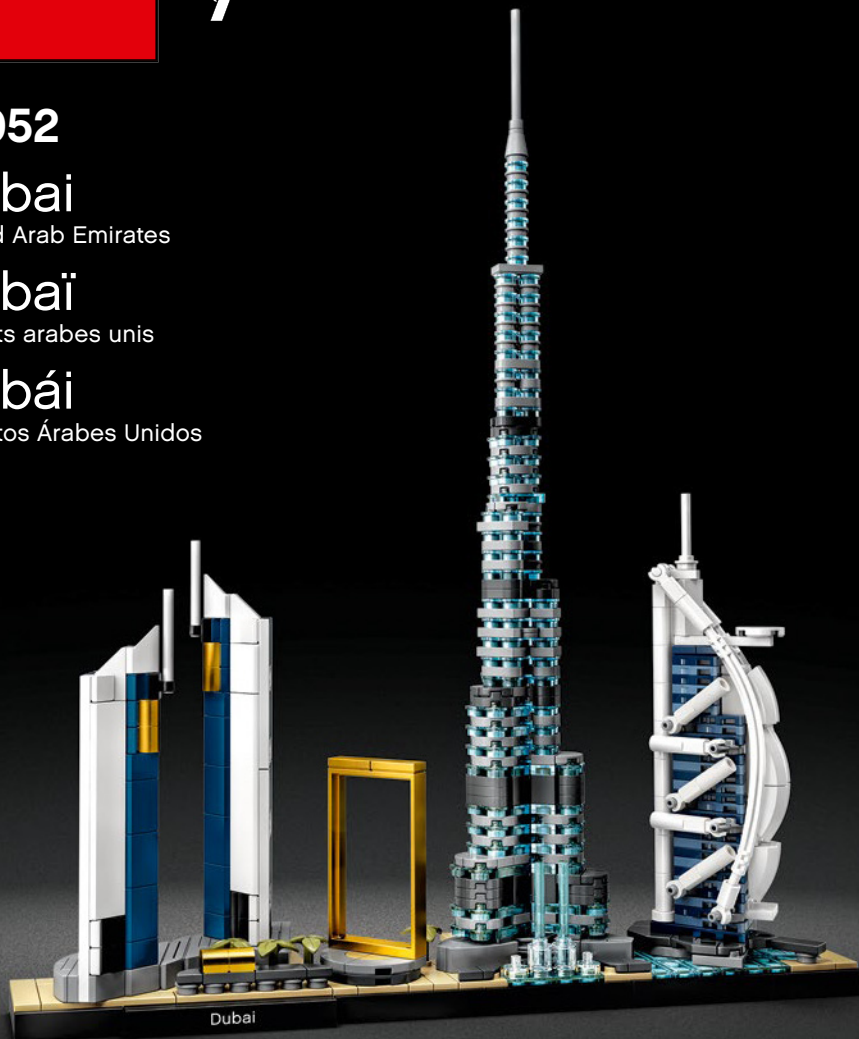

Dubai Dubāi Dubái

At the crossroads of Europe, Asia and Africa, Dubai is a vibrant blend of traditional Arabian culture and futuristic metropolis. Established as a modern international hub for trade, transport and tourism, it also contains some of the boldest architectural statements in the world.

Au carrefour de l'Europe, de l'Asie et de l'Afrique, Dubaï est un mélange vibrant de culture arabe traditionnelle et de métropole futuriste. Plaque tournante internationale moderne pour le commerce, les transports et le tourisme, la ville contient également quelques-uns des éléments architecturaux les plus audacieux du monde.

Punto de encuentro entre Europa, Asia y África, Dubái concentra con vitalidad la cultura árabe tradicional y una futurista metrópoli. Concebida como un moderno polo internacional para el comercio, el transporte y el turismo, contiene también algunas de las manifestaciones arquitectónicas más audaces del mundo.

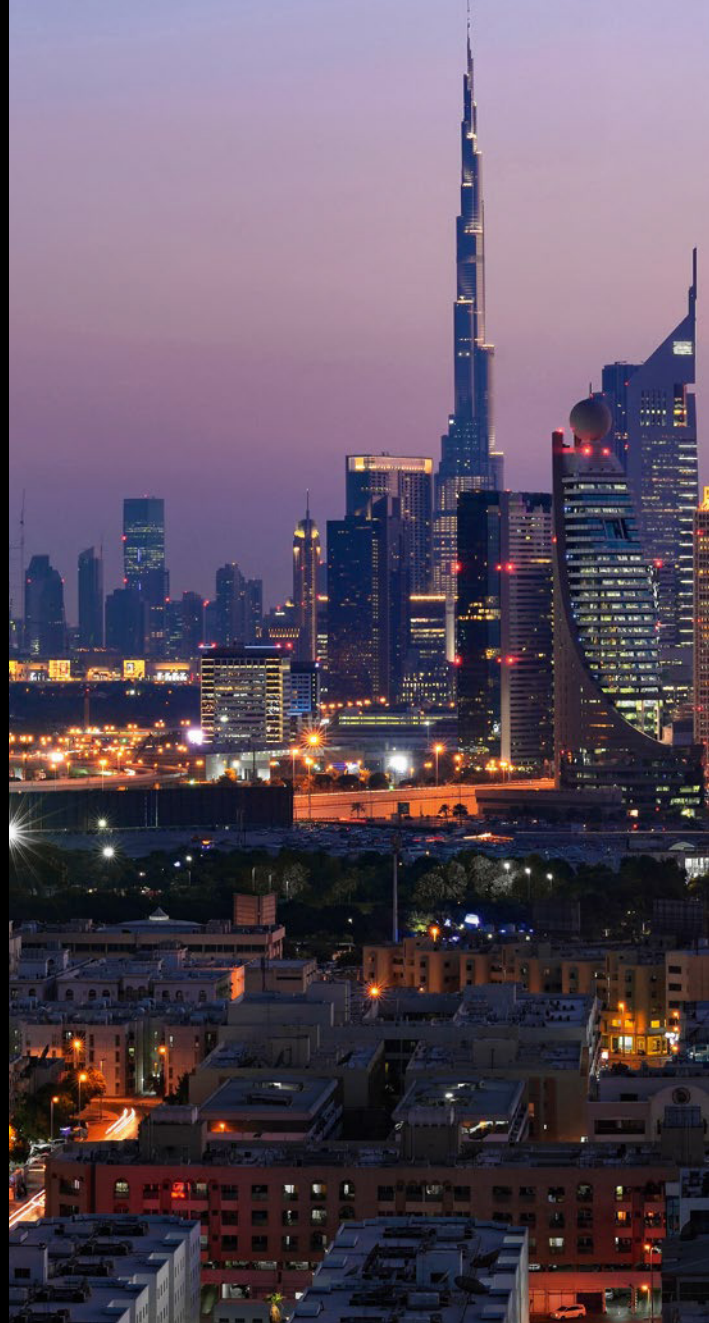

"...a place where everybody from all over the world meets each other"

HH Sheikh Mohammed bin Rashid Al Maktoum

« ... un endroit où des gens du monde entier se rencontrent »

S. A. Cheikh Mohammed bin Rashid Al Maktoum

"... un lugar donde se reúnen personas de todo el mundo".

S. A. el jeque Mohamed bin Rashid al Maktum





Jumeirah Emirates Towers

Les Jumeirah Emirates Towers

Torres Jumeirah Emirates

Soaring high above Dubai's financial district, the Jumeirah Emirates Towers are among the most iconic in the city. The larger of the two towers houses an office complex, while the smaller tower is a luxury 56-floor, 400-room hotel. The exterior of the triangular structures is inspired by traditional Islamic themes.

S'élevant au-dessus du quartier financier de Dubaï, les Jumeirah Emirates Towers sont parmi les plus emblématiques de la ville. La plus grande des deux tours abrite un complexe de bureaux, tandis que la plus petite est un hôtel de luxe de 56 étages et 400 chambres. L'extérieur des structures triangulaires est inspiré des thèmes islamiques traditionnels.

Las Torres Jumeirah Emirates se elevan por encima del distrito financiero de Dubái y se cuentan entre las más representativas de la ciudad. La mayor de las dos torres alberga un complejo de oficinas, mientras que la torre más pequeña es un lujoso hotel de 56 pisos y 400 habitaciones. La fachada de las estructuras triangulares está inspirada en temas islámicos tradicionales.



Dubai Frame Le Dubai Frame Marco de Dubái

Dubai's latest architectural landmark is the impressive Dubai Frame. Measuring 492 ft. (150m) high and 305 ft. (93m) wide, the structure metaphorically frames the development of the city's past and present, while offering a panoramic view of the Emirate.

La dernière œuvre architecturale de Dubaï est l'impressionnant Dubai Frame. Il mesure 150 m de haut et 93 m de large. Sa structure encadre métaphoriquement le développement du passé et du présent de la ville, tout en offrant une vue panoramique sur l'émirat.

El hito arquitectónico más reciente de Dubái es el impresionante Marco de Dubái. Con 150 m de alto y 93 m de ancho, la estructura enmarca metafóricamente el desarrollo entre el pasado y el presente de la ciudad, y al mismo tiempo ofrece una hermosa vista del emirato.

The Dubai Fountain

La fontaine de Dubaï

Fuente de Dubái

The Dubai Fountain is the world's largest choreographed fountain experience. Set in the 30-acre (12 ha), man-made Burj Khalifa Lake, it shoots water 500 ft. (152m) into the air in time to a range of classical, modern and Arabic music.

La fontaine de Dubaï présente la plus importante chorégraphie au monde réalisée avec une fontaine. Située dans le lac artificiel de Burj Khalifa de 12 ha, elle projette de l'eau à 152 m de haut sur fond de musique classique, moderne et arabe.

La Fuente de Dubái es la mayor experiencia hidrocoreografiada del mundo. Ubicada en el lago artificial Burj Khalifa, de 12 ha, lanza agua a 152 m de altura en sincronía con un amplio abanico de piezas de música clásica, moderna y árabe.



Burj Khalifa

Towering 2,716.5 ft. (828m) above downtown Dubai, Burj Khalifa has been the tallest building in the world since its completion in 2010. Described as a “vertical city,” the architects incorporated many patterns and elements from traditional Islamic architecture within its ultra-modern design.

Surplombant le centre-ville de Dubaï du haut de ses 828 m, Burj Khalifa est le bâtiment le plus élevé du monde depuis son achèvement en 2010. Décrit comme une « ville verticale », il comporte de nombreux motifs et éléments de l'architecture islamique traditionnelle dans son design ultra-moderne.

Con una vertiginosa altura de 828 m sobre el centro de Dubái, el Burj Khalifa ha sido el edificio más alto del mundo desde su construcción en 2010. Descrito como “ciudad vertical”, los arquitectos incorporaron numerosos patrones y elementos característicos de la arquitectura tradicional islámica en su ultramoderno diseño.

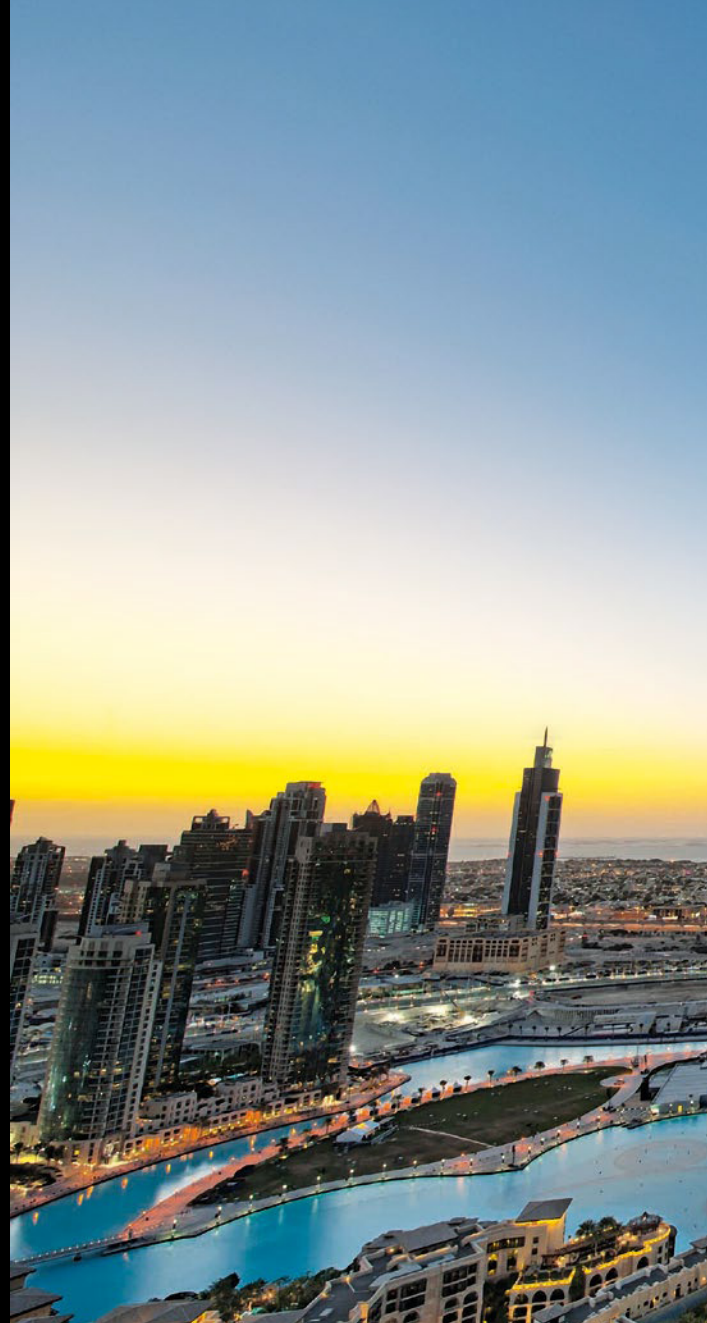



"The race for excellence has no finish line."

HH Sheikh Mohammed bin Rashid Al Maktoum

« La course à l'excellence n'a pas de ligne d'arrivée. »

S.A. Cheikh Mohammed bin Rashid Al Maktoum

"La carrera por la excelencia no tiene línea de meta".

S. A. el jeque Mohamed bin Rashid al Maktoum



Burj Al Arab

The distinctive sail-shaped silhouette of the Burj Al Arab Jumeirah has become an icon of modern Dubai. Built on a triangular, man-made island, the 1,053 ft. (321m) tall hotel boasts both a helipad and an underwater aquarium restaurant reached through a simulated submarine voyage.

La silhouette distinctive en forme de voile du Burj Al Arab Jumeirah est devenue une icône du Dubaï moderne. Construit sur une île triangulaire artificielle, le grand hôtel de 321 m dispose à la fois d'un hélicoptère et d'un restaurant doté d'un aquarium sous-marin auquel on accède par un voyage sous-marin simulé.

La característica silueta con forma de vela del Burj Al Arab Jumeirah se ha convertido en un icono de la Dubái moderna. Construido sobre una isla artificial triangular, el hotel, de 321 m de altura, cuenta con un helipuerto y un restaurante-acuario subacuático al que se llega mediante un viaje submarino simulado.



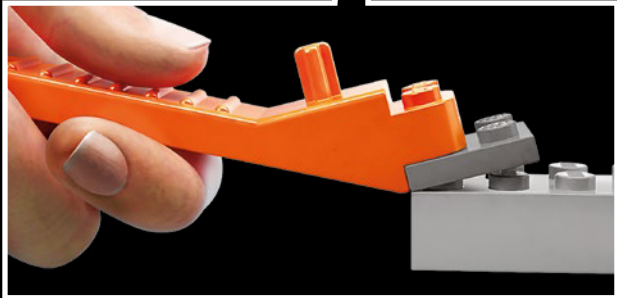
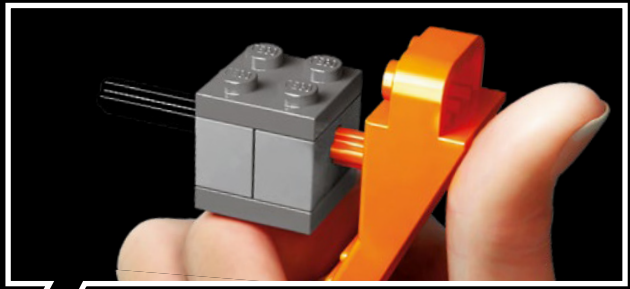
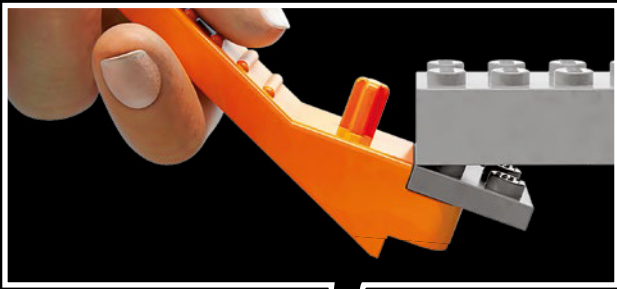



- 1** Scan the code on the front cover
 Scanne den Code auf der Titelseite
 Scanne le code sur la page de couverture
 Scanner le code sur la page couverture
 Scansiona il codice sulla copertina
 Escanea el código de la portada
 Faz scan do código na frente da capa
 Olvasd be a borítón látható kódot!
 Noskenē kodu uz priekšējā vāka
 扫描封面上的二维码

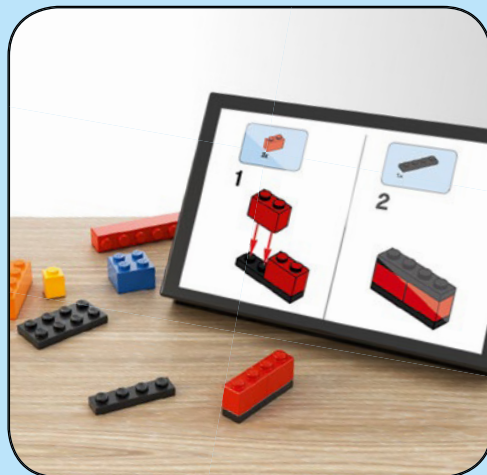

- 2** Get the Building Instructions
 Hol dir die Bauanleitung
 Obtens les instructions de montage
 Obtenir les instructions de montage
 Scarica le istruzioni per la costruzione
 Consulta las instrucciones de construcción
 Obtém as Instruções de Construção
 Szerezd be az építési útmutatókat!
 Saņem būvēšanas instrukcijas
 获取拼搭说明

LEGO.com/apps

Check for compatibility
 Kompatibilität prüfen
 Vérifier la compatibilité
 Controlla la compatibilità
 Comprueba tu compatibilidad

Verificar a compatibilidade
 Ellenőrizd a kompatibilitást
 Pārbaudīt saderību
 检查兼容性

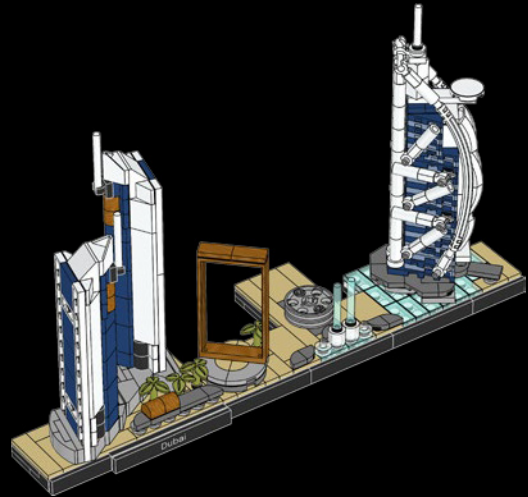
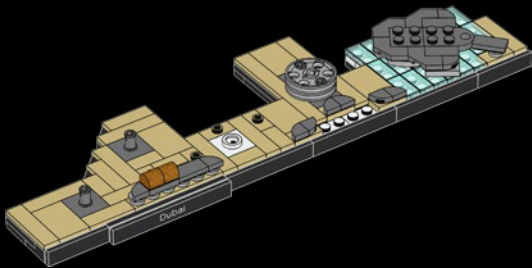

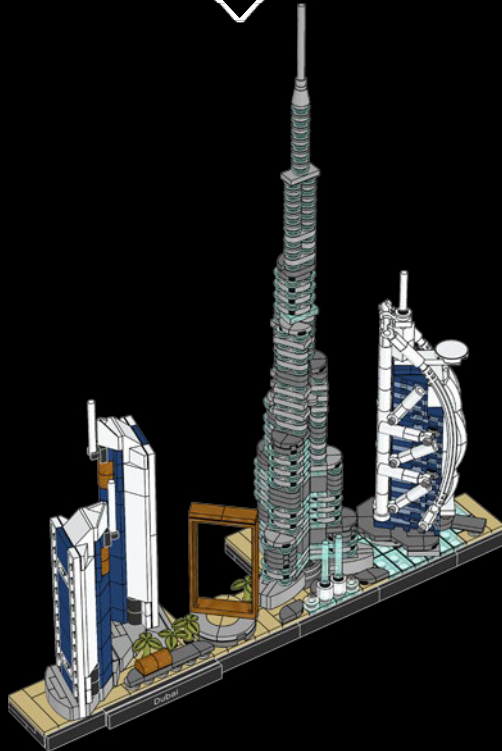

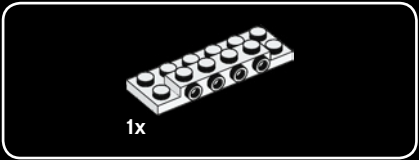

1

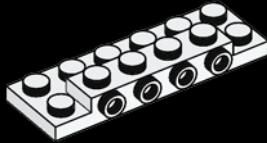
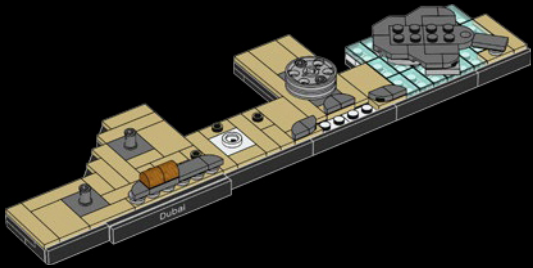

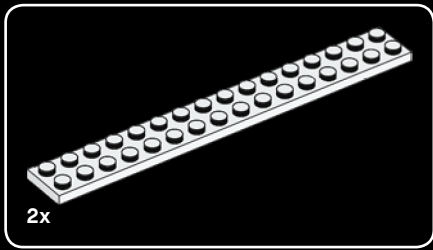

2

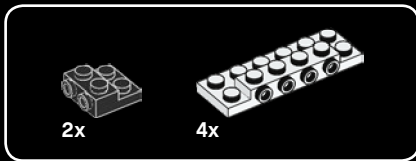
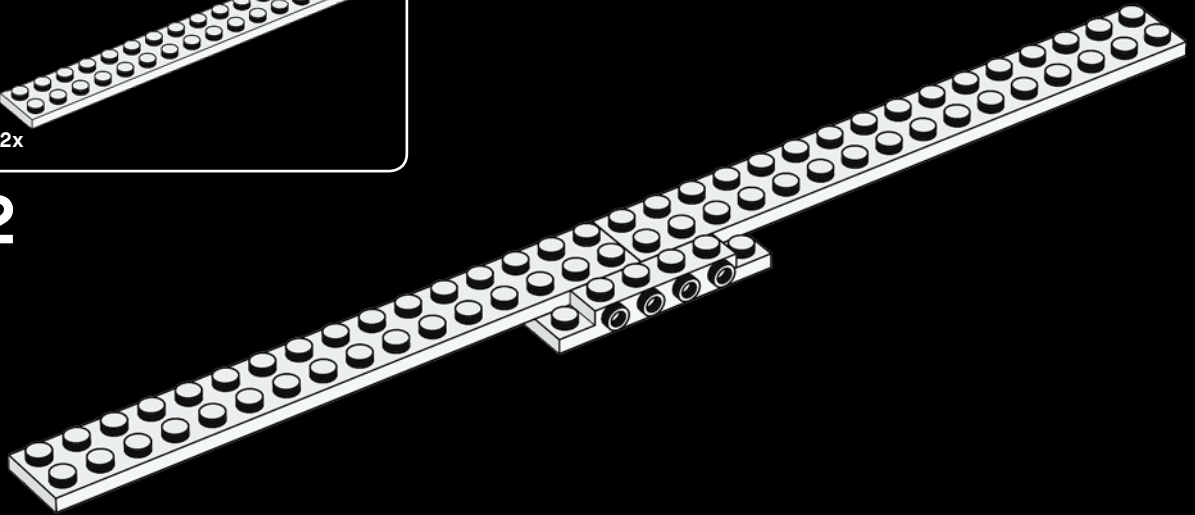

3

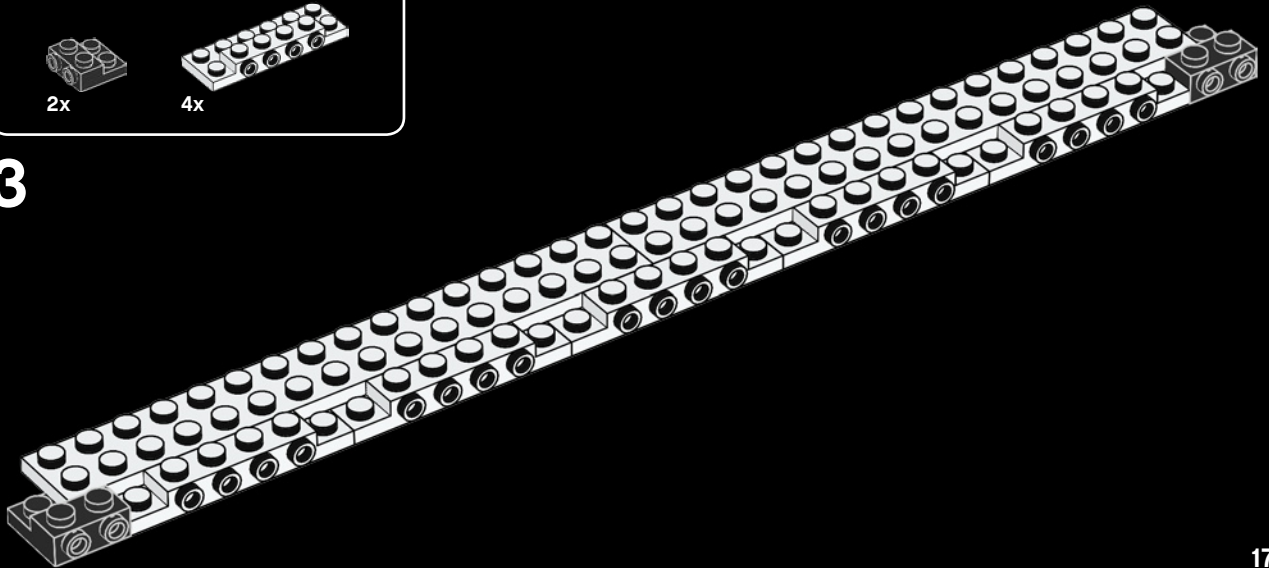

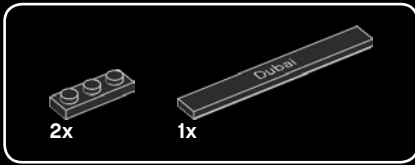

6

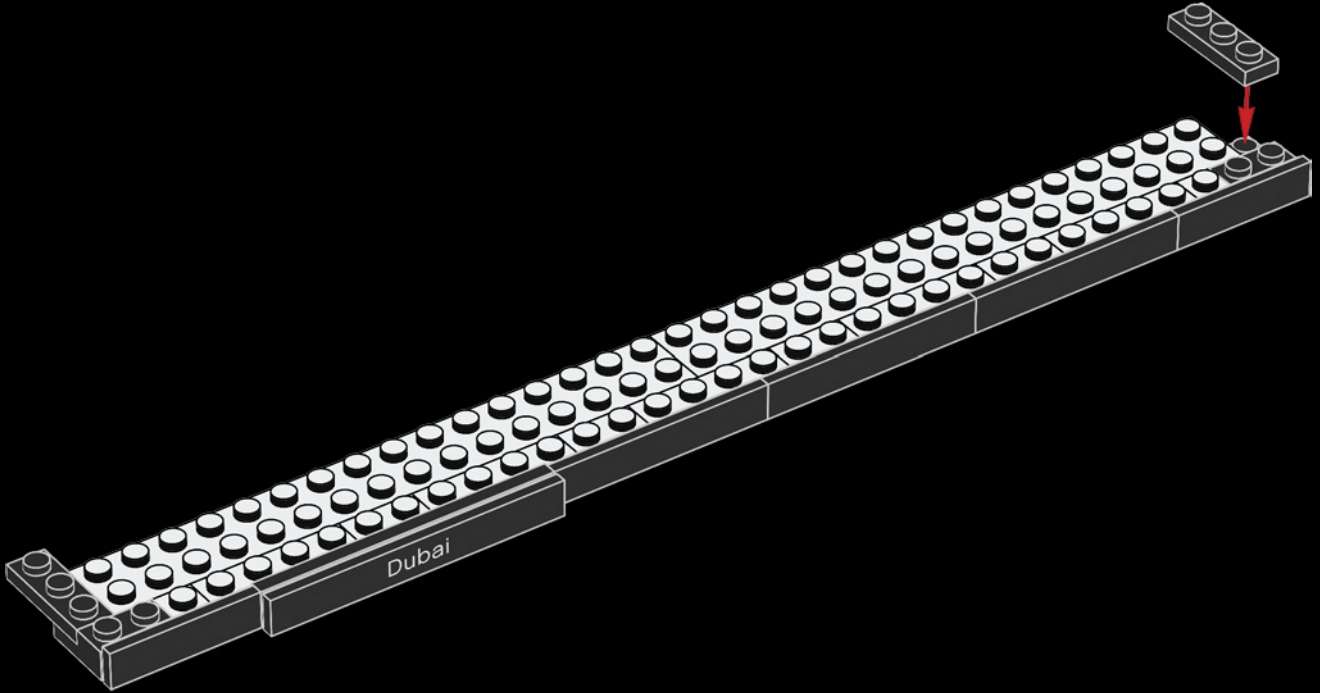

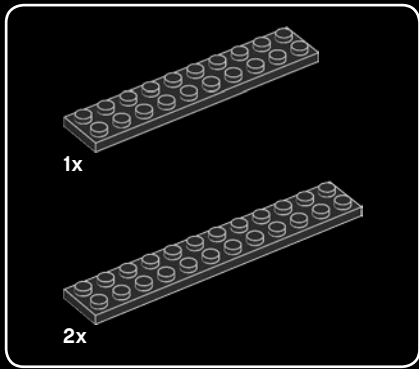

7

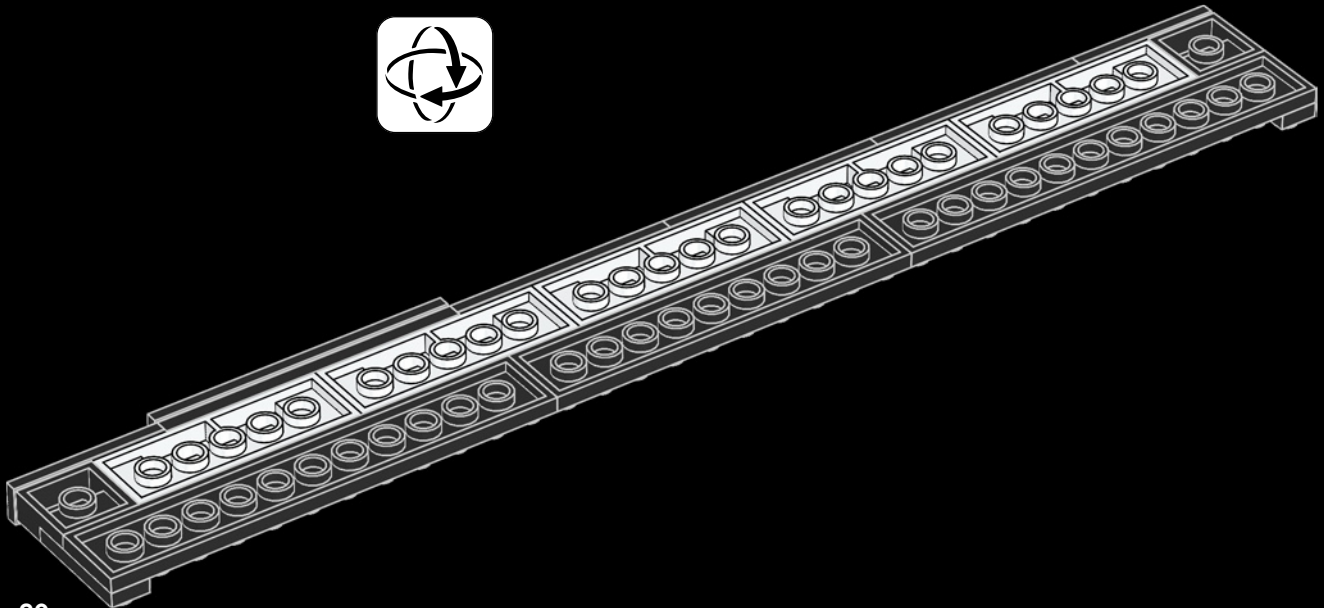

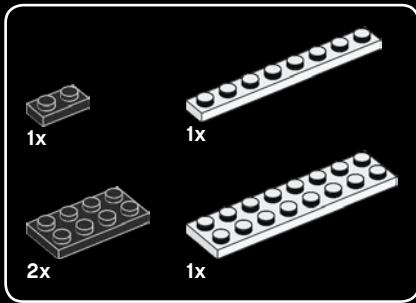

8

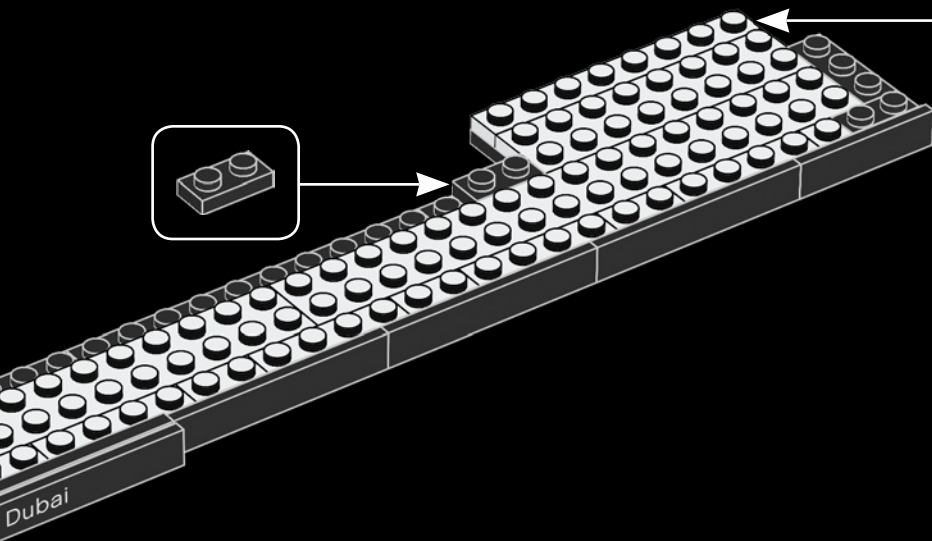
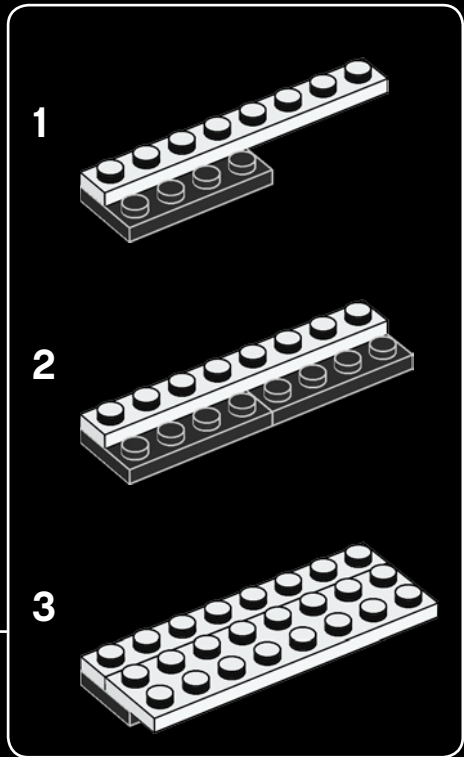

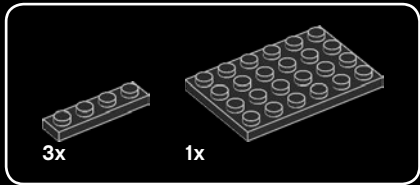

9

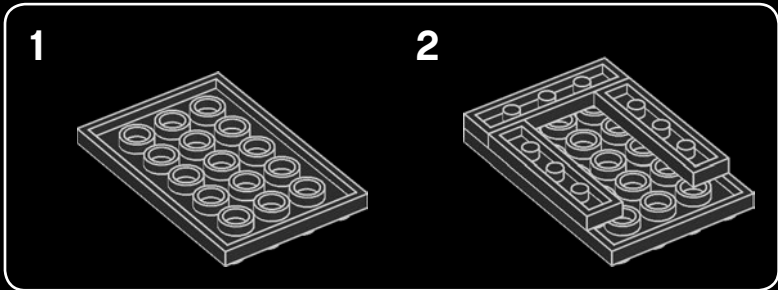

2

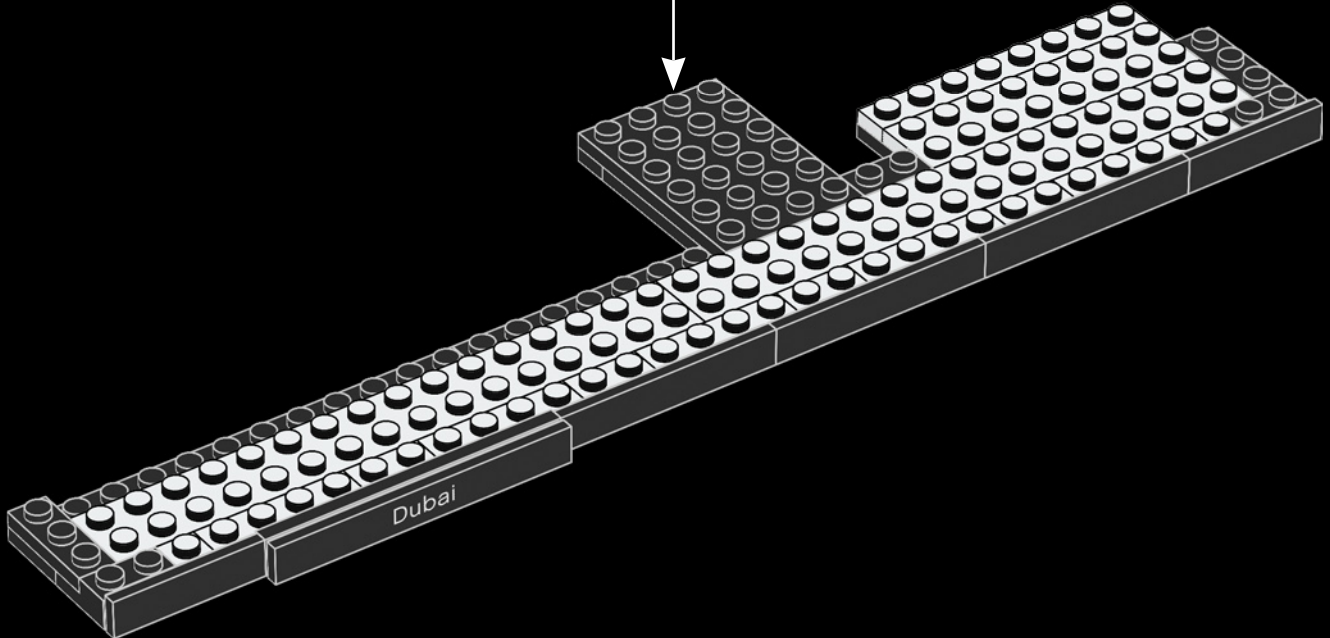
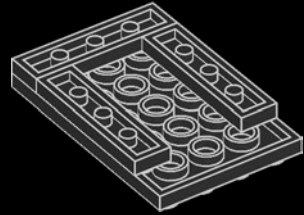

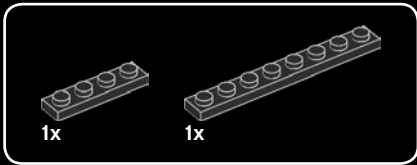

10

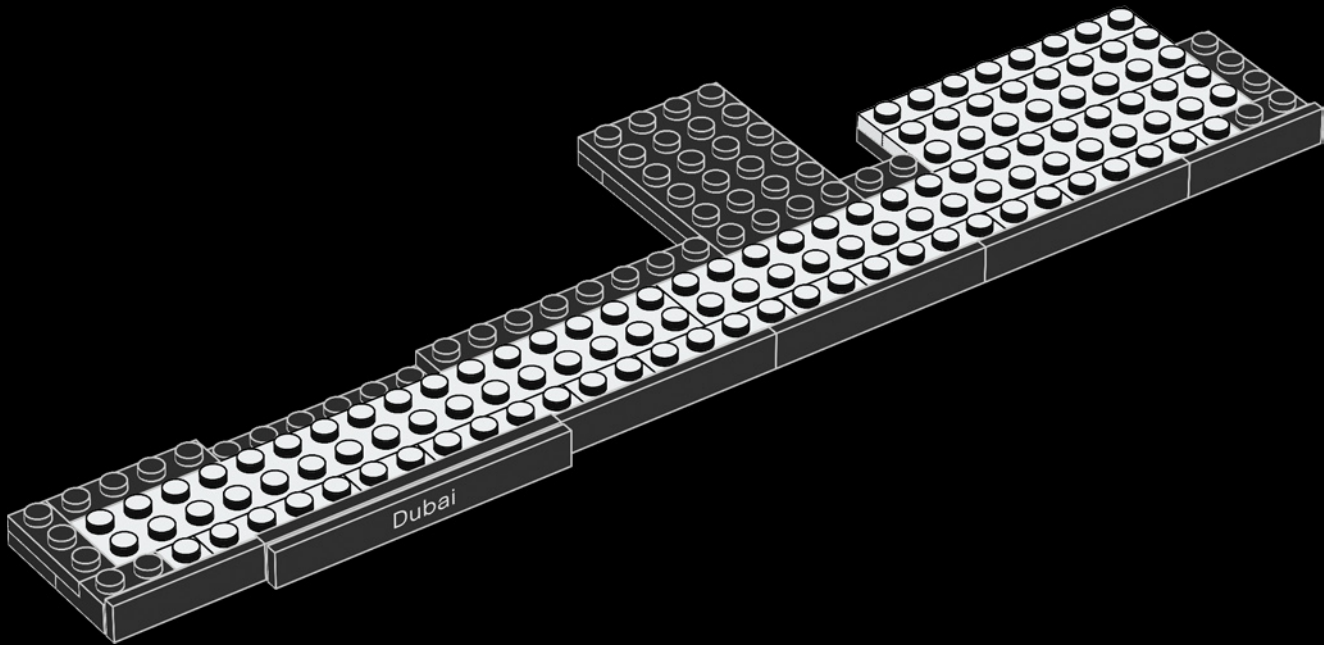

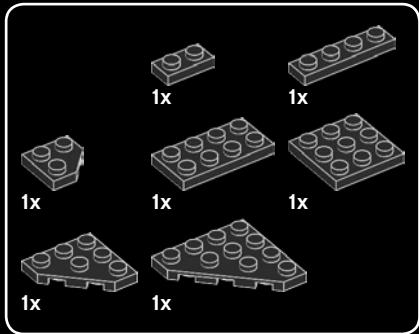

11

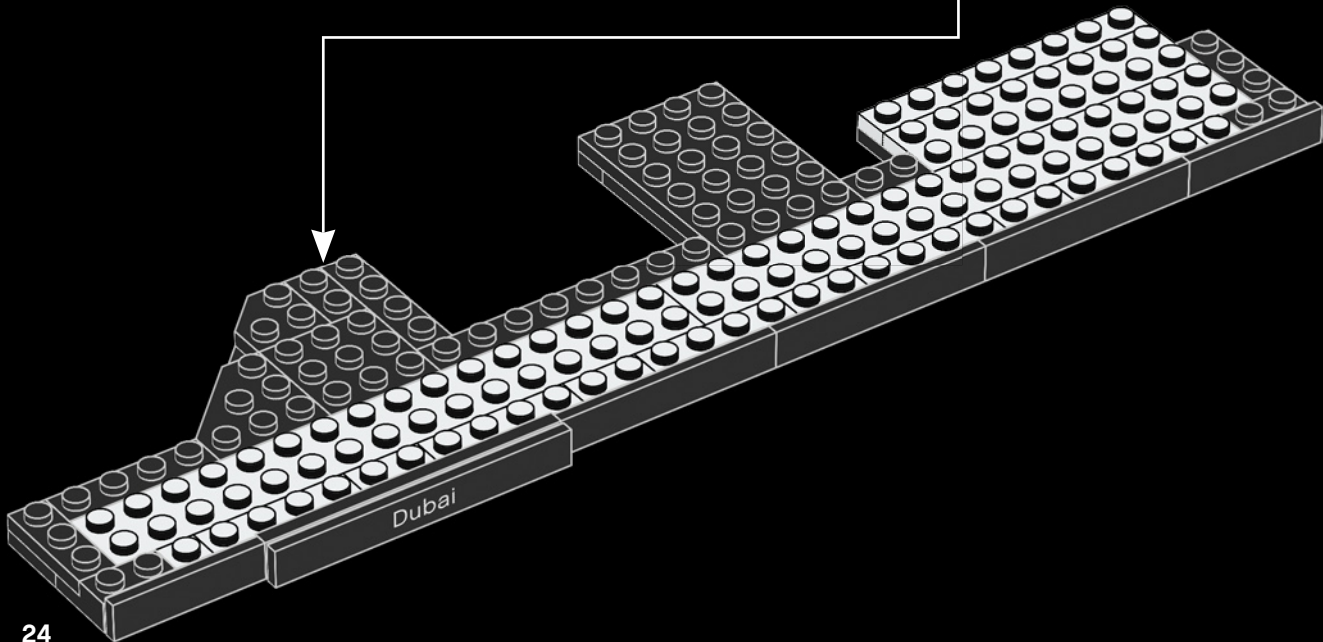
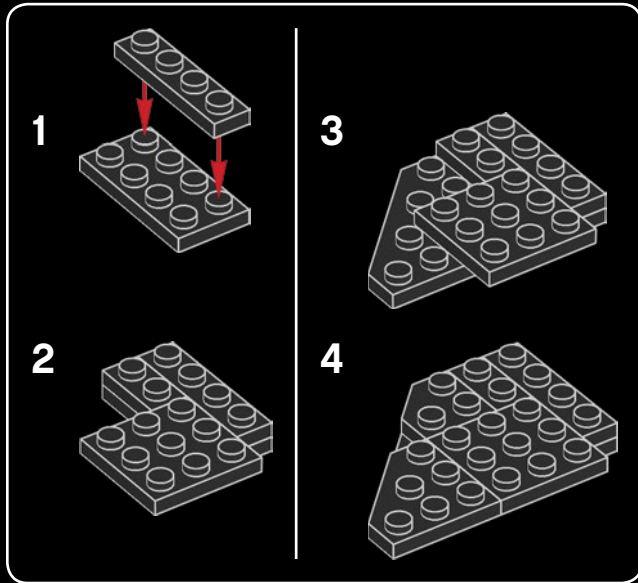

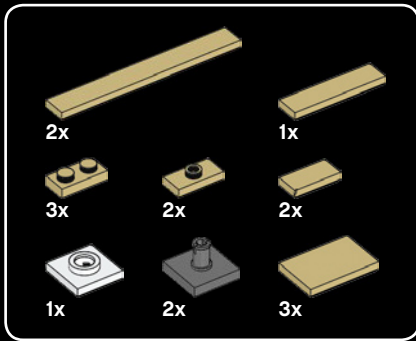

14

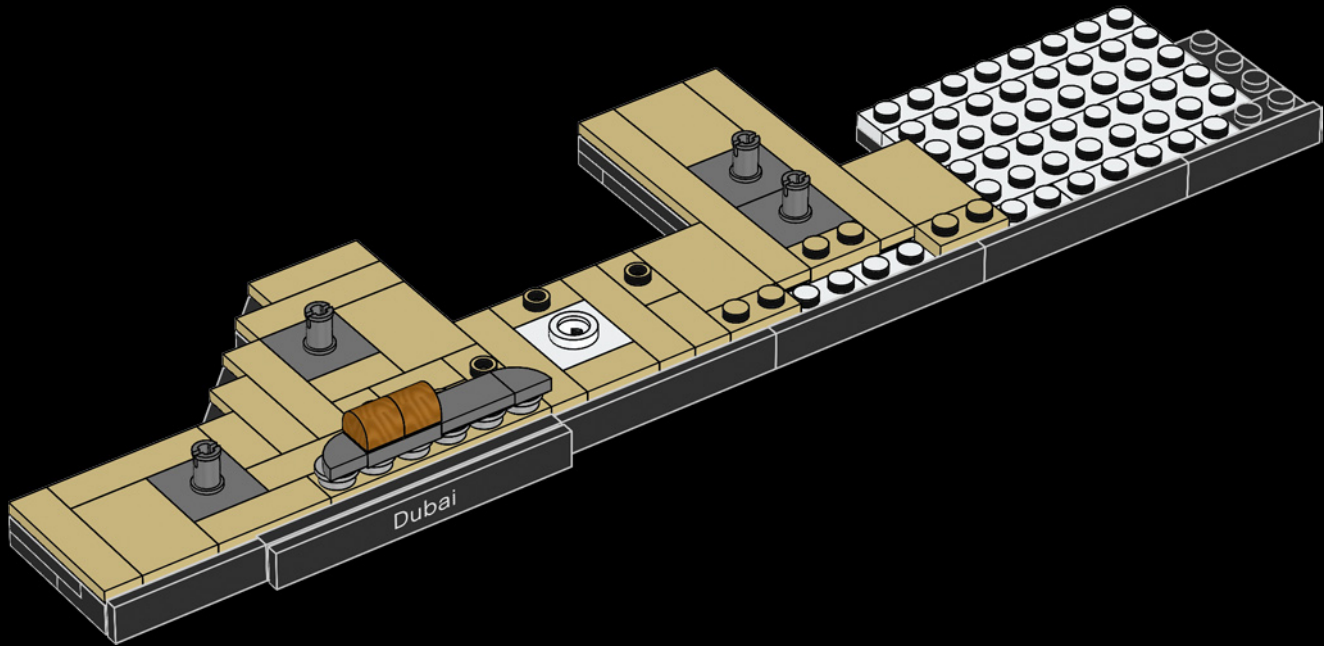



16

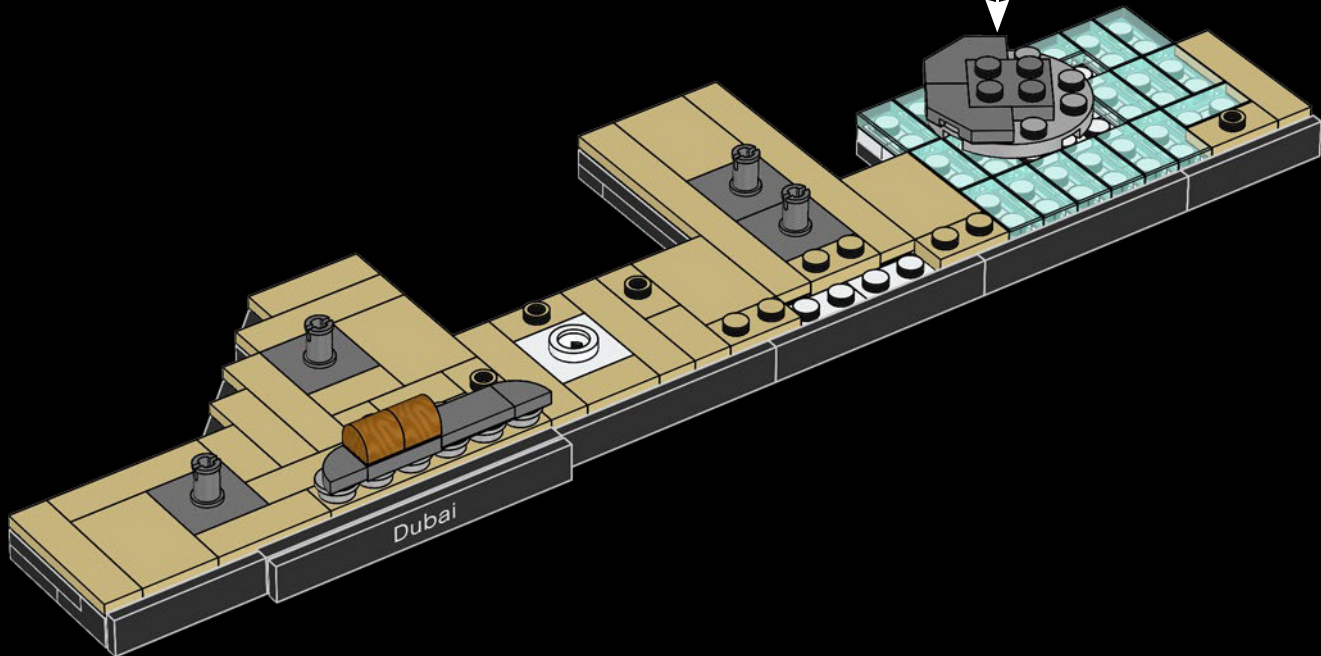
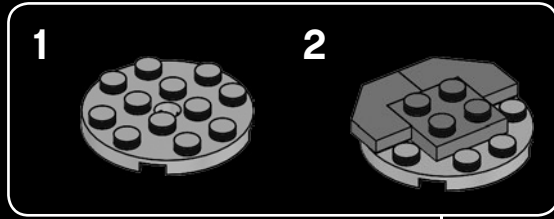

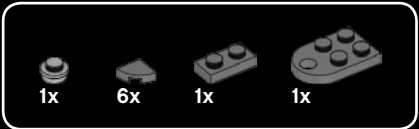

17

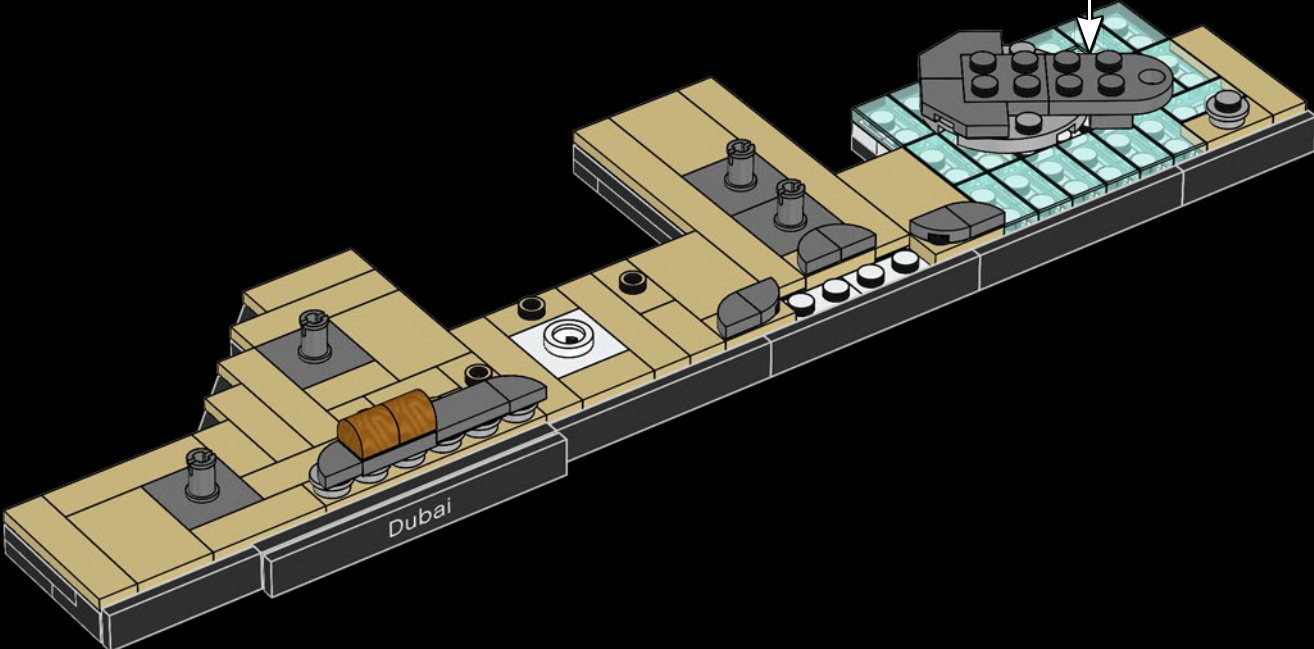
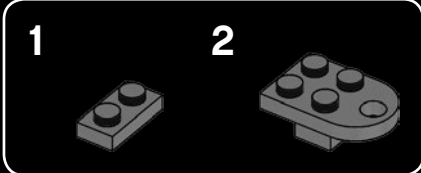

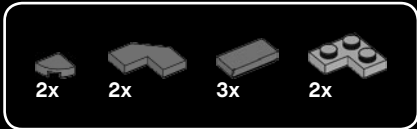

18

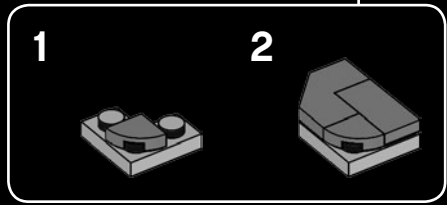
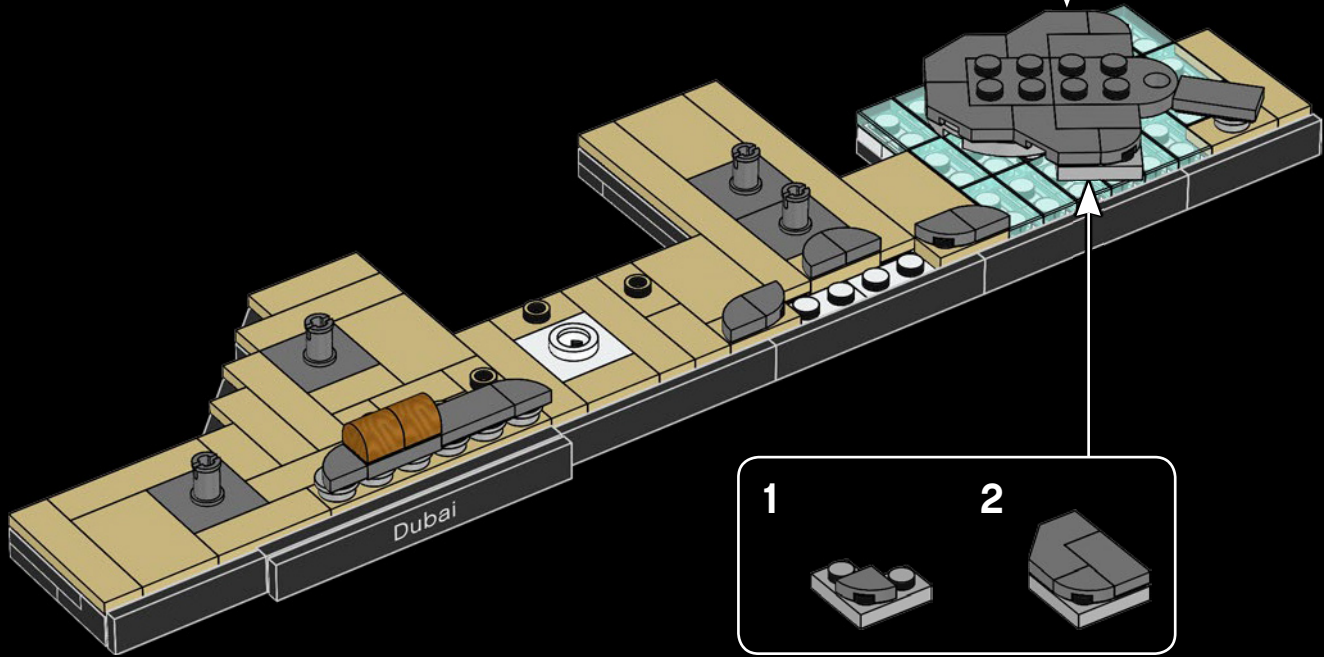
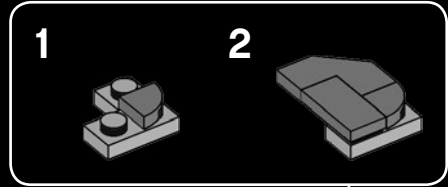



19

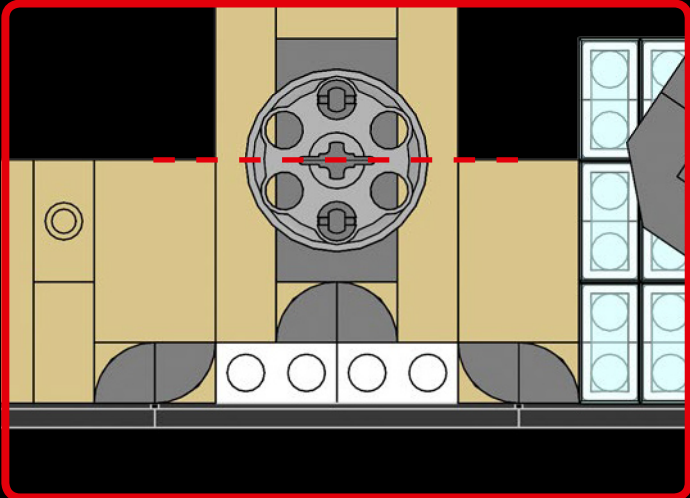
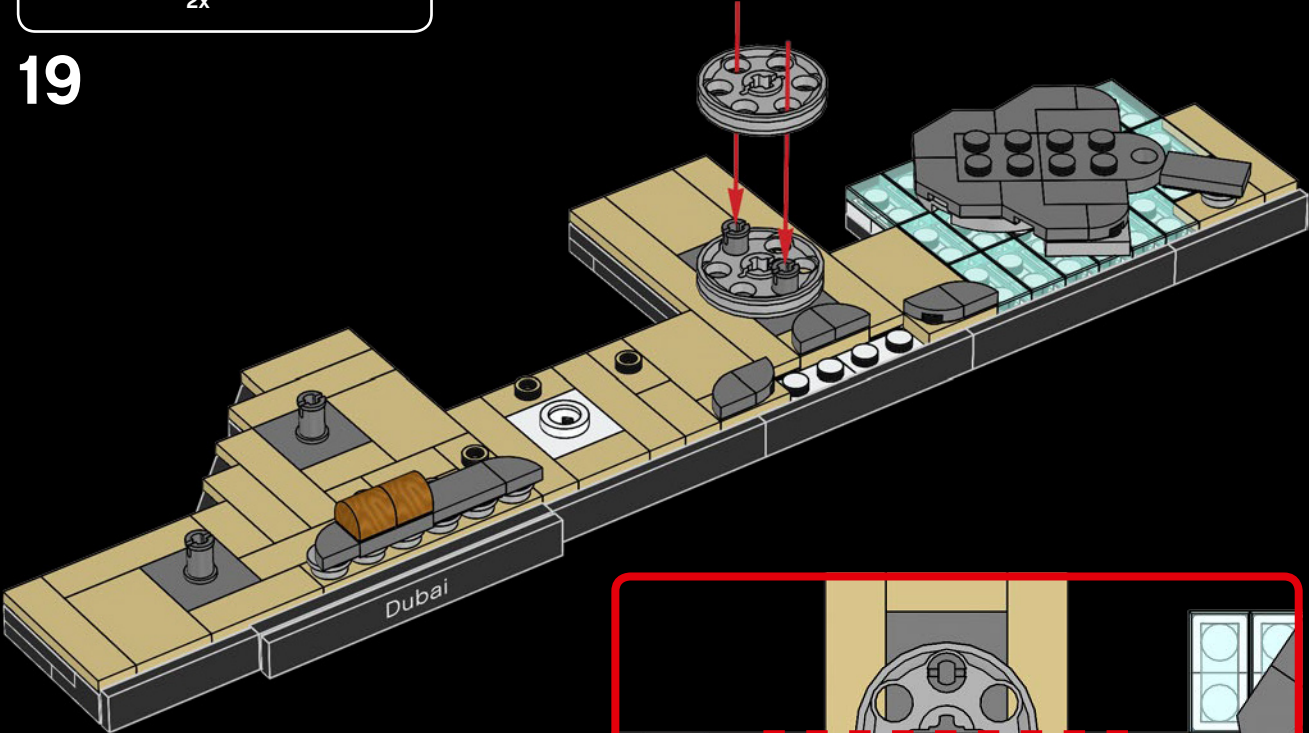

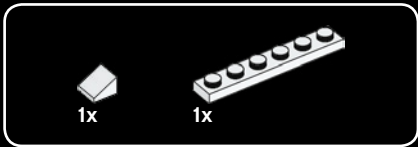
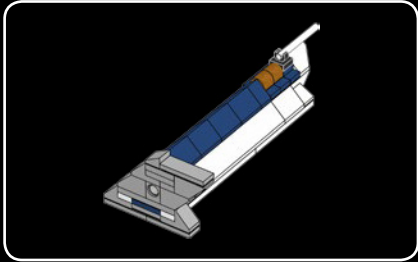
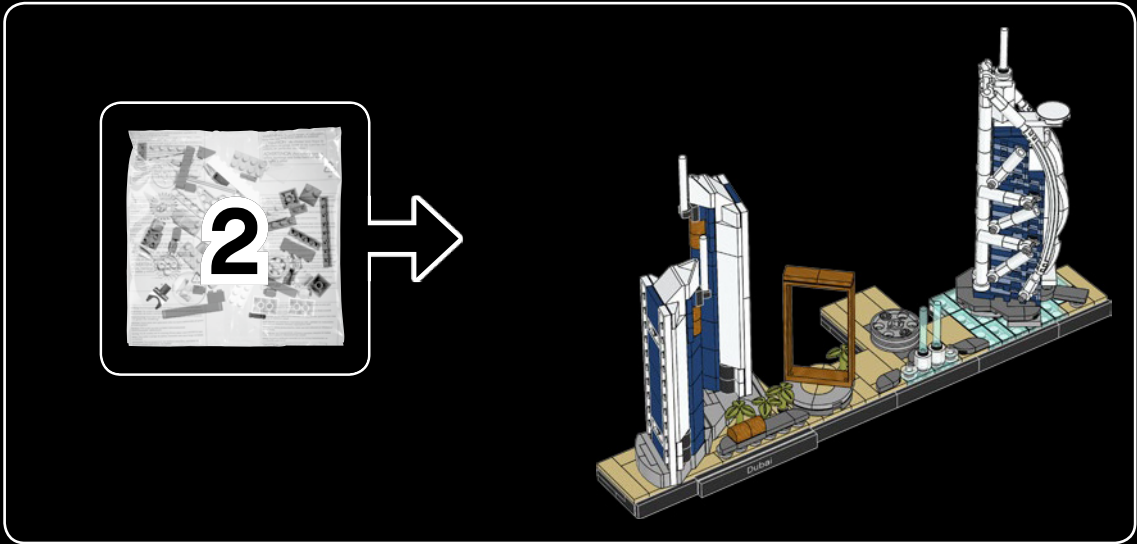

20

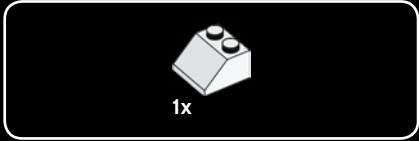
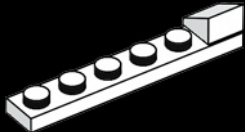

21

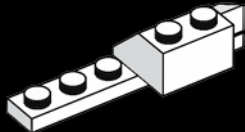

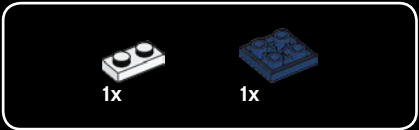

22

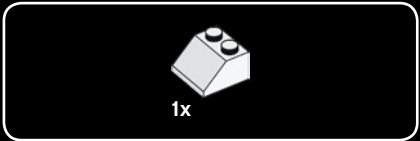
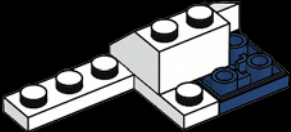

23

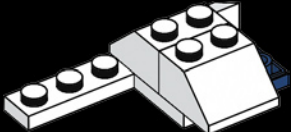

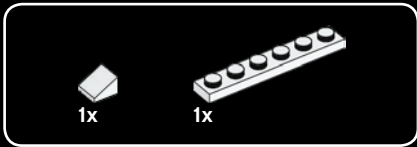

24

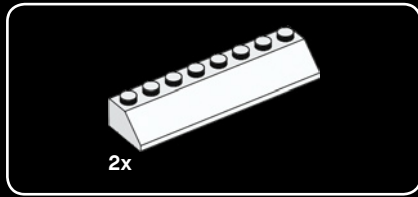
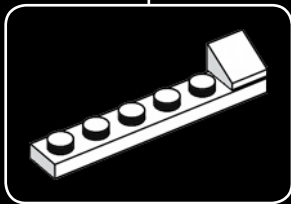
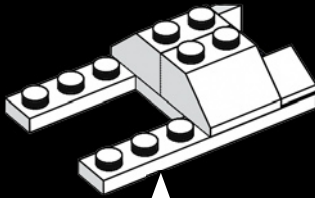

25

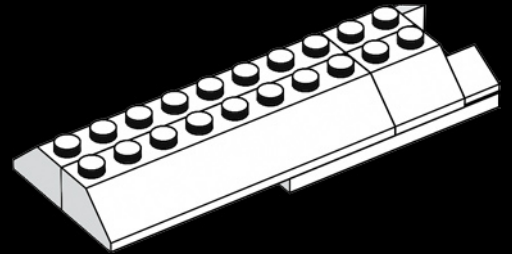

26

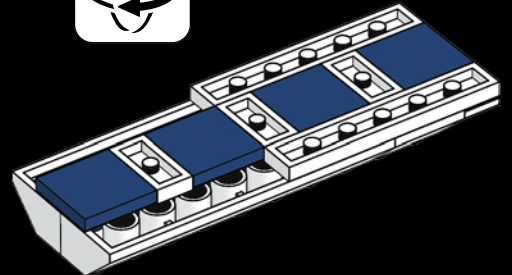

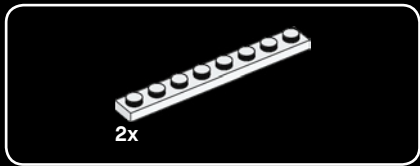

27

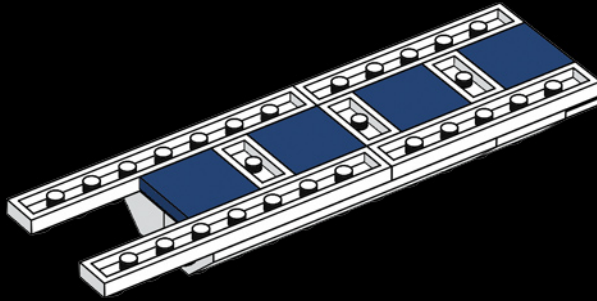

28

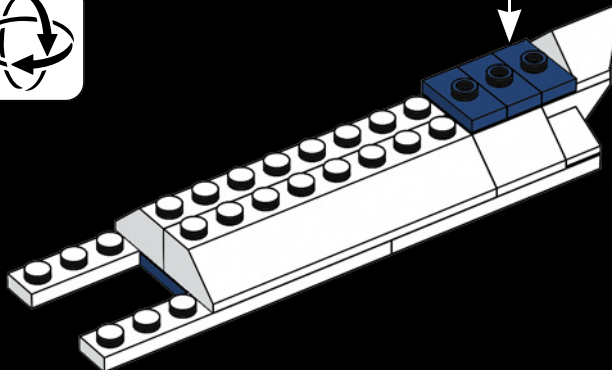
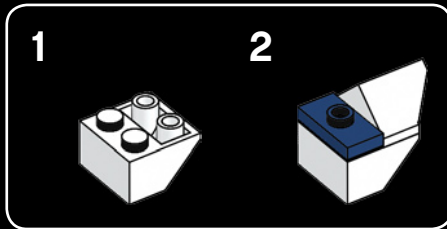



29

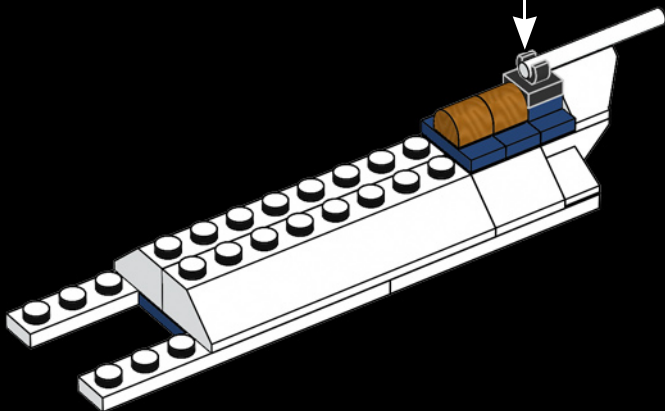
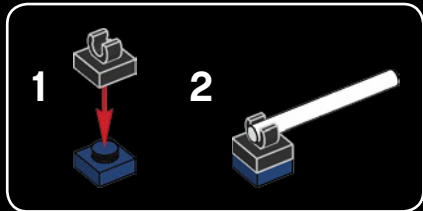



31

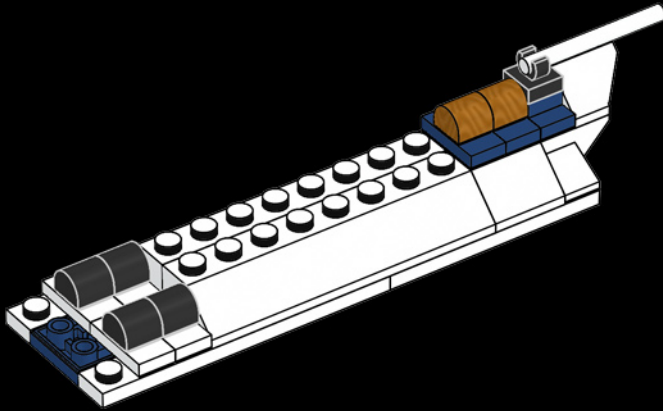

32

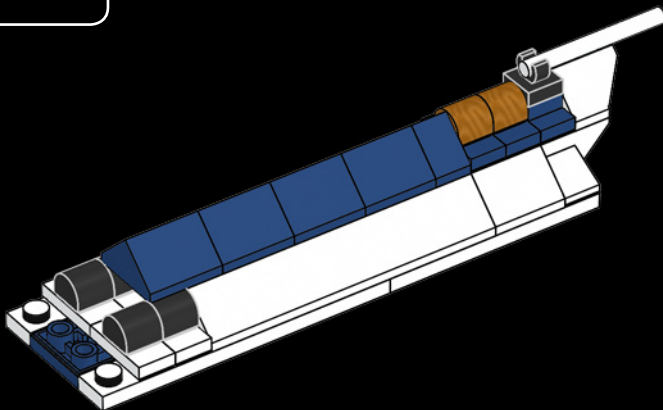

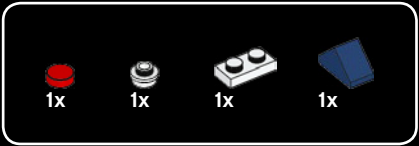

33

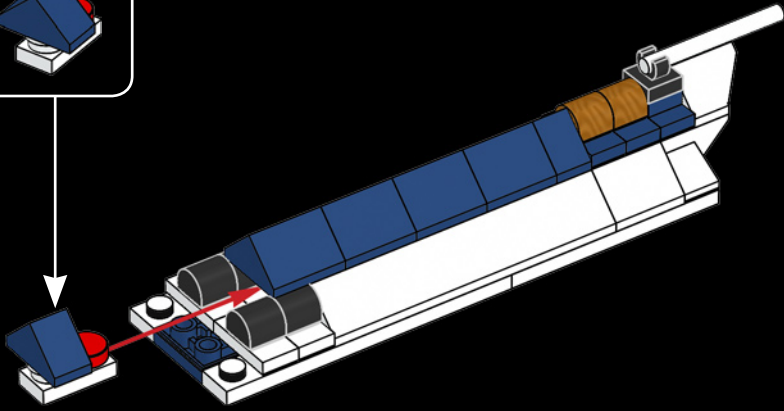
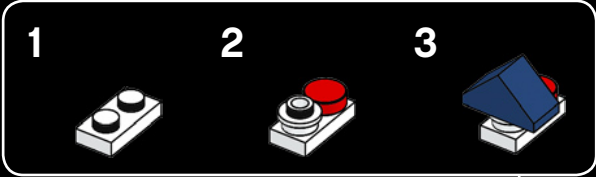

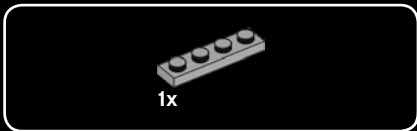

34

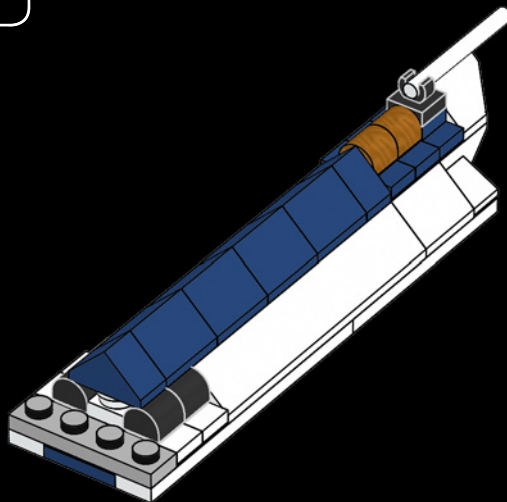

35

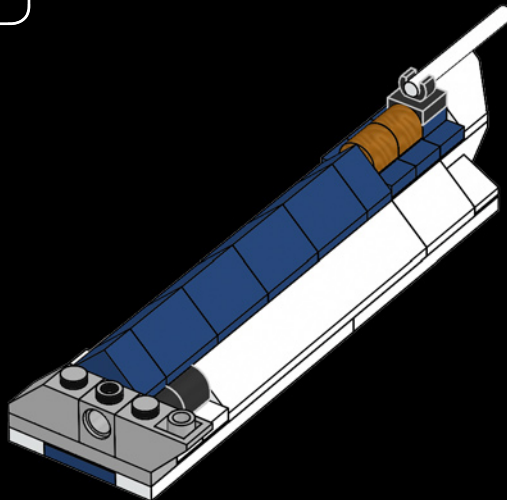



36

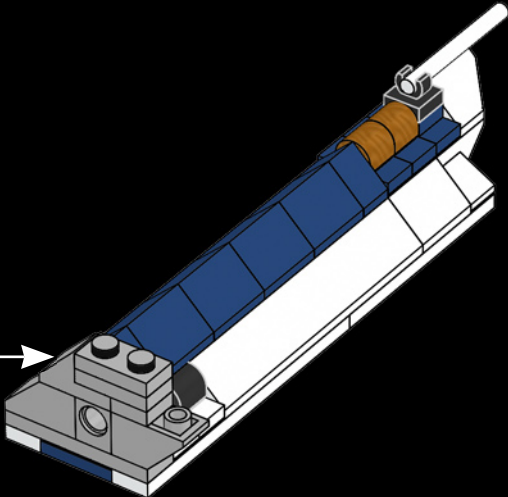
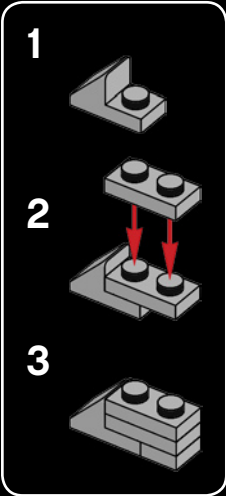

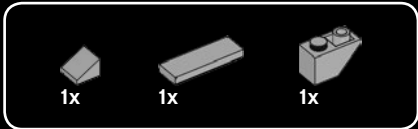

Jumeirah Emirates Towers / Les Jumeirah Emirates Towers /
Torres Jumeirah Emirates

The tallest of the two towers is 1,014 ft. (309m) in height.

La plus haute des deux tours mesure 309 m de haut.

La más alta de las dos torres mide 309 m de altura.



37

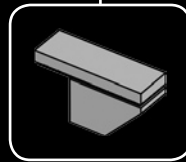
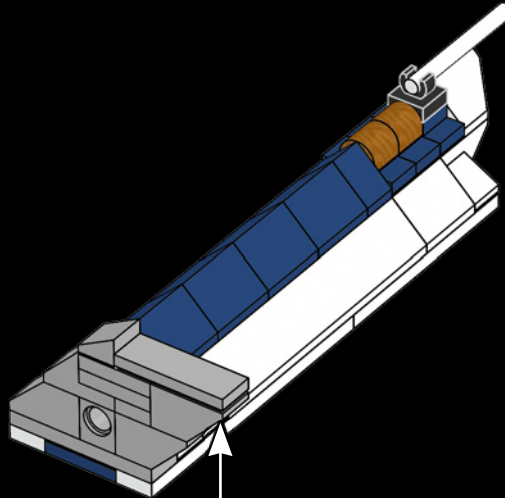

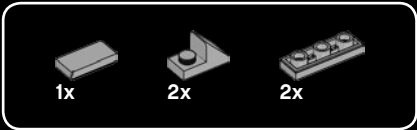

38

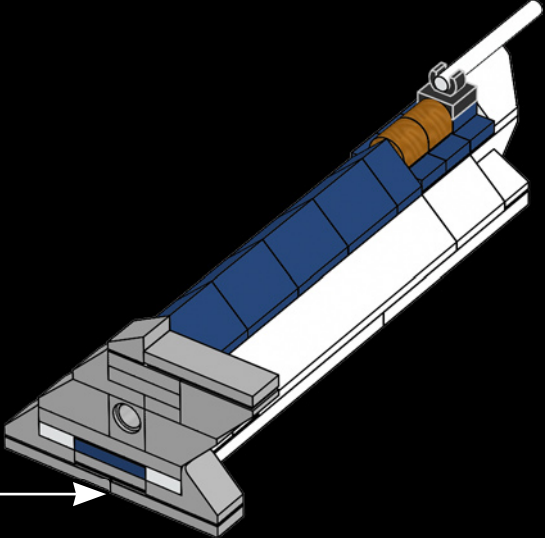
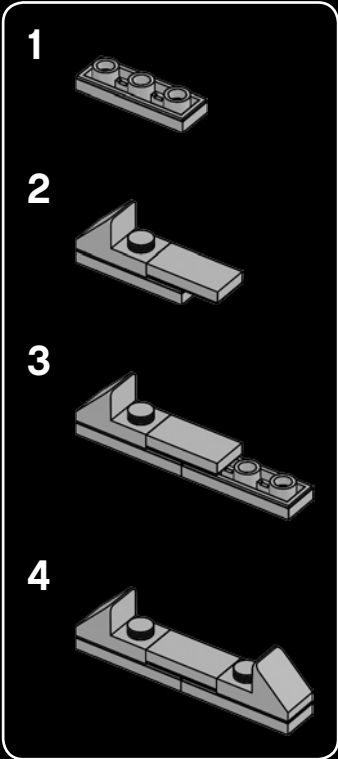

39

Jumeirah Emirates Towers / Les Jumeirah Emirates Towers /
Torres Jumeirah Emirates

The elevators in the 98 ft. (30m) high hotel atrium move at
13 ft. (4 meters) per second.

Les ascenseurs de l'atrium de l'hôtel situé à une hauteur de
30 m se déplacent à une vitesse de quatre mètres par seconde.

Los elevadores del atrio del hotel, a 30 m de altura,
se mueven a 4 m/s.

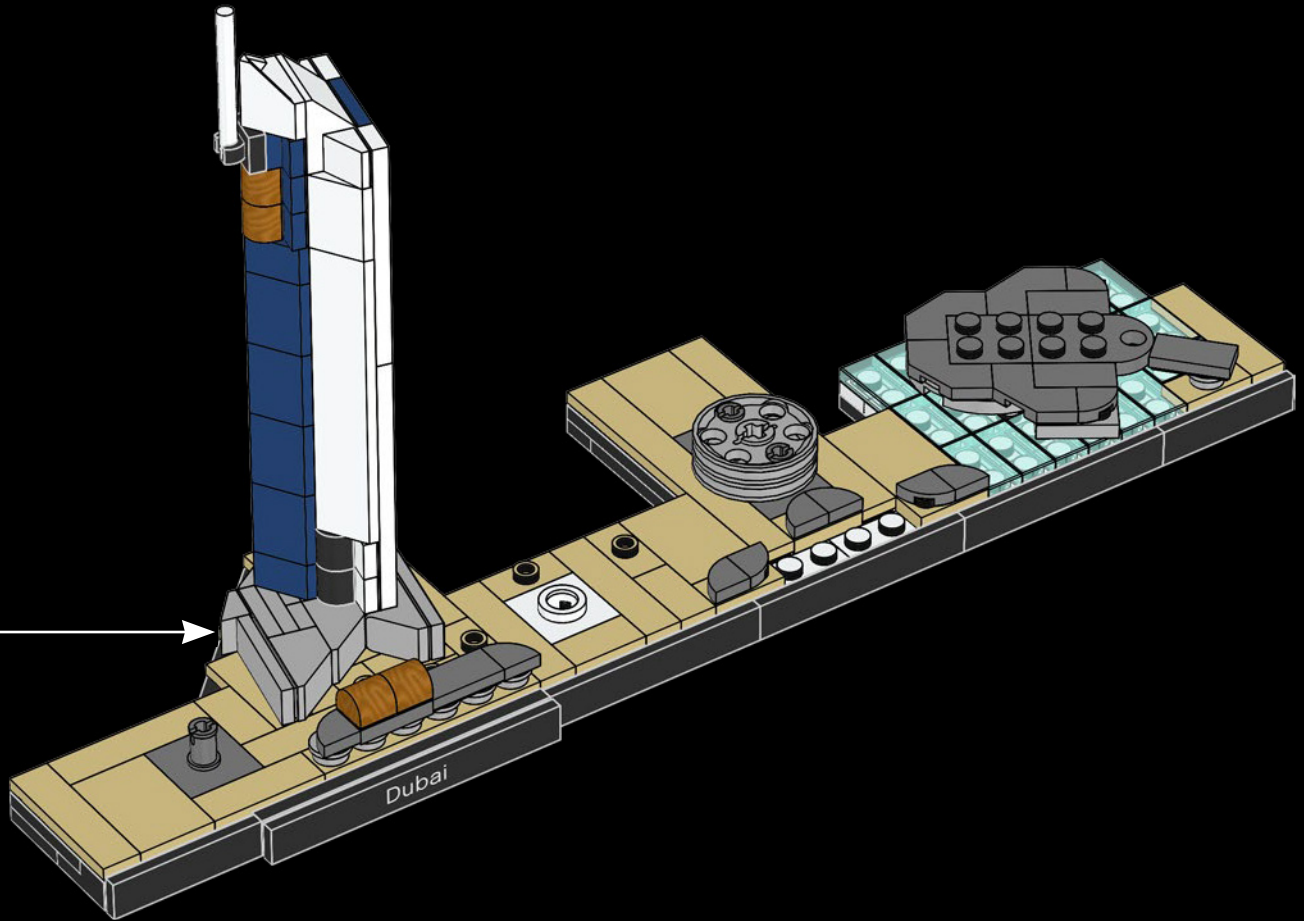

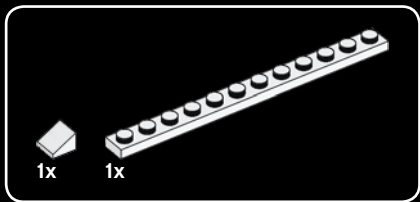
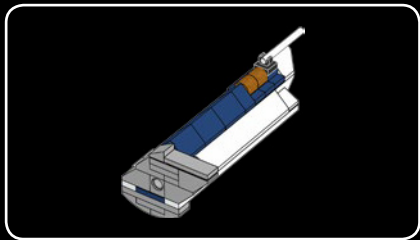

40

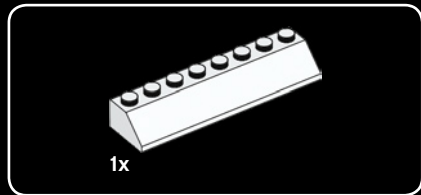
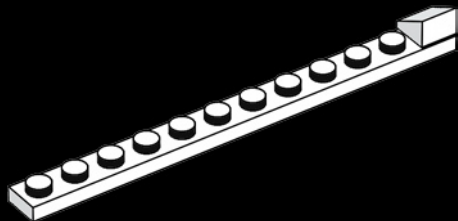

41

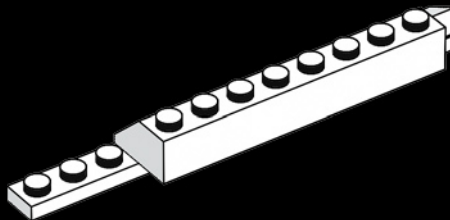

42

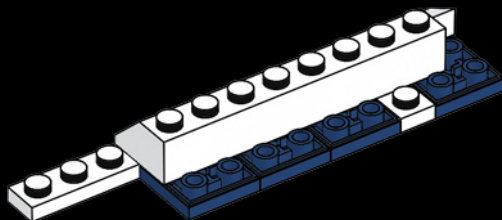

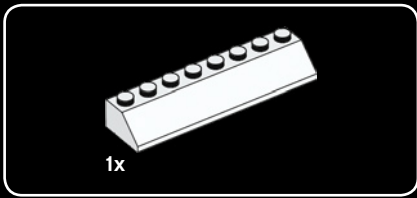

43

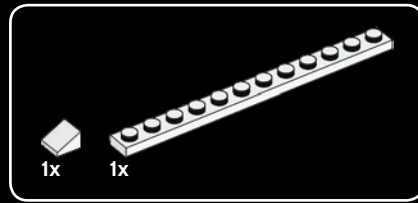
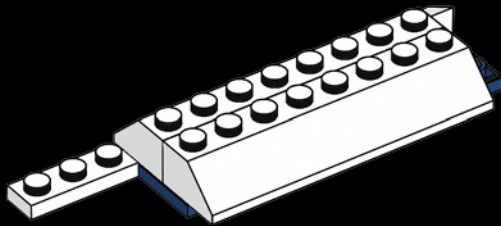

44

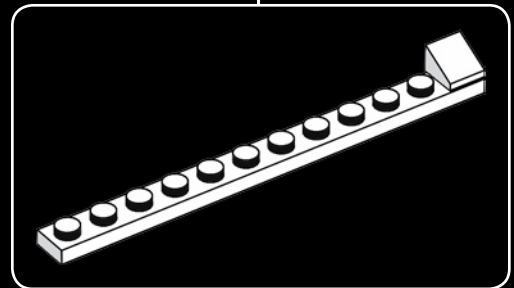
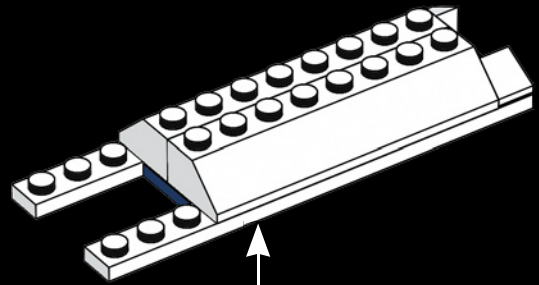



45

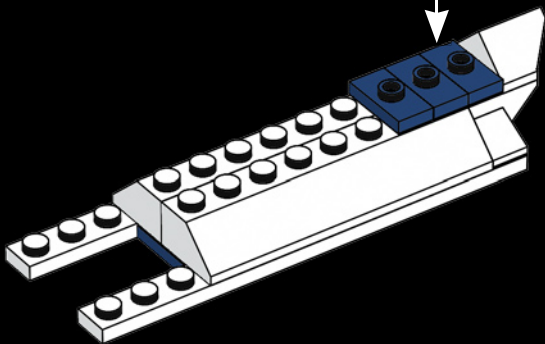
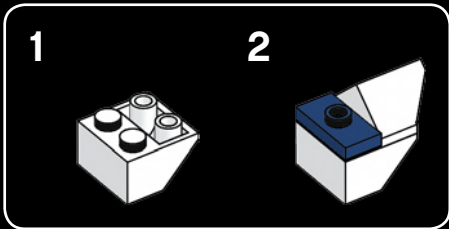

46

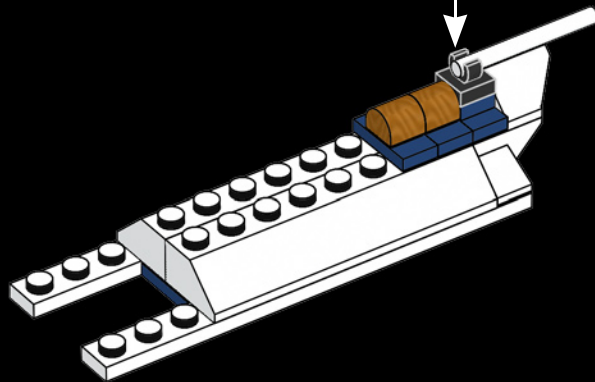
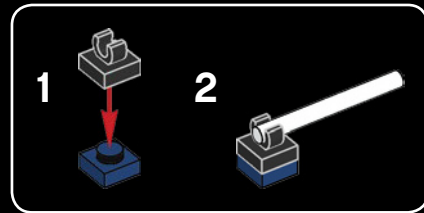



47

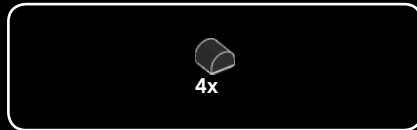
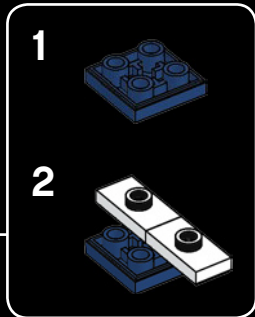
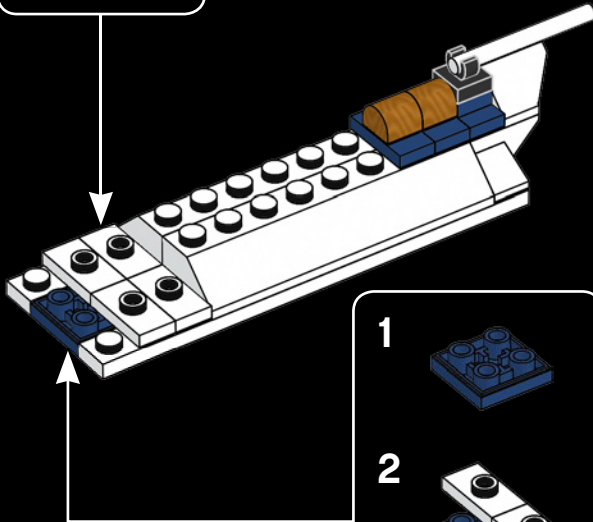
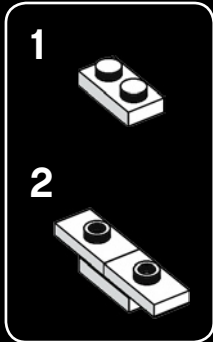

48

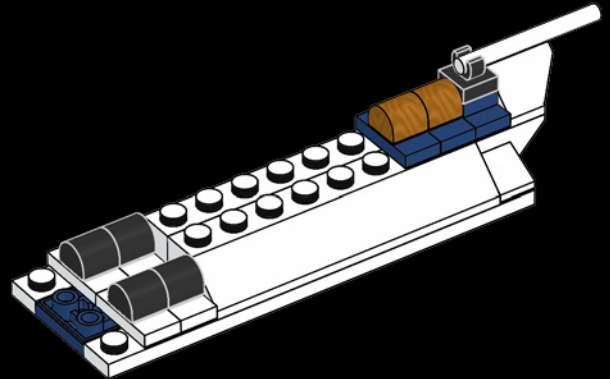

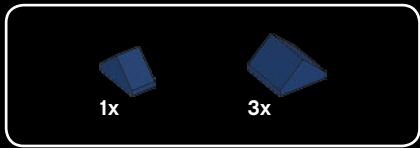

49

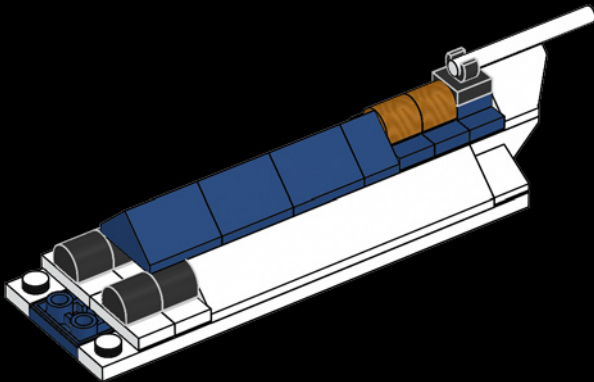

50

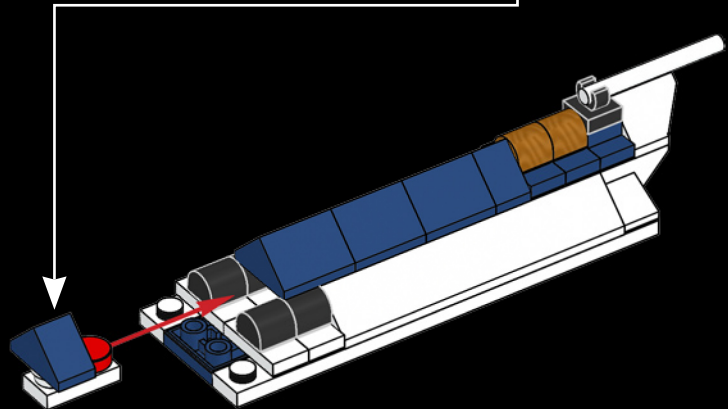
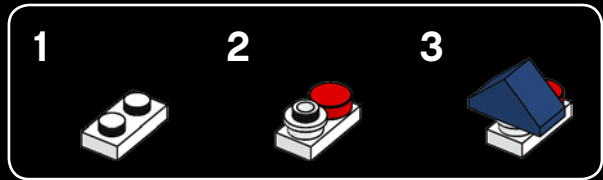

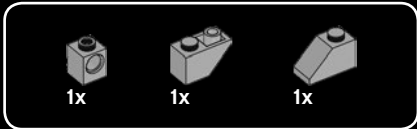

51

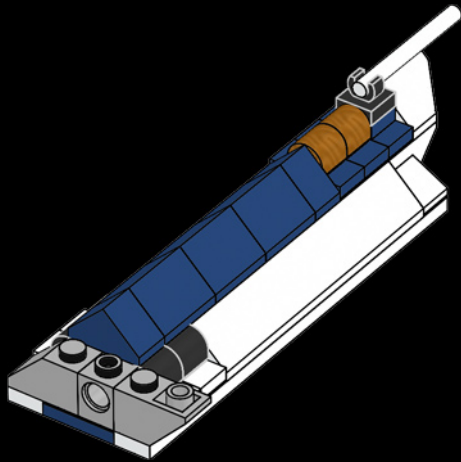

52

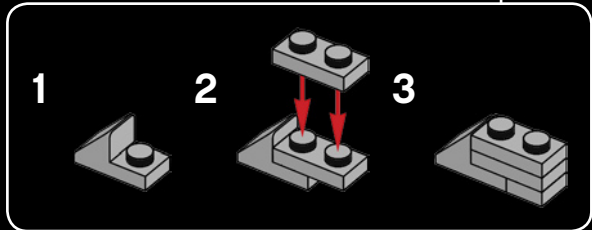
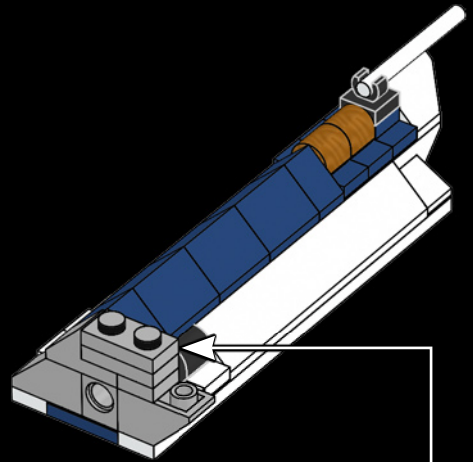

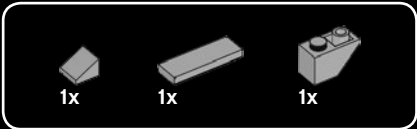

53

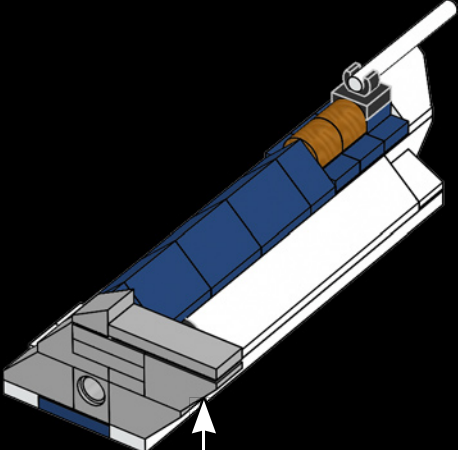

54

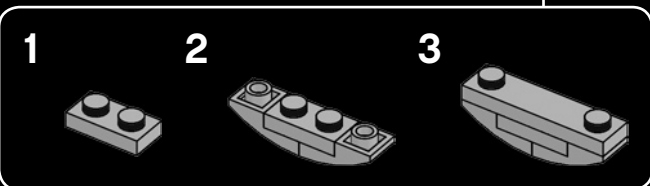
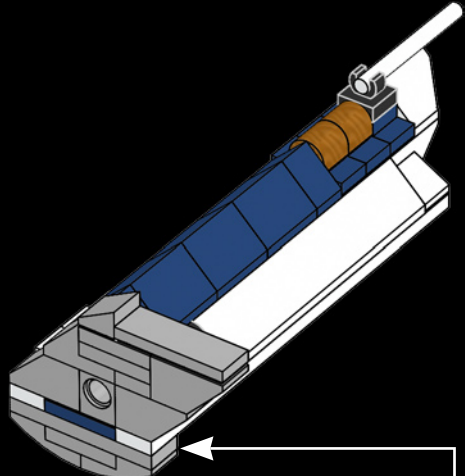

55

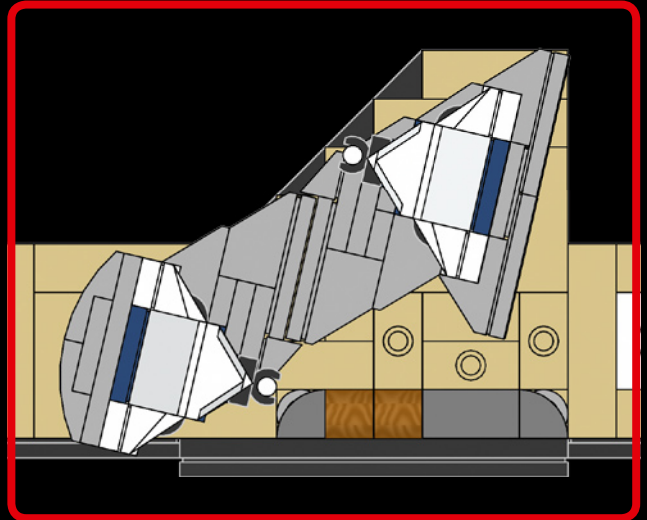
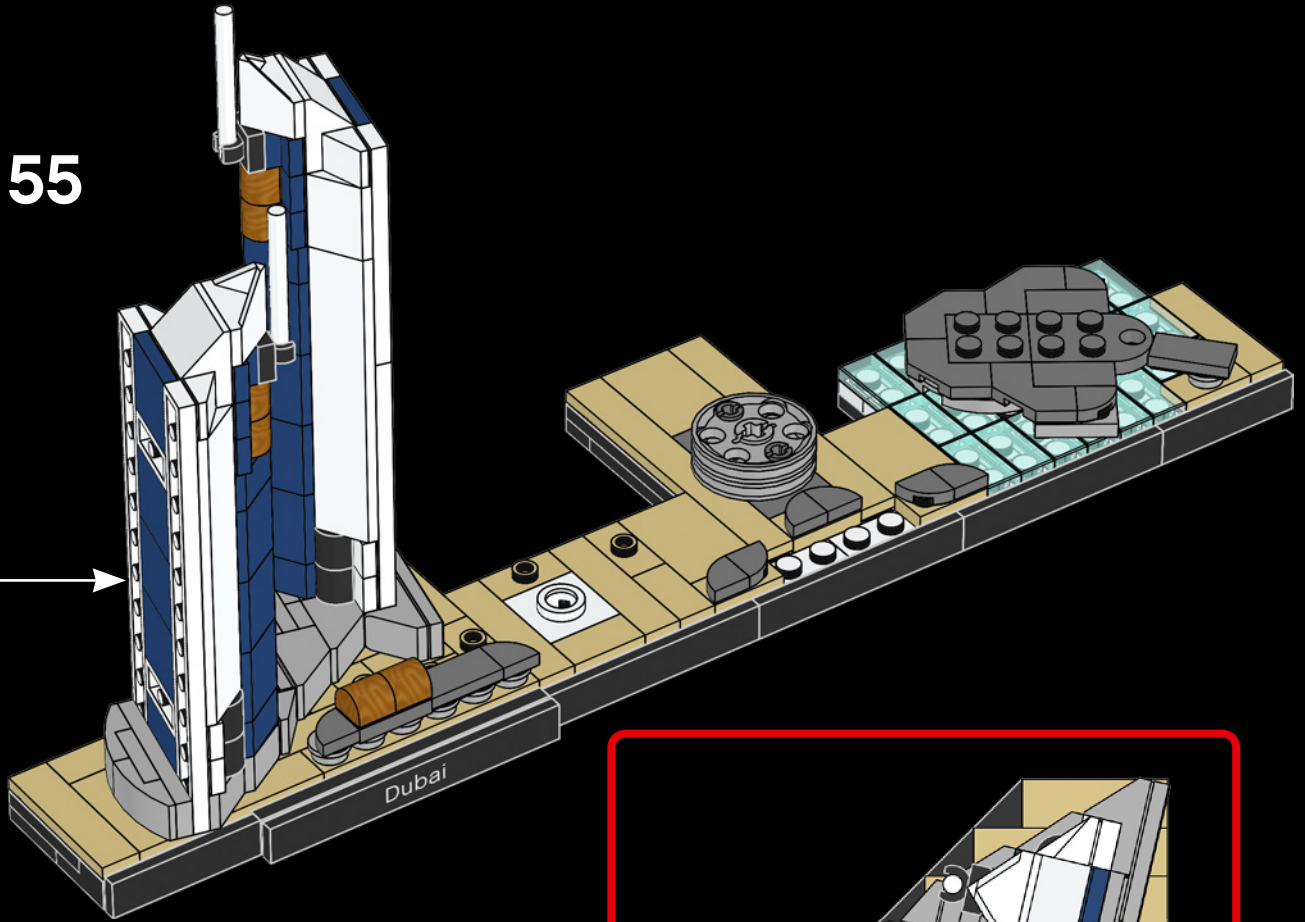

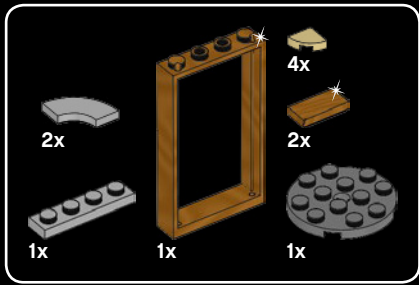

56

1



2



3



4



Dubai Frame / Le Dubaï Frame / Marco de Dubái

It's expected that up to 2 million tourists will visit the Dubai Frame every year.

Selon les prévisions, près de deux millions de touristes visiteront le Dubaï Frame chaque année.

Se espera que hasta dos millones de turistas visiten el Marco de Dubái cada año.

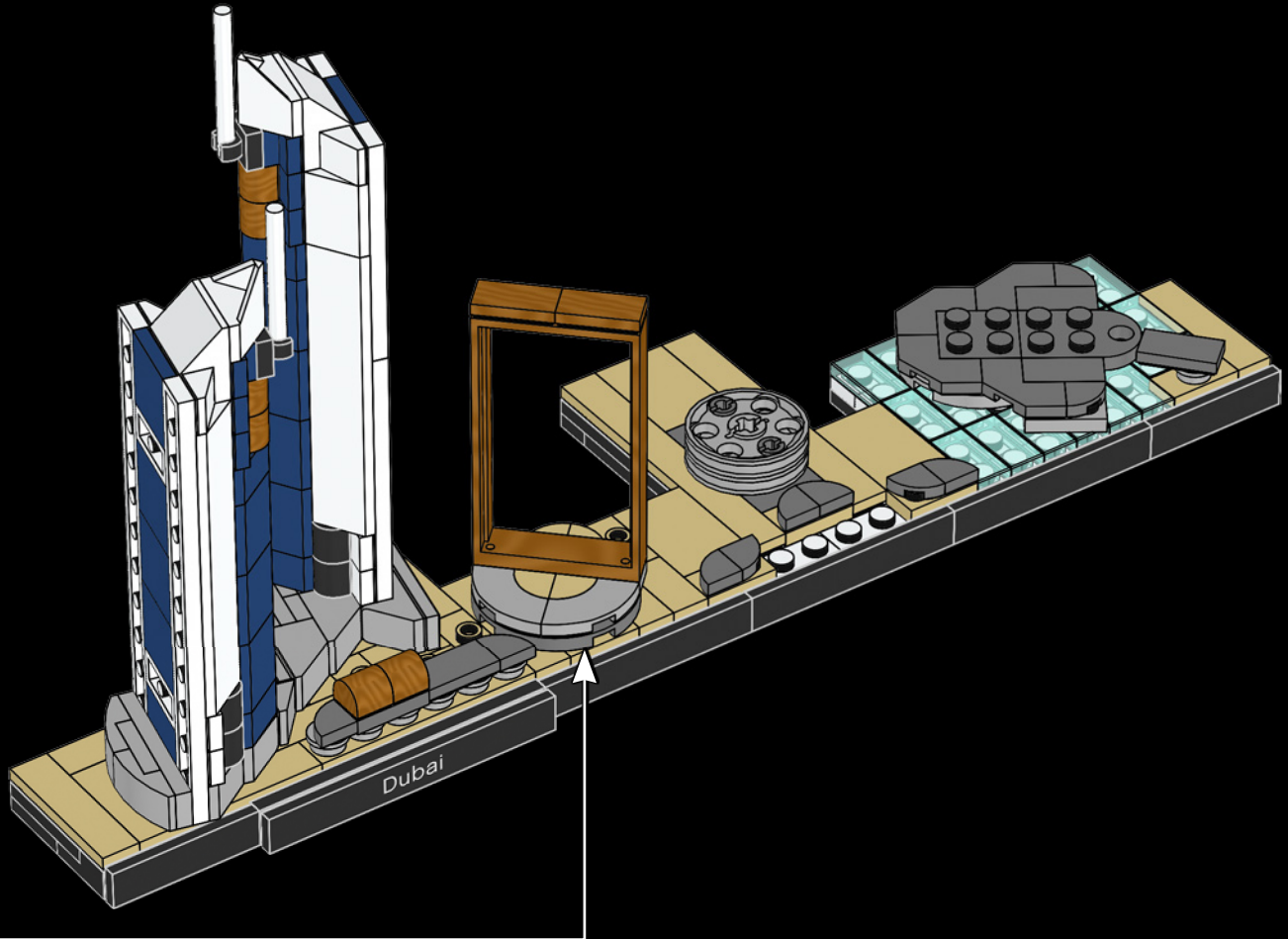



4x

57

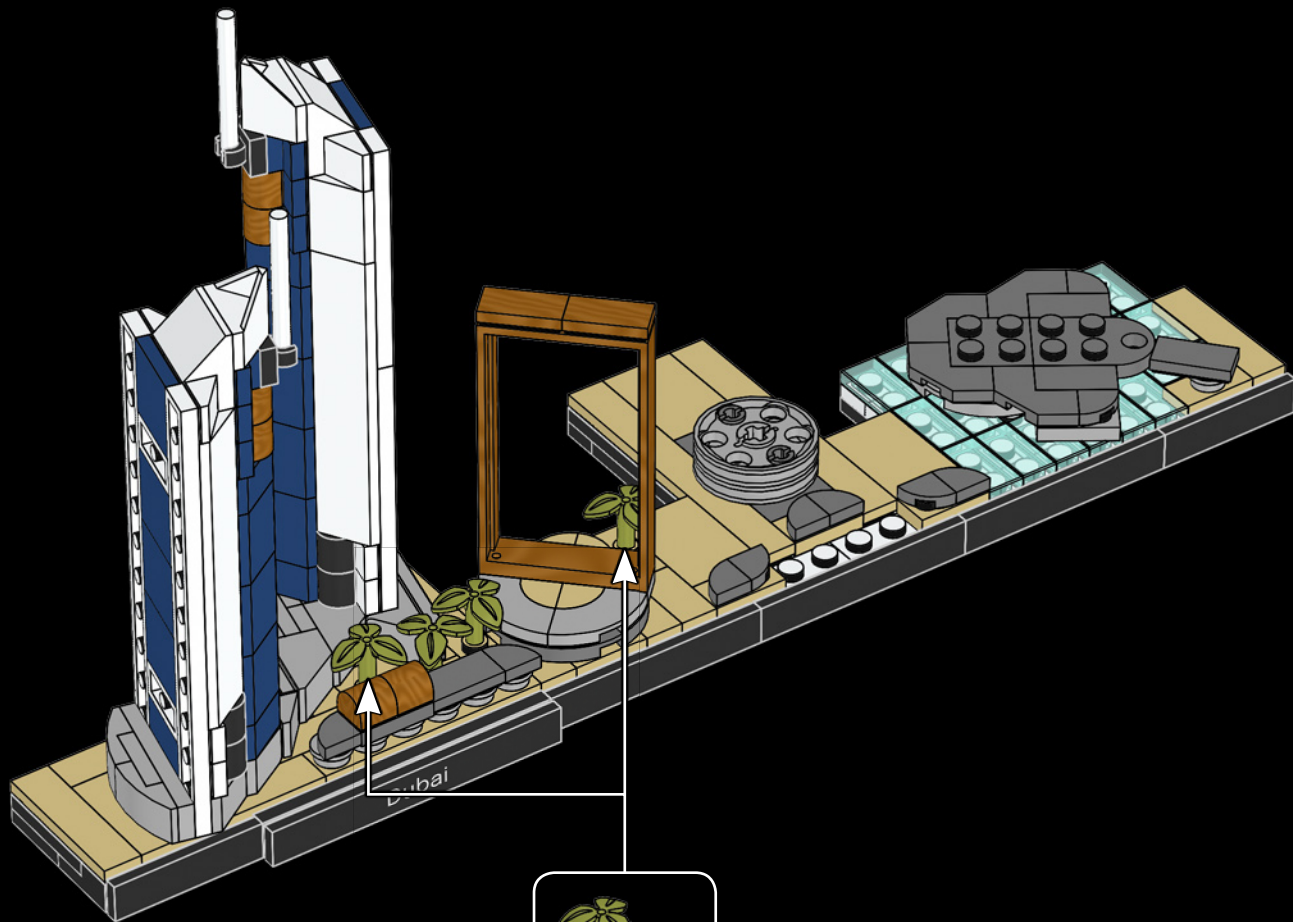

4x

Dubai Frame / Le Dubaï Frame / Marco de Dubái

More than 161, 458 sq. ft. (15,000m²) of gold-colored stainless steel covers the Dubai Frame.

Plus de 15 000 m² d'acier inoxydable doré recouvrent le Dubaï Frame.

Más de 15,000 m² de acero inoxidable dorado cubren el Marco de Dubái.

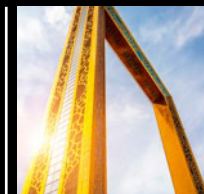



58

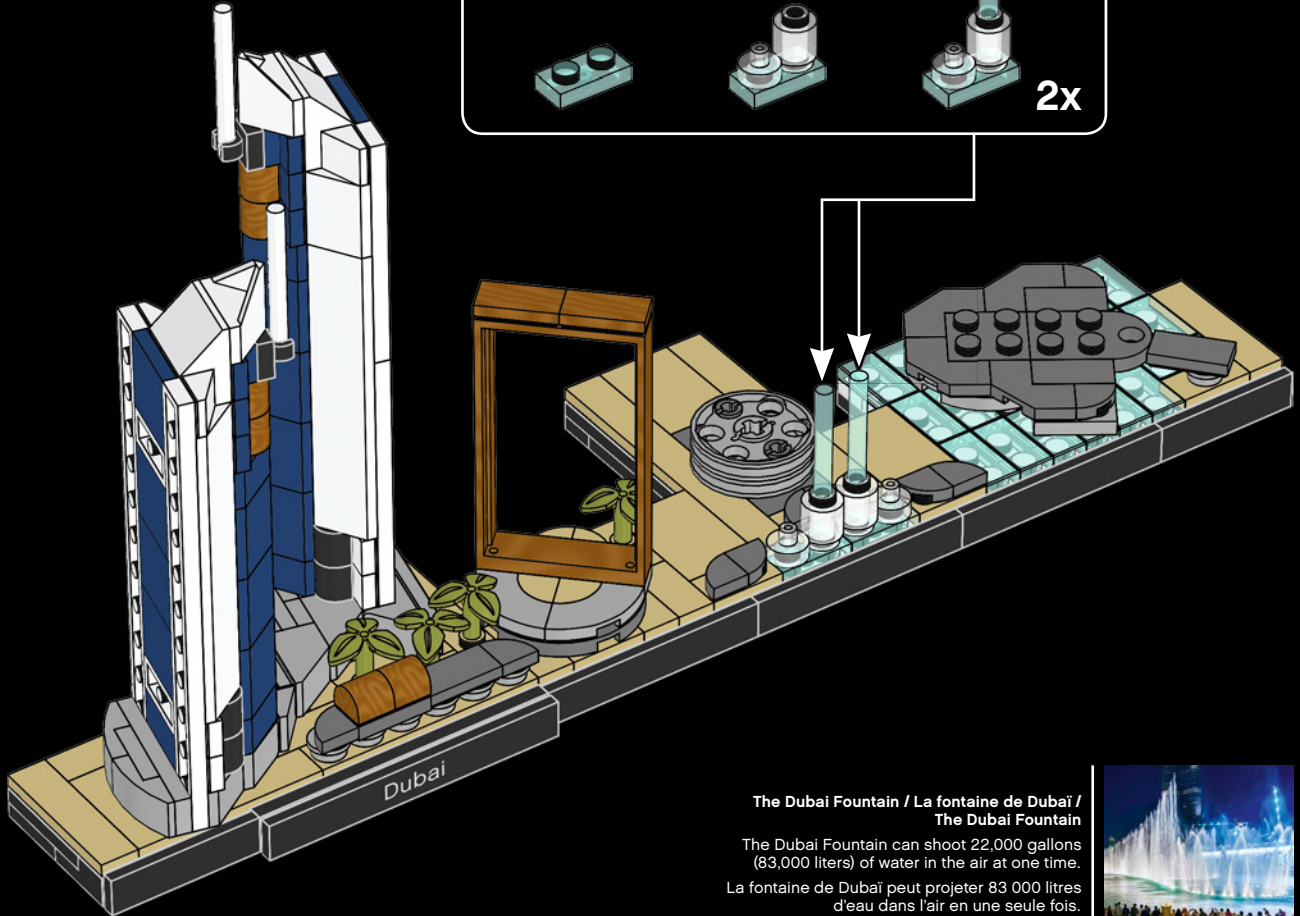
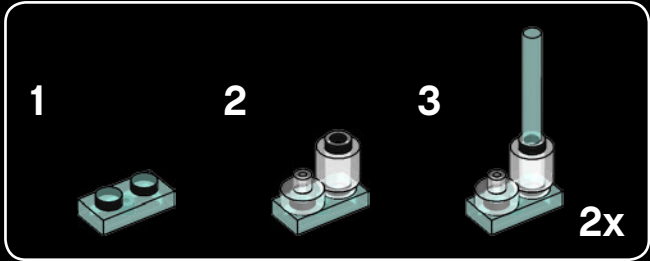

**The Dubai Fountain / La fontaine de Dubaï /
The Dubai Fountain**

The Dubai Fountain can shoot 22,000 gallons
(83,000 liters) of water in the air at one time.
La fontaine de Dubaï peut projeter 83 000 litres
d'eau dans l'air en une seule fois.

La Fuente de Dubaï puede disparar 83,000 l de
agua al aire a la vez.



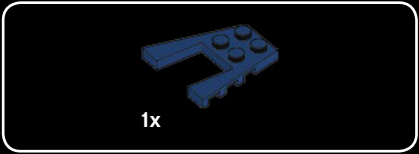
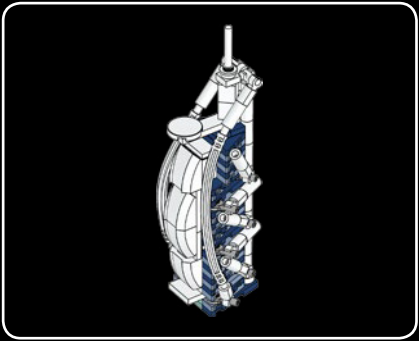

59

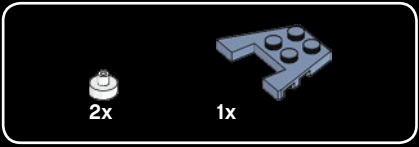
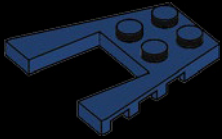

60

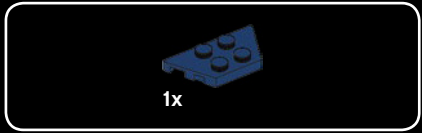
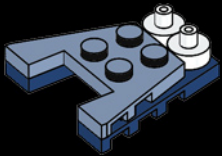

61

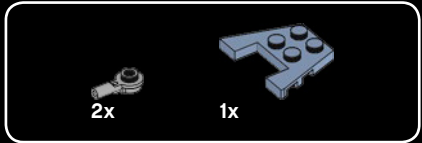
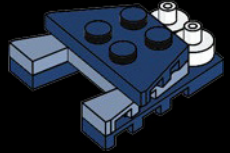

62

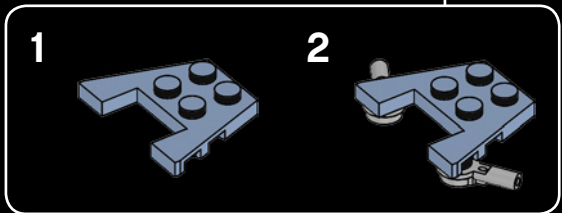
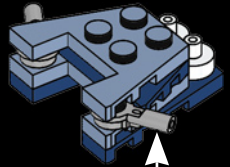

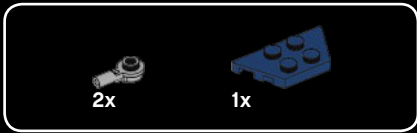

63

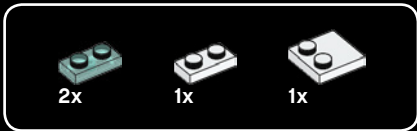
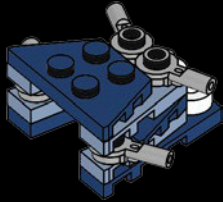

64

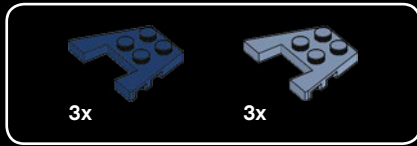
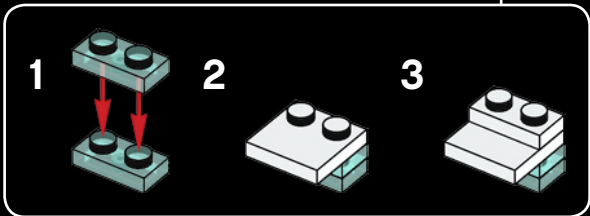
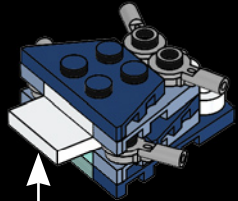

65

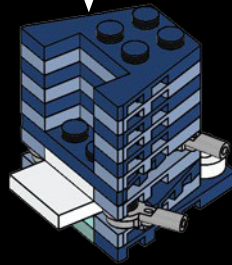
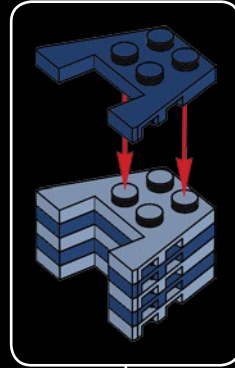

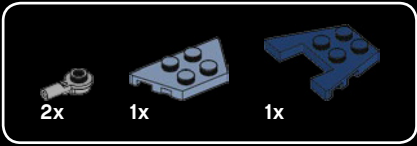

66

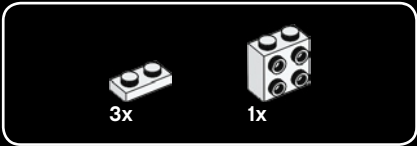
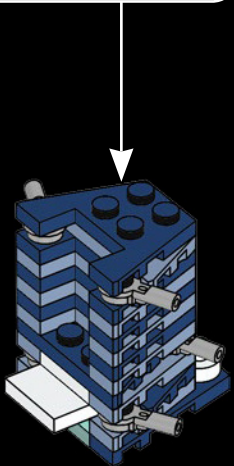
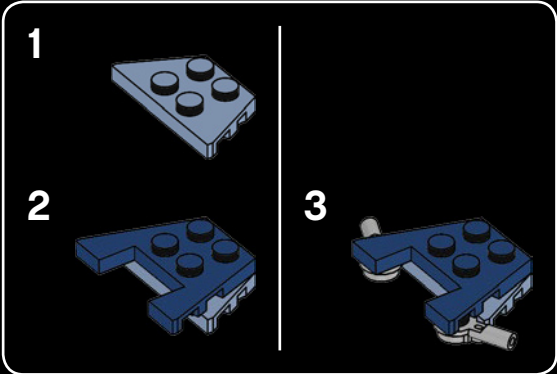

67

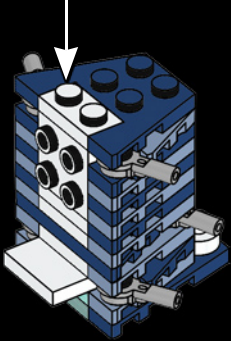
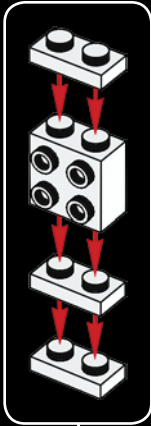

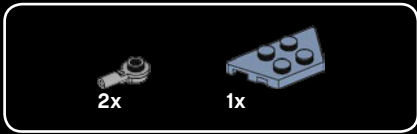

68

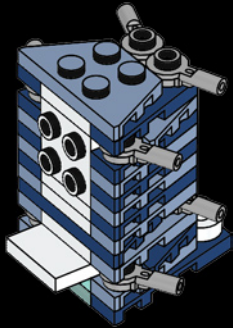

Burj Al Arab

The Burj Al Arab hotel opened for business in 1999.

L'hôtel Burj Al Arab a ouvert ses portes en 1999.

El hotel Burj al Arab abrió sus puertas en 1999.

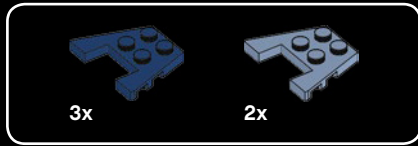

69

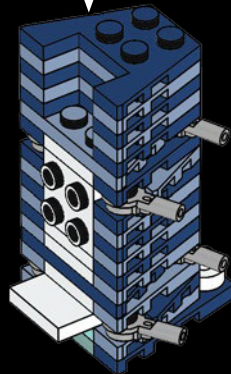
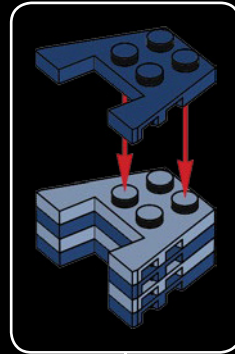

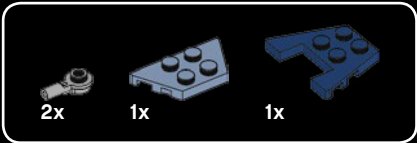

70

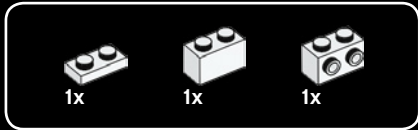
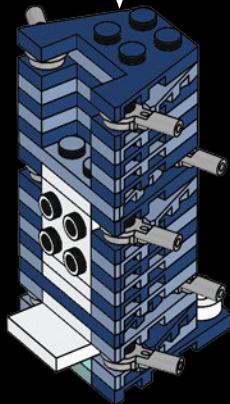
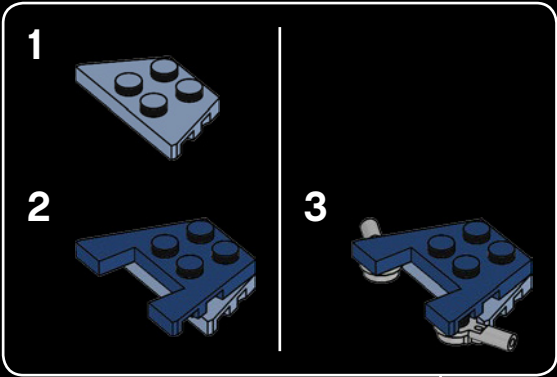

71

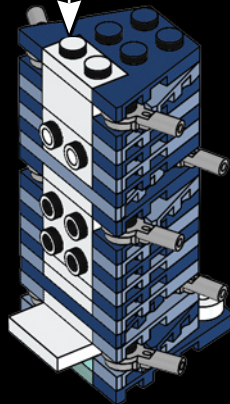
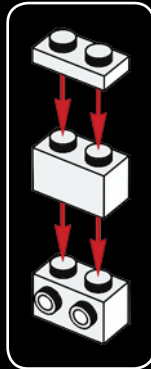

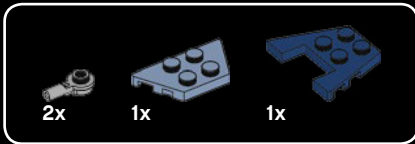

72

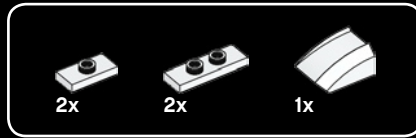
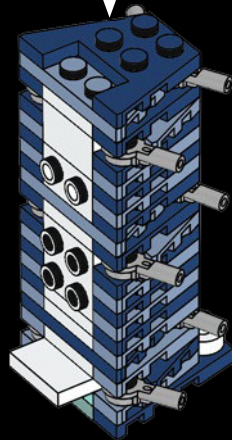
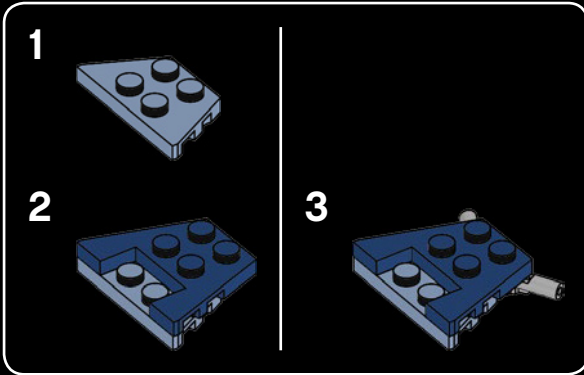

73

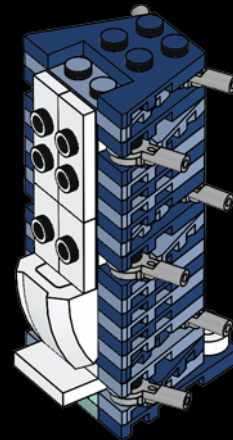



74

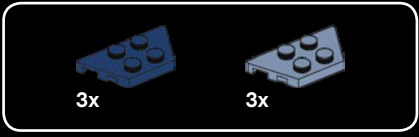
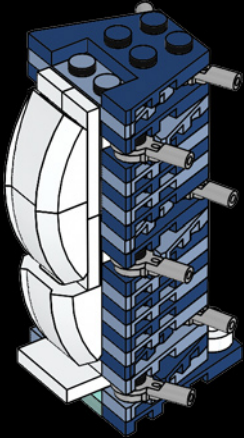

75

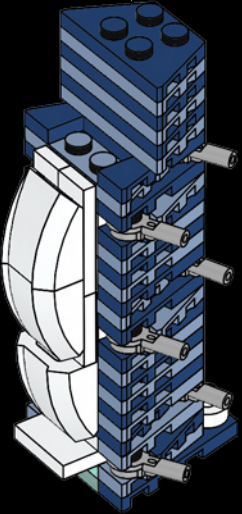
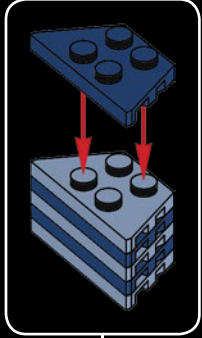



76

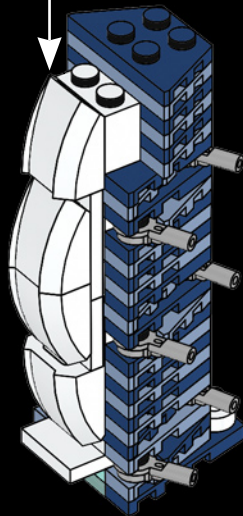
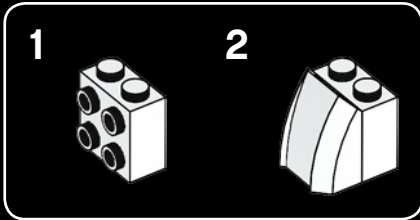

77



Burj Al Arab

The hotel's sail-like shape is taken from the traditional Arabian dhow ship.

La forme de voile de l'hôtel rappelle le traditionnel boutre arabe.

La forma de vela del hotel está inspirada en un dhow: una embarcación árabe tradicional.

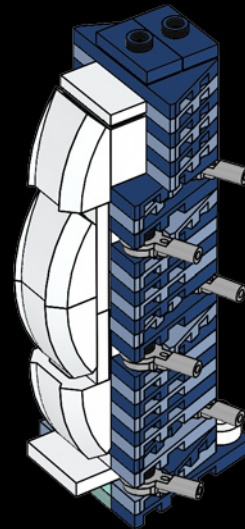



2x



1x

78

1

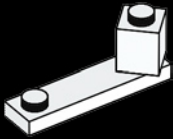

2

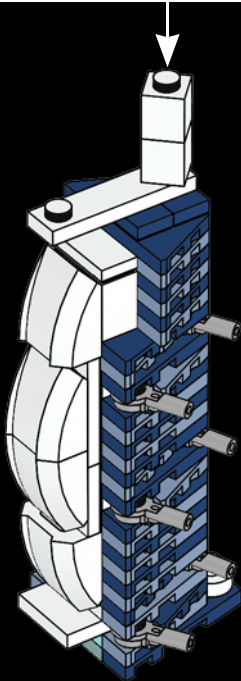
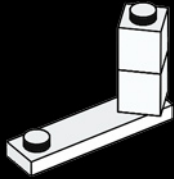

2x



16x

79

1



2



2x

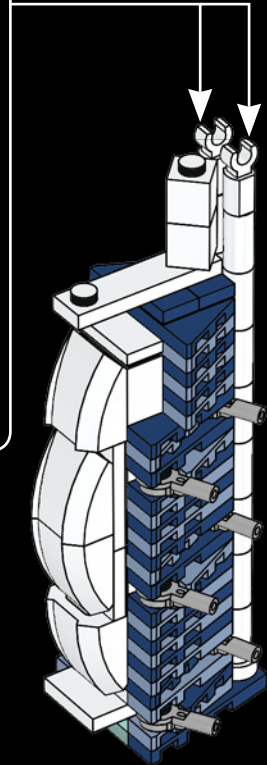



80

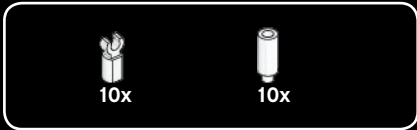
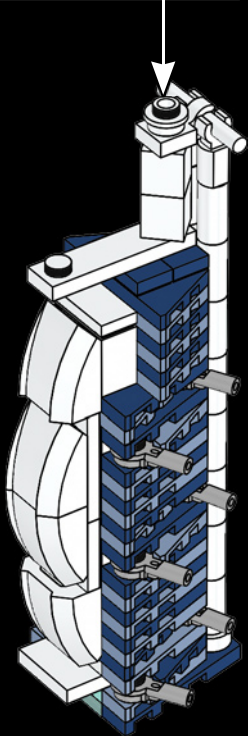
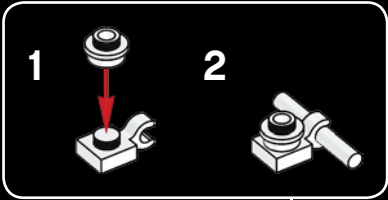

81

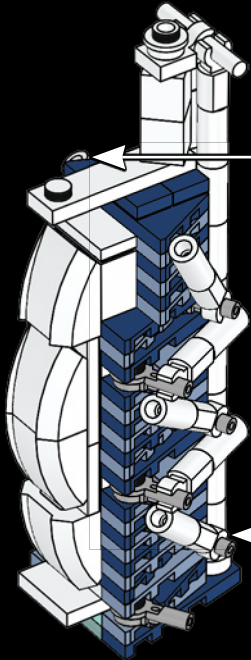
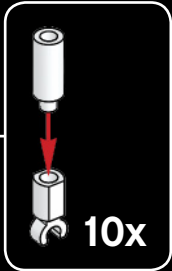

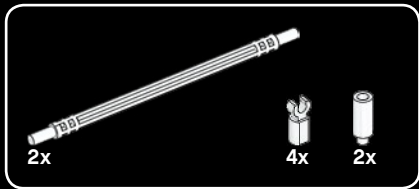

82

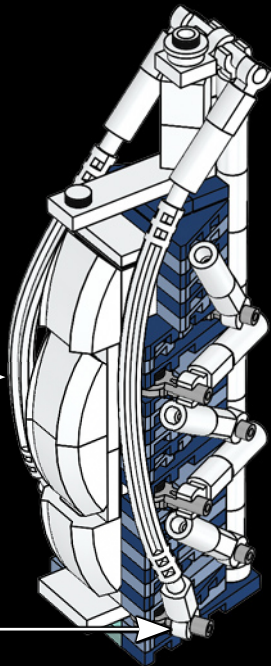
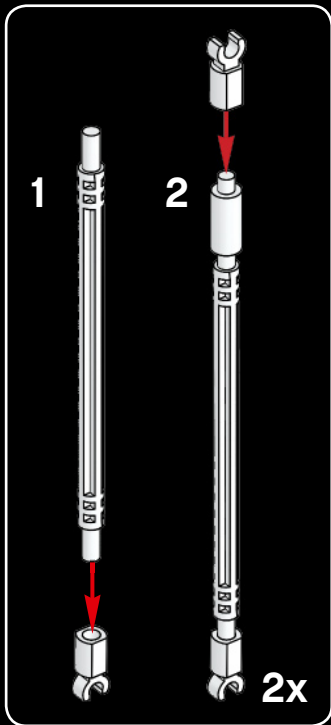



83

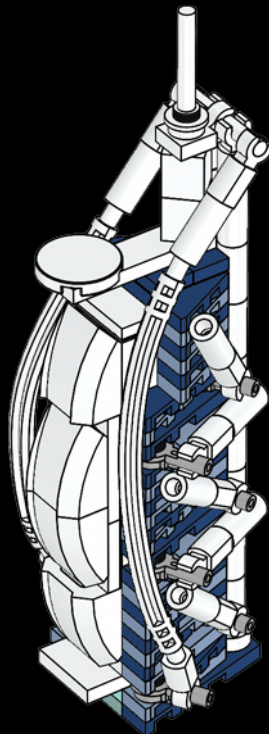

Burj Al Arab

The hotel boasts the tallest atrium in the world at almost 590 ft. (180m).

L'hôtel possède le plus haut atrium du monde, qui s'élève à près de 180 m.

El hotel cuenta con el atrio más alto del mundo, a casi 180 m de altura.

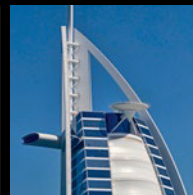

84

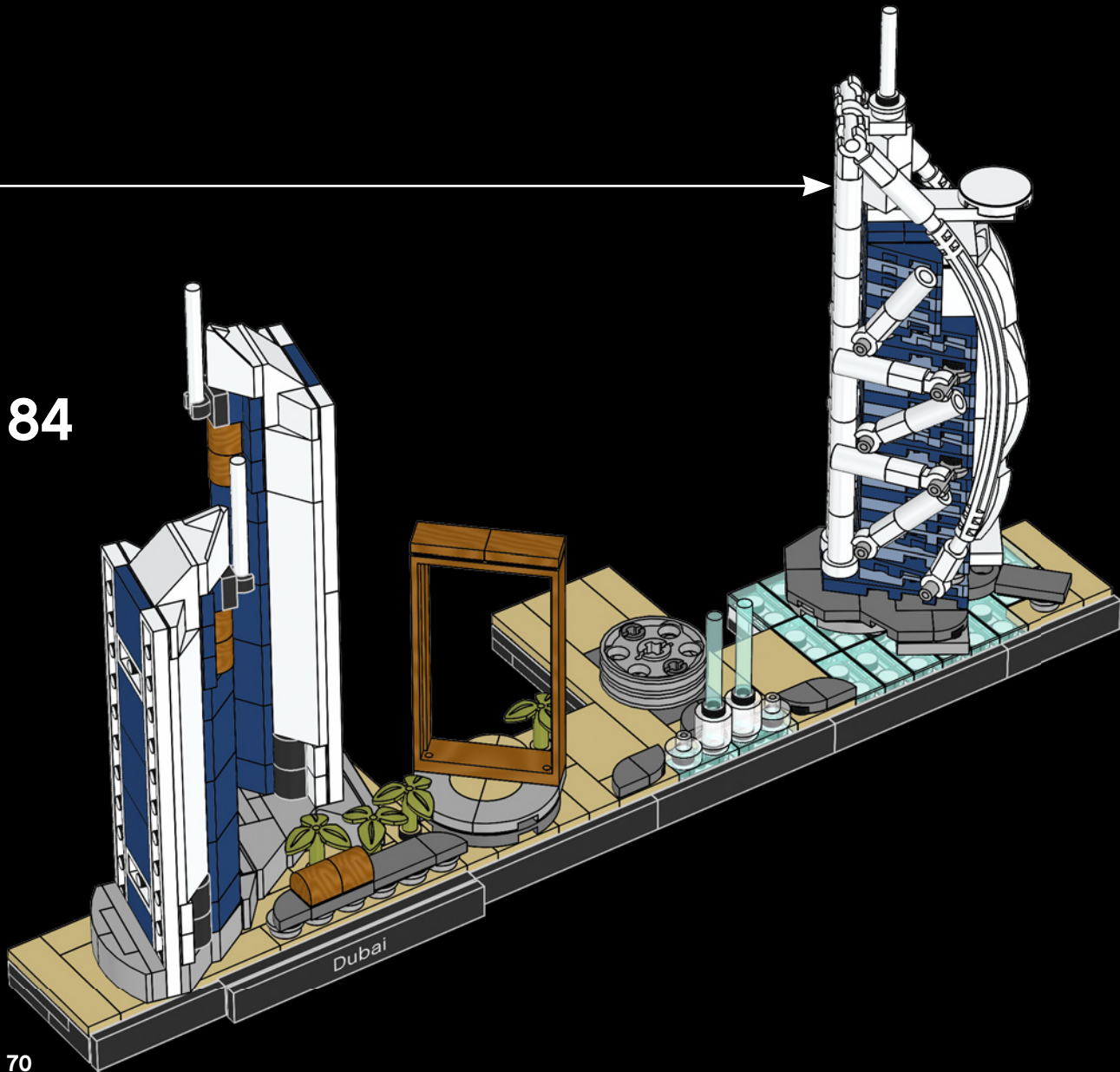

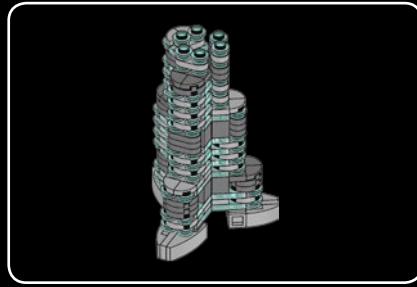
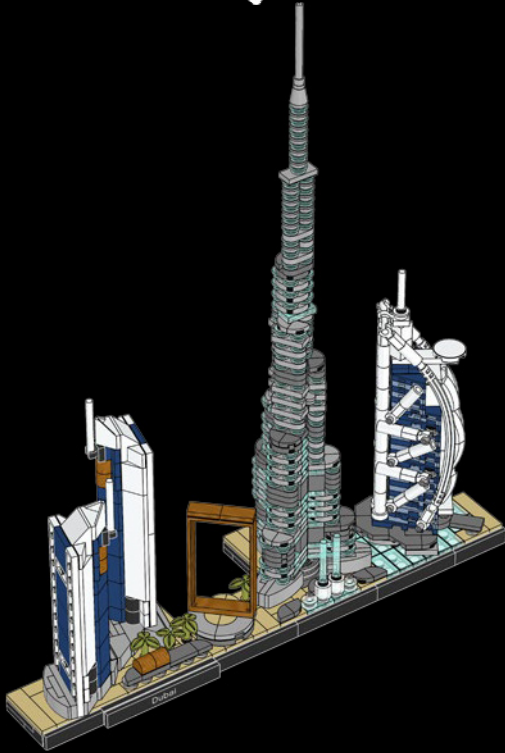

85



86





1x

87

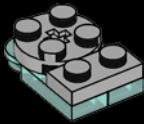

2x



2x

88



3x



1x

89

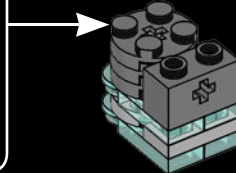
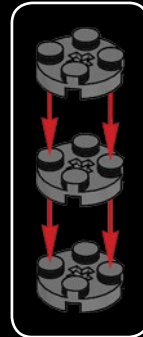

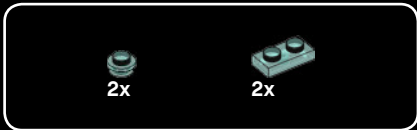

90

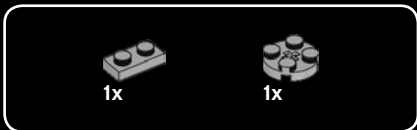

91

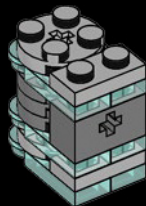

92



93



2x



2x

94



1x



1x

95

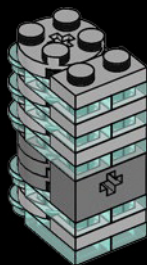

2x



2x

96



2x



1x



97

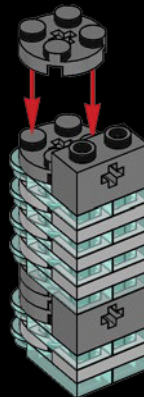



98

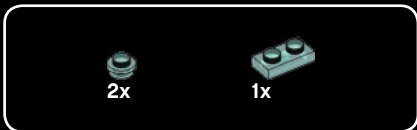
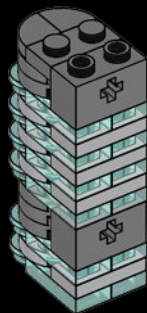

99

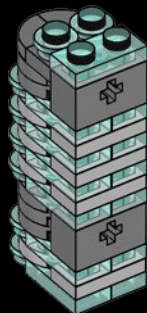

100

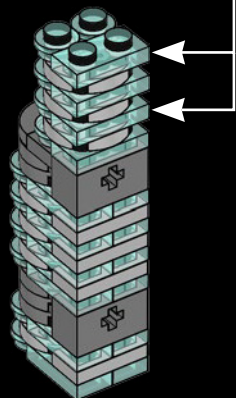



101



102



2x

1x

103

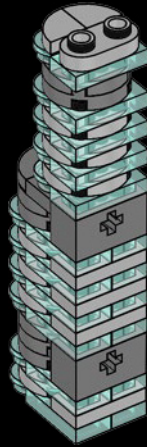

Burj Khalifa

It takes 36 workers 3 to 4 months to clean the entire exterior façade.

Pour nettoyer toute la façade extérieure, 36 ouvriers doivent travailler pendant trois à quatre mois.

Se necesitan de tres a cuatro meses para que 36 trabajadores limpien toda la fachada exterior.

2x

104

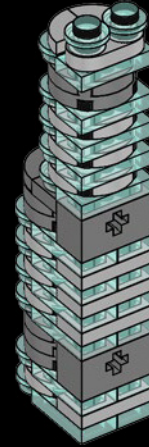

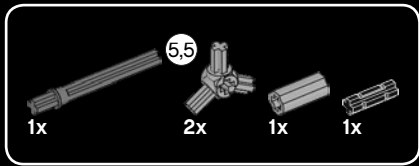

105

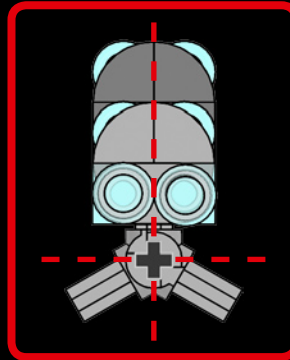
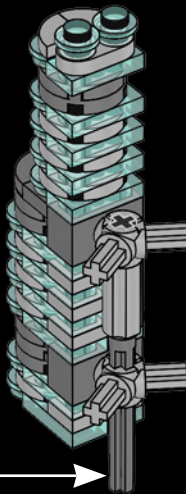
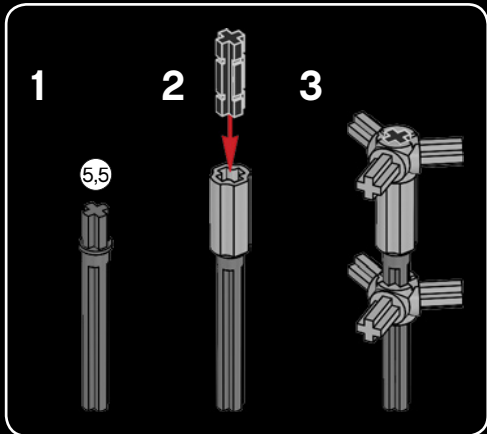



110

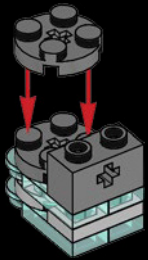

111



112



113

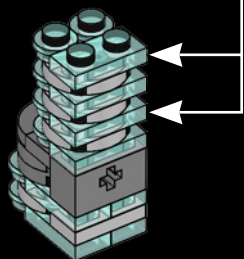



114

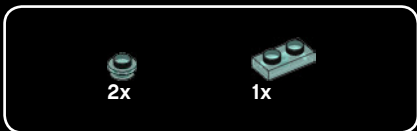
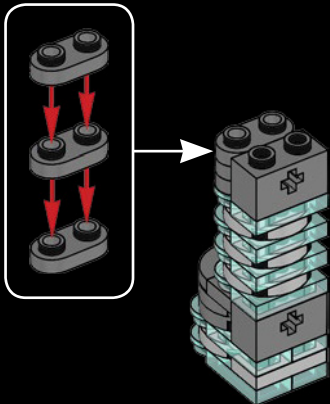

115

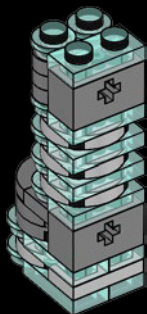

116

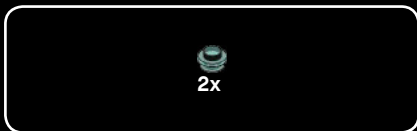

117

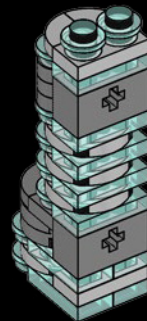



118

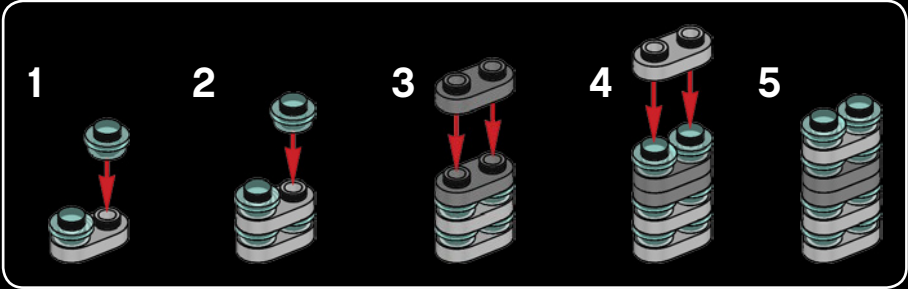

119

Burj Khalifa

A record-breaking 11.6 million cu. ft. (330,000 cubic meters) of concrete was used in the Burj Khalifa's construction.

Une quantité record de béton, soit 330 000 mètres cubes, a été utilisée pour construire le Burj Khalifa.

La construcción del Burj Khalifa necesitó la cifra récord de 330,000 m³ de concreto.

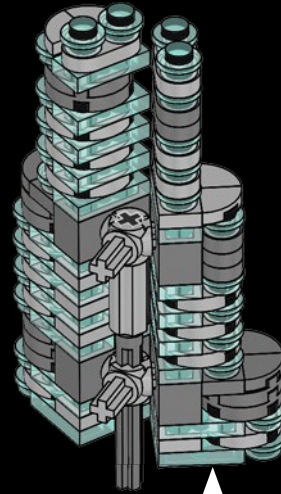



1x

120



2x



2x

121



1x

122



2x



2x

123

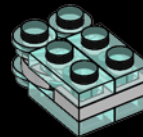



124

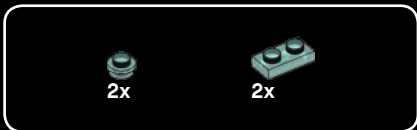
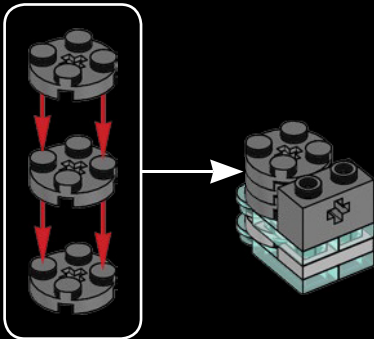

125



126



127





128

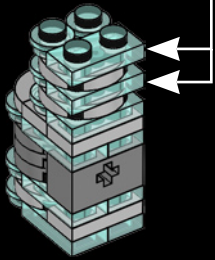

129

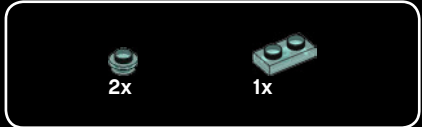
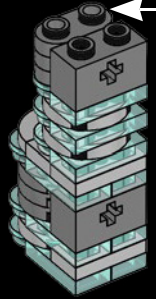
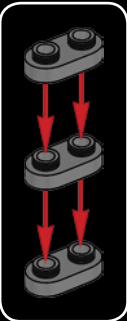

130

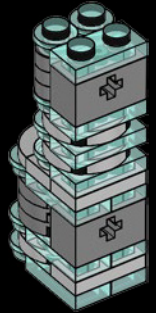



131

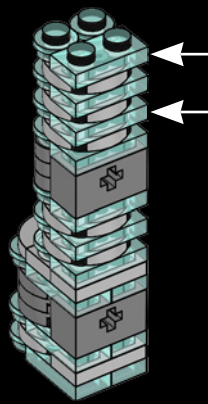
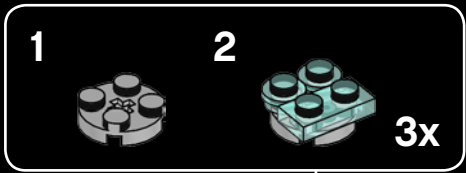

132

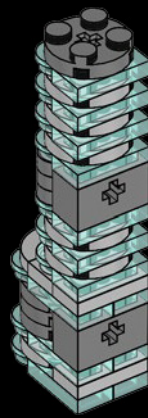



2x



1x

133



2x

134





1x

135



2x

136



Burj Khalifa

The tower took 22 million man-hours to construct.

La construcción de la torre a également nécessité 22 millions d'heures de travail.

Se invirtieron 22 millones de horas de mano de obra en la construcción de la torre.



137

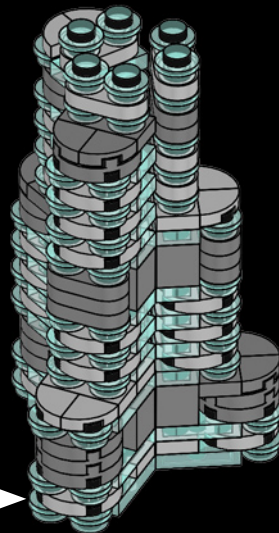

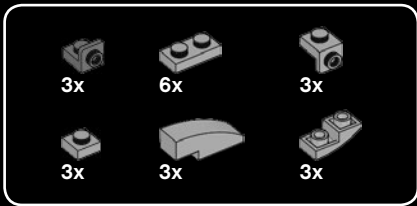

138

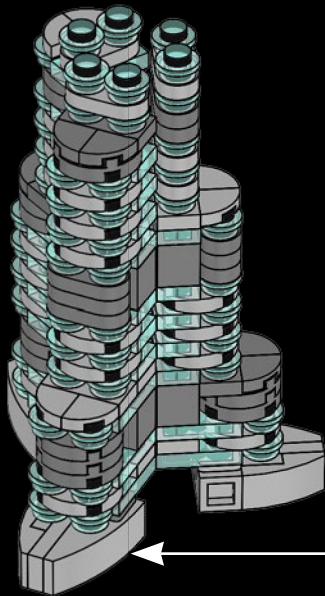
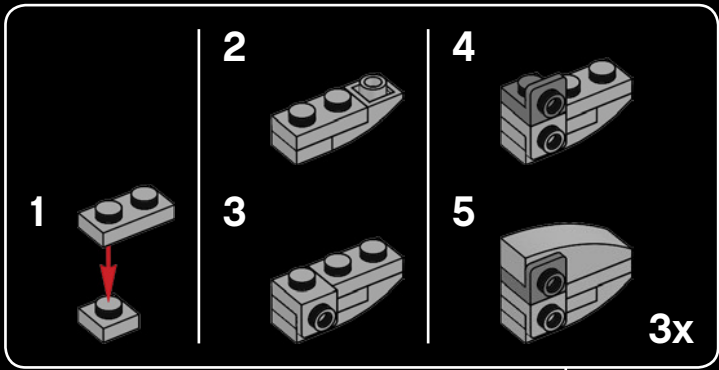

139

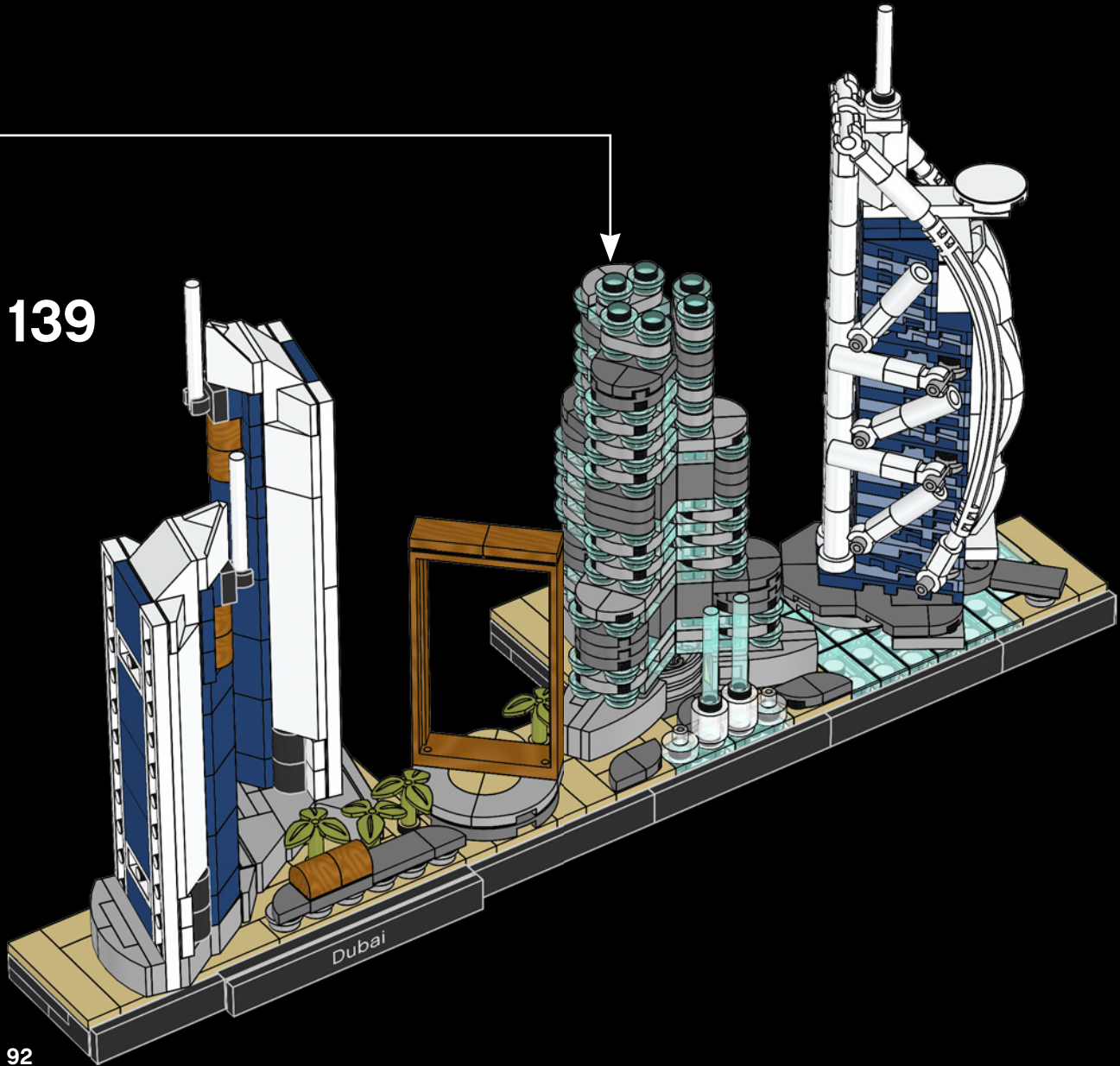

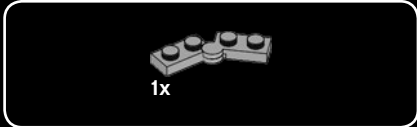
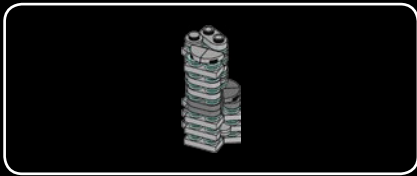

140



141

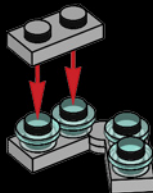

142

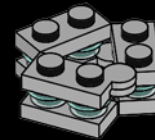

143

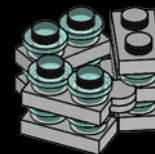
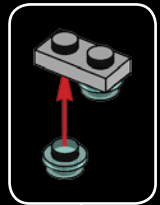



1x

144



2x

145



1x

146



2x

147





148

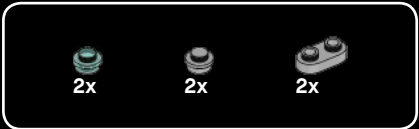
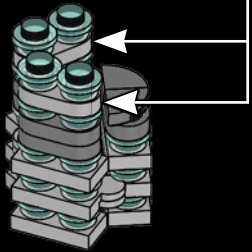
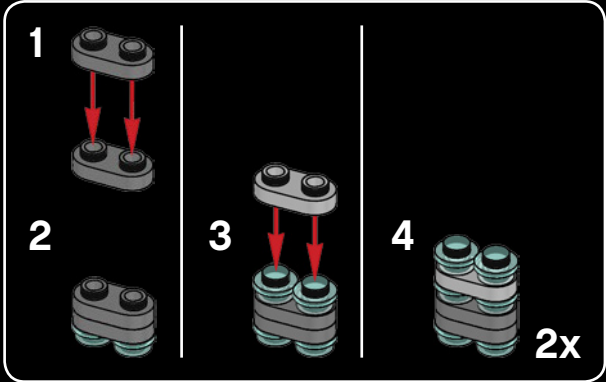

149

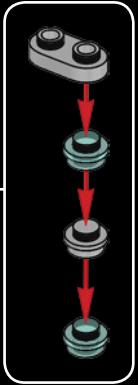

150





1x



1x

151

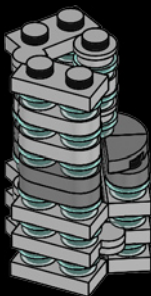

5x

152

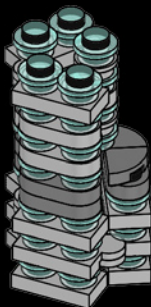

1x



2x



1x

153



154

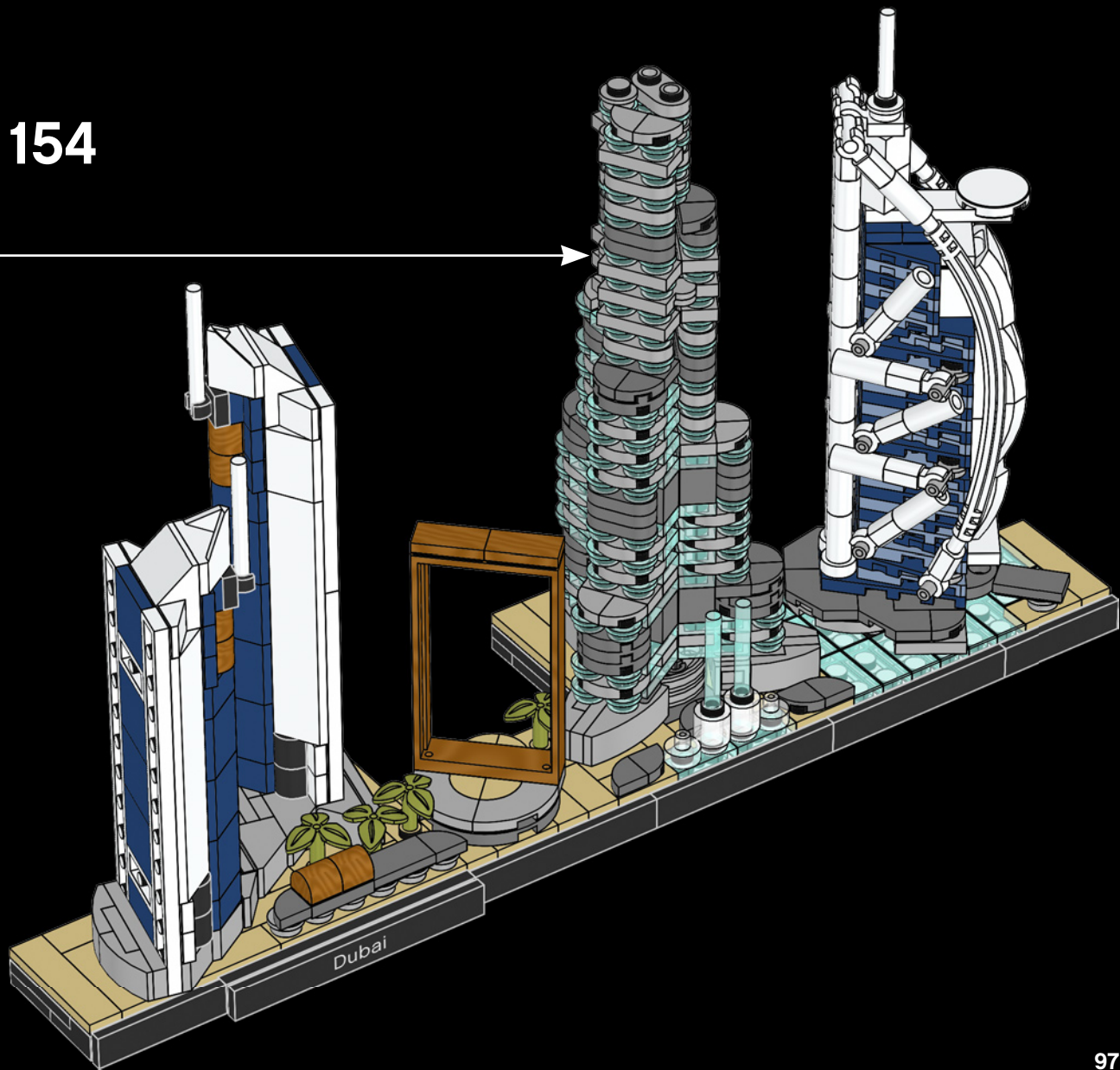

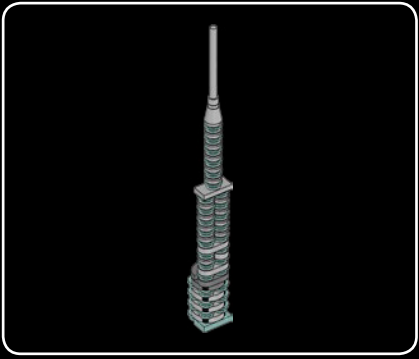

155



156

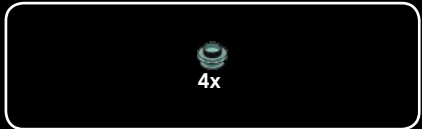

157

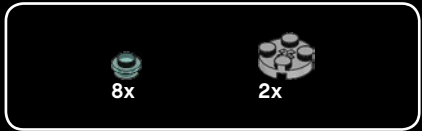

158



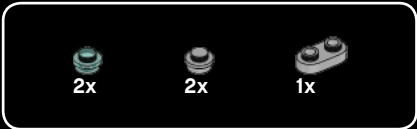

163

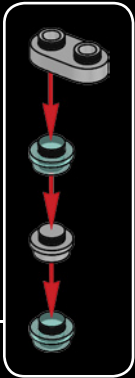

164



165

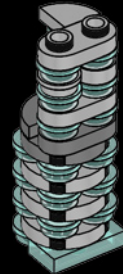



8x



10x

166

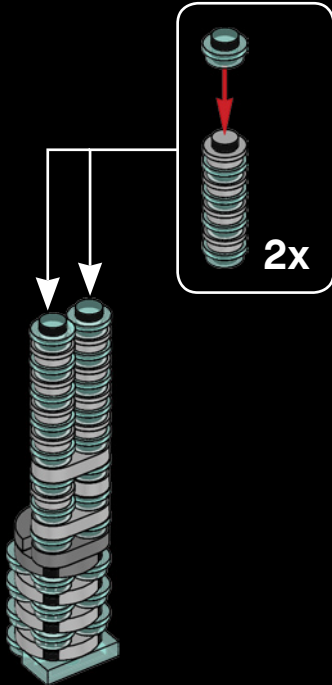

1x

167



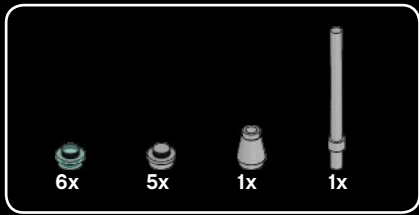

168

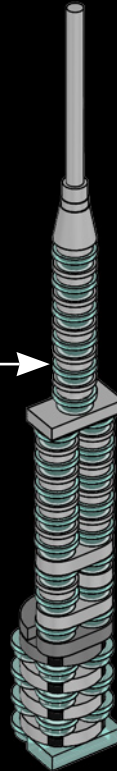
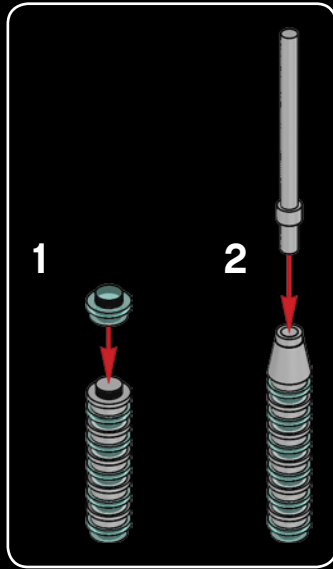



Dubai Frame / Le Dubai Frame / Marco de Dubái

The Dubai Frame can only handle 200 visitors per hour.

Le Dubai Frame ne peut accueillir que 200 visiteurs par heure.

El Marco de Dubái solo puede recibir 200 visitantes por hora.

169

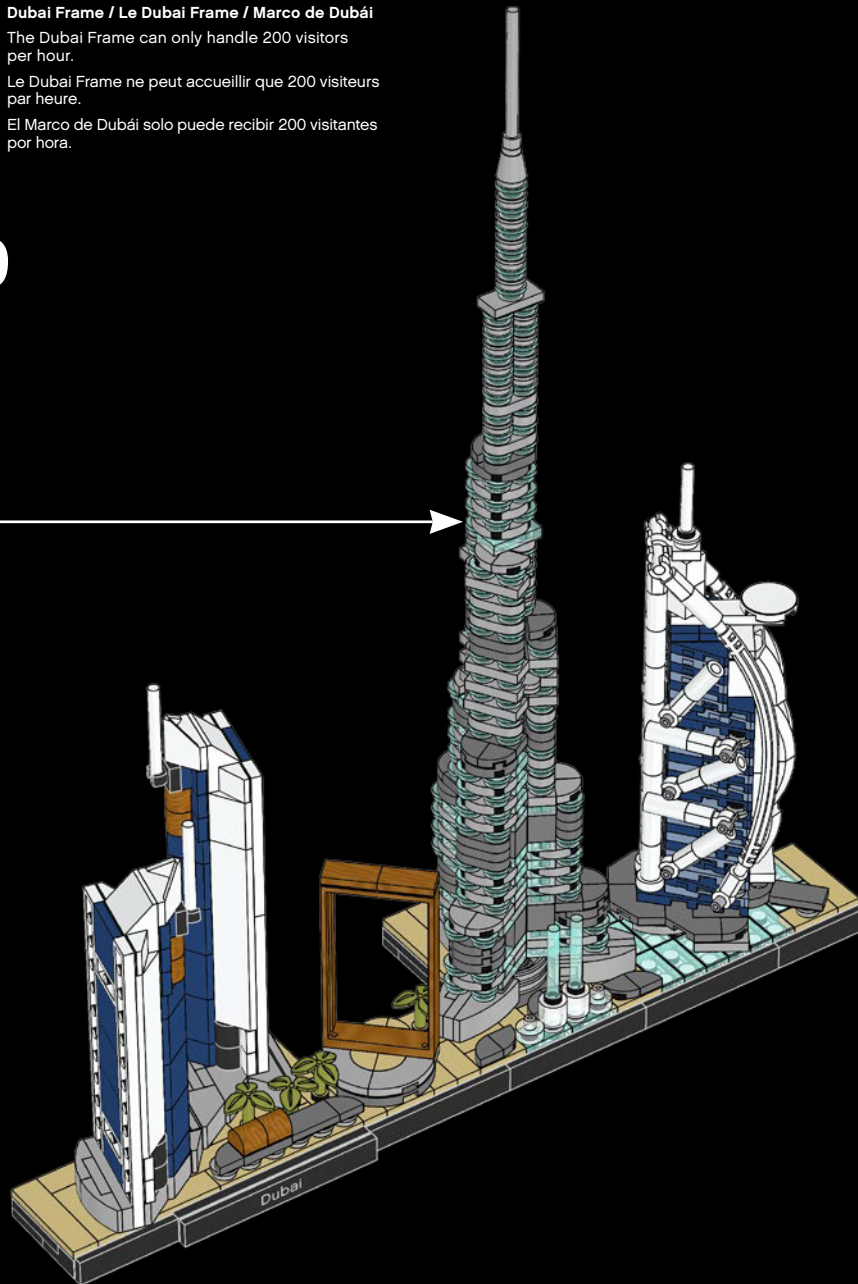



LEGO® Architecture – do you like it? Aimez-vous LEGO® Architecture ? LEGO® Architecture: ¿te gusta?

The LEGO Group would like your opinion on the new product you have just purchased. Your feedback will help shape the future development of this product series. Please visit:

Le Groupe LEGO aimerait connaître votre opinion sur le produit que vous venez d'acheter. Vos commentaires nous aideront à concevoir les futurs produits de cette gamme. Veuillez visiter :

The LEGO Group quiere conocer tu opinión acerca del nuevo producto que acabas de comprar. Tus comentarios nos ayudarán a dar forma a los futuros productos de esta serie. Visita:

[LEGO.com/productfeedback](https://www.lego.com/productfeedback)

By completing our short feedback survey, you will be automatically entered into a drawing to win a LEGO® prize.

En remplissant ce court sondage sur le produit, vous serez automatiquement inscrit à un tirage au sort pour gagner un prix LEGO®.

Al contestar este breve cuestionario de opinión, participarás automáticamente en el sorteo de un producto LEGO®.

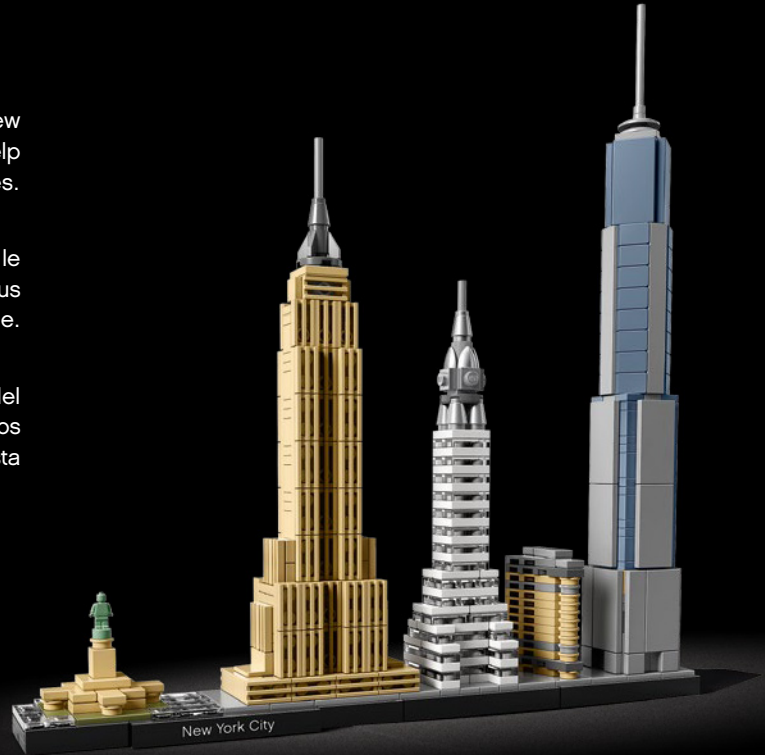

Terms & Conditions apply. Des conditions générales s'appliquent. Sujeto a Términos y Condiciones.

LEGO® Architecture

The LEGO® Architecture series creatively captures the essence of many of the world's most iconic landmarks while giving you an enjoyable and engaging LEGO building experience.

Whether your interest is in travel, design, history or architecture, these sets are a physical memento of a great trip abroad, a famous building you know well, or a city you still dream of visiting.

Every LEGO Architecture set is designed to be displayed. Much more than just a photo, building and displaying your model on your desk, in the bookcase or on the shelf, lets you be transported every time you admire the view.

La série LEGO® Architecture capture l'essence de nombreux monuments parmi les plus célèbres du monde tout en vous offrant une expérience agréable et stimulante de construction LEGO.

Que votre intérêt porte sur les voyages, le design, l'histoire ou l'architecture, ces ensembles constituent un souvenir tangible d'un voyage mémorable, d'un célèbre bâtiment que vous connaissez bien ou d'une ville que vous rêvez de visiter.

Chaque ensemble LEGO Architecture est conçu pour être exposé. Construire votre modèle et l'exposer sur votre bureau, une bibliothèque ou une tablette vous fera voyager à chaque coup d'œil, bien plus qu'une simple photo ne pourrait le faire.

La línea LEGO® Architecture captura con creatividad la esencia de muchos de los monumentos más populares del mundo y pone a tu alcance una experiencia de construcción gratificante y cautivadora con el sello característico de LEGO.

Ya sea que sientas atracción por los viajes, el diseño, la historia o la arquitectura, estos sets expresan físicamente tus recuerdos de aquel fantástico viaje al extranjero, ese famoso edificio que conoces tan bien o la ciudad que sueñas con visitar algún día.

Todos los sets LEGO Architecture están diseñados para decorar. Mucho más que una simple fotografía, construir y exponer un modelo en tu escritorio, un librero o una repisa te traslada a otro lugar al admirar las vistas.

Follow us on

Suivez-nous sur

Síguenos en



Adam Reed Tucker is the co-developer of the LEGO Architecture product line.

Adam Reed Tucker est le codéveloppeur de la gamme de produits LEGO Architecture.

Adam Reed Tucker es el codesarrollador de la línea de productos LEGO Architecture.



Celebrate the world of architecture and collect all the models
Célébrez le monde de l'architecture et collectionnez tous les modèles
Celebra el mundo de la arquitectura y colecciona todos los modelos

21045
Trafalgar Square



21042
Statue of Liberty
La statue de la Liberté
Estatua de la Libertad



21046
Empire State Building
L'Empire State Building



21028
New York City
New York
Nueva York



21039
Shanghai
Shanghái

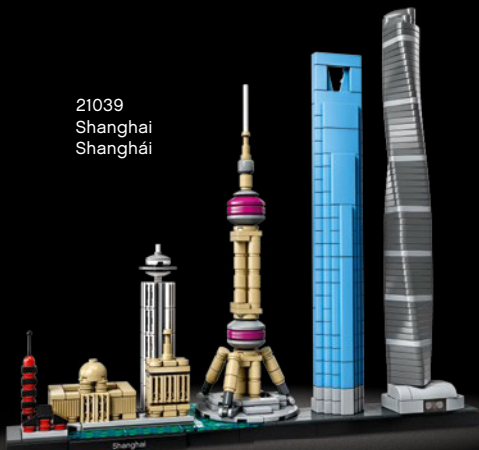

21043
San Francisco



21034
London
Londres



21044
Paris
Paris



21051
Tokyo
Tokio



28x
6234807

16x
6052824

2x
6186681

2x
302401

4x
4504369

2x
300501

1x
4538353

1x
6044691

2x
6059271

10x
6051511

1x
6058177

1x
306901

17x
302301

1x
300401

2x
6218823

2x
6093526

1x
6218822

2x
366001

2x
303901

4x
4195869

2x
6195371

2x
6116602

1x
4597131

2x
366601

2x
4296264

2x
4119227

3x
6168642

2x
6238334

4x
4163984

1x
303401

5x
4560929

3x
346001

2x
4514842

1x
6285745

2x
346026

1x
383226

2x
244526

8x
6273589

1x
6174243

2x
6052126

2x
362326

2x
243126

5x
371026

1x
6174917

1x
4227684

3x
302026

3x
663626

1x
4160025

1x
303226

2x
6066102

1x
4109810

2x
302326

4x
6145570

5x
4114026

6x
6092587

3x
4113917

4x
6131896

5x
6175367

7x
4550324

1x
4124067

2x
4544139

2x
4184108

8x
6092588

10x
6285466

7x
6285473

4x
6285562

5x
4613335

9x
6285477

1x
6275408

7x
6285557

7x
6285482

1x
4210633

19x
6199549

3x
6225494

14x
6221607

14x
4211042

5x
4211063

6x
6178919

4x
4211052

1x
4211094

4x
4211129

4x
6177079

1x
4225733

1x
4528323

1x
4508553

1x
6170418

1x
4529241

27x
4211525

9x
6176433

2x
4521921

5x
4211399

2x
4211535

3x
6248078

13x
6248890

12x
6227897

20x
4211475

1x
4512360

5x
6144138

4x
6093859

1x
6066097

23x
4211398

1x
4211414

4x
4211437

2x
4211614

2x
4502595

2x
4494222

2x
6163990

2x
4211353

2x
6251044

2x
4558169

3x
4251163

1x
4599498

2x
4211445

1x
4515351

4x
6102769

149x
6240225

44x
6240222

18x
6251295

2x
6170187

2x
6186867

2x
6223655

2x
6284574

4x
6285465

6x
6286351

2x
6265247

1x
6286377

1x
6240515

Customer Service
Kundenservice
Service Consommateurs
Servicio Al Consumidor
LEGO.com/service or dial



00800 5346 5555 :

1-800-422-5346 :



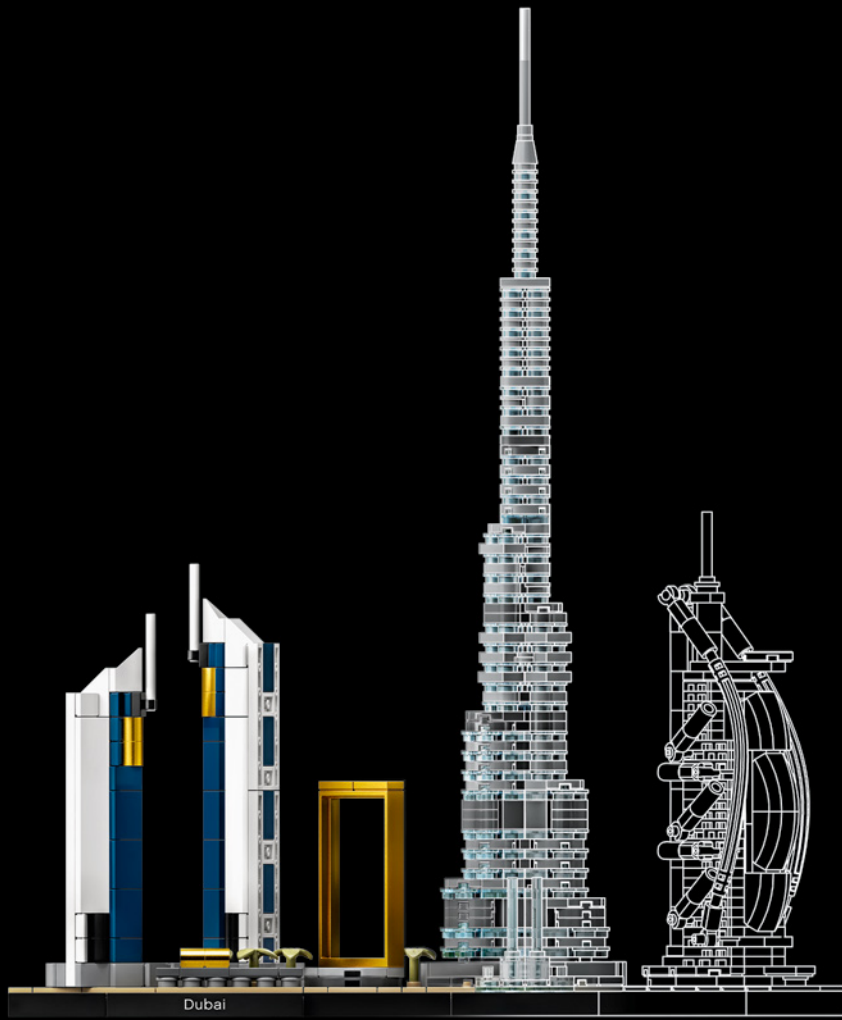

[LEGO.com/architecture](https://www.lego.com/architecture)

LEGO and the LEGO logo are trademarks of the/son/ des marques de commerce du/son marcas registradas de LEGO Group.
©2020 The LEGO Group. 6313381

BURJ KHALIFA
EMAAR

Follow LEGO® Architecture on
Suivez LEGO® Architecture sur
Sigue a LEGO® Architecture en



© Jumeirah International LLC