



CLASSIC

10704



 [LEGO.com/classic](https://www.lego.com/classic)



WARNING: CHOKING HAZARD.
Small parts. Not for children under 3 years.





AVERTISSEMENT : RISQUE D'ÉTOUFFEMENT.

Contient des petites pièces. Ne convient pas aux enfants de moins de 3 ans.



ADVERTENCIA: PELIGRO DE ASFIXIA.

No recomendado para niños menores de 3 años. Contiene piezas pequeñas.



LEGO.com/brickseparator



Easy Building
Construction facile
Construcción fácil



Medium Building
Construction intermédiaire
Construcción intermedia



Advanced Building
Construction avancée
Construcción avanzada

p./pag.
14



p./pag.
6



p./pag.
20



p./pag.
32



LEGO.com/classic





1

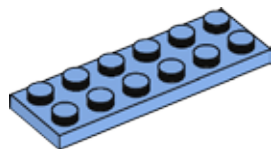

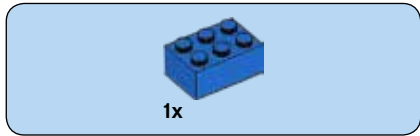

2

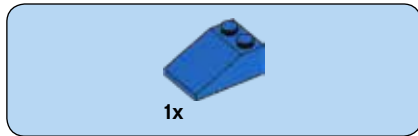
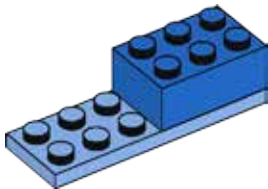

3

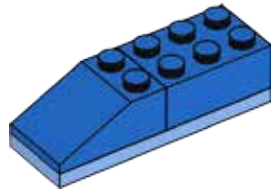



1x



1x

4

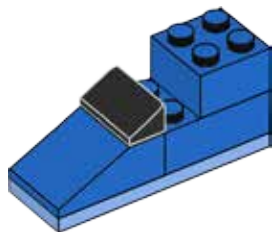

8



1x

5

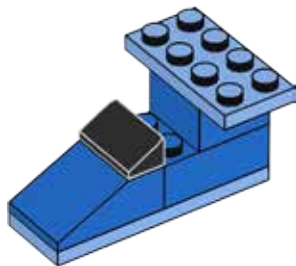

2x

6



2x

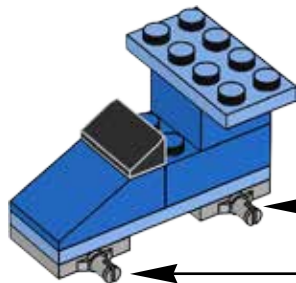



4x



4x

7



4x

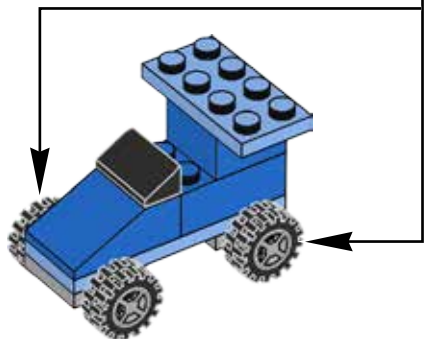

1x

8

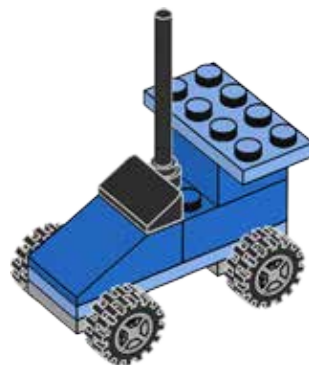



1

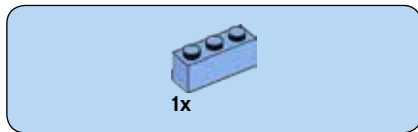

2





1x



2x

3

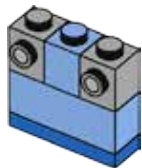

1x

4





1x



2x

5



6

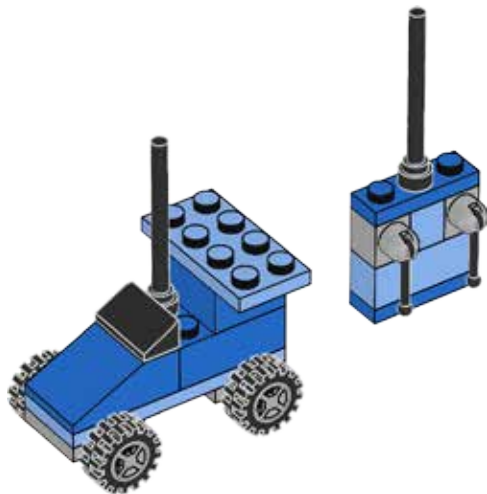



1

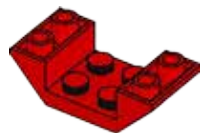

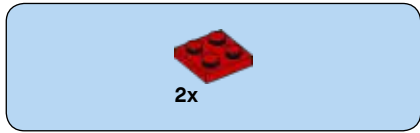

2

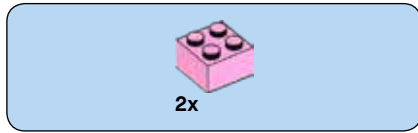
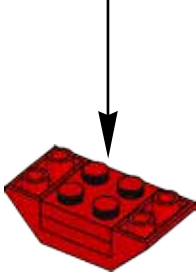
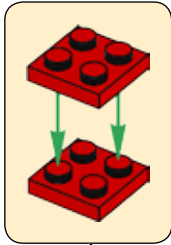

3

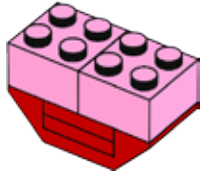



1x

4

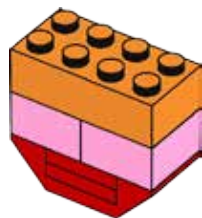



2x

5

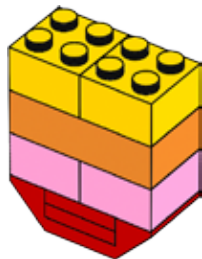

1x

6





2x

7

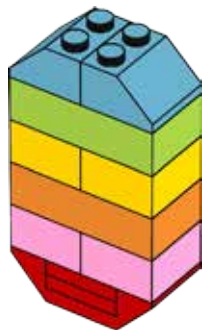



3x

8

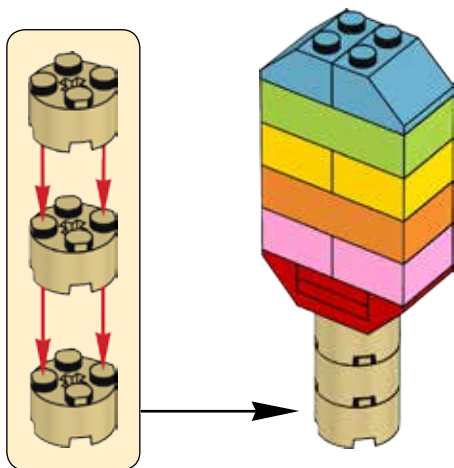



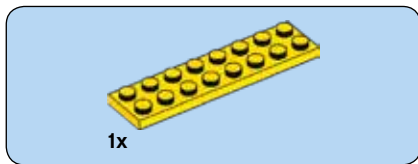

1

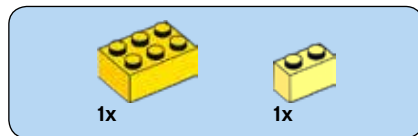
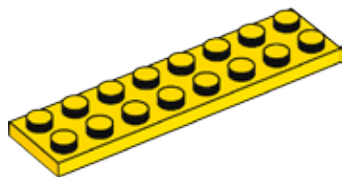

2

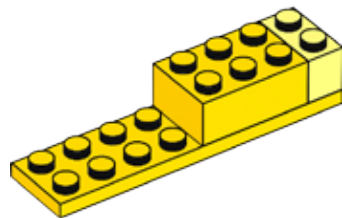



1x

3

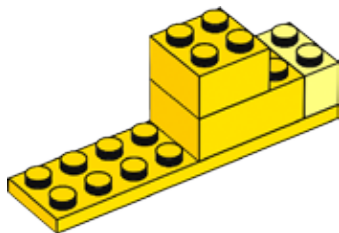



4x

4



2x

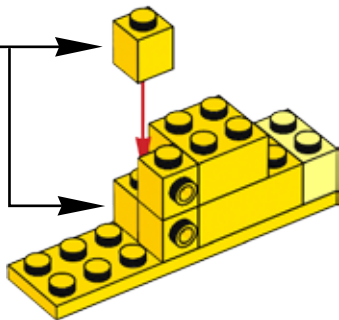

2x

5

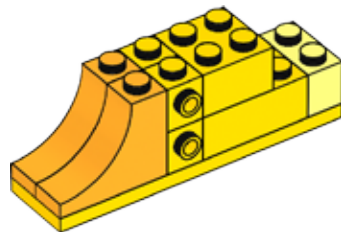



1x

6

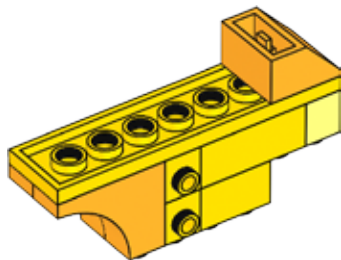
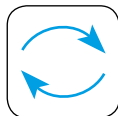

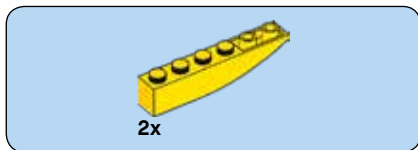

7

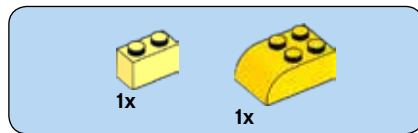
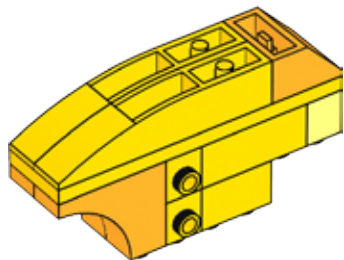

8

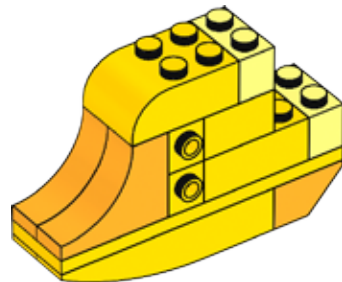
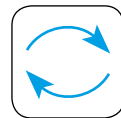



1x

9

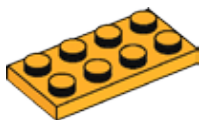



2x

10

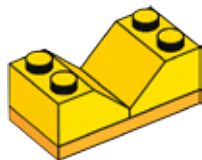

1x



1x

11

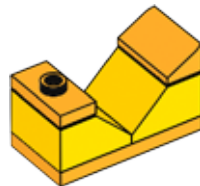

12

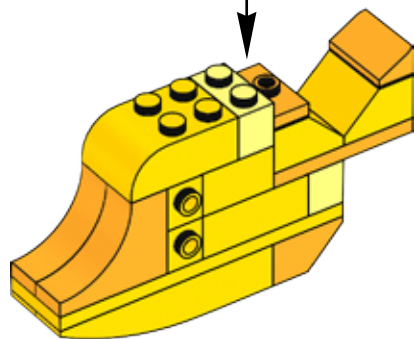



13

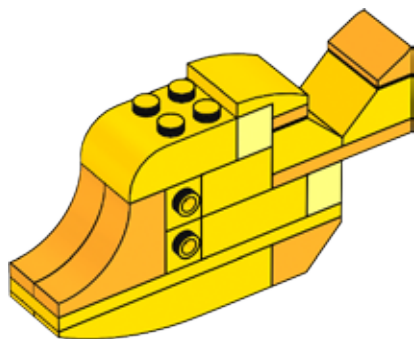

14

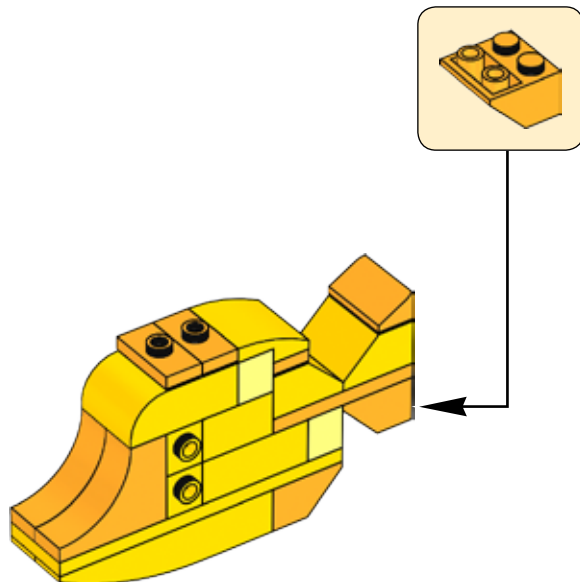



1x

15

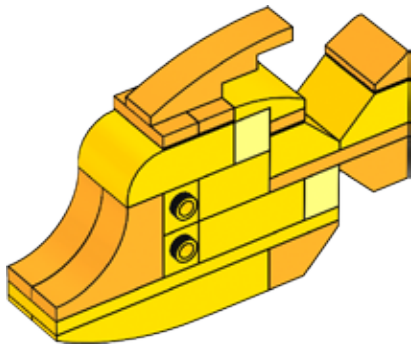



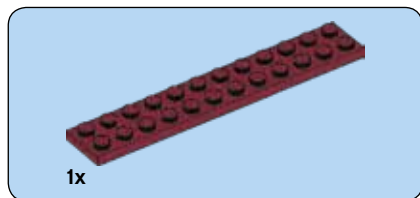

1

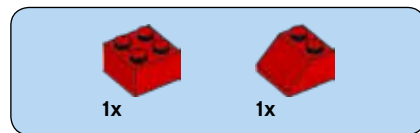
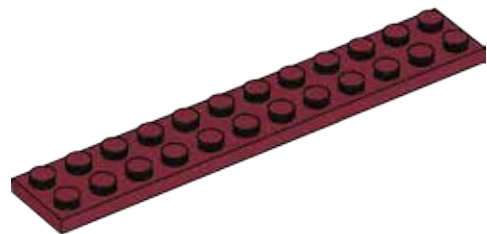

2

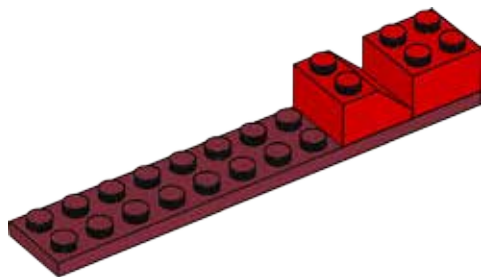



2x

3

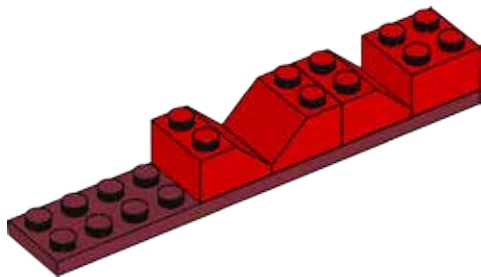

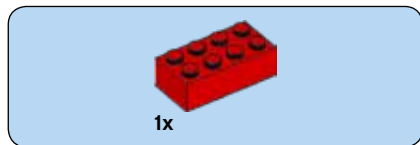

4

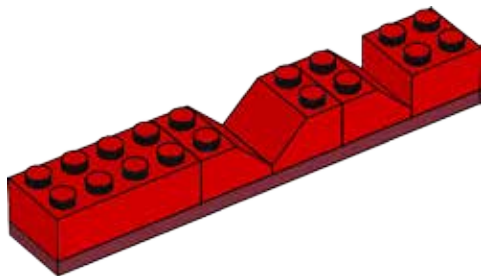

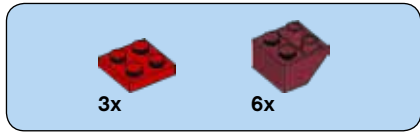

5

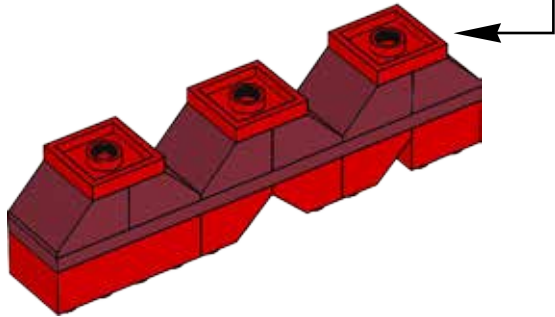
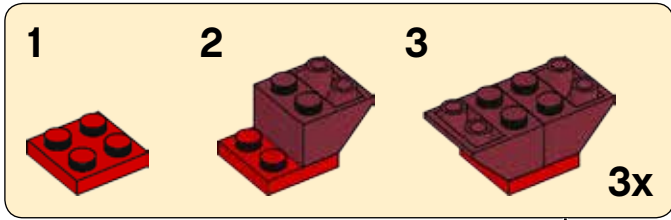



6

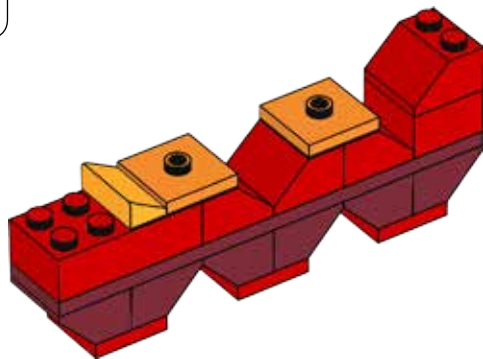
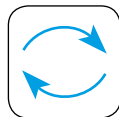



1x



2x

7

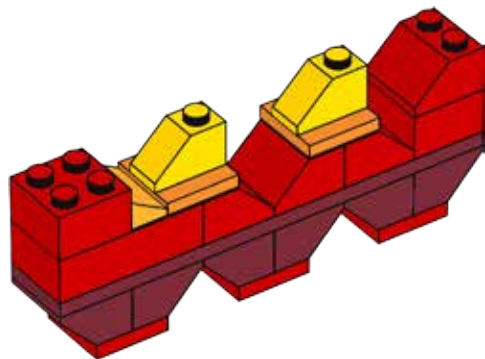



8

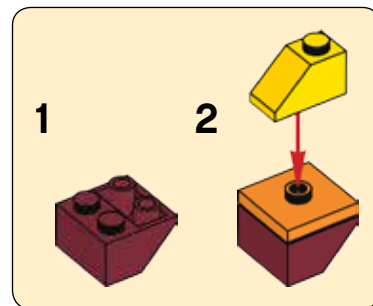
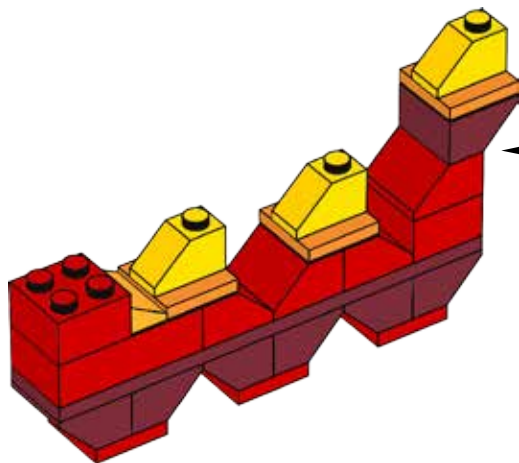



9

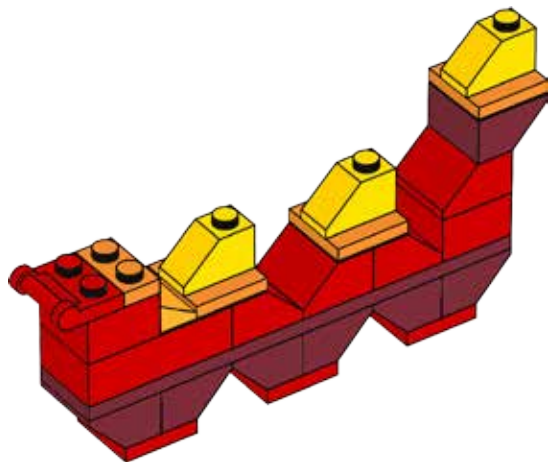



2x

10

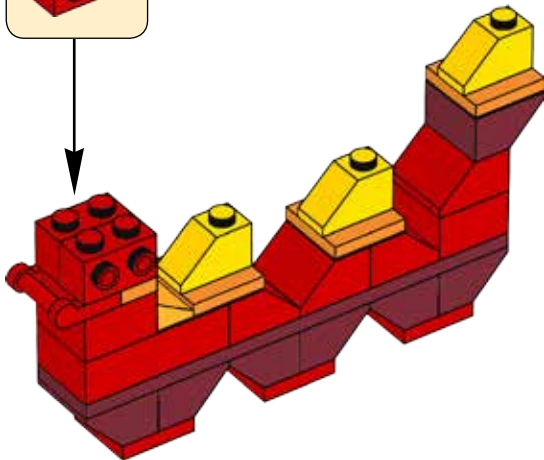

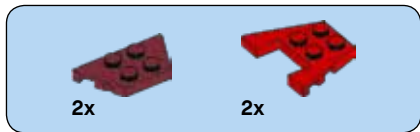

11

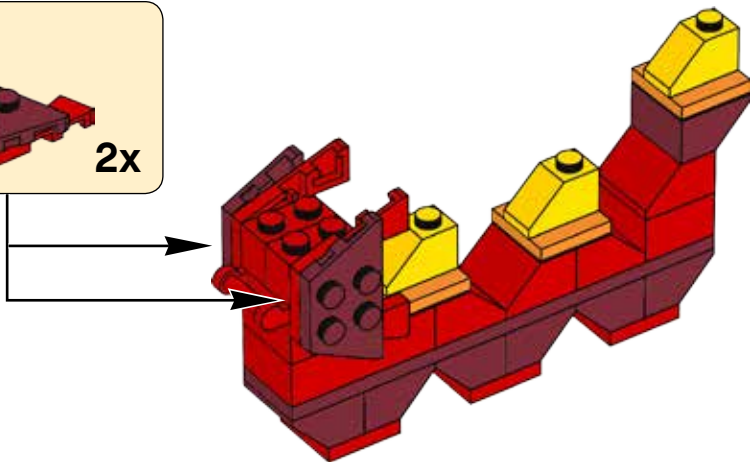
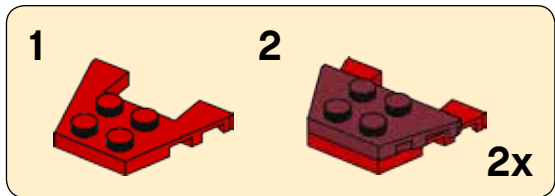

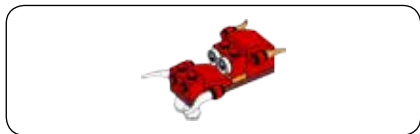

12

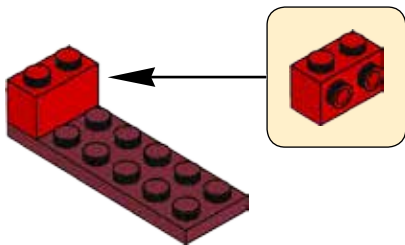

13

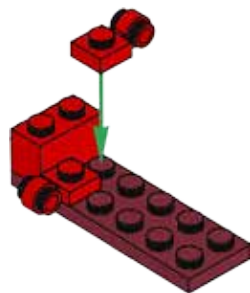



1x



1x

14

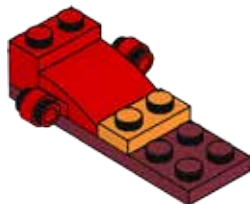



1x

15

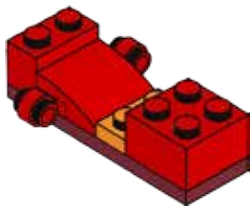

2x



1x

16

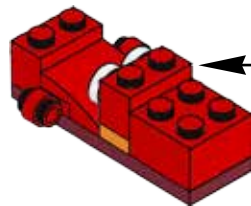
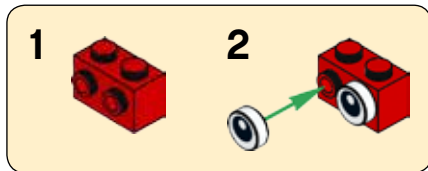



2x

17

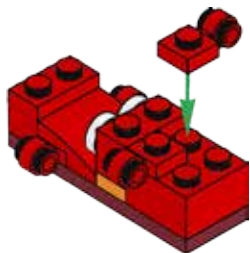



18

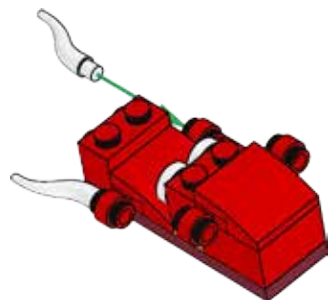

19

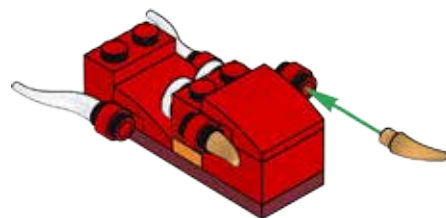



2x

20

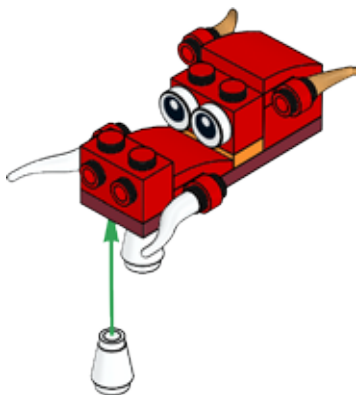
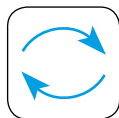

21

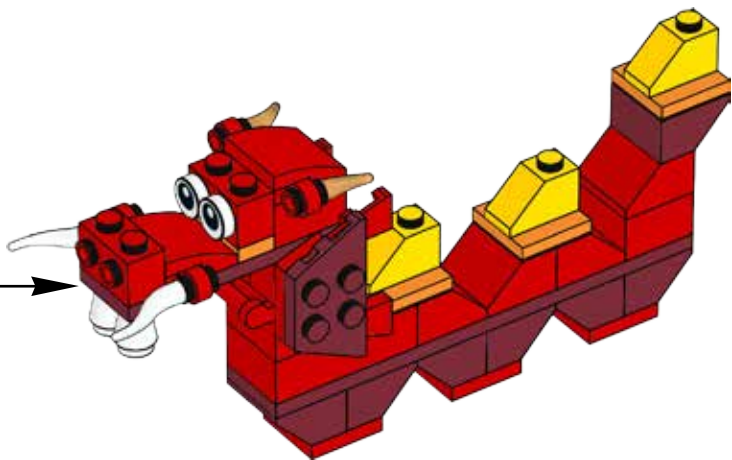

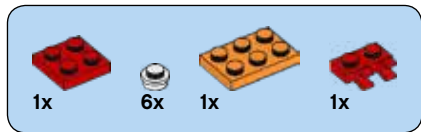

22

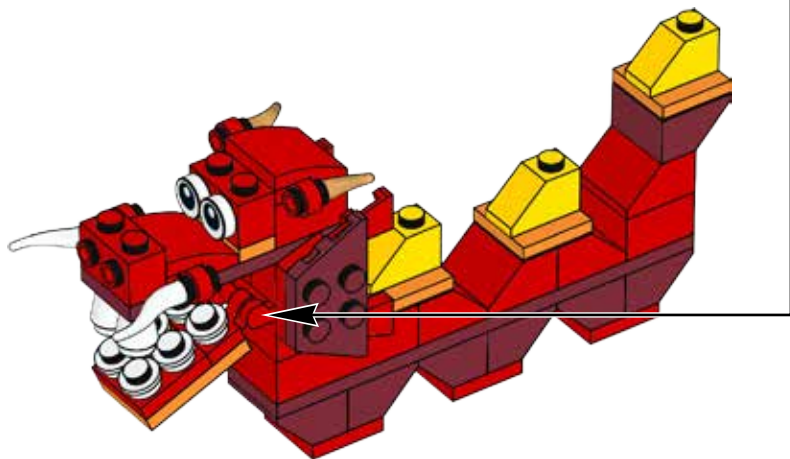



3x



3x

23

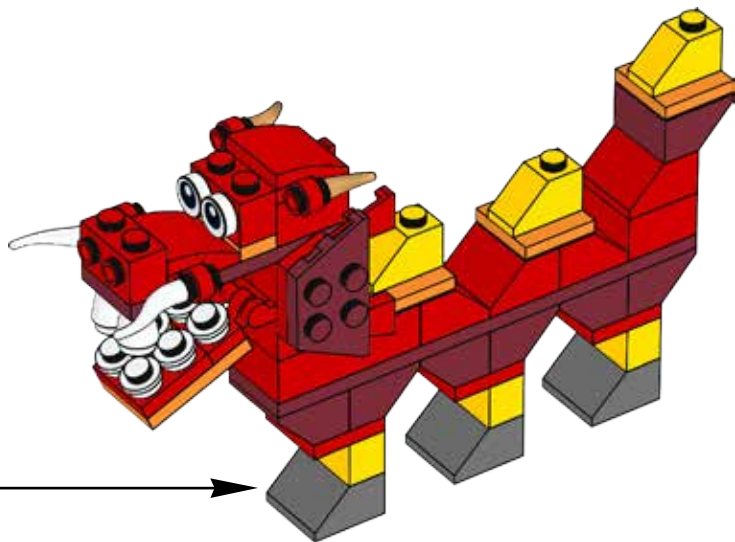

3x

**MORE IDEAS
ONLINE:**

**PLUS D'IDÉES
EN LIGNE :**

**MÁS IDEAS EN
INTERNET:**

LEGO.COM/classic





10698



10696



10692



10699



10700



10701





31060



31054



31055





4x
4518400



6x
614101



4x
6029156



3x
6097402



3x
6099548



4x
300501



2x
6055541



2x
6097801



4x
6058177



4x
4532972



4x
300301



10x
303901



2x
4233370



4x
302101



2x
4530590

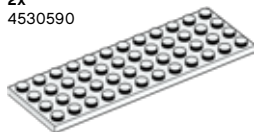

1x
4168072



4x
4121932



2x
6032360



3x
4161734



2x
4579260



4x
4125220



4x
4109995



4x
6092587



2x
6046924



4x
4114306



2x
4118866



4x
4121921



4x
4114309



2x
6139363



4x
4114319



1x
4114001



2x
4113988



4x
614321



4x
6019155



2x
4556153



2x
4226876



6x
302221



4x
6105976



4x
300321



4x
303921



4x
4632572



1x
449521



2x
6170523



2x
487121



8x
300121



4x
366621



4x
362221



4x
300521



2x
6072998

4x
362323

4x
4509443

4x
300223

4x
6141996

4x
4649773

4x
300123

2x
366623

1x
303423

4x
4529235

3x
614123

4x
300523

4x
300323

3x
614124

4x
4624985

8x
300424

4x
4121965

2x
6079007

4x
300324

4x
303924

4x
300224

4x
621524

4x
300323

1x
4561507

2x
6175158

2x
4181143

2x
303424

2x
4221775

2x
4504382

4x
300526

4x
4613162

4x
4578677

2x
4548180

4x
4515373

4x
4617848

4x
300426

4x
4568644

4x
428626

2x
460026

1x
4530589

2x
395726

4x
302026

4x
300126

2x
292626

4x
300528

4x
6112266

4x
4121969

4x
302228

4x
4644085

4x
4107637

1x
4583718

4x
4109674

3x
6170300

4x
4112838

















































2x
4141737























































3x
4566179

4x
4106356

2x
6102903

1x
4277361

 2x 6024020	 4x 4179830	 4x 4177932	 4x 4527943	 4x 6172869	 2x 6093064
 4x 4167842	 4x 4626883	 4x 6078590	 4x 6030276	 3x 6170306	 4x 6015454
 4x 622740	 4x 6000881	 4x 6013635	 4x 4164037	 4x 6101073	 4x 6184880
 4x 3006841	 2x 4179828	 4x 4153825	 4x 4164022	 2x 6022656	 4x 4249891
 4x 306541	 4x 4650970	 4x 4251969	 4x 4220632	 2x 6037652	 4x 4528981
 4x 6107790	 2x 6101858	 4x 4125278	 4x 4234716	 4x 6037658	 2x 4540280
 2x 4650500	 4x 4153827	 4x 4153827	 4x 6092671	 4x 6066120	 4x 6142695
 4x 306544	 1x 4654448	 2x 4189007	 4x 4165967	 1x 6170921	 2x 4667595
 4x 3006848					

 4x 6092771	 4x 4539061	 4x 6024286	 2x 6075213	 2x 6058130	 4x 4515374	 4x 4211088
 4x 4245570	 4x 6117418	 4x 6122504	 4x 4223303	 1x 4211211	 4x 4211387	 4x 4210978
 4x 6055241	 2x 6089268	 4x 6170916	 2x 4595814	 8x 4211412	 4x 4211428	 2x 4221745
 4x 6020923	 2x 4618986	 4x 6172370	 1x 4542131	 4x 4211506	 2x 4211504	 4x 4211039
 2x 4245566	 1x 6009130	 2x 6045944	 4x 4264755	 2x 4213567	 2x 6031056	 4x 4211135
 4x 4539082	 8x 6052917	 2x 6133815	 2x 6092659	 4x 4211764	 4x 4211356	 4x 4211094
 4x 4541544	 4x 6172766	 4x 6062574	 4x 4211201	 4x 4211398	 4x 4211385	 4x 4211054
	 4x 6172762	 1x 4624507	 8x 6022105	 2x 4529240	 4x 4648256	 1x 6118832



1x
4595710



2x
4211107



1x
4210678

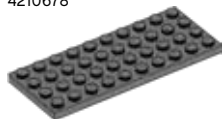

1x
4211122



2x
4618195



4x
4492224



4x
6132426



4x
6160819



4x
4621542



4x
4517993



4x
4580010



4x
4517995



4x
4550359



4x
4649743



4x
6002148



4x
6175307



4x
6022083



4x
6133822



4x
6147726



4x
6084028



2x
6097501



4x
6092604



4x
6174640



4x
6035470



4x
4626935



4x
4620909



4x
6092674



4x
4618647



4x
4655246



4x
4625032



4x
6173655



3x
6146866



4x
4625629



2x
4619653



3x
4633691



2x
4619636



4x
6136331



4x
4623598



4x
6107188



4x
6109901



4x
4619516



4x
4655173



2x
4649745



2x
6027624



4x
6163294



2x
6097055



2x
6037655



4x
6056283



4x
4651231



4x
4569382



4x
6174192



4x
4651232

Customer Service

Kundenservice

Service Consommateurs

Servicio Al Consumidor

LEGO.com/service or dial



: 00800 5346 5555

: 1-800-422-5346

WIN

GO TO WWW.LEGO.COM/PRODUCTFEEDBACK AND
GIVE US YOUR SHORT **FEEDBACK** ABOUT THIS
LEGO® SET FOR A CHANCE TO WIN
A COOL LEGO PRIZE.

Terms & Conditions apply

LEGO.com/productfeedback



GEWINNE



Erzähle uns auf
www.LEGO.com/productfeedback

etwas über die Erfahrungen, die du mit
diesem LEGO® Set gemacht hast, und
sichere dir die Chance auf einen coolen
LEGO Preis!

Es gelten die Teilnahmebedingungen

GAGNE



Rends-toi sur
www.LEGO.com/productfeedback

et donne-nous quelques commentaires sur
ce produit LEGO® pour avoir une chance
de gagner un prix LEGO !

Voir Conditions Générales

GANAN



Visita
www.LEGO.com/productfeedback

y envíanos tu opinión acerca de este set
LEGO®. ¡Participarás en el sorteo de un
premio LEGO!

Términos y Condiciones aplicables

获取奖品



登录
www.LEGO.com/productfeedback

给出关于此乐高®套装的简短反馈，
就有机会获得炫酷乐高奖品

《条款及条件》适用

LEGO and the LEGO logo are trademarks of the/son des marques de commerce du/son marcas registradas de LEGO Group. ©2017 The LEGO Group.

6195126