

ASSASSIN'S CREED

COLLECTOR CONSTRUCTION SETS



3x MA17003AKD
 2x AM74397AKD
 3x AM75332F
 2x AM18560ASD
 2x AM18560AKD
 1x MA07223DH
 6x MA07223ASD
 2x MA03328ASD
 1x MA03328AKD
 6x MA1312AKD
 4x AM74415AKD
 1x AM74300ASD
 1x AM74299ASD
 2x AM19999ASD
 5x MA0910F
 2x MA17127ASD
 2x MA15258ASD
 4x AM15486AKD
 1x AM74214BTN
 2x MA04428ASD
 2x AM19900AKD
 2x AM18287AKD
 2x MA1086ASD
 1x AM18630AKD
 2x MA17201ASD

1x MA19327AKD
 1x MA022501DH
 1x AM73758DH
 3x MA09393DH
 1x MA09393AKD
 9x MA09393ASD
 2x MA07590DH
 1x AM17407AKD
 1x AM18901ASD
 4x MA16975AKD
 8x MA16954DH
 2x AM18667ASD
 2x AM74428ASD
 1x AM74428DH
 10x AM18014ASD
 1x MA09013ASD
 1x MA18665AKD
 1x MA18666AKD
 1x AM18293AKD
 1x MA74677AKD
 4x AM74657ASD
 2x MA04429AKD

4x MA72000AKD
 2x AM09270AKD
 4x MA18223ASD
 2x MA03484ASD
 2x MA03485ASD
 1x MA03484AKD
 1x MA03485AKD
 2x MA0948ASD
 4x AS-CNG12-02
 4x MA0948AKD
 1x MA03773AKD
 1x MA09267DH
 1x MA09268DH
 1x AM16967DH
 4x MA1154ASD
 4x MA18671AKD
 2x M09023W
 2x MA1314AKD
 2x MA1314ASD
 4x MA16384ASD

1x MA03772DH
 3x MA03772ASD
 2x MA03772AKD
 2x AM18593AKD
 1x AM17408AKD
 1x AM19899DH
 1x AM19898DH
 2x AS-CNG12-03
 2x AS-CNG12-04
 1x MA09838AKD
 5x MA09838ASD
 8x MA09838DH
 4x MA09593ASD
 2x MA09593DH
 2x AM17116AKD
 2x MA1087ASD
 1x MA09493DH
 1x MA09493AKD
 4x AM17056ASD
 1x AM03324ASD
 1x AM03323ASD

1x AM72904AKD
 1x AX-CNG11-02
 3x AM16764F
 1x AM17793ASD
 2x MA07475ASD
 1x MA07475AKD
 6x MA16331AKD
 2x MA16331ASD
 1x MA16331DH
 2x MA09292ASD
 4x MA1313ASD

1x MA17054DH
 4x AM75960ASD
 2x MA1480AKD
 2x MA1480ASD
 2x MA18298ASD
 1x MA09922ASD
 1x MA08483AKD
 1x MA08483ASD
 1x MA17845DH
 1x AX-CNG12-01

1x AM17870KC

1x AM09553AGV



1x FIG-CNG12-A

2x AM75871AGV



2x AM75876AKD
 1x AS-CNG12-01



1x FIG-CNG12-B

1x AM18567AKD



1x FIG-CNG12-D



1x FIG-CNG12-C

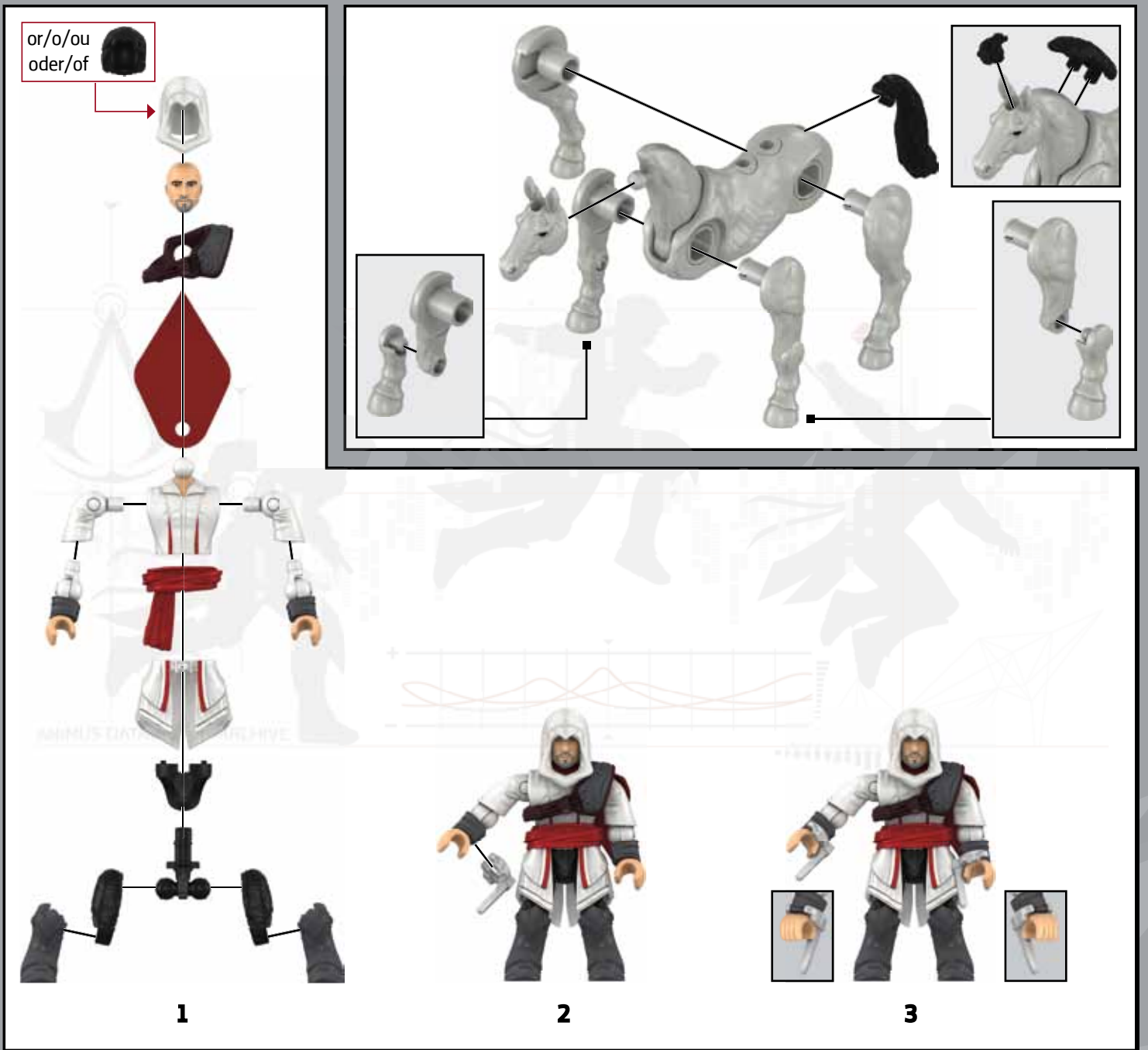

Please read these instructions carefully before first use and keep them for future reference.
 Il est recommandé de lire attentivement ce feuillet avant la première utilisation et de le conserver pour référence future.
 Leer estas instrucciones cuidadosamente antes de la primera utilización y guardarlas para referencia futura.
 Leia as instruções antes do primeiro uso e guarde-as para futura referência.

Leggere le istruzioni prima di cominciare ad usare il gioco e conservarle per referenze future.
 Die Gebrauchsanleitung bitte durchlesen und aufbewahren.

Proszę uważnie przeczytać instrukcję obsługi przed pierwszym użyciem, a następnie zachować ją na przyszłość.

Wij raden u aan deze handleiding zorgvuldig te lezen en te bewaren voor eventuele raadpleging op een later tijdstip.

Внимательно прочитайте инструкцию перед первым использованием и сохраните ее для дальнейшего использования.

Vær venlig at læse disse instruktioner omhyggeligt inden ibrugtagten og opbevar dem til fremtidigt brug.

Läs noggrant igenom dessa instruktioner innan du använder produkten för första gången och spara dem för ev. framtida frågor.

Les disse instruksjonene nøye før første gangs bruk, og ta vare på dem for fremtidige oppslag.

Lue nämä ohjeet huolellisesti ennen ensimmäistä käyttöä ja säilytä ne myöhempää tarvetta varten.

Διαβάστε αυτές τις οδηγίες προσεκτικά πριν χρησιμοποιήσετε το προϊόν για πρώτη φορά και φυλάξτε τις για μελλοντική αναφορά.

يرجى قراءة هذه التعليمات بدقة قبل البدء بالاستعمال والاحتفاظ بها كمرجع للمستقبل

请在初次使用前仔细阅读这些指示，并保留它们以便未来参考。

初めてご使用になる前に、この説明書をよくお読みください。また、本書は将来いつでも参照できるように保管してください。



ASSASSIN'S CREED

Collector Construction Sets
 Jeu de construction pour collectionneur
 Set de construcción para coleccionistas
 Jogos de construção para colecionador
 Kit di costruzione per collezionisti
 Sammler Bauset
 Kolekcjonerskie zestawy konstrukcyjne
 Bouwsets voor verzamelaars
 Коллекционные наборы конструктора



UBISOFT

© 2015 Ubisoft Entertainment.
 All Rights Reserved.

1

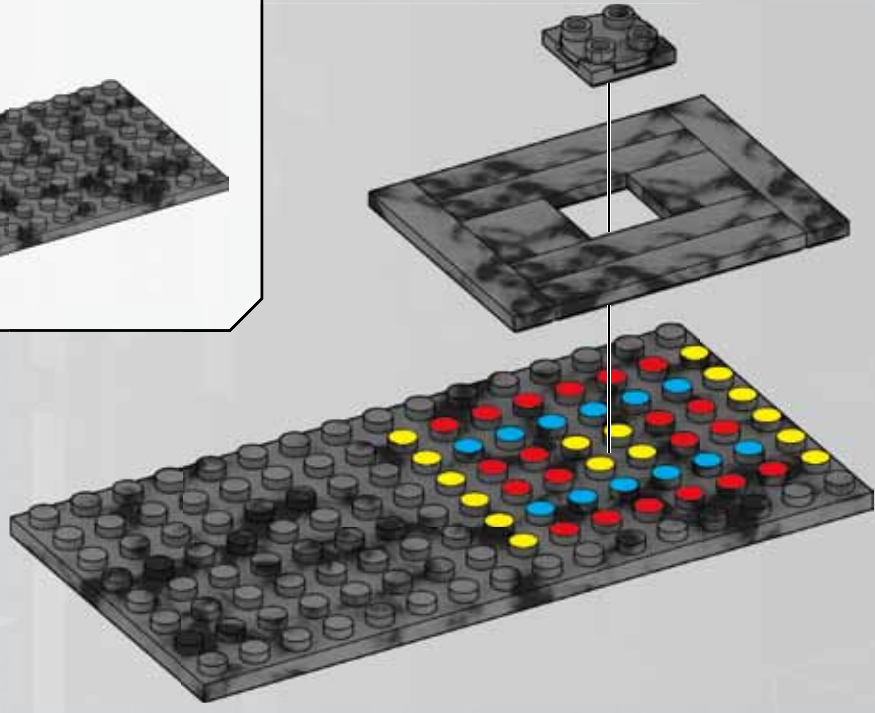
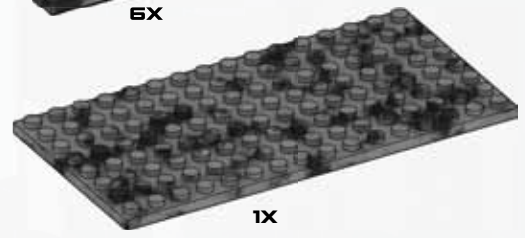
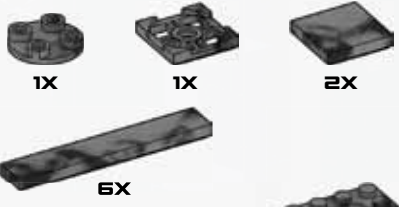

2

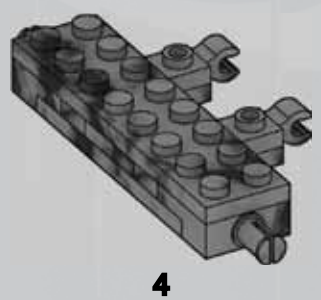
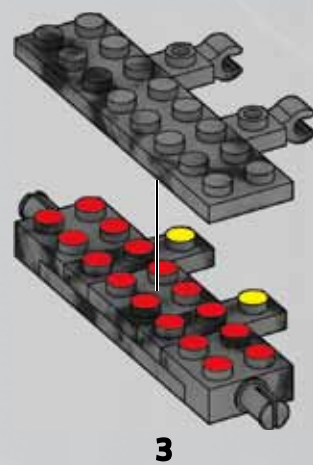
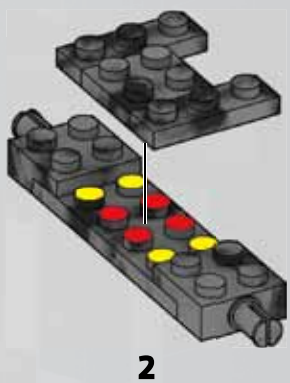
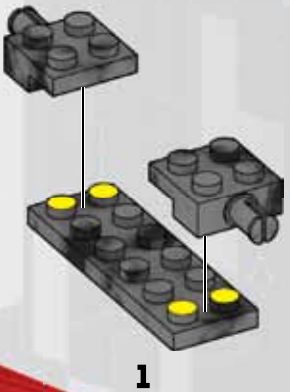
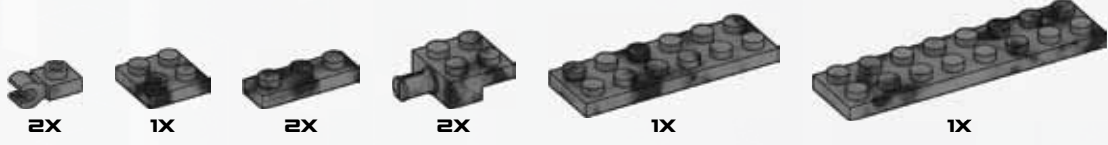

4

3



Place temporary pieces
 Placez les pièces temporaires
 Colocar piezas temporales
 Coloque peças temporárias
 Installare i pezzi temporanei
 Vorübergehende Teile platzieren
 Umieścić elementy tymczasowe.
 Plaats tijdelijke bouwstenen
 Установите временные детали
 Placér midlertidige stykker.
 Placera temporära delar
 Plasser midlertidige deler
 Aseta väliaikaiset osat
 Τοποθέτηση προσωρινών κομματιών
 ضع القطع المؤقتة
 放置临时件
 暫定ピースを配置してください

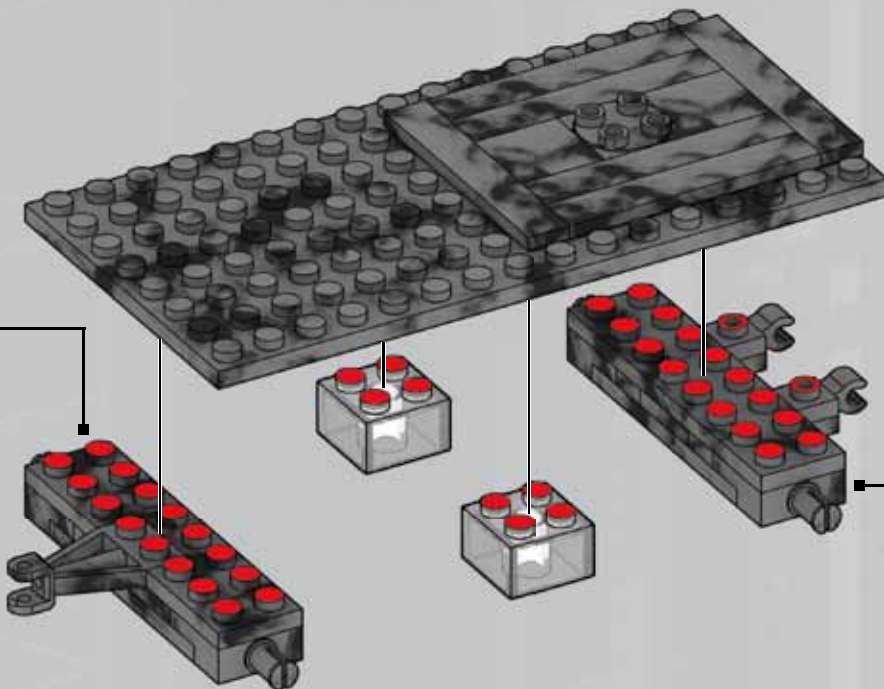
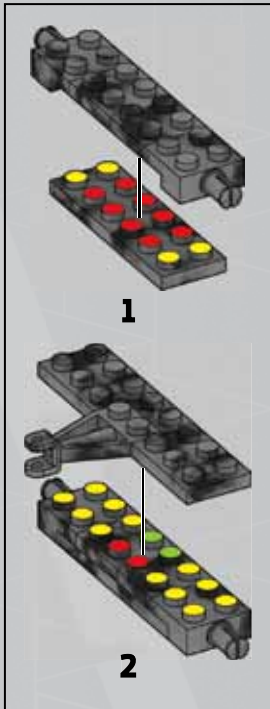

4

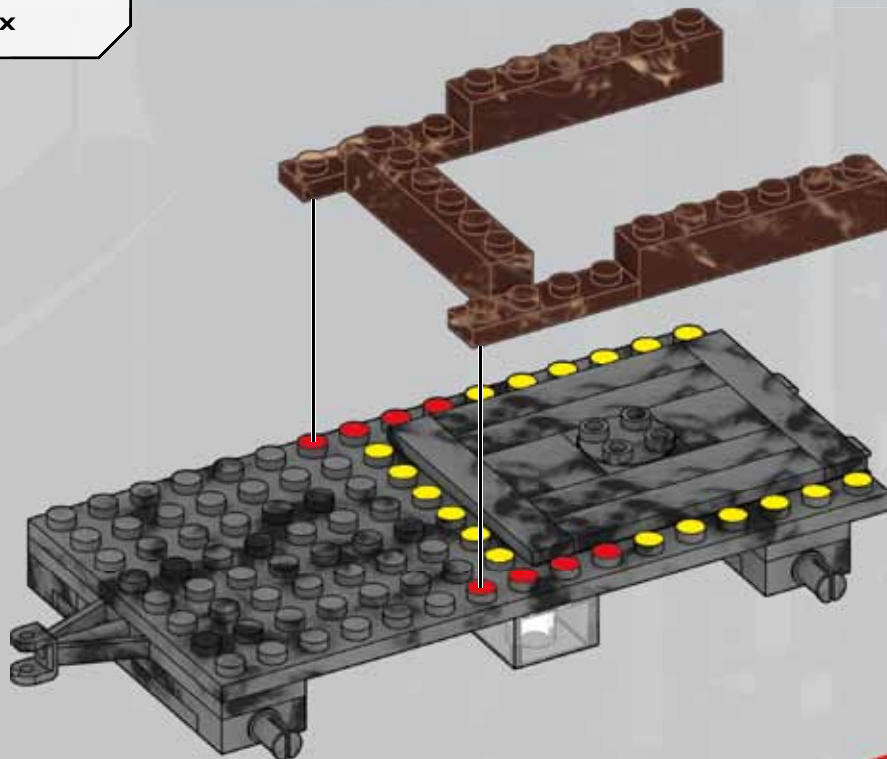

5



6

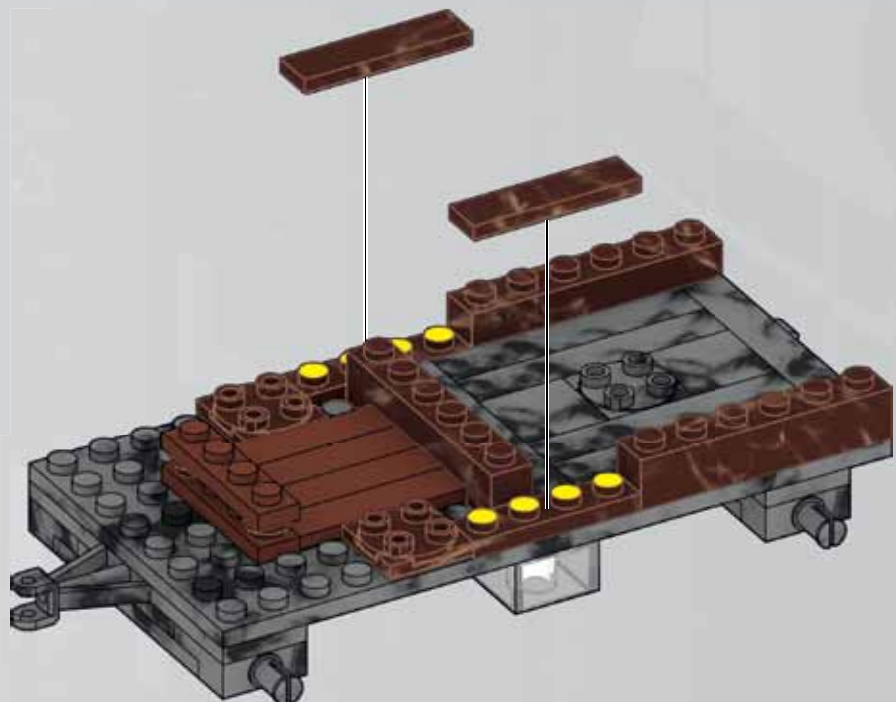

6

7



2x



2x



2x

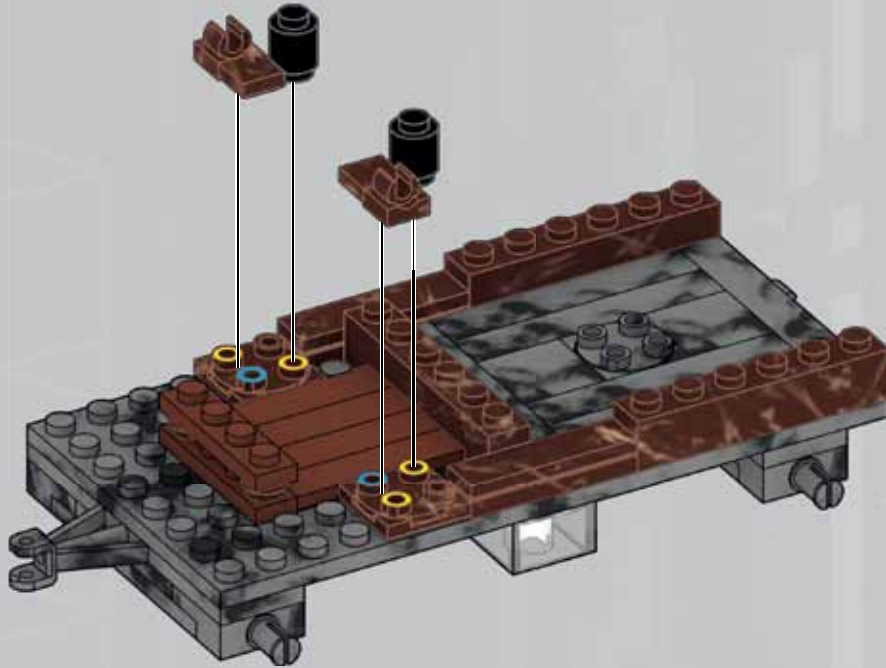

8



2x

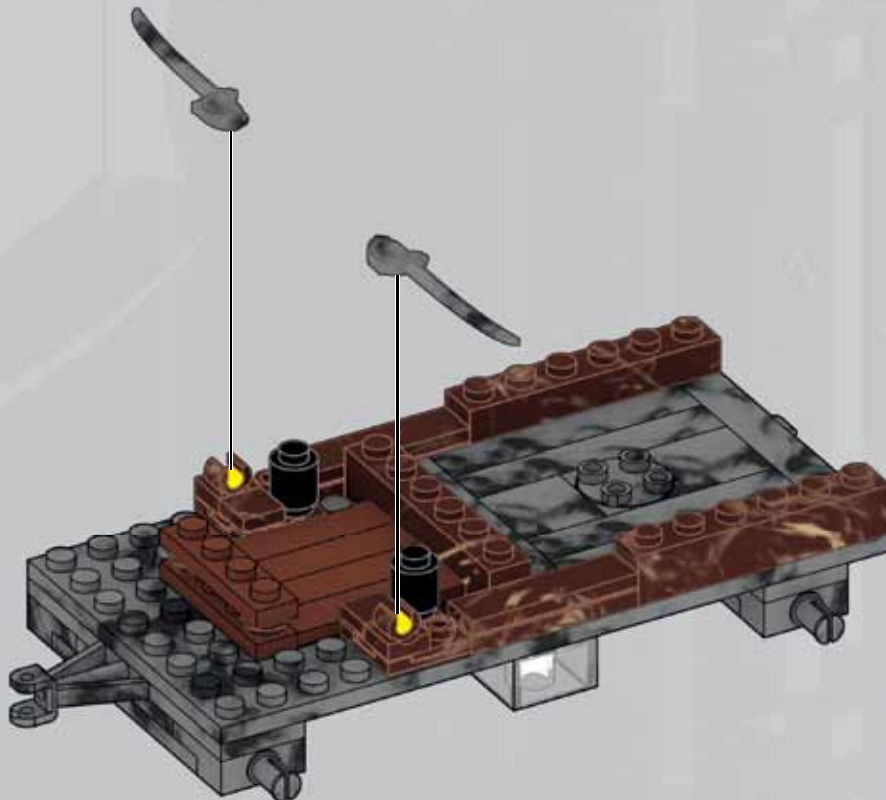

9



2x



4x

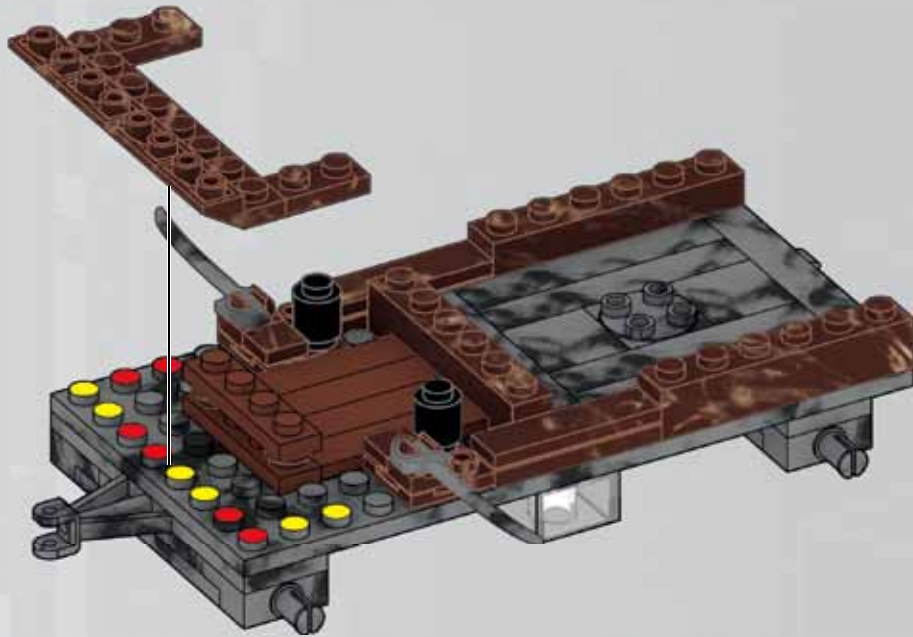

10



2x



2x



2x



11

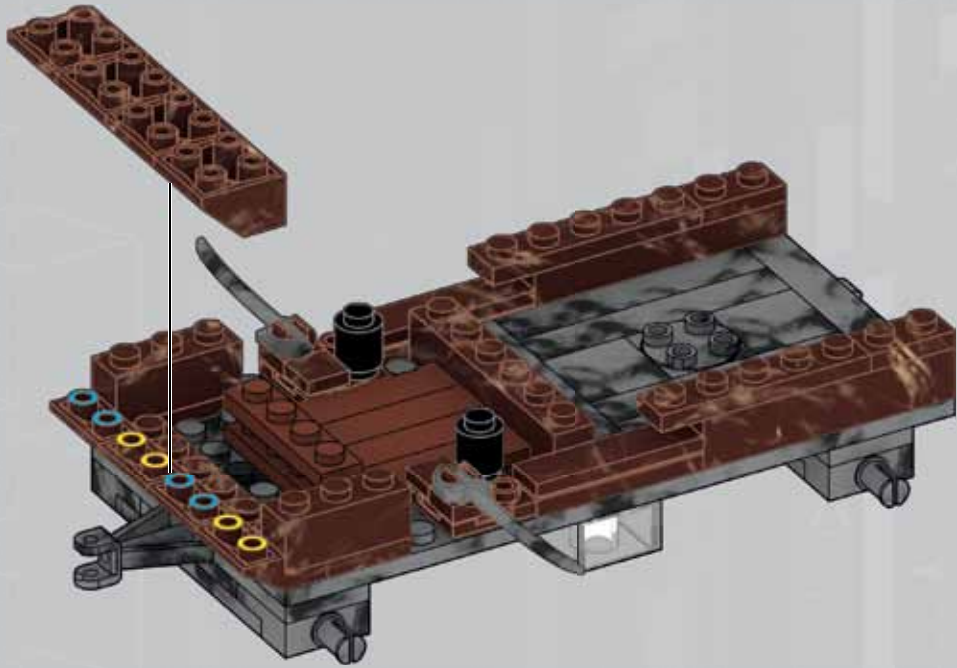

12

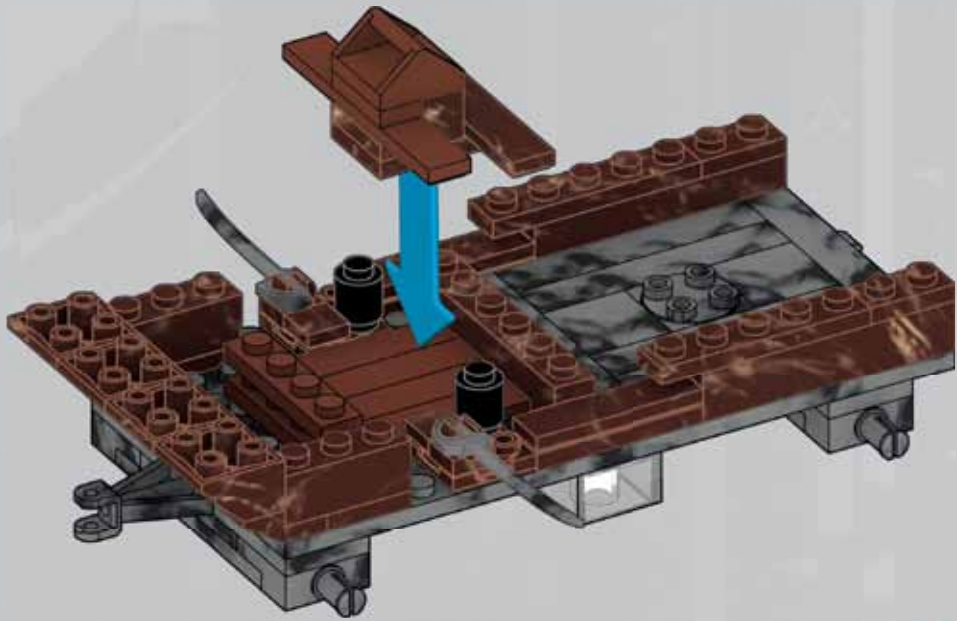
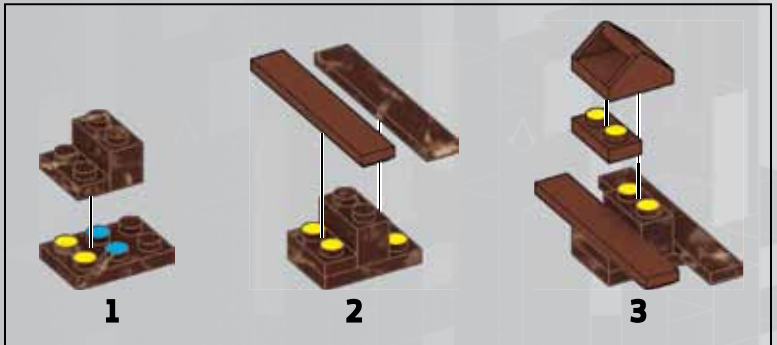
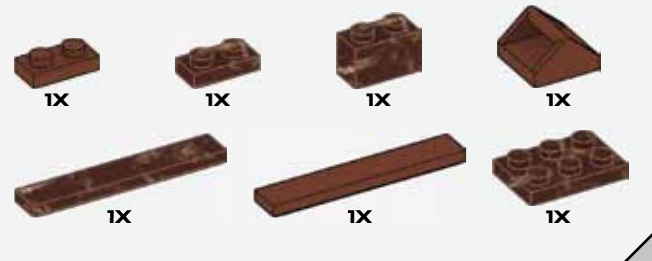

13

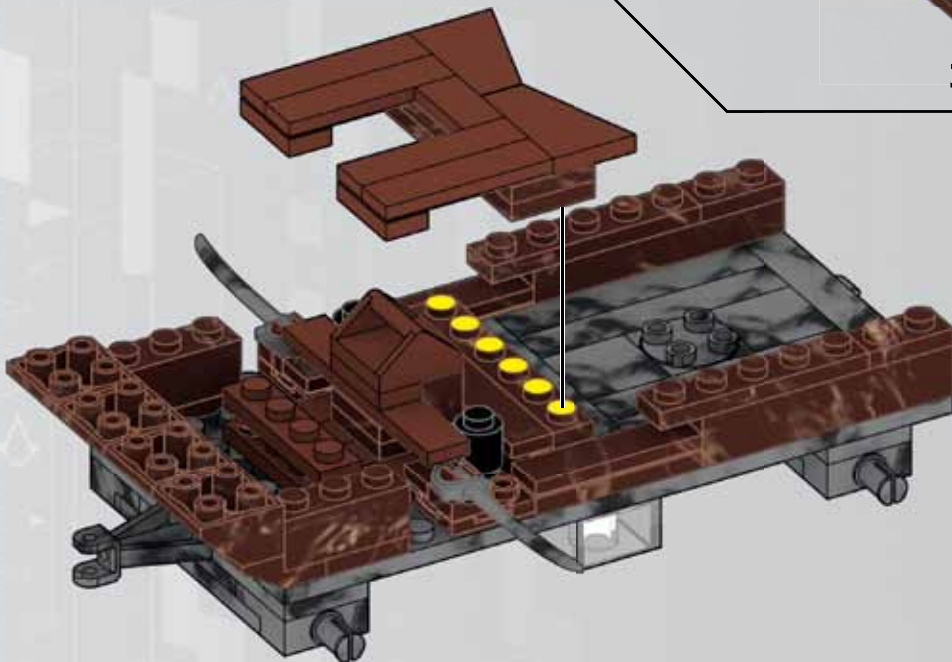
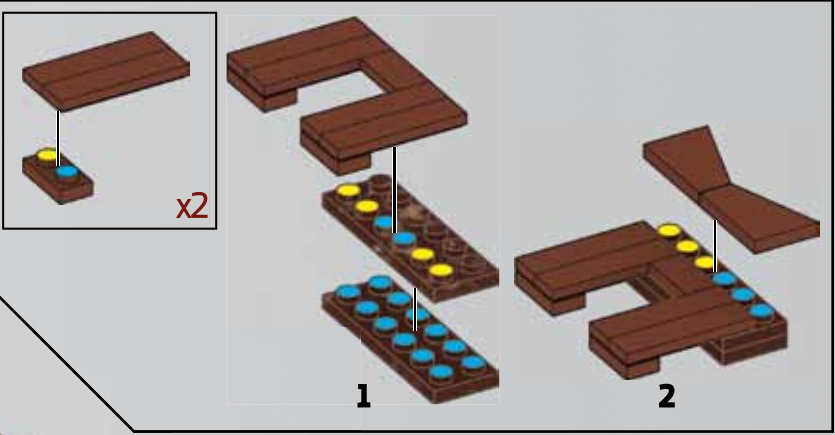
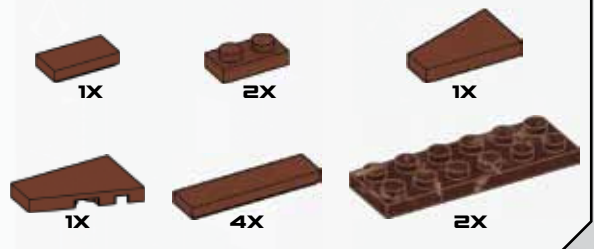

14

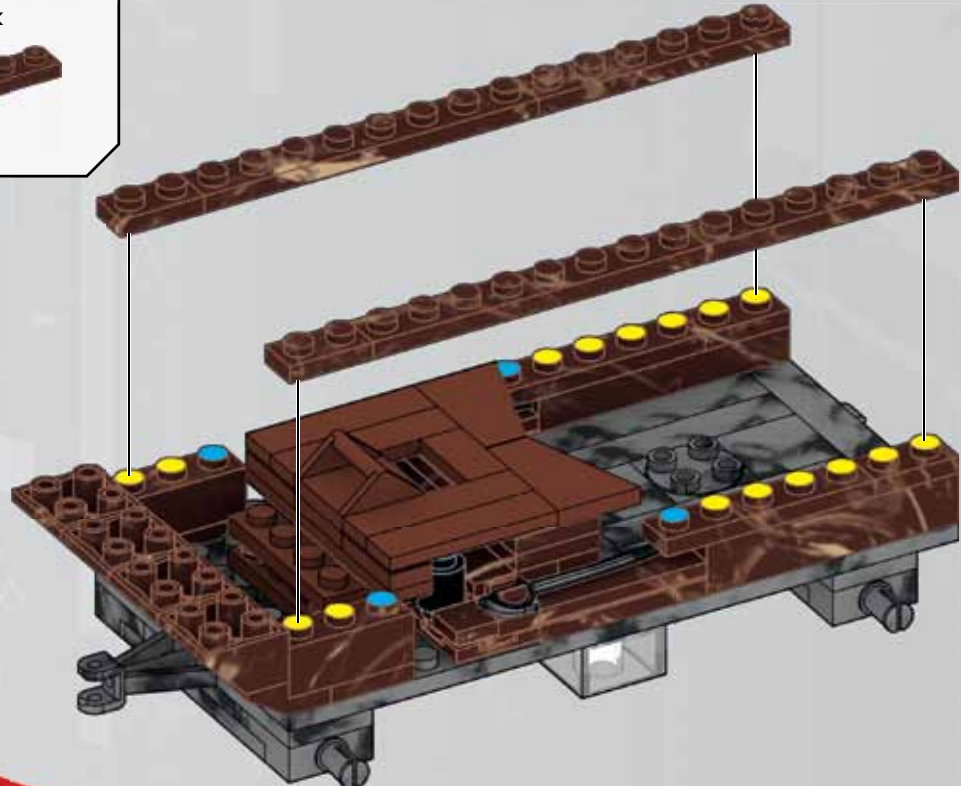
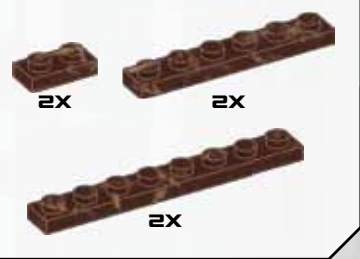

15



1x



1x



2x

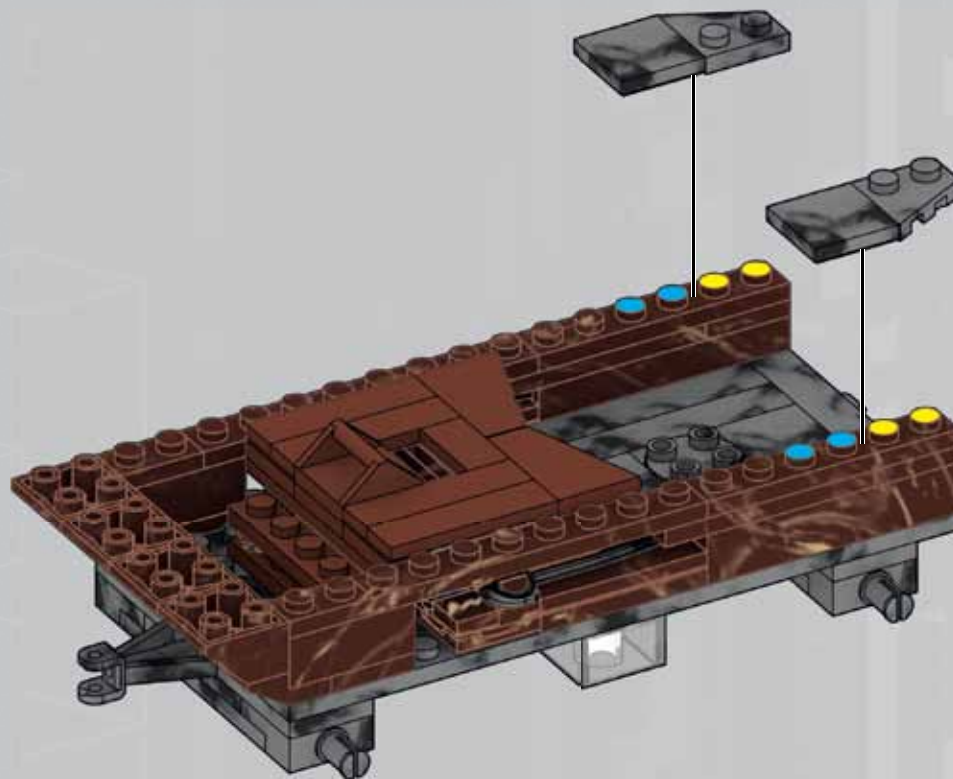

16



8x

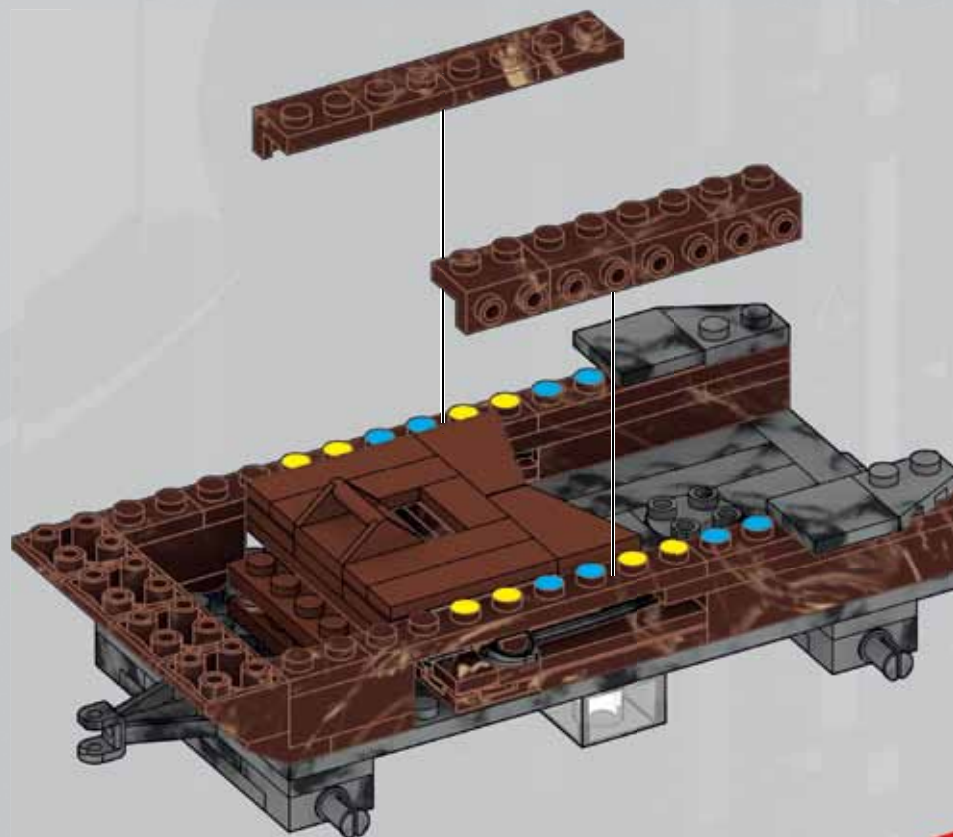

17

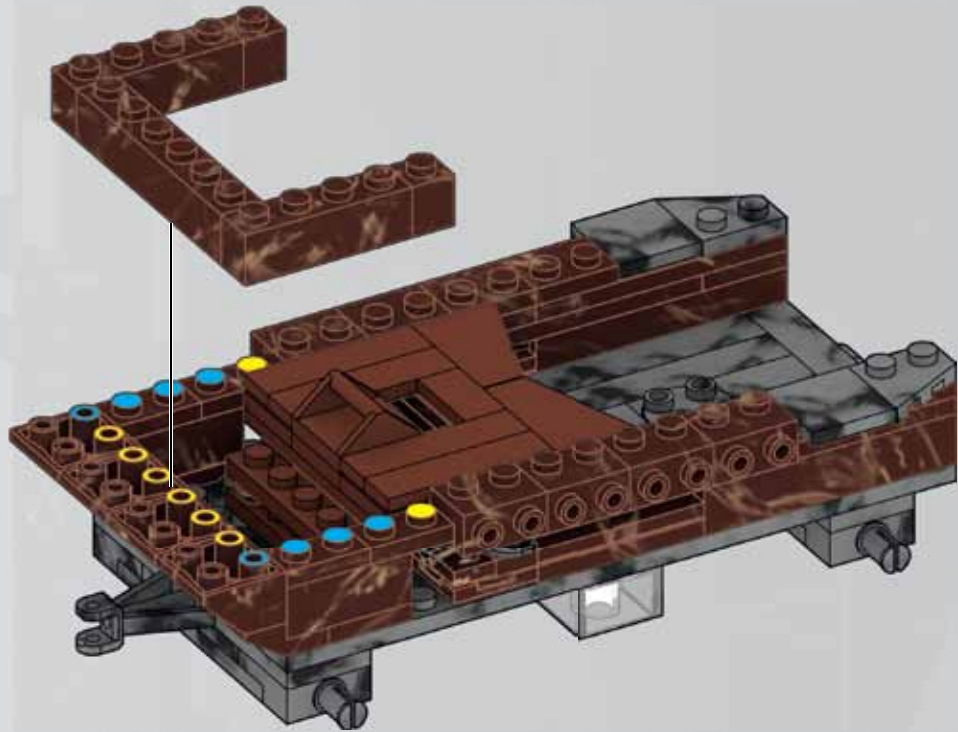

18

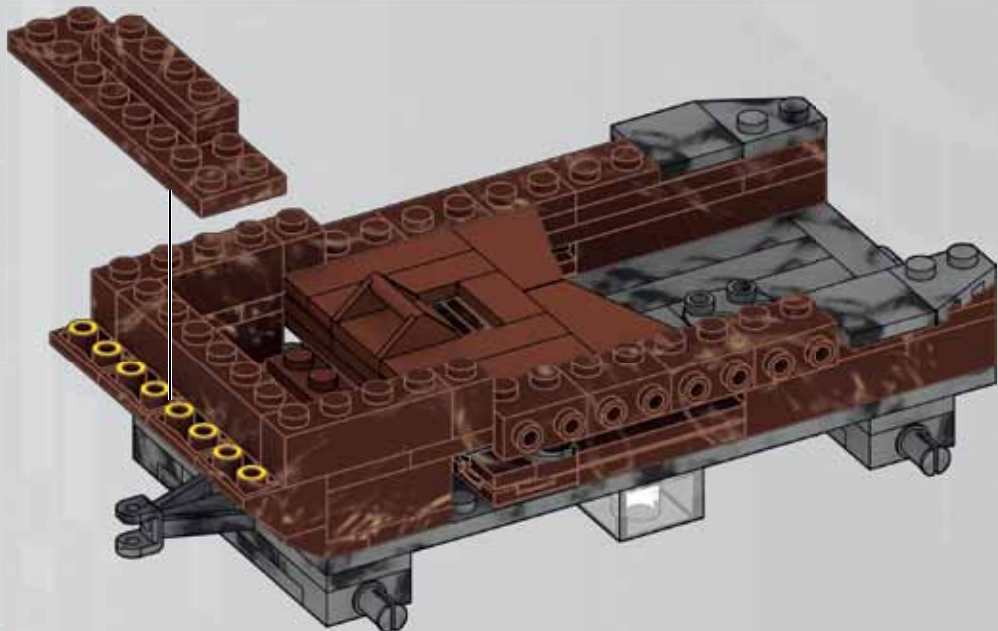
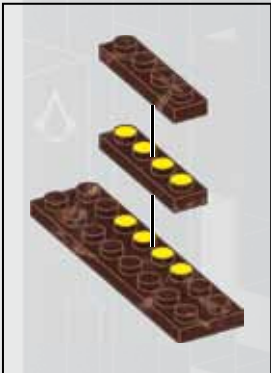

19

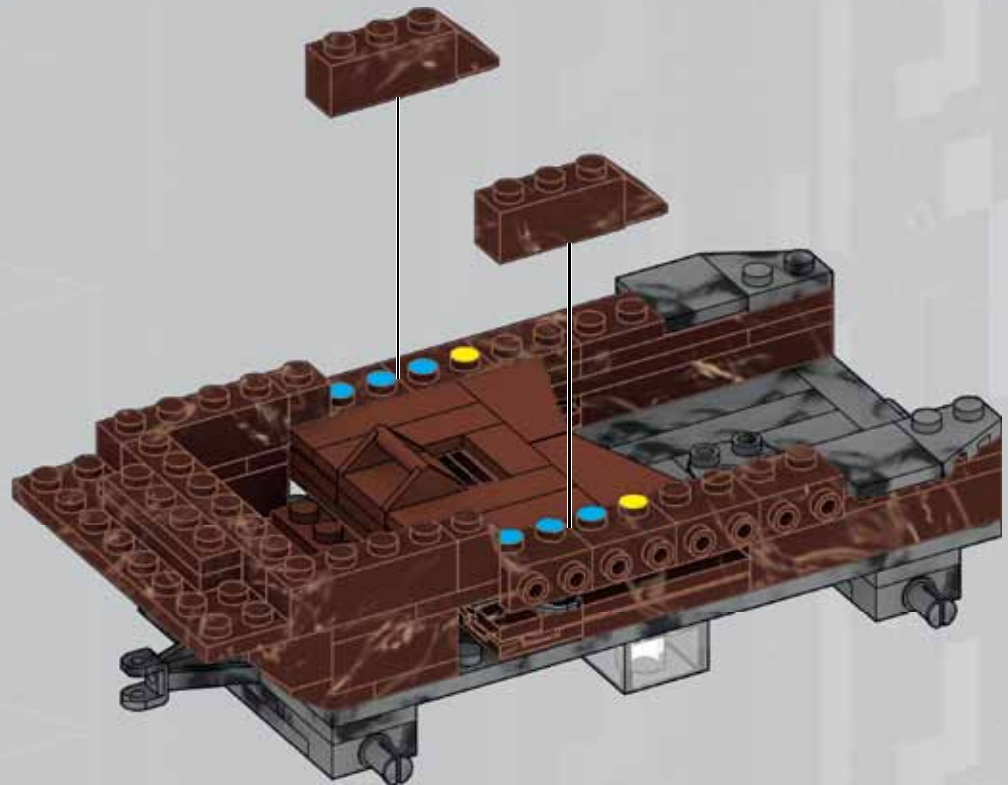

20

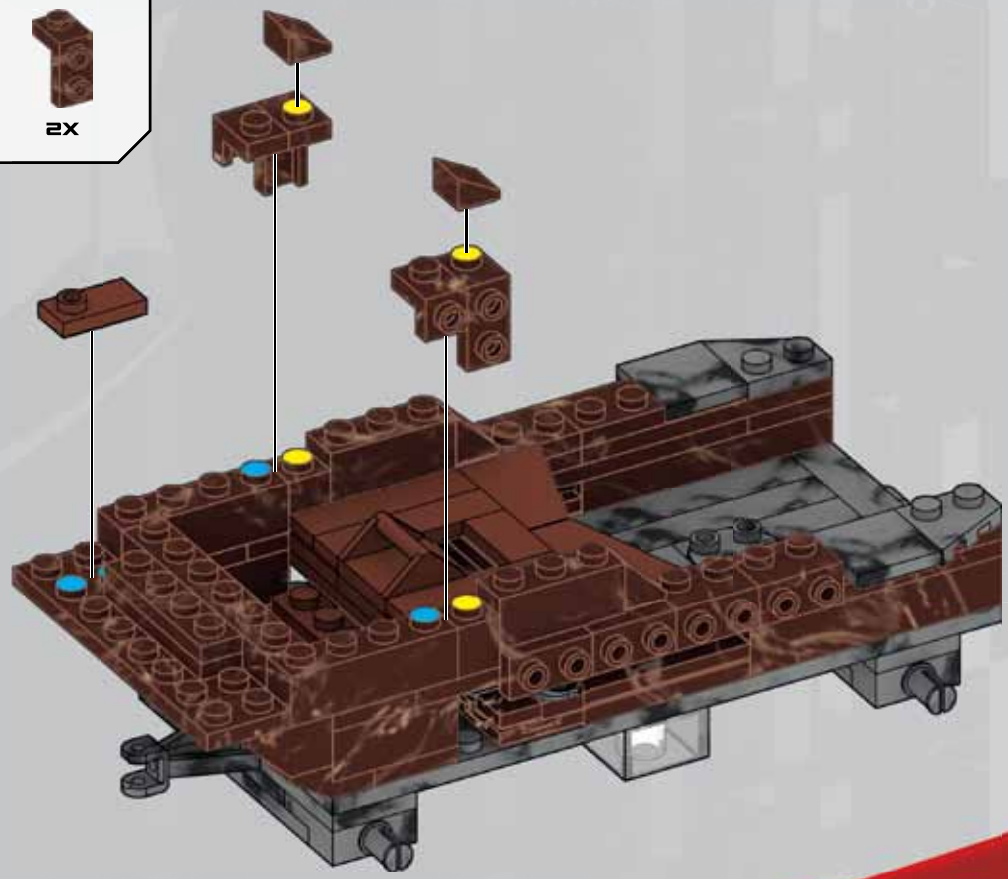

21

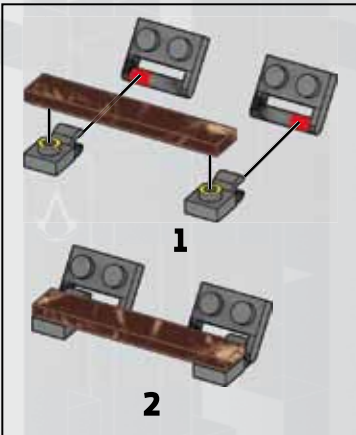
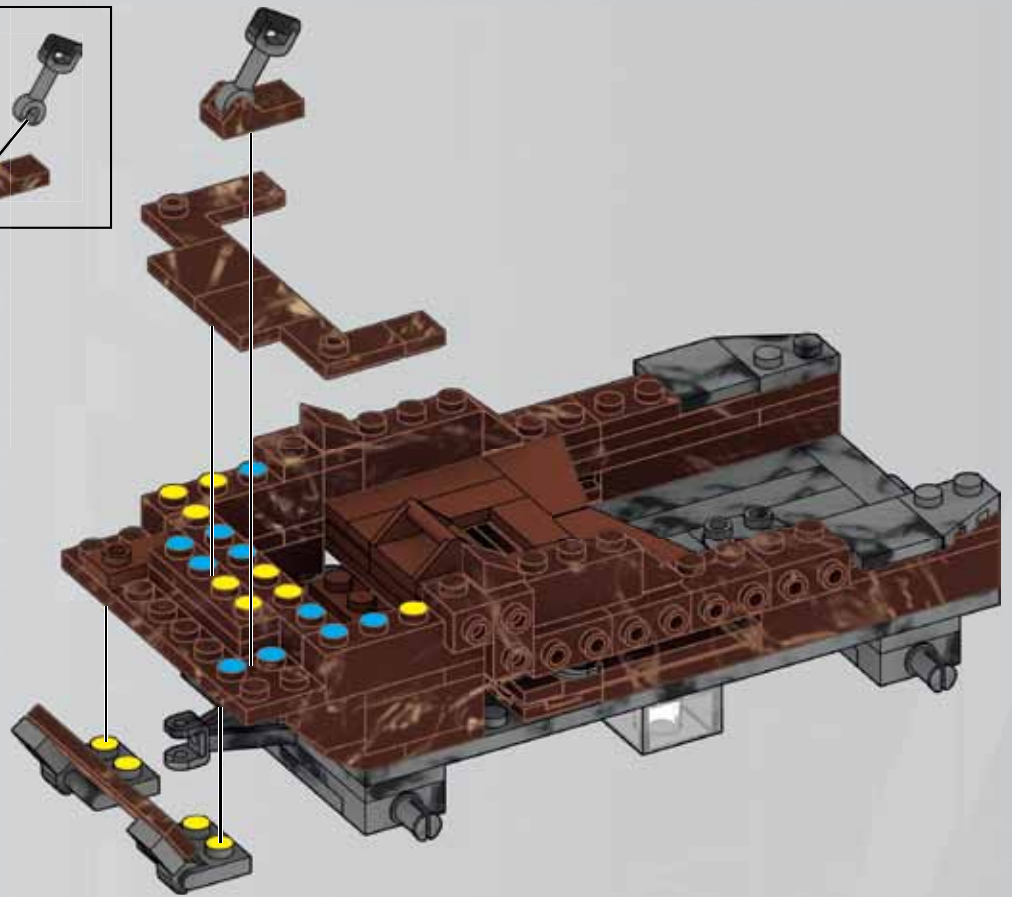

22

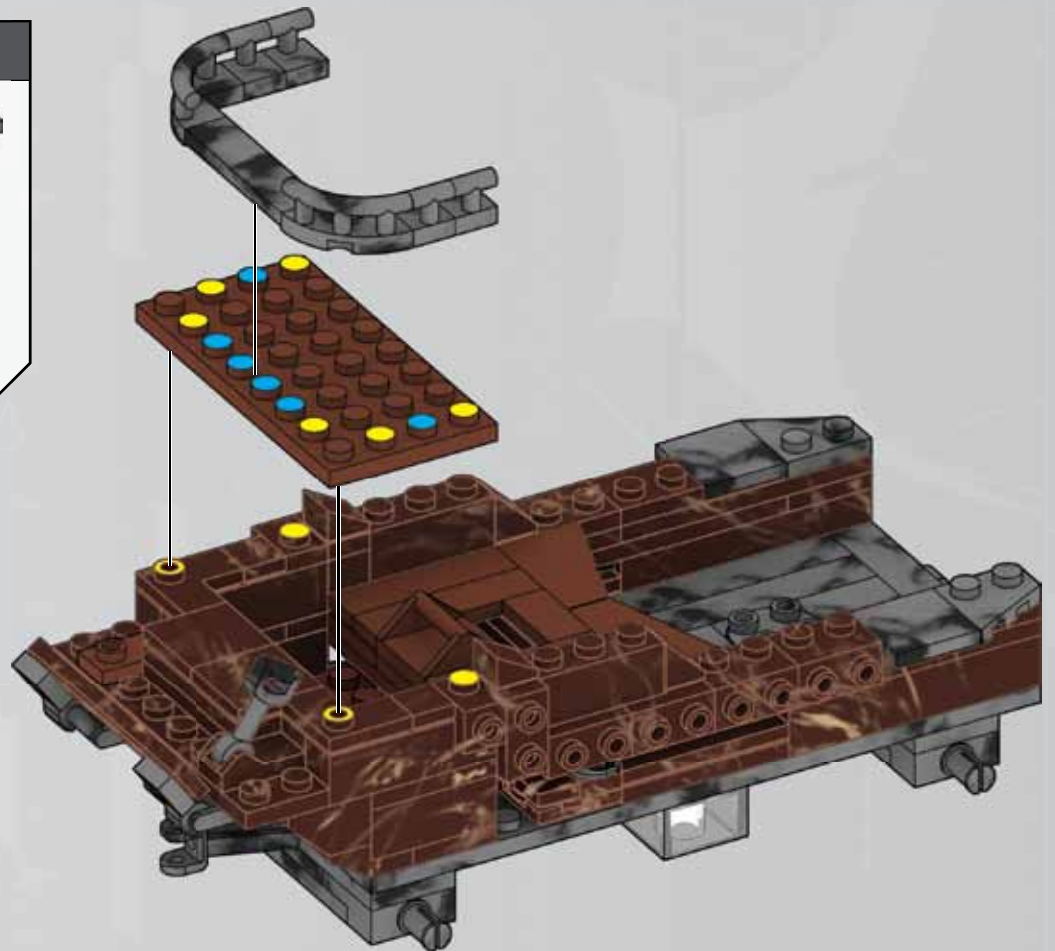
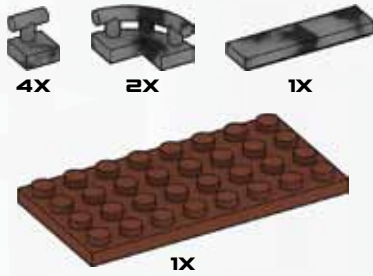

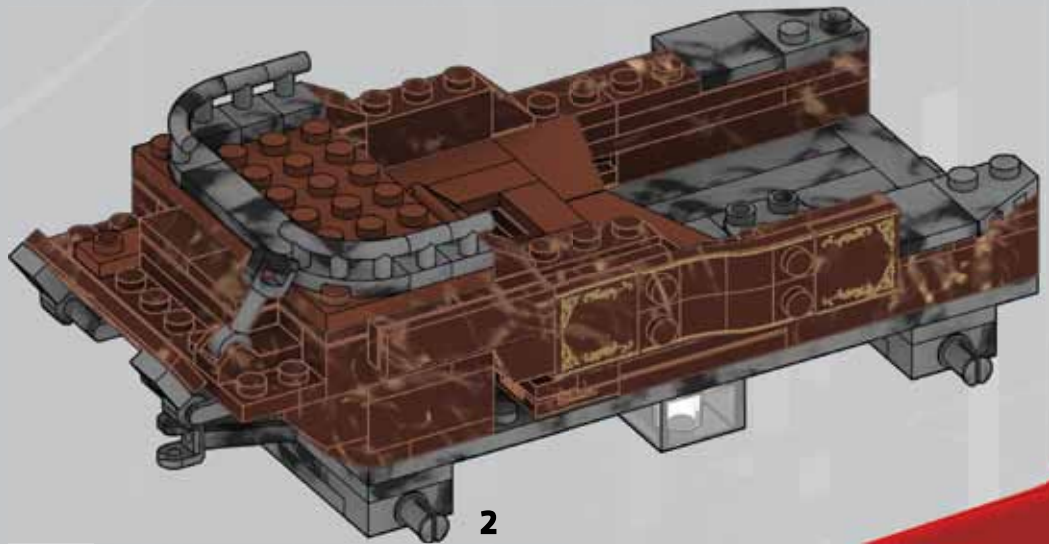
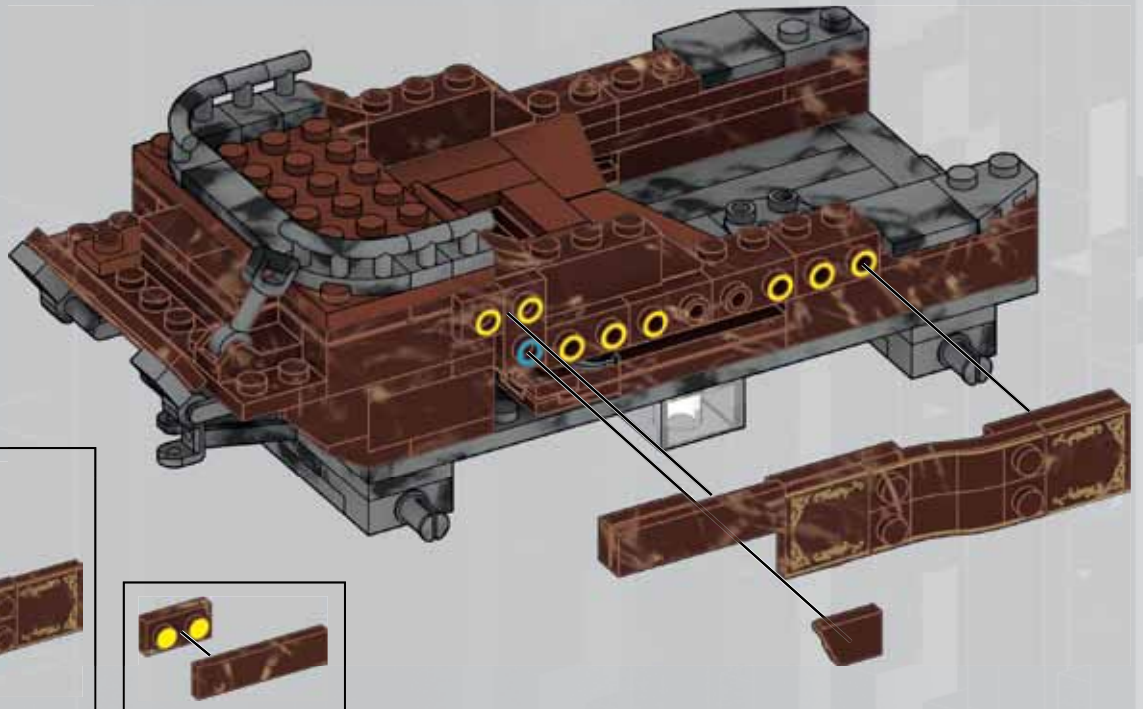

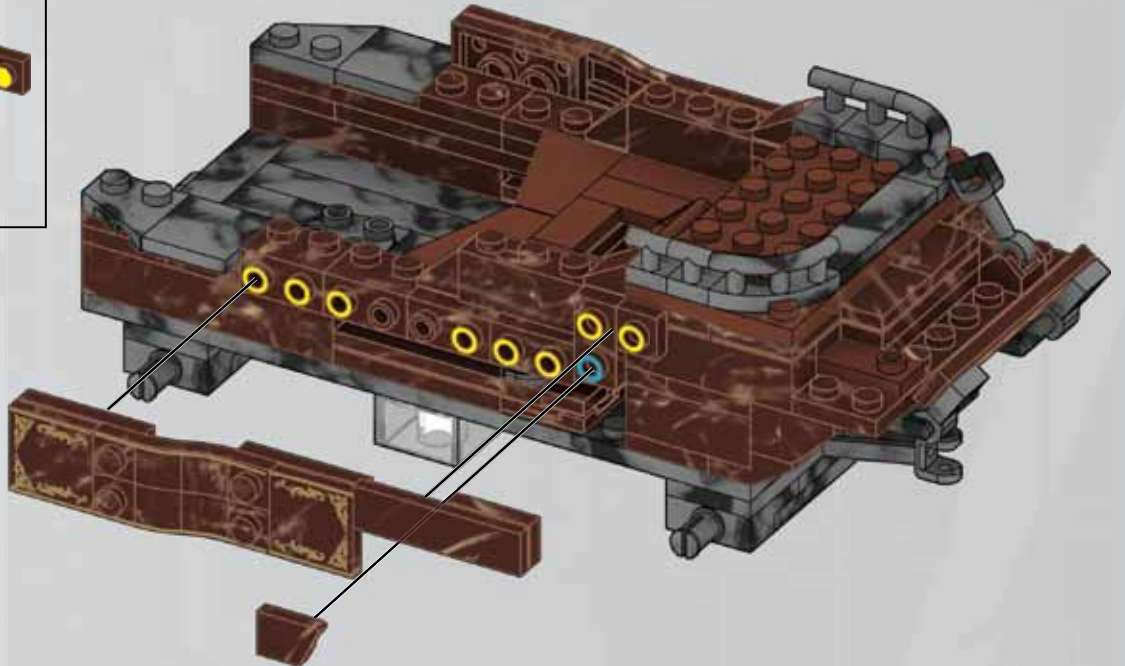
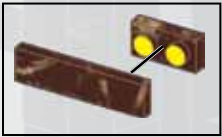
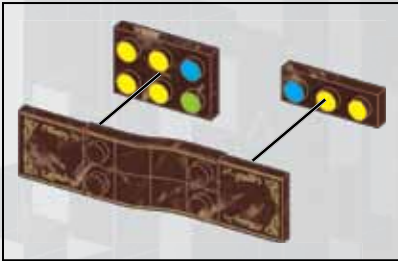

1

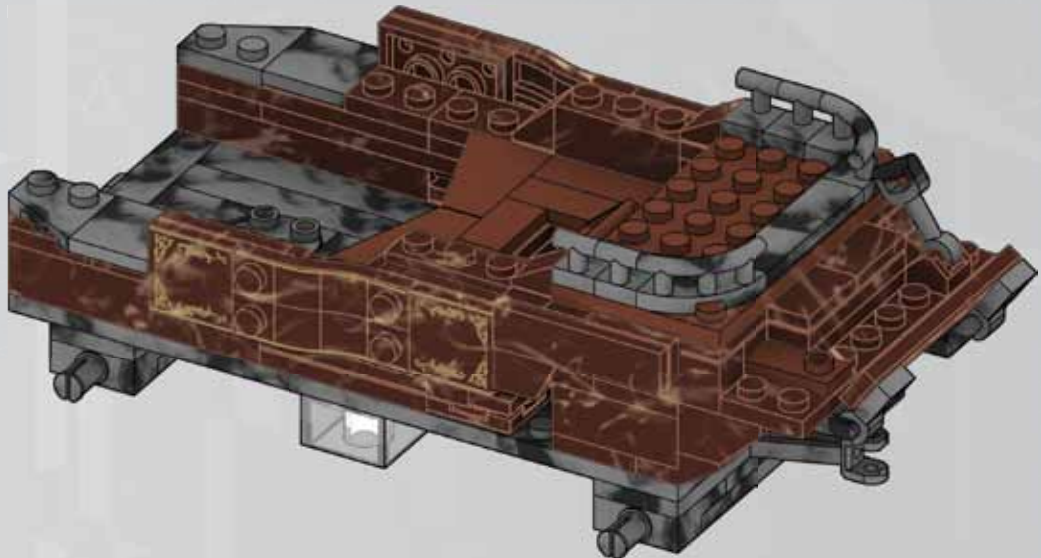

2

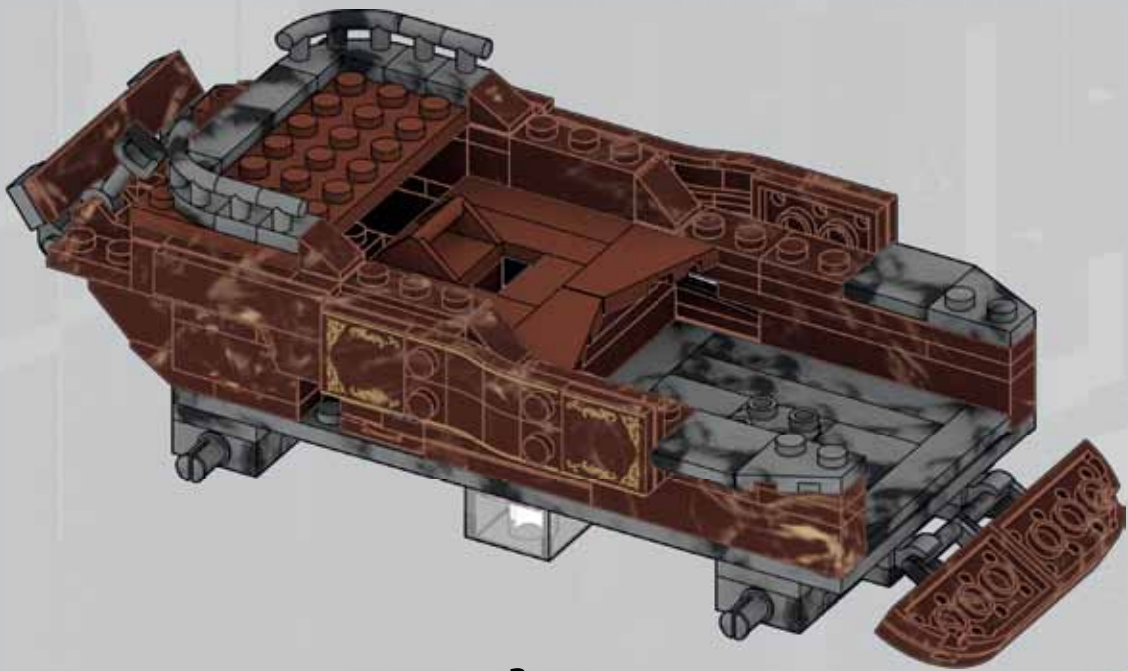
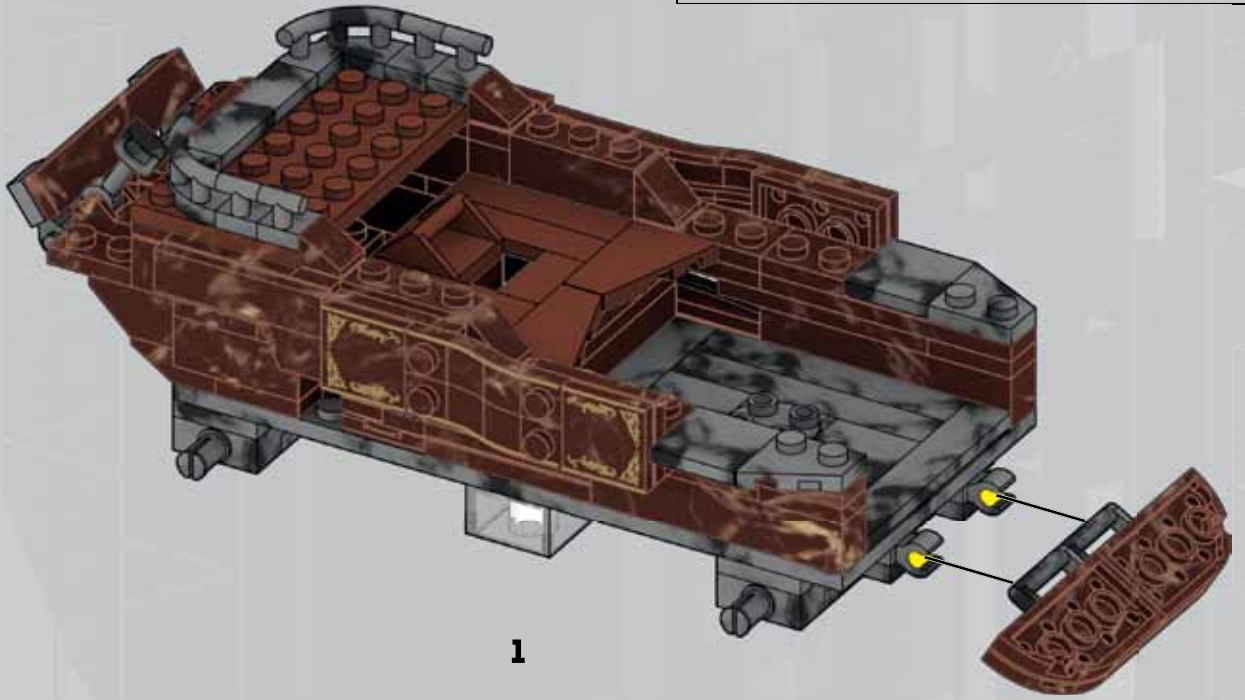
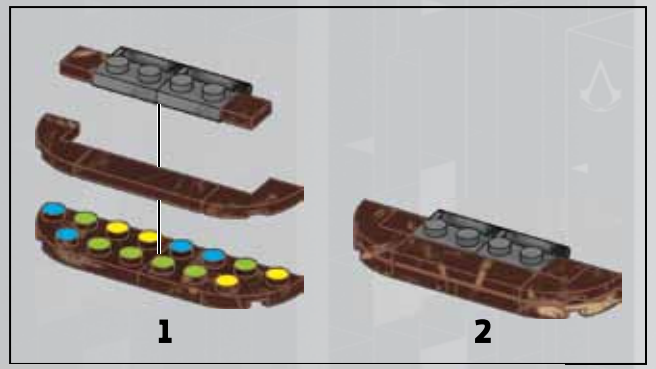

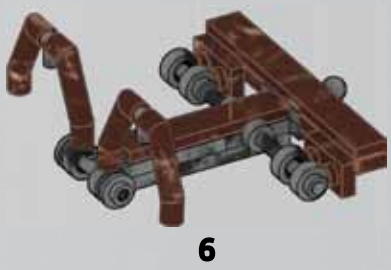
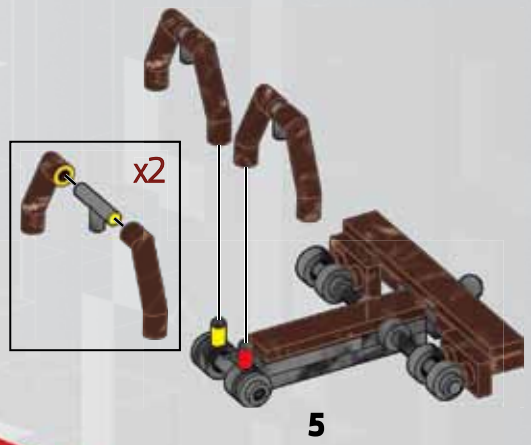
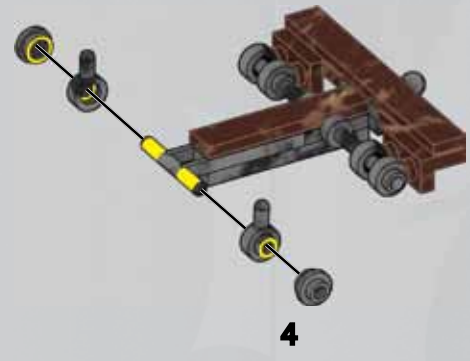
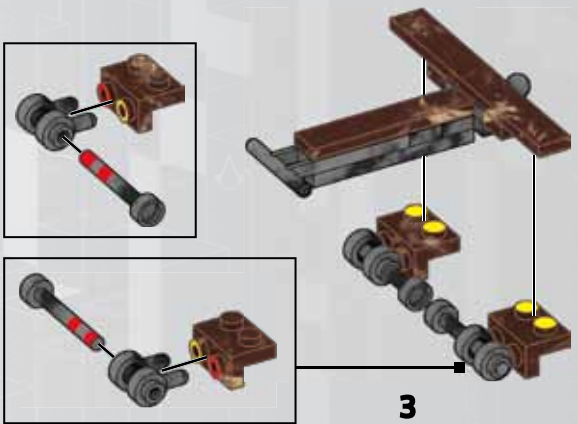
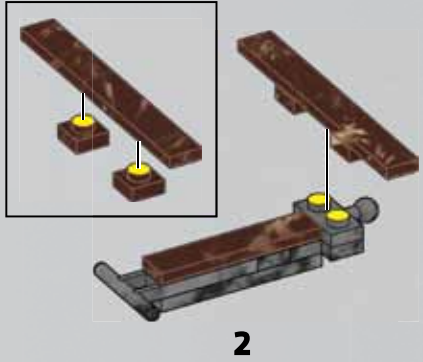
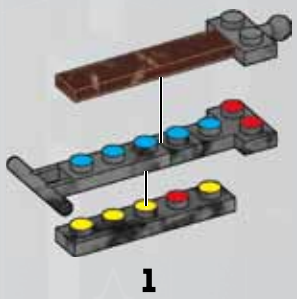
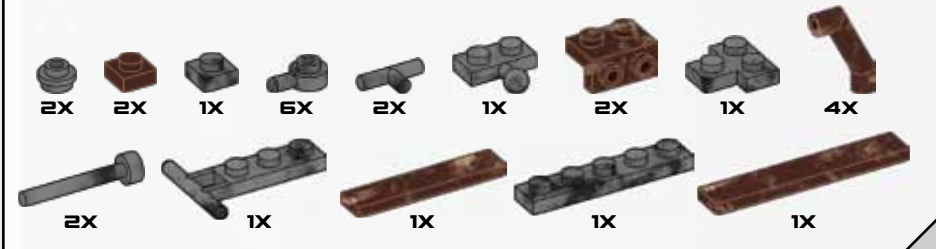

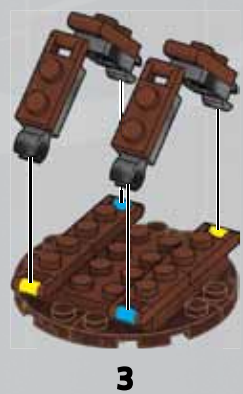
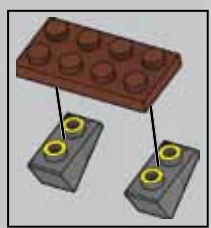
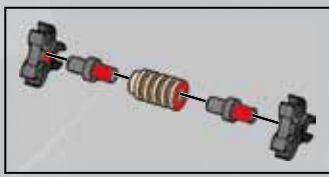
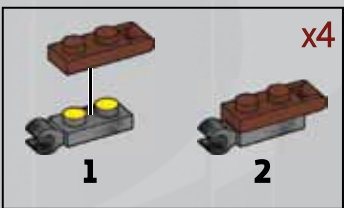
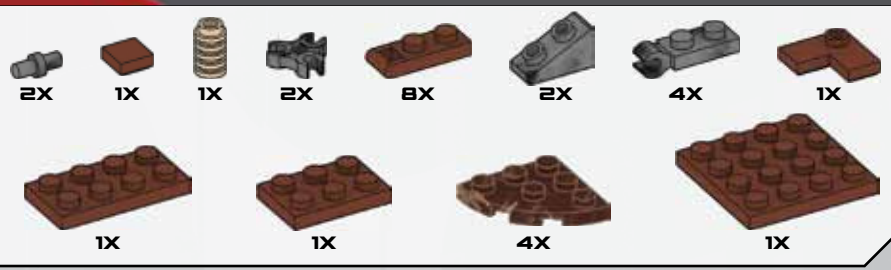
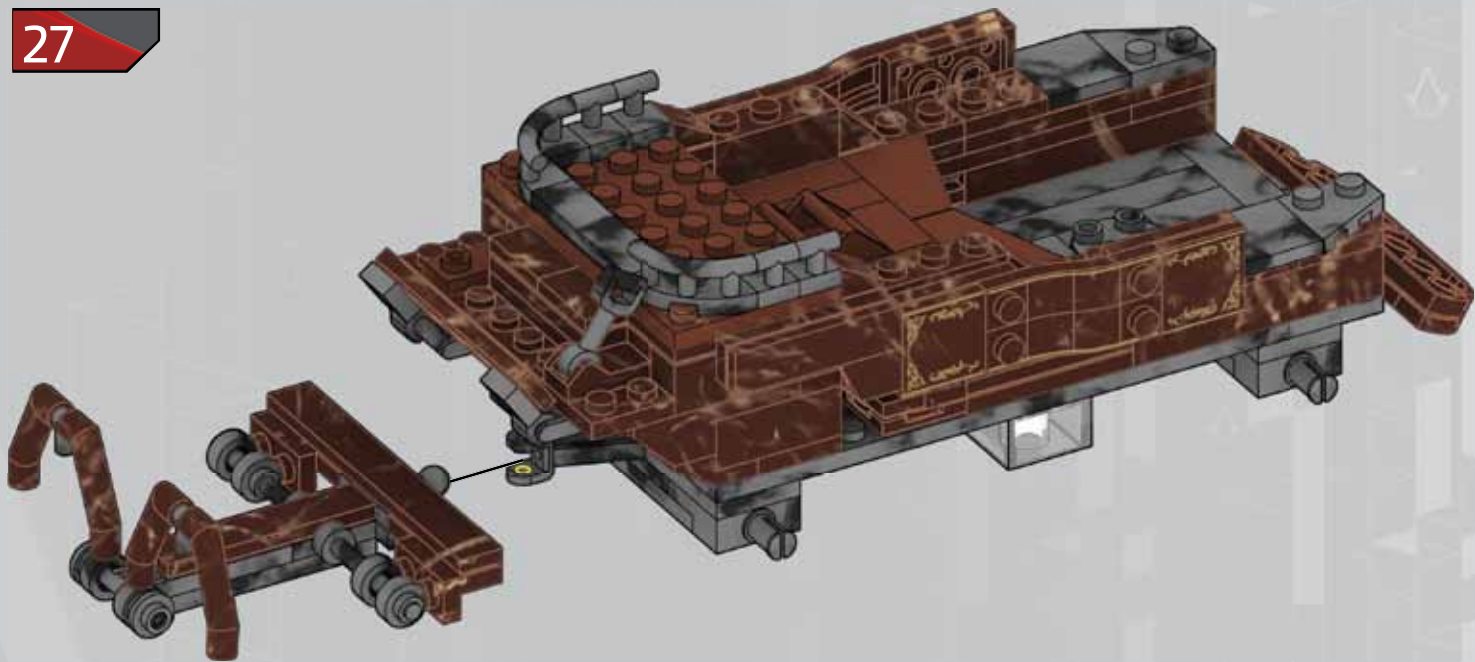

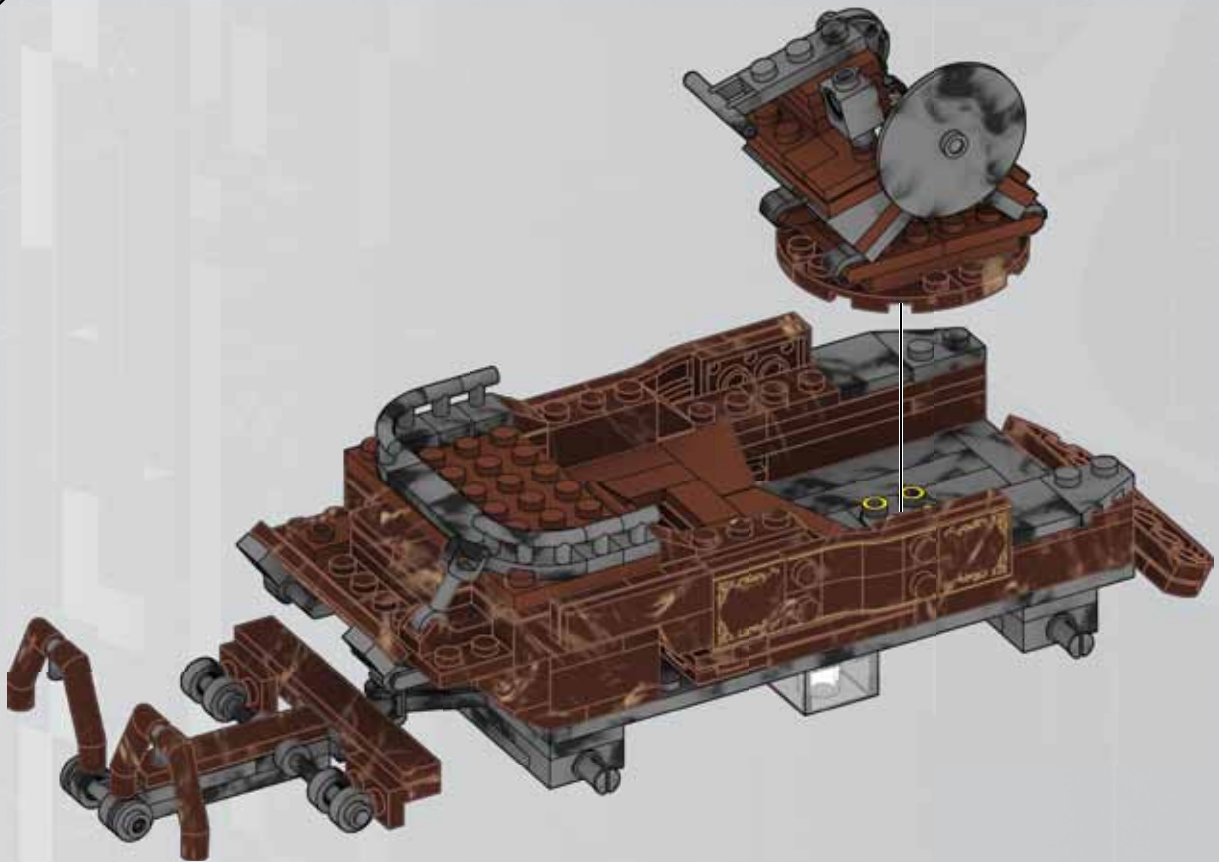
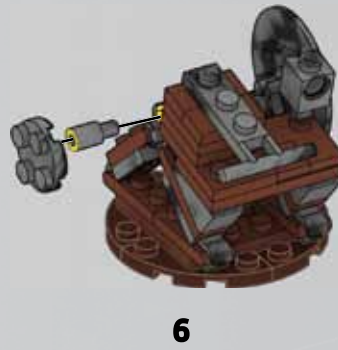
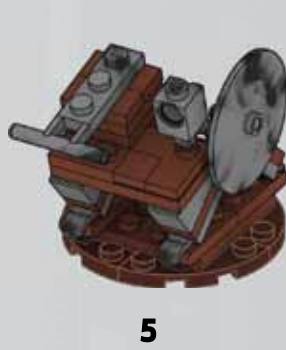
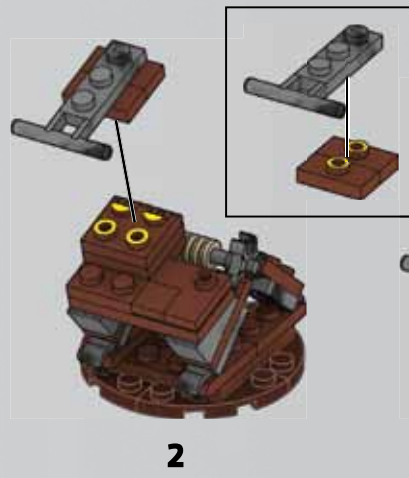
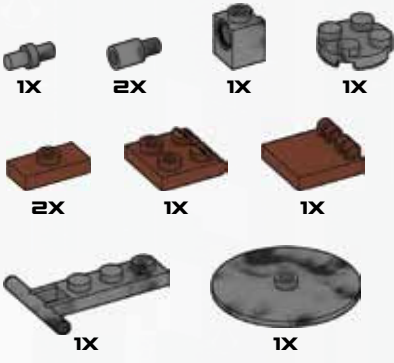

31



4X

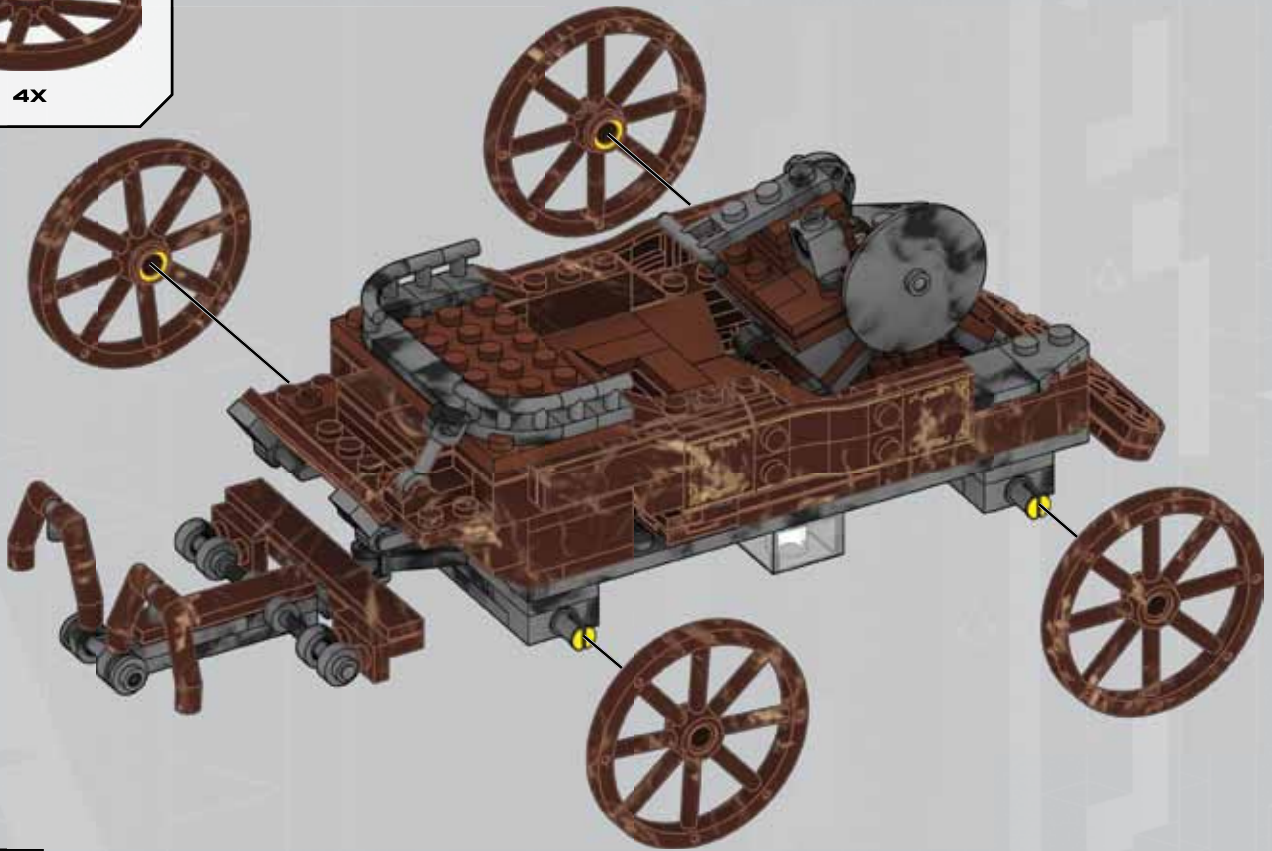

32

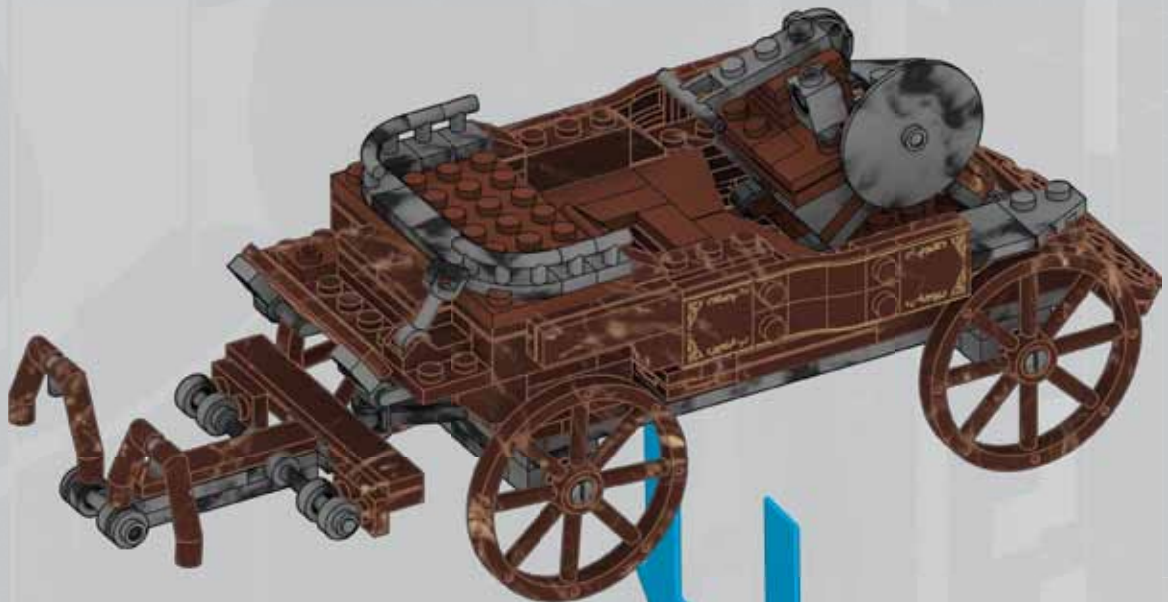

Remove temporary pieces
Retirez les pièces temporaires
Retirar piezas temporales
Remove peças temporárias
Rimuovere i pezzi temporanei
Vorübergehende Teile entfernen
Usunąć elementy tymczasowe.
Verwijder tijdelijke bouwstenen
Снимите временные детали

Fjern midlertidige stykker.
Ta bort temporära delar
Fjern midlertidige deler
Poista väliaikaiset osat
Αφαίρεση προσωρινών
κομμάτων
انزع القطع المؤقتة
移除临时件
暫定ピースを外してください



33

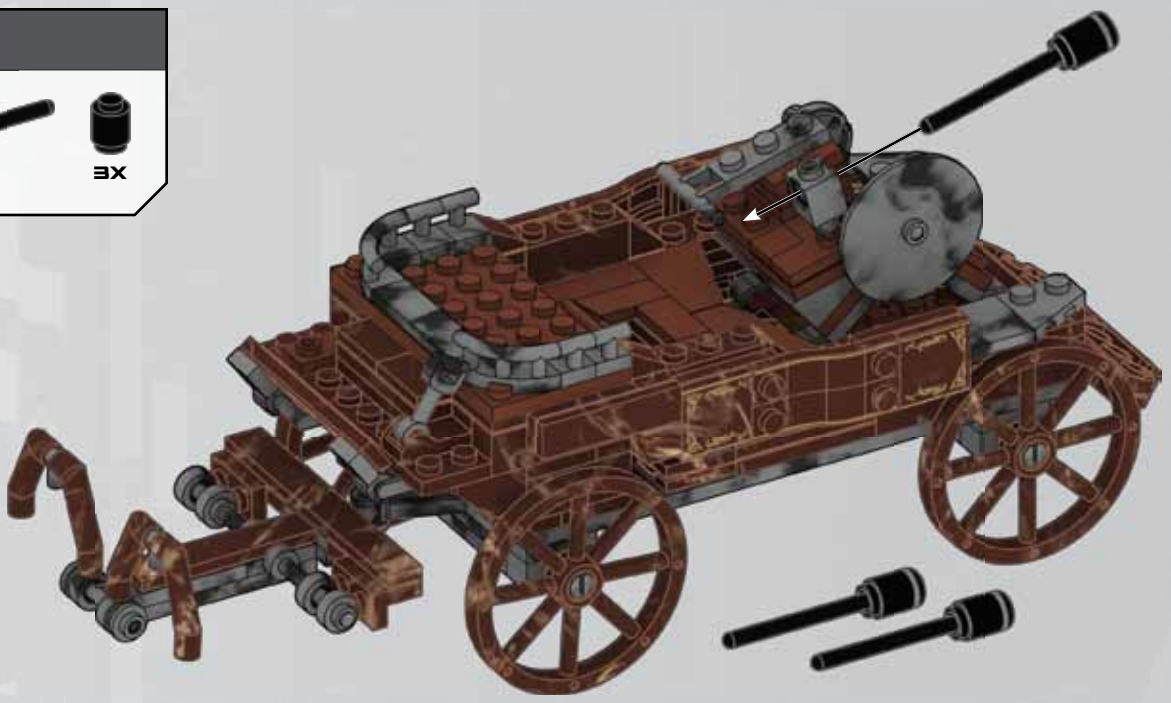

34

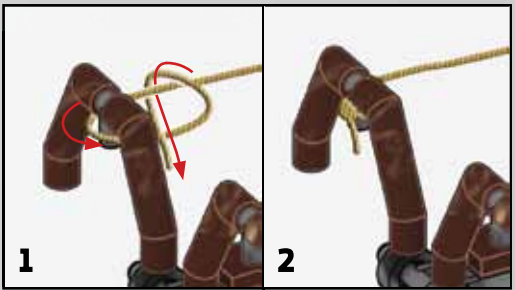
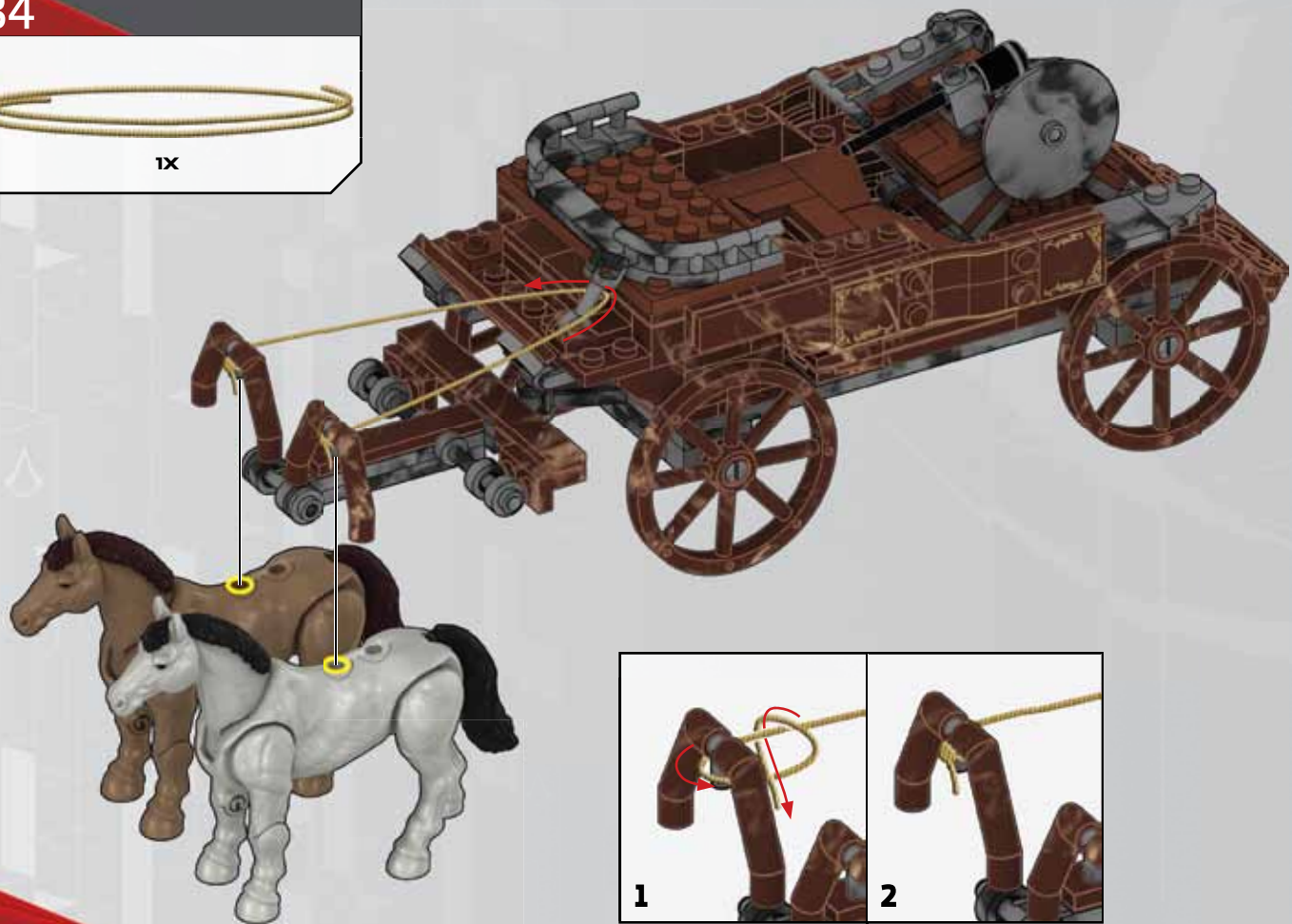



Warning: Do not aim at eyes or face. Only use projectiles supplied with this toy. Do not fire at point blank range.

Attention : Ne pas viser les yeux ou le visage. Ne pas utiliser d'autres projectiles que ceux fournis avec ce jouet. Ne pas tirer à bout portant.

Advertencia: No apuntar hacia los ojos o la cara. Utilizar exclusivamente los proyectiles suministrados con este juguete. No disparar a quemarropa.

Atenção! Não apontar para os olhos e para a face. Não utilizar projéteis diferentes dos providos. Não disparar excessivamente perto do alvo.

Attenzione: Non puntare agli occhi o al viso. Usa solo i proiettili forniti con il giocattolo. Non sparare a distanza ravvicinata.

Achtung: Nicht auf Augen oder Gesicht zielen. Nur die zu diesem Spielzeug gehörenden Projektile verwenden. Nicht auf Menschen oder Tiere oder aus nächster Nähe zielen.

Ostrzeżenie: Nie celuj w oczy ani w twarz. Używaj wyłącznie rzutek BOOMco.™. Nie strzelaj z bliska.

Waarschuwing: niet op ogen of gezicht richten. Gebruik uitsluitend de bijgeleverde projectielen. Niet van te dichtbij afschieten.

Предупреждение: Не направляйте в глаза или лицо. Используйте только детали, входящие в комплект. Не стреляйте со слишком близкого расстояния.

Advarsel: Sigt ikke mod øjne eller ansigt. Brug kun de projektiler, som følger med legetøjet. Skyd ikke direkte på personer eller ting.

Varning! Sikta inte mot ögon eller ansikte. Använd endast projektiler som medföljer leksaken. Fyra inte av på mycket nära håll.

Advarsel: Du må ikke sikte mot øyne eller ansikt. Bruk bare prosjektilene som følger med leken. Ikke skyt på noe på kloss hold.

Varoitus: Älä tähtää silmiin äläkä kasvoihin. Käytä ainoastaan tämän tuotteen mukana tulleita ammuksia. Älä ammu lähietäisyydeltä.

Προσοχή: Μη στοχεύετε στα μάτια ή στο πρόσωπο. Χρησιμοποιείτε μόνο τα βλήματα που περιλαμβάνονται. Μη στοχεύετε προς ανθρώπους ή ζώα.

تحذير: يجب عدم التصويب باتجاه العينين أو الوجه. يجب استخدام المقذوفات المزودة مع هذه اللعبة فقط. يجب عدم الإطلاق من مدى قريب.

警告: 请勿对着眼睛或脸部发射。仅使用本玩具自带的抛射物。请勿近距离射击。

警告: 目や顔を狙わないでください。このおもちゃに同梱されている発射物のみ使用するようになしてください。到達可能な距離内で火を燃やさないでください。

SUPER POSEABLE MICRO ACTION FIGURES
 FIGURINES MINIATURES SUPER ARTICULÉES
 FIGURAS DE ACCIÓN MINIATURAS SÚPER FLEXIBLES
 MICRO FIGURAS DE AÇÃO SUPER ARTICULÁVEIS
 MICRO PERSONAGGI D'AZIONE ARTICOLATI
 VOLLBEWEGLICHE MICRO AKTION FIGUREN
 FIGURKI Z WIELOMA RUCHOMYMI ELEMENTAMI,
 KTÓRE POZWALAJĄ PRZYBRAĆ RÓŻNE POZY.
 SUPERBEWEEGLIJE ACTIEFIGUURTJES
 СУПЕРПОДВИЖНЫЕ МИКРОФИГУРКИ ГЕРОЕВ



Ezio Auditore

CUSTOMIZE WITH AUTHENTIC ACCESSORIES
 PERSONNALISEZ AVEC D'AUTENTIQUES ACCESSOIRES
 PERSONALICE CON ACCESORIOS AUTÉNTICOS
 PERSONALIZE COM ACESSÓRIOS AUTÊNTICOS
 PERSONALIZZA CON ACCESSORI AUTENTICI
 KÖNNEN MIT AUTHENTISCHEM ZUBEHÖR ANGEPASST WERDEN.
 DOSTOSUJ UŻYWAJĄC ORYGINALNYCH AKCESORIÓW
 HELEMAAL AAN TE PASSEN MET AUTHENTIEKE ACCESSOIRES
 ДОПОЛНИТЕ ОРИГИНАЛЬНЫМИ АКССУРАМИ



CNG11

CNG07

CNG10

Each sold separately and subject to availability. / Tous vendus séparément. Certains produits peuvent ne pas être commercialisés. / Se venden por separado y están sujetos a disponibilidad. / Vendidos em separado e sujeitos à disponibilidade. / Ognuno in vendita separatamente secondo disponibilità. / Alle Artikel separat erhältlich. Einige Artikel werden nicht in allen Ländern vertrieben. / Sprzedawane oddzielnie w zależności od dostępności. / Per stuk verkrijgbaar en niet overal leverbaar. / Каждый продукт продается отдельно, в зависимости от наличия. / Sælges separat og så længe lager haves. / Alla delar säljs separat så långt lagret räcker. / Hver leke selges separat så langt lageret rekker. / Jokainen myydään erikseen, saatavuus voi vaihdella. / Το καθένα πωλείται ξεχωριστά και ανάλογα με τη διαθεσιμότητα. /

每件单独出售，并且视库存情况而定。/ それぞれ在庫状況に従って個別に販売されます。

تباع كل منها على حدة وتخضع لتوفرها.