

MEGA
BLOKS

HALO



97068

Versus: Snowbound Battlescape • Versus: Campo de batalla Snowbound • Versus : Champ de bataille du Blizzard
Gegen: Eingeschnittenes Kampfgebiet • Tegen: Snowbound-gevechtsterrein • Contro: Battlescape Snowbound • Contra: Battlescape Snowbound

Versus: Snowbound Battlescape

The Halo Snowbound Battlescape lets you build new battles on authentic arctic terrain based on the popular Snowbound location with pronged plates, vehicle display rods and interconnecting tiles!

Versus: Campo de batalla Snowbound

El campo de batalla Snowbound de Halo te deja construir nuevas batallas en auténticos terrenos árticos basados en el popular Snowbound con placas dentadas, barras de despliegue de vehículos y paneles que se interconectan!

Versus : Champ de bataille Snowbound

Le champ de bataille Snowbound de Halo vous permet de créer de superbes combats sur le terrain arctique authentique inspiré de la carte Snowbound et il est muni de plaques à facettes, de tiges d'exposition et de tuiles de fixation!

Gegen: Eingeschneites Kampfgebiet

Mit dem Halo Snowbound-Battlescape kannst Du neue Kämpfe auf authentischem arktischem Gelände erstellen, basierend auf dem beliebten Snowbound-Standort mit verzinkten Platten, Fahrzeuganzeige-Stäben und miteinander verbundenen Kacheln!

Tegen: Snowbound-gevechtsterrein

Met het Halo Snowbound -gevechtsterrein kan je nieuwe veldslagen bouwen in een echt poolgebied op de populaire Snowbound-locatie met aan elkaar verbonden platen en tegels en voertuigdisplaystaven! De geautomatiseerde Plasma -geschutkoepel vuurt zowel op het rode als op het blauwe team!

Contro: Battlescape Snowbound

Il Battlescape Snowbound di Halo ti permette di costruire nuove battaglie su un autentico terreno artico basato sulla popolare sede Snowbound, con piattaforme ramificate, aste da esposizione per veicoli e piastrelle collegabili!

Contra: Battlescape Snowbound

O Halo Snowbound Campo de batalha permite que você construa novas batalhas em autênticos cenários árticos baseados no popular cenário Snowbound placas divididas, veículos motores e ladrilhos conectados!





HALO
THE AUTHENTIC COLLECTOR'S SERIES

Register for the Halo Bloks Brigade!
Apuntate a la brigada Halo Bloks!
Enrolez-vous dans la Brigade Halo Bloks!
 Registriere dich fur die Halo-Bloks Brigade! • Schrijf je in voor de Halo Bloks Brigade!
 Effetua la registrazione per la Brigata dei Blok Halo! • Regista-te para a Brigada Halo Bloks!



halo.megabloks.com



1x
AM0113KK

1x
AM185605X

1x
AM033285X

1x
AM03328MM

1x
AM18265MM

2x
AM09129HJ

4x
AM15605W

1x
AS9702903

1x
AM15603W

2x
AM010865X

5x
AM0225015X

7x
AM093935X

1x
AM09198MM

4x
AM043225X

2x
AM154845X

1x
AM182935X

1x
AM18293MM

2x
AM014175X

1x
AM09893HJ

1x
AM18710MM

4x
AM037735X

3x
AM16679MM

1x
AM090135X

1x
AM186015X

3x
AM171605X

1x
AM04217MM

1x
AM011545X

2x
AM723315X

3x
AM17832W

1x
AM09238MM

3x
AM195295X

2x
AM723305X

1x
AM18264MM

1x
AM095935X

2x
AM09493AJL

1x
AM193235X

1x
AM16966MM

1x
AM723325X

1x
AM190165X

3x
AM186535X

1x
AM15625W

1x
AM15626W

1x
AM17730AKQ

1x
AS9706804

1x
AS9706802

1x
AS9706801

1x
AS9706803

1x
AM19232AJT

1x
AM17622F

1x
AM18802W

- EN** Please read these instructions carefully before first use and keep them for future reference.
- ES** Leer estas instrucciones cuidadosamente antes de la primera utilización y guardarlas para referencia futura.
- FR** Il est recommandé de lire attentivement ce feuillet avant la première utilisation et de le conserver pour référence future.
- DE** Die Gebrauchsanleitung bitte durchlesen und aufbewahren.
- NL** Wij raden u aan deze handleiding zorgvuldig te lezen en te bewaren voor eventuele raadpleging op een later tijdstip.
- DA** Vær venlig at læse disse instruktioner omhyggeligt inden ibrugtagning og opbevar dem til fremtidigt brug.
- EL** Διαβάστε αυτές τις οδηγίες προσεκτικά πριν χρησιμοποιήσετε το προϊόν για πρώτη φορά και φυλάξτε τις για μελλοντική αναφορά.
- FI** Lue nämä ohjeet huolellisesti ennen ensimmäistä käyttöä ja säilytä ne myöhempää tarvetta varten.
- IT** Leggere le istruzioni prima di cominciare ad usare il gioco e conservarle per referenze future.
- NO** Les disse instruksjonene nøye før første gangs bruk, og ta vare på dem for fremtidige oppslag.
- PT** Leia as instruções antes do primeiro uso e guarde-as para futura referência.
- SV** Läs noggrant igenom dessa instruktioner innan du använder produkten för första gången och spara dem för ev. framtida frågor.
- JA** 初めてご使用になる前に、この説明書をよくお読みください。また、本書は将来いつでも参照できるように保管してください。
- ZH** 请在初次使用前仔细阅读这些指示，并保留它们以便未来参考。
- AR** يرجى قراءة هذه التعليمات بدقة قبل البدء بالاستعمال والاحتفاظ بها كمرجع للمستقبل

EN ⚠ **WARNING :**
CHOKING HAZARD. - Small parts.
Toy contains a small ball.
Not for children under 3 years.

ES ⚠ **ADVERTENCIA :**
RIESGO DE ASFIXIA. - Contiene piezas pequeñas.
El juguete contiene una bola pequeña.
No recomendado para niños menores de 3 años.

FR ⚠ **ATTENTION :**
DANGER D'ÉTOUFFEMENT. - Présence de petits éléments.
Le jouet contient une petite balle.
Ne convient pas aux enfants de moins de 3 ans.

DE ⚠ **ACHTUNG :**
ERSTICKUNGSGEFAHR. - Enthält kleine Teile.
Ein kleiner Ball ist im Spielzeug inbegriffen.
Nicht für Kinder unter 3 Jahren geeignet.

NL ⚠ **WAARSCHUWING :**
VERSTIKKINGSGEVAAR. - Bevat kleine onderdelen.
Speelgoed bevat een klein balletje.
Niet geschikt voor kinderen onder de 3 jaar.

DA ⚠ **ADVARSEL :**
FARE FOR KVÆLNING. - Indeholder smådele.
Legetøjet indeholder en lille bold.
Ikke til børn under 3 år.

EL ⚠ **ΠΡΟΕΙΔΟΠΟΙΗΣΗ :**
ΚΙΝΔΥΝΟΣ ΠΝΙΓΜΟΥ. - Περιέχει μικρά αντικείμενα.
Το παιχνίδι περιέχει ένα μπαλάκι.
Όχι για παιδιά κάτω των 3 ετών.

FI ⚠ **VAROITUS :**
TUKEHTUMISVAARA. - Sisältää pieniä osia.
Leluun sisältyy pieni pallo.
Ei alle 3-vuotiaille lapsille.

IT ⚠ **AVVERTENZA :**
PERICOLO DI SOFFOCAMENTO. - Contiene piccole parti.
Il giocattolo comprende una pallina.
Non indicato per bambini sotto i 3 anni.

NO ⚠ **ADVARSEL :**
KVÆLNINGSFARE. - Inneholder små deler.
Leketøy inneholder en liten ball.
Kun for barn over 3 år.

PT ⚠ **ATENÇÃO :**
PERIGO DE ASFIXIA. - Contém peças pequenas.
O brinquedo contém uma pequena bola.
Não é concebido para crianças de menos de 3 anos.

SV ⚠ **VARNING :**
KVÄVNINGSRISK. - Innehåller små delar.
Leksaken innehåller en liten boll.
Inte för barn under 3 år.

JA ⚠ **警告 :**
のどにつまる危険 小さな部品が含まれています
小さな玉が含まれています。
3歳以下の子供には与えないで下さい。

ZH ⚠ **警告 :**
噎住危險。包含有小部件
此玩具含有一個小球。
不適合3歲以下的小孩玩。

AR ⚠ **تحذير :**
خطر الاختناق - قطع صغيرة.
تحتوي اللعبة على كرة صغيرة.
غير صالحة للأطفال أقل من 3 سنوات.



Get the free mobile app
for your phone
<http://gettag.mobi>

XBOX 360 343 INDUSTRIES™

© 2012 MICROSOFT CORPORATION. ALL RIGHTS RESERVED.
MICROSOFT, 343 INDUSTRIES, THE 343 INDUSTRIES LOGO, HALO,
THE HALO LOGO, XBOX, XBOX 360, AND THE XBOX LOGOS, ARE
TRADEMARKS OF THE MICROSOFT GROUP OF COMPANIES.



1

3X 1X

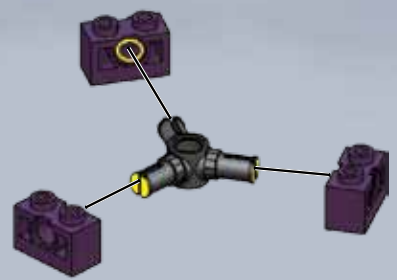

2

3X 3X
3X 3X
3X

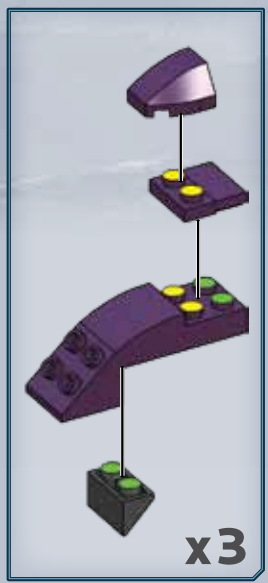

3

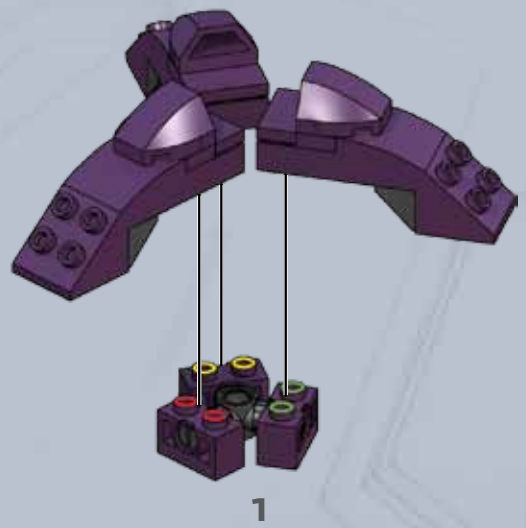

6

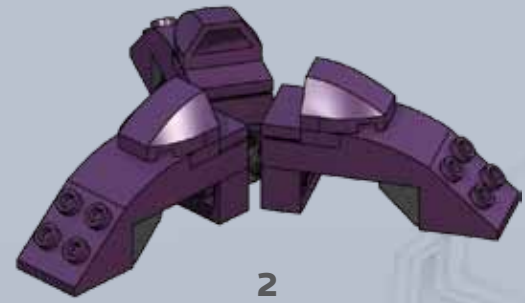



4

1X 1X 1X

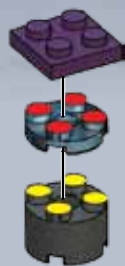

5

2X 1X



6

1X 1X 1X 1X

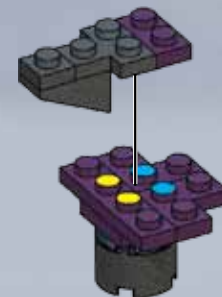

7

1X 1X

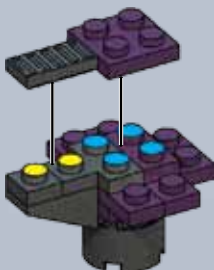

8

2X 2X 1X

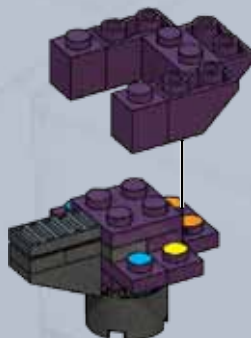

9

2X

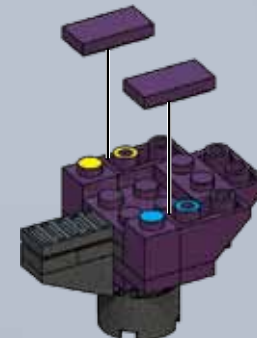



10

2X 1X 1X

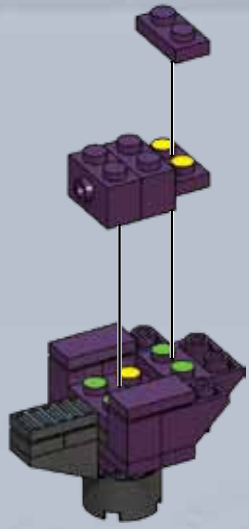

11

4X

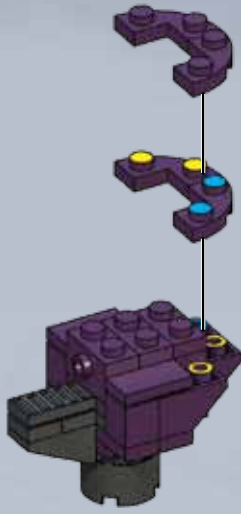

12

1X 1X 2X

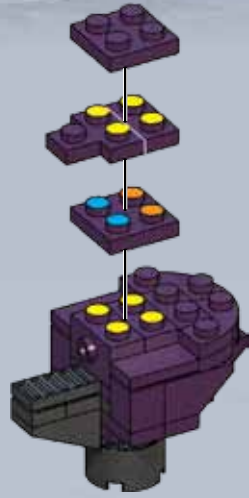

13

1X 1X 1X

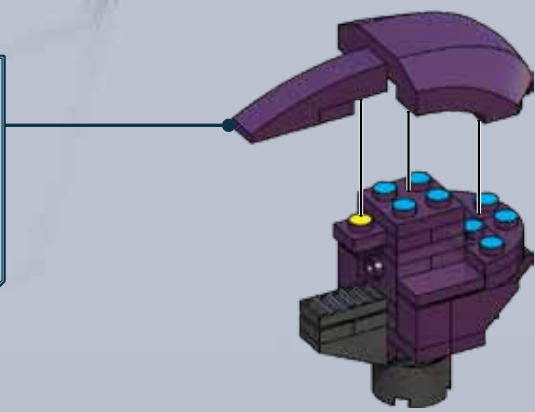
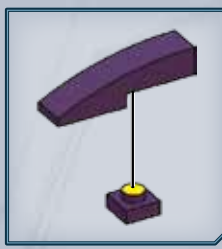



14

1X 1X 1X

1

2

1

2

15

1X

click

1

2





HALO

16

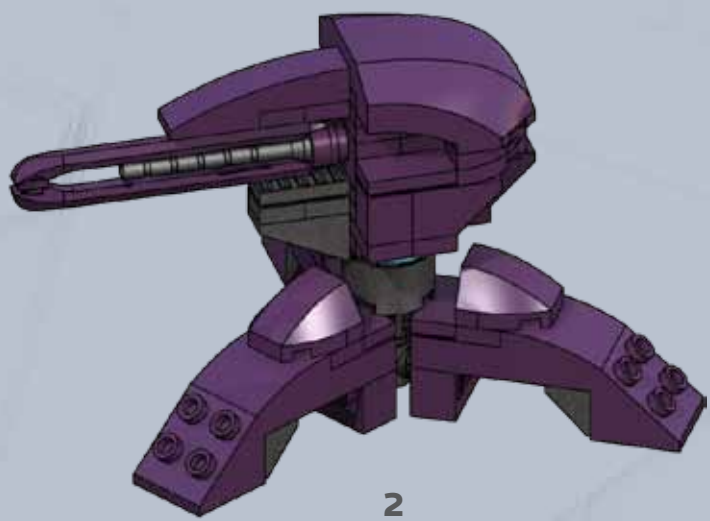
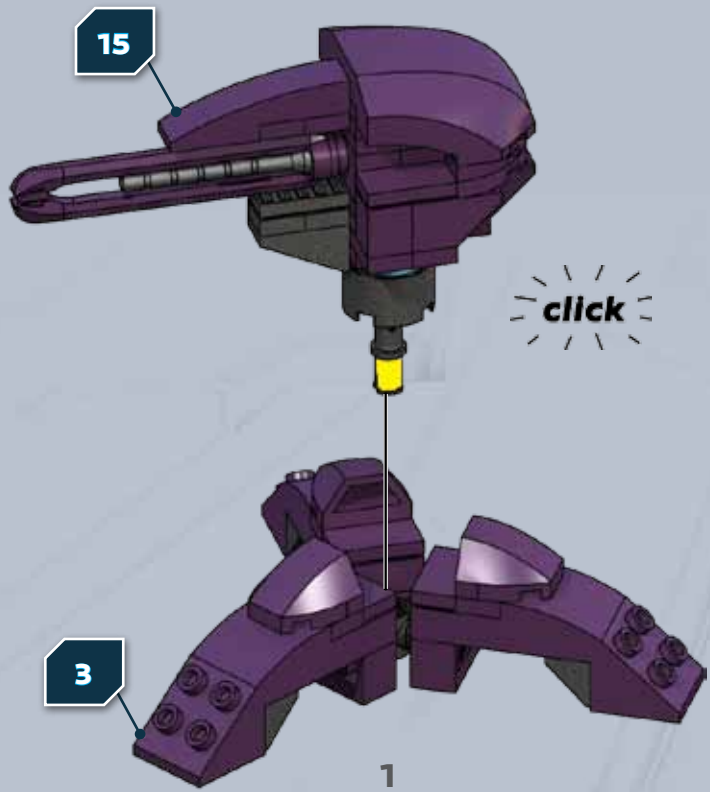

10



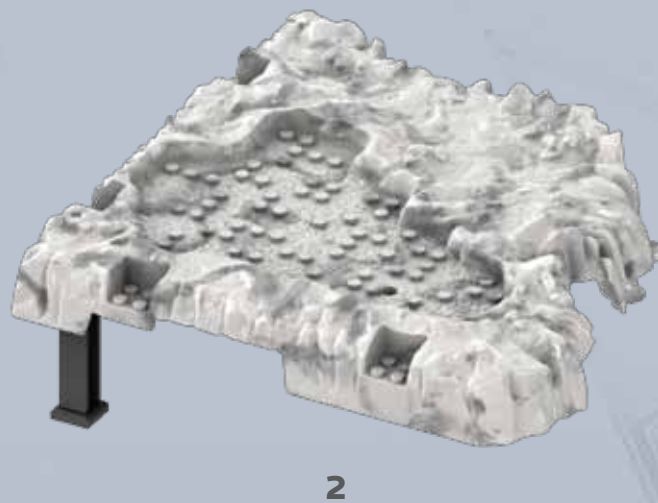
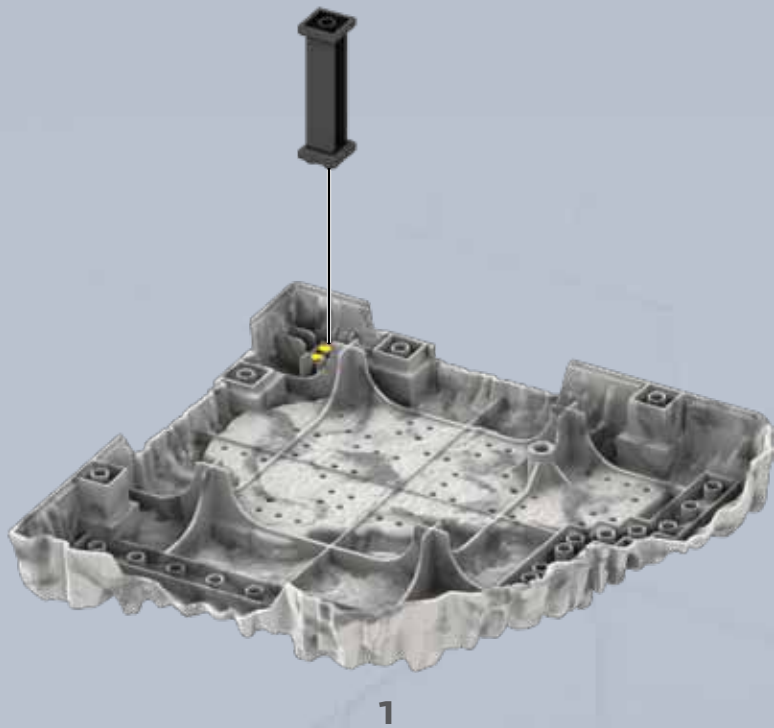



2

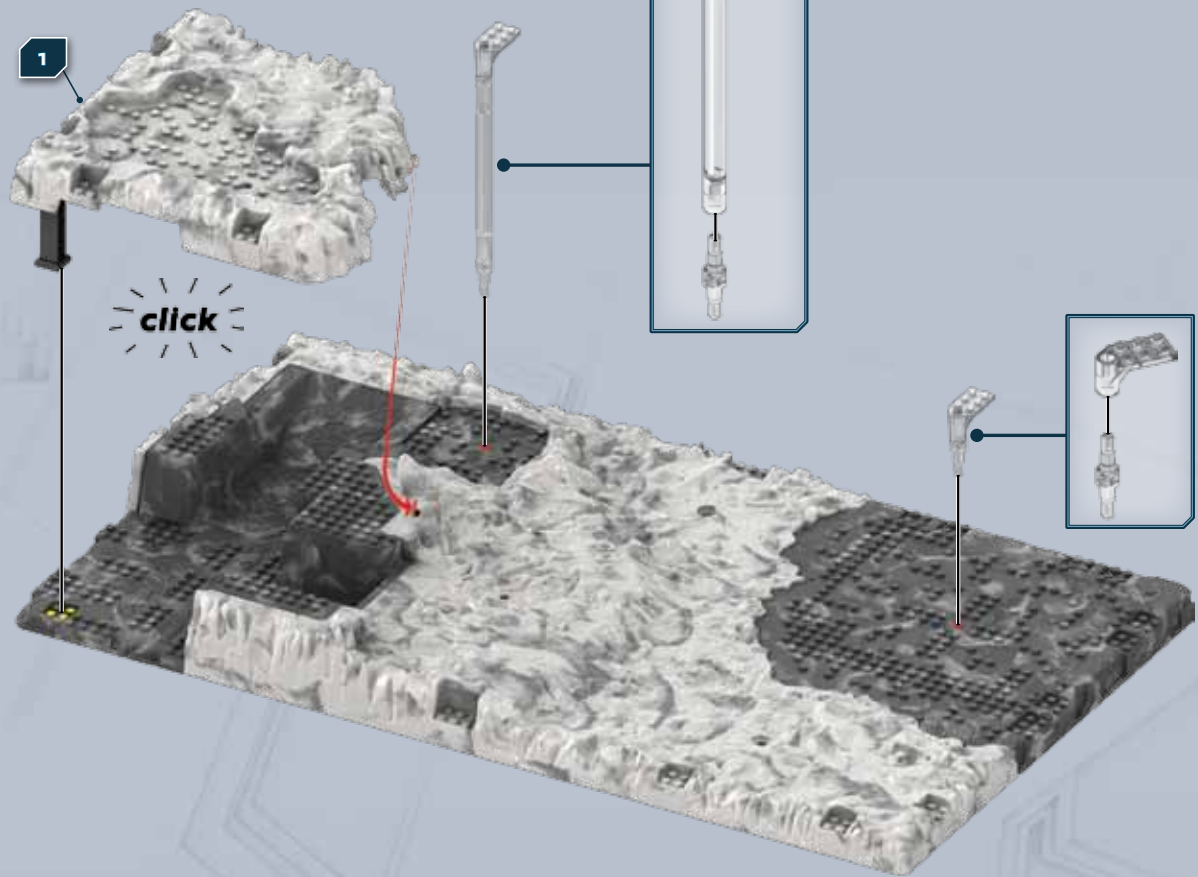
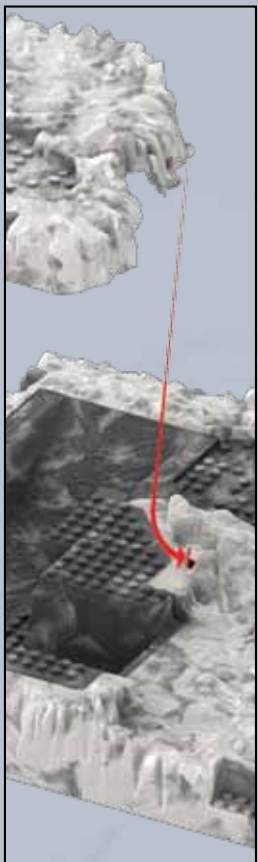
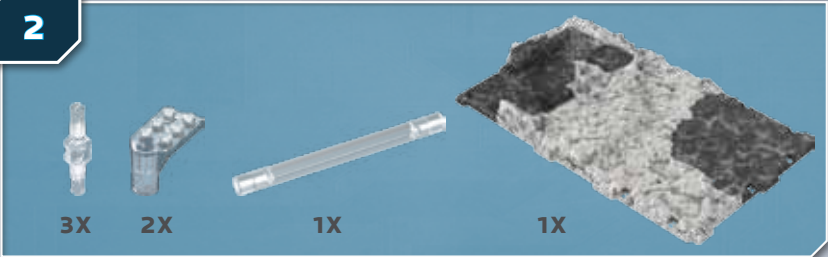



3



1X



1X



1X



1X



1X



1X

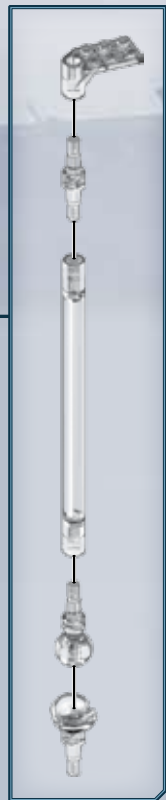
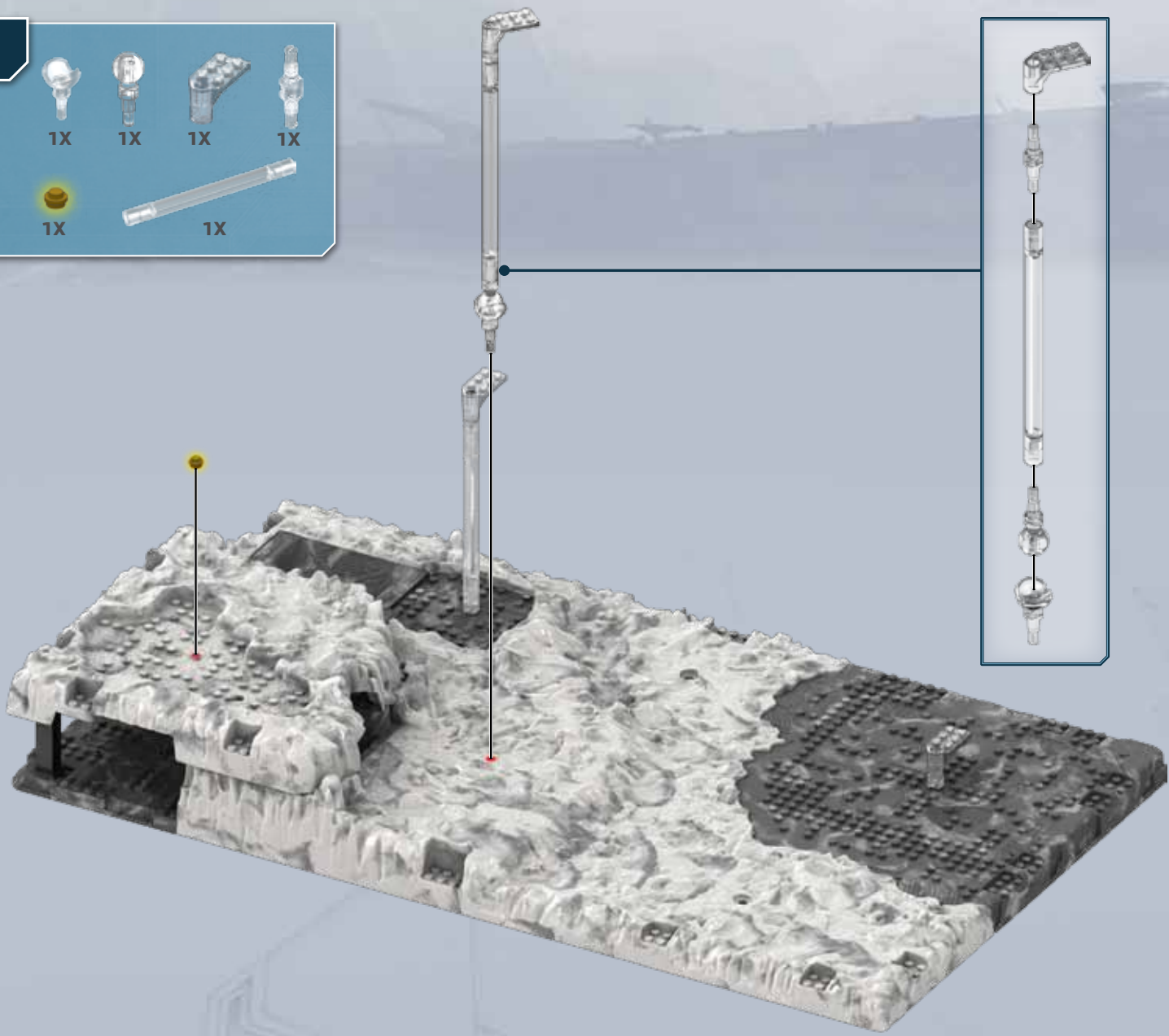

13





HALO

4

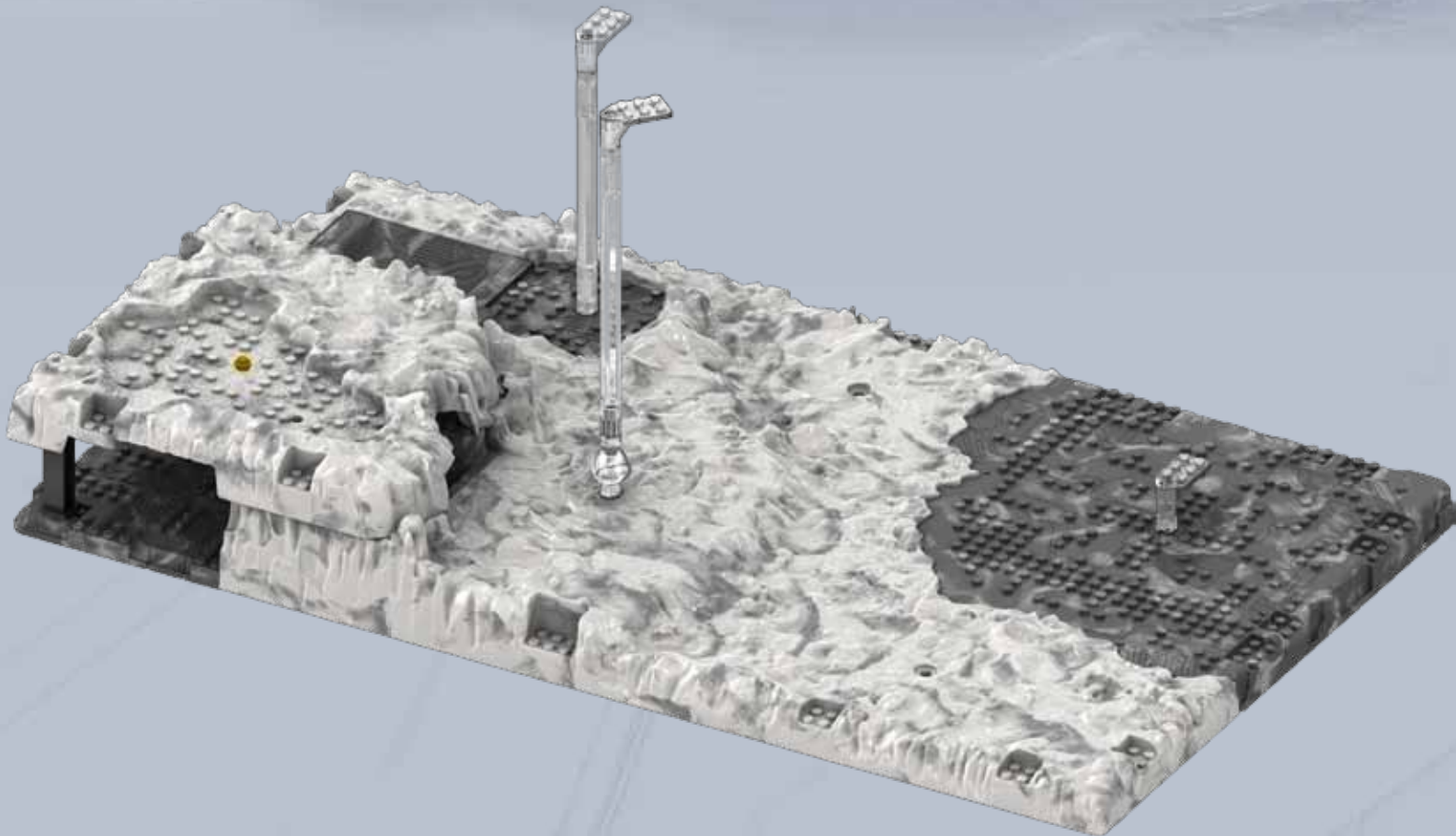

14



Go to halo.megabloks.com/downloads for rebuild instructions!

¡Visita halo.megabloks.com/downloads para obtener instrucciones de reconstrucción!

Allez au halo.megabloks.com/downloads pour obtenir des instructions de réassemblage!

Für Wiederaufbauanleitungen gehe zu halo.megabloks.com/downloads!

Ga voor bouw instructies naar halo.megabloks.com/downloads

Vai su halo.megabloks.com/downloads per le istruzioni di ricostruzione!

Visite halo.megabloks.com/downloads para instruções de reconstrução!

97069

VERSUS: SNOWBOUND HIGHBASE

VERSUS: BASE ALTA SNOBOUND

VERSUS: BASE SURÉLEVÉE DU BLIZZARD

GEGEN: EINGESCHNEITES KAMPFGEBIET

TEGEN: SNOWBOUND-GEVECHTSTERREIN

CONTRA: BATTLESCAPE SNOWBOUND

CONTRA: BATTLESCAPE SNOWBOUND

97069 NOT INCLUDED

NO INCLUYE EL 97069

97069 NON COMPRIS

97069 NICHT ENTHALTEN / 97069

NIET INBEGREPEN / 97069 NON

INCLUSO / 97069 NÃO INCLuíDO

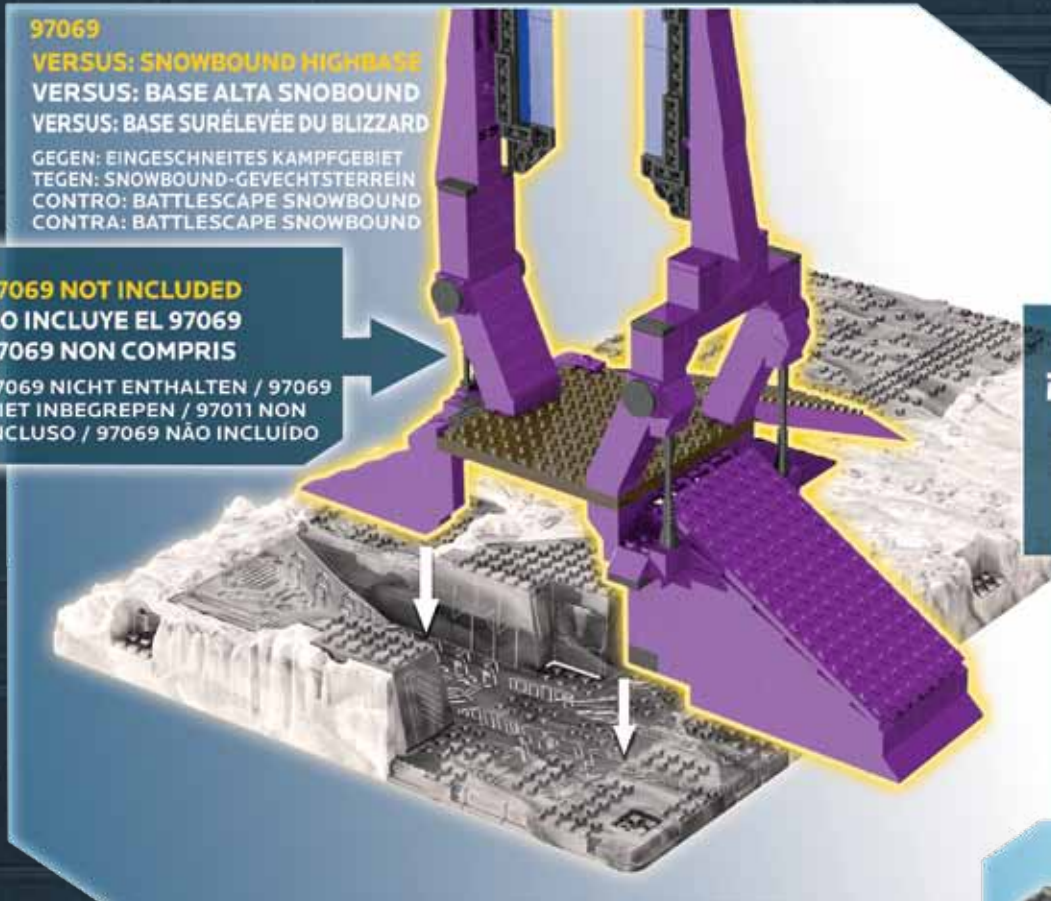

REBUILD!

¡RECONSTRUYE!
RECONSTRUIS!

BAUE! / BOWEN! /
COSTRUISCI! /
CONSTRÓI!

CONNECT AND EXPAND YOUR BATTLE!

¡CONÉCTATE Y EXPANDE TU BATALLA!

RELIEZ ET AGRANDISSEZ VOTRE

EQUIPE DE COMBAT!

VERBINE UND ERWEITERE DEINEN KAMPF!

KOPPEL AAN ELKAAR EN BREID JE GEVECHT UIT!

COLLEGA ED ESTENDI LA TUA BATTAGLIA!

CONNECTE E EXPANDE SUA BATALHA!

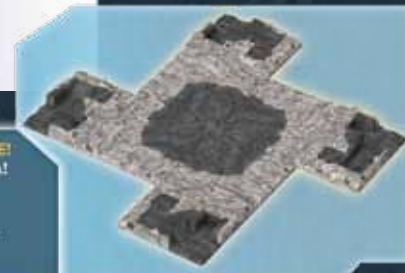

Additional purchases required to collect all elements shown. / Para coleccionar todos los elementos mostrados se precisa realizar unas compras adicionales. / Des achats additionnels sont nécessaires afin d'obtenir tous les articles de la collection illustrés. / Des achats additionnels sont nécessaires afin d'obtenir tous les articles de la collection illustrés. / Um alle dargestellten Elemente zu sammeln sind zusätzliche Käufe erforderlich. / Verdere aankopen zijn nodig om alle afgebeelde artikelen te verzamelen. / Acquisti supplementari necessari per collezionare tutti gli elementi illustrati. / Compras adicionais são necessárias para coleccionar todos os elementos exibidos.

HALO



**MEGABLOKS CAMO EFFECT
EFFECTO CAMO MEGABLOKS
EFFET CAMO MEGABLOKS**

MEGABLOKS CAMO EFFECT
MEGABLOKS CAMO EFFECT
EFFETTO CAMO MEGABLOKS
EFFETTO CAMO MEGABLOKS

**SNOWBOUND ARMOR
ARMADURA SNOWBOUND
ARMURE SNOWBOUND**

SNOWBOUND PAZELERUNG
SNOWBOUND BALPENSUTZUNG
ARMATURA SNOWBOUND
ARMATURA SNOWBOUND

NOTES
VERBODEN AANWENDINGEN: VERBODEN DE
VERSIELEN, BAKEN, ALTA SNOWBOUND
VERBODEN, BAKEN, ALTA SNOWBOUND
VERBODEN, BAKEN, ALTA SNOWBOUND
VERBODEN, BAKEN, ALTA SNOWBOUND
VERBODEN, BAKEN, ALTA SNOWBOUND

**97069 NOT INCLUDED
NO INCLUIX EL 97069
97069 NON COMPRES**

97069 NICHT INSTALLEN / 97069
NIET INSTALLEREN / 97069
NIE INSTALLEN / 97069 NAO
INSTALLEREN

**REBUILD!
¡RECONSTRUYE!
RECONSTRUIS!**
BAUEN / BOWEN /
COSTRUIRE /
CONSTRUI!

**CONNECT AND EXPAND YOUR BATTLE!
¡CONÉCTATE Y EXPANDE TU BATALLA!
RELIÉZ ET AGRANDISSEZ VOTRE
ÉQUIPE DE COMBAT!**
VERBENDE UND ERWEITERE DICHEN A SCHNIP!
HOEFEL AAN ELK AAN EEN BREDJE DE GEVOORT LAAT
COLLEGA ED EXTENDE LA TUA BATTAGLIA!
CONECTE E EXPANDA SUA BATALHA!



UNSC INTEL

Collect them all! - ¡Colecciónalos todos! - Collectionne-les tous!
Hal sie dir alle! - Verzamel ze allemaal! - Collezionati tutti! - Coleccione todos ellos!



97043

97041

97065

97069



©2012, MEGA Brands Inc. © & ™ MEGA Brands Inc.
Printed in China AD970681A