

MEGA
BLOKS

HALO



97029

Battlescape III • Campo de batalla III • Champ de bataille III
Eingeschnittes III • Gevechtsterrein III • Battlescape III • Campo de Batalha III

Battlescape III

On a recon mission on an unknown planet, a lone UNSC Spartan has discovered a long forgotten Forerunner structure! As the Spartan investigates, the structure activates its automated defenses to destroy any intruders looking to uncover its ancient secrets!

Campo de batalla III

En una misión de reconocimiento en un planeta desconocido, iun Spartan de CENU ha descubierto una larga estructura Forerunner olvidada! A medida que el Spartan investiga, la estructura activa sus defensas para destruir cualquier intruso que pretenda descubrir sus antiguos secretos.

Champ de bataille III

Lors d'une mission de reconnaissance sur une planète inconnue, un Spartan du CSNU découvre une structure Forerunner oubliée depuis longtemps! Pendant que le Spartan explore la structure, celle-ci active ses systèmes de défense automatisés afin d'éliminer tout intrus risquant de découvrir ses secrets anciens!

Eingeschneites III

Bei einer Aufklärungsmission auf einem unbekanntem Planeten hat ein einsamer RVN Spartan eine längst vergessene Forerunner-Struktur entdeckt! Während der Spartaner den Fund untersucht, aktiviert die Struktur ihre automatisierte Abwehr, um alle Eindringlinge zu zerstören, die ihre alten Geheimnisse aufdecken wollen!

Gevechtsterrein III

Tijdens een verkenningsmissie op een onbekende planeet heeft een eenzame RVN Spartan een lang vergeten Forerunner-installatie ontdekt! Terwijl de Spartan de installatie onderzoekt, wordt de automatische verdediging ingeschakeld om de oude geheimen tegen indringers te beschermen!

Battlescape III

Durante una missione di ricognizione su un pianeta sconosciuto, un solitario CSNU Spartan ha scoperto una struttura Forerunner dimenticata da tempo! Mentre lo Spartan indaga, la struttura attiva le sue difese automatiche per distruggere ogni intruso che tenti di scoprire i suoi antichi segreti!

Campo de bathala III

Em uma missão de reconhecimento em um planeta desconhecido, um solitário Spartan do CENU descobriu uma estrutura Forerunner esquecida! À medida que o Spartan investiga, a estrutura ativa suas defesas automáticas para destruir intrusos querendo descobrir seus antigos segredos!

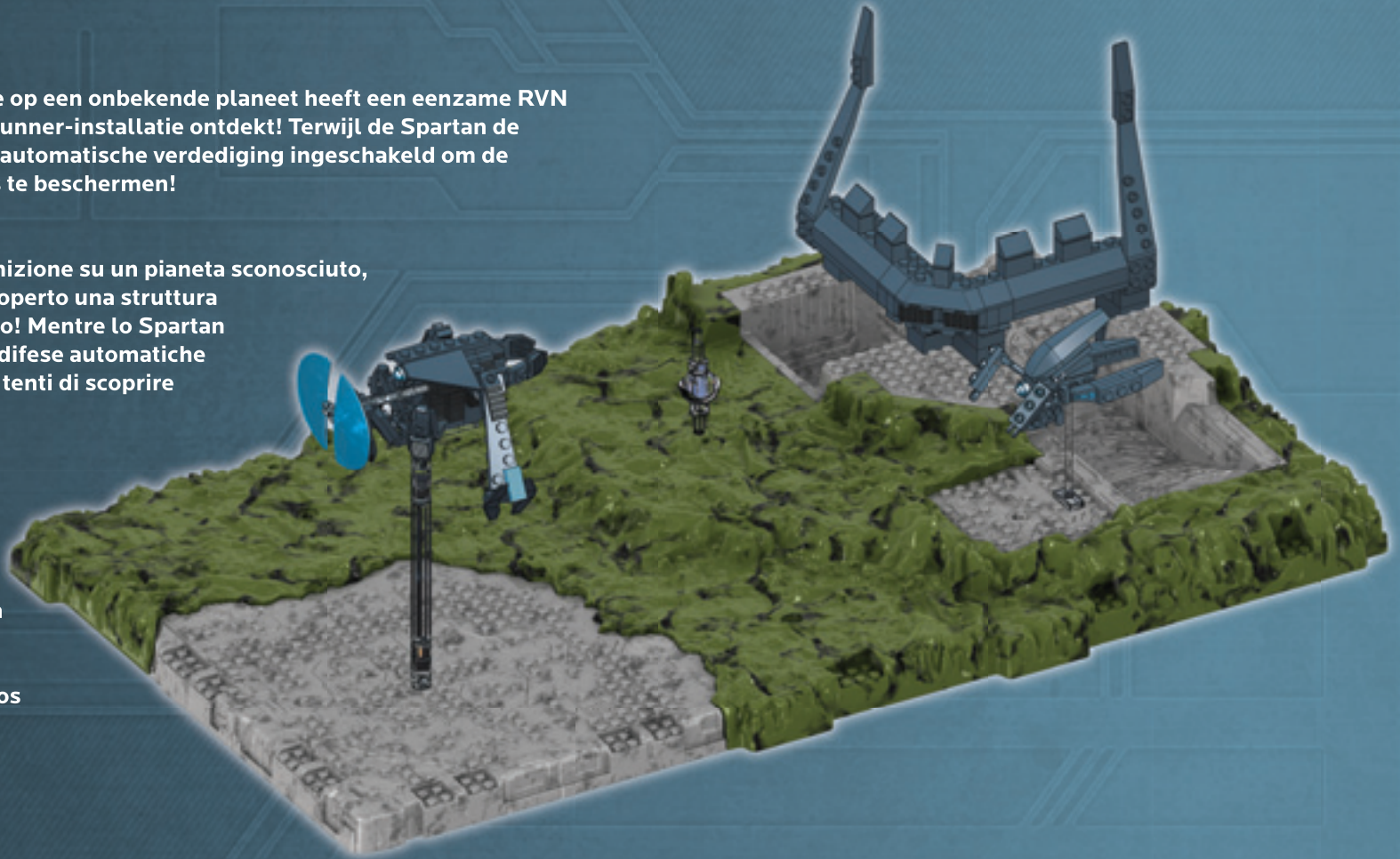



HALO
THE AUTHENTIC COLLECTOR'S SERIES

Register for the Halo Bloks Brigade!
Apuntate a la brigada Halo Bloks!
Enrolez-vous dans la Brigade Halo Bloks!
Registrierte dich für die Halo-Bloks Brigade! · Schrijf je in voor de Halo Bloks Brigade!
Effetua la registrazione per la Brigata dei Blok Halo! · Regista-te para a Brigada Halo Bloks!

**MEGA
BLOKS**

halo.megabloks.com

- 3x AMI8560HJ
- 1x AMO1113KC
- 5x AMO3328ALG
- 1x AMO3328F
- 1x AMI8623F
- 2x AM7200IALG
- 4x AMI7003ALG
- 5x AMI7003W
- 4x AMI7062ALG
- 1x AMI8287ALG
- 3x AMI7506W
- 1x AMI8260W
- 1x AMO1140W
- 4x AMI9197ALG
- 1x AMI9197F
- 1x AMI9530ALG
- 1x AMI8740ALG

- 1x AMI5258ALG
- 1x AMO4428ALG
- 9x AMO1086ALG
- 1x AMO7629F
- 2x AMI7507ALG
- 4x AMO7629ALG
- 2x AMI9327ALG
- 1x AMO7590W
- 6x AMO9198F
- 2x AMO2250IHJ
- 2x AMO7590ALG
- 1x AMO7590F
- 2x AMO9393F
- 6x AMO9393ALG
- 2x AMI8272F
- 3x AMI7128ALG
- 1x AMO4430ALG
- 2x AMI8549ALG

- 4x AMO3019ALG
- 1x AMO1322F
- 2x AMO4218ALG
- 3x AMO1417ALG
- 11x AMO9013ALG
- 1x AMI860IALG
- 1x AMO9013F
- 2x AMI5484ALG
- 2x AMI8293F
- 1x AMO3773F
- 5x AMO3773ALG
- 1x AMI9529ALG
- 2x AMO9106F
- 2x AMO1141ALG

- 2x AMI0273ALG
- 5x AMO1154ALG
- 2x AMO9023ALG
- 6x AMI7153ALG
- 2x AMI8554ALG
- 6x AMI6975ALG
- 12x AMI6954ALG
- 2x AMO1314ALG
- 5x AM72600ALG
- 6x AMI7048ALG
- 2x AMO1418ALG
- 2x AMO3772F
- 2x AMO3873ALG
- 2x AS9702905

- 4x AMI6636ALG
- 7x AMO9593ALG
- 1x AMO8416ALG
- 4x AMO1087ALG
- 1x AM7260IALG
- 2x AMI5492ALG
- 1x AMO4433ALG
- 1x AMO4434ALG
- 2x AMO7475ALG
- 1x AMO9292ALG
- 1x AM7201IALG
- 1x AM7201OALG

- 1x AM7253IALG
- 2x AMO9493AQW
- 1x AS9702903
- 1x AMI5603W
- 1x AMI8259W
- 1x AM72320ALG
- 1x AMI8777ALG
- 1x AMO9622ALG

- 4x AMI8298ALG
- 2x AMO8483ALG
- 1x AMI7602ALG
- 1x AMI7603ALG
- 2x AMO9933ALG
- 2x AMO9924ALG
- 1x AS9702904



1x
AMI7832W



2x
AMI5605W



1x
AMI5625W



2x
AMI8169HJ



1x
AMI6700F



1x
AS9702902

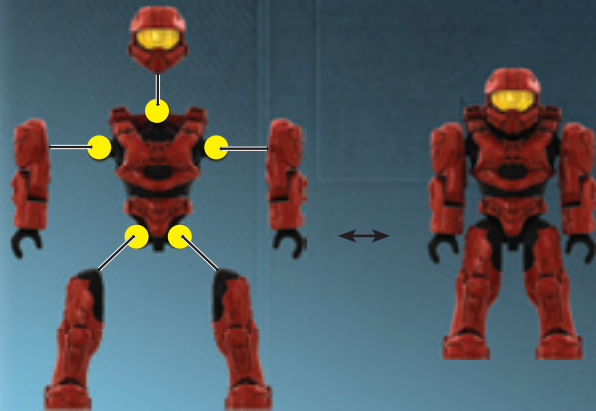

- (EN) Please read these instructions carefully before first use and keep them for future reference.
- (ES) Leer estas instrucciones cuidadosamente antes de la primera utilización y guardarlas para referencia futura.
- (FR) Il est recommandé de lire attentivement ce feuillet avant la première utilisation et de le conserver pour référence future.
- (DE) Die Gebrauchsanleitung bitte durchlesen und aufbewahren.
- (NL) Wij raden u aan deze handleiding zorgvuldig te lezen en te bewaren voor eventuele raadpleging op een later tijdstip.
- (DA) Vær venlig at læse disse instruktioner omhyggeligt inden ibrugtagningen og opbevar dem til fremtidigt brug.
- (EL) Διαβάστε αυτές τις οδηγίες προσεκτικά πριν χρησιμοποιήσετε το προϊόν για πρώτη φορά και φυλάξτε τις για μελλοντική αναφορά.
- (FI) Lue nämä ohjeet huolellisesti ennen ensimmäistä käyttöä ja säilytä ne myöhempää tarvetta varten.
- (IT) Leggere le istruzioni prima di cominciare ad usare il gioco e conservarle per referenze future.
- (NO) Les disse instruksjonene nøye før første gangs bruk, og ta vare på dem for fremtidige oppslag.
- (PT) Leia as instruções antes do primeiro uso e guarde-as para futura referência.
- (SV) Läs noggrant igenom dessa instruktioner innan du använder produkten för första gången och spara dem för ev. framtida frågor.
- (JA) 初めてご使用になる前に、この説明書をよくお読みください。また、本書は将来いつでも参照できるように保管してください。
- (ZH) 请在初次使用前仔细阅读这些指示，并保留它们以便未来参考。
- (AR) يرجى قراءة هذه التعليمات بدقة قبل البدء بالاستعمال والاحتفاظ بها كمرجع للمستقبل.

- (EN) ⚠ WARNING :
CHOKING HAZARD. - Small parts.
Not for children under 3 years.
- (ES) ⚠ ADVERTENCIA :
RIESGO DE ASFIXIA. - Contiene piezas pequeñas.
No recomendado para niños menores de 3 años.
- (FR) ⚠ ATTENTION :
DANGER D'ÉTOUFFEMENT. - Présence de petits éléments.
Ne convient pas aux enfants de moins de 3 ans.
- (DE) ⚠ WARNUNG :
ERSTICKUNGSGEFAHR. - Enthält kleine Teile.
Nicht für Kinder unter 3 Jahren geeignet.
- (NL) ⚠ WAARSCHUWING :
VERSTIKKINGSGEVAAR. - Bevat kleine onderdelen.
Niet geschikt voor kinderen onder de 3 jaar.
- (DA) ⚠ ADVARSEL :
FARE FOR KVÆLNING. - Indeholder smådele.
Ikke til børn under 3 år.
- (EL) ⚠ ΠΡΟΕΙΔΟΠΟΙΗΣΗ :
ΚΙΝΔΥΝΟΣ ΠΝΙΓΜΟΥ. - Περιέχει μικρά αντικείμενα.
Όχι για παιδιά κάτω των 3 ετών.
- (FI) ⚠ VAROITUS :
TUKEHTUMISVAARA. - Sisältää pieniä osia.
Ei alle 3-vuotiaille lapsille.
- (IT) ⚠ ATTENZIONE :
PERICOLO DI SOFFOCAMENTO. - Contiene piccole parti.
Non indicato per bambini sotto i 3 anni.
- (NO) ⚠ ADVARSEL :
KVELNINGSFARE. - Inneholder små deler.
Kun for barn over 3 år.
- (PT) ⚠ ATENÇÃO :
PERIGO DE ASFIXIA. - Contém peças pequenas.
Não é concebido para crianças de menos de 3 anos.
- (SV) ⚠ VARNING :
KVÄVNINGSRISK. - Innehåller små delar.
Inte för barn under 3 år.
- (JA) ⚠ 警告 :
のどにつまる危険。小さな部品が含まれています。
3歳以下の子供には与えないで下さい。
- (ZH) ⚠ 警告 :
噎住危险。包含有小部件。
不适合3岁以下的小孩玩。
- (AR) ⚠ تحذير :
خطر الاختناق - قطع صغيرة.
غير صالحة للأطفال أقل من 3 سنوات.

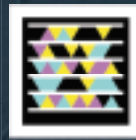

WARNING ! ATTENTION ! ADVERTENCIA ! ACHTUNG ! WAARSCHUWING !	AVVERTENZA ! VAROITUS ! ADVERTENCIA ! ADVARSEL ! ATENÇÃO !	ADVARSEL ! VARNING ! 警告 ! تحذير !
--	--	--

Get the free mobile app
for your phone
<http://gettag.mobi>



© 2012 MICROSOFT CORPORATION. ALL RIGHTS RESERVED.
MICROSOFT, 343 INDUSTRIES, THE 343 INDUSTRIES LOGO, HALO,
THE HALO LOGO, XBOX, XBOX 360, AND THE XBOX LOGOS, ARE
TRADEMARKS OF THE MICROSOFT GROUP OF COMPANIES.

A



1

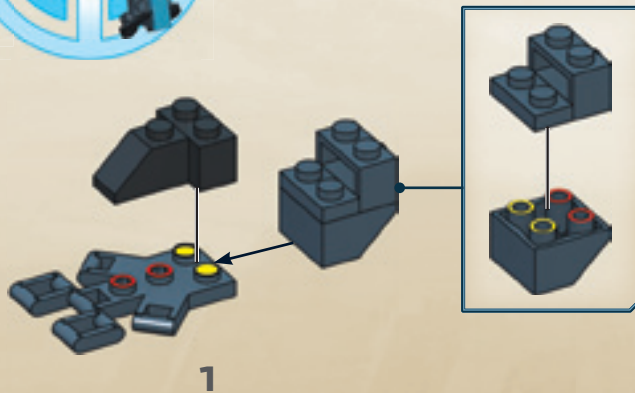

2



2



3

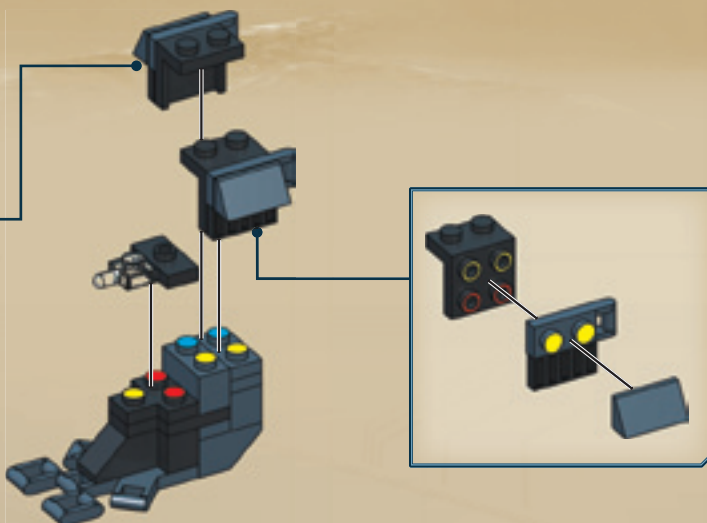
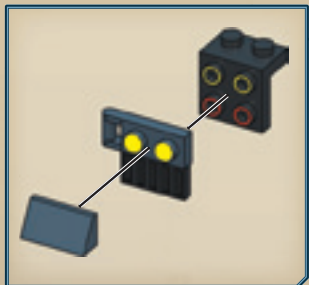

4

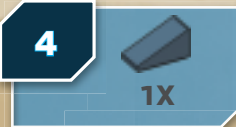

1



2

5

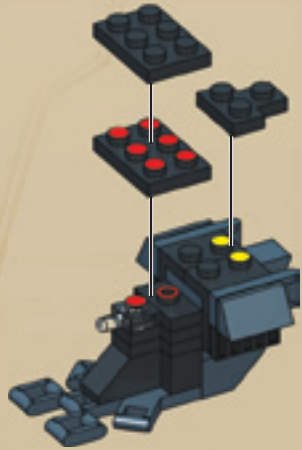

6

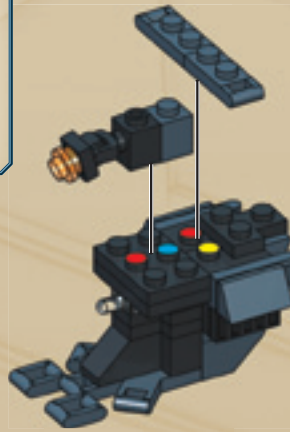

7



8



9

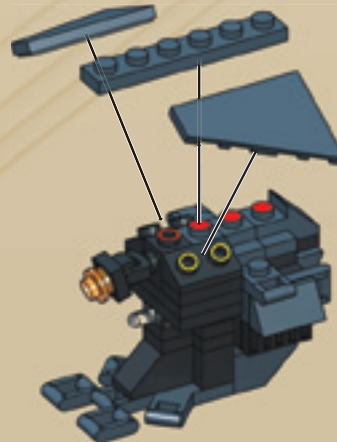

10

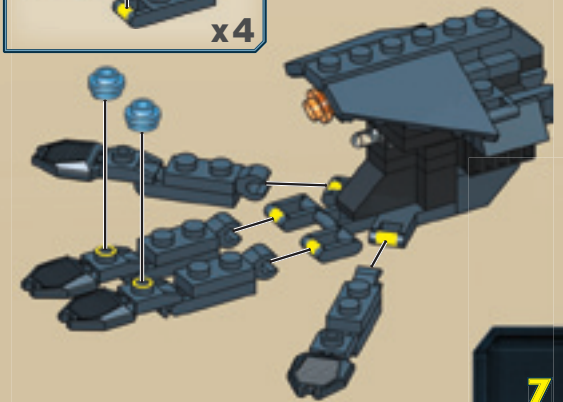

11

- 4X [Small dark grey pin]
- 2X [Small dark grey pin]
- 2X [Small dark grey pin]
- 2X [Small dark grey pin]
- 2X [Light blue 1x2 Technic brick]
- 2X [Black 1x2 Technic brick]
- 2X [Dark grey 1x2 Technic brick]
- 2X [Dark grey 1x2 Technic brick]
- 2X [Dark grey 1x2 Technic brick]
- 4X [Dark grey 1x2 Technic brick]
- 2X [Dark grey 1x2 Technic brick]
- 1X [Dark grey 1x6 Technic brick]
- 1X [Dark grey 1x6 Technic brick]
- 2X [Dark grey 1x6 Technic brick]

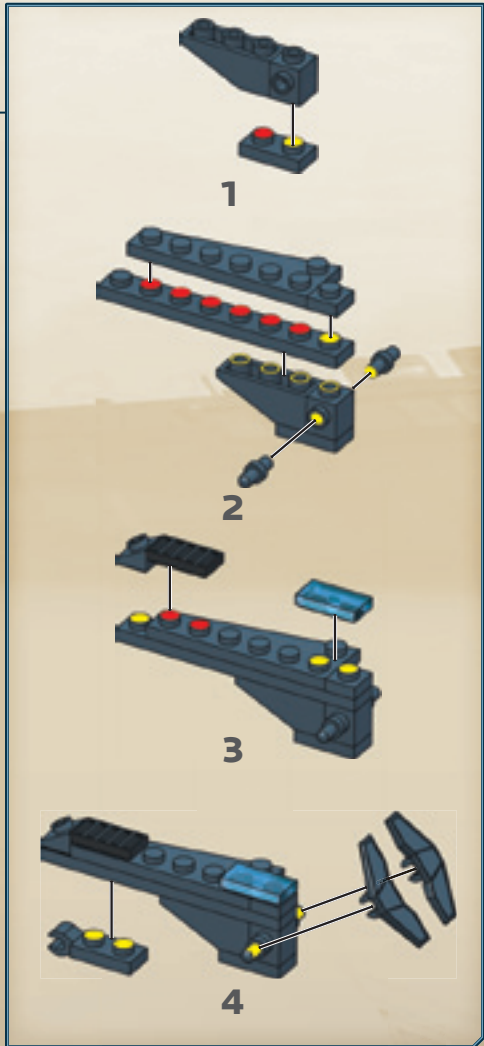
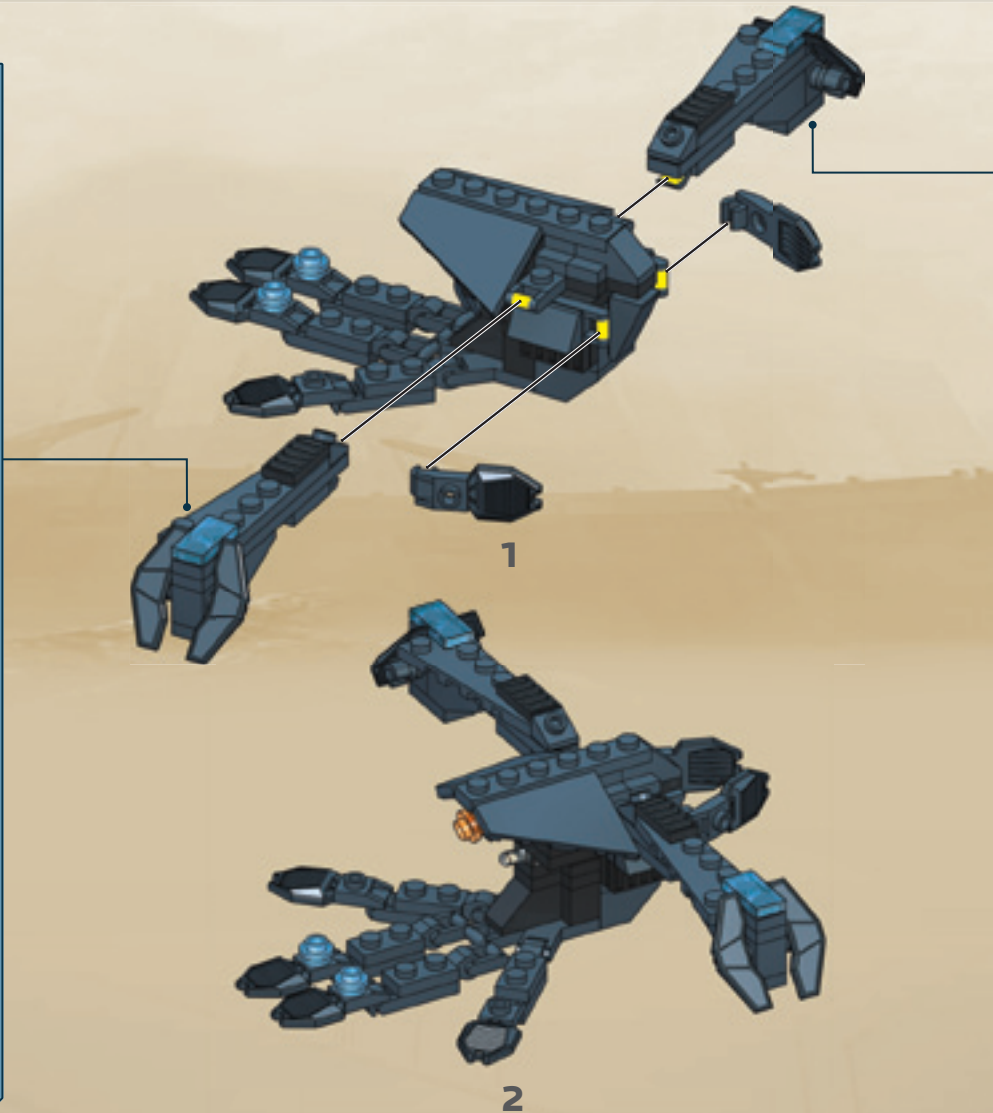
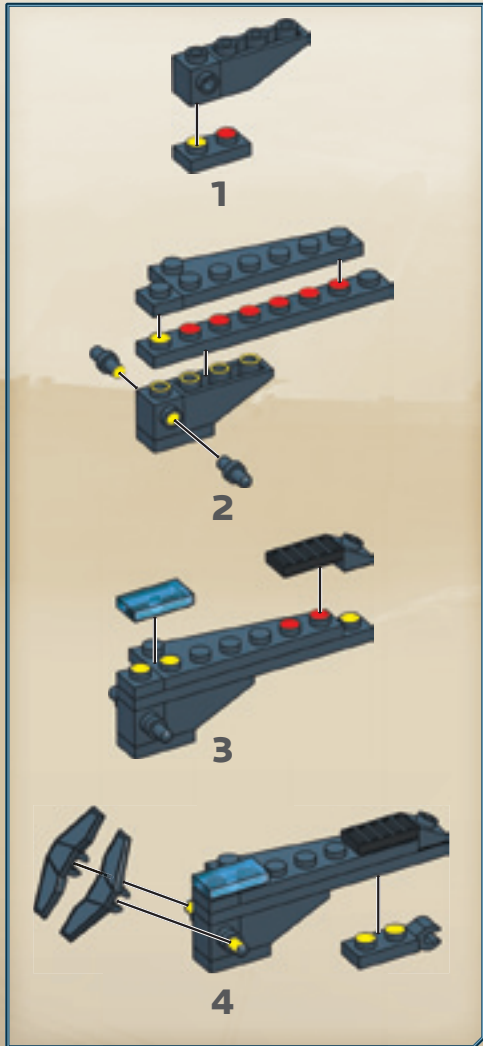

12



3X



2X



2X



1X

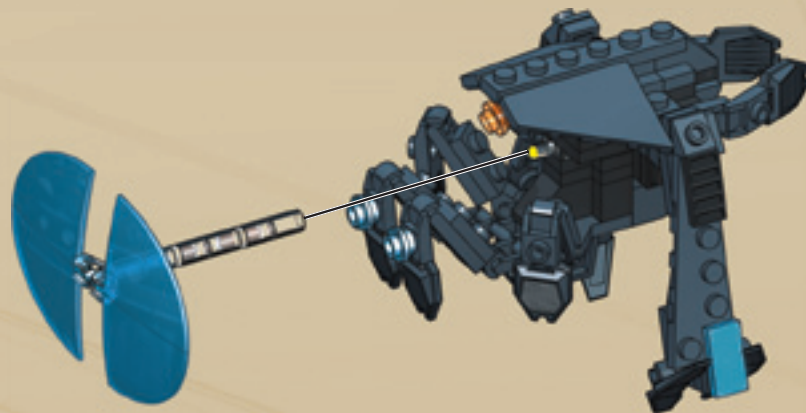
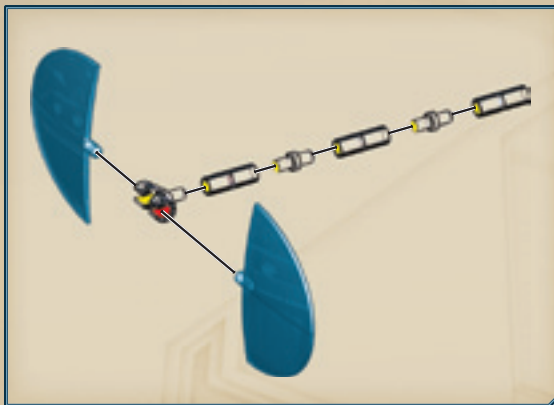

13



1X

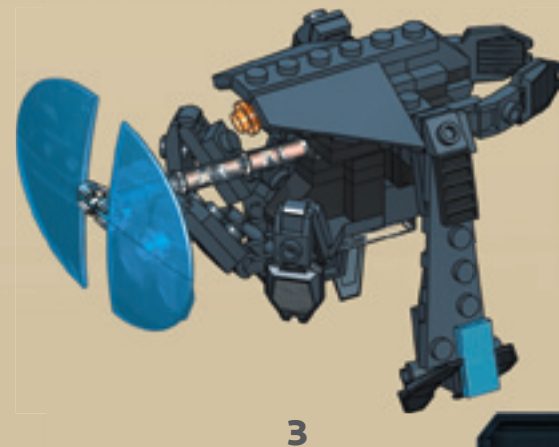
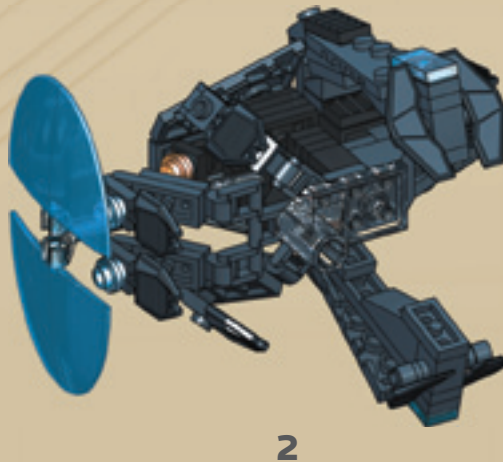
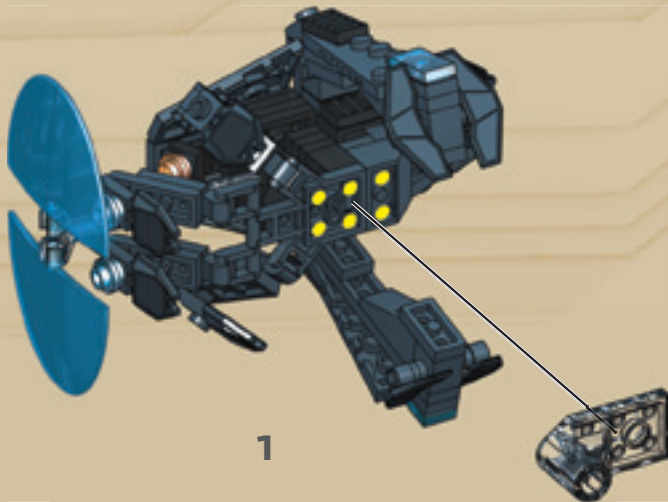

B



1

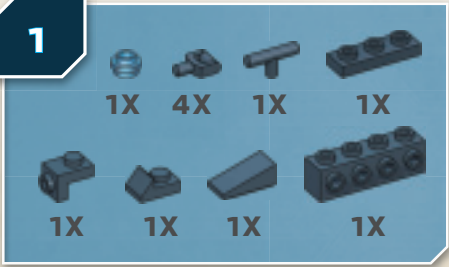

1

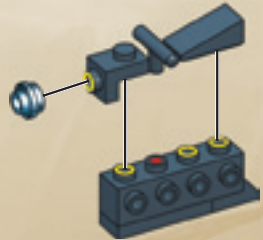

2

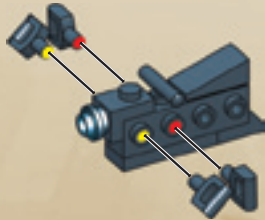

3

2

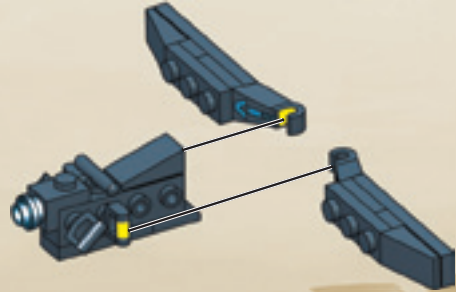
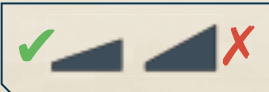
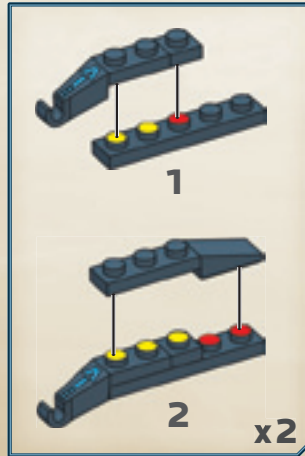

3

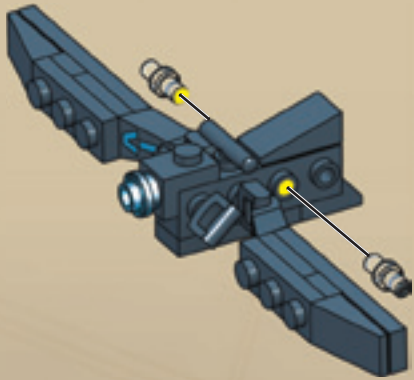
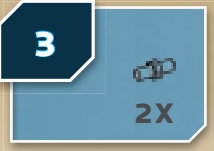

4

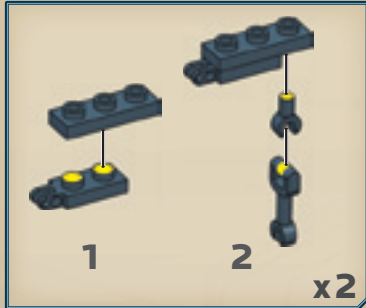

1

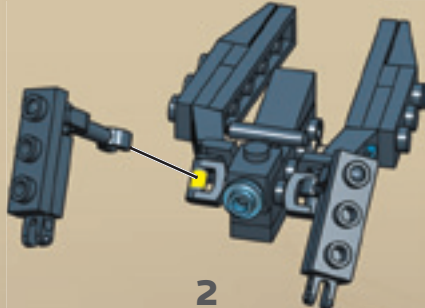

2

5



2X

2X

1X

1X



1

2

3

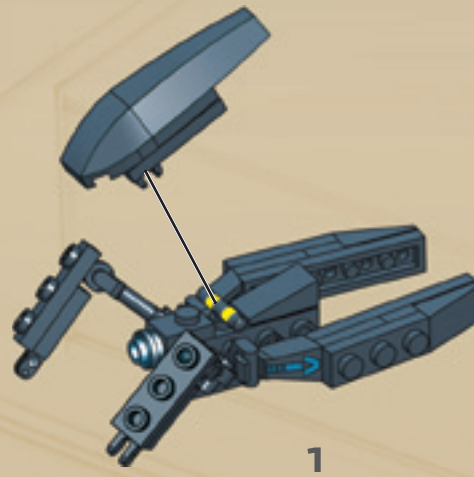

1

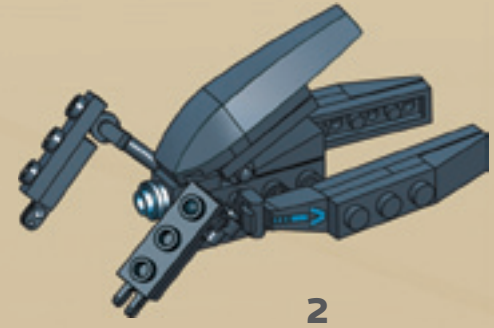

2

6

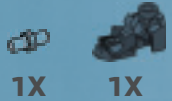

1X

1X

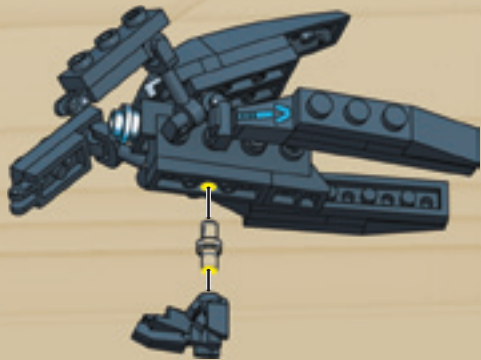

7

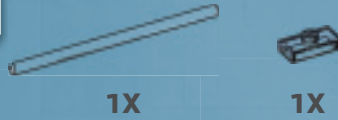

1X

1X

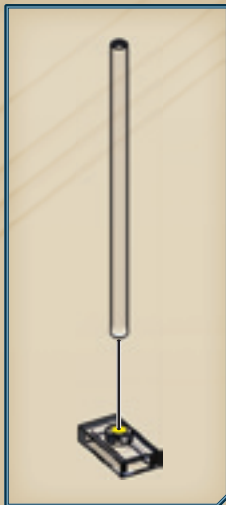

1



2

C



1



4X



4X

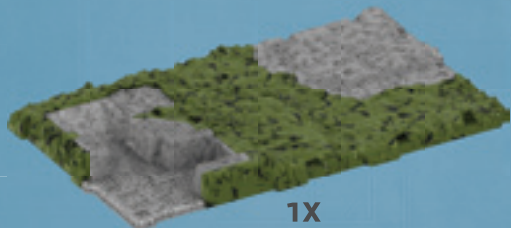

1X



2



1X



3X



2X



2X

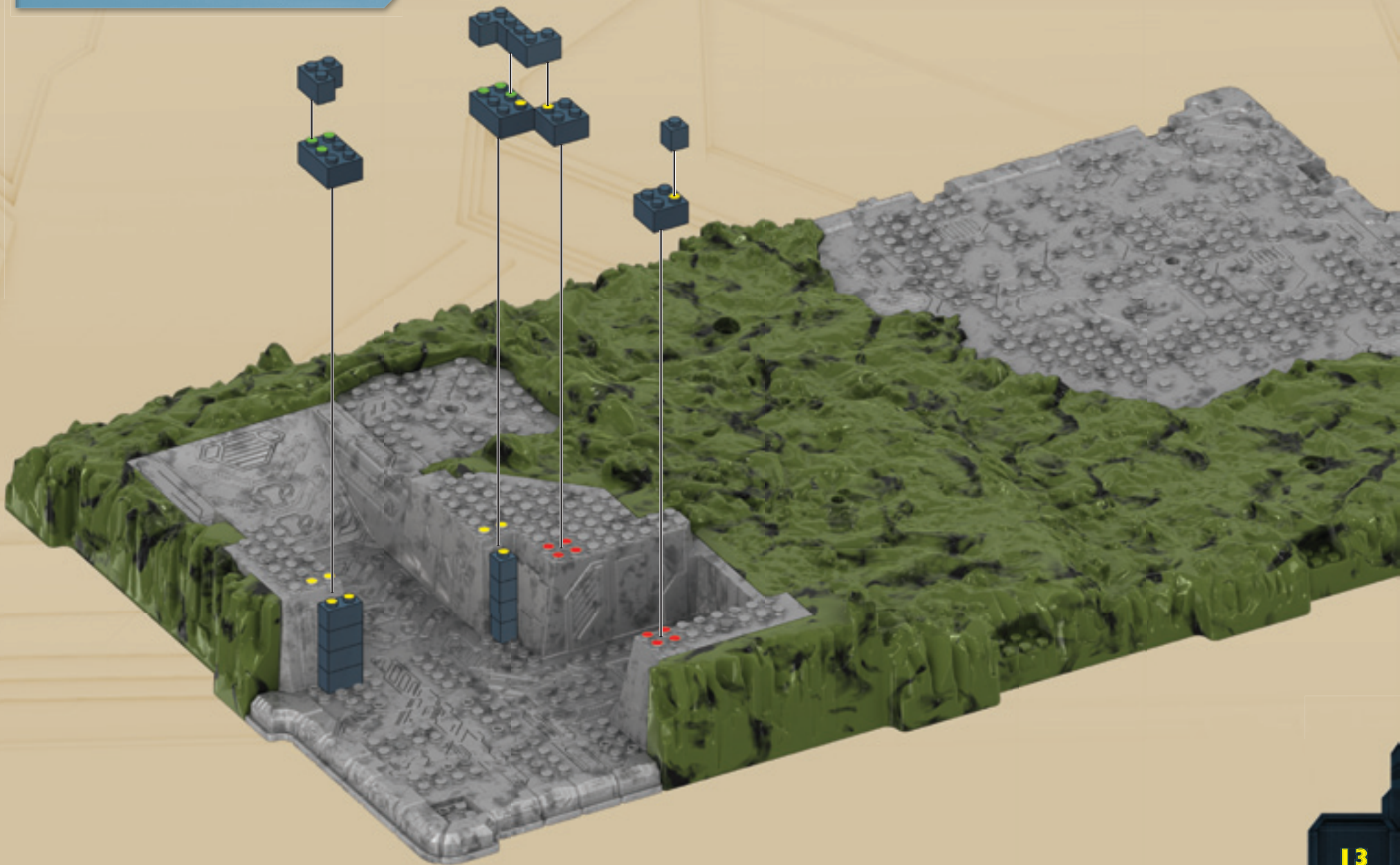

3



3X



4X



2X

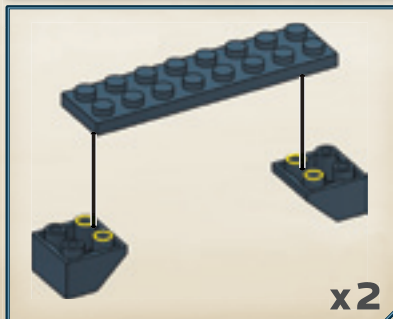

x2



4



1X



4X



1X



3X



1X

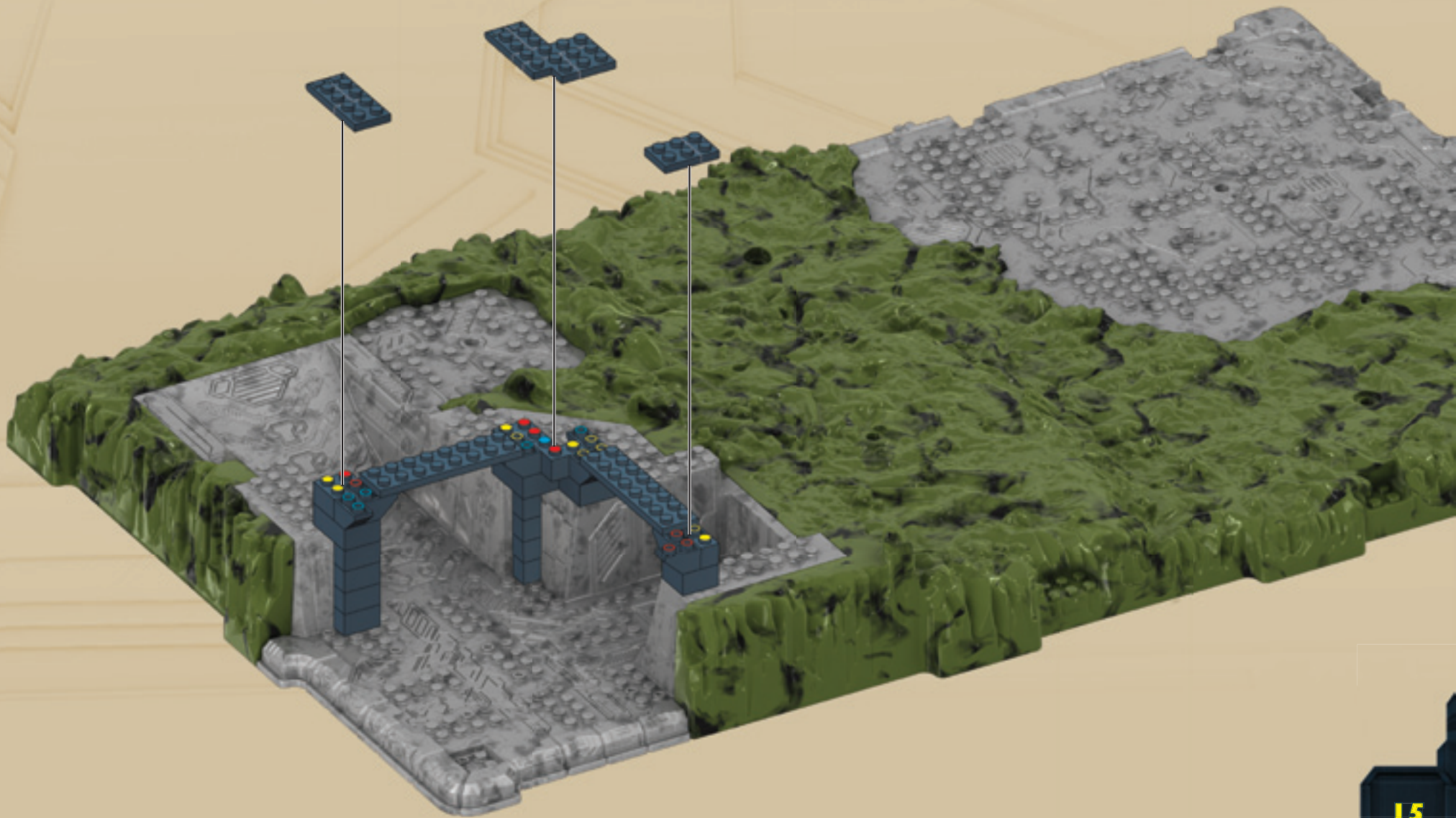

5



2X



1X



2X

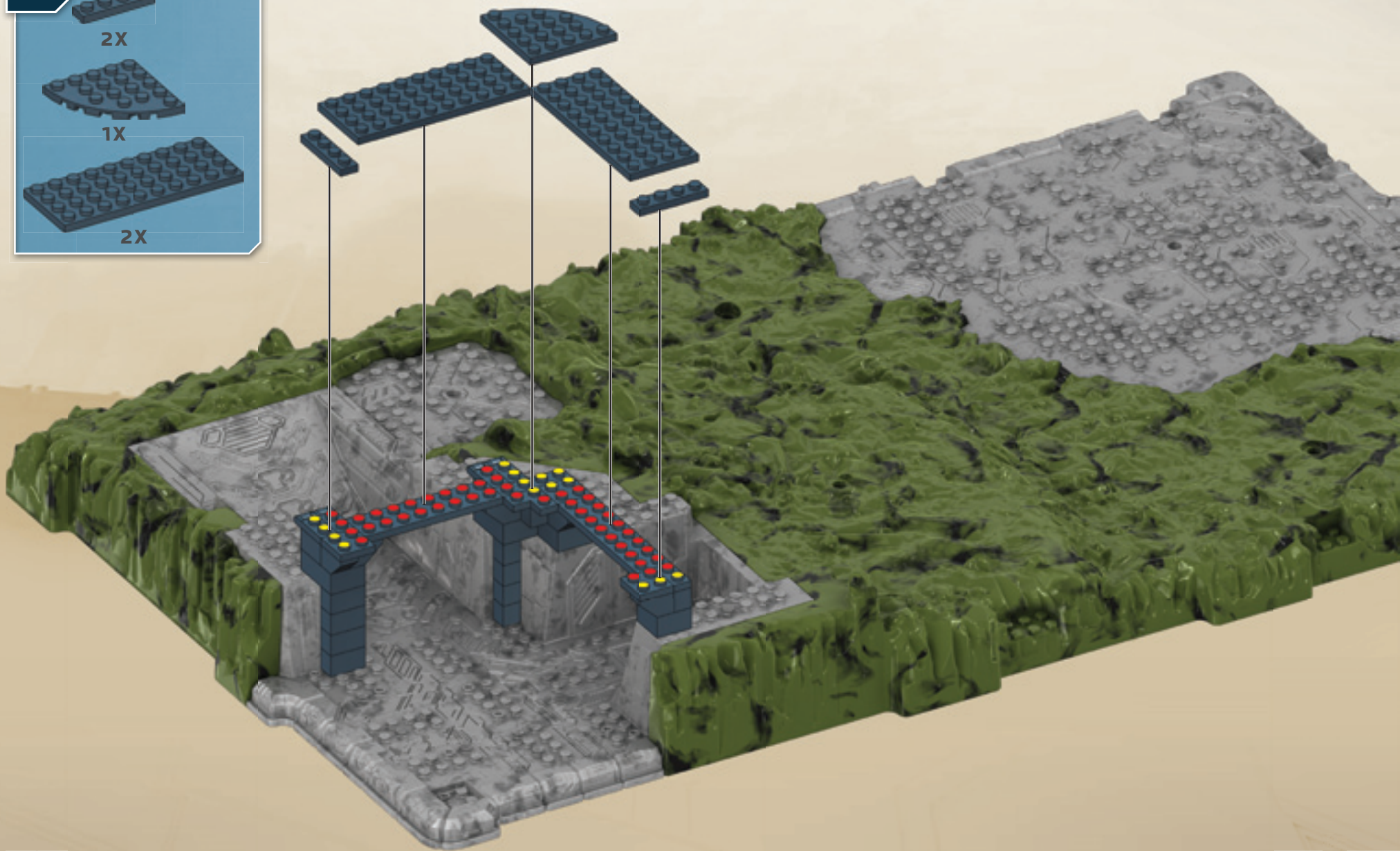

6



2X



4X



2X

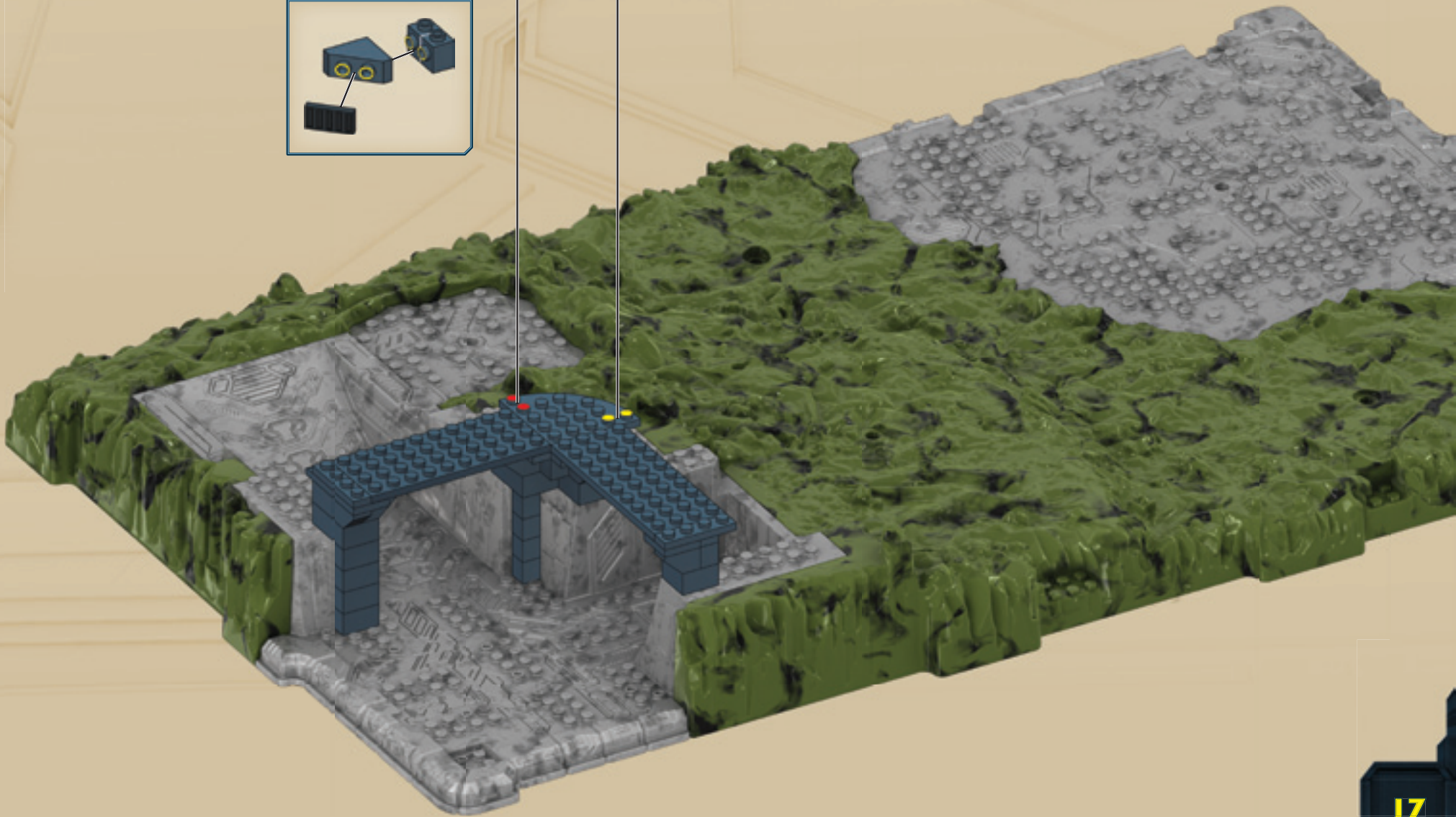
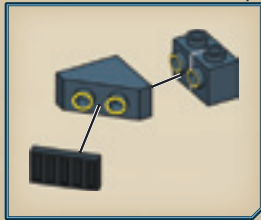
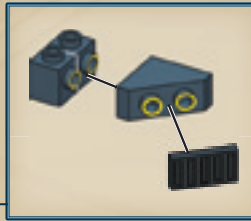

7

2X

1X

2X

2X

3X

4X

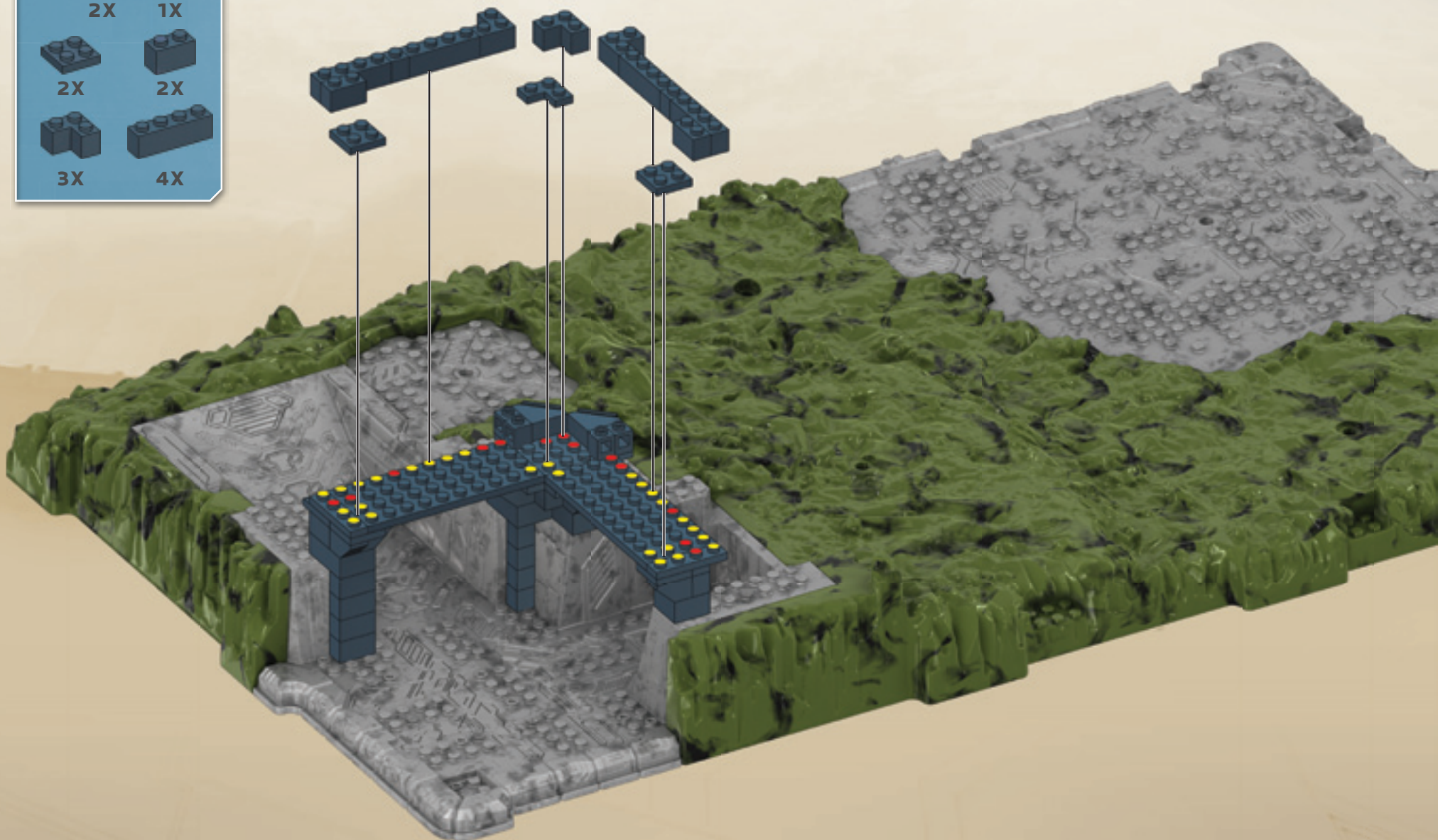

8



2X



4X



1X

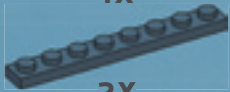

2X



2X

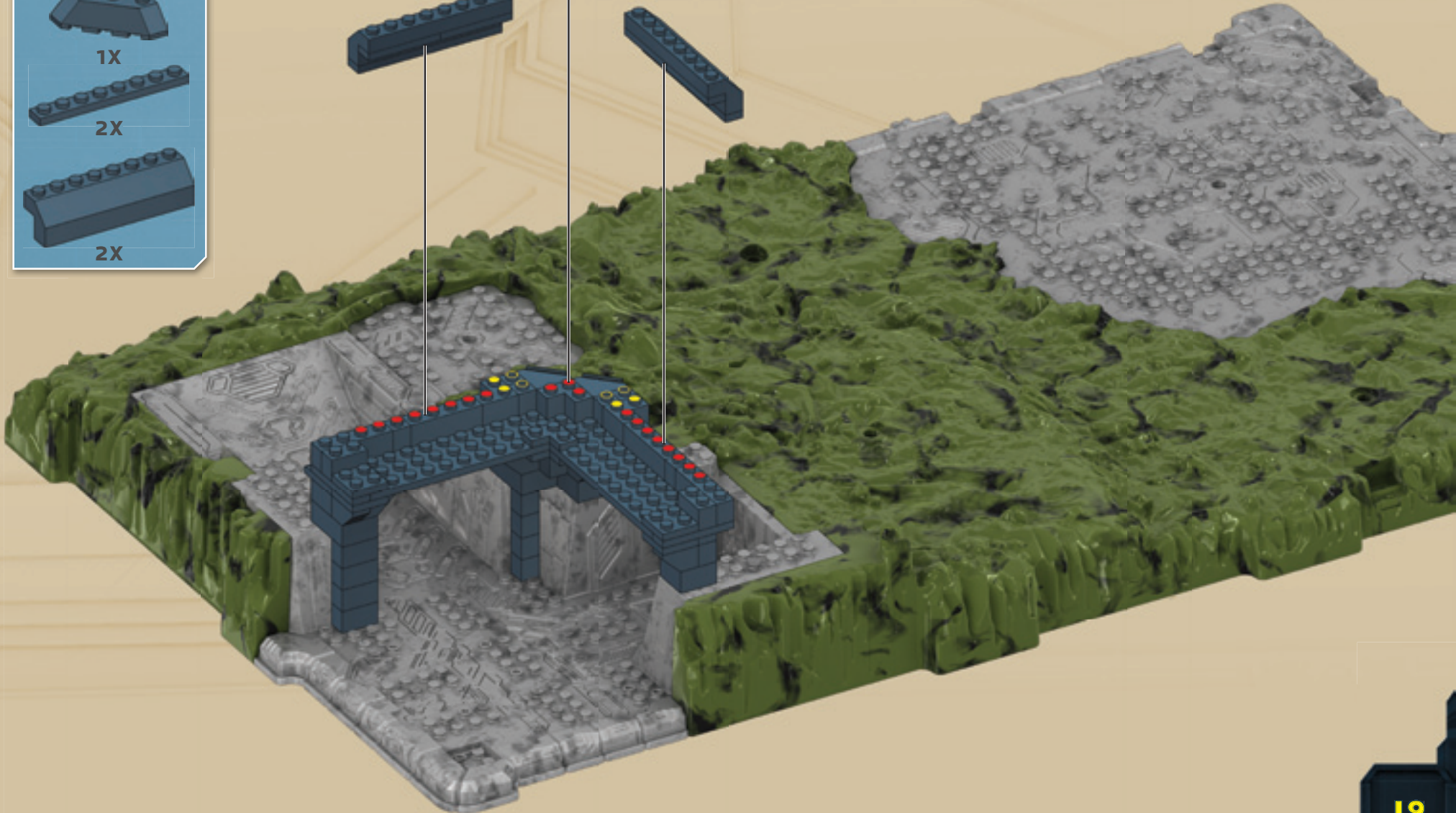
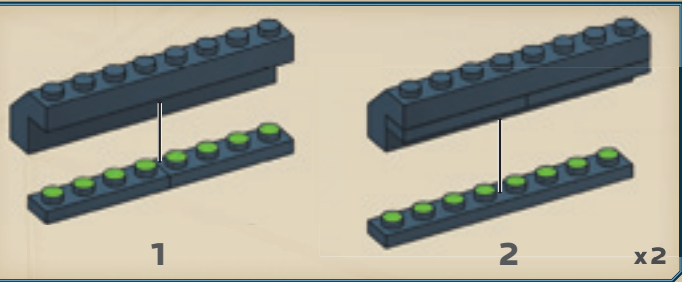

9



1X



4X



2X

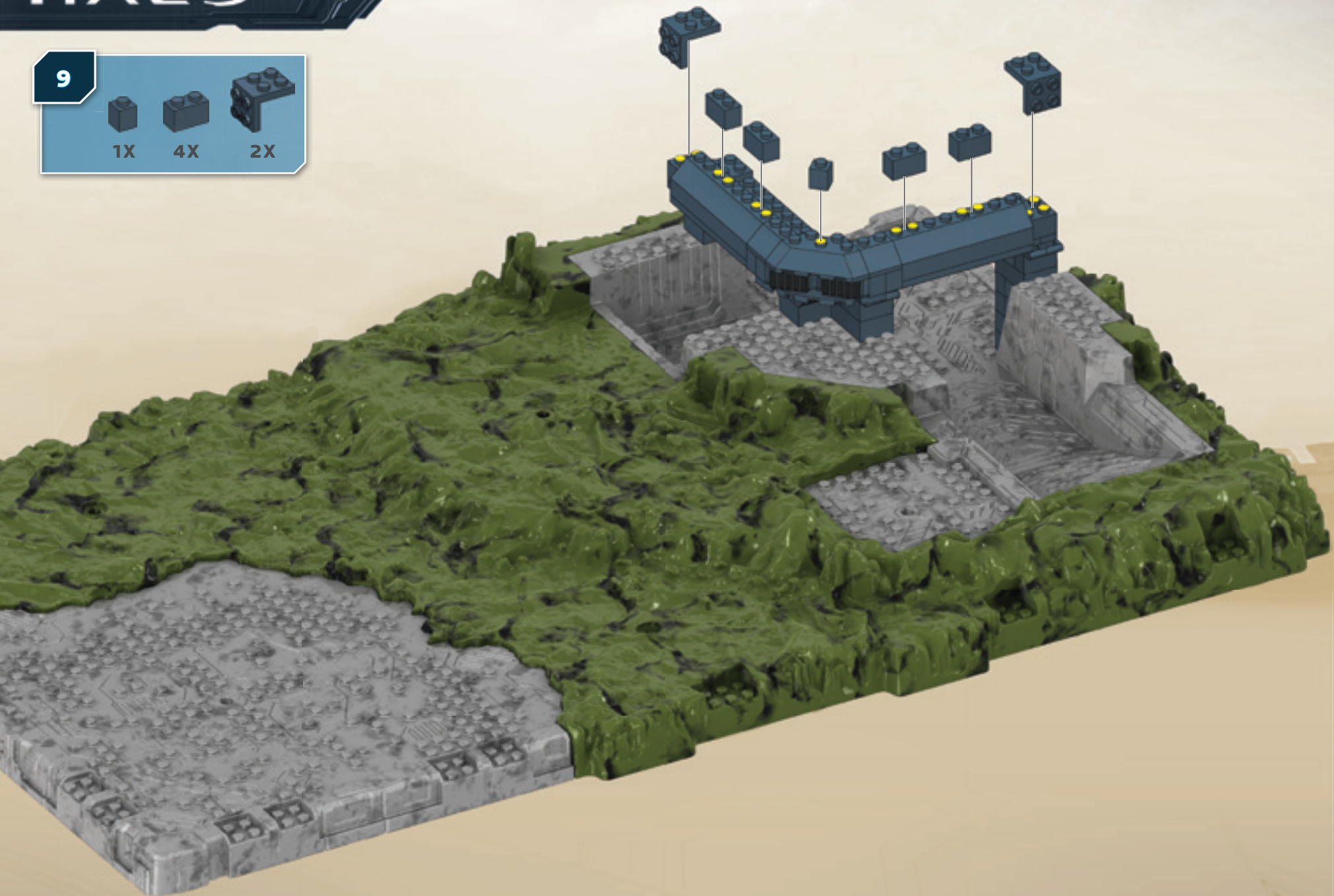

10



1X



4X

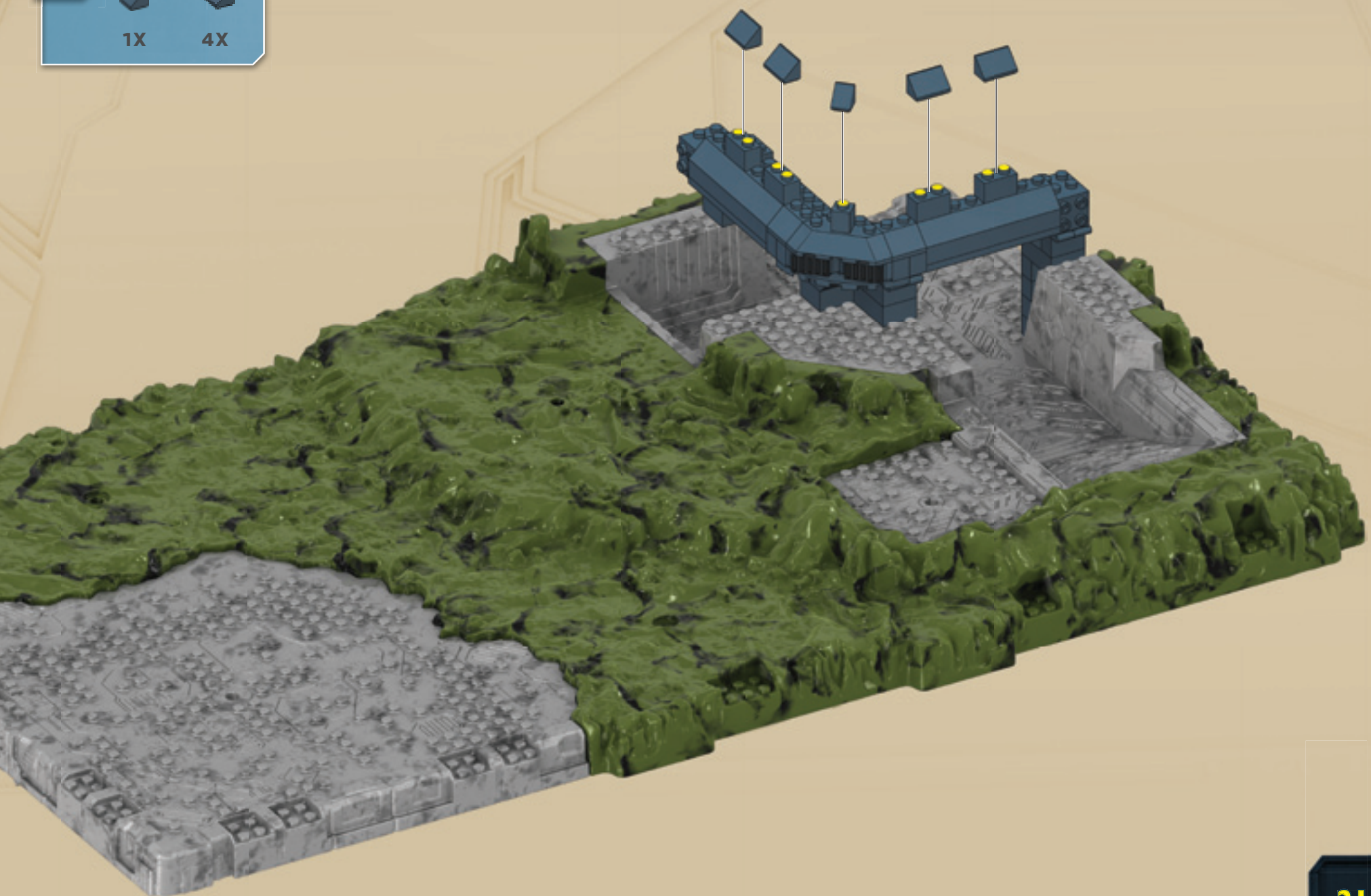

21

11

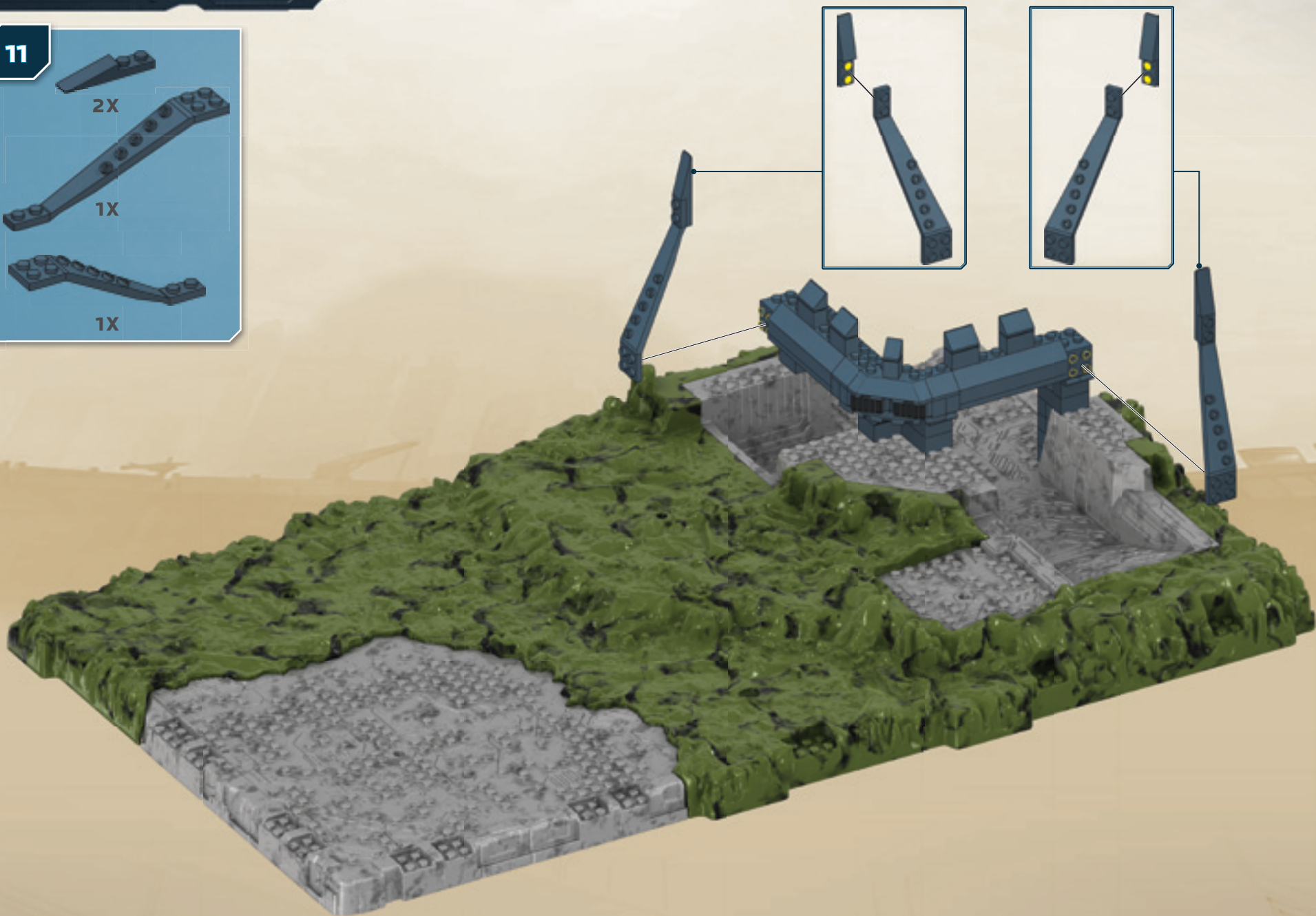
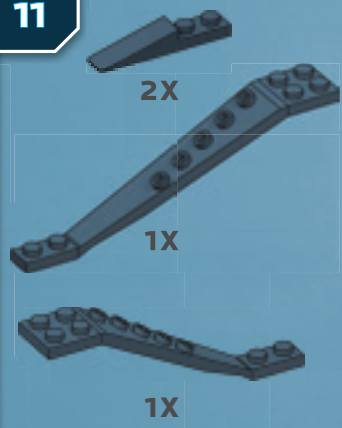

12



2X



1X

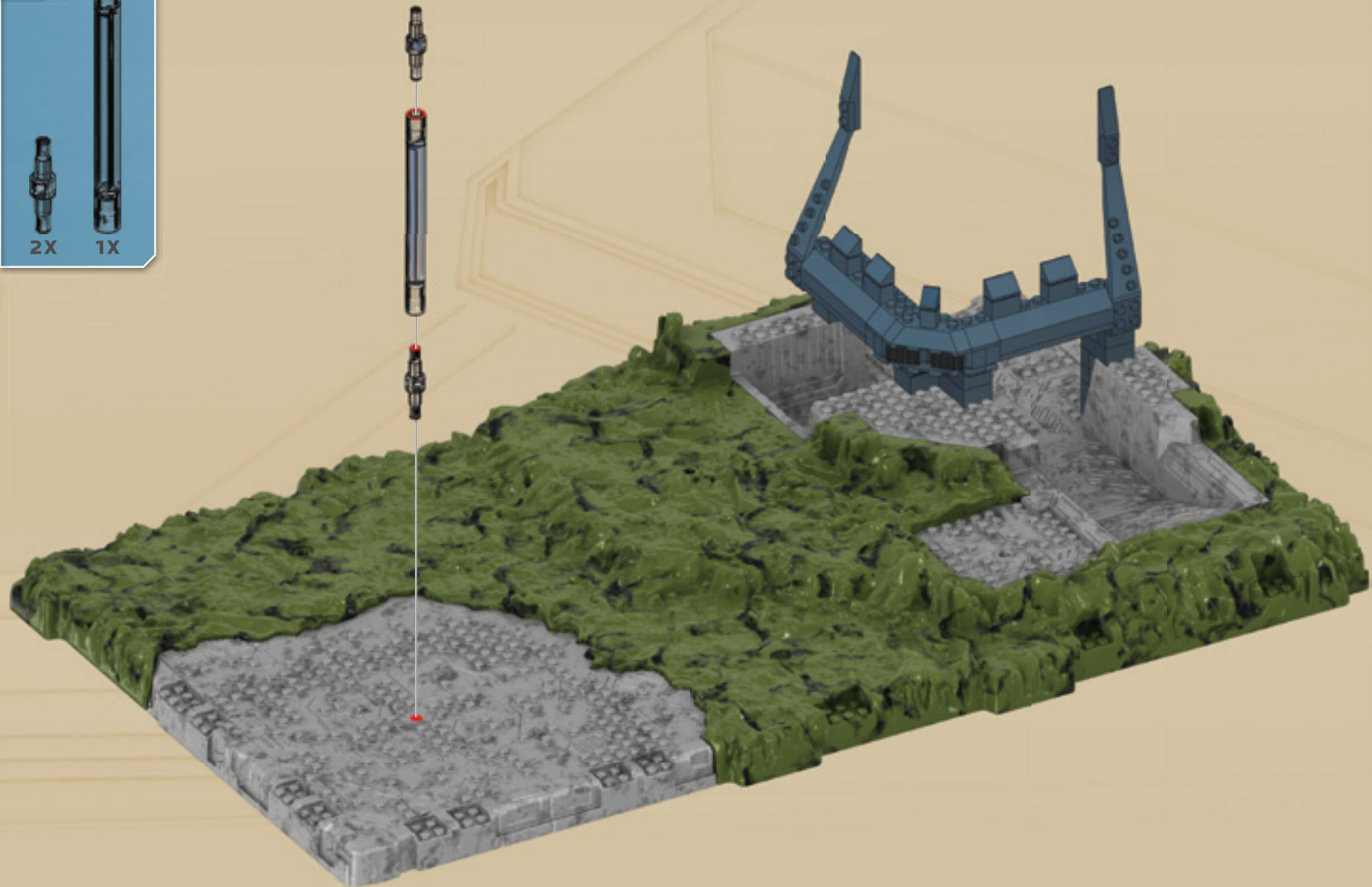

13

A

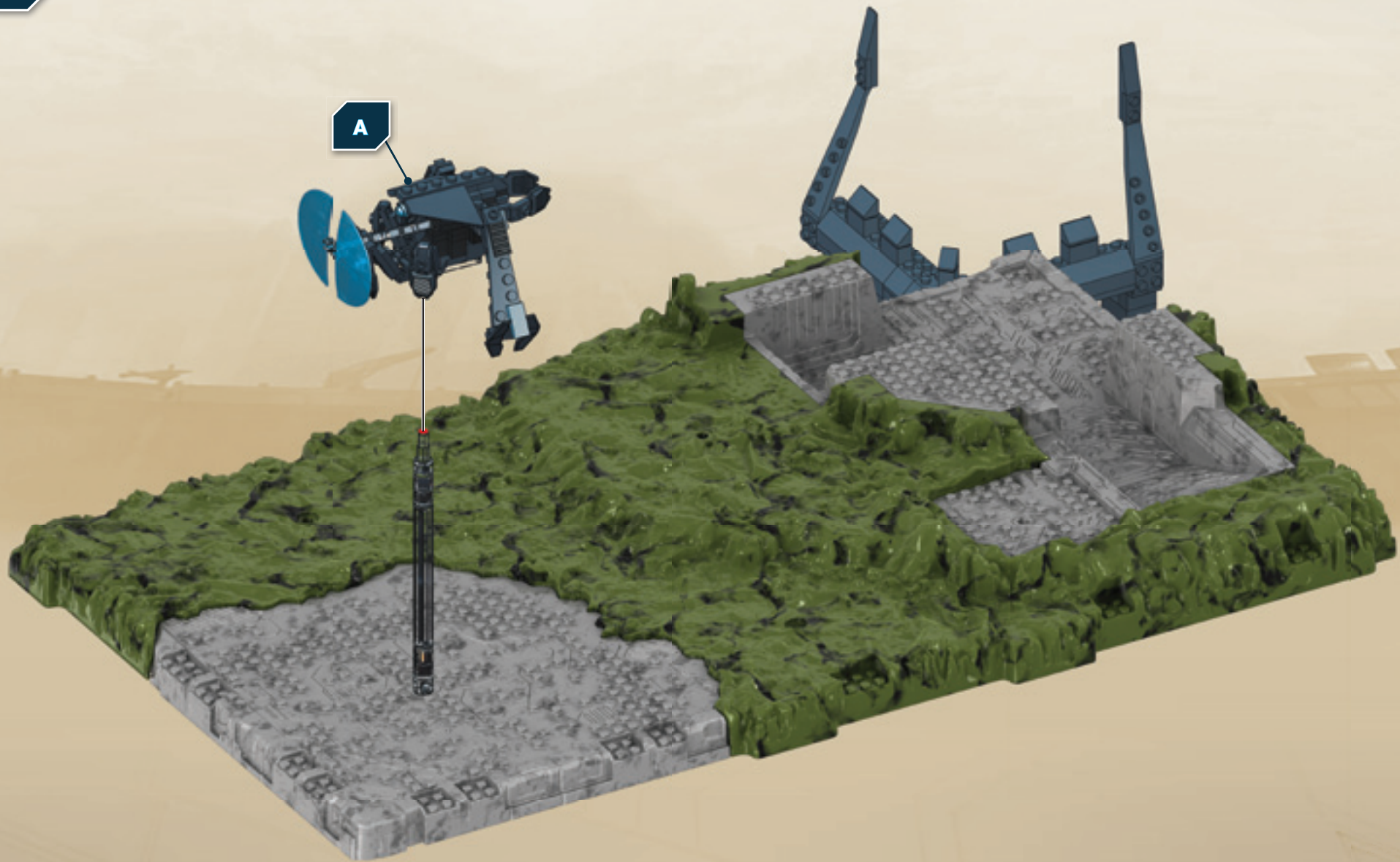

14



1X



1X

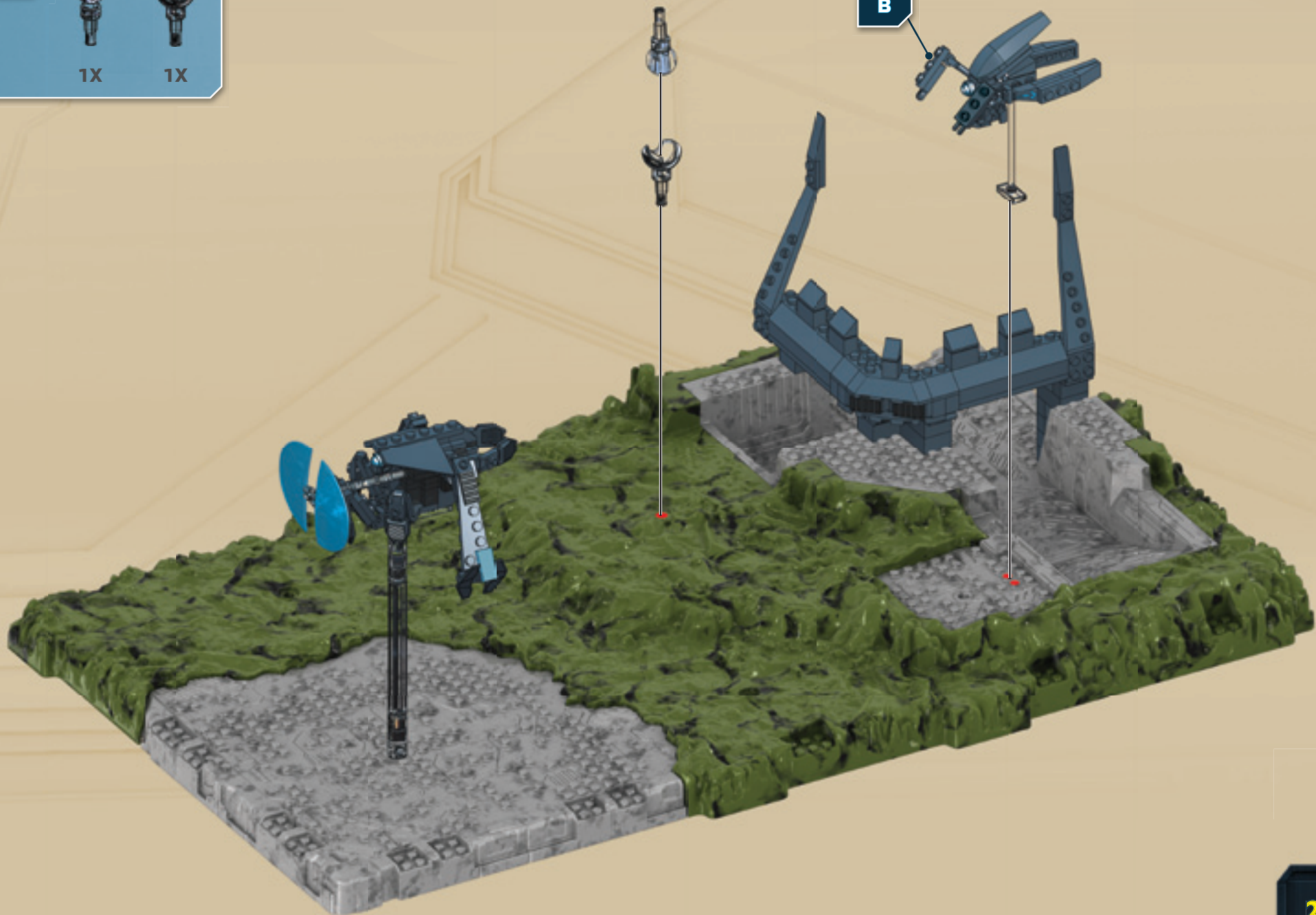

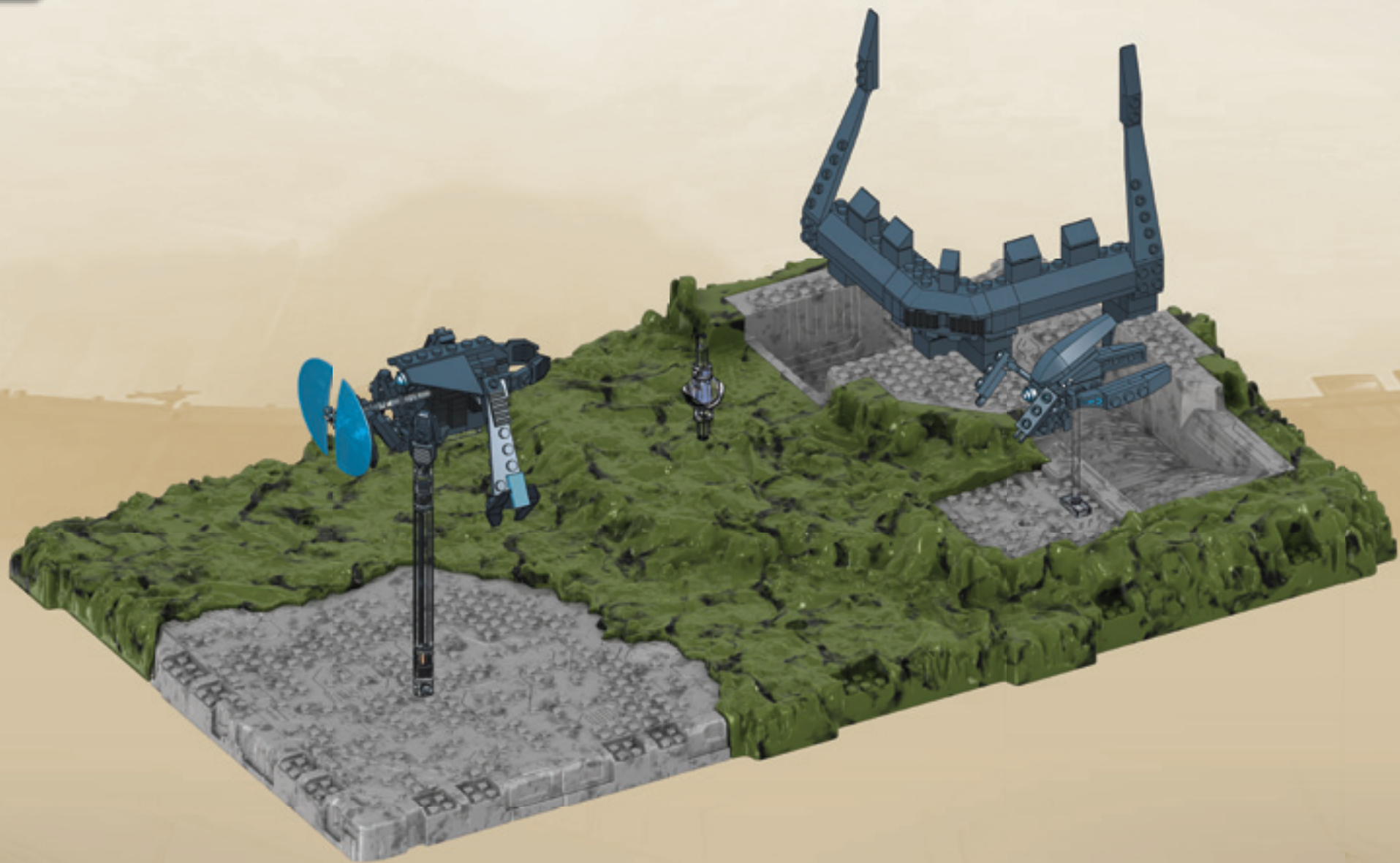

Go to halo.megabloks.com/downloads for rebuild instructions!

¡Visita halo.megabloks.com/downloads para obtener instrucciones de reconstrucción!

Allez au halo.megabloks.com/downloads pour obtenir des instructions de réassemblage!

Für Wiederaufbauanleitungen gehe zu halo.megabloks.com/downloads!

Ga voor bouw instructies naar halo.megabloks.com/downloads

Vai su halo.megabloks.com/downloads per le istruzioni di ricostruzione!

Visite halo.megabloks.com/downloads para instruções de reconstrução!

WARTHOG RESISTANCE 97011
RESISTENCIA WARTHOG
RÉSISTANCE DU WARTHOG
WARTHOG WIDERSTAND /
WARTHOG-VERZET / RESISTENZA
WARTHOG / RESISTÊNCIA WARTHOG



97011 NOT INCLUDED
NO INCLUYE EL 97011
97011 NON COMPRI
97011 NICHT ENTHALTEN
97011 NIET INBEGRIEPEN
97011 NON INCLUSO
97011 NÃO INCLUIDO

BATTLESCAPE III 97029
CAMPO DE BATALLA III
CHAMP DE BATAILLE III
ENGESCHNEITES III /
GEVECHTSTERREIN III / BATTLESCAPE III /
CAMPO DE BATALHA III



REBUILD!
¡RECONSTRUYE!
RECONSTRUIS!
BAUE! / BOWEN! /
COSTRUISCI! /
CONSTRÓI!

CONNECT AND EXPAND YOUR BATTLE!
¡CONÉCTATE Y EXPANDE TU BATALLA!
RELIEZ ET AGRANDISSEZ VOTRE
ÉQUIPE DE COMBAT!

VERBINDE UND ERWEITERE DEINEN KAMPF!
KOPPEL AAN ELKAAR EN BREID JE GEVECHT UIT!
COLLEGA ED ESTENDI LA TUA BATTAGLIA!
CONECTE E EXPANDA SUA BATALHA!

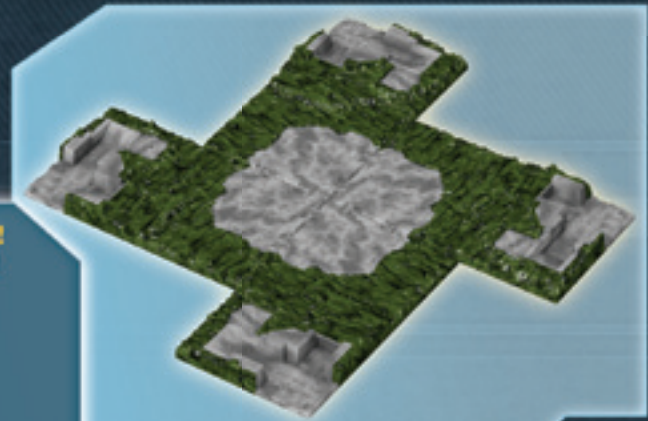

Additional purchases required to collect all elements shown. / Para coleccionar todos los elementos mostrados se precisa realizar unas compras adicionales. / Des achats additionnels sont nécessaires afin d'obtenir tous les articles de la collection illustrés. / Des achats additionnels sont nécessaires afin d'obtenir tous les articles de la collection illustrés. / Um alle dargestellten Elemente zu sammeln sind zusätzliche Käufe erforderlich. / Verdere aankopen zijn nodig om alle afgebeelde artikelen te verzamelen. / Acquisti supplementari necessari per collezionare tutti gli elementi illustrati. / Compras adicionais são necessárias para coleccionar todos os elementos exibidos.

HALO

THE AUTHENTIC COLLECTOR'S SERIES
 LA AUTÉNTICA SERIE PARA COLECCIONISTAS
 SÉRIE AUTHENTIQUE POUR COLLECTIONNEUR
 DIE AUTHENTISCHE SAMMLER-SERIE
 DE AUTHENTIEKE VERZAMELAARSGERIE
 L'AUTENTICA SERIE PER COLLEZIONISTI
 A SÉRIE DO VERDADEIRO COLECCIONADOR



MEGABLOKS CAMO EFFECT
EFFECTO CAMO MEGABLOKS
EFFET CAMO MEGABLOKS
 MEGABLOKS CAMO EFFECT
 MEGABLOKS CAMO EFFECT
 EFFETTO CAMO MEGABLOKS
 EFFETTO CAMO MEGABLOKS

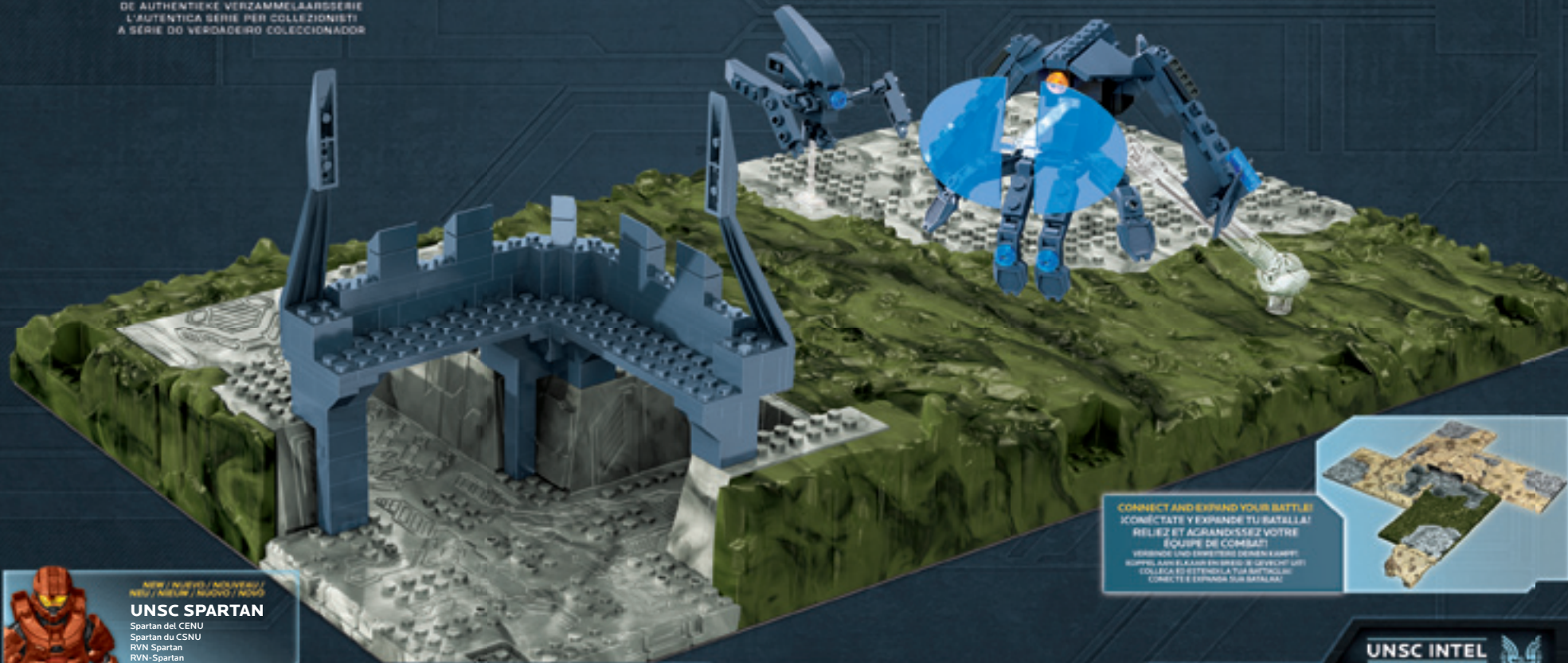

CONNECT AND EXPAND YOUR BATTLE!
CONÉCTATE Y EXPANDE TU BATALLA!
RELIEZ ET AGRANDISSEZ VOTRE ÉQUIPE DE COMBAT!
 VERBODEN OM ANDERSTREDS BENEDELEN.
 NIPPEN EN BIJZAKEN EN NIET IN GEBRUIK NIET.
 COLLEGA ES ESTENDI LA TUA BATTAGLIA.
 CORRECTE E EXPANDE SUO BATTAGLIA.



UNSC SPARTAN
 Spartan del CENU
 Spartan du CSNU
 RVN Spartan
 Spartan dell CSNU
 Spartan do CENU



FOFERUNNER ENFORCER



FORERUNNER SENTINEL

Collect them all! - ¡Colecciónalos todos! - Collectionne-les tous!
 Hei die die alle! - Verzamel ze allemaal! - Collezionezi tutti! - Colecciona todos ellos!



96993 97011 97010 97016

UNSC INTEL 