

MEGA BLOKS **BLOK BOTS**™

TRANSFORMING

9356

Knight & Wolf



Ages / Anos Pieces / Piezas

7+

440

⚠ WARNING:
CHOKING HAZARD – Small parts.
Not for children under 3 years.



Color chart.

Charte de couleurs.

Cuadro cromático.

Diagramma
colorimetrico.

Färgtabell.

Kleurkaart.

カラーチャート

彩圖

Active step / Étape active / Etapa activa / Istruzione attuale
Aktiv skede / Folgende stap / 此步為步驟 / 現段階

Previous step / Étape précédente / Etapa precedente / Istruzione
precedente / Føregående skede / Vorige stap / 此步為前步 / 前段階



Adult assistance is required. / L'aide d'un adulte est requise. / Necesita ayuda de un adulto. / L'aiuto di un adulto è richiesto. /
Hjælp af en voksen er nødvendigt. / Hulp van volwassenen is gewenst. / 大人の援助が必要です。 / 成人的協助是必要的。 / 小零件有窒息危險。

WARNING:

Choking hazard - Small parts.
Not for children under 3 years.

AVERTISSEMENT:

Risque de suffocation. Ne convient pas à
un enfant de moins de 3 ans - contient de
petits éléments.

ADVERTENCIA:

Peligro de asfixia. No recomendado para niños
menores de 3 años - contiene piezas pequeñas.

AVVERTENZA:

Rischio di soffocamento. Non adatto ad un
bambino di età minore ai 36 mesi. Contiene parti
piccole - non ingerire.

WARNING:

Risk for kvävning. Ikke egnet til barn
under
3 år - inneholder smådeler.

WAARSCHUWING:

Stikgevaar. Niet geschikt voor kinderen
ouder 3 jaar - i.v.m. kleine onderdelen.

注意:

飲み込むと 危険です。
小さいパーツがあるので、
3歳以下の幼児には
与えないでください。

不适于三岁以下儿童。

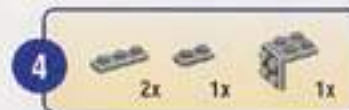

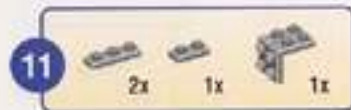
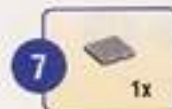



Active step / Étape active / Etapa activa / Istruzione attuale
Aktiv skede / Volgende stap / 現在のステップ / 现阶段

Previous step / Étape précédente / Etapa precedente / Istruzione precedente
Föregående skede / Vorige stap / 前のステップ / 前阶段



14



1x



1x



15



1x

1x



16



2x



17



1x



18



1x

1x



19



1x



20



21

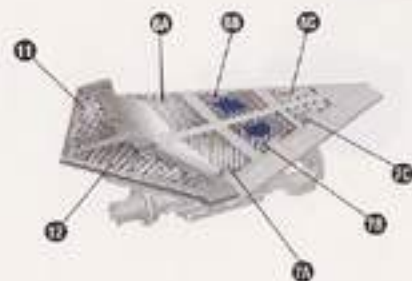
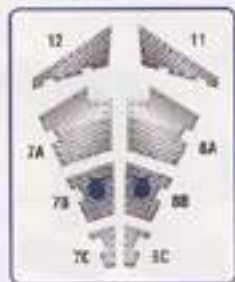

22



23



1x

1x



24



1x



25



1x



26



2x



27



28



1x

4x





Active step / Étape active / Etapa activa / Istruzione attuale
Aktiv skede / Folgende stap / 次の手順 / 現段階

Previous step / Étape précédente / Etapa precedente / Istruzione precedente
Föregående skede / Vorige stap / 前の手順 / 前段階



29



30



31



32



33



34



35

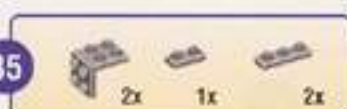

36







Active step / Étape active / Etapa activa / Istruzione attuale
Aktiv skede / Volgende stap / 现在的手续 / 现阶段

Previous step / Étape précédente / Etapa precedente / Istruzione precedente
Föregående skede / Vorige stap / 以前的手续 / 前阶段



47



48



49



50



51



52



53

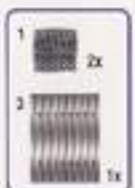

54



55



56



57



58



59



60



61



62



63





Active step / Étape active / Etapa activa / Istruzione attuale
Aktiv skede / Folgende stap / 现在的步骤 / 现阶段

Previous step / Étape précédente / Etapa precedente / Istruzione precedente / Föregående skede / Vorige stap / 从前的步骤 / 前阶段



64



65



66

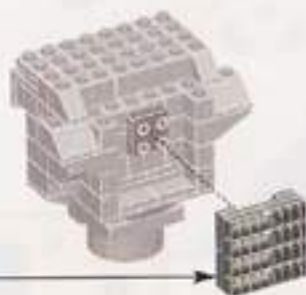

67



68



69



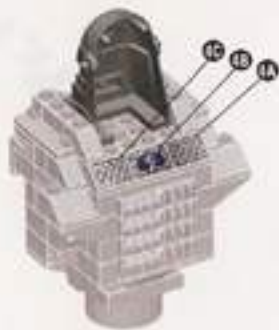

75





Active step / Étape active / Etapa activa / Istruzione attuale
Aktiv skede / Folgende stap / 现在的一步 / 现阶段

Previous step / Étape précédente / Etapa precedente / Istruzione precedente
Föregående skede / Yorige stap / 以前的一步 / 前阶段



79



80



81



82



83



84



85



86



87

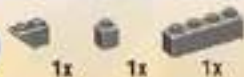

88



89



90



91



92



93





Active step / Étape active / Etapa activa / Istruzione attuale
Aktiv skede / Volgende stap / 现在的步骤 / 现阶段

Previous step / Étape précédente / Etapa precedente / Istruzione precedente
Föregående skede / Vorige stap / 以前的步骤 / 前阶段



94



4x

2x

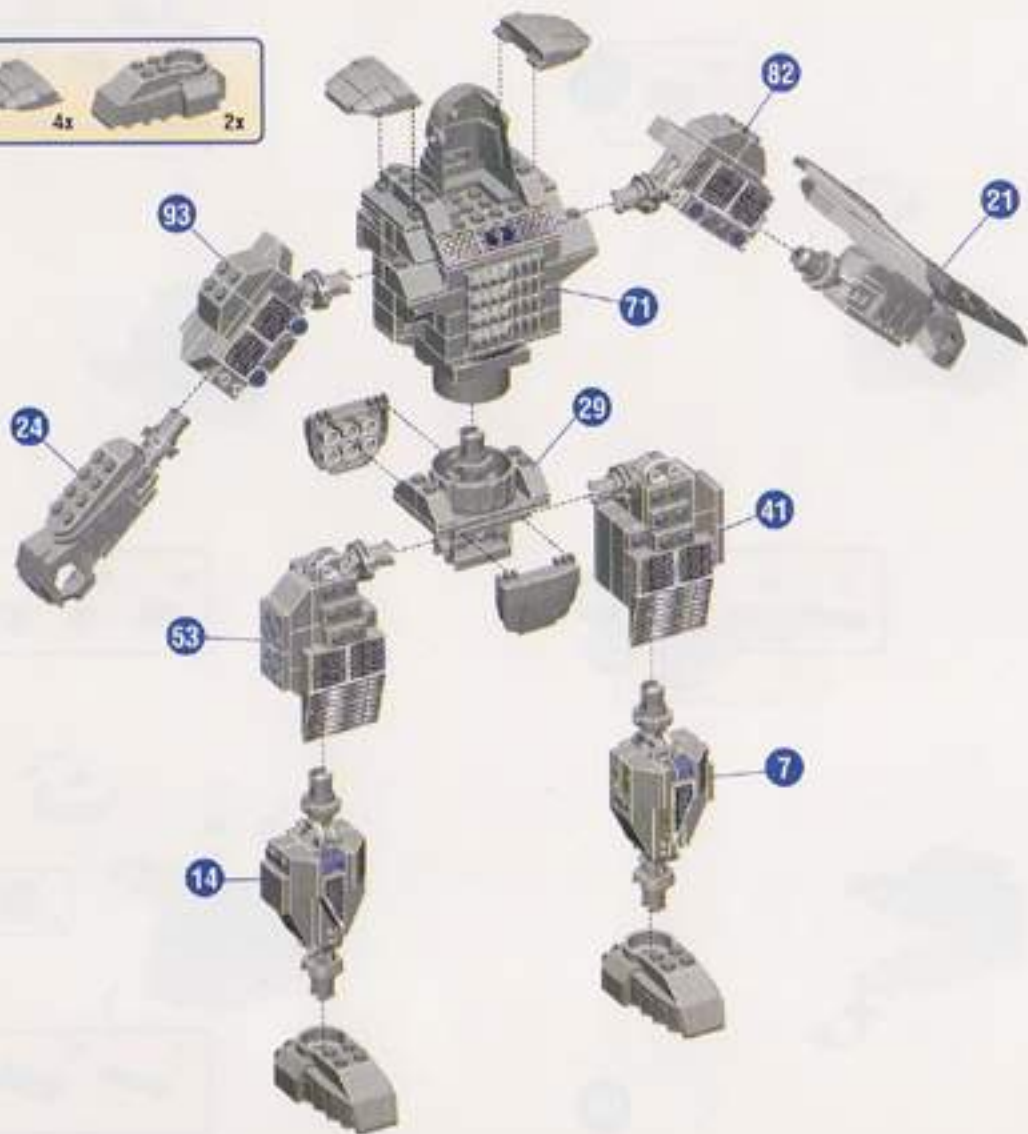

95



96



97





Active step / Étape active / Etapa activa / Istruzione attuale
Aktiv skede / Volgende stap / 现在的步骤 / 现阶段

Previous step / Étape précédente / Etapa precedente / Istruzione precedente / Föregående skede / Vorige stap / 以前的步骤 / 前阶段



98

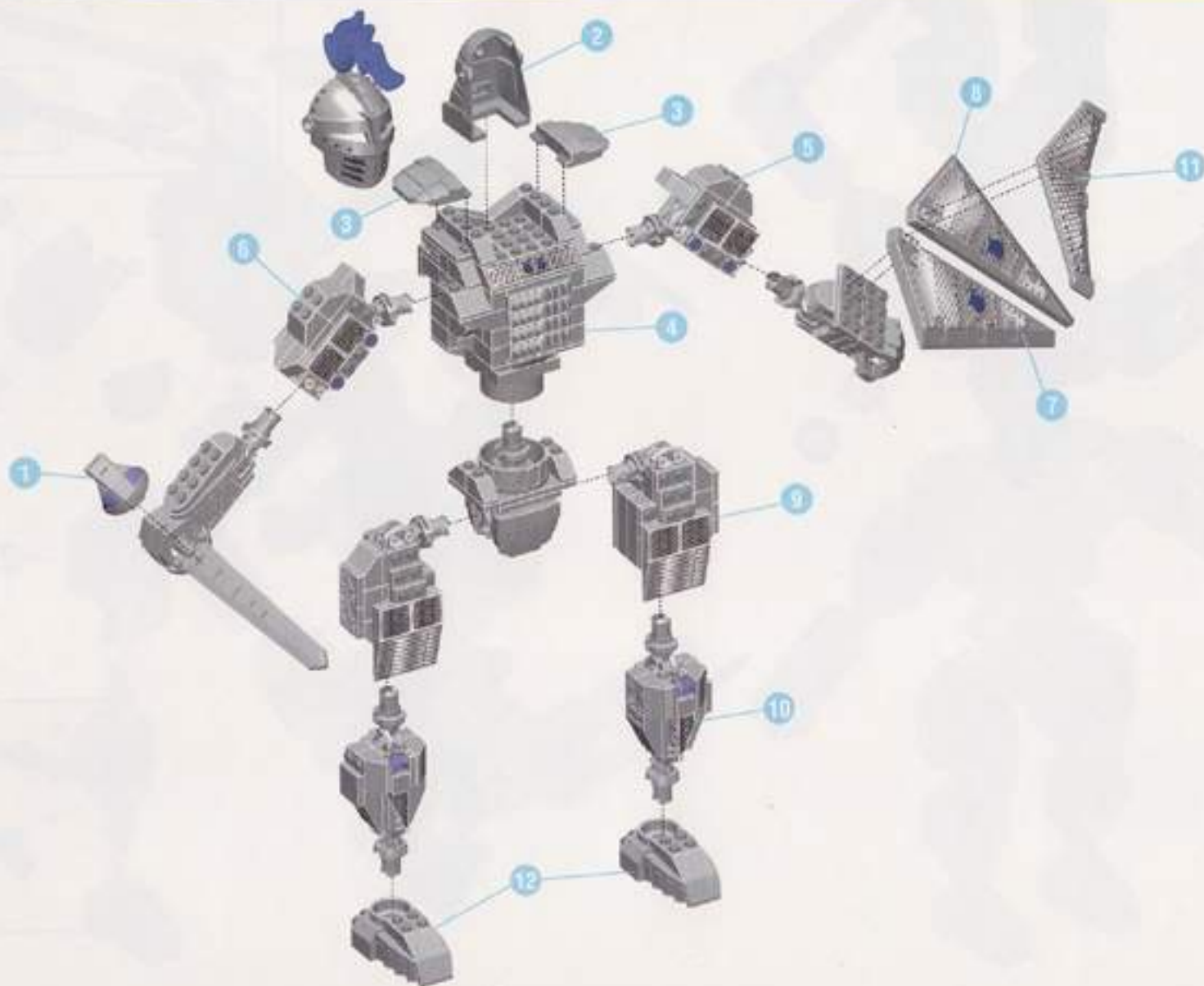

99

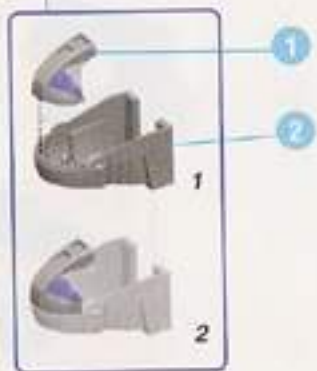
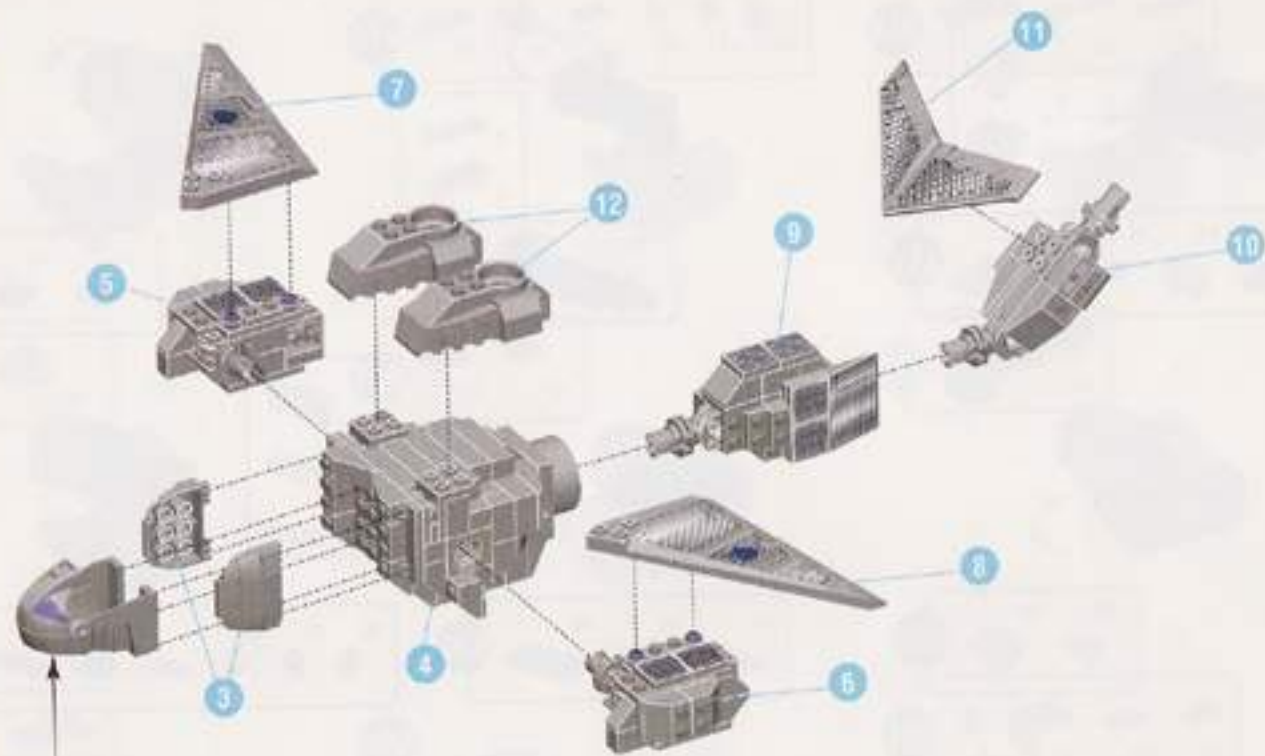

100

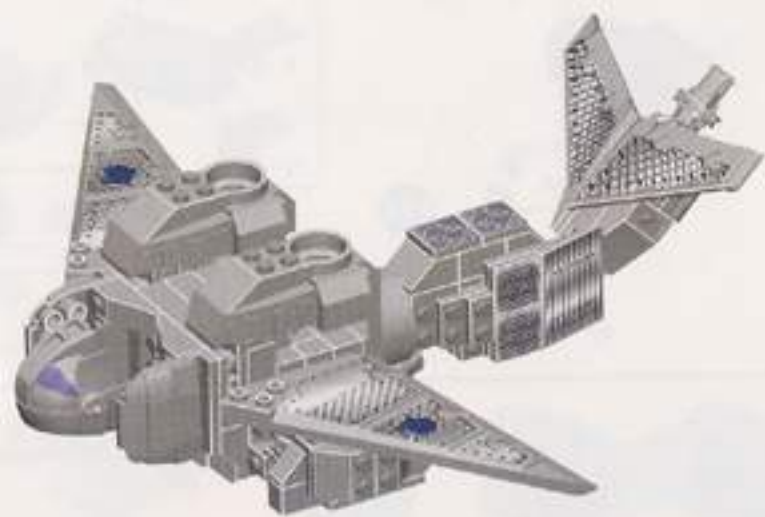



Active step / Étape active / Etapa activa / Istruzione attuale
 Aktiv skede / Voigende stap / 现在的一步 / 现阶段

Previous step / Étape précédente / Etapa precedente / Istruzione precedente / Föregående skede / Vorige stap / 从前的步骤 / 前阶段



101



1x



102



1x 1x 1x 1x 1x



103



1x



104



105



1x 1x 1x 2x 1x 1x



106



1x 1x 1x



107



1x 1x



108



2x



109



1x 1x



110



1x



111



1x 1x 1x 1x 1x

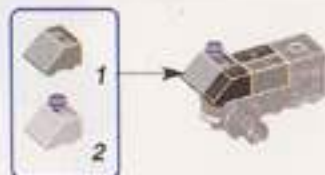

112



1x



113



114

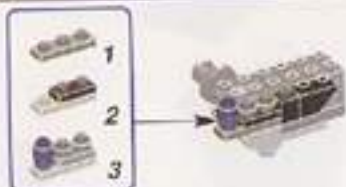

115



116



117



118



119



120



121



122



123

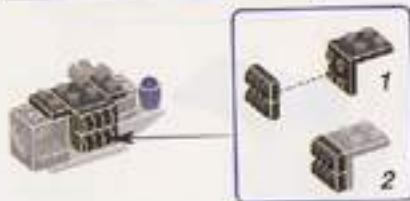

124



125



126



127



128





Active step / Étape active / Etapa activa / Istruzione attuale
Aktiv skede / Folgende stap / 現在のステップ / 現段階

Previous step / Étape précédente / Etapa precedente / Istruzione precedente
Föregående skede / Vorige stap / 以前のステップ / 前段階



129



130



131



132



133



134



135



136



137



138



139



140



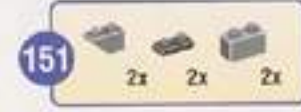



Active step / Étape active / Etapa activa / Istruzione attuale
Aktiv skede / Folgende stap / 現在のステップ / 现阶段

Previous step / Étape précédente / Etapa precedente / Istruzione precedente
Föregående skede / Vorige stap / 以前的步骤 / 前阶段



156

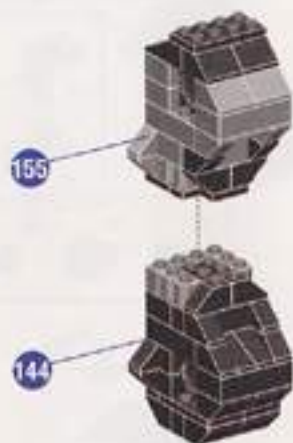

157



158



159



160

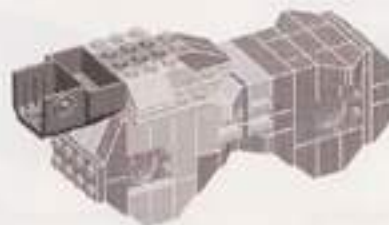

161



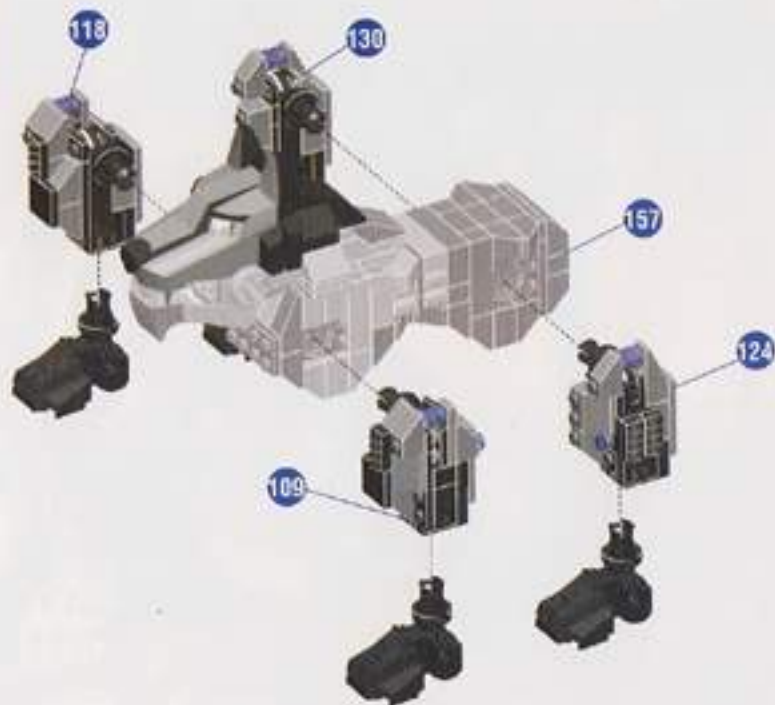
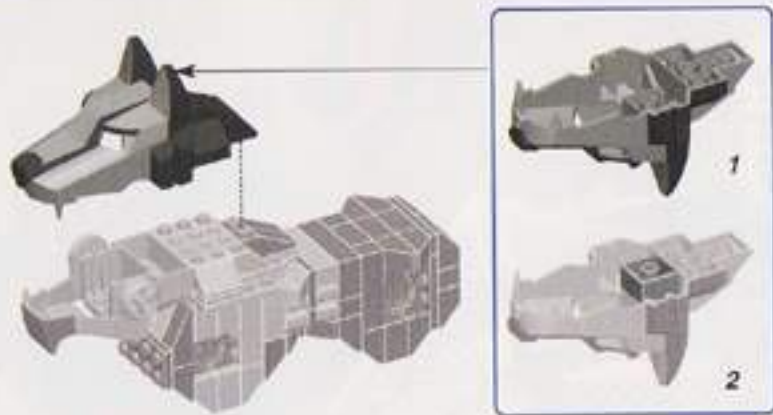

164



165



166



MEGA
BLOKS

TRANSFORMING

BLOK BOTS™

9356

Gladiator
& Lion
9358



Knight
& Wolf
9356

Knight
& Wolf
9356

Ninja
& Dragon
9357

Ritvik

© 2001, RITVIK HOLDINGS INC.
PRINTED IN CANADA D93561

www.megabloks.com