

5906

Sand Storm™

MEGA
BLOKS

nano™
Building System



7+ Ages / Edades
Âges / Leeftijden

70 Pieces / Piezas
Pièces / Stuks



Welcome to the world of NANO!

NANO Bloks™ is an exciting, new, miniature construction system, which allows you to **BUILD, PLAY** and **COLLECT** in a size and range that you have never seen before. I am **NANOMAN** and let me introduce you to a cool new world of building detail, action and fun!

¡Bienvenido al mundo de NANO!

NANO Bloks™ es un nuevo y excitante sistema de construcción miniatura que te deja **CONSTRUIR, JUGAR** y **COLECCIONAR** en una dimensión y de alcance nunca visto antes. ¡Soy **NANOMAN**, permítame que te presente un asombroso nuevo mundo para construir con detalles, acción y entretenimiento!

Bienvenue au monde de NANO!

NANO Bloks™ est un nouveau et fascinant système de construction à partir de pièces miniatures qui vous permet de **CONSTRUIRE, de JOUER** et de **COLLECTIONNER** un éventail de pièces d'une taille inédite. Je suis **NANOMAN**. Permettez-moi de vous présenter un nouveau monde de construction, d'action et de plaisir !

Welkom in de wereld van NANO!

NANO Bloks™ vormt een nieuw en opwindend miniatuur bouwsysteem dat je laat **BOUWEN, SPELEN** en **VERZAMELEN** in een formaat en verscheidenheid dat je nooit eerder gezien hebt. Ik ben **NANOMAN** en ik wil je bekend maken met een leuke nieuwe wereld van bouwdetails, actie en plezier.



I am here to help you with your building project so look for me throughout this playbook. I will guide you through the more challenging sections of these instructions to make sure that your building experience is easy, fun & rewarding.

Aquí estoy para ayudarte con tu proyecto de construcción, así que búscame en todo este libro de juego. Seré tu guía a través de las secciones más complejas de estas instrucciones para que tu aventura de constructor resulte fácil, entretenida y gozosa.

Je suis ici pour vous aider dans votre projet de construction. Il suffit de me rechercher dans ce livre de jeu. Je vous accompagnerai à travers les sections les plus difficiles de ces instructions pour vous assurer une expérience de construction facile, amusante et valorisante.

Ik ben hier om je te helpen met je bouwproject, dus je vindt me overal in deze handleiding. Ik zal je gids zijn in de meer ingewikkelde delen van deze instructies om jouw bouwervaring zo gemakkelijk, plezierig en bevredigend te maken als het maar kan.

Please read these instructions carefully before first use and keep them for future reference.

Leer estas instrucciones cuidadosamente antes de la primera utilización y guárdalas para referencia futura.

Il est recommandé de lire attentivement ce feuillet avant la première utilisation et de le conserver pour référence future.

Wij raden u aan deze handleiding zorgvuldig te lezen en te bewaren voor eventuele raadpleging op een later tijdstip.

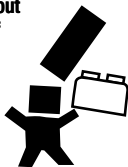

Nanoverse

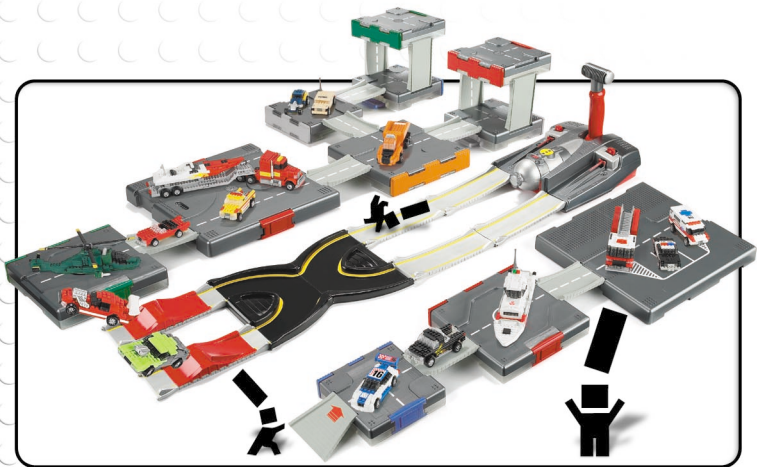

Military
Militar
Militaire
Militair



Racing
Carreras
Course
Racing



Rescue
Rescate
Secours
Redding



Construction
Construcción
Construction
Gebouw



Classic/Show cars
Autos clásicos/exhibición
Voitures classiques/d'exposition
Klassieke/Show autos

Nanocase Playset / Juego Nanocase Jeu Nanocase / Nanocase Speelpakket

Action Key / Launcher – fires vehicles

Tecla de acción / Lanzador – dispara vehículos

Clé d'activation / Lanceur – déploie les véhicules

Actiesleutel / Lanceerinrichting – schiet voertuigen af

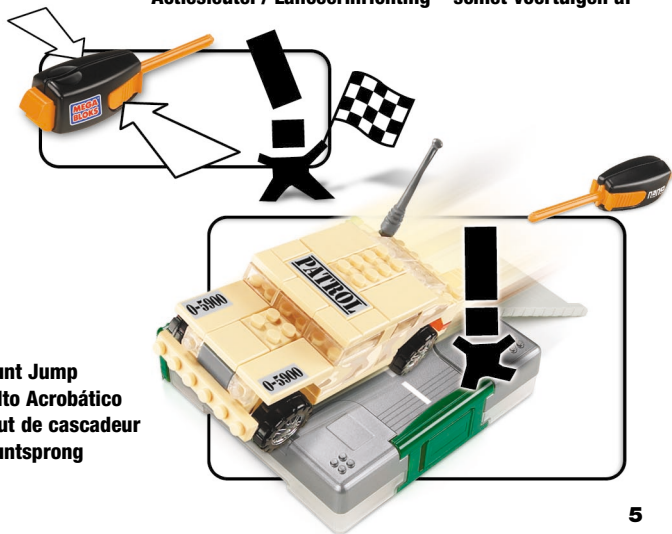

Stunt Jump
Salto Acrobático
Saut de cascadeur
Stuntsprong

Nanocase Building / Construcción Nanocase Construction Nanocase / Nanocase Gebouw

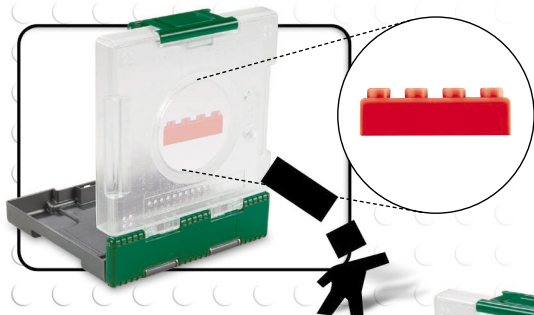

**Nano-magnifier
Nano-lupa
Nano-loupe
Nano-loep**

**Ruler to measure Nano Bloks™ pieces
Regla para medir piezas Nano Bloks™
Règle pour mesurer les pièces Nano Bloks™
Lineaal voor het meten van Nano Bloks™
bouwstenen**

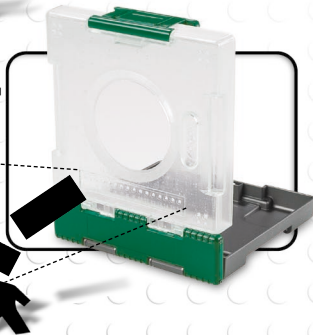

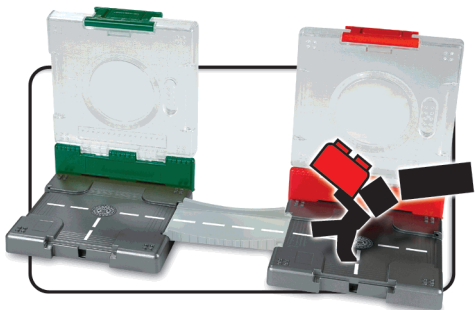

**Collect 'n Connect
Road System**

**Sistema vial colector
/conectar**

**Système de chemins à
collectionner et à relier**

**Verzamel-en-Verbind
wegennet**

**Detailed Environments
Paisajes detallados
Environnements détaillés
Gedetailleerde milieus**



Nanocase Display / Presentación Nanocase Présentoir Nanocase / Nanocase Uitstalling

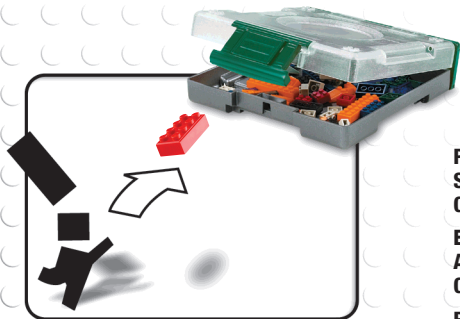

**Pack.
Store.
Collect.**

**Empaca.
Almacena.
Colecciona.**

**Ranger.
Collectionner.**

**Verpak.
Bewaar.
Verzamel.**



Sand Storm™

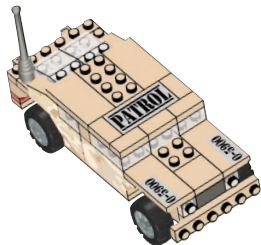

Color chart • Cuadro cromático Charte de couleurs • Färgtabell

Active step
Etapa activa
Étape active
Aktivt skede
Previous step
Étape précédente
Föregående skedet

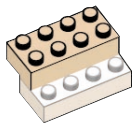

Active step
Etapa activa
Étape active
Aktivt skede
Previous step
Étape précédente
Föregående skedet

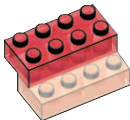

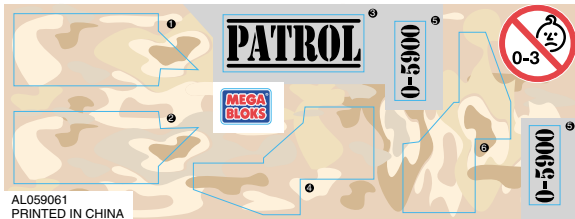



















AL059061
PRINTED IN CHINA

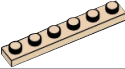

Apply stickers
Aplicar autoadhesivos
Apposer les autocollants
Stickers aanbrengen

1x
AL059061

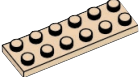
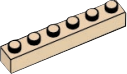
Parts List • Lista de piezas Liste de pièces • Onderdelenlijst

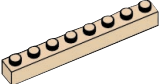
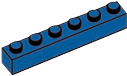
	2x AM25002X		1x AM25005DR		2x AM25010DR
	2x AM25002W		4x AM25016DR		2x AM25030DR
	5x AM25033DR		5x AM25035DR		2x AM25028W
	1x AM25033JG		4x AM25006DR		5x AM25007W
	6x AM25029DR		3x AM25006B		3x AM25011DR
	1x AM25034DR		4x AM25017DR		1x AM25012DR
	1x AM25049JG		2x AM25013DR		3x AM25012B

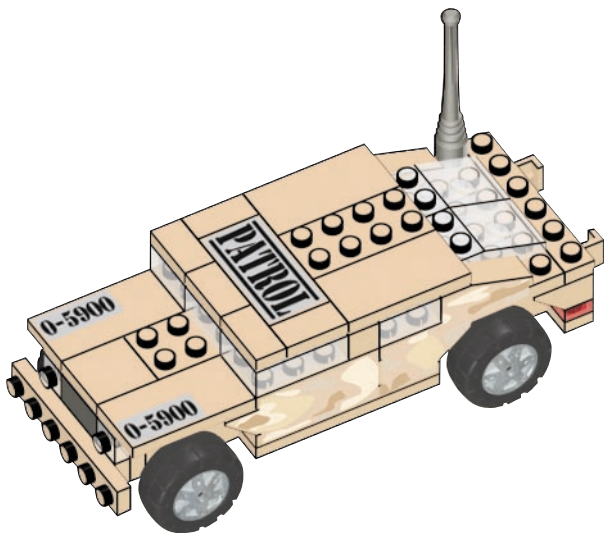

01

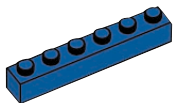

3x

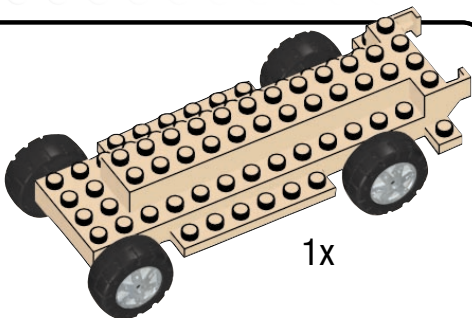

1x

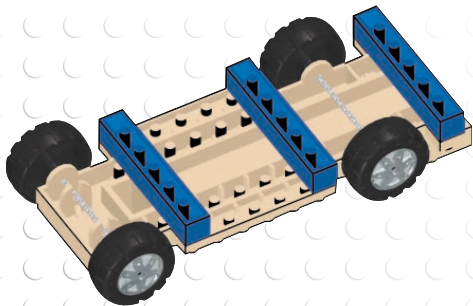

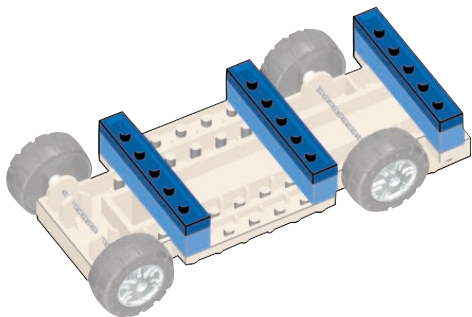

02

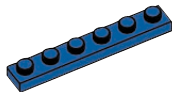

3x

03

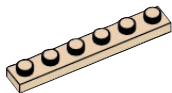

2x



1x



2x

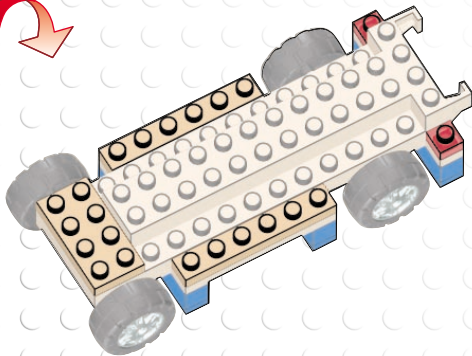

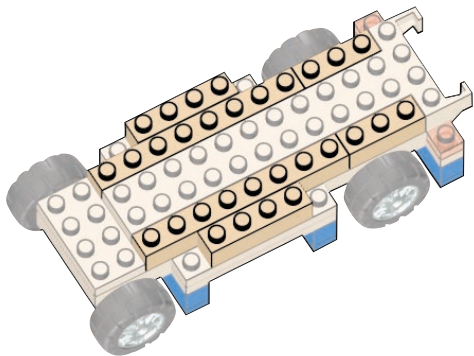

04

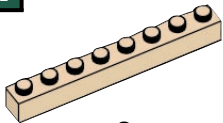

2x

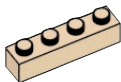

2x



2x

05



2x



6x

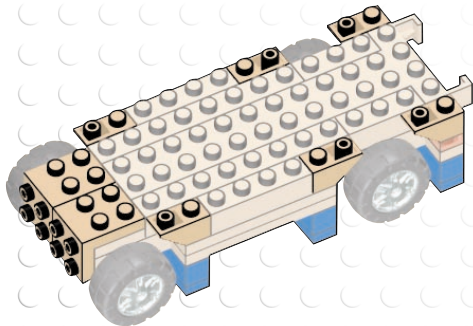

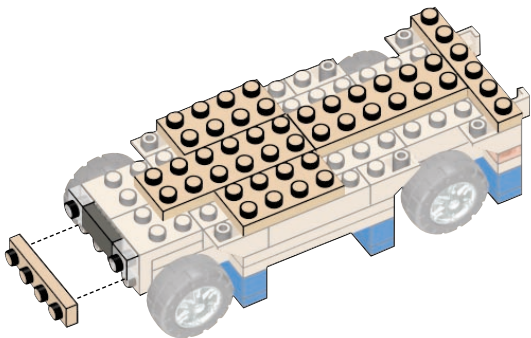

06

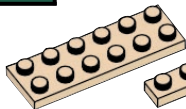

2x

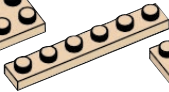

1x

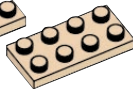

2x

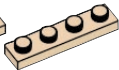

1x



1x



2x

07

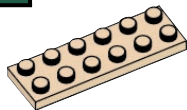

2x



2x



1x

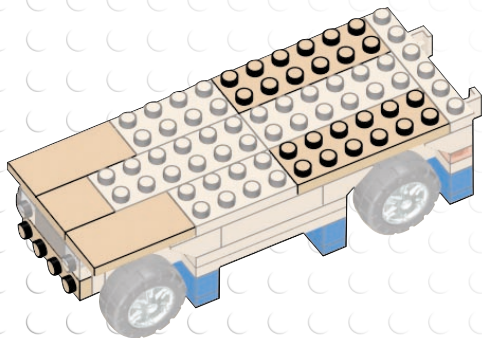

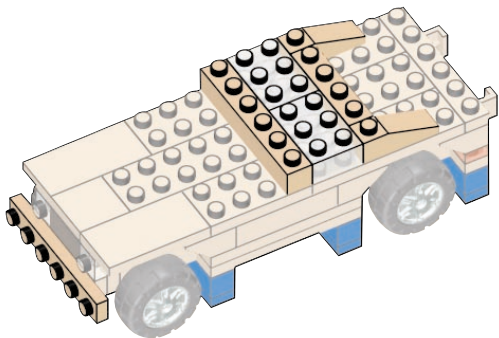

08

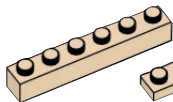

1x

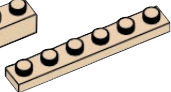

1x



2x

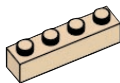

1x



2x

09



3x



2x

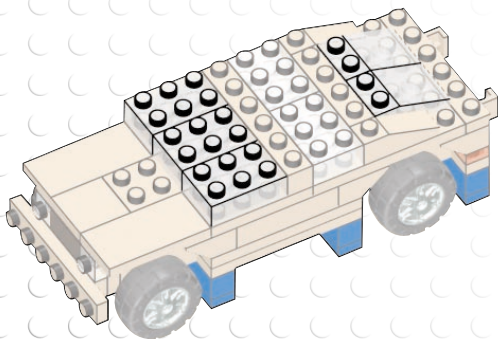

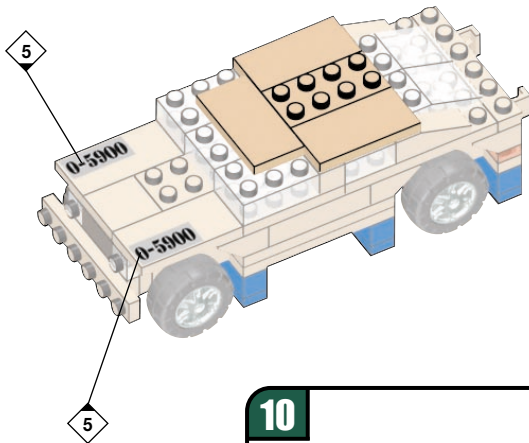

10

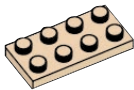

1x



3x

11



5x

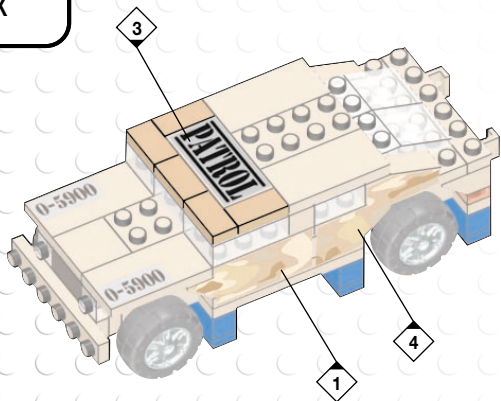

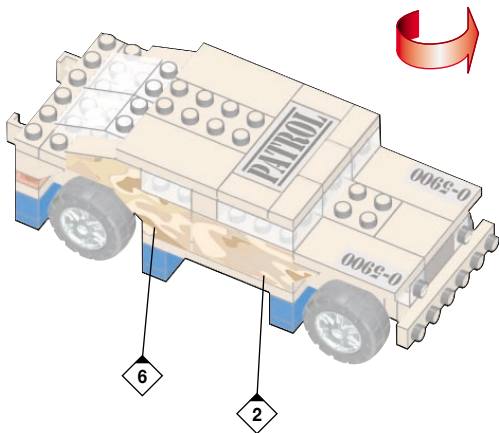

12

13

**Remove temporary pieces.
Retirar las piezas provisionales.
Enlever les pièces temporaires.
Verwijder tijdelijkedelen.**

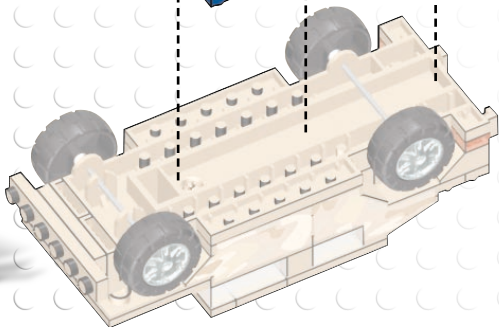
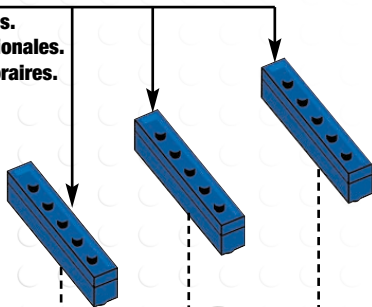

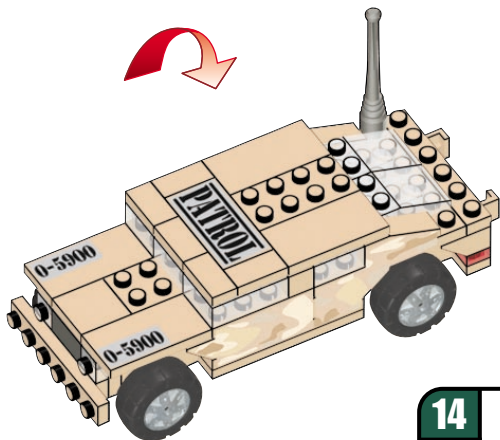

14



1x

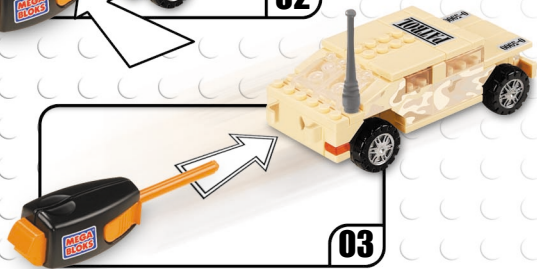
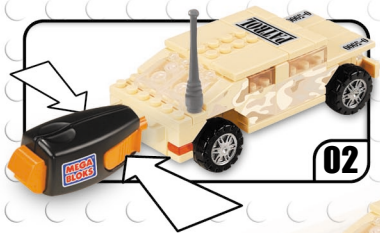
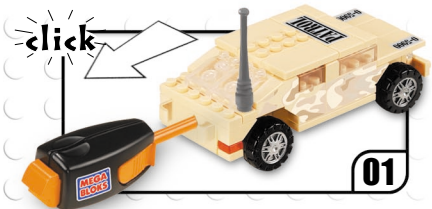

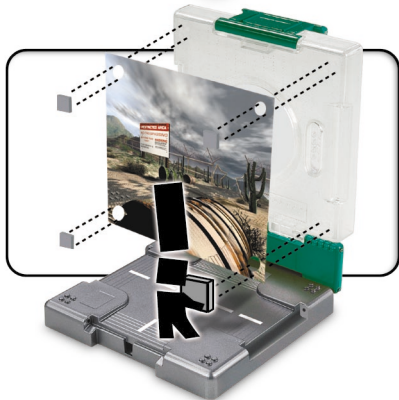
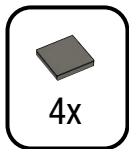
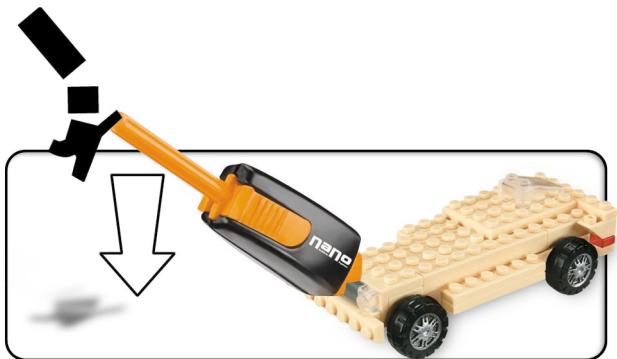

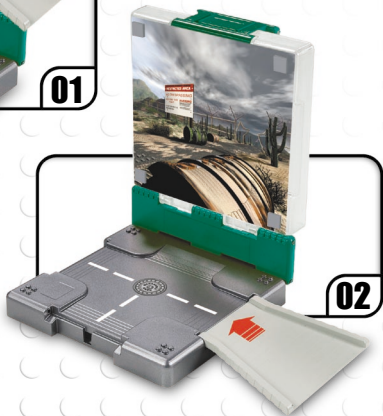

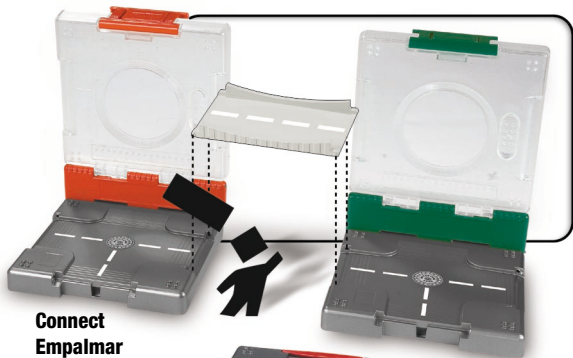

Connect
Empalmar
Relier
Verbinden

Additional purchases required to collect all elements shown.

Para coleccionar todos los elementos mostrados se precisa realizar unas compras adicionales.

Des achats additionnels sont nécessaires afin d'obtenir tous les articles de la collection illustrés.

Verdere aankopen zijn nodig om alle afgebeelde artikelen te verzamelen.

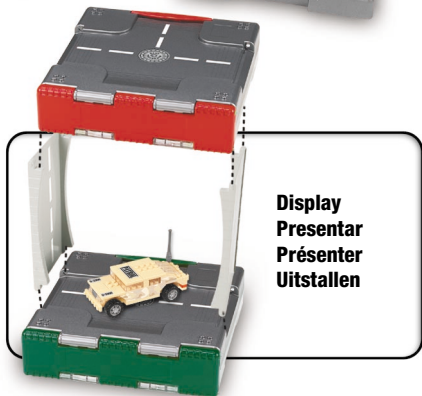

Display
Presentar
Préserver
Uitstellen

Nanoverse

Canyon Cruiser™



5901

Turbo Rally Racer™



5902

Police Interceptor™



5903

Rebel Roadster™



5904

Sand Storm™



Off Road Runner™



5905

Nano Basic

Nanoverse

Military Chopper



5951

Rescue Cutter™



5952

Construction Hauler



5954

Nano Deluxe

Nanoverse

5981



Emergency Response™

5983



Off Shore Racing™

Nano Tropolis™

Nanoverse

5990

Power up launcher
Arranca la lanzadora
Activer le lanceur
Breng de lanceerinrichting op kracht

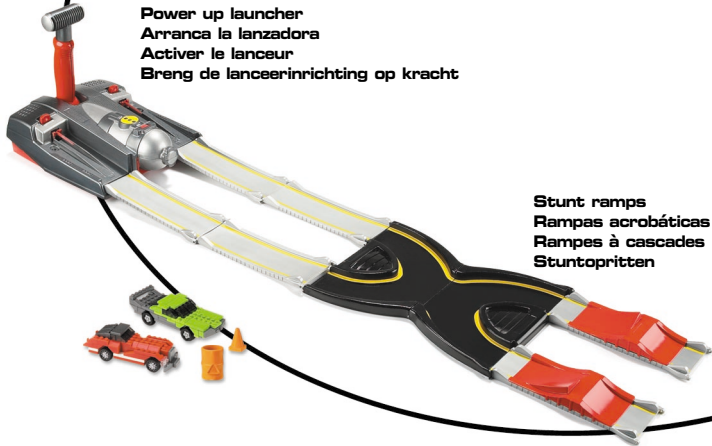

Stunt ramps
Rampas acrobáticas
Rampes à cascades
Stuntopritten

Smokin' Stunt Speedway™

Also Available
También disponible
Également disponible
Eveneens beschikbaar



PROBUILDER®



TM & © BVS.

Also Available
También disponible
Également disponible
Eveneens beschikbaar



©2003 Mirage Studios, Inc. Teenage Mutant Ninja Turtles™ is a trademark of Mirage Studios, Inc. All rights reserved.
©2003 Mirage Studios, Inc. Teenage Mutant Ninja Turtles™ es marca registrada de Mirage Studios, Inc. Todos los derechos reservados.
©2003 Mirage Studios, Inc. Teenage Mutant Ninja Turtles™ est une marque de commerce de Mirage Studios, Inc. Tous droits réservés.
©2003 Mirage Studios, Inc. Teenage Mutant Ninja Turtles™ is een handelsmerk van Mirage Studios, Inc. Alle rechten voorbehouden.

EN ⚠ **WARNING :**
CHOKING HAZARD. - Small parts.
Not for children under 3 years.

ES ⚠ **ADVERTENCIA :**
PELIGRO DE ASFIXIA. - Contiene piezas pequeñas.
No recomendado para niños menores de 3 años.

FR ⚠ **AVERTISSEMENT :**
RISQUE DE SUFFOCATION. - Présence de petits éléments.
Ne convient pas aux enfants de moins de 3 ans.

NL ⚠ **WAARSCHUWING:**
VERSTIKKINGSGEVAAR. - Bevat kleine onderdelen.
Niet geschikt voor kinderen onder de 3 jaar.

DE ⚠ **WARNUNG:**
ERSTICKUNGSGEFAHR. - Enthält kleine Teile.
Nicht für Kinder unter 3 Jahren geeignet.

DA ⚠ **ADVARSEL:**
KVÆLNINGSFARE. - Indeholder smådele.
Ikke til børn under 3 år.

EL ⚠ **ΠΡΟΕΙΔΟΠΟΙΗΣΗ:**
ΚΙΝΔΥΝΟΣ ΠΝΕΙΜΑΤΟΣ. - Περιέχει μικρά αντικείμενα.
Όχι για παιδιά κάτω των 3 ετών.

FI ⚠ **VAROITUS:**
TUKEHTUMISVAARA. - Sisältää pieniä osia.
Ei alle 3-vuotiaille lapsille.

IT ⚠ **ATTENZIONE:**
PERICOLO DI SOFFOCAMENTO. - Contiene piccole parti.
Non indicato per bambini sotto i 3 anni.

NO ⚠ **ADVARSEL:**
KVELNINGSFARE. - Inneholder små deler.
Kun for barn over 3 år.

PT ⚠ **ATENÇÃO:**
PERIGO DE ASFIXIA. - Contém peças pequenas.
Não é concebido para crianças de menos de 3 anos.

SV ⚠ **VARNING!**
KVÄVNINGSRISK. - Innehåller små delar.
Inte för barn under 3 år.

JA ⚠ **警告 :**
窒息の危険性 小さな部品が含まれています
3歳以下の子供には与えないで下さい。

ZH ⚠ **警告:**
有窒息危險。包含有小部件
不适合3岁以下的小孩玩。



**LIFETIME GUARANTEE
GARANTIZADO DE POR VIDA
GARANTIE A VIE
LEVENSLANGE GARANTIE**

**COMMENTS, QUESTIONS ? / ¿ COMENTARIOS, PREGUNTAS ?
COMMENTAIRES, QUESTIONS ? / COMMENTAAR, VRAGEN ?**

1.800.465.MEGA

**U.S. & Canada only / Solamente en EEUU y Canadá
E.U. et Canada seulement / Uitsluitend in de V.S. en Canada**

www.megabloks.com

- EN CAUTION!** Do not aim at eyes or face.
- ES ¡ADVERTENCIA!** NO dirigir nunca los proyectiles hacia los ojos o la cara.
- FR ATTENTION!** Ne pas viser les yeux ou le visage.
- NL LET OP:** Niet op ogen of gezicht richten.
- DE VORSICHT!** Nicht auf das Gesicht oder die Augen richten.
- DA ADVARSEL!** Peg ikke i retning af øjne eller ansigt.
- EL ΠΡΟΣΟΧΗ!** Να μην σκοπεύετε προς τα μάτια ή το πρόσωπο.
- FI VARO!** Älä tähtää silmiin tai kasvoihin.
- IT Attenzione!** Non puntare verso gli occhi o il viso.
- NO FORSIKTIG!** Sikt ikke mot øyne eller ansikt.
- PT ATENÇÃO:** Não apontar para os olhos ou o rosto.
- SV VAR FÖRSIKTIG!** Rikta inte med ögon eller ansikte.
- JA 注意!** 目や顔に使用しないで下さい。
- ZH 警告!** 不要对准眼睛或脸。

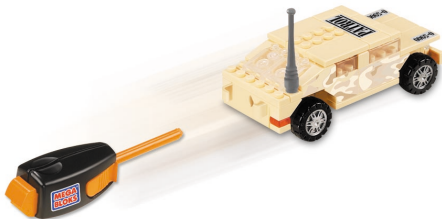

5906 Sand Storm™



© 2004, MEGA BLOKS INC.
© and ™ denote trademarks of MEGA BLOKS INC.
© y ™ designan la marca registrada y la marca comercial de MEGA BLOKS INC.
© et ™ désignent des marques de commerce de MEGA BLOKS INC.
© en ™ duiden op handelsmerken van MEGA BLOKS INC.

PRINTED IN CHINA AD059062