

**MEGA
BLOKS**

SABAN'S **POWER RANGERS MEGAFORCE**

**NEW!
¡NUEVO!
NOUVEAU!**

**SUPER-POSABLE FIGURE!
FIGURA CON MÚLTIPLES POSAS!
FIGURINE SUPER ARTICULÉE!
KOMPLETT BEWEGLICHE FIGUR!
FIGUR DE L'UN SUPERVEIL,
STANDEN KLANT ZETZEN
FIGURINA SUPER SPOCATA
FIGURA COM MOLTIPLAS POSAS**



5829 Red Ranger vs Vrak • Ranger Rojo vs. Vrak • Ranger rouge contre Vrak
Roter Ranger gegen Vrak • Rode Rangervs Vrak • Ranger Rossocontro Vrak • Ranger Vermelhocontra Vrak

2X MA03019APG
 4X AM18232F
 1X AM17010F
 2X AM09113F
 1X MA09013BYE
 3X MA09013F
 2X MA17502F
 2X AM73454ARG
 2X AM73454X
 1X AM17129APG
 2X AM18543APG
 2X MA03773BYE
 5X MA03773F
 1X AM09267F
 1X AM09268F
 2X AM17062F
 2X MA03328F
 2X MA1086F
 2X AM08841NS
 10X MA09393F
 6X MA09198APG
 2X AM022501ARG
 2X MA07590NS
 1X AM17131F
 1X AM17129APG
 1X AM17129NS
 1X AM17129ARG
 1X AM17130APG
 1X AM17130NS
 1X AM17130ARG

1X MA09023BYE
 1X AM18527F
 1X MA1154F
 2X MA18328APG
 2X MA18329APG
 4X MA1314APG
 2X MA1314NS
 2X MA1314F
 1X MA1139F
 3X MA03772F
 1X AM18736NS
 2X MA09593NS
 2X MA09838NS

2X AM17066NS
 2X AM08416F
 2X MA17503F
 1X MA09033NS
 4X MA09033F
 1X AM18548NS
 7X MA09493F
 1X AM73446F
 1X AS0582902
 1X AM72430F

1X AM16630NS
 1X AM16629NS
 2X AS0582901
 4X MA09292F
 1X MA1480NS
 3X MA1480F
 1X AM18292F
 1X MA08483F
 1X AM09190NS

1X AM16910F
 2X AM04219NS
 2X AM04219ARG
 1X AM17077NS
 1X AM17076NS
 1X AM18294F
 1X AM18295F
 1X AM73230F

1X AS0581010
 2X AM04399F
 1X AS0584028
 1X AS0585027
 1X AS0582037
 1X AS0583035
 1X AM73382F
 1X AM73629ARG

1X AS0581001
 1X AM73258ARG
 1X AS0584001
 1X AS0585017
 1X AS0582038
 1X AS0583036



- EN** Please read these instructions carefully before first use and keep them for future reference.
FR Il est recommandé de lire attentivement ce feuillet avant la première utilisation et de le conserver pour référence future.
ES Leer estas instrucciones cuidadosamente antes de la primera utilización y guardarlas para referencia futura.
DE Die Gebrauchsanleitung bitte durchlesen und aufbewahren.
NL Wij raden u aan deze handleiding zorgvuldig te lezen en te bewaren voor eventuele raadpleging op een later tijdstip.
IT Leggere le istruzioni prima di cominciare ad usare il gioco e conservarle per referenze future.
PT Leia as instruções antes do primeiro uso e guarde-as para futura referência.
PL Proszę uważnie przeczytać instrukcję obsługi przed pierwszym użyciem, a następnie zachować ją na przyszłość.
DA Vær venlig at læse disse instruktioner omhyggeligt inden ibrugtagen og opbevar dem til fremtidigt brug.
EL Διαβάστε αυτές τις οδηγίες προσεκτικά πριν χρησιμοποιήσετε το προϊόν για πρώτη φορά και φυλάξτε τις για μελλοντική αναφορά.
FI Lue nämä ohjeet huolellisesti ennen ensimmäistä käyttöä ja säilytä ne myöhempää tarvetta varten.
NO Les disse instruksjonene nøye før første gangs bruk, og ta vare på dem for fremtidige oppslag.
SV Läs noggrant igenom dessa instruktioner innan du använder produkten för första gången och spara dem för ev. framtida frågor.
JA 初めてご使用になる前に、この説明書をよくお読みください。また、本書は将来いつでも参照できるように保管してください。
ZH 请在初次使用前仔细阅读这些指示，并保留它们以便未来参考。
AR يرجى قراءة هذه التعليمات بدقة قبل البدء بالاستعمال والاحتفاظ بها كمرجع للمستقبل

- EN** ⚠ **WARNING :**
CHOKING HAZARD. - Small parts.
 Not for children under 3 years.
- FR** ⚠ **ATTENTION :**
DANGER D'ÉTOUFFEMENT. - Présence de petits éléments.
 Ne convient pas aux enfants de moins de 3 ans.
- ES** ⚠ **ADVERTENCIA :**
RIESGO DE ASFIXIA. - Contiene piezas pequeñas.
 No recomendado para niños menores de 3 años.
- DE** ⚠ **ACHTUNG :**
ERSTICKUNGSGEFAHR. - Enthält kleine Teile.
 Nicht für Kinder unter 3 Jahren geeignet.
- NL** ⚠ **WAARSCHUWING :**
VERSTIKKINGSGEVAAR. - Bevat kleine onderdelen.
 Niet geschikt voor kinderen onder de 3 jaar.
- IT** ⚠ **AVVERTENZA :**
PERICOLO DI SOFFOCAMENTO. - Contiene piccole parti.
 Non indicato per bambini sotto i 3 anni.
- PT** ⚠ **ATENÇÃO :**
PERIGO DE ASFIXIA. - Contém peças pequenas.
 Não é concebido para crianças de menos de 3 anos.
- PL** ⚠ **OSTRZEŻENIE :**
ZAGROŻENIE ZADŁAWIENIEM. - Małe elementy.
 Nie nadaje się dla dzieci poniżej 3 lat.
- DA** ⚠ **ADVARSEL :**
FARE FOR KVÆLNING. - Indeholder smådele.
 Ikke til børn under 3 år.
- EL** ⚠ **ΠΡΟΕΙΔΟΠΟΙΗΣΗ :**
ΚΙΝΔΥΝΟΣ ΠΝΙΓΜΟΥ. - Περιέχει μικρά αντικείμενα.
 Όχι για παιδιά κάτω των 3 ετών.
- FI** ⚠ **VAROITUS :**
TUKEHTUMISVAARA. - Sisältää pieniä osia.
 Ei alle 3-vuotiaille lapsille.
- NO** ⚠ **ADVARSEL :**
KVELNINGSFARE. - Inneholder små deler.
 Kun for barn over 3 år.
- SV** ⚠ **VARNING :**
KVÄVNINGSRISK. - Innehåller små delar.
 Inte för barn under 3 år.
- JA** ⚠ **警告 :**
 のどにつまる危険 小さな部品が含まれています
 3歳以下の子供には与えないで下さい。
- ZH** ⚠ **警告 :**
 噎住危险。包含有小部件
 不适合3岁以下的小孩玩。
- AR** ⚠ **تحذير :**
خطر الاختناق - قطع صغيرة.
 غير صالحة للأطفال أقل من 3 سنوات.

SABAN Brands www.powerrangers.com

TM and © 2013 SCG Power Rangers LLC. Power Rangers and all related logos, characters, names, and distinctive likenesses thereof are the exclusive property of SCG Power Rangers LLC. All Rights Reserved. Used Under Authorization.



WARNING ! **ACHTUNG !** **ATENÇÃO !** **VAROITUS !** **警告 !**
ATTENTION ! **WAARSCHUWING !** **OSTRZEZENIE !** **ADVARSEL !** **警告 !**
ADVERTENCIA ! **AVVERTENZA !** **ADVARSEL !** **VAROITUS !** **警告 !**
ΠΡΟΕΙΔΟΠΟΙΗΣΗ !





1

2x 1x 1x

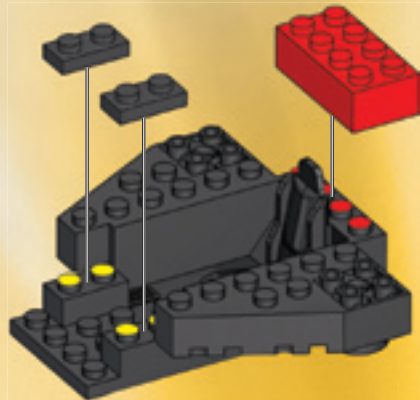

2

2x 1x 2x 2x 2x

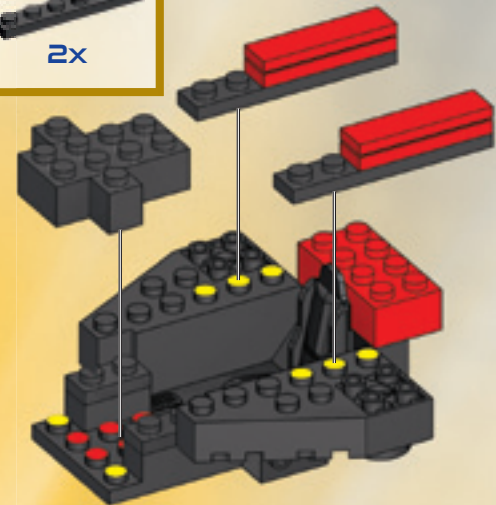
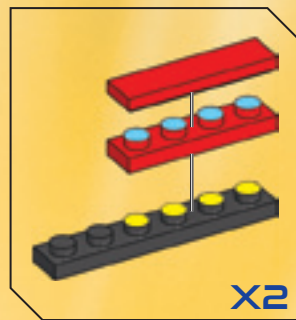

3

1x 1x

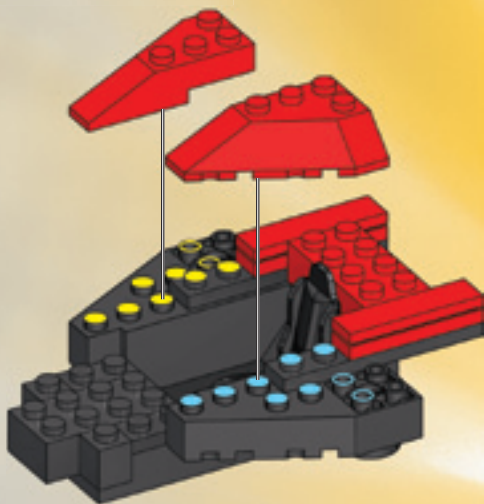

4

2x 1x 2x

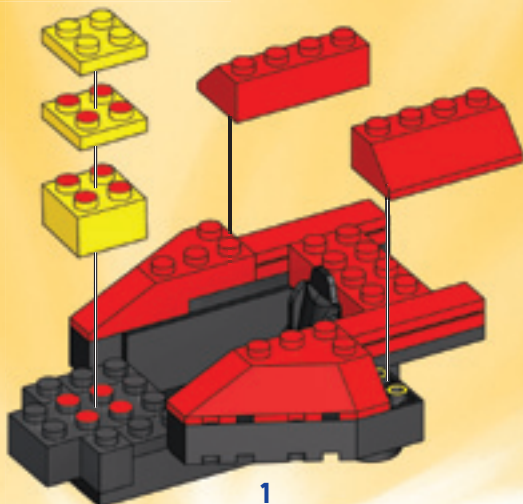

Place temporary pieces.
Colocar las piezas provisionales.
Installer les pièces temporaires.
Provisorische Teile einsetzen.
Instaleer de tijdelijke onderdelen.
Piazzare i pezzi temporanei.
Colocar peças temporárias.

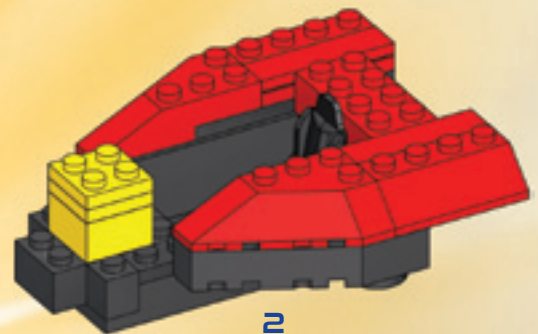

5

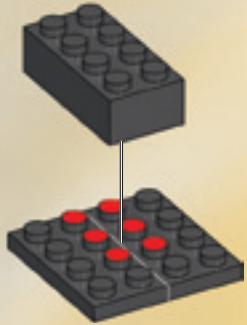

1

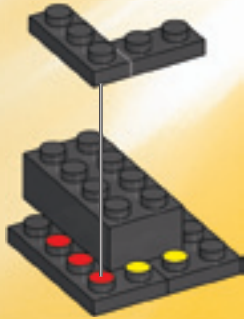

2

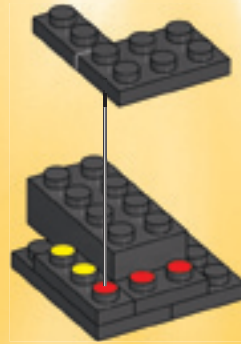

3

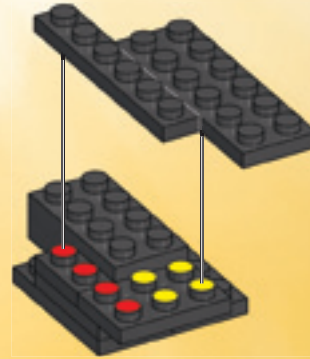

4

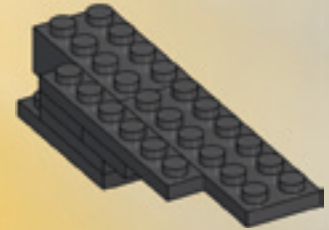

5

6

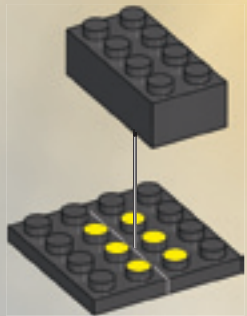

1

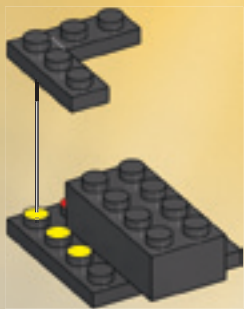

2

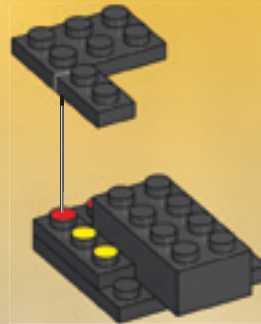

3

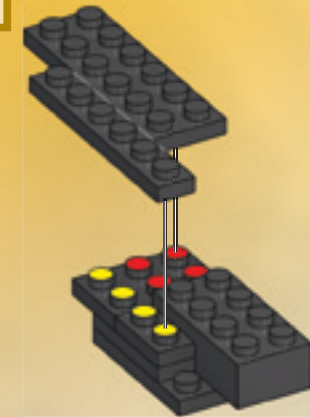

4

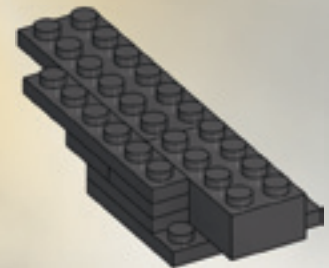

5

7

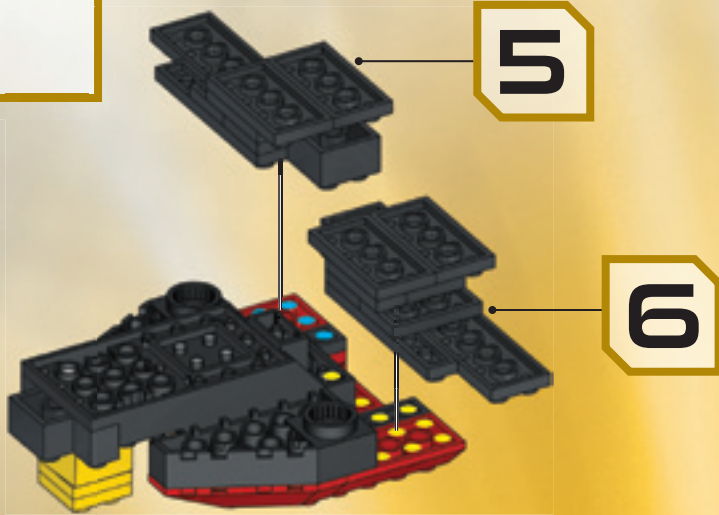

8

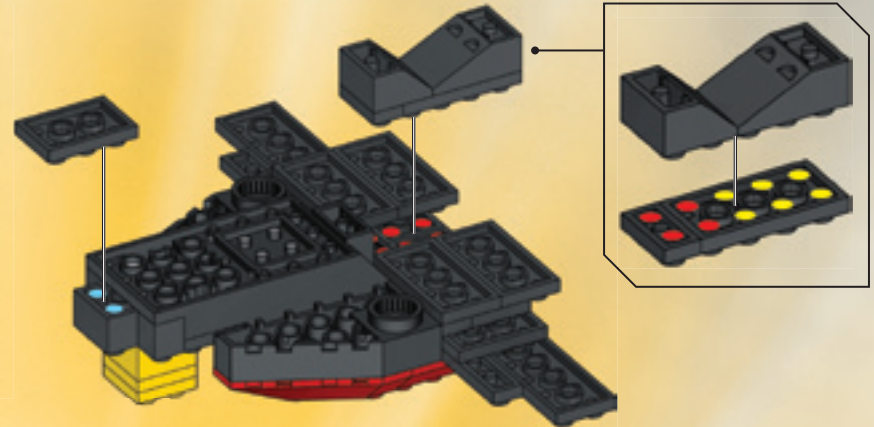

9

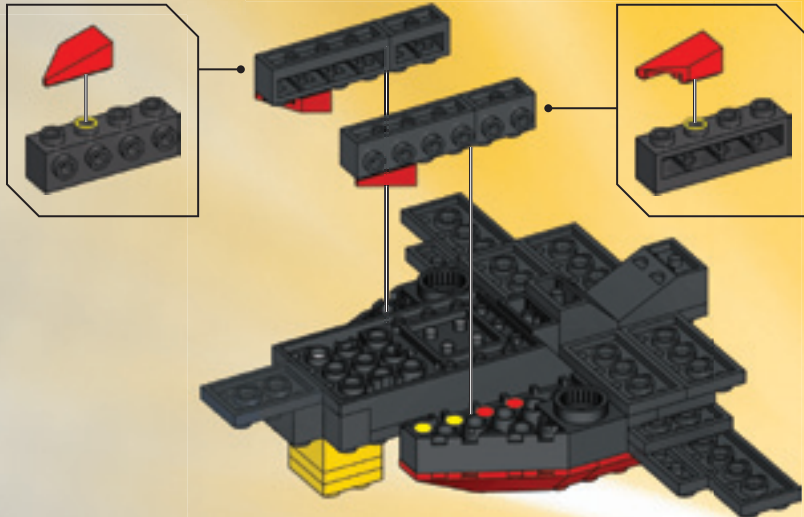

10

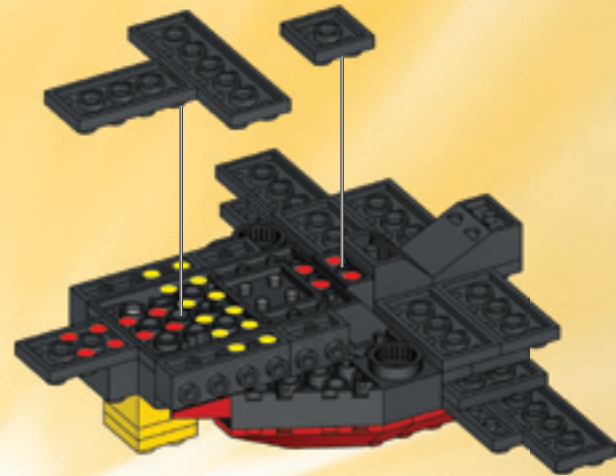

11

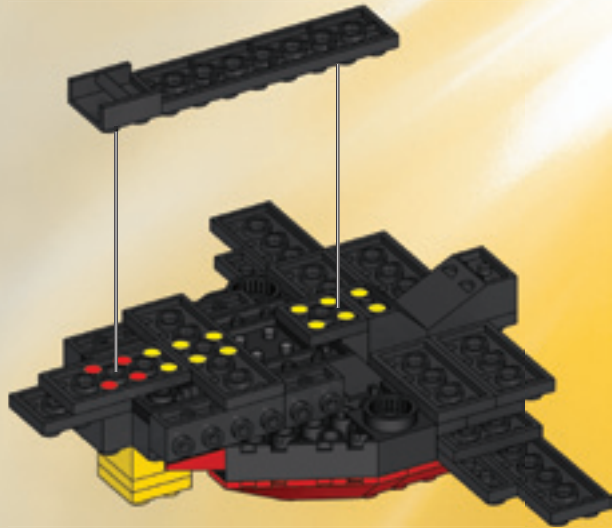

12

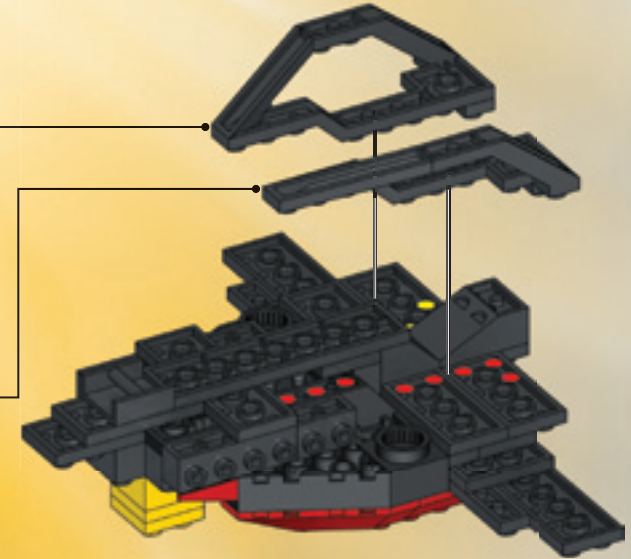
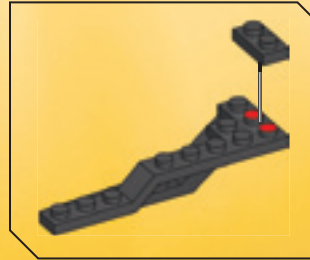
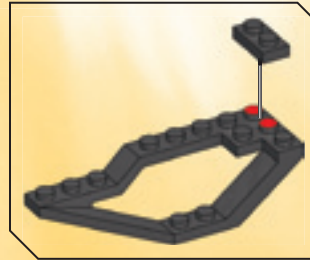

13



1x



2x



1x

Place temporary pieces.
Colocar las piezas provisionales.
Installer les pièces temporaires.
Provisorische Teile einsetzen.
Instaleer de tijdelijke onderdelen.
Piazzare i pezzi temporanei.
Colocar peças temporárias.

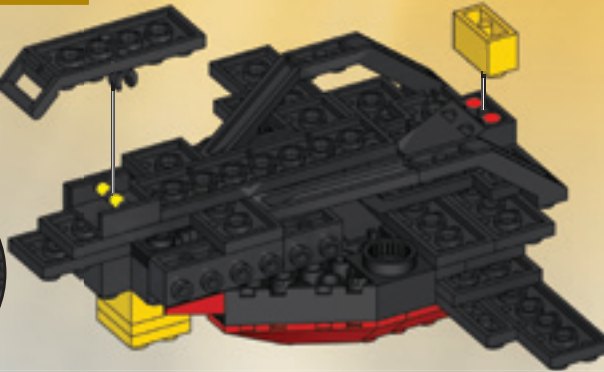
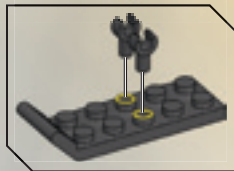

14



2x



1x

Remove temporary pieces.
Retirar las piezas provisionales.
Enlever les pièces temporaires.
Provisorische Teile entfernen.
Verwijder de tijdelijke onderdelen.
Rimuovere i pezzi temporanei.
Retirar peças temporárias.

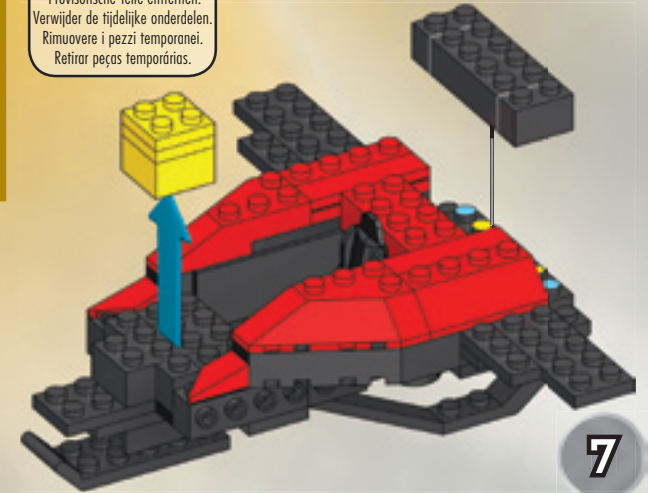

19

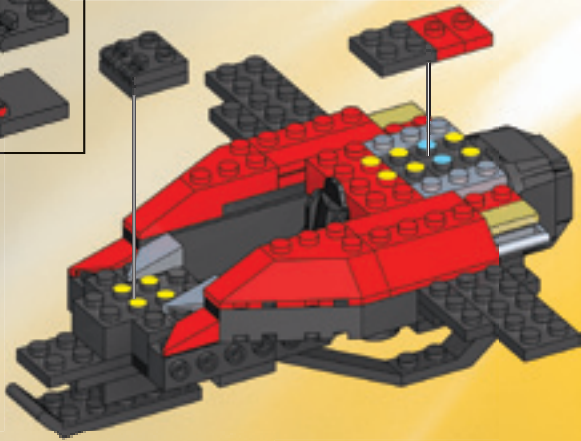

20

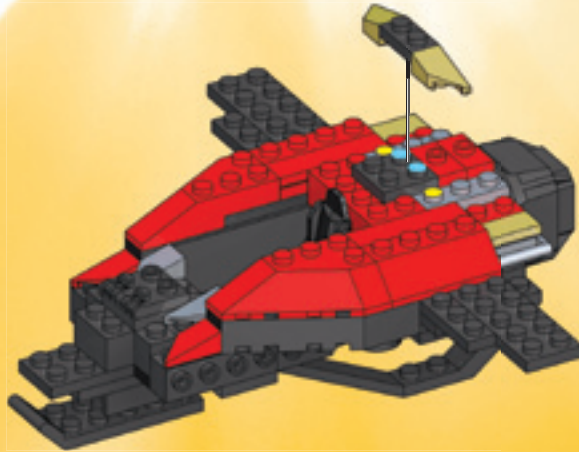

21

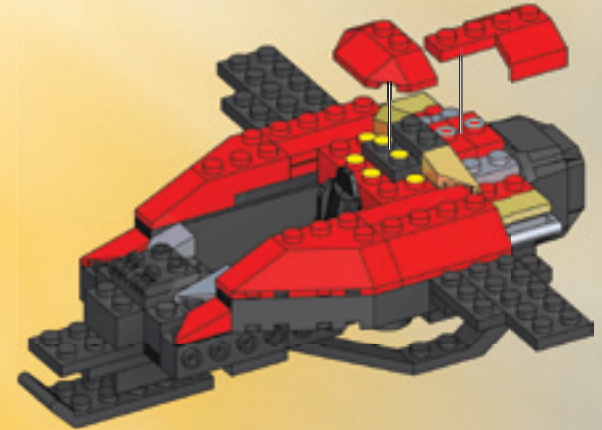

22

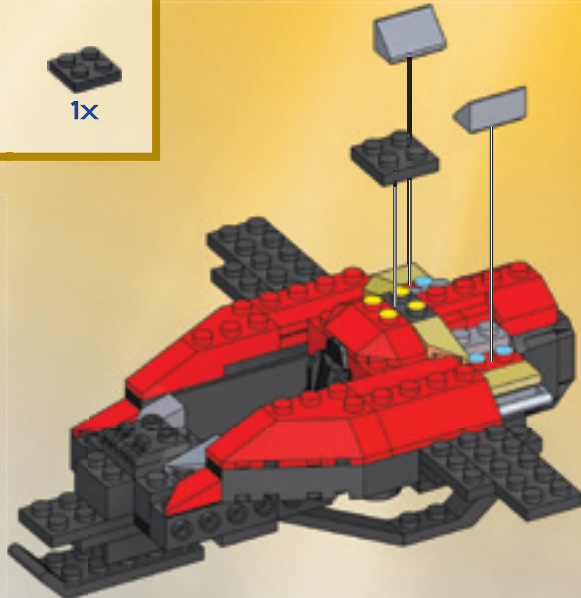

1

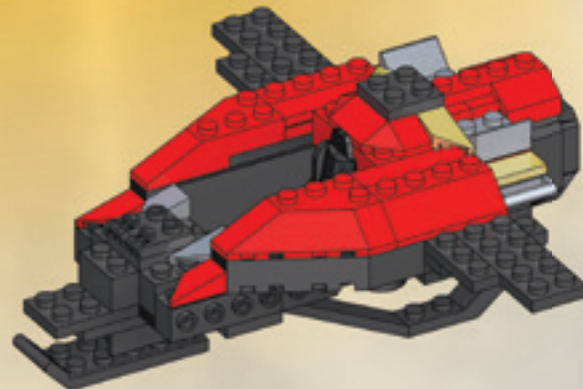

2

23

1x



1x



1x



1x



1x



1



2



3

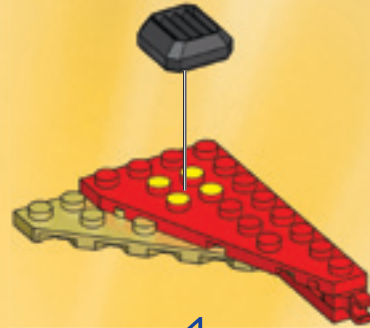

4



5

24

1x



1x



1x



1x



1x

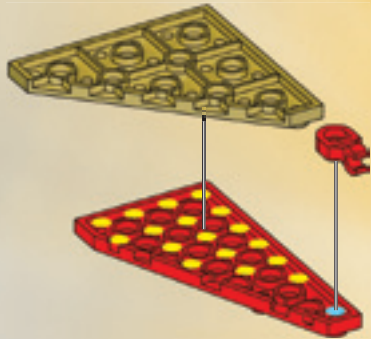

1

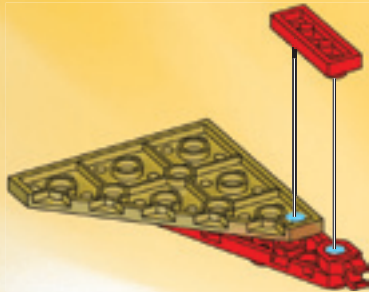

2

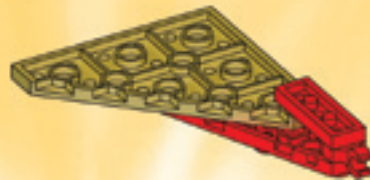

3

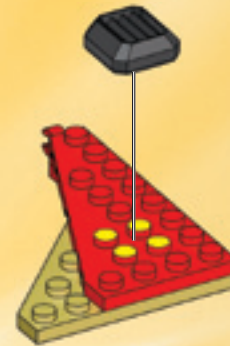

4

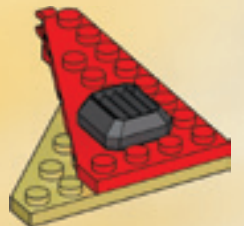

5



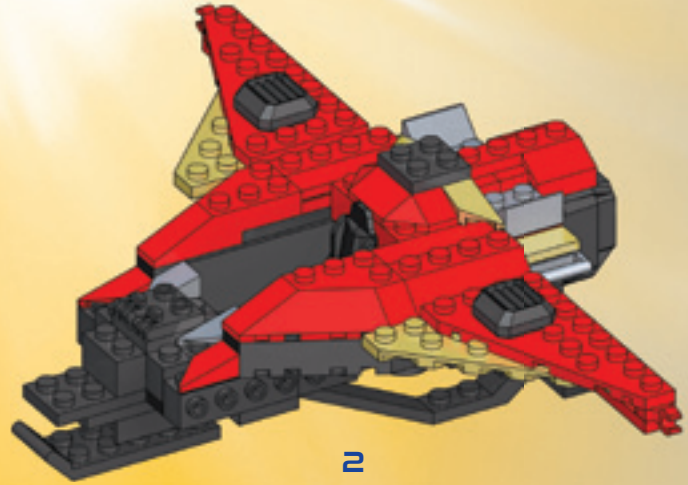
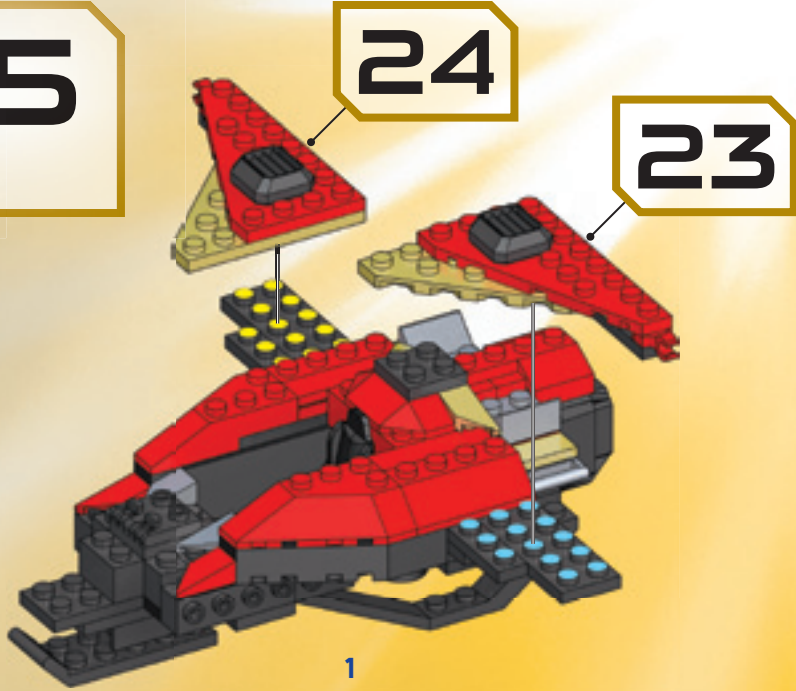

25



26

			
2x	1x	1x	1x

27

			
2x	1x	1x	1x

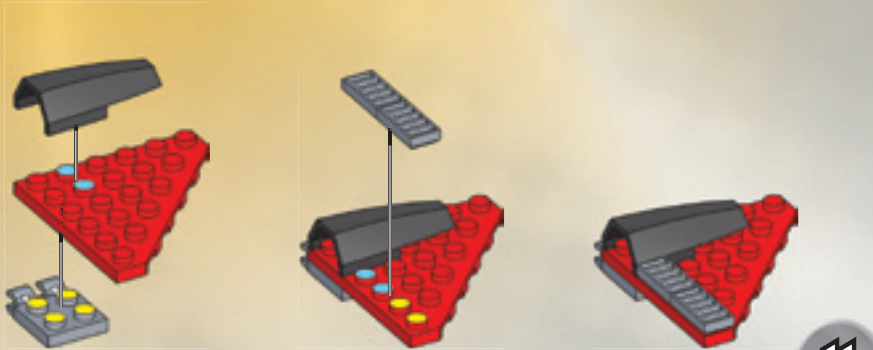

28



26

29



27



30



31

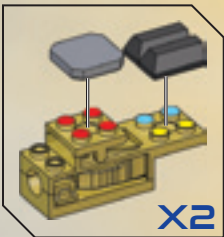
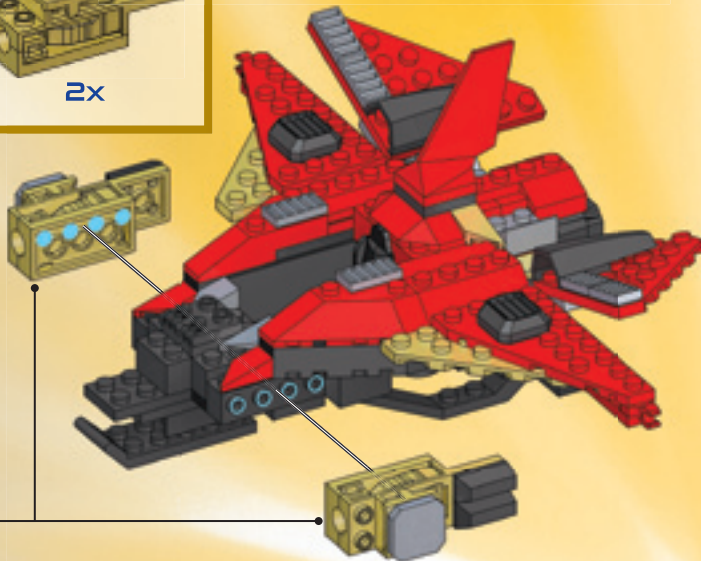

X2

32

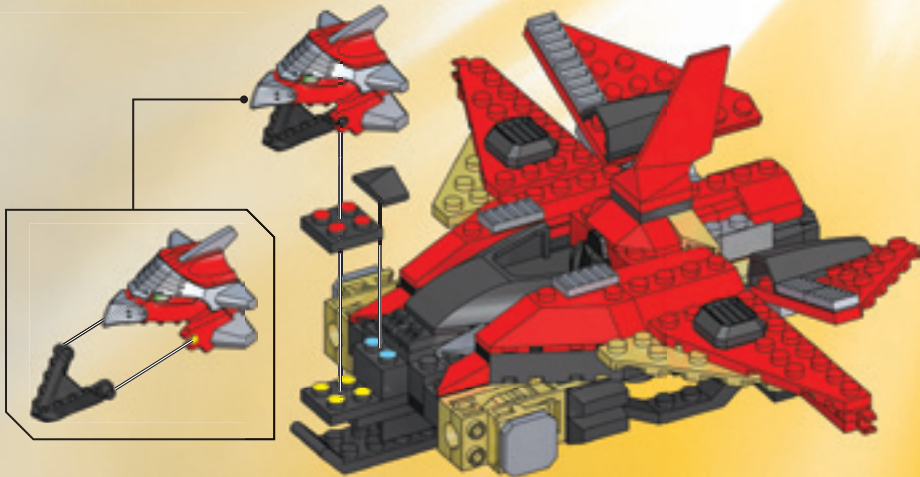

33

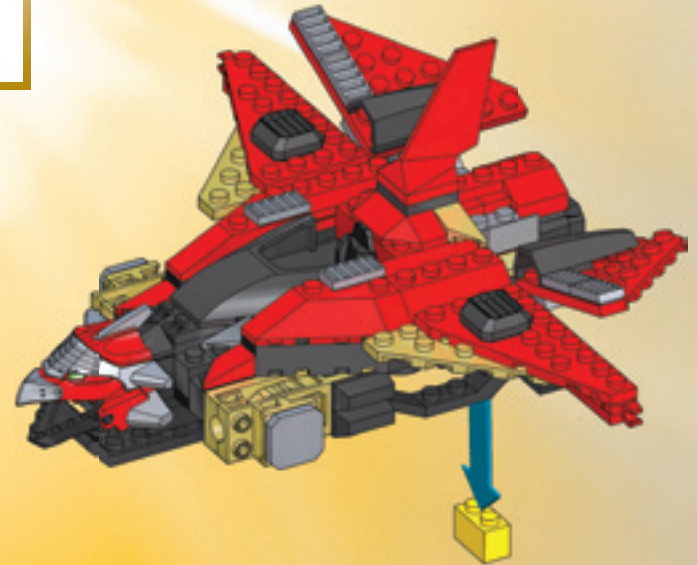

Remove temporary pieces.
Retirar las piezas provisionales.
Enlever les pièces temporaires.
Provisorische Teile entfernen.
Verwijder de tijdelijke onderdelen.
Rimuovere i pezzi temporanei.
Retirar peças temporárias.

34

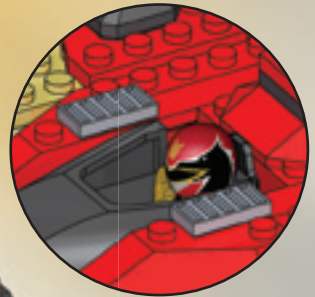
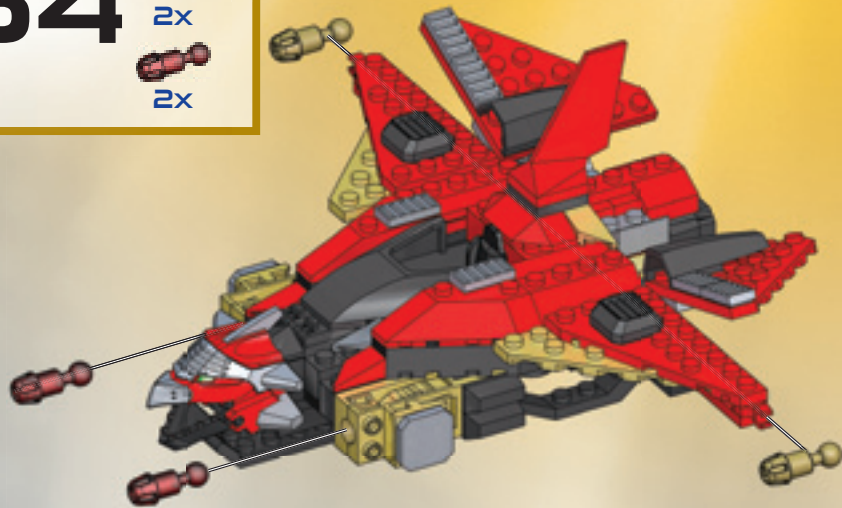
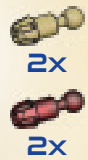



- **EN** WARNING ! Do not aim at eyes or face.
- **FR** ATTENTION ! Ne pas viser les yeux ou le visage.
- **ES** ADVERTENCIA ! No dirigir nunca los proyectiles hacia los ojos o la cara.
- **DE** ACHTUNG ! Nicht auf das Gesicht oder die Augen richten.
- **IT** AVVERTENZA ! Non puntare verso gli occhi o il viso.
- **PT** ATENÇÃO ! Não apontar para os olhos ou o rosto.
- **PL** OSTRZEŻENIE ! Nie celować w oczy lub twarz.
- **NL** WAARSCHUWING ! Niet op ogen of gezicht richten.
- **DA** ADVARSEL ! Peg ikke i retning af øjne eller ansigt.
- **EL** ΠΡΟΣΟΧΗ ! Να μην σκοπεύετε προς τα μάτια ή το πρόσωπο.
- **FI** VAROITUS ! Älä tähtää silmiin tai kasvoihin.
- **NO** ADVARSEL ! Sikkt ikke mot øyne eller ansikt.
- **SV** VARNING ! Rikta inte med ögon eller ansikte.
- **JA** 警告！目や顔に使用しないで下さい。
- **ZH** 警告！不要对准眼睛或脸。
- **AR** تحذير ! لا توجه للقديفة أو الوجه

Use only the projectiles included with this toy.
Utiliser seulement les projectiles fournis avec le jouet.
Utilizar solamente los proyectiles incluidos con el juguete.
Nur die mit dem Spielzeug mitgelieferten Projektile verwenden.
Alleen de met het speelgoed bijgeleverde projectielen gebruiken.
Utilizzare soltanto i proiettili forniti con questo giocattolo.
Usar somente os projecteis incluídos com este brinquedo.
Nie celować w oczy lub twarz. Należy stosować jedynie naboje dołączone do zabawki.
استخدم فقط القديفة المرافقة لهذه اللعبة

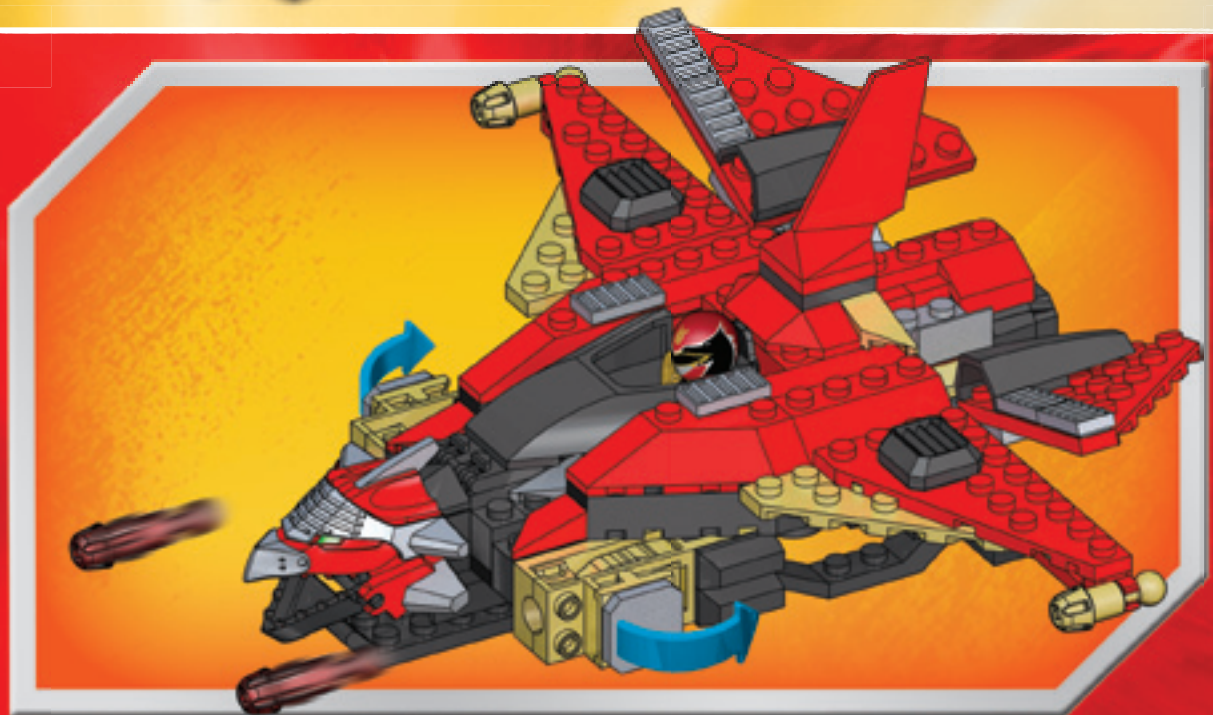

REBUILD CHALLENGE! TRY THIS!
DESAFÍO DE RECONSTRUCCIÓN! ¡PRUEBA ESTO!
DÉFI DE RÉASSEMBLAGE! ESSAYEZ!
UMBAUHERAUSFORDERUNG! PROBIERE ES AUS!
UITDAGEND HERBOUWPROJECT! PROBEER NU!
RICOSTRUISCI LA SFIDA! PROVALO!
DESAFIO DE RECONSTRUÇÃO! EXPERIMENTE ISSO!



BUILDING STEPS ONLINE @
PASOS DE CONSTRUCCIÓN EN INTERNET @
ÉTAPES DE CONSTRUCTION EN LIGNE @
AUFBAUANLEITUNG ONLINE @ / ONLINE INSTRUCTIES @ / PASI DI
COSTRUZIONE ONLINE SU / ETAPAS DE CONSTRUÇÃO ONLINE @
megabloks.com/powerangers

SABAN'S POWER RANGERS MEGAFORCE

powerrangers.megabloks.com



REBUILD CHALLENGE!
IDEAÑO DE RECONSTRUCCIÓN!
DÉFI DE RÉASSEMBLAGE!

UMBAUHERAUSFORDERUNG!
UITDAGEND HERBOUWPROJECT!
RICOSTRUISCI LA SFIDA!
DESAFIO DE RECONSTRUÇÃO!



VRAK



WORKING LAUNCHER!
LANZADOR QUE FUNCIONA!
CANON FONCTIONNEL!

FUNKTIONSFÄHIGE RAKETENWERFER
FUNCTIONEREND LANCERRAKET
LANCIATORE FUNZIONANTE
LANÇADOR QUE FUNCIONA



SUPER MODE
MODD SUPER
MODD SUPER

SUPERMODUS
SUPER MODE
MODALITÀ SUPER
MODD SUPER



SABAN Brands

WWW.POWERRANGERS.COM
™ & © 2013 SGI Power Rangers LLC.
All Rights Reserved. Used Under Authorization.

COLLECT THEM ALL! / ¡COLECCIONALOS TODOS! / COLLECTIONNEZ-LES TOUS!
SAMMLE SIE ALLE / VERZAMEL ZE ALLEMAAL! / COLLEZIONALI TUTTI! / COLECCIONA OS TODOS!



5021

5045

5046

5798

5062

5063

5072

5782



© 2013, MEGA Brands Inc.
© & ™ MEGA Brands Inc.
Printed in Canada D058291