

Probuilder[®]

CARBON SERIES™



3268 Sports Bike

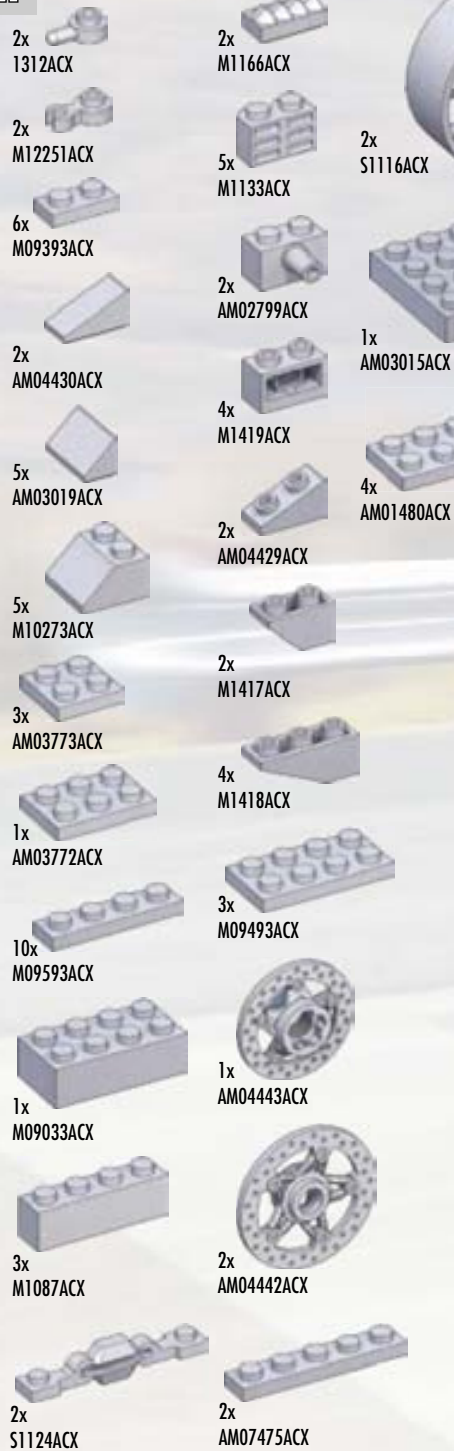
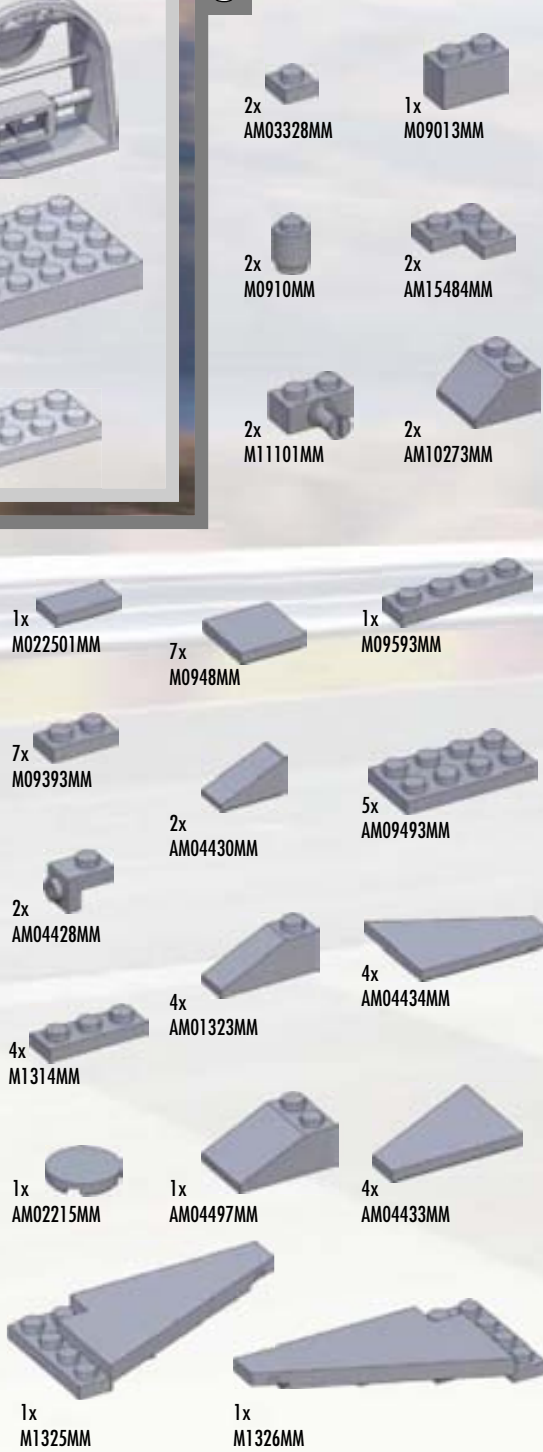

A**B****C**

D

6x
M1113AJG

4x
AS032689

1x
M09393AJG

1x
M10273W

1x
AS0326816



1x
AS032684

1x
M009493AJG

4x
M09023BRD



1x
AS032685



1x
AS032686



1x
AM04439F



1x
AM04441F

2x
AS032683

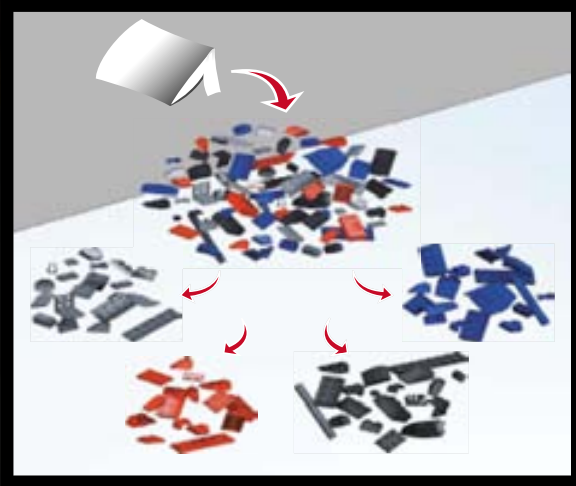

EN Please read these instructions carefully before first use and keep them for future reference. / **ES** Leer estas instrucciones cuidadosamente antes de la primera utilización y guardarlas para referencia futura. / **FR** Il est recommandé de lire attentivement ce feuillet avant la première utilisation et de le conserver pour référence future. / **DE** Die Gebrauchsanleitung bitte durchlesen und aufbewahren. / **NL** Wij raden u aan deze handleiding zorgvuldig te lezen en te bewaren voor eventuele raadpleging op een later tijdstip. / **IT** Leggere le istruzioni prima di cominciare ad usare il gioco e conservarle per referenze future. / **PT** Leia as instruções antes do primeiro uso e guarde-as para futura referência.

EN ⚠ **WARNING :**
CHOKING HAZARD. - Small parts.
Not for children under 3 years.

ES ⚠ **ADVERTENCIA :**
PELIGRO DE ASFIXIA. - Contiene piezas pequeñas.
No recomendado para niños menores de 3 años.

FR ⚠ **AVERTISSEMENT :**
RISQUE DE SUFFOCATION. - Présence de petits éléments.
Ne convient pas aux enfants de moins de 3 ans.

DE ⚠ **WARNING :**
ERSTICKUNGSGEFAHR. - Enthält kleine Teile.
Nicht für Kinder unter 3 Jahren geeignet.

NL ⚠ **WAARSCHUWING :**
VERSTIKKINGSGEVAAR. - Bevat kleine onderdelen.
Niet geschikt voor kinderen onder de 3 jaar.

DA ⚠ **ADVARSEL :**
KVELNINGSFARE. - Indeholder smådele.
Ikke til børn under 3 år.

EL ⚠ **ΠΡΟΕΙΔΟΠΟΙΗΣΗ :**
ΚΙΝΔΥΝΟΣ ΠΝΙΞΙΜΑΤΟΣ. - Περιέχει μικρά αντικείμενα.
Όχι για παιδιά κάτω των 3 ετών.

FI ⚠ **VAROITUS :**
TUKEHTUMISVAARA. - Sisältää pieniä osia.
Ei alle 3-vuotiaille lapsille.

IT ⚠ **ATTENZIONE :**
PERICOLO DI SOFFOCAMENTO. - Contiene piccole parti.
Non indicato per bambini sotto i 3 anni.

NO ⚠ **ADVARSEL :**
KVELNINGSFARE. - Inneholder små deler.
Kun for barn over 3 år.

PT ⚠ **ATENÇÃO :**
PERIGO DE ASFIXIA. - Contém peças pequenas.
Não é concebido para crianças de menos de 3 anos.

SV ⚠ **VARNING :**
KVÄVNINGSRISK. - Innehåller små delar.
Inte för barn under 3 år.

JA ⚠ **警告 :**
窒息の危険性 - 小さな部品が含まれています
3歳以下の子供には与えないで下さい。

ZH ⚠ **警告 :**
有窒息危險。 - 包含有小部件
不适合3岁以下的的小孩玩。

AR ⚠ **تحذير :**
خطر اختناق - قطع صغيرة.
غير صالحة للأطفال أقل من 3 سنوات.



- C** 1x [1x 4-hole dark grey plate]
- 4x [4x 1-hole dark grey wedge]
- 4x [4x 1-hole dark grey wedge]
- 2x [2x 1-hole dark grey wedge]
- 1x [1x 1-hole dark grey wedge]
- 1x [1x 1-hole dark grey wedge]
- 1x [1x 1-hole dark grey wedge]

- D** 4x [4x 1-hole red brick]

1



2



3

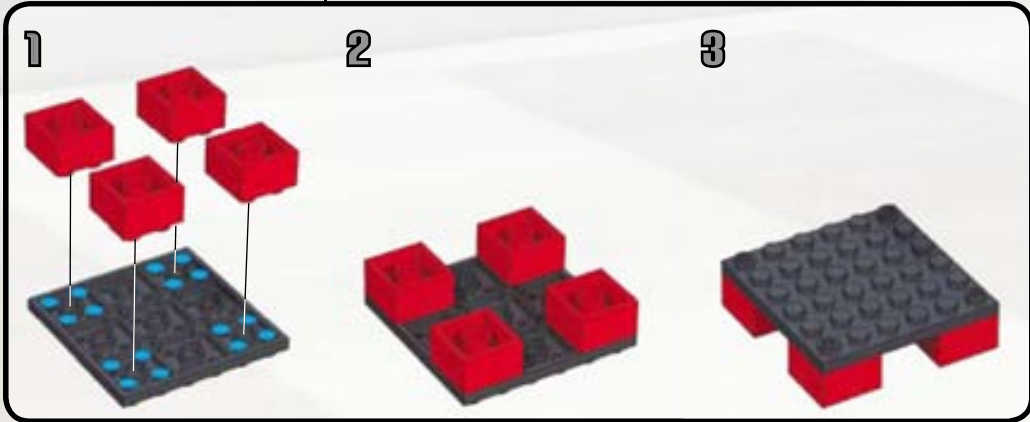
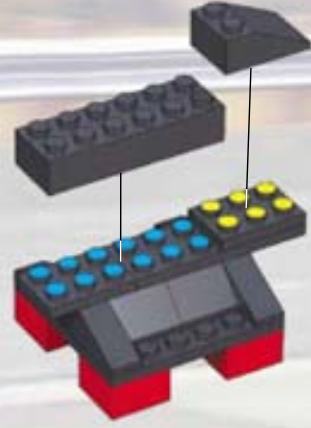



4

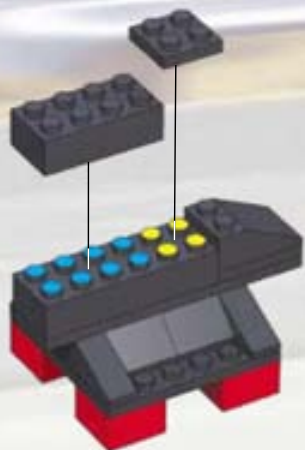

5

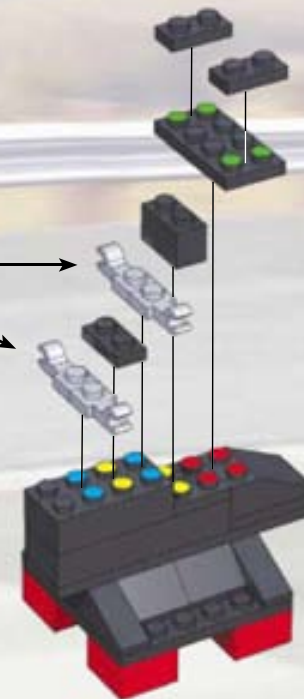
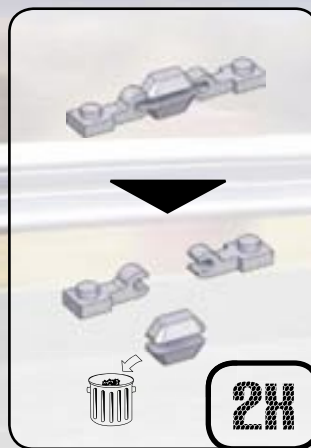

- EN** WARNING: Contains sharp points. Adult assembly required.
- ES** ADVERTENCIA: Contiene puntas muy agudas. Debe ser ensamblado por un adulto.
- FR** MISE EN GARDE: Contient des pièces à bout pointu. L'assemblage doit être fait par un adulte
- DE** ACHTUNG: Enthält scharfe Kanten. Muss von Erwachsenen zusammengebaut werden.
- NL** WAARSCHUWING: Bevat scherpe punten. Vereist montage door volwassenen.
- DA** ADVARSEL: Indeholder skarpe spidser. Montering af en voksen er obligatorisk.
- EL** ΠΡΟΕΙΔΟΠΟΙΗΣΗ : Περιέχει αιχμηρά σημεία. Απαιτείται σύνδεση από ενηλίκους.
- FI** VAROITUS: Sisältää teräviä osia. Kokoamiseen tarvitaan aikuinen.
- IT** ATTENZIONE: Contiene punte affilate. Deve essere montato da un adulto.
- NO** ADVARSEL: Spisse deler. Må settes sammen av voksne.
- PT** ADVERTENCIA: Contém pontas agudas. Requer montagem por adultos.
- SV** VARNING: Innehåller vassa spetsar. Bör monteras av en vuxen.
- JA** 警告：先の尖ったものが含まれています。組立は大人がしてください。
- ZH** 警告：含有尖刺。需由成人組裝。
- AR** تحذير : تحتوي على حواف حادة. يلزم أن يتم التجميع بمعرفة شخص بالغ.

C



1



2

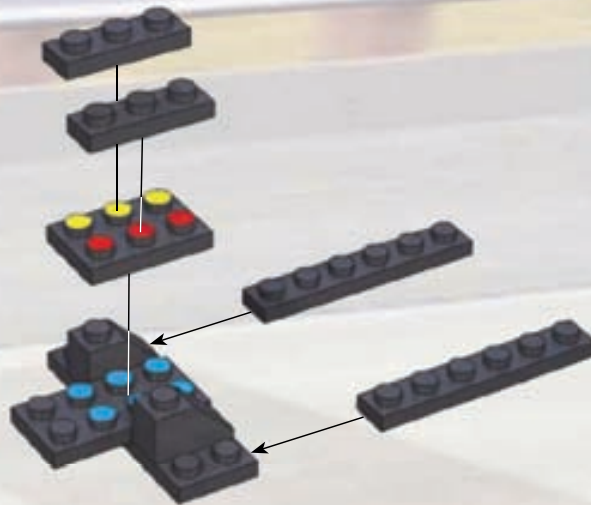

3

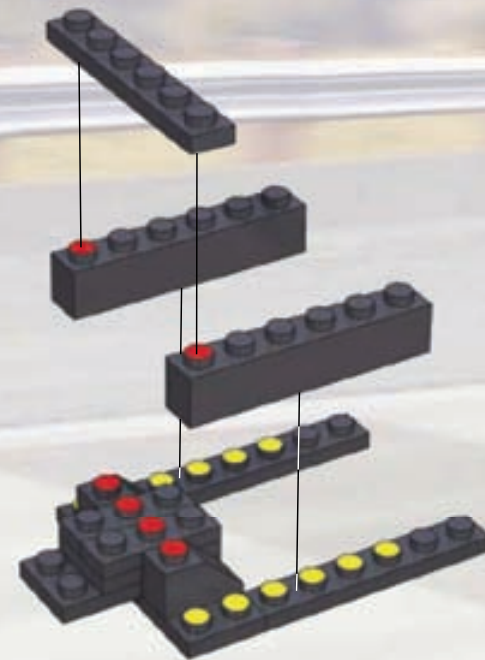



1



2

3





4

5

6



-  2x
- C**  1x
-  2x
-  2x
-  1x
-  2x
-  2x

1

2

3

4

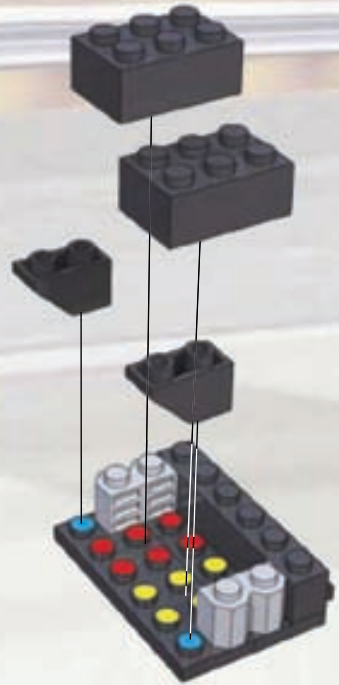
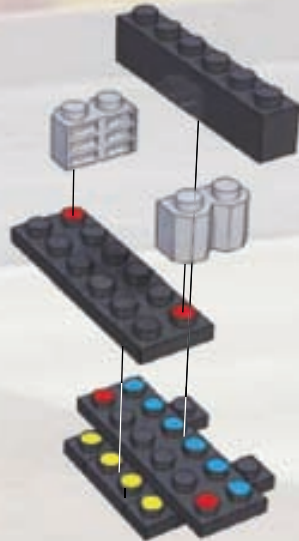
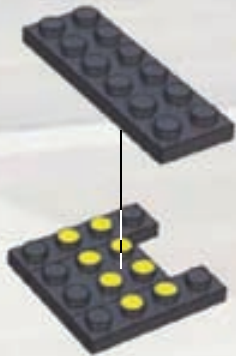
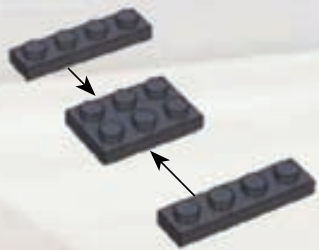

C



5



6



7



3





1

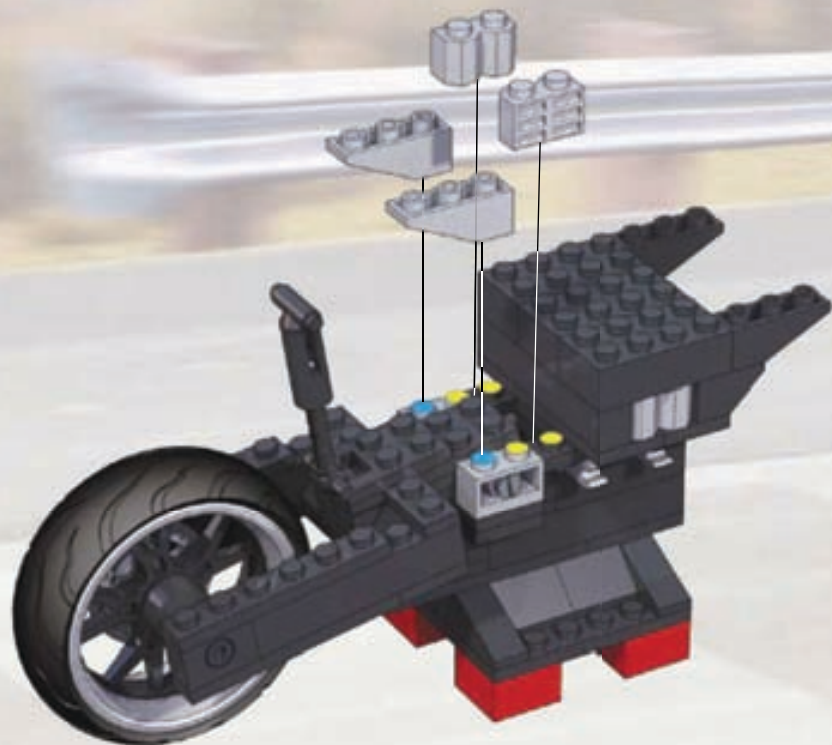

2



3

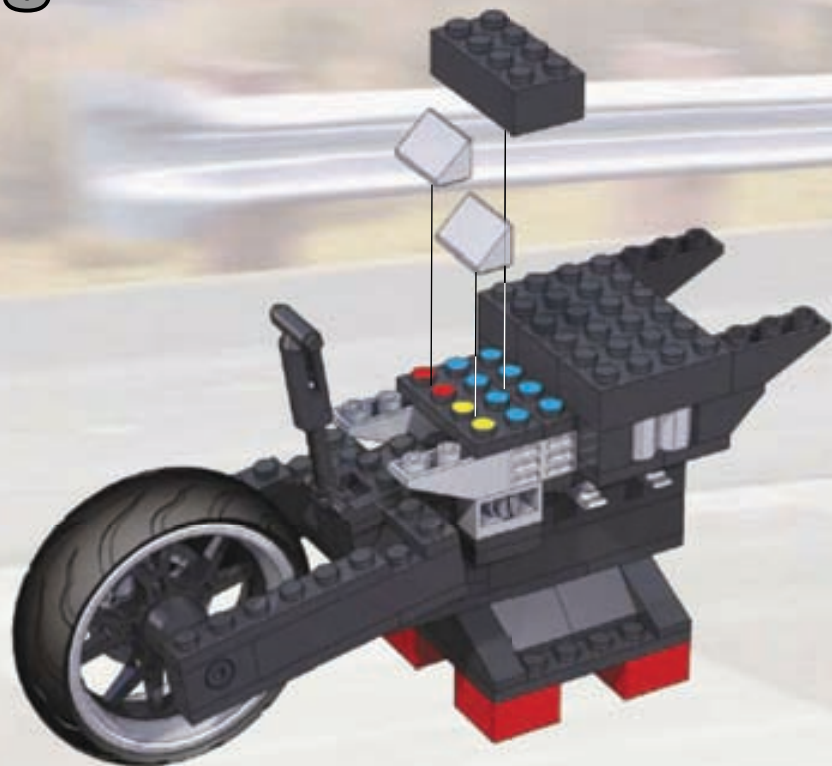

4

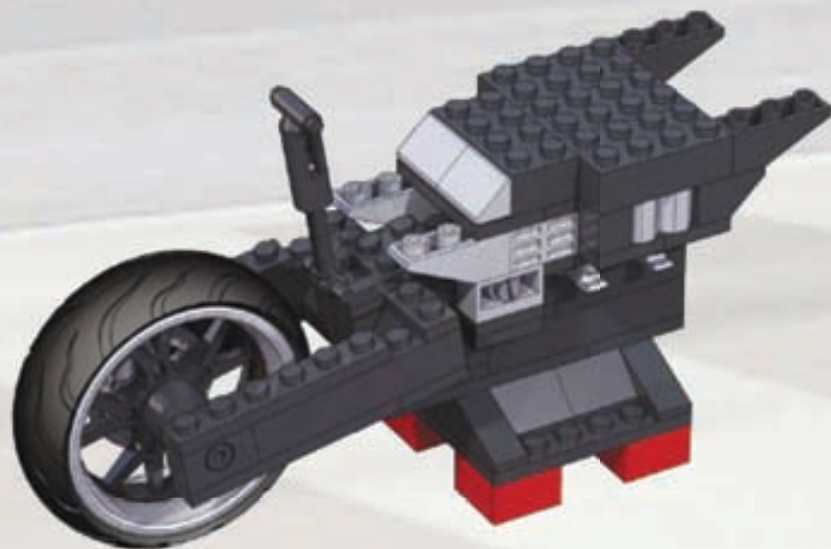

- 1x
- 1x
- 1x
- 1x
- 2x
- 2x
- 2x

1



2

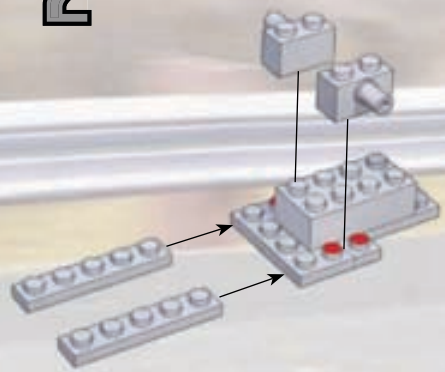

3

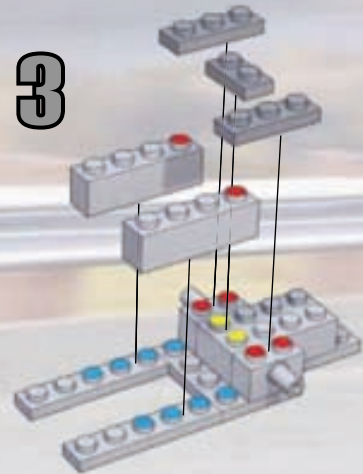

4

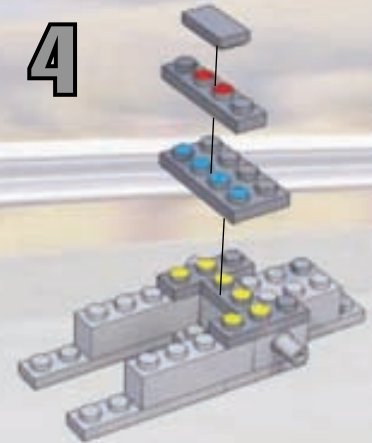

5

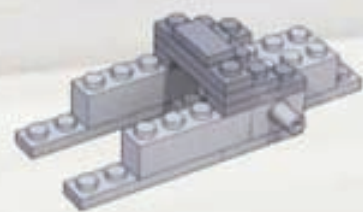

6

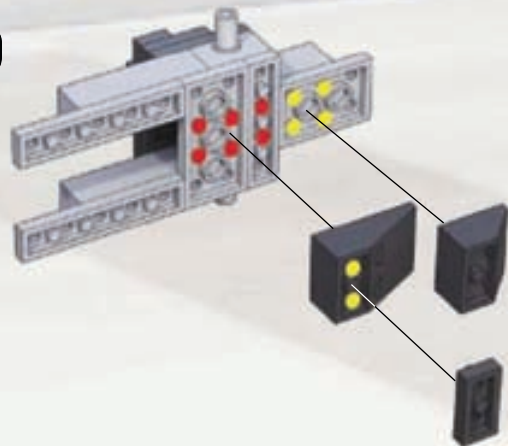

7

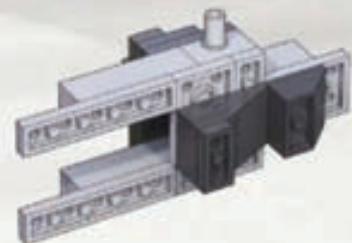

B

- 1x
- 2x
- 1x
- 1x
- 1x

C

- 1x
- 1x
- 1x

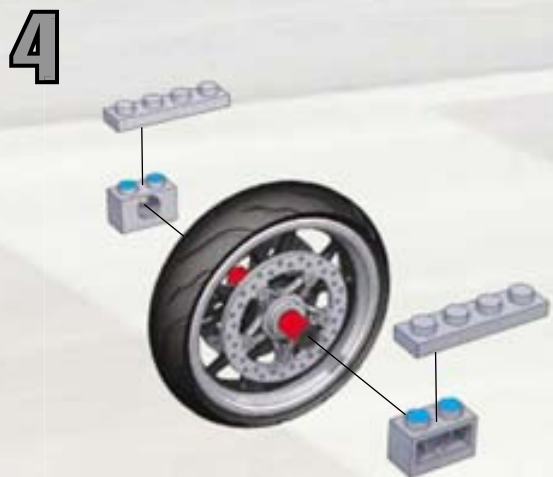

9

C 2x

1

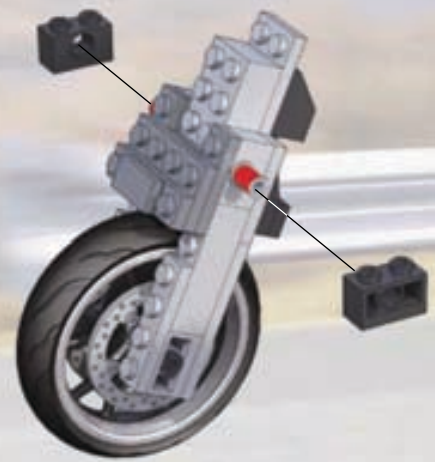

2

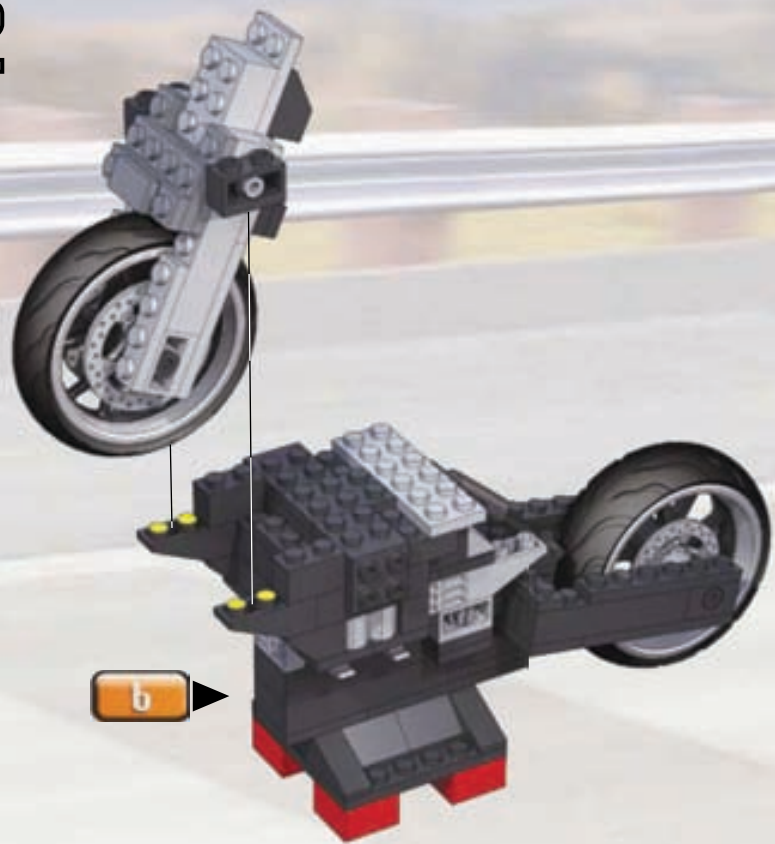

3



- A** 2x 2x
- B** 2x 4x
- C** 10x 1x 1x 1x

1

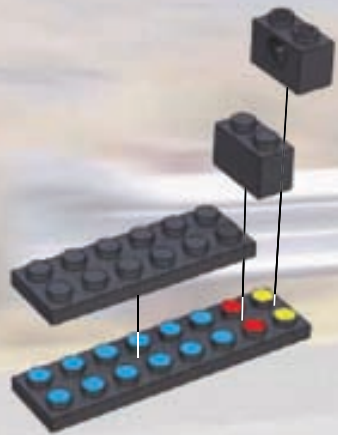

2

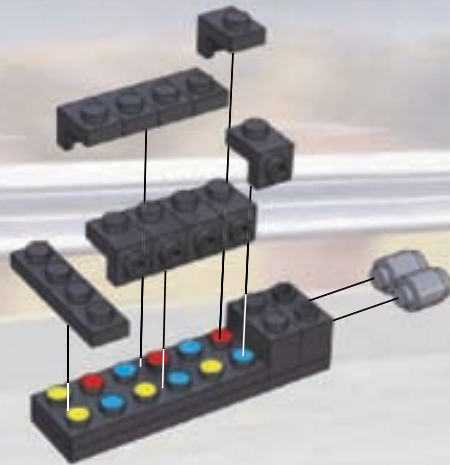

3

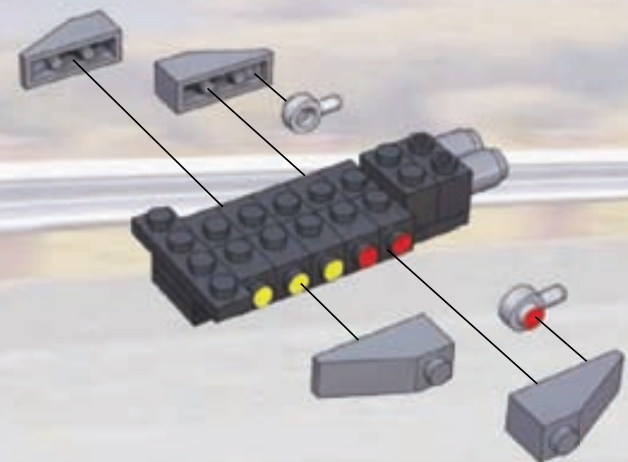

4

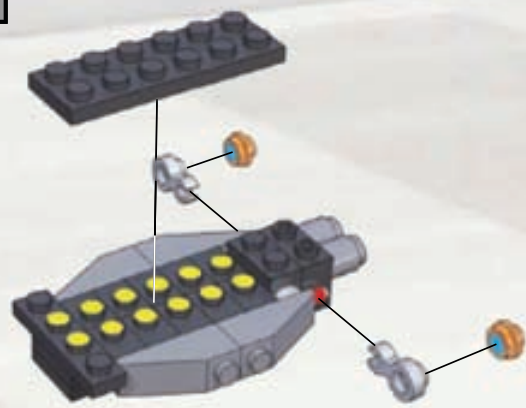

5



- C** 2x 1x
- D** 2x

- A 1x
- B 2x
- 2x
- 1x
- 1x
- 2x
- 2x
- 2x

1

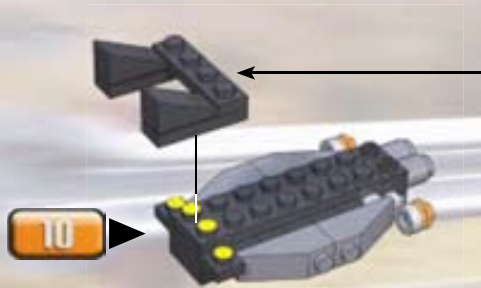

1



2



2



3

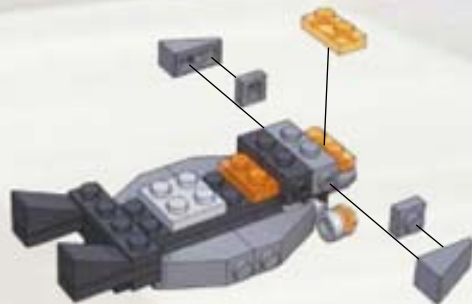

4



5

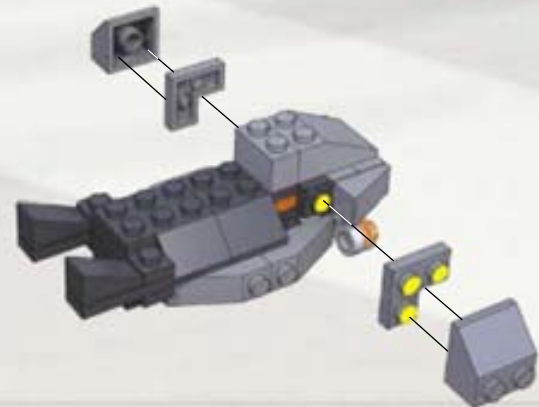

- C 2x
- 1x
- 2x
- 2x
- 2x
- D 1x
- 1x

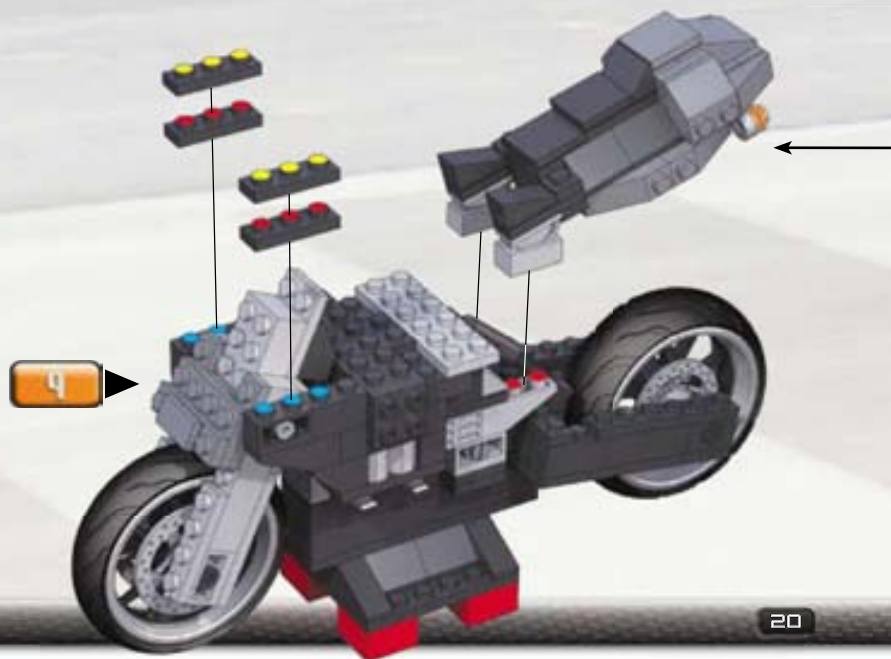
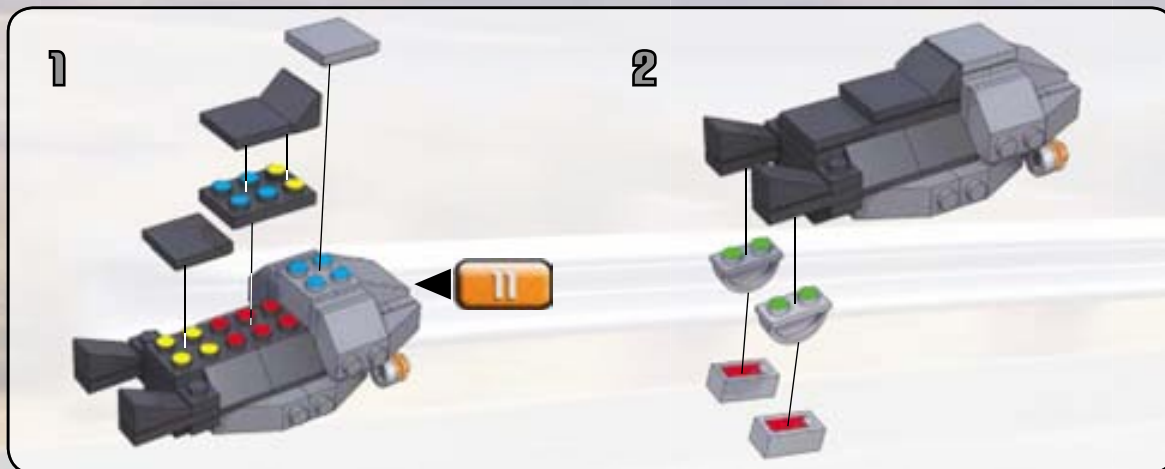

- EN** WARNING: Contains sharp points. Adult assembly required.
- ES** ADVERTENCIA: Contiene puntas muy agudas. Debe ser ensamblado por un adulto.
- FR** MISE EN GARDE: Contient des pièces à bout pointu. L'assemblage doit être fait par un adulte.
- DE** ACHTUNG: Enthält scharfe Kanten. Muss von Erwachsenen zusammengebaut werden.
- NL** WAARSCHUWING: Bevat scherpe punten. Vereist montage door volwassene.
- DA** ADVARSEL: Indeholder skarpe spidser. Montering af en voksen er obligatorisk.
- EL** ΠΡΟΕΙΔΟΠΟΙΗΣΗ: Περιέχει αιχμηρά σημεία. Απαιτείται σύνδεση από ενήλικους.
- FI** VAROITUS: Sisältää teräviä osia. Kokoamiseen tarvitaan aikuinen.
- IT** ATTENZIONE: Contiene punte affilate. Deve essere montato da un adulto.
- NO** ADVARSEL: Spisse deler. Må settes sammen av voksne.
- PT** ADVERTENCIA: Contém pontas agudas. Requer montagem por adultos.
- SV** VARNING: Innehåller vassa spetsar. Bör monteras av en vuxen.
- JA** 警告：先の尖ったものが含まれています。組立は大人がしてください。
- ZH** 警告：含有尖刺。需由成人組裝。
- AR** تحذير: تحتوي على حواف حادة. يلزم أن يتم التجميع بمعرفة شخص بالغ.

-  2x
-  1x
-  2x
-  2x
-  1x
-  2x
-  1x

1

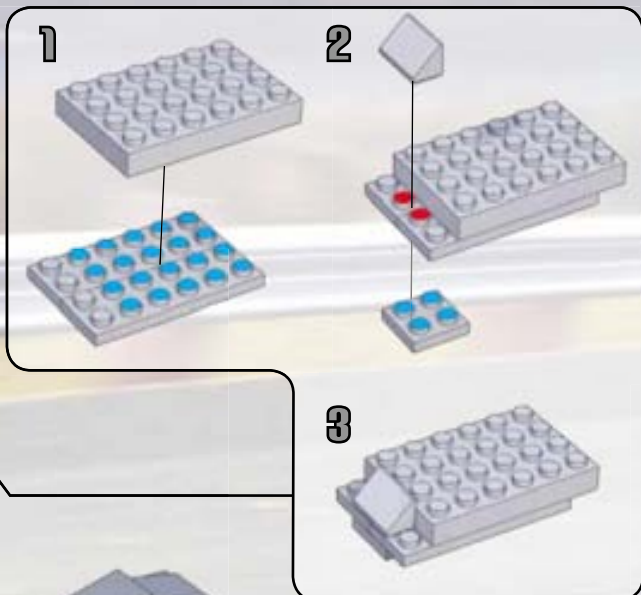
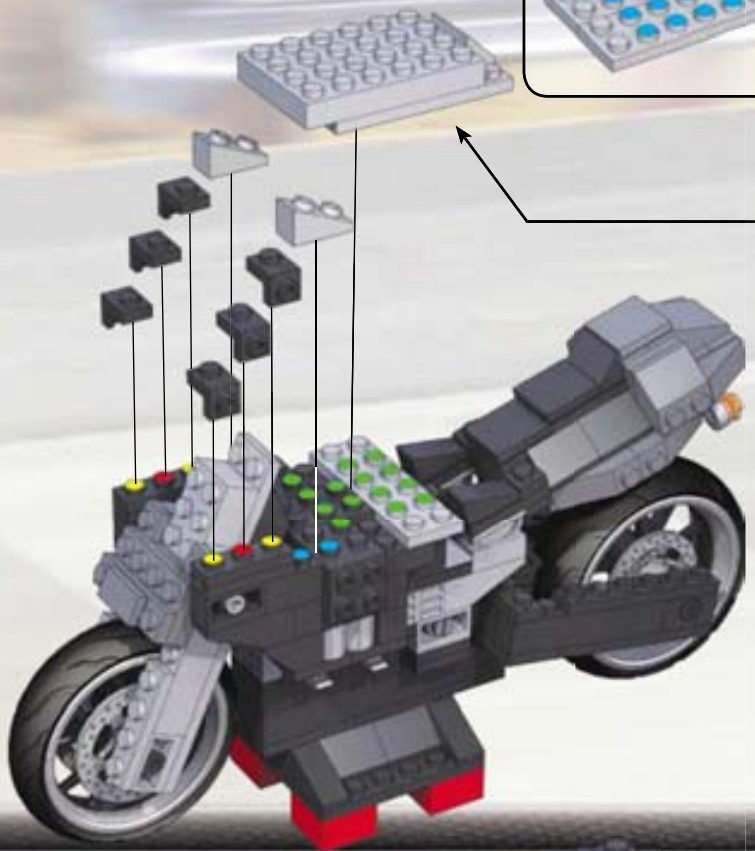

2

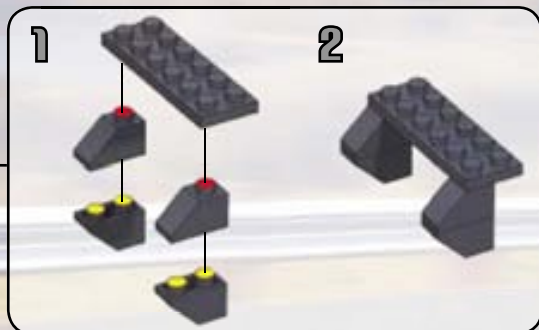

-  6x
-  2x
-  2x
-  1x
-  2x

- A 3x
- B 2x
- C 2x
- D 1x
- E 2x
- F 1x
- G 2x
- H 2x

1



2

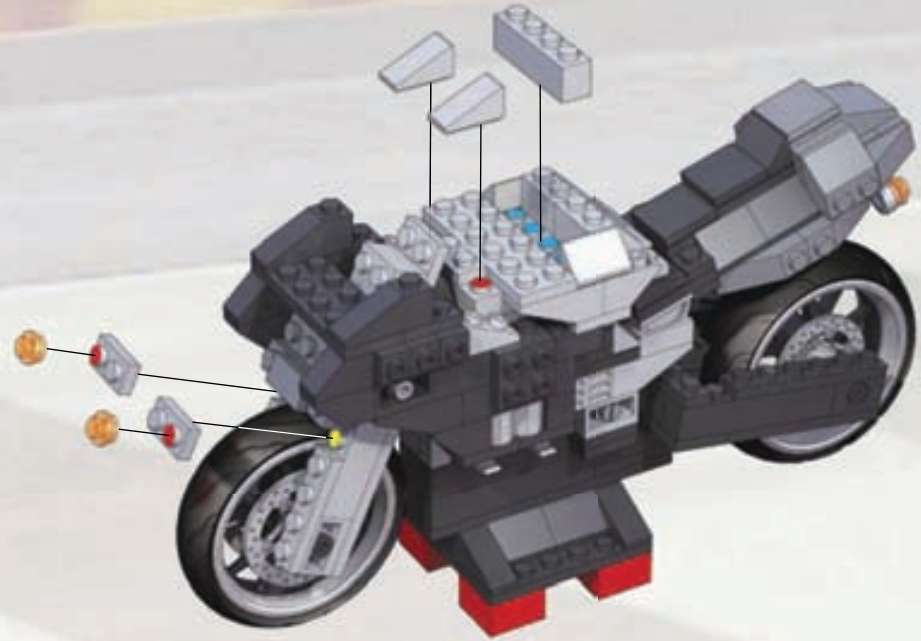

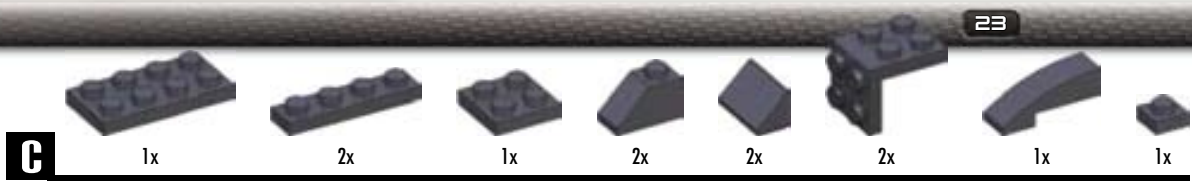
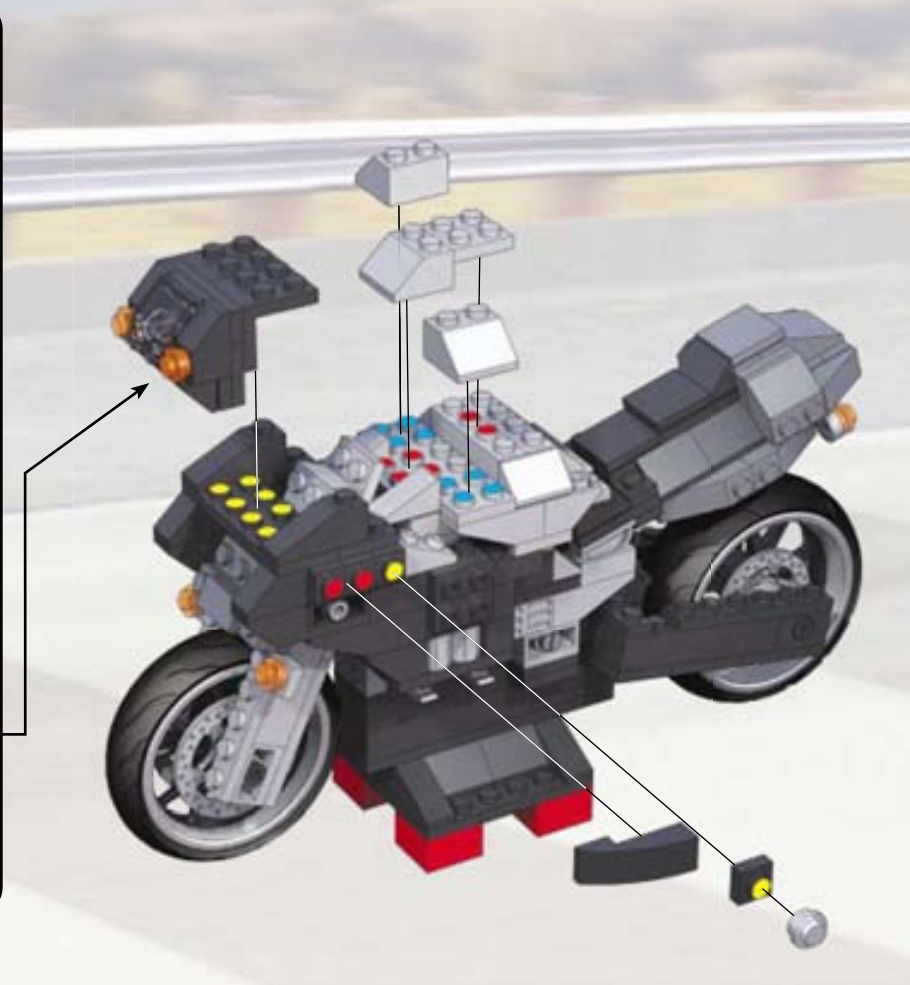
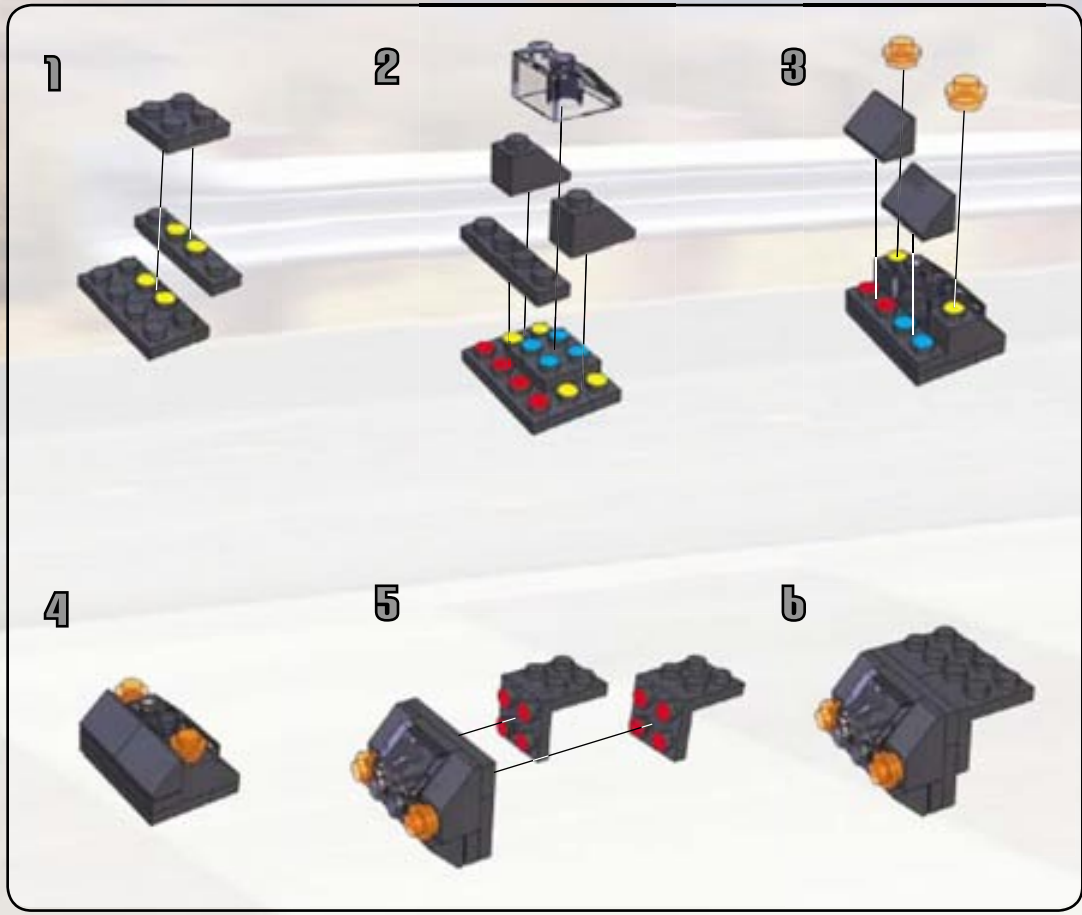

- A 4x 1x 1x
- B 1x
- C 2x
- D 2x

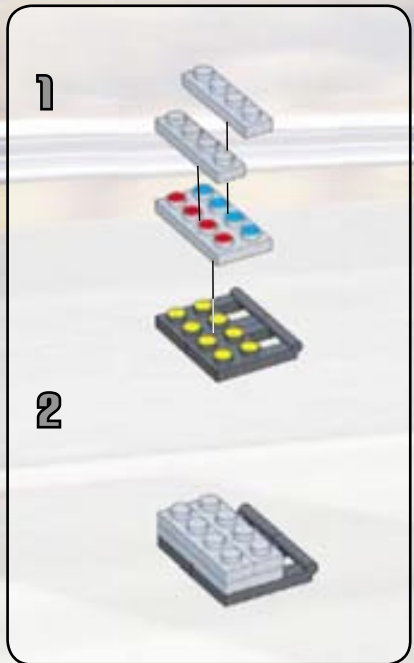
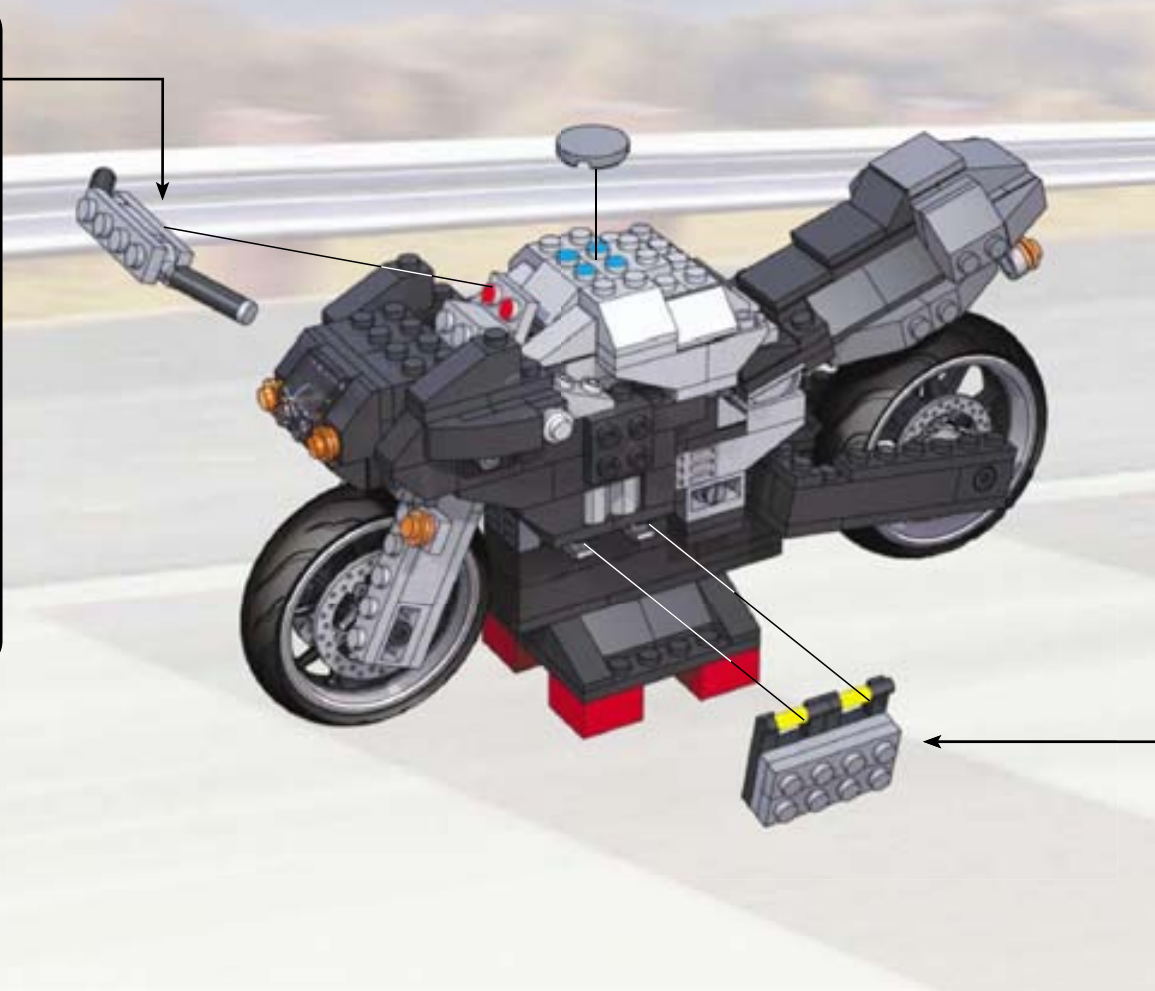
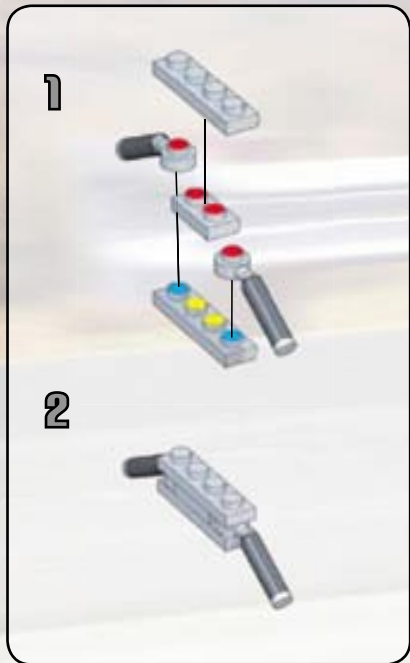

- 6 1x
- 2x
- 1x
- 1x
- 2x
- D 1x

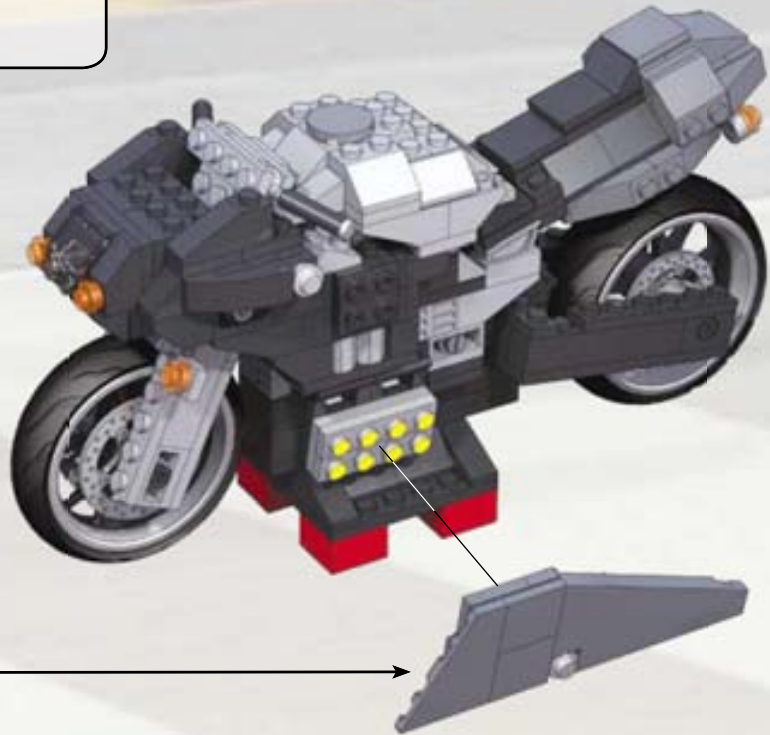
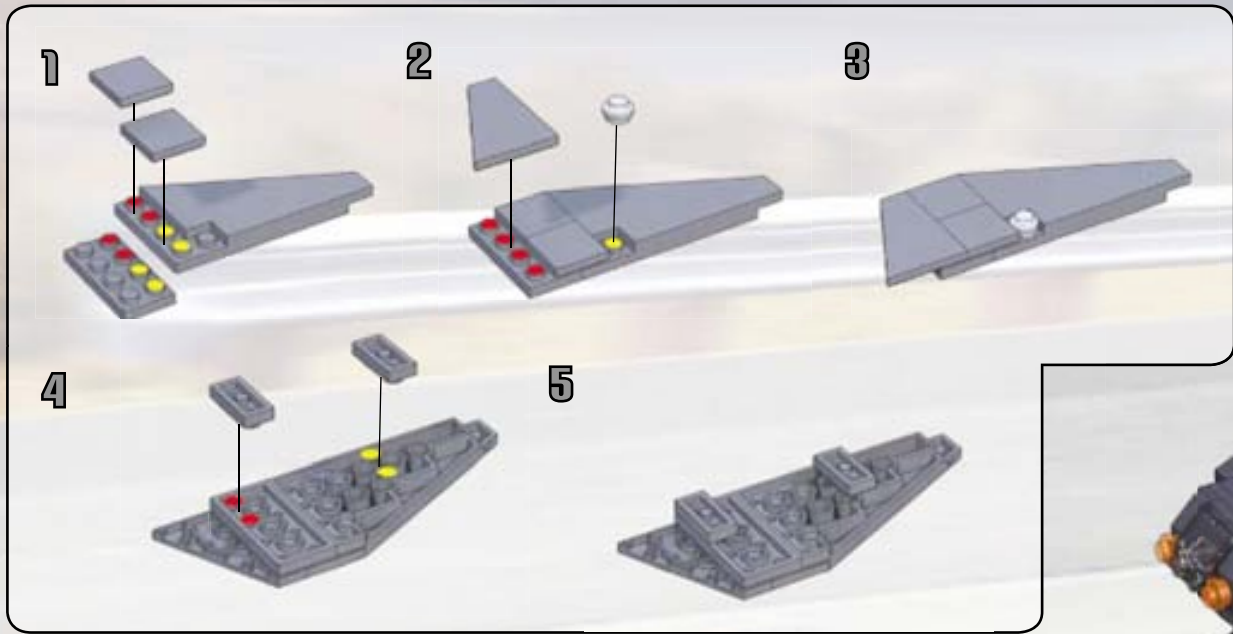

- A 1x
- B 1x
- 1x
- 2x
- 1x
- 2x
- 1x

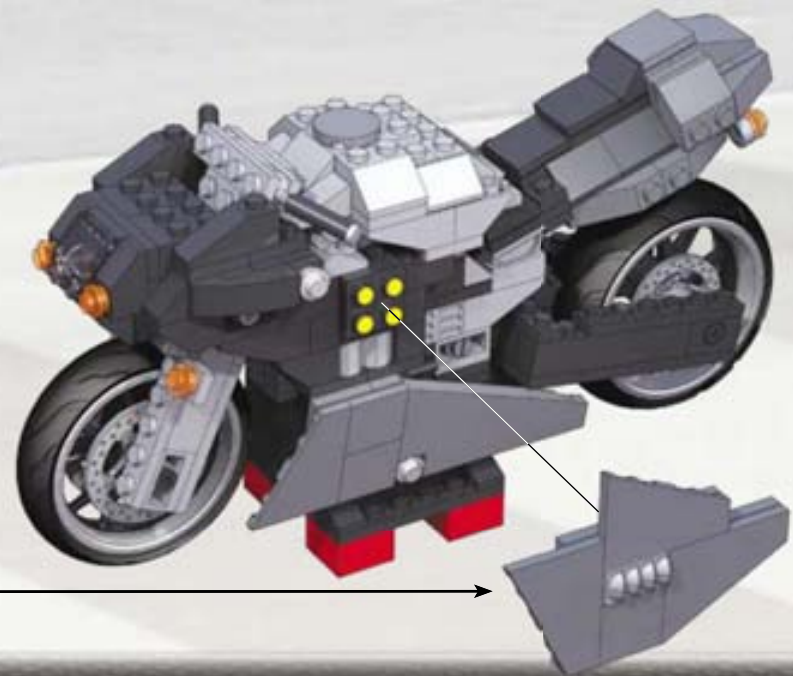
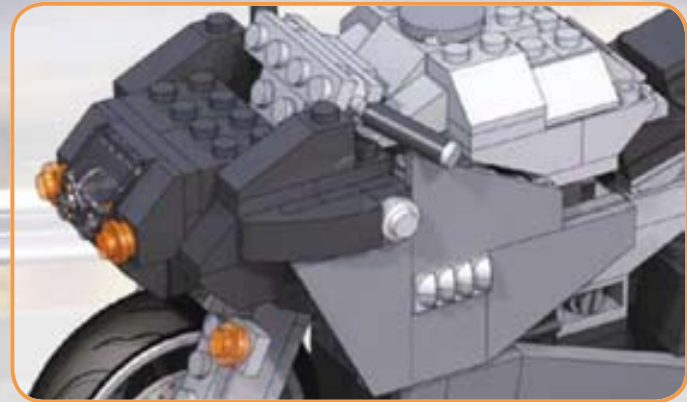
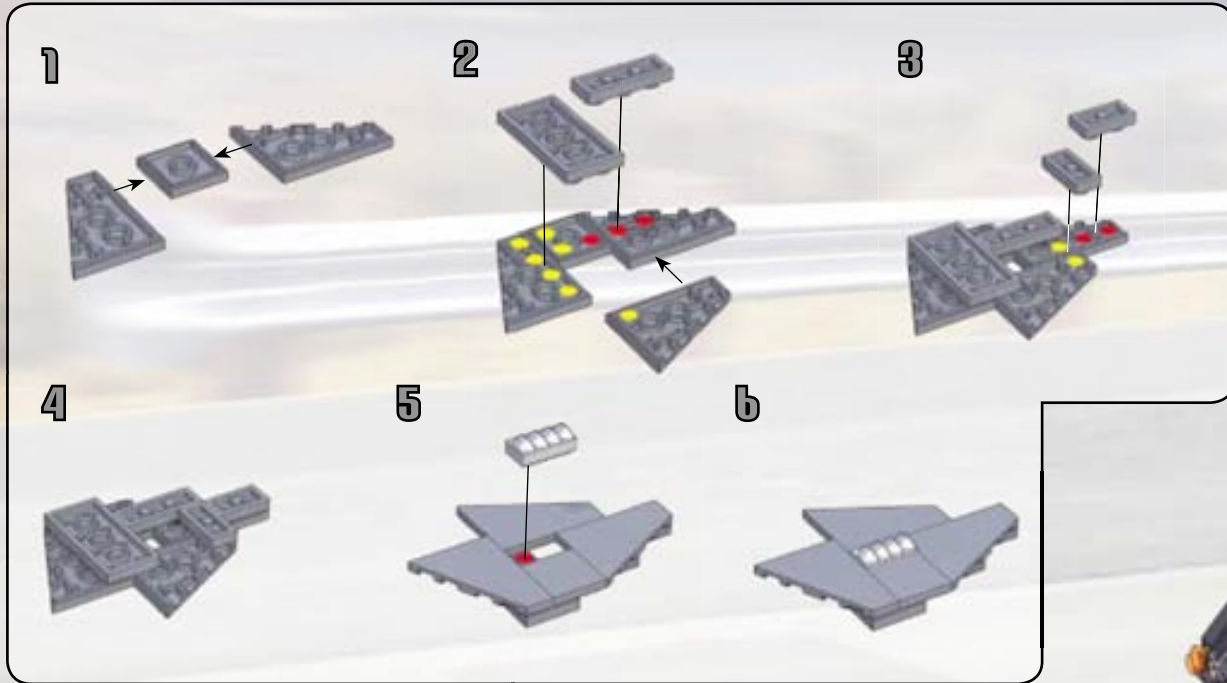

- A 1x
- 1x
- 2x

- C 1x
- 1x
- 2x

1



18

2

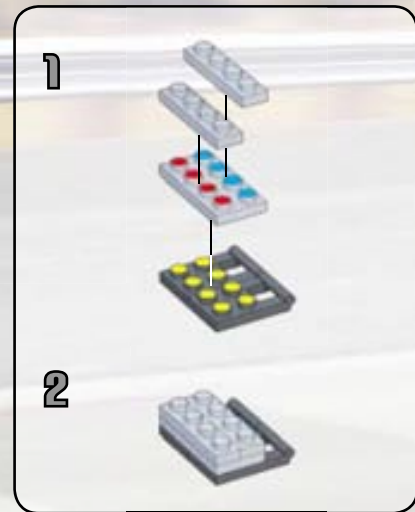

1

2

- A 1x
- B 1x
- 2x
- 1x
- 1x
- 2x

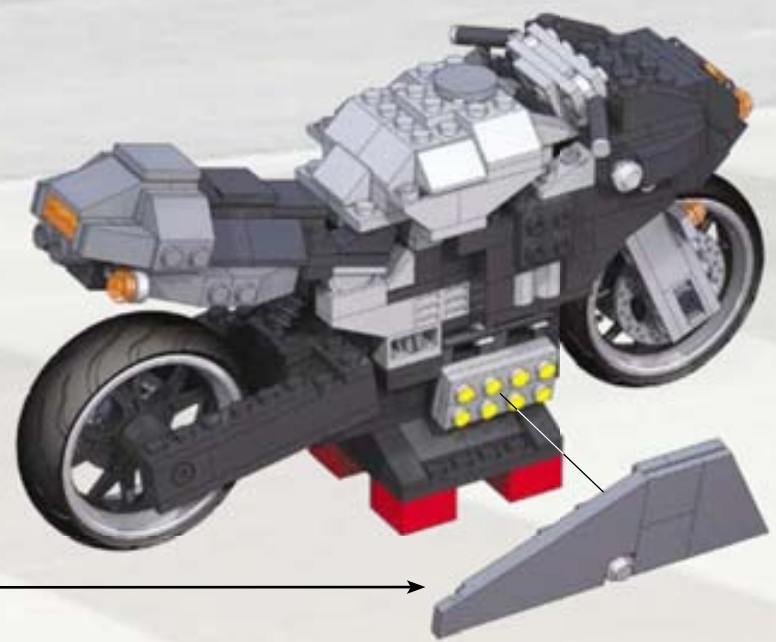
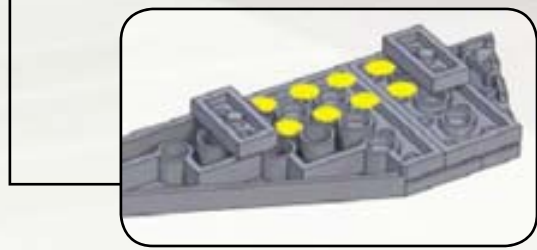
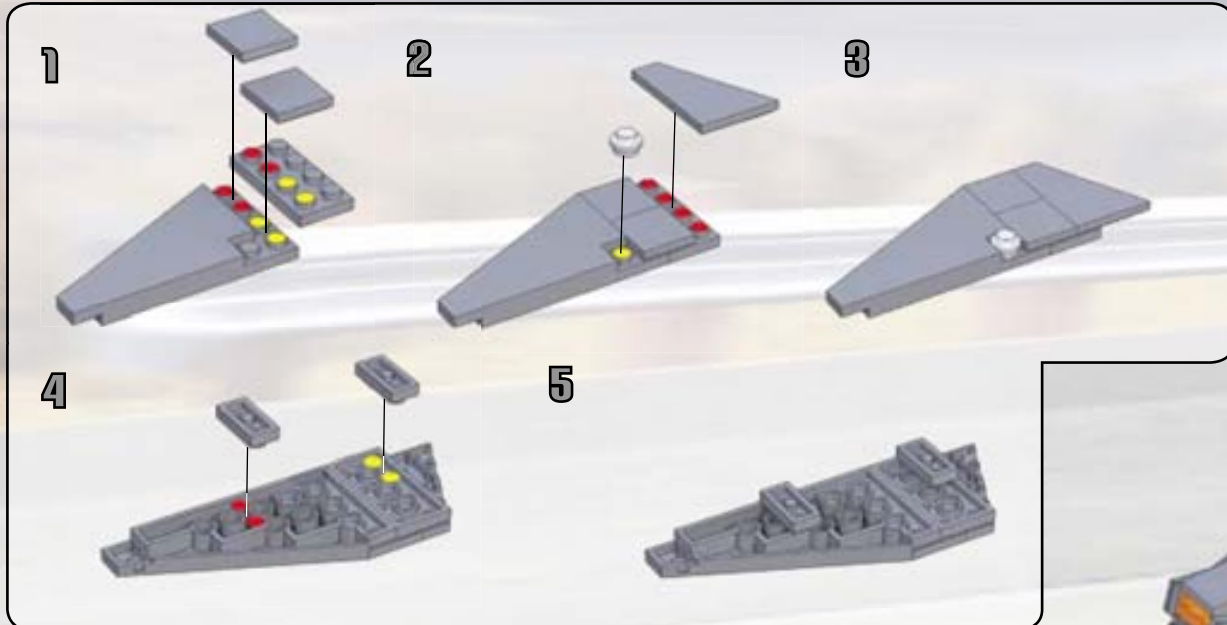

- A 1x
- B 1x
- 1x
- 1x
- 2x
- 2x
- 1x

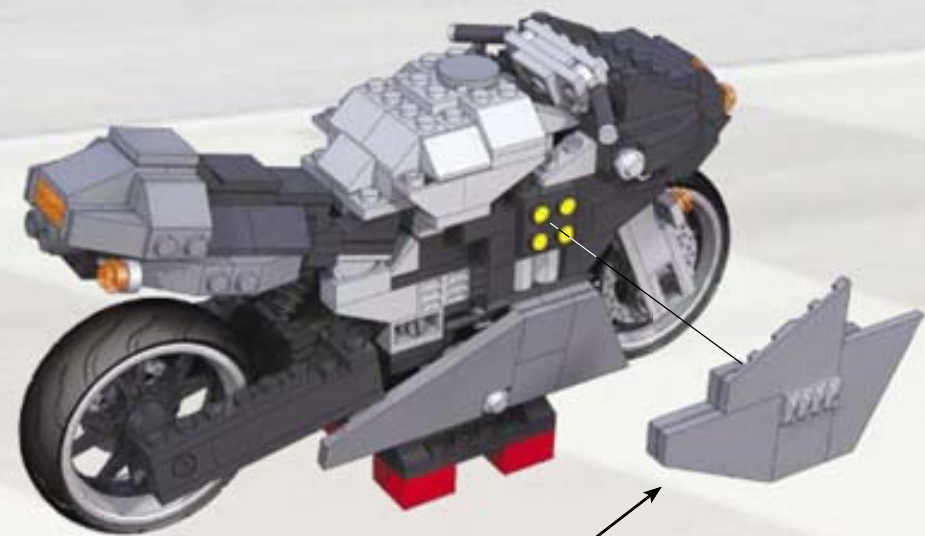
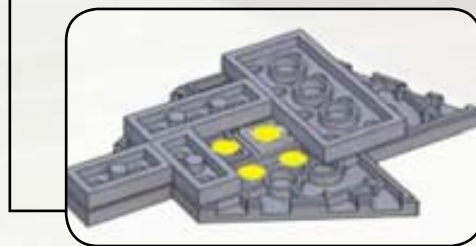
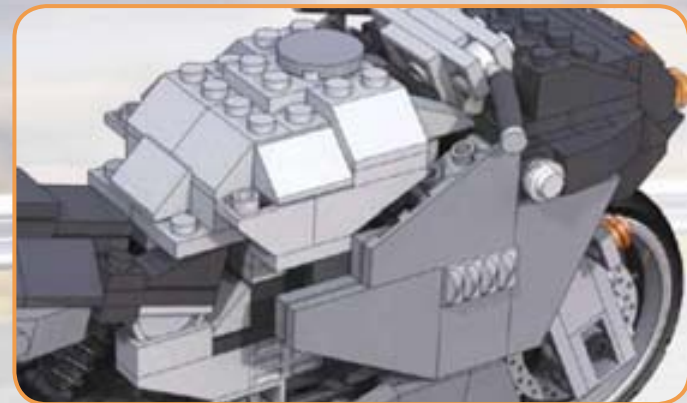
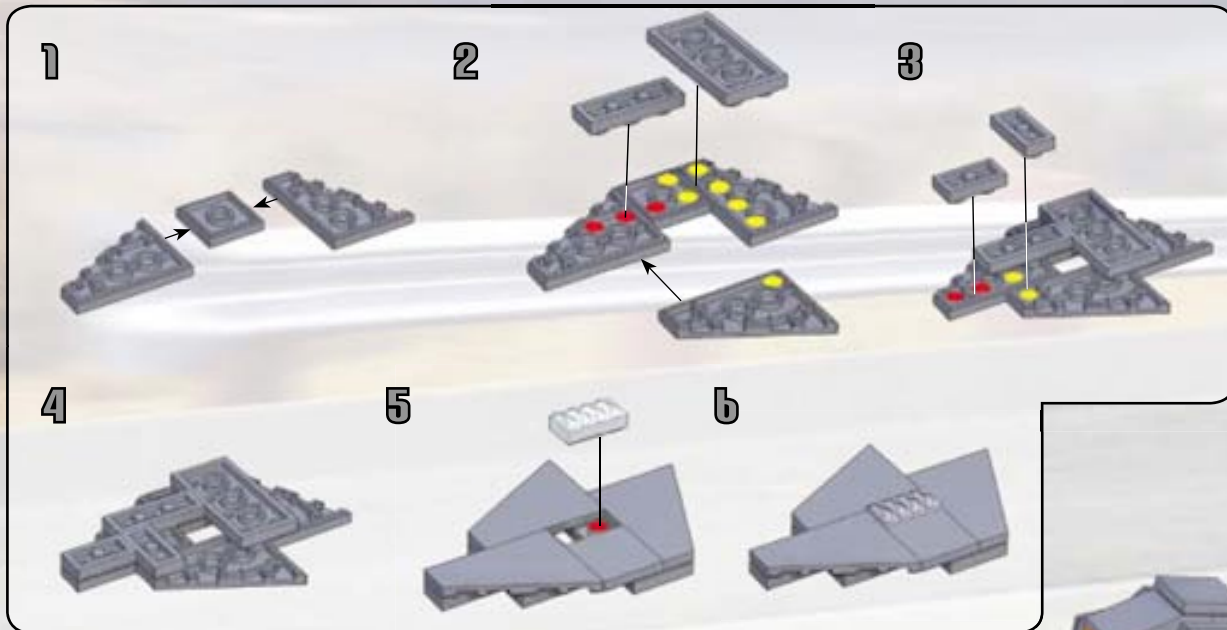

1



2

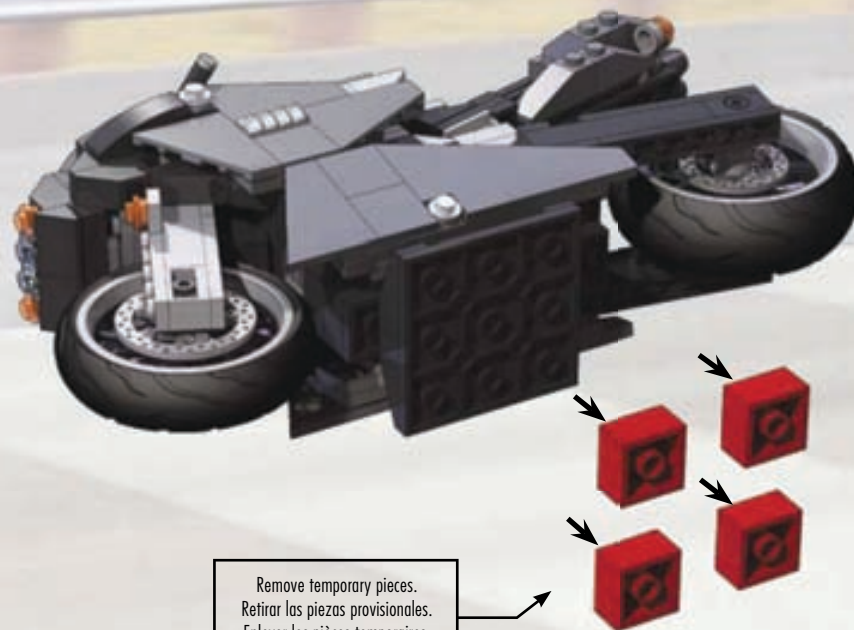

Remove temporary pieces.
Retirar las piezas provisionales.
Enlever les pièces temporaires.
Provisorische Teile entfernen.
Verwijder de tijdelijke onderdelen.
Rimuovere i pezzi temporanei.
Retirar peças temporárias.



3268



Probuilder



Carbon Series™

Sports Bike



228 x 174 x 141 mm



24.4 in x 21.3 in



10.2 in x 8.1 in



Ultimate collection!
¡Una colección indispensable!
Collection ultime !
Die ultimative Sammlung!
Ultieme verzameling!
La collezione all'ultimo grido!
Uma coleção a não perder!



3269



3274



3275



3271



3272



3263

© 2009, MEGA Brands Inc.
MEGA Brands Inc. und das MEGA Brands Inc.-Logo sind eingetragene Warenzeichen von MEGA Brands Inc.
MEGA Brands Inc. and the MEGA Brands Inc. logo are registered trademarks of MEGA Brands Inc.
MEGA Brands Inc. y el logotipo MEGA Brands Inc. son marcas registradas de MEGA Brands Inc.
MEGA Brands Inc. et le logo de MEGA Brands Inc. sont des marques de commerce déposées de MEGA Brands Inc.
MEGA Brands Inc. en het MEGA Brands Inc. logo zijn gedeponeerde handelsmerken van MEGA Brands Inc.
MEGA Brands Inc. ed il logo di MEGA Brands Inc. sono marchi di fabbrica di MEGA Brands Inc.
MEGA Brands Inc. e o logo MEGA Brands Inc. são marcas registradas de MEGA Brands Inc.
Printed in Canada D032681A

