

# Probuilder<sup>®</sup>

CARBON SERIES™



3263 | Battleship



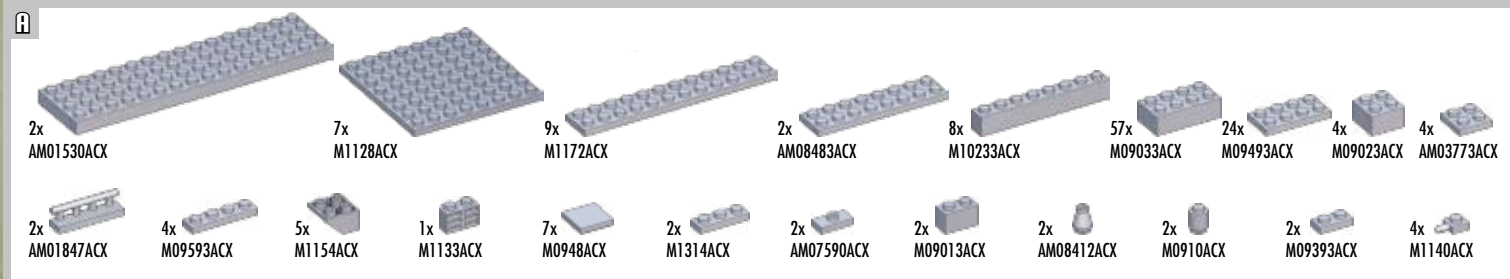

**EN** WARNING: Contains sharp points. Adult assembly required.  
**ES** ADVERTENCIA: Contiene puntas muy agudas. Debe ser ensamblado por un adulto.  
**FR** MISE EN GARDE: Contient des pièces à bout pointu. L'assemblage doit être fait par un adulte.  
**DE** ACHTUNG: Enthält scharfe Kanten. Muss von Erwachsenen zusammengebaut werden.  
**NL** WAARSCHUWING: Bevat scherpe punten. Vereist montage door volwassene.  
**DA** ADVARSEL: Indeholder skarpe spidser. Montering af en voksen er obligatorisk.  
**EL** ΠΡΟΕΙΔΟΠΟΙΗΣΗ: Περιέχει αιχμηρά σημεία. Απαιτείται σύνδεση από ενήλικους.  
**FI** VAROITUS: Sisältää teräviä osia. Kokoamiseen tarvitaan aikuinen.  
**IT** ATTENZIONE: Contiene punte affilate. Deve essere montato da un adulto.  
**NO** ADVARSEL: Spisse deler. Må settes sammen av voksne.  
**PT** ADVERTENCIA: Contém pontas agudas. Requer montagem por adultos.  
**SV** VARNING: Innehåller vassa spetsar. Bör monteras av vuxnen.  
**JA** 警告: 先の尖ったものが含まれています。組立は大人がしてください。  
**ZH** 警告: 含有尖刺。需由成人組裝。  
**AR** تحذير: تحتوي على حواف حادة. يلزم أن يتم التجميع بمعرفة شخص بالغ.

**EN** Please read these instructions carefully before first use and keep them for future reference. /  
**ES** Leer estas instrucciones cuidadosamente antes de la primera utilización y guardarlas para referencia futura. /  
**FR** Il est recommandé de lire attentivement ce feuillet avant la première utilisation et de le conserver pour référence future. /  
**DE** Die Gebrauchsanleitung bitte durchlesen und aufbewahren. /  
**NL** Wij raden u aan deze handleiding zorgvuldig te lezen en te bewaren voor eventuele raadpleging op een later tijdstip. /  
**IT** Leggere le istruzioni prima di cominciare ad usare il gioco e conservarle per referenze future. /  
**PT** Leia as instruções antes do primeiro uso e guarde-as para futura referência.

**EN** ⚠️ WARNING: CHOKING HAZARD. - Small parts. Not for children under 3 years.  
**ES** ⚠️ ADVERTENCIA: PELIGRO DE ASFIXIA. - Contiene piezas pequeñas. No recomendado para niños menores de 3 años.  
**FR** ⚠️ AVERTISSEMENT: RISQUE DE SUFFOCATION. - Présence de petits éléments. Ne convient pas aux enfants de moins de 3 ans.  
**DE** ⚠️ WARNUNG: ERSTICKUNGSGEFAHR. - Enthält kleine Teile. Nicht für Kinder unter 3 Jahren geeignet.

**NL** ⚠️ WAARSCHUWING: VERSTIKKINGSGEVAAR. - Bevat kleine onderdelen. Niet geschikt voor kinderen onder de 3 jaar.  
**DA** ⚠️ ADVARSEL: KVÆLNINGSFARE. - Indeholder smådele. Ikke til børn under 3 år.  
**EL** ⚠️ ΠΡΟΕΙΔΟΠΟΙΗΣΗ: ΚΙΝΔΥΝΟΣ ΠΝΙΞΙΜΑΤΟΣ. - Περιέχει μικρά αντικείμενα. Όχι για παιδιά κάτω των 3 ετών.  
**FI** ⚠️ VAROITUS: TUKEHTUMISVAARA. - Sisältää pieniä osia. Ei alle 3-vuotiaille lapsille.

**IT** ⚠️ ATTENZIONE: PERICOLO DI SOFFOCAMENTO. - Contiene piccole parti. Non indicato per bambini sotto i 3 anni.  
**NO** ⚠️ ADVARSEL: KVÆLNINGSFARE. - Inneholder små deler. Kun for barn over 3 år.  
**PT** ⚠️ ATENÇÃO: PERIGO DE ASFIXIA. - Contém peças pequenas. Não é concebido para crianças de menos de 3 anos.  
**SV** ⚠️ VARNING: KVÄVNINGSRISK. - Innehåller små delar. Inte för barn under 3 år.

**JA** ⚠️ 警告: 窒息の危険性 - 小さな部品が含まれています。3歳以下の子供には与えないで下さい。  
**ZH** ⚠️ 警告: 有窒息危险。 - 包含有小部件。不适合3岁以下的小孩玩。  
**AR** ⚠️ تحذير: خطر اختناق - قطع صغيرة. غير صالحة للأطفال أقل من 3 سنوات.



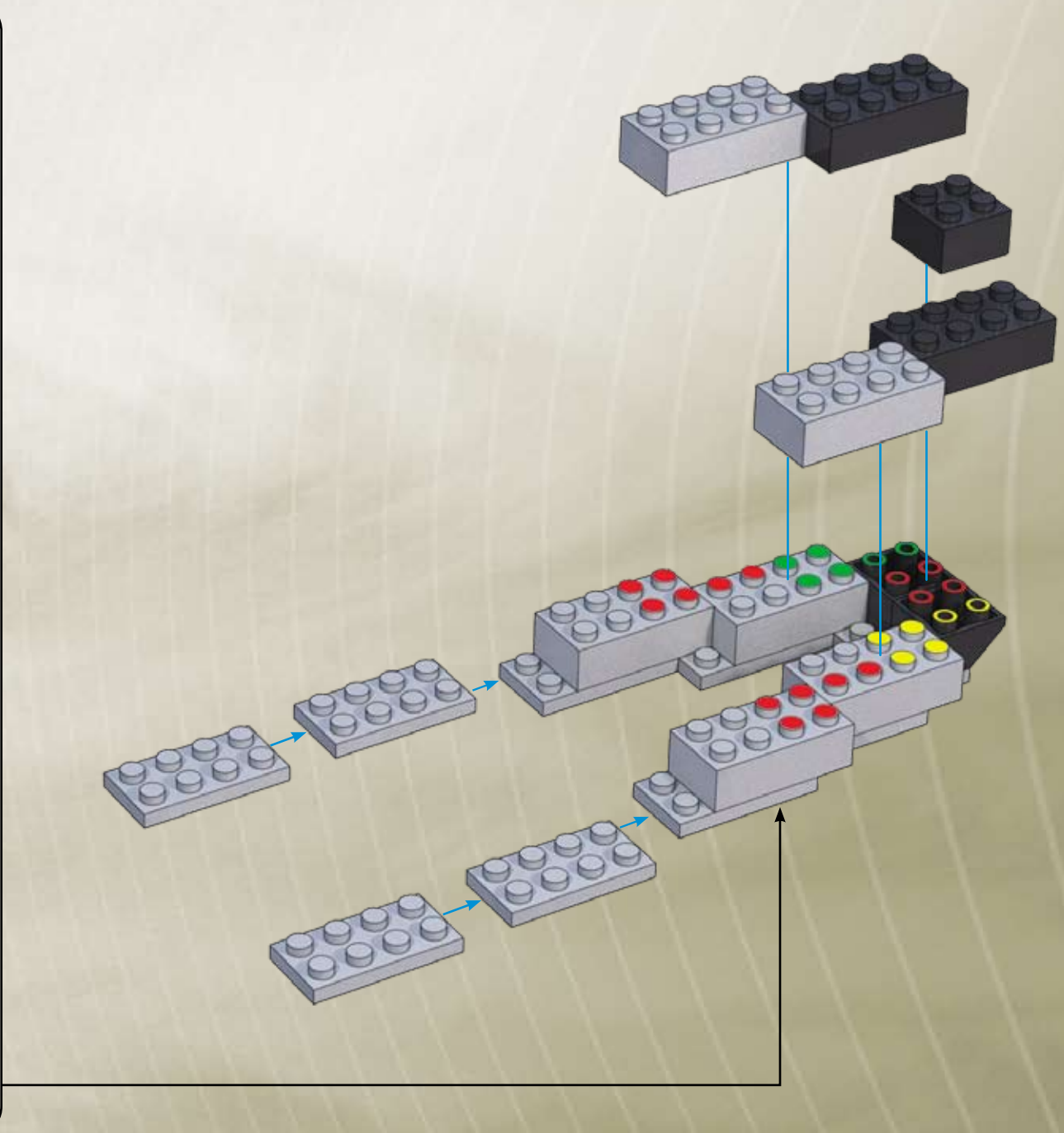
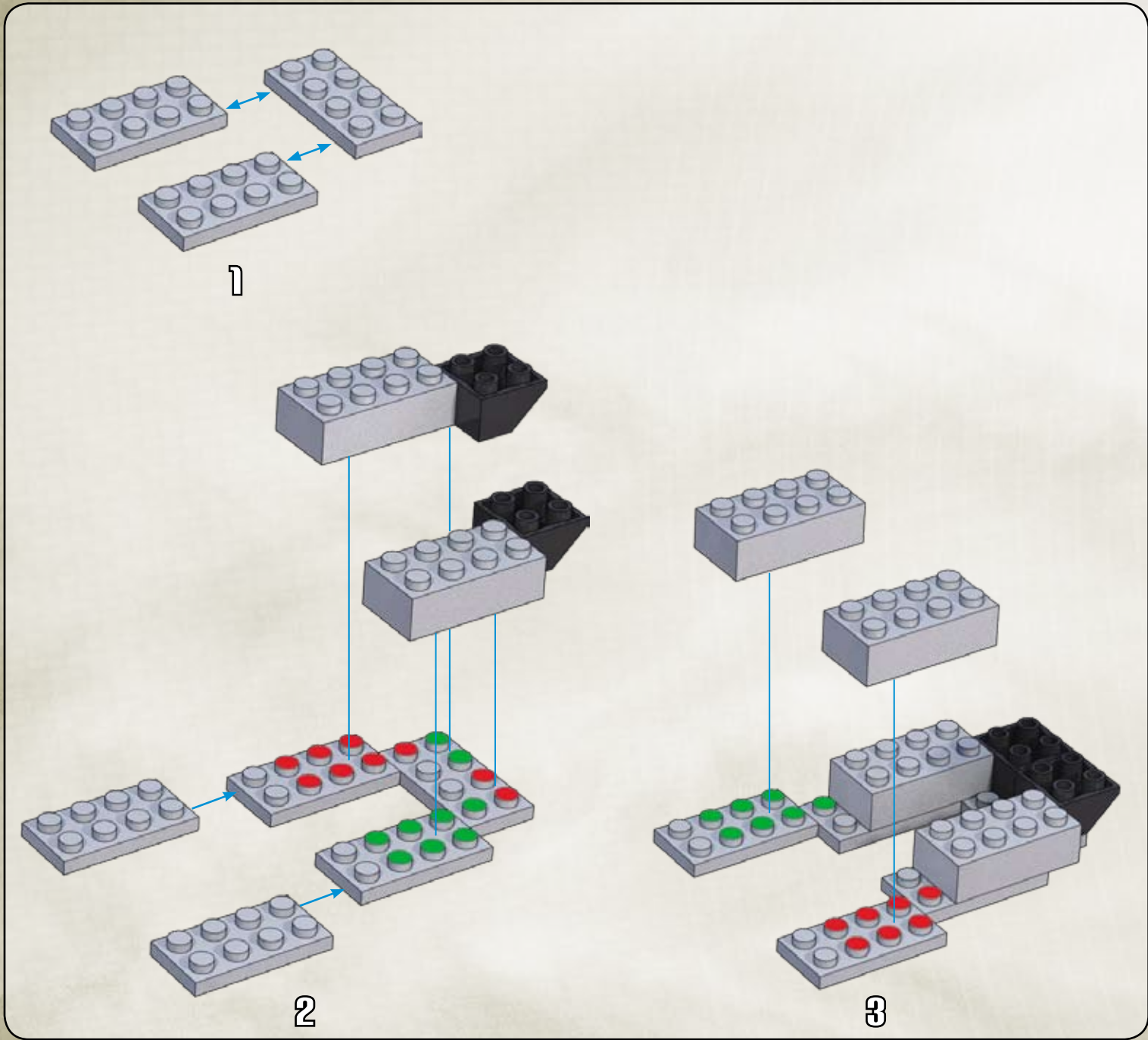
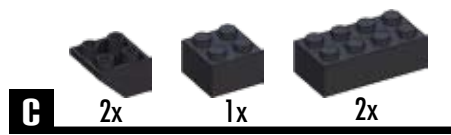
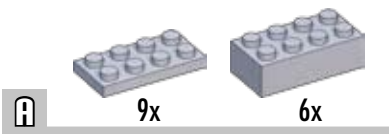

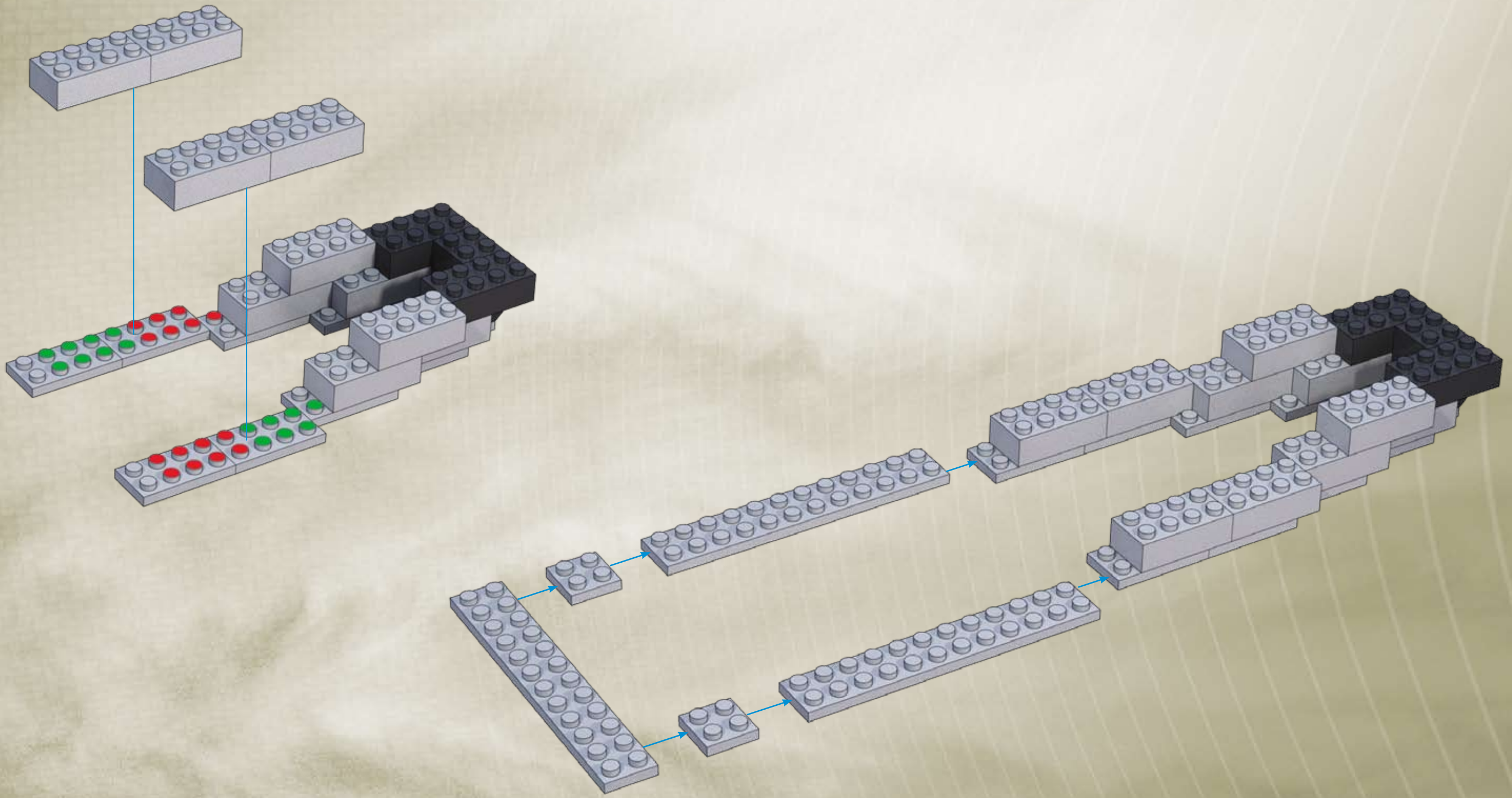
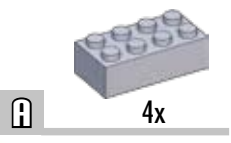

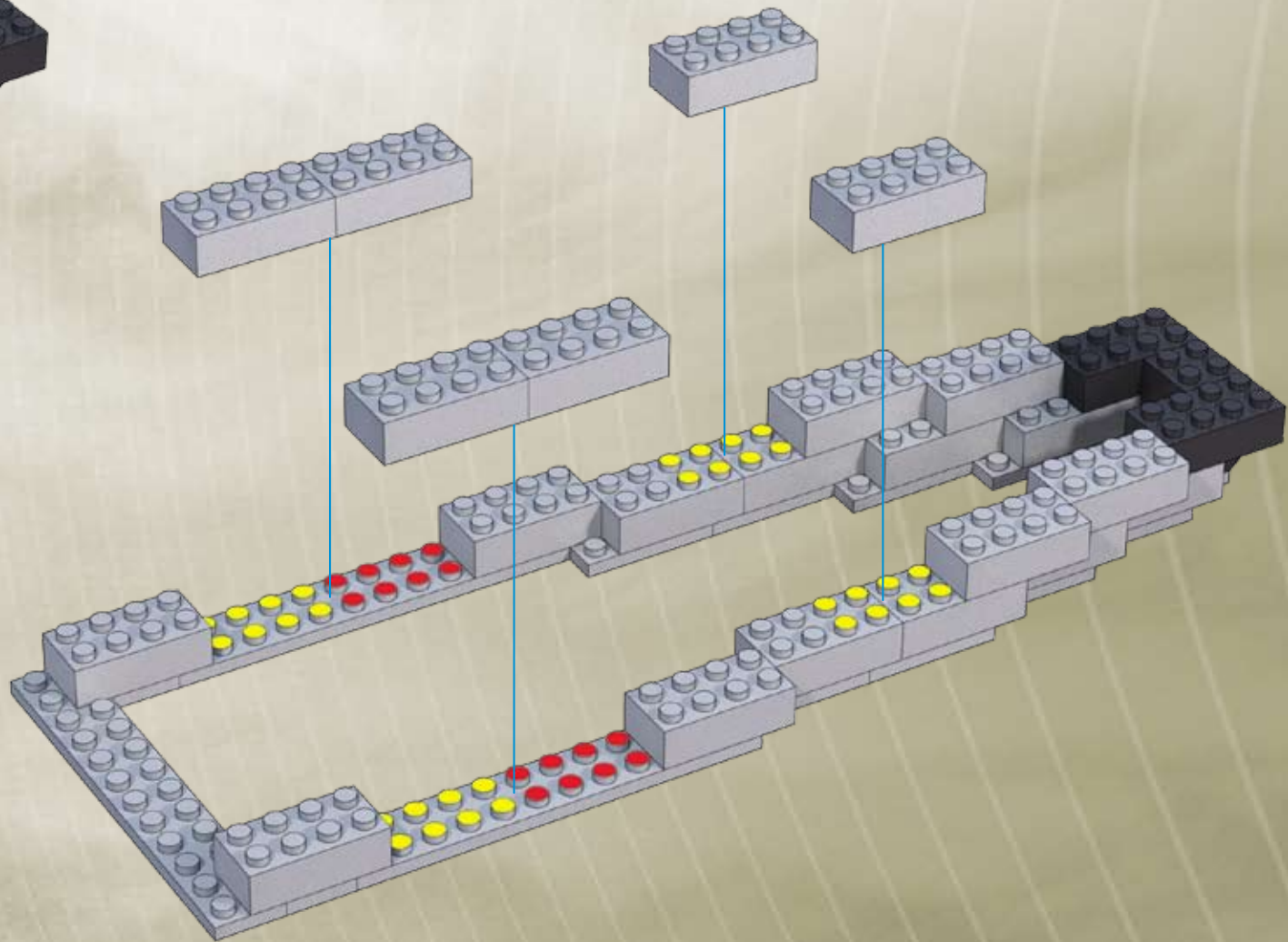
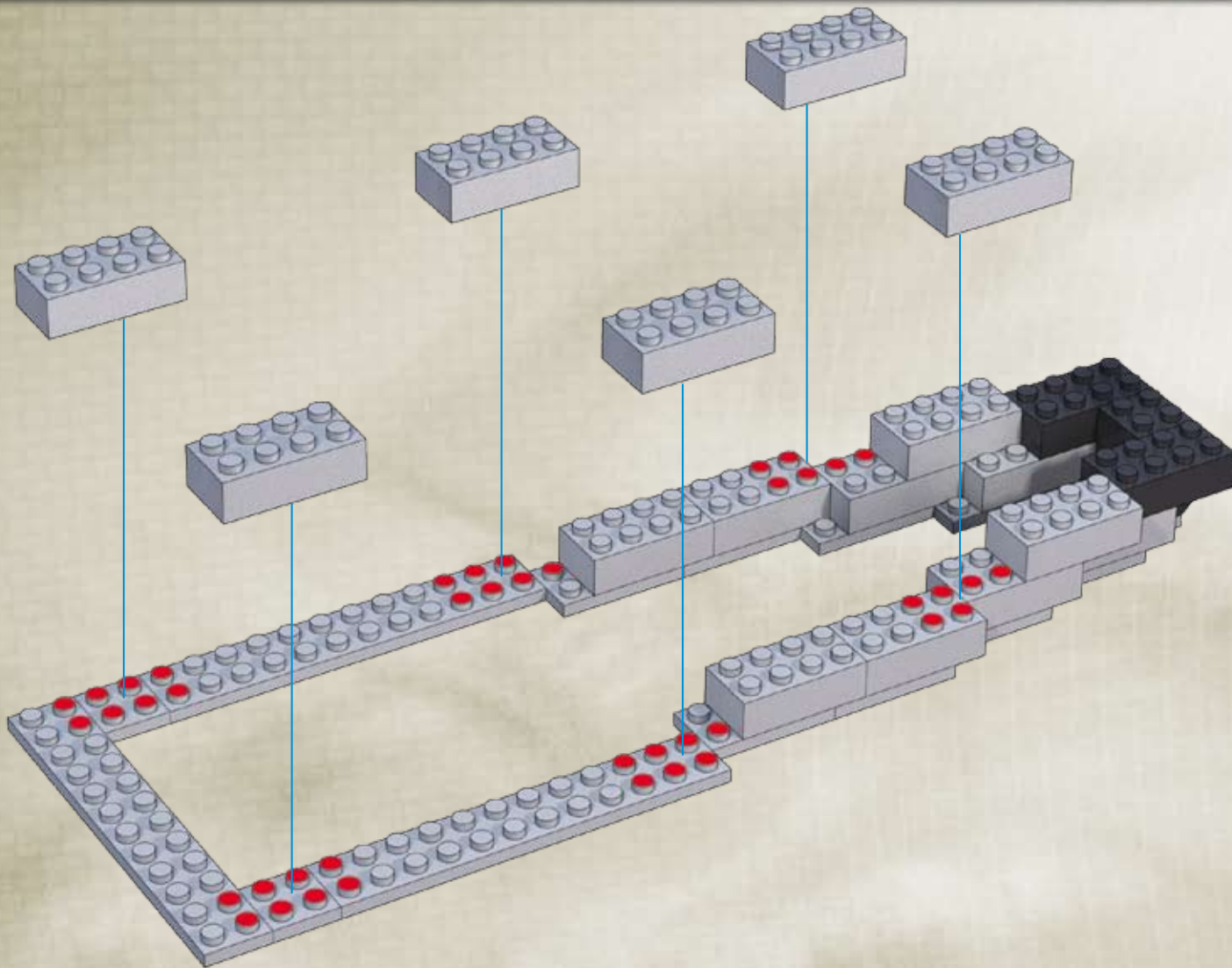

4

 6x



5

 6x

5

**b**

**B** 8x

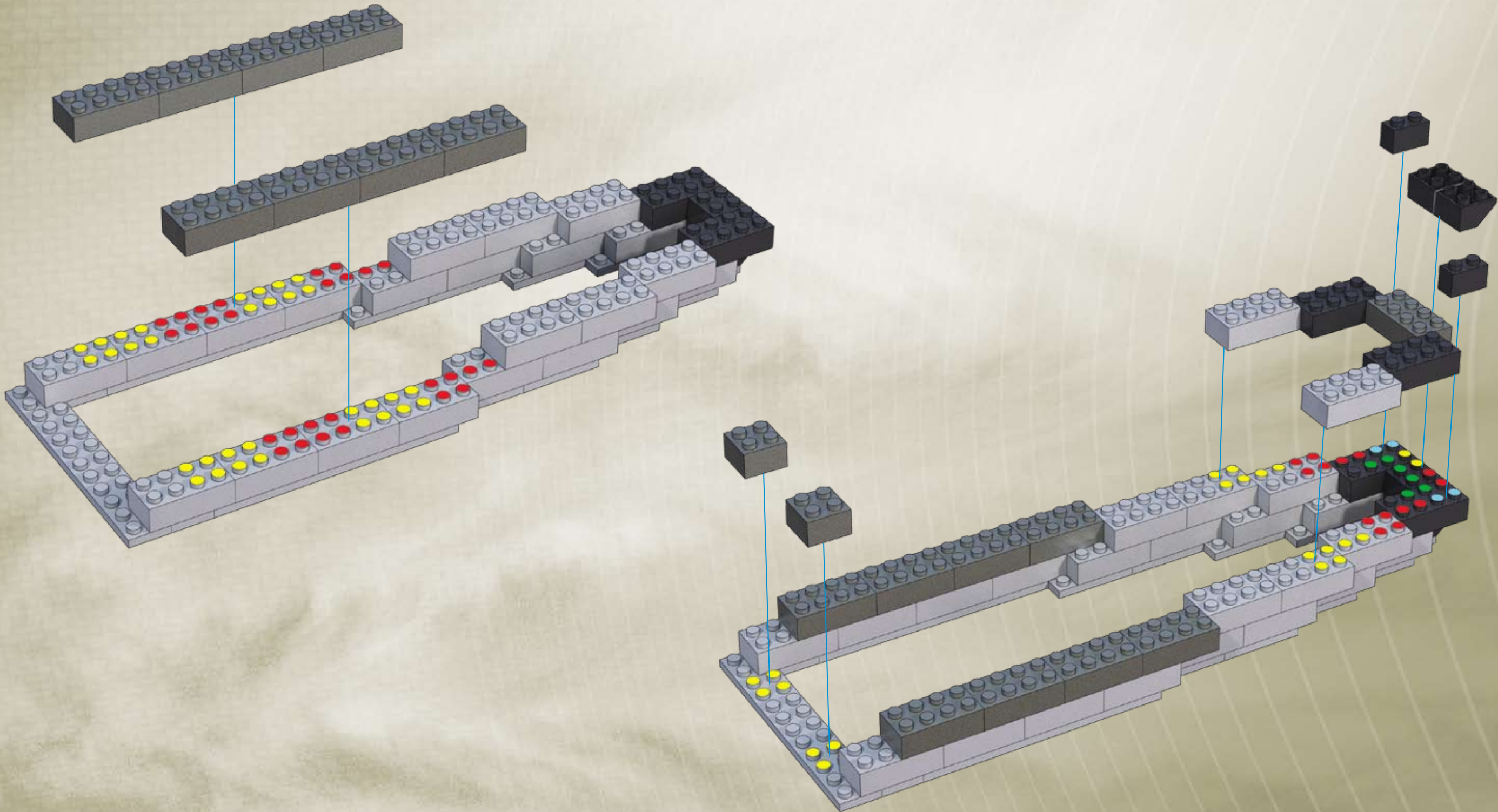

**6**

**A** 2x

**B** 1x 2x

**C** 2x 2x 2x

**7**

- A** 2x
- 1x
- B** 8x

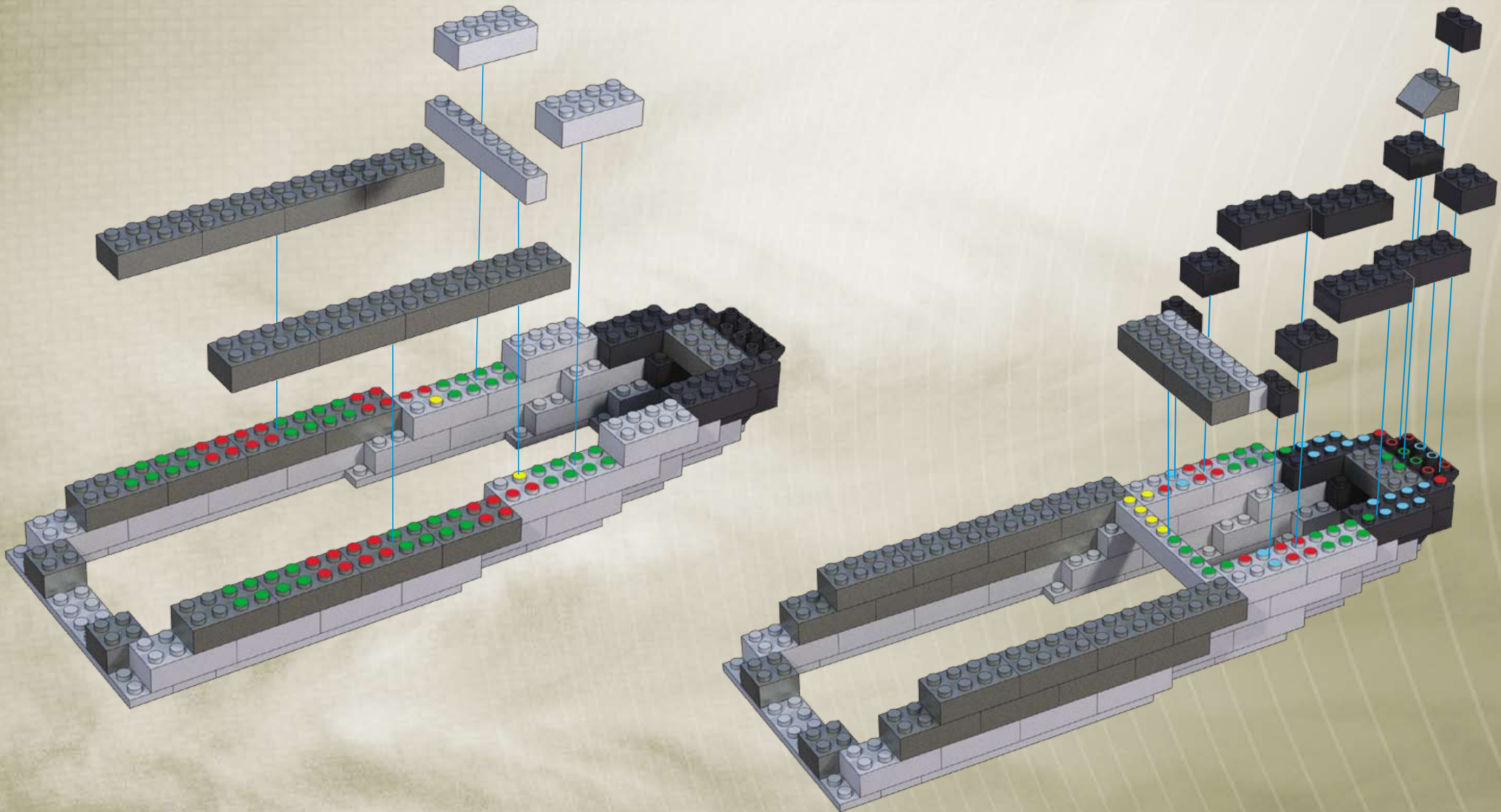

- A** 1x
- B** 1x 2x
- C** 3x 4x 4x

10

- B** 2x
- 1x
- 3x
- C** 8x

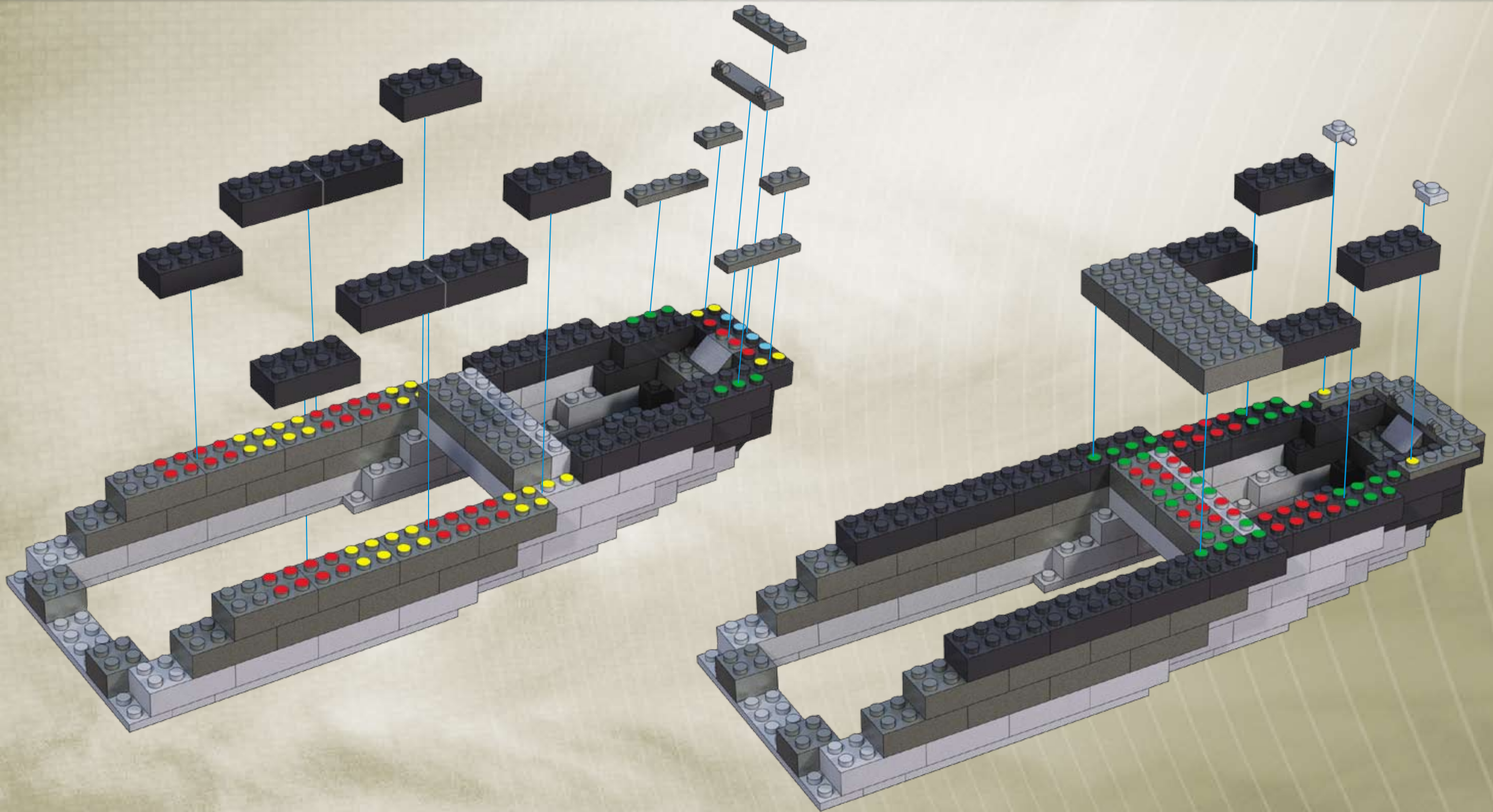

8





- A** 2x
- B** 5x
- C** 4x



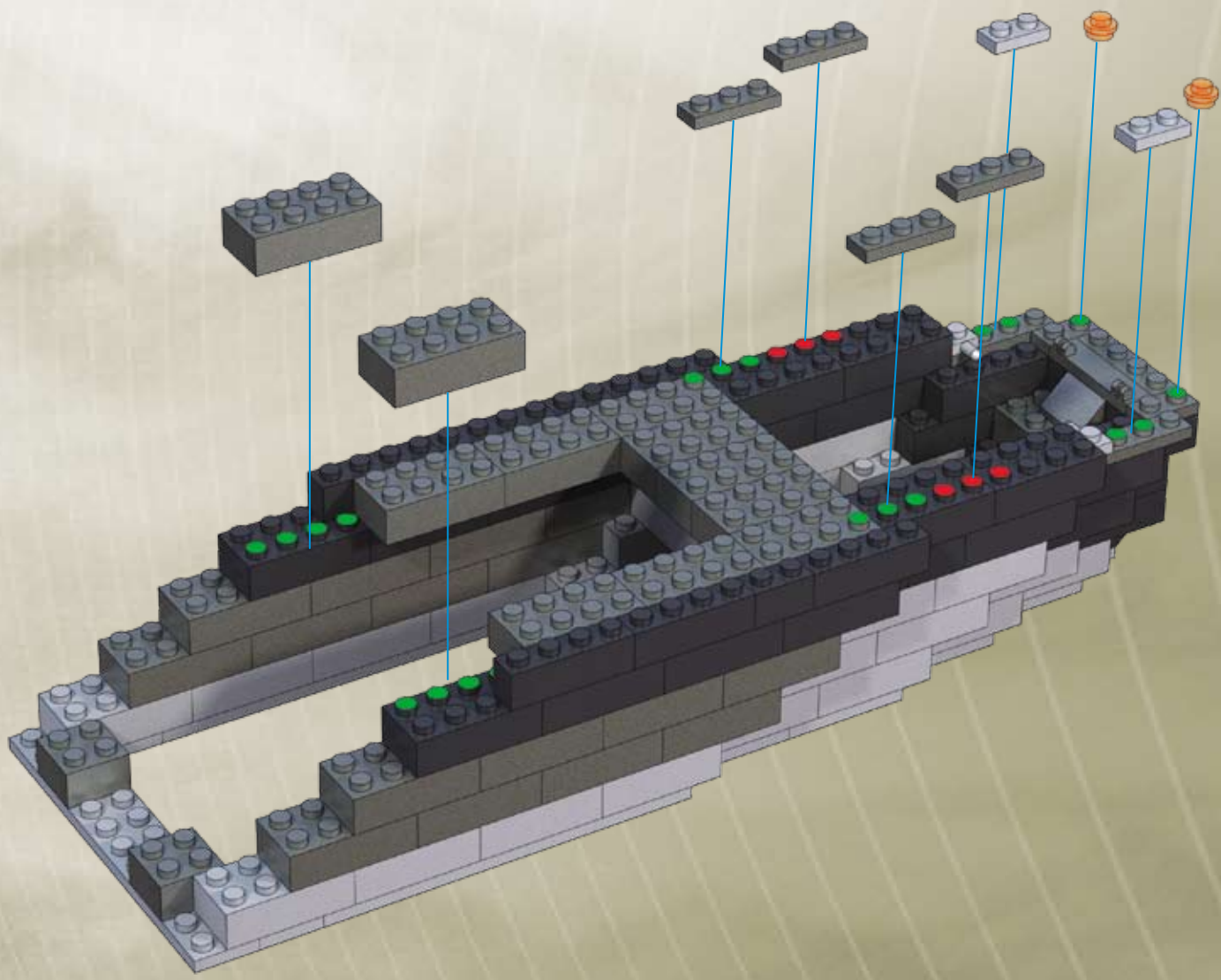
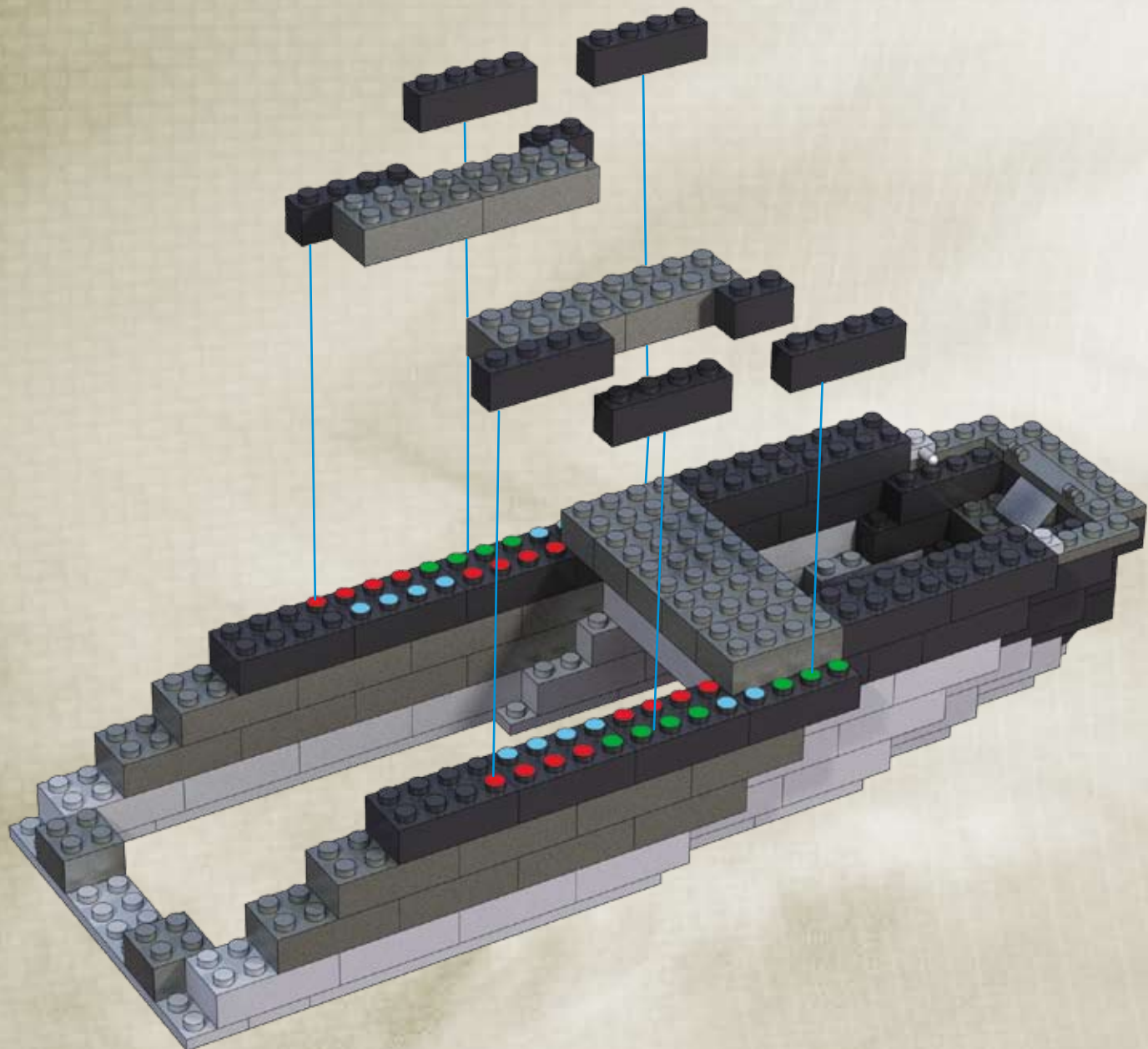

11









- B** 4x 
- C** 2x  6x 

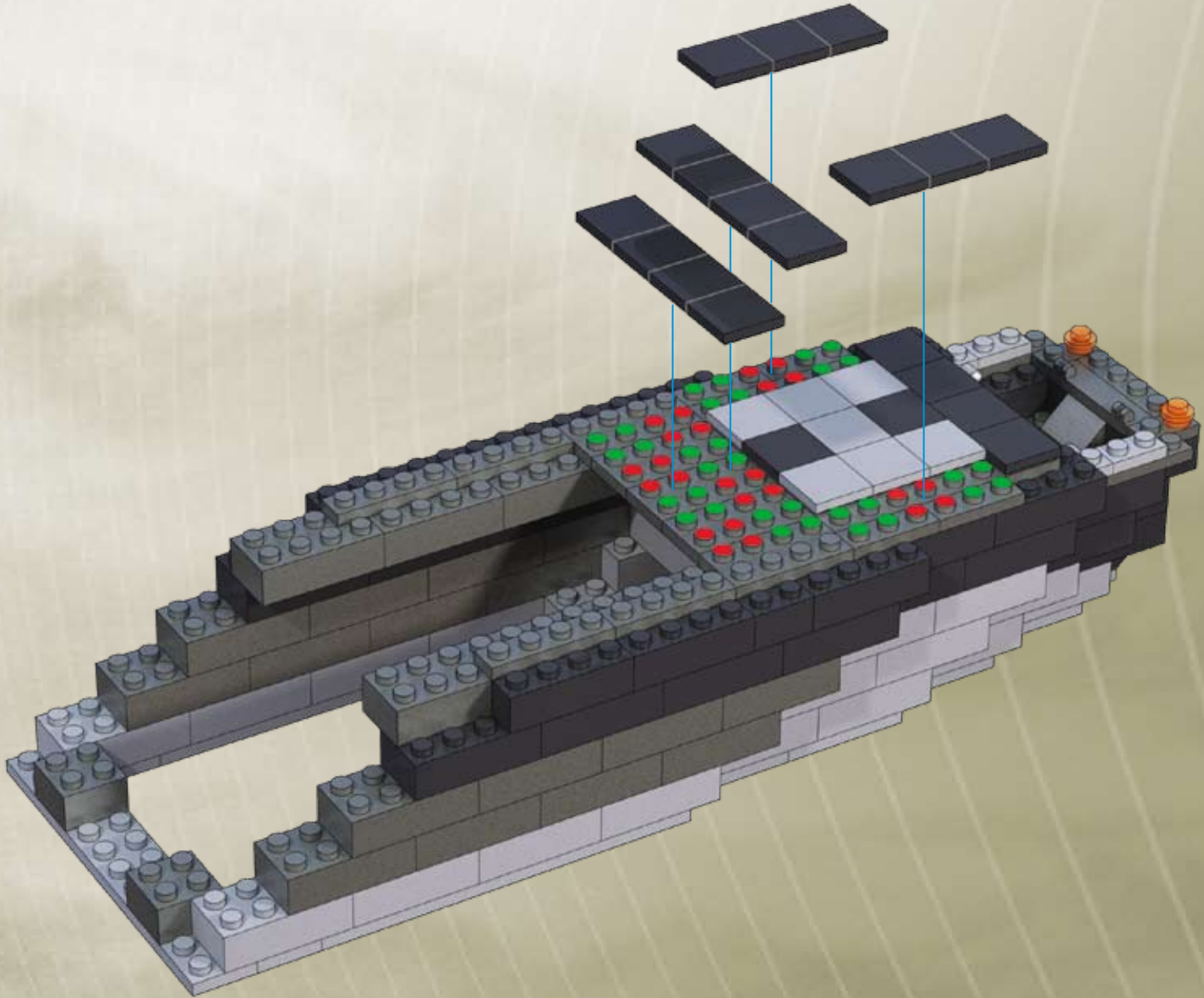
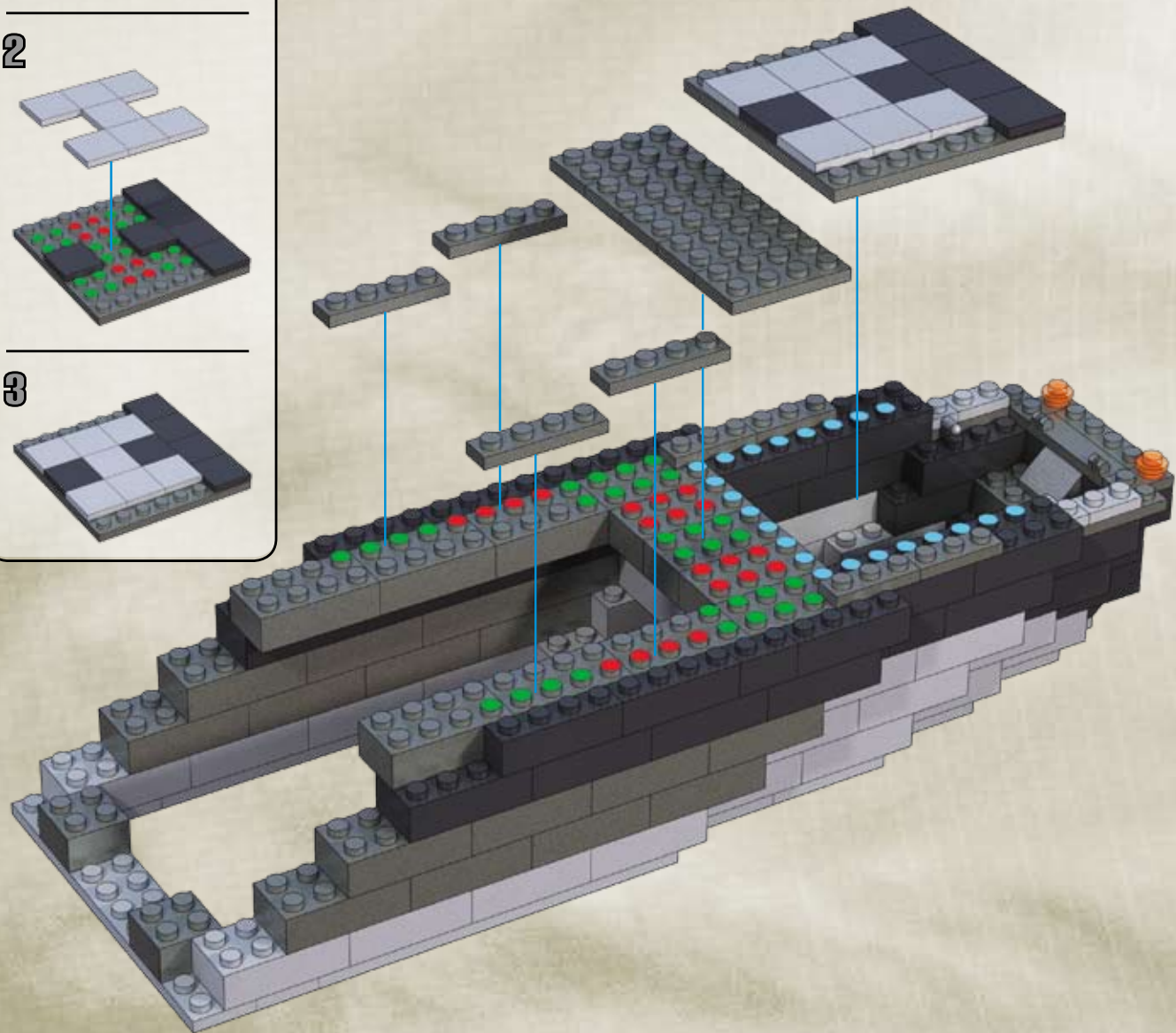
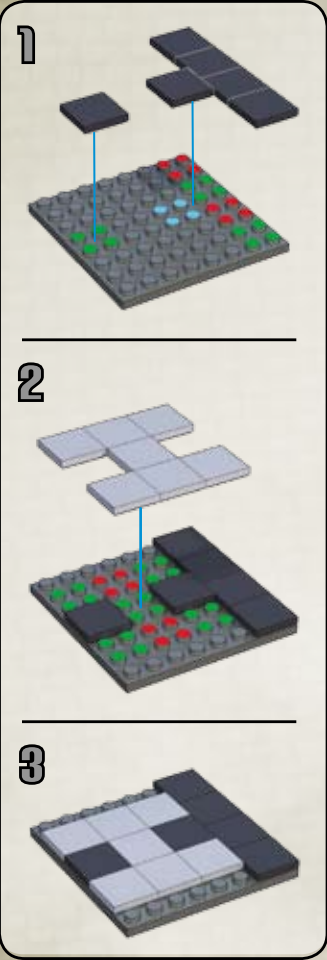



- A** 2x 
- B** 4x  2x 
- D** 2x 

- A**  7x
- B**  4x     5x     1x
- C**  6x

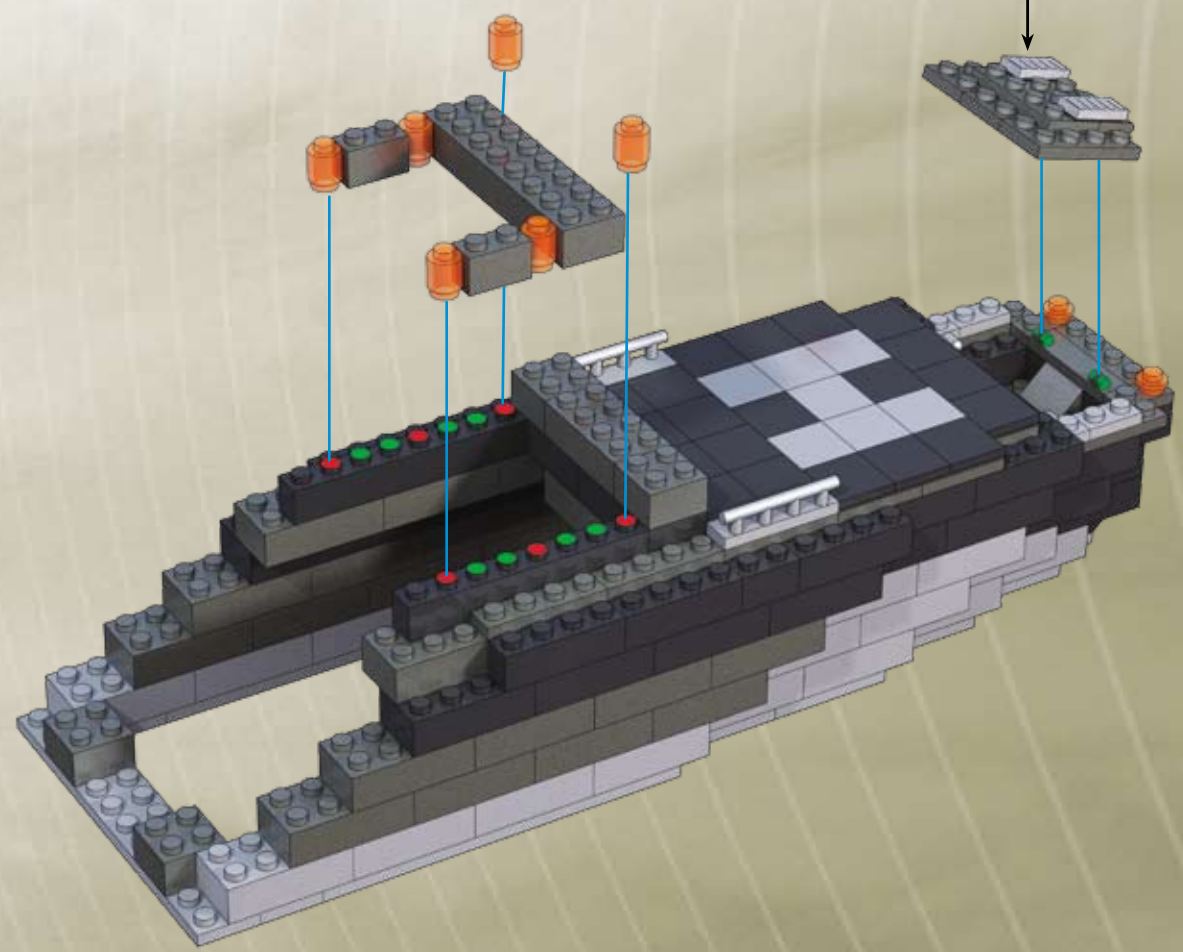
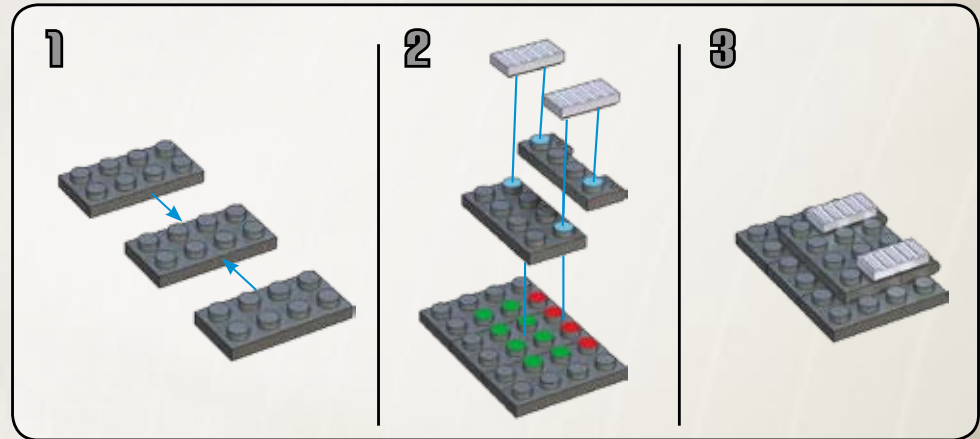
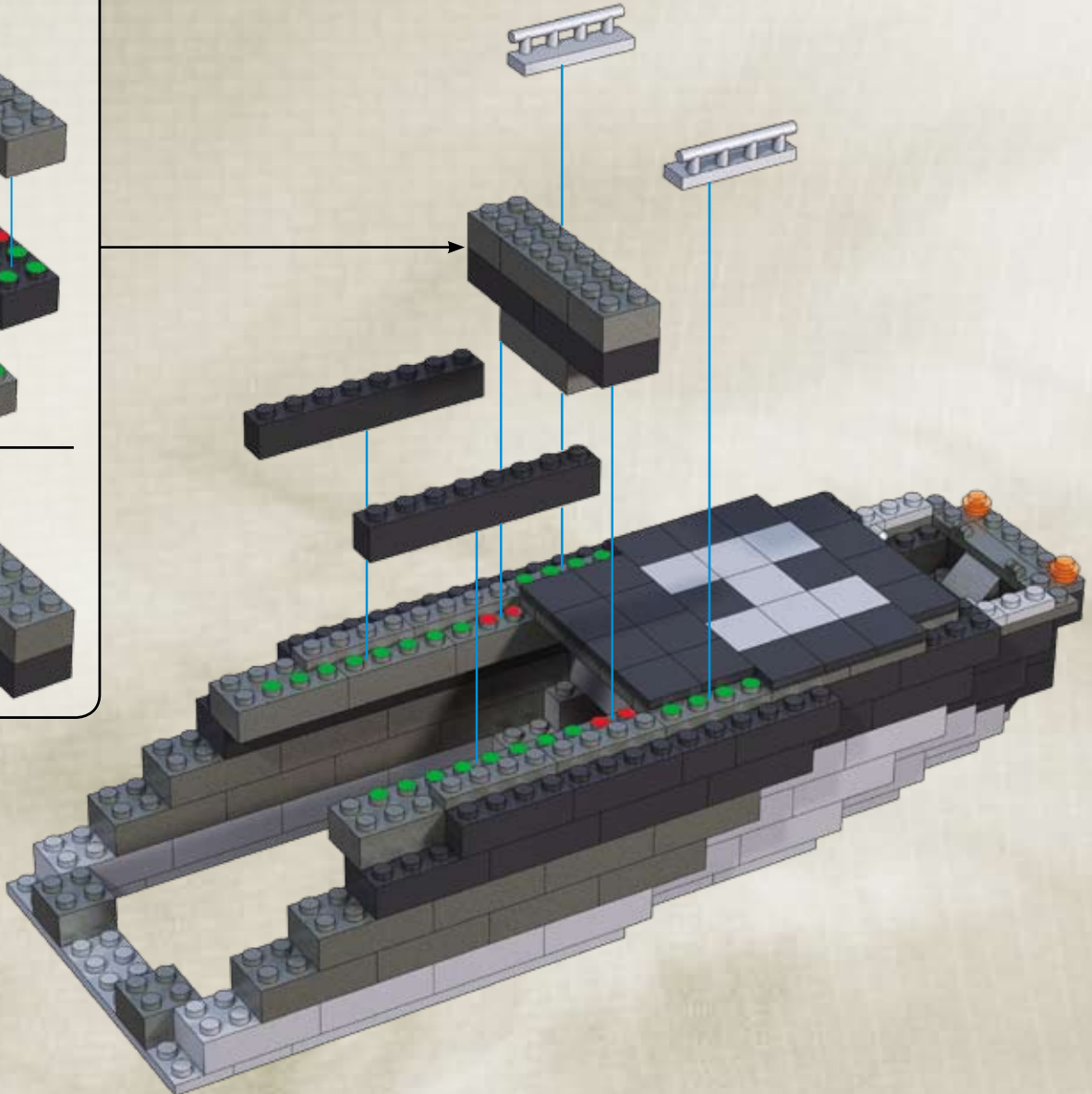
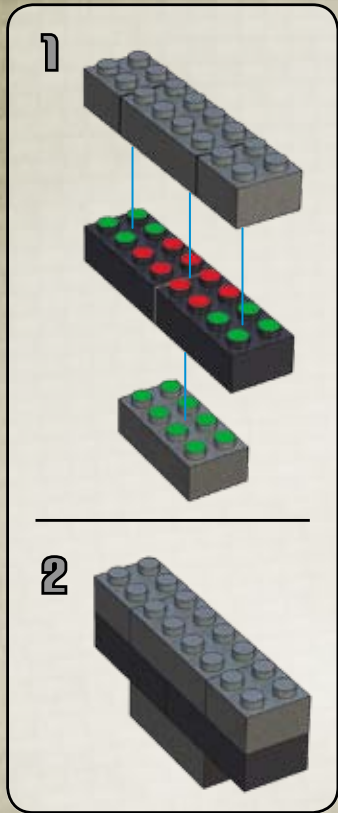

- A**  2x
- B**  2x  2x
- C**  2x  2x



- B**  2x  1x  4x  1x
- D**  6x  2x

- A 2x 2x 2x
- B 2x
- D 2x

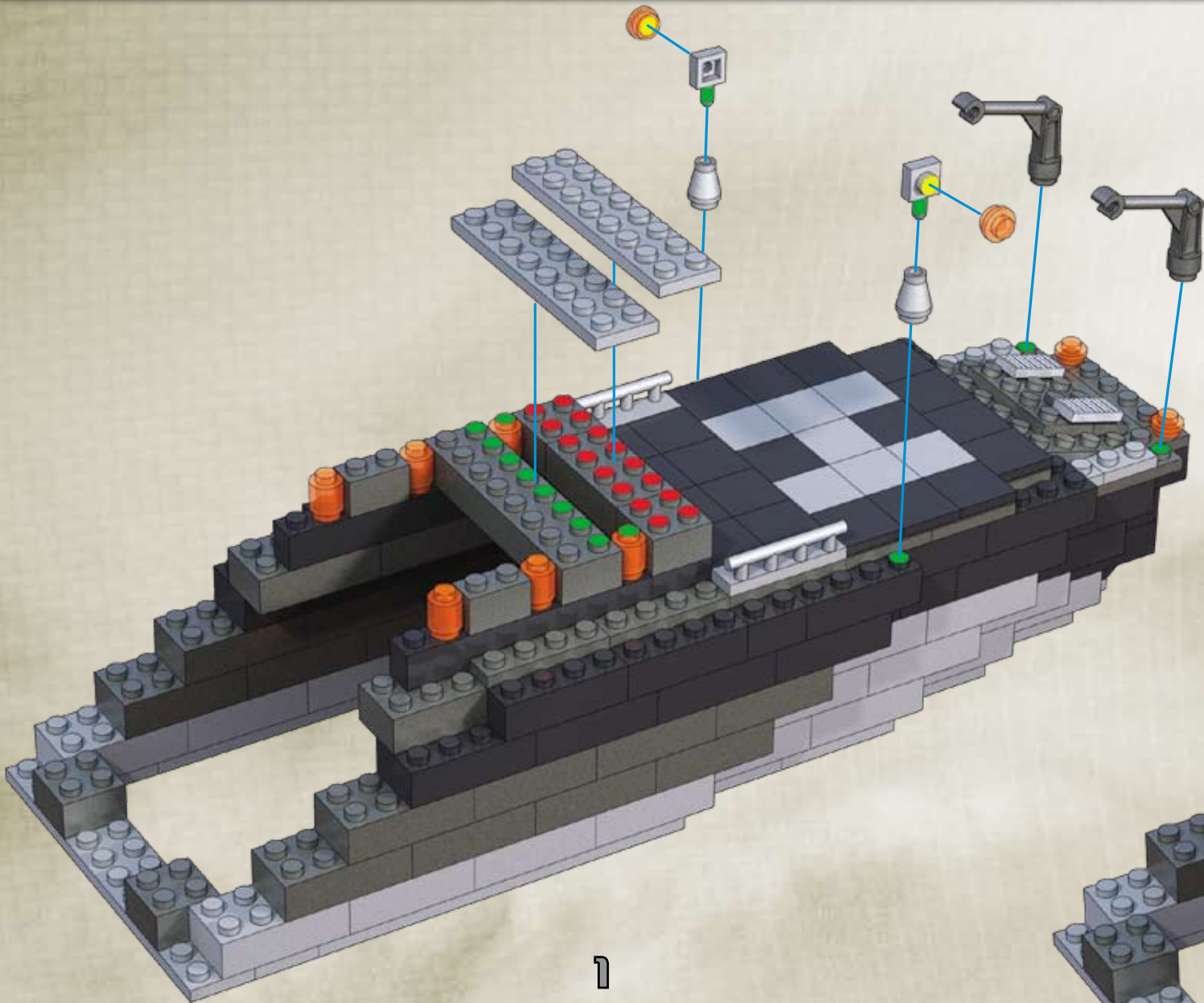

1

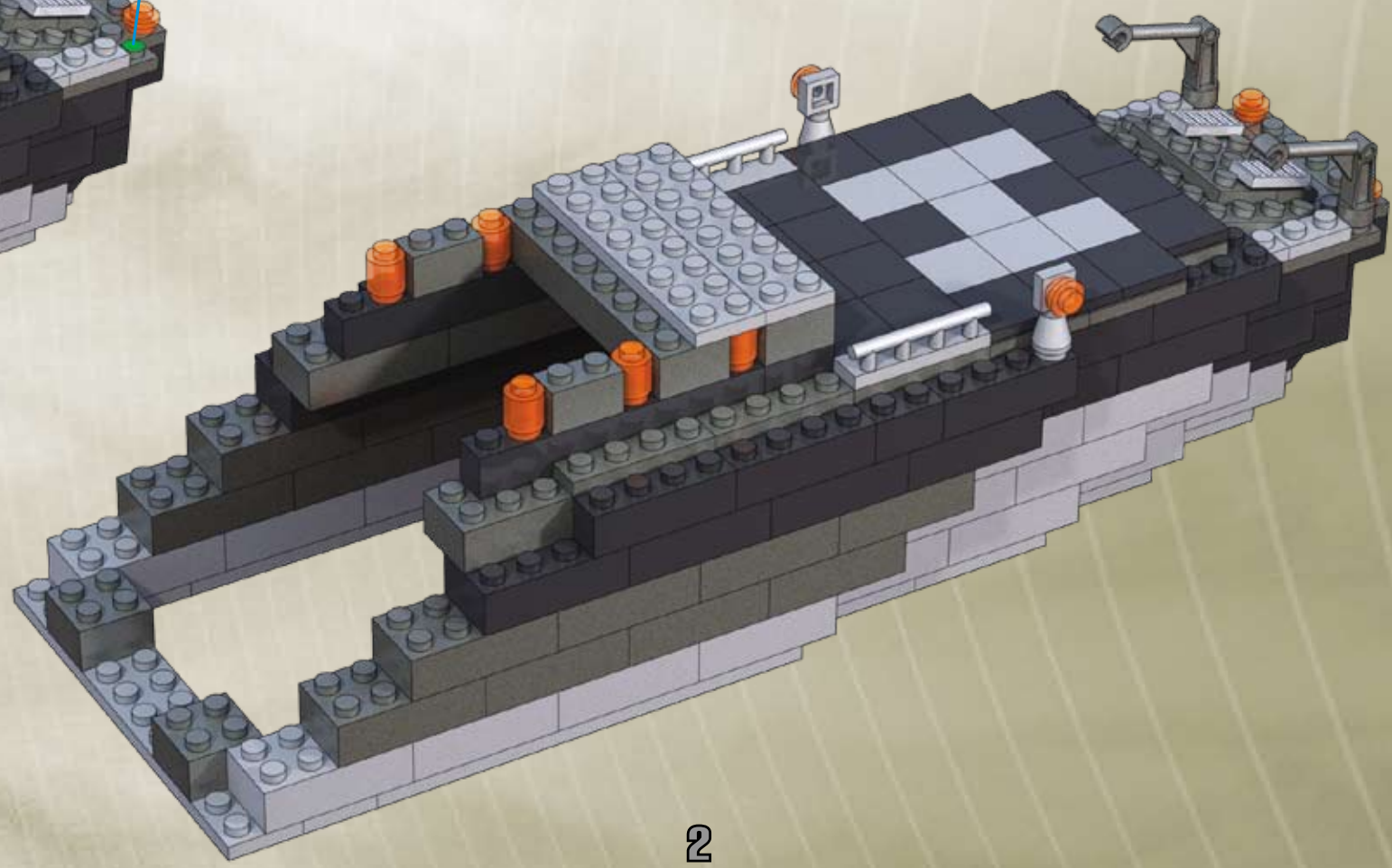

2

1

- 1x
- 1x
- 1x
- 4x
- 4x

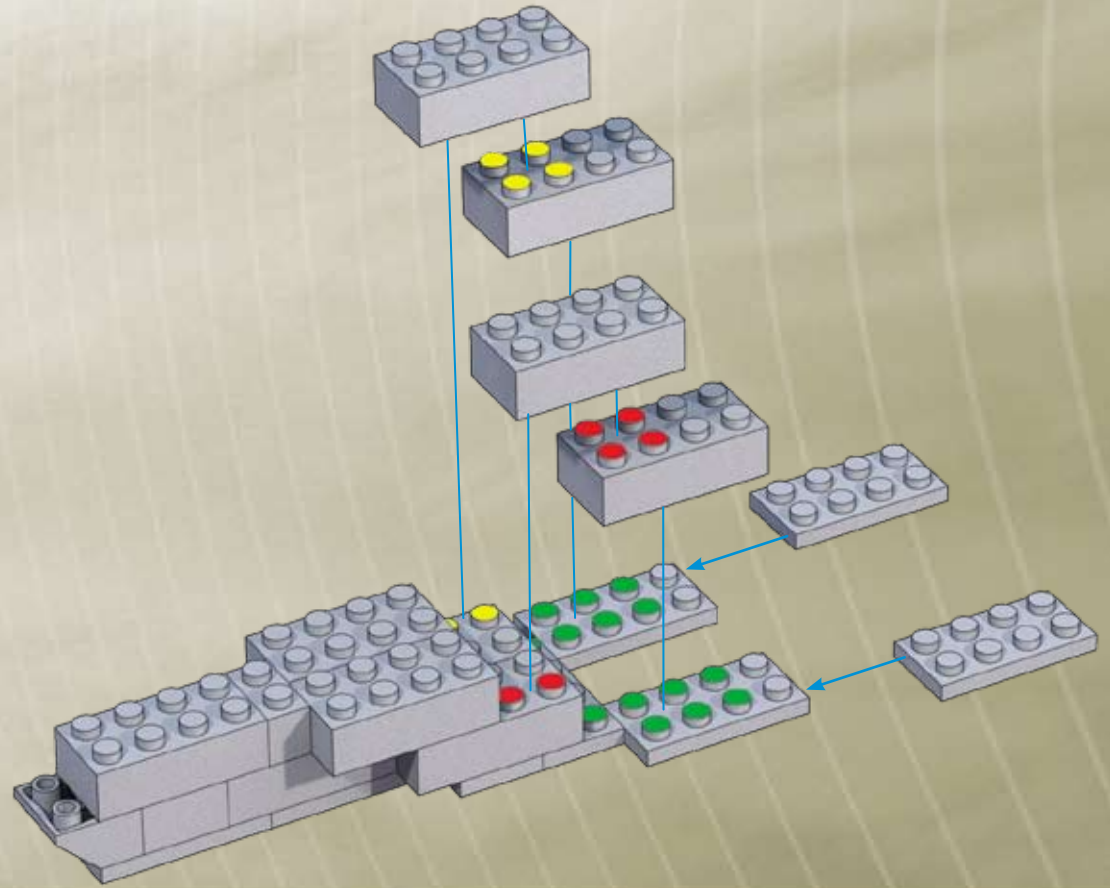
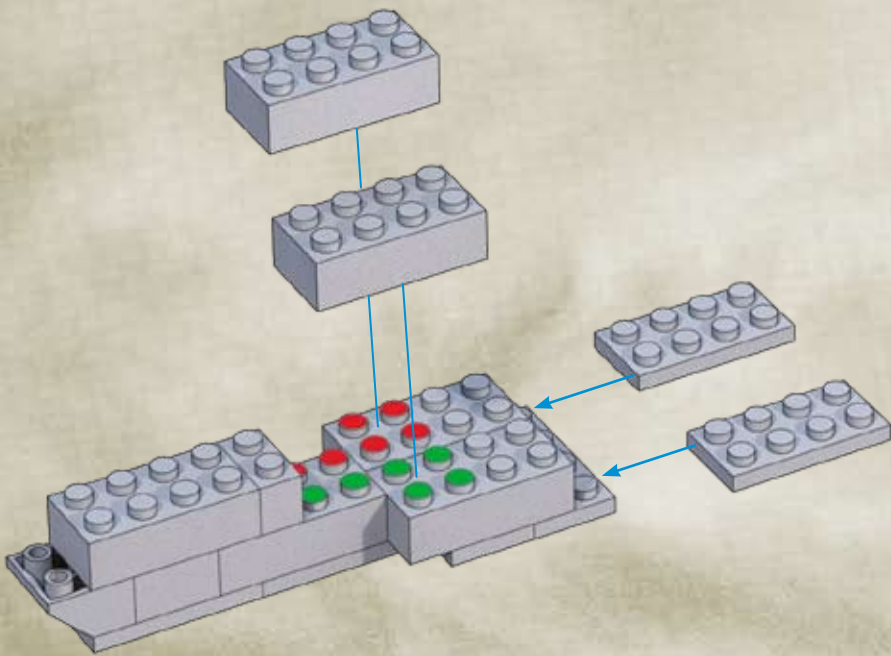
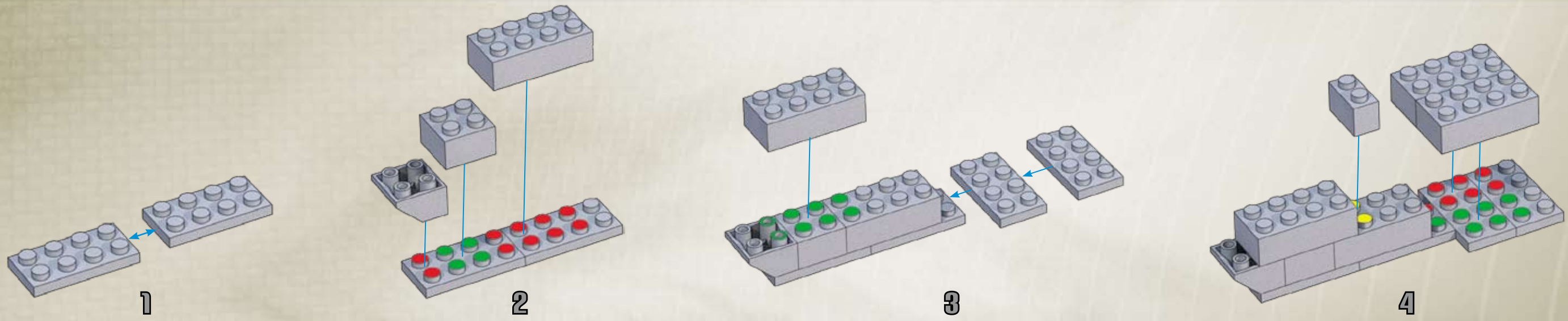

2

- 2x
- 2x

- 2x
- 4x

3

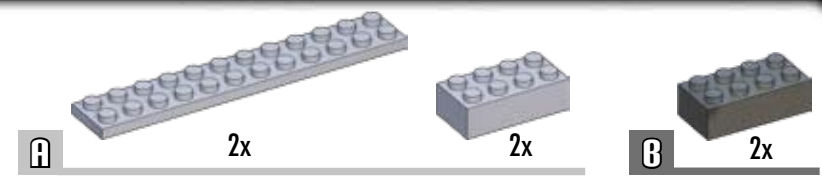
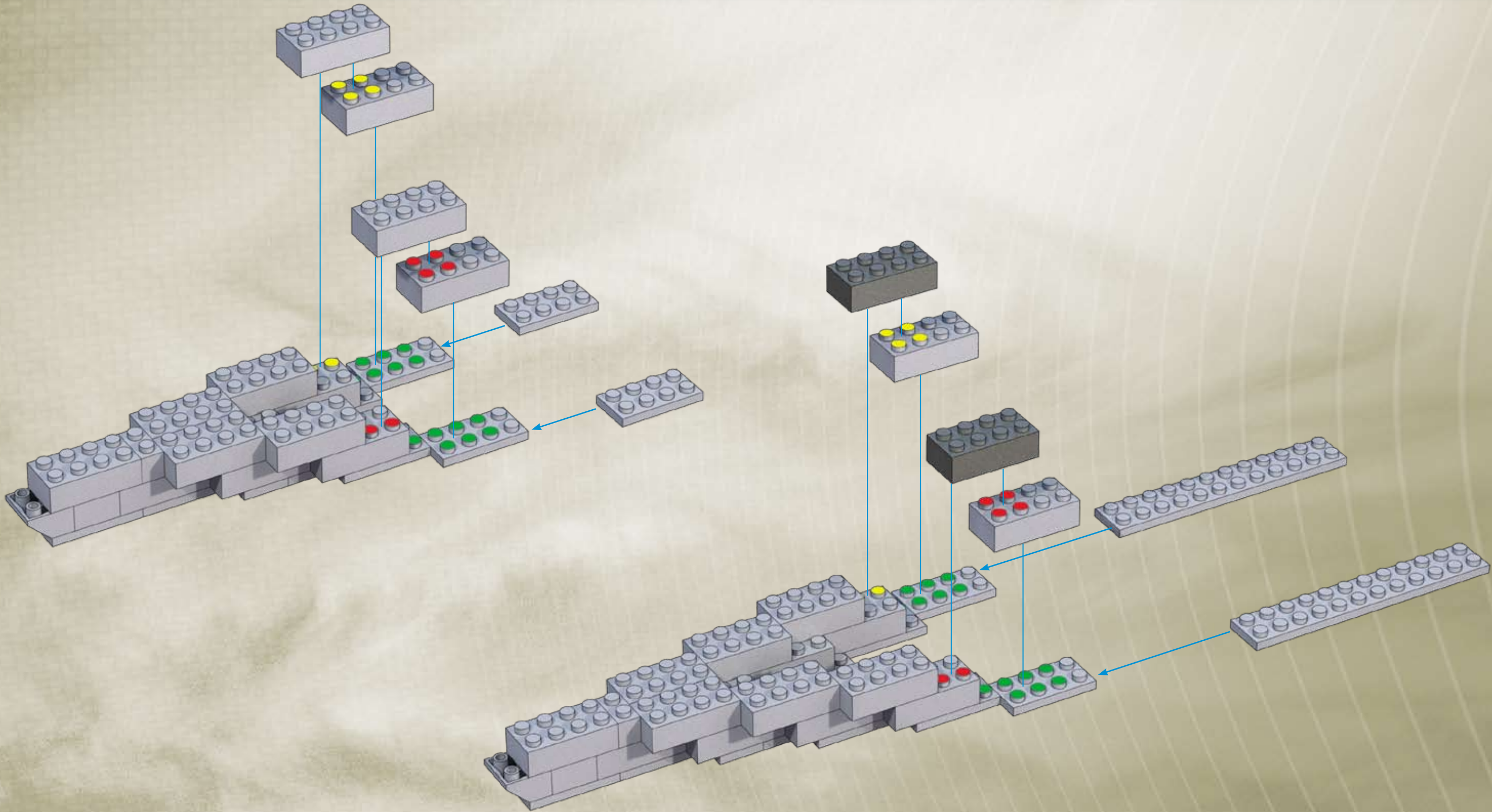
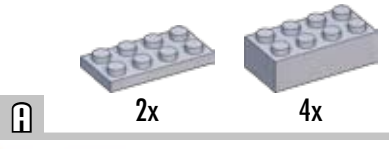

- A 2x
- B 2x

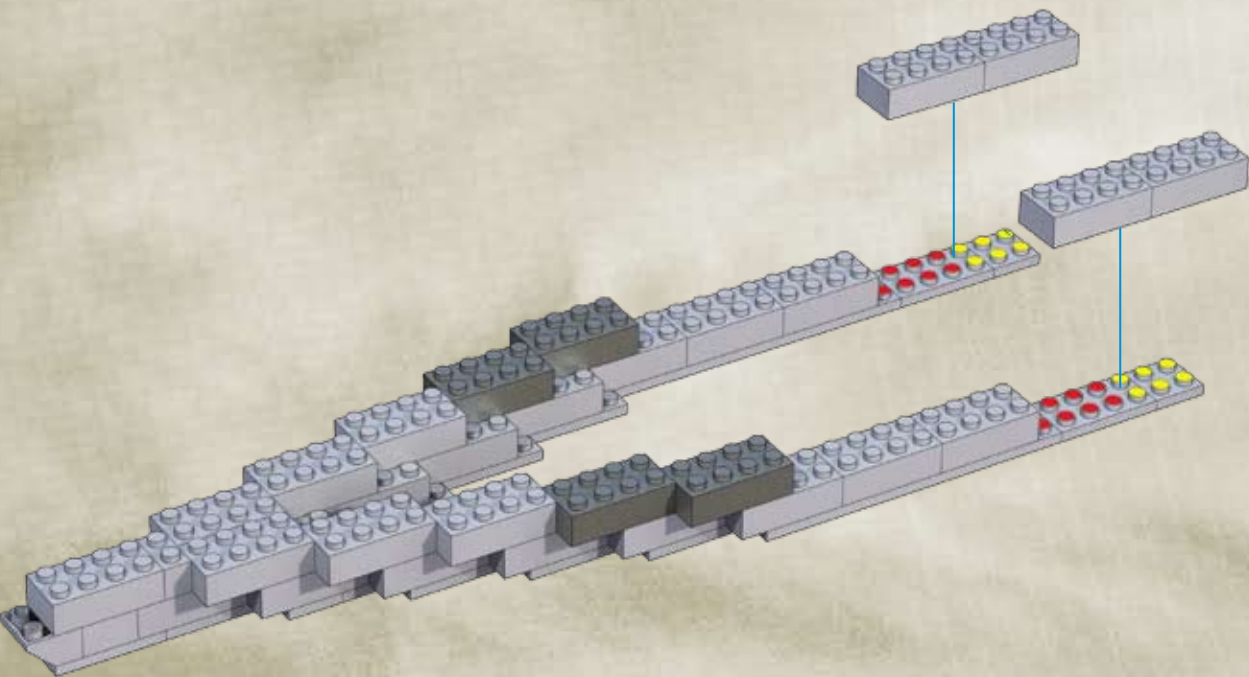
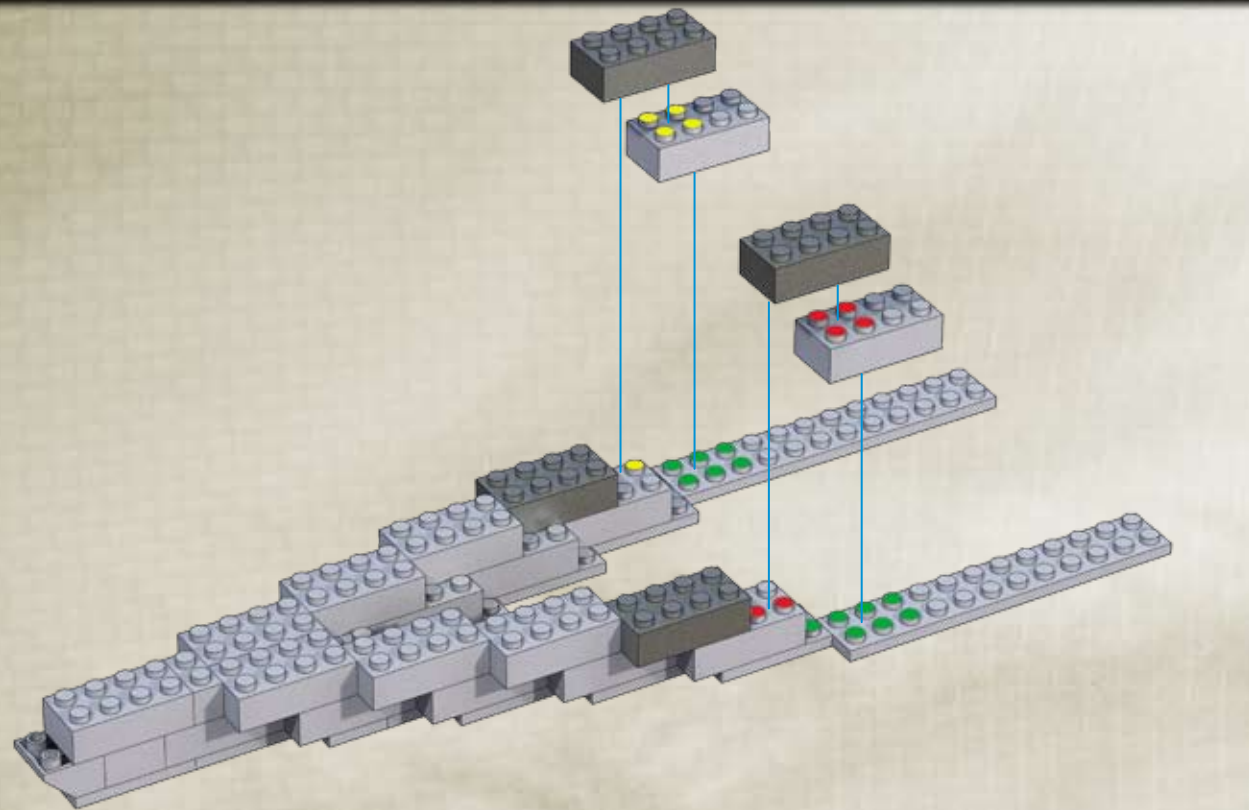

- A 4x
- B 2x
- C 2x

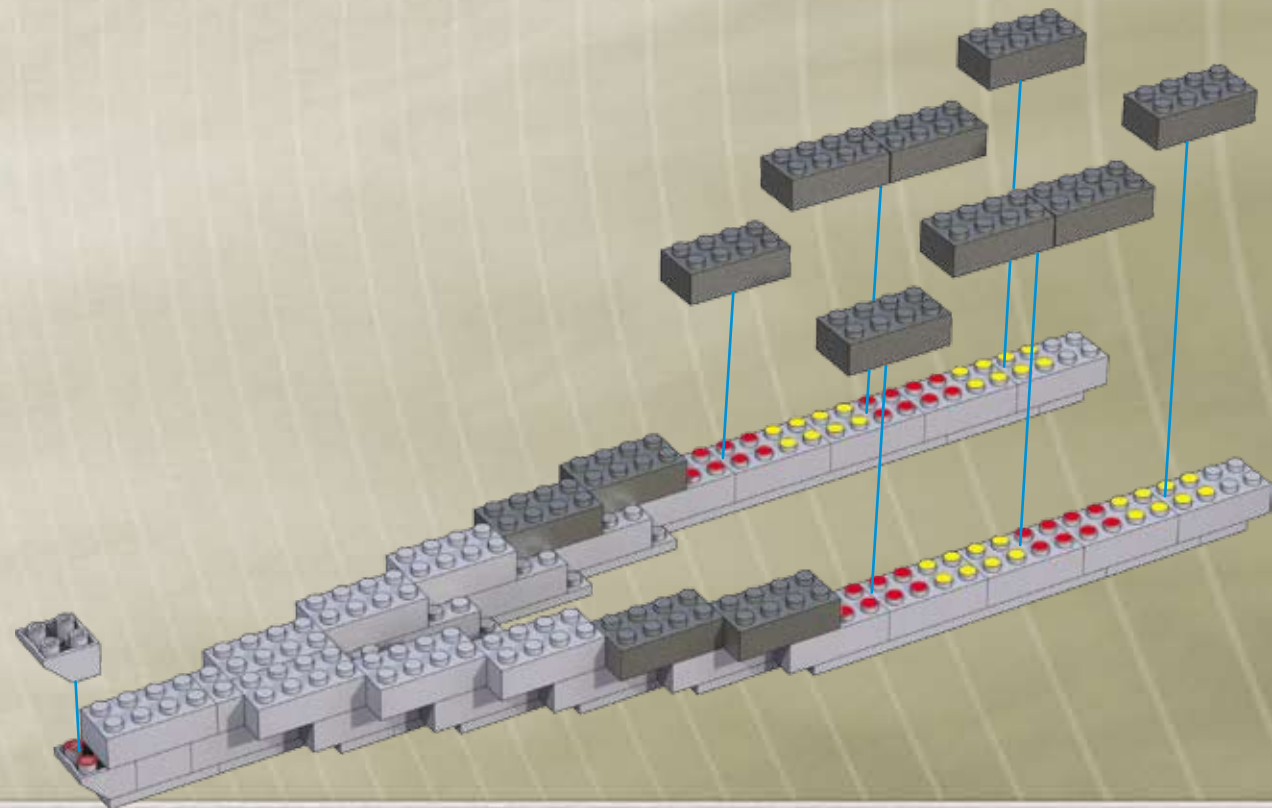
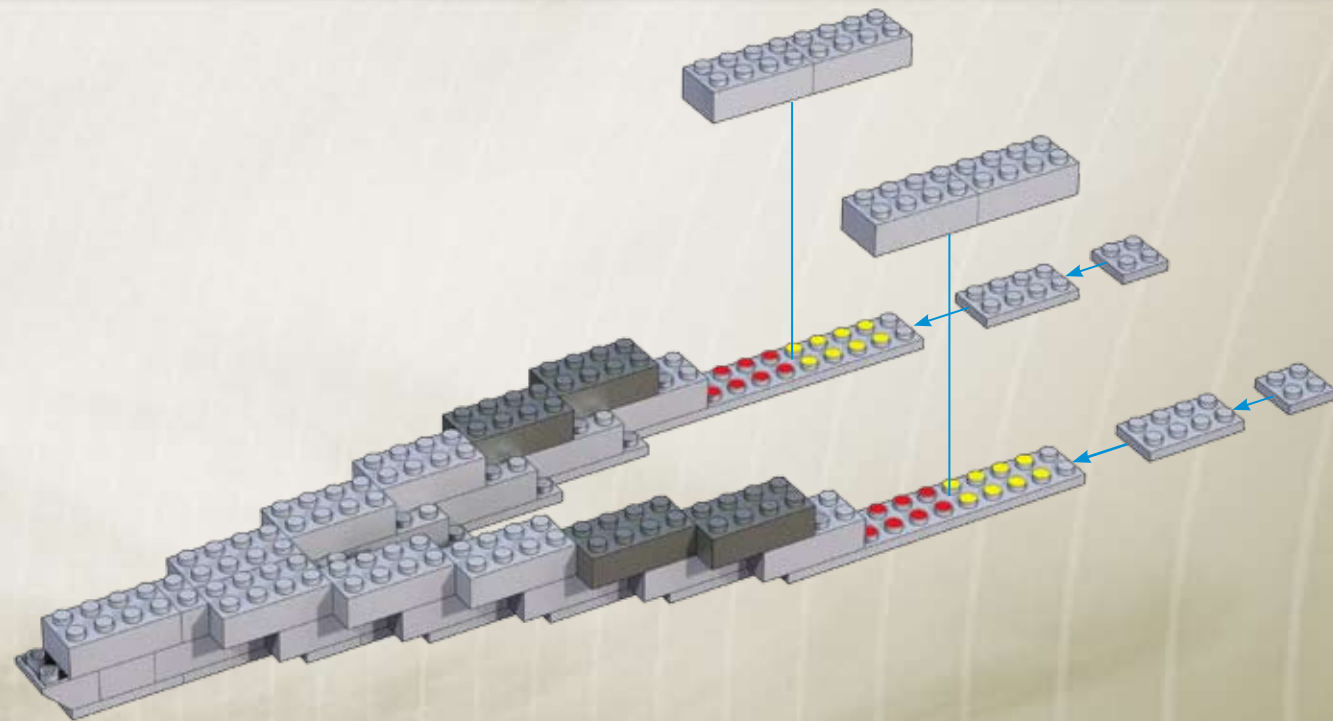

- A 4x



- A 1x
- B 8x



- A 5x
- B 5x

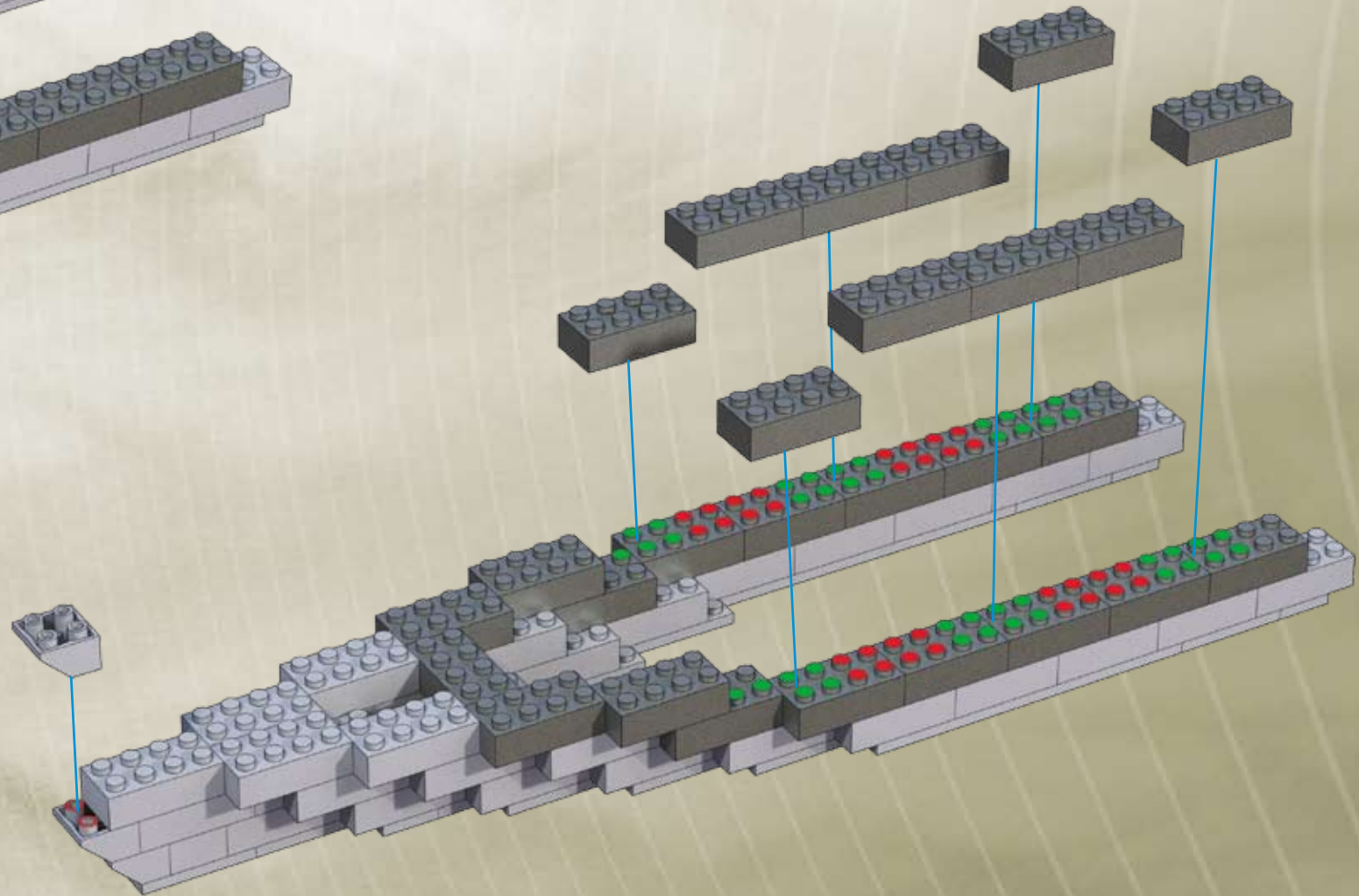
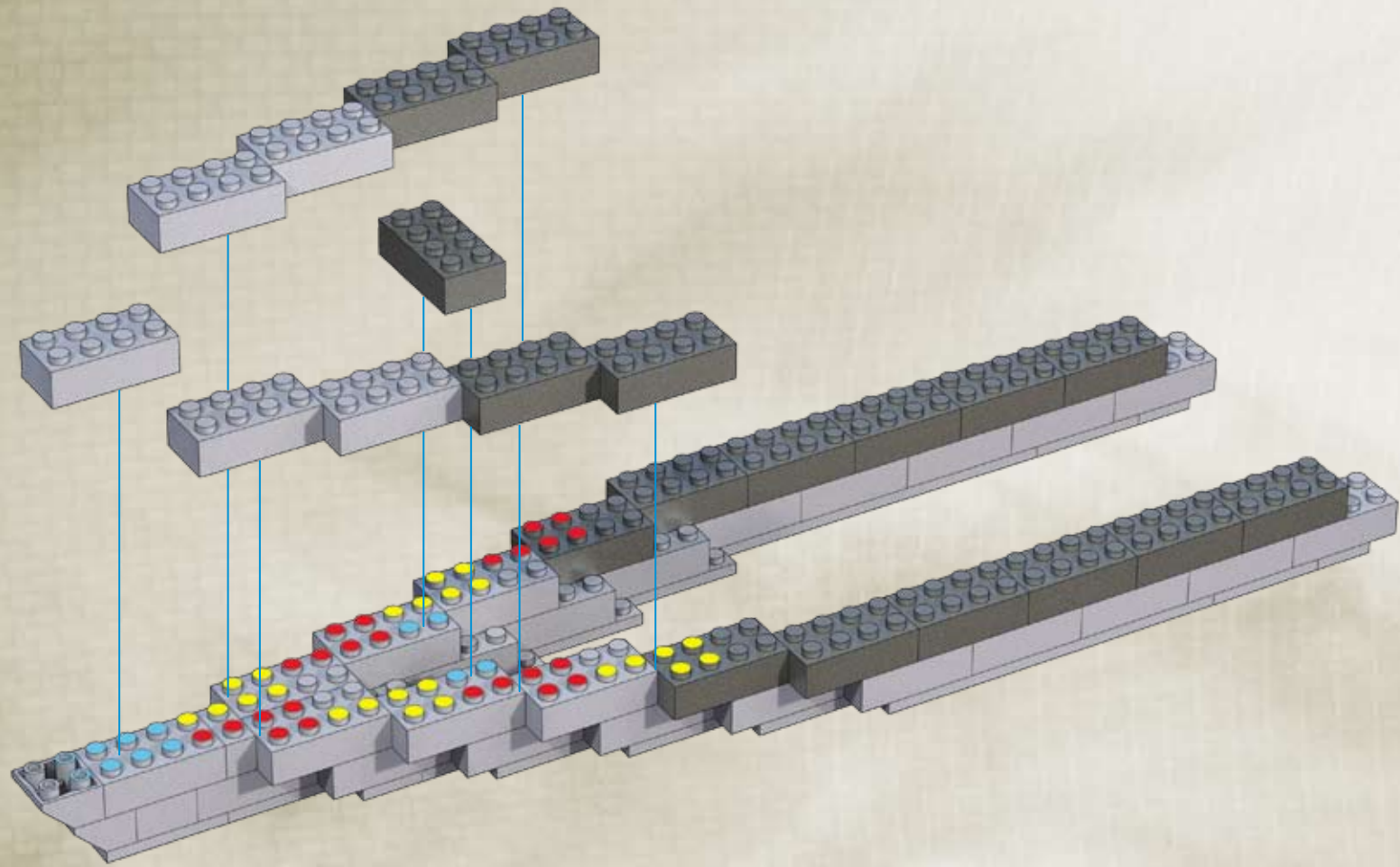

- A 1x
- B 10x



12

- A 1x 1x
- B 1x
- C 8x

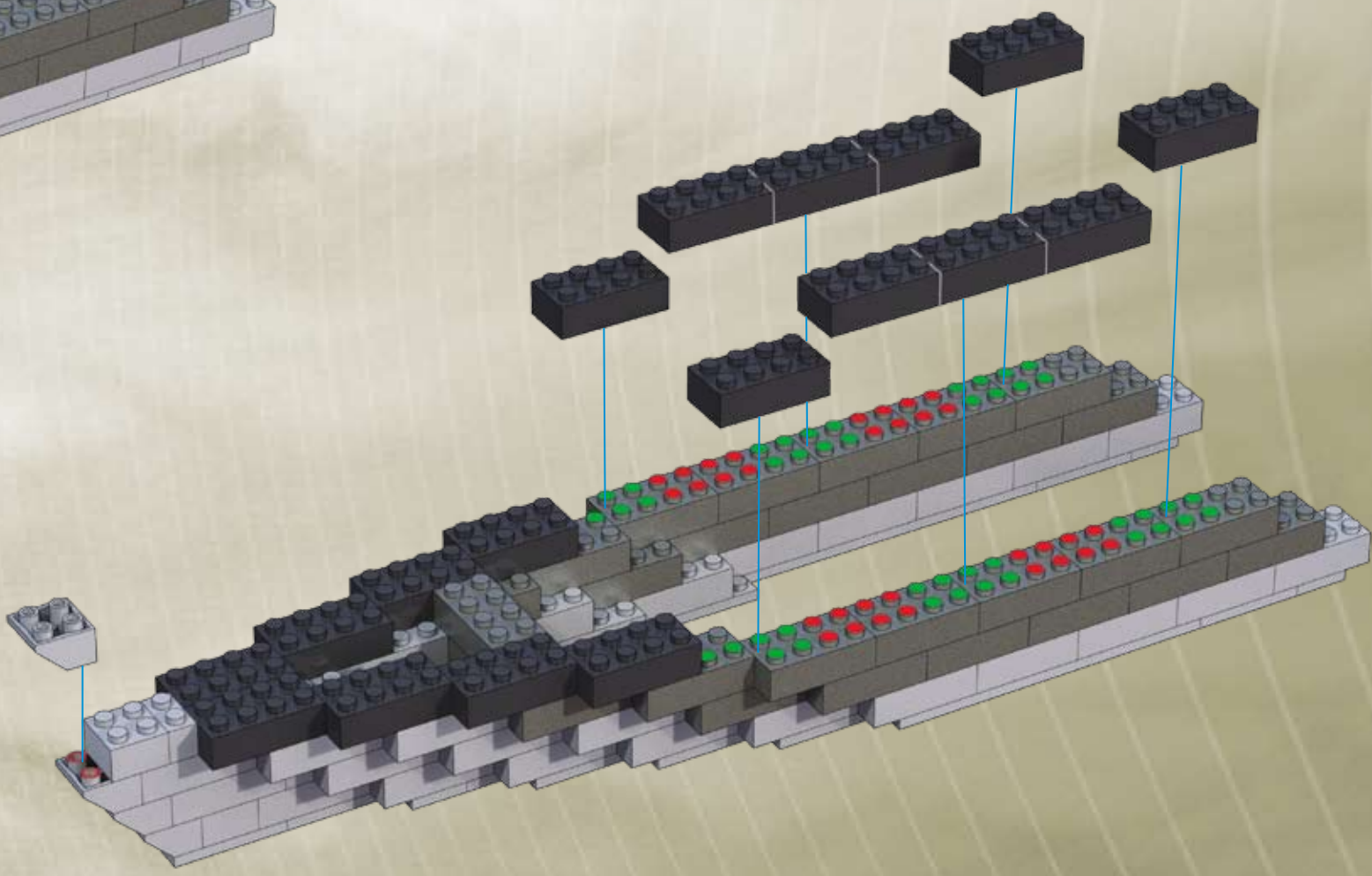
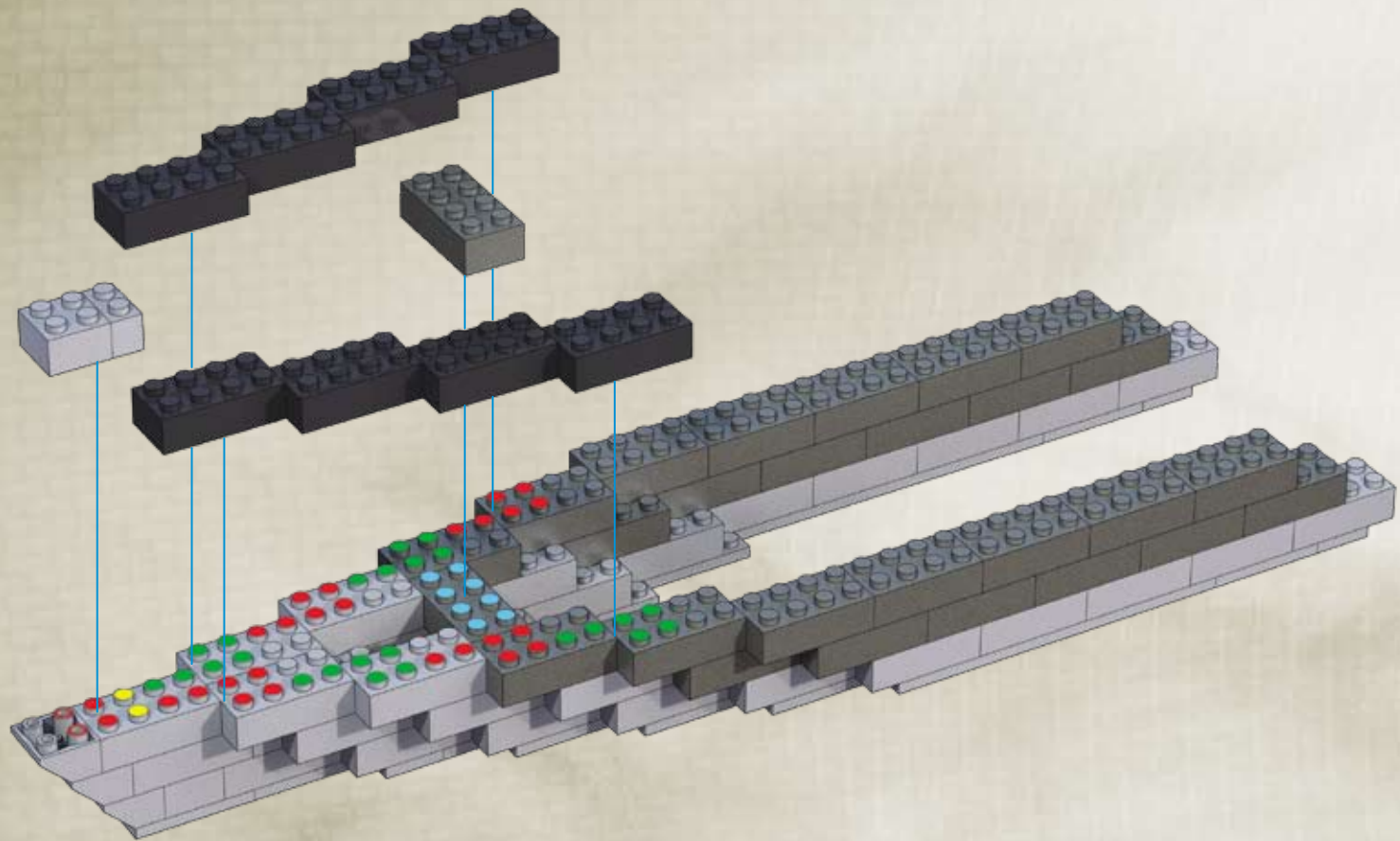

17

- A 1x
- C 10x

13

- A** 2x 2x 2x
- B** 1x 2x
- C** 10x

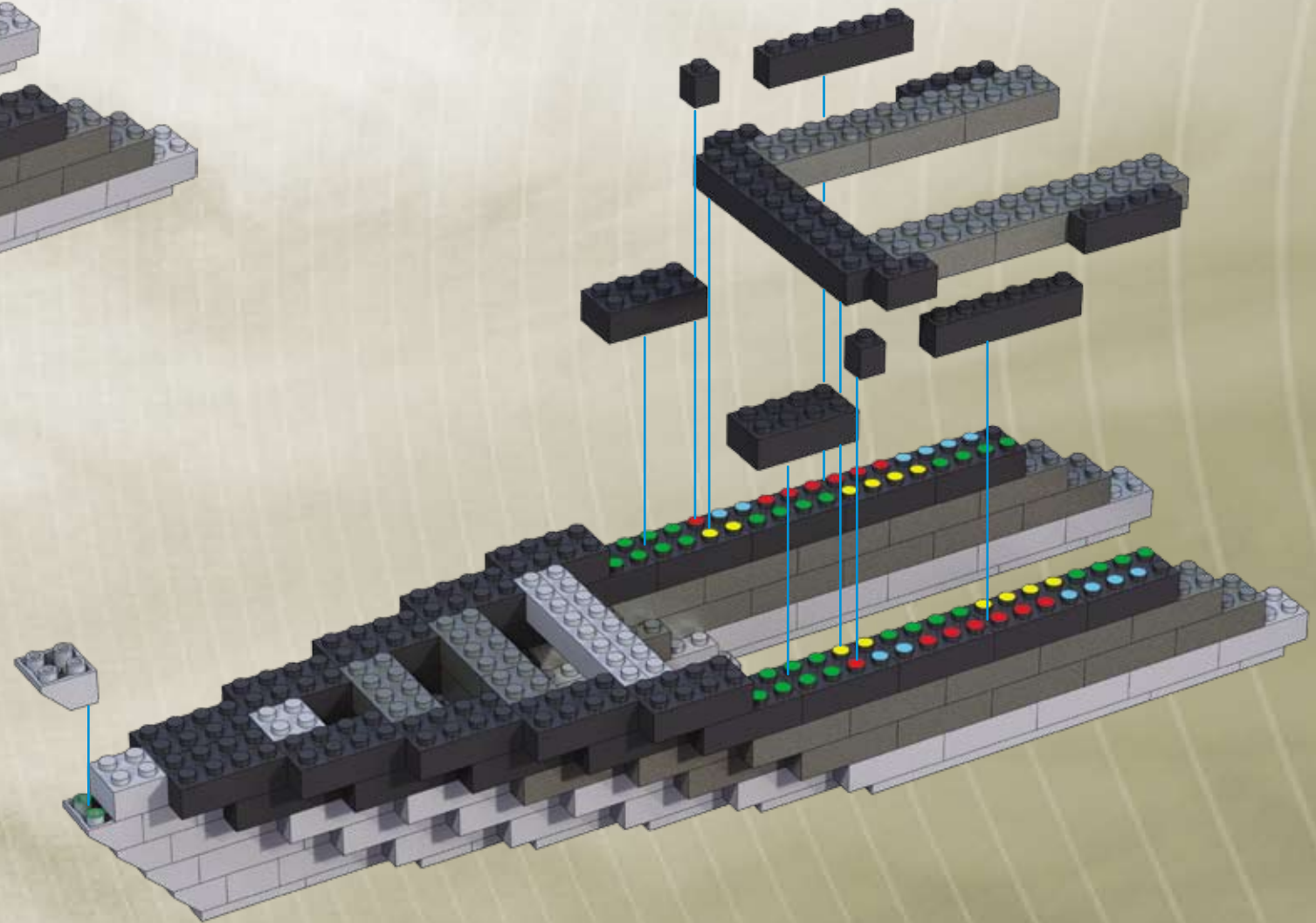
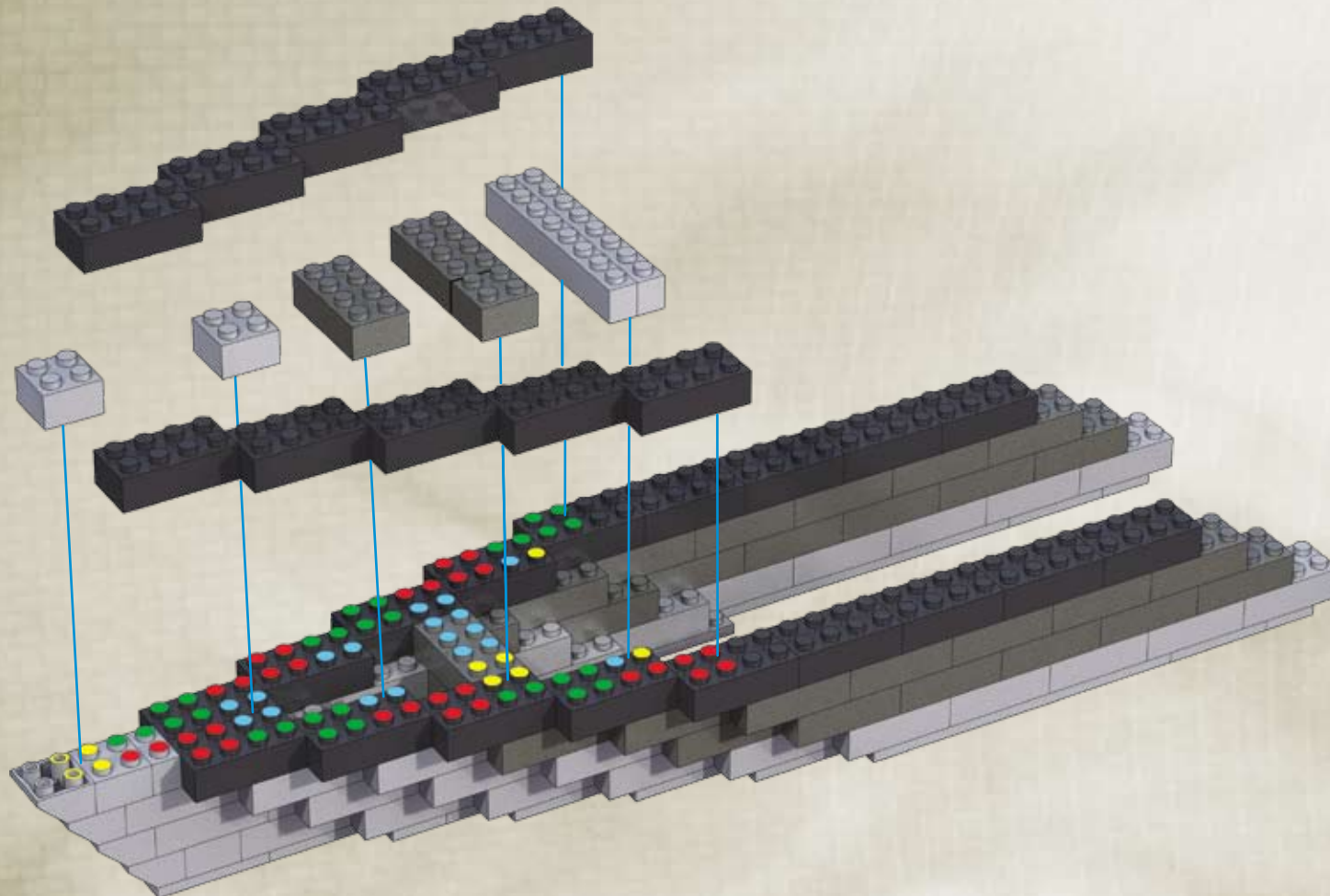

- A** 1x
- B** 6x
- C** 2x 2x 2x 2x 2x 1x

16

8x 4x

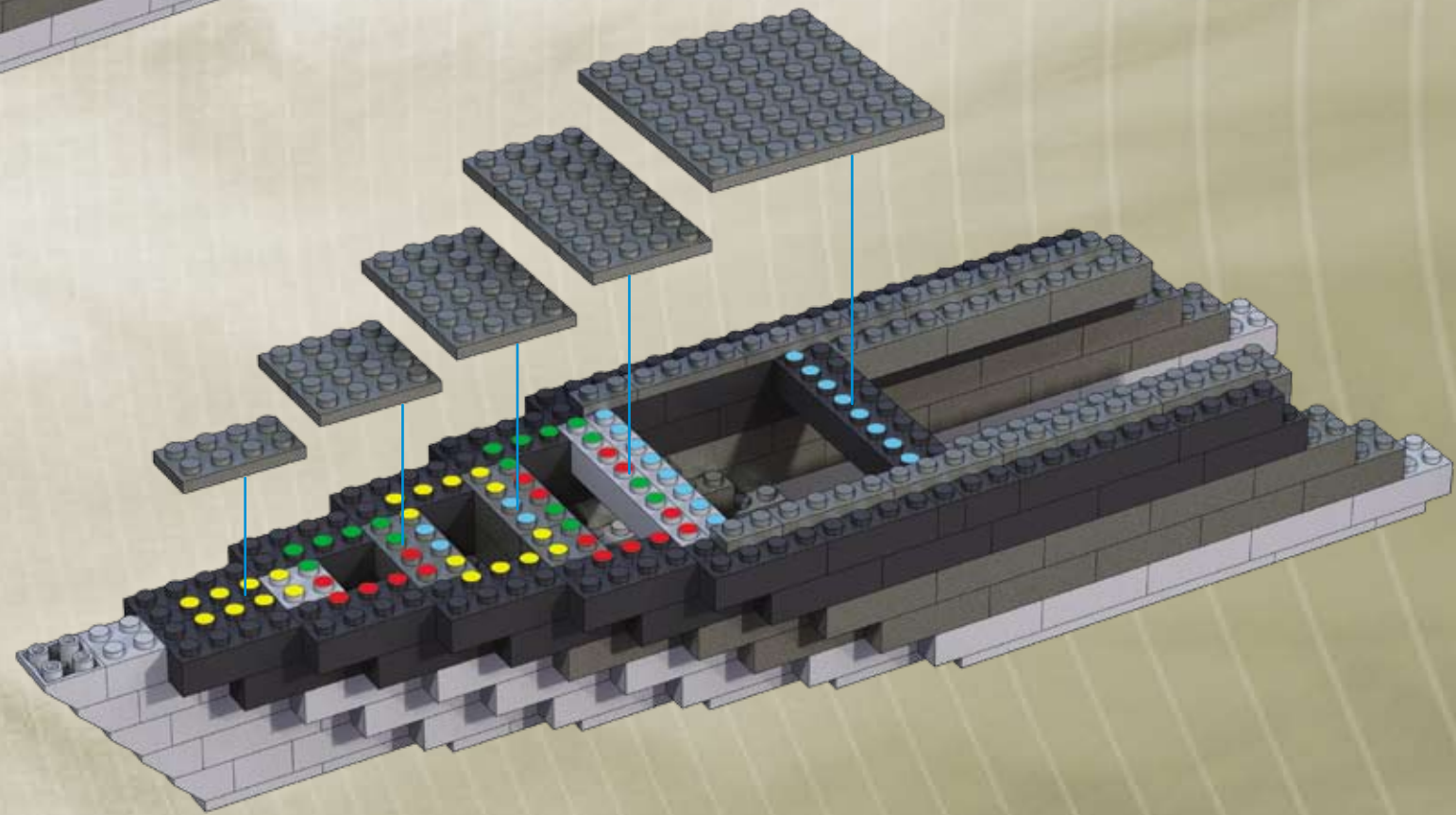
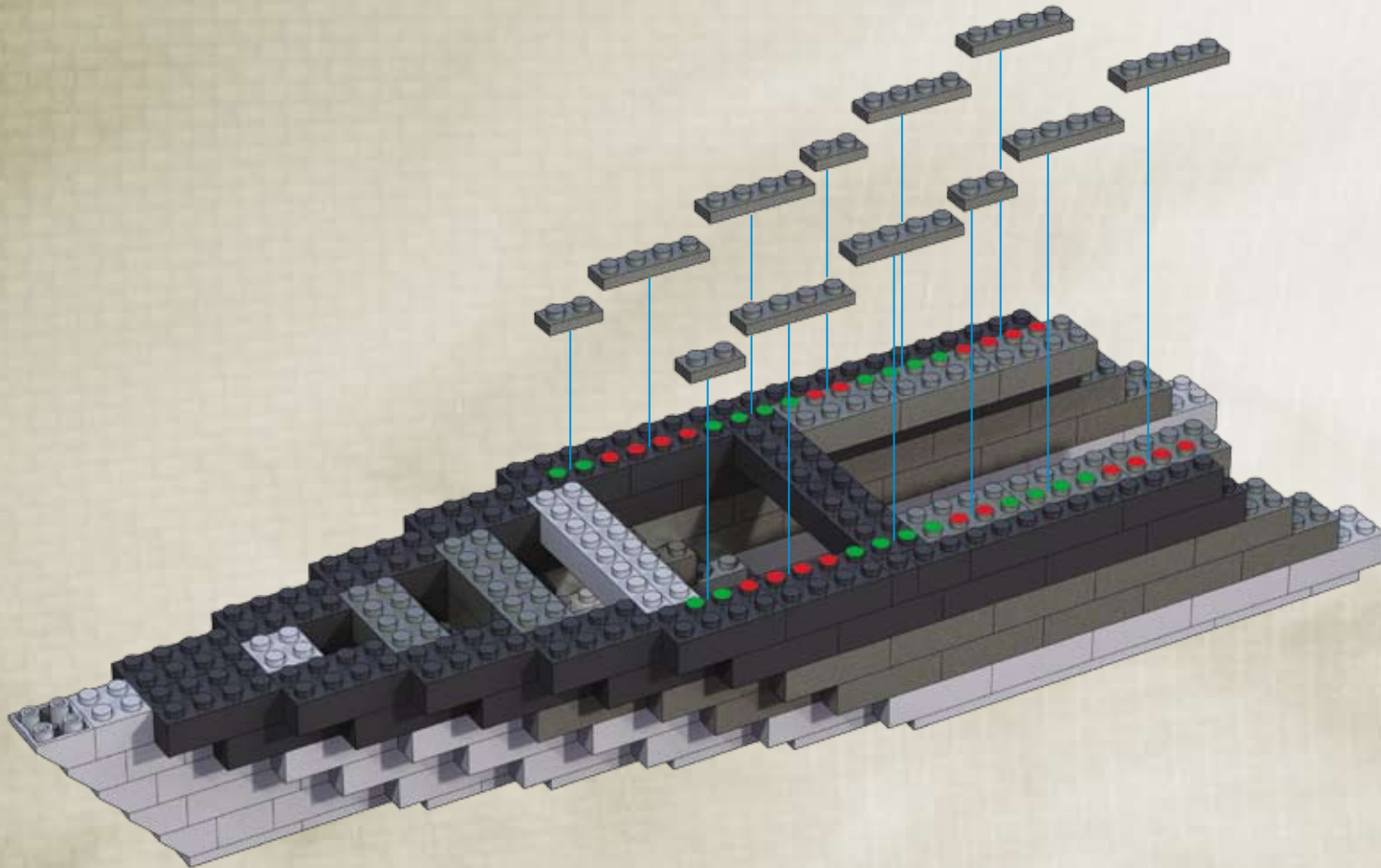

19

1x 10x

17

- C** 2x
- 3x
- 2x
- 1x

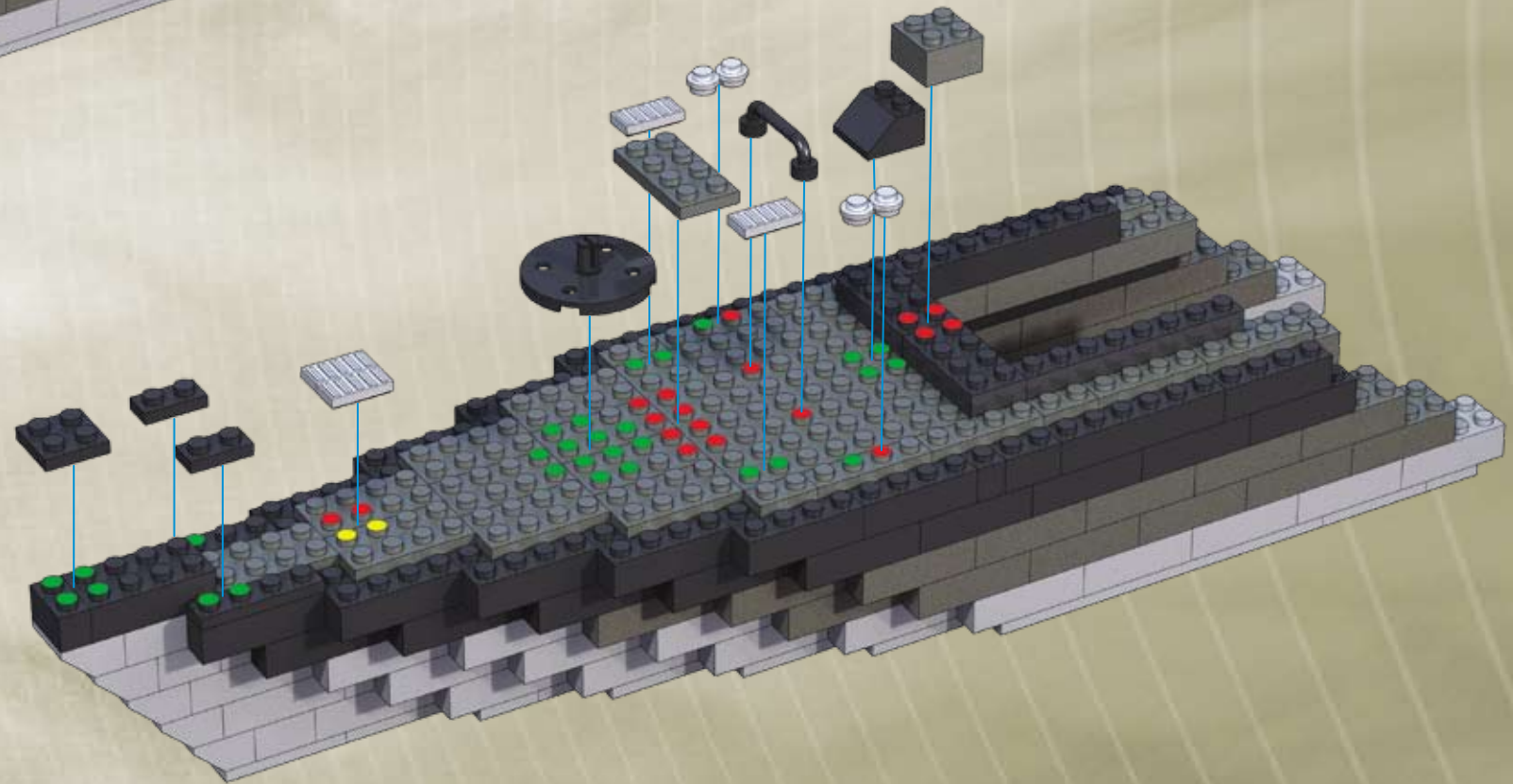
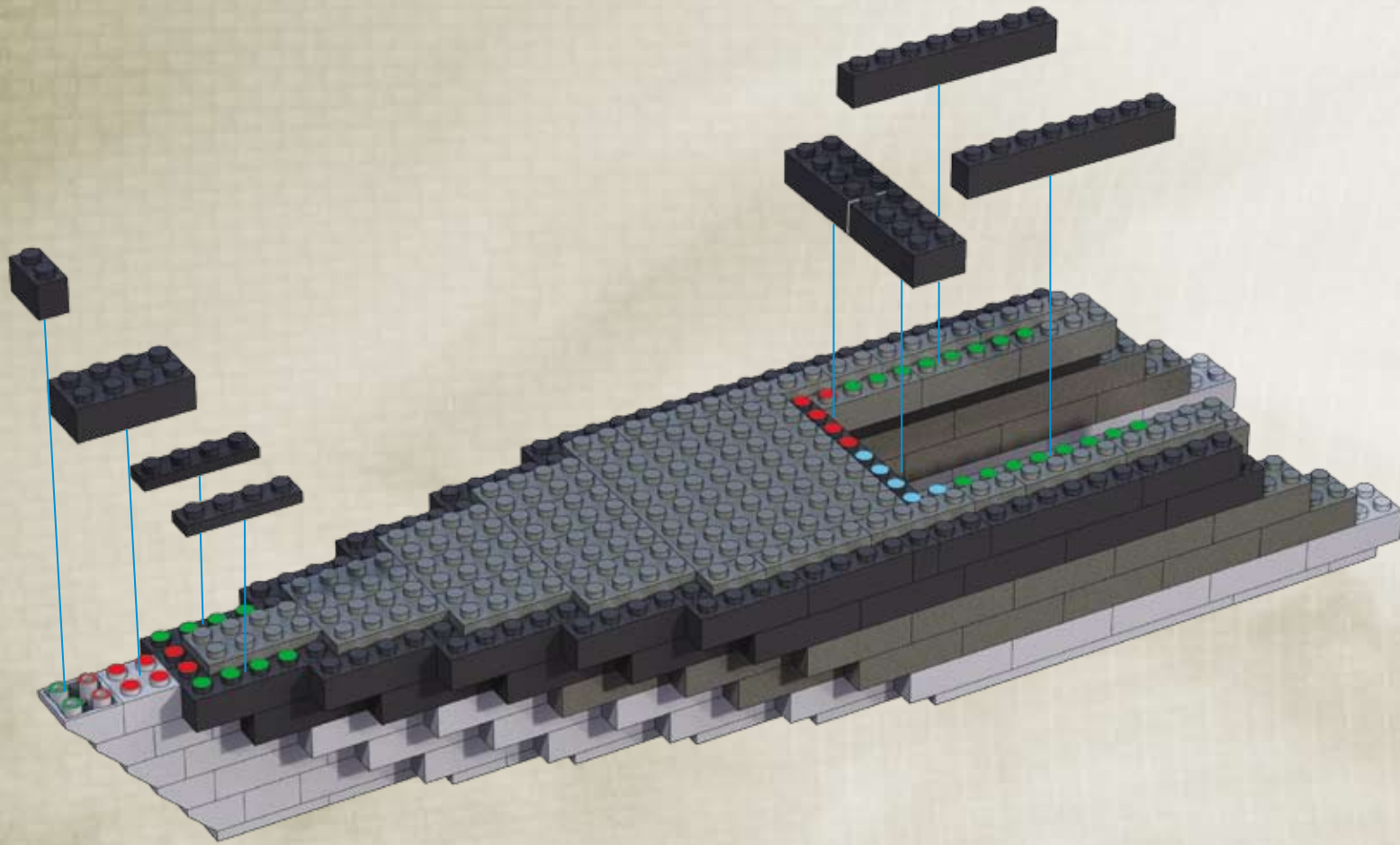

- B** 1x
- 1x

- C** 1x
- 1x
- 1x
- 2x
- 1x

- D** 4x
- 4x

B 1x 6x

D 10x 2x

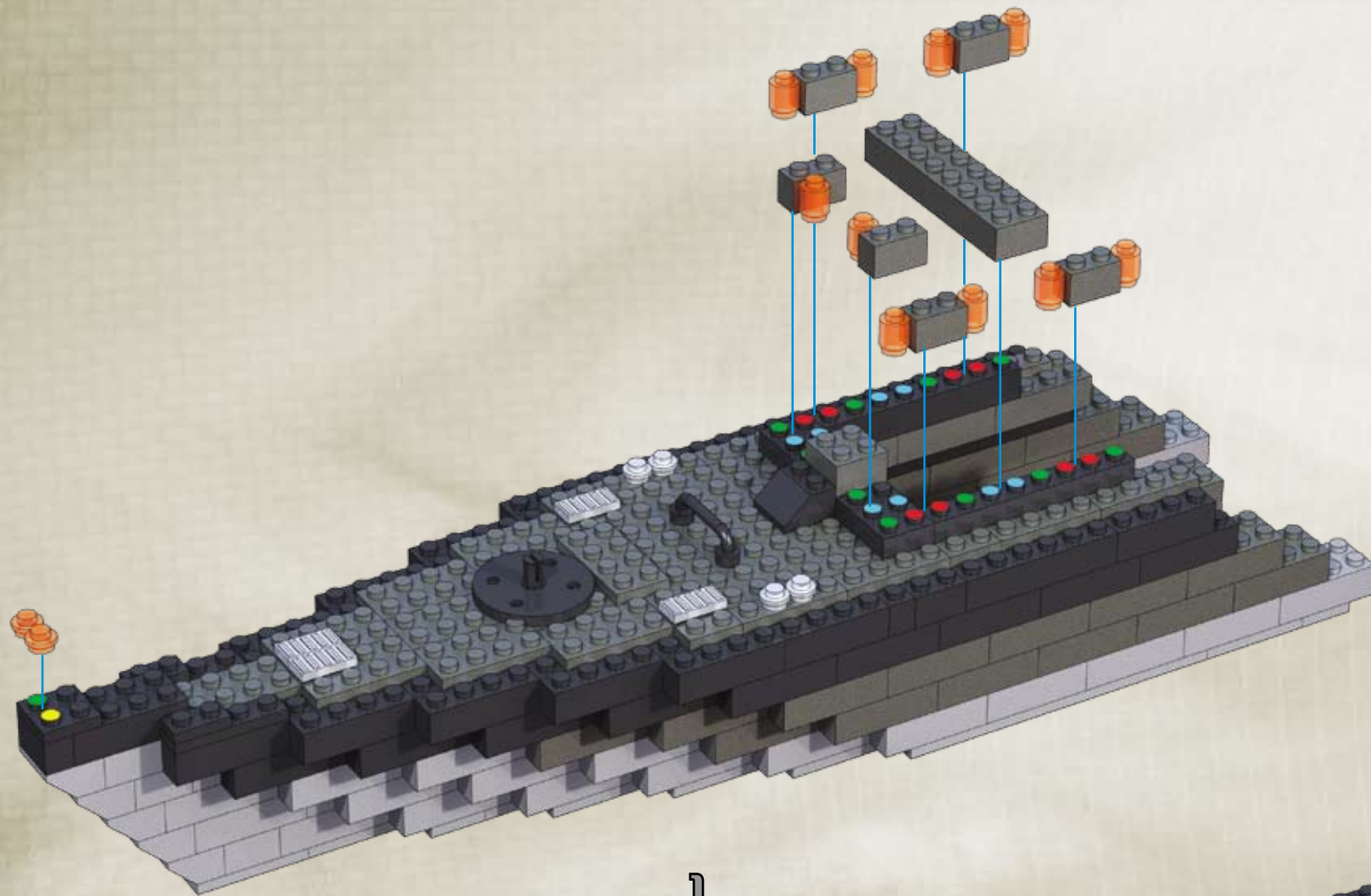

1

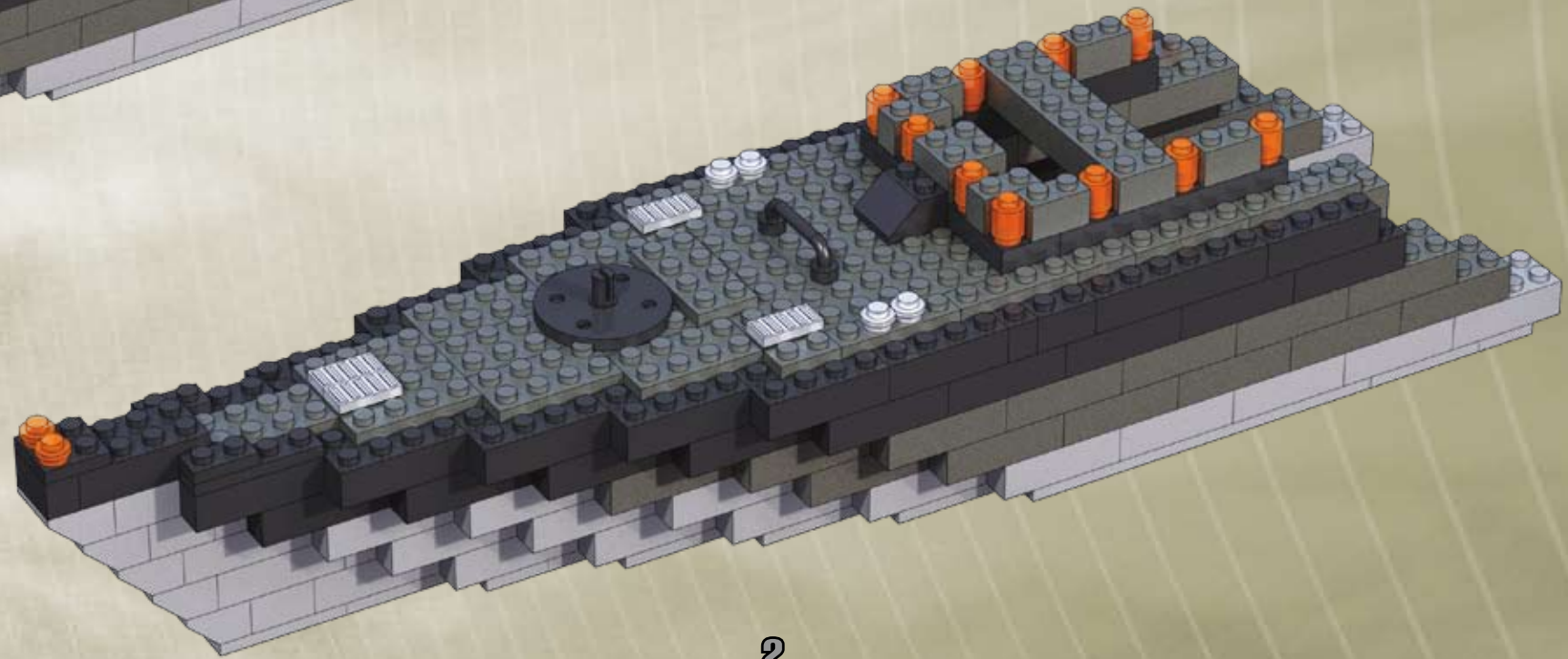

2

- B** 3x 3x 3x 6x 6x 3x 3x
- C** 3x 3x 9x 3x

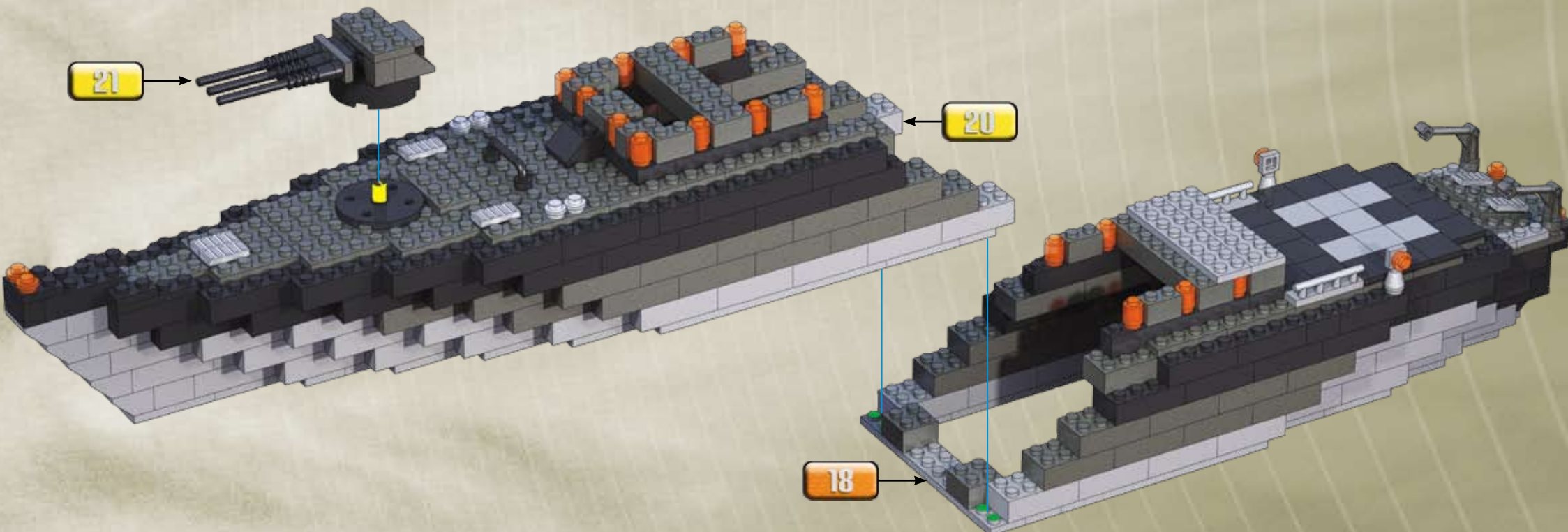
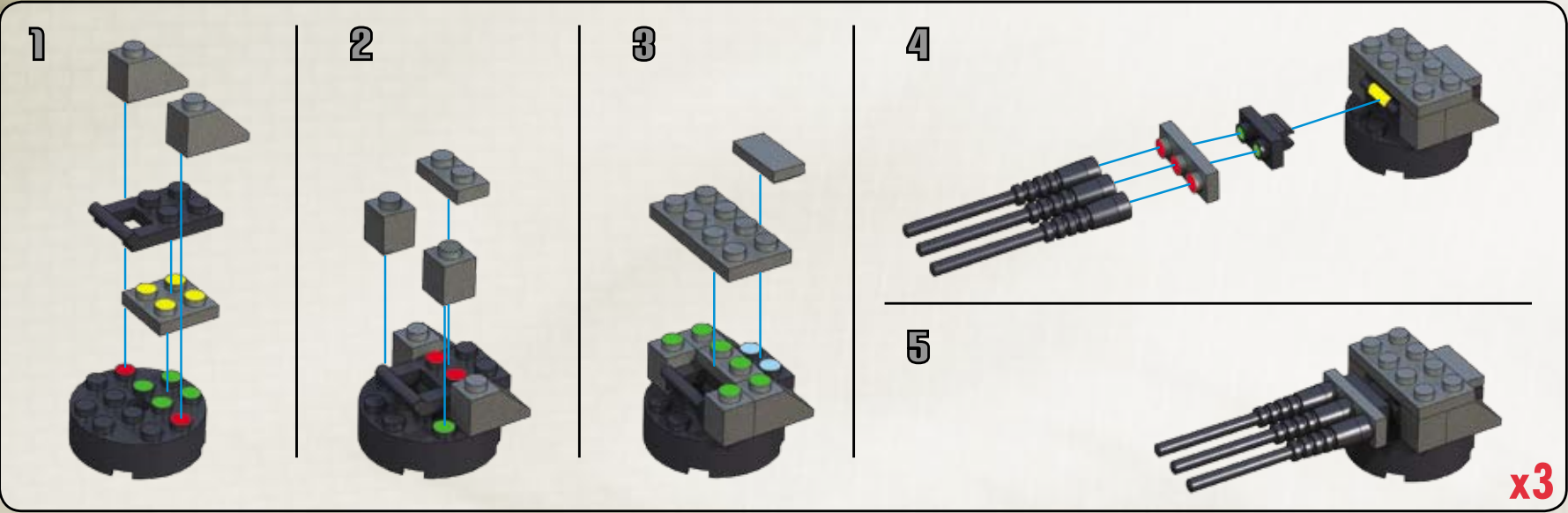

- A 2x
- B 4x

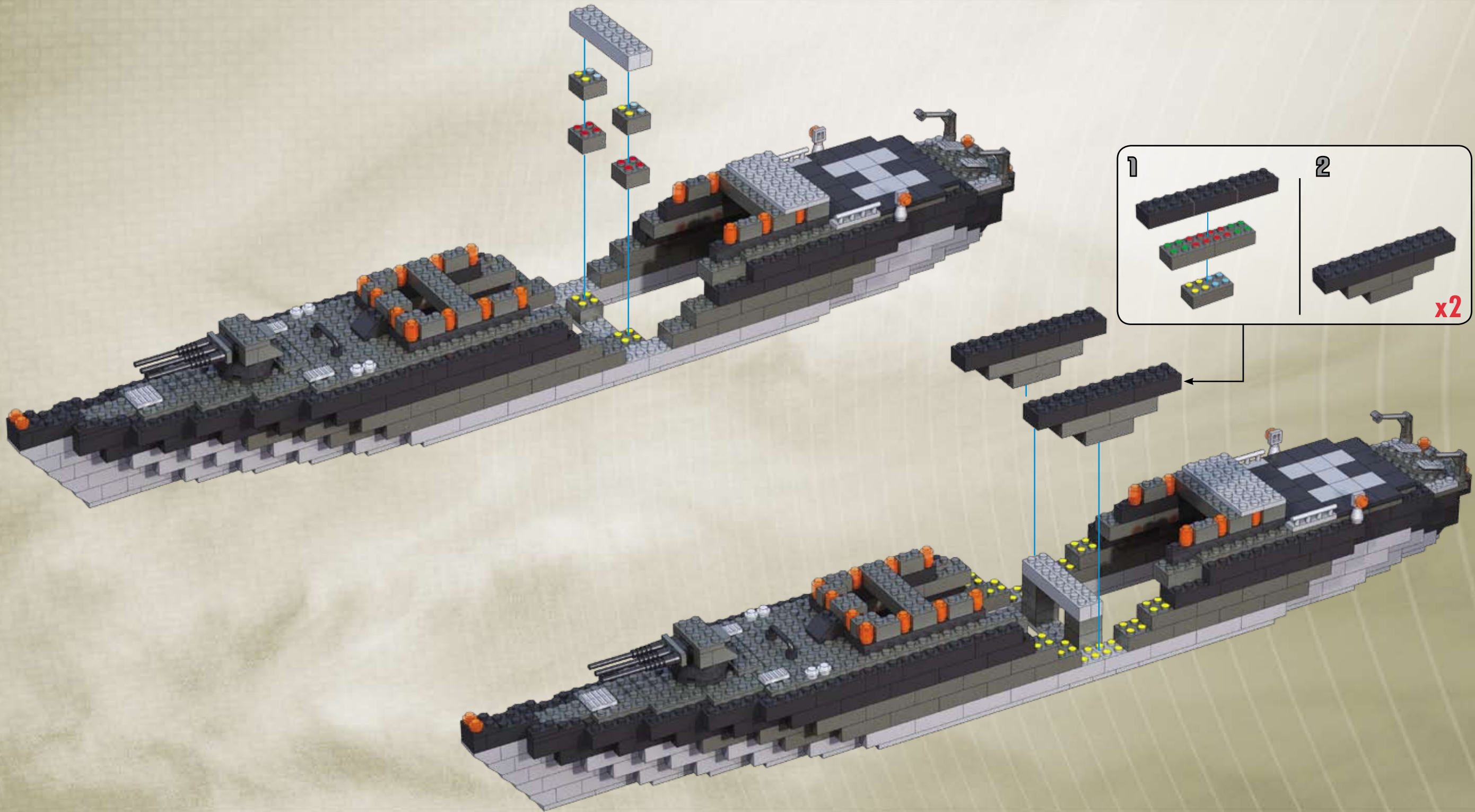

- B 6x
- C 6x

- B 6x
- C 8x

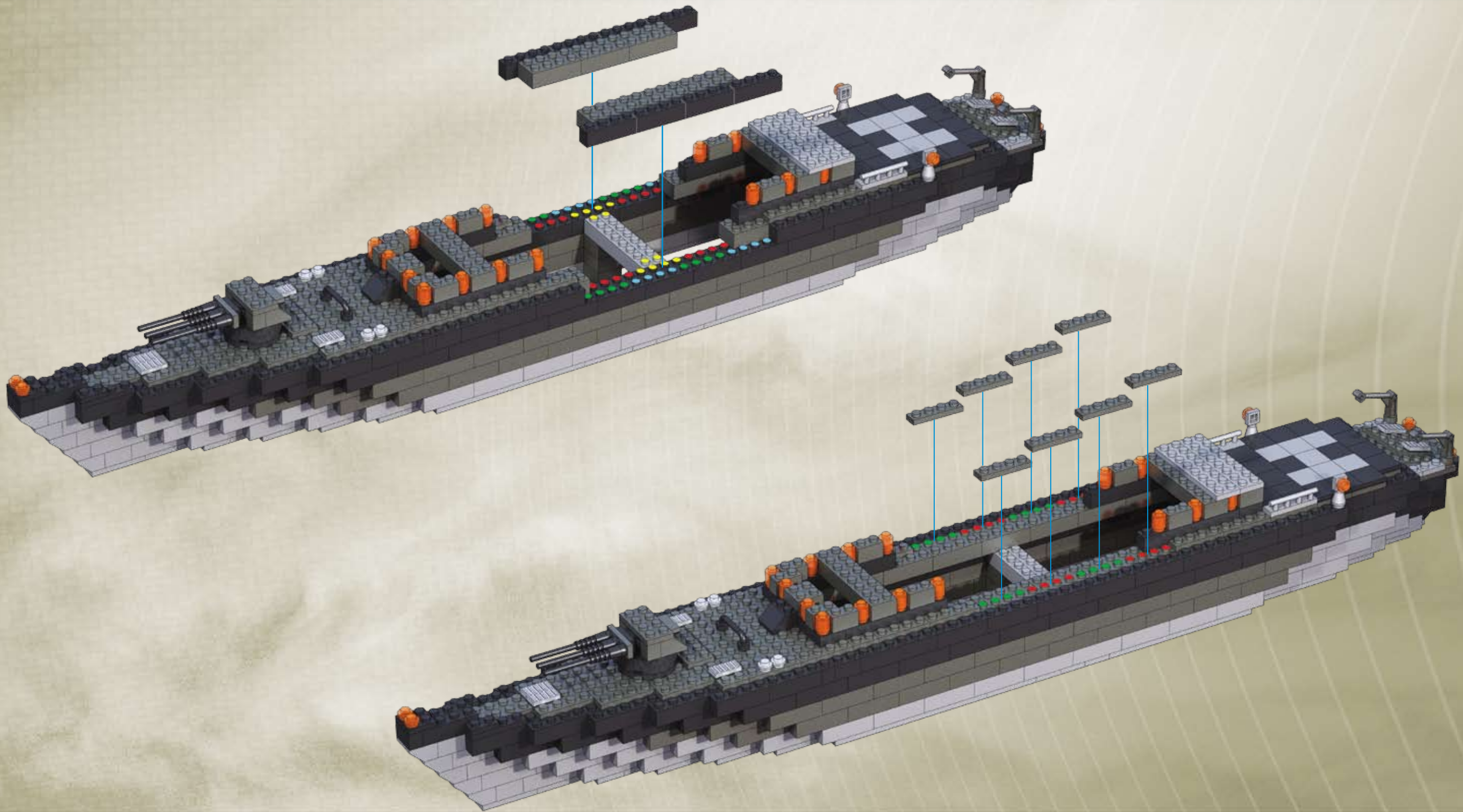

- B 8x





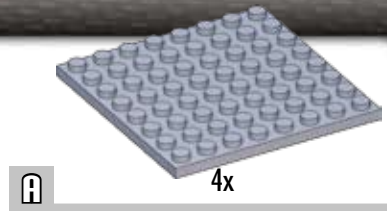
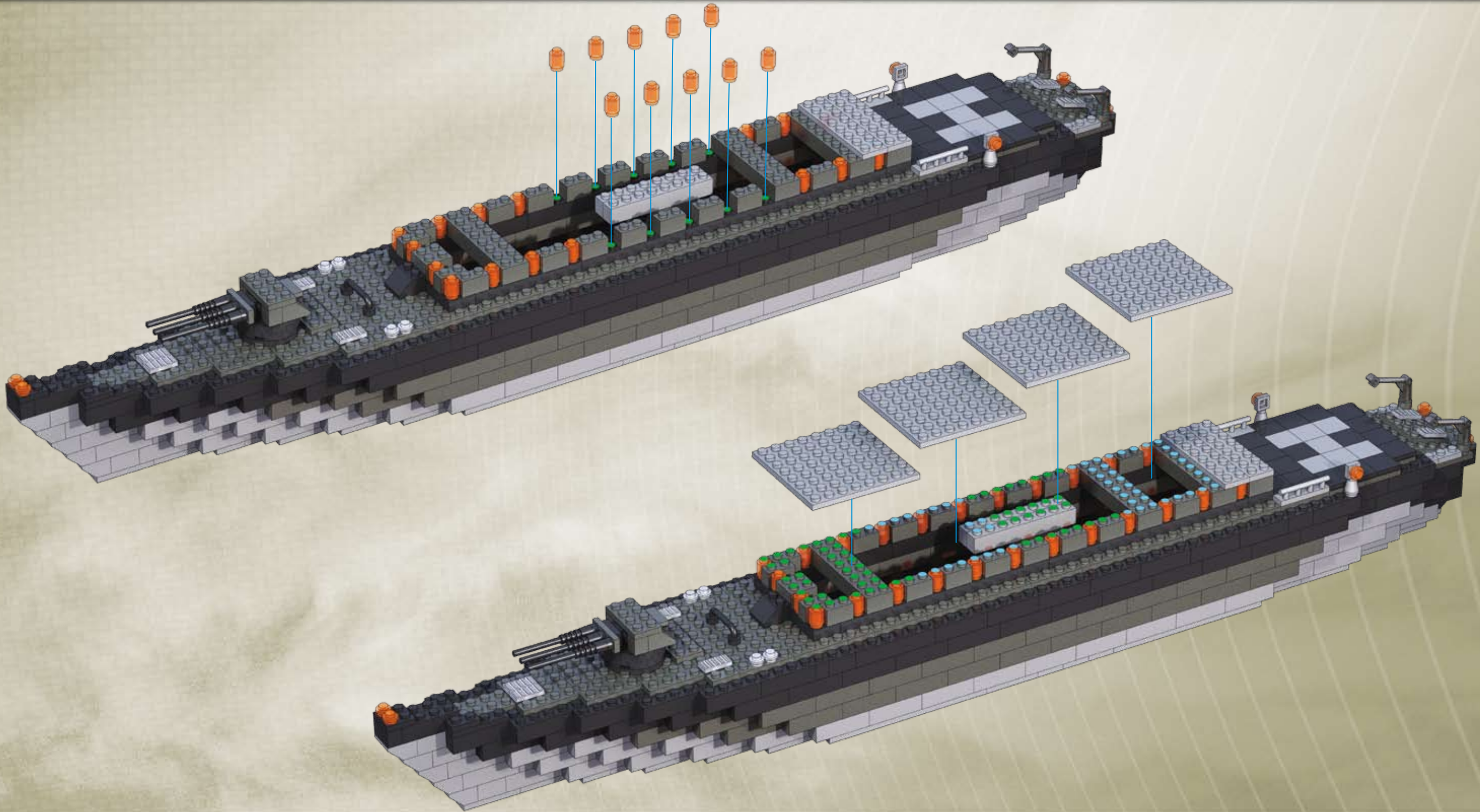

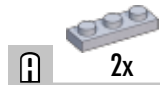
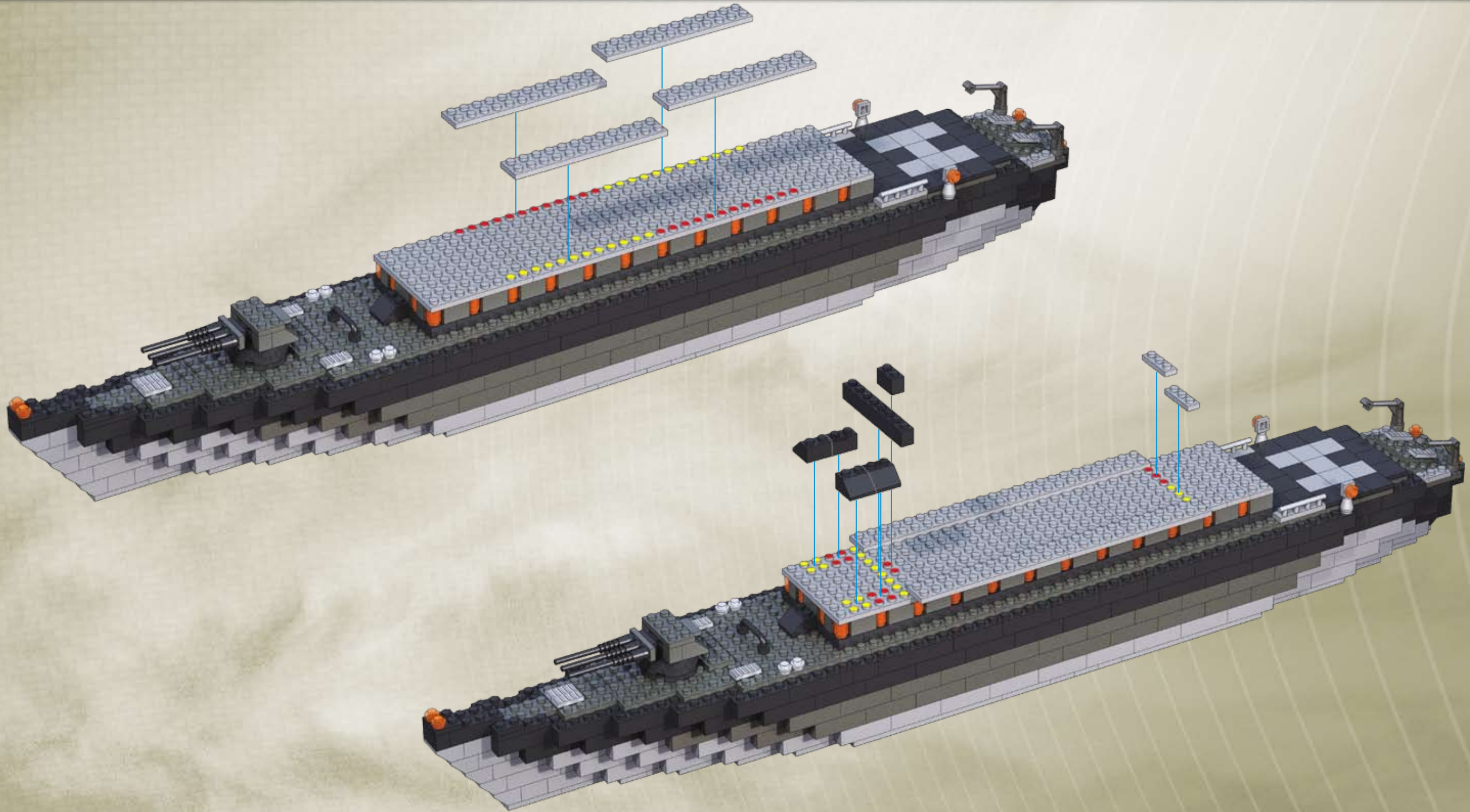
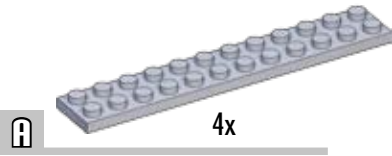



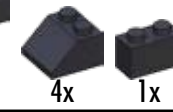
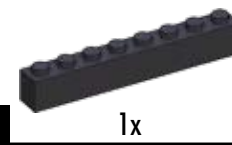

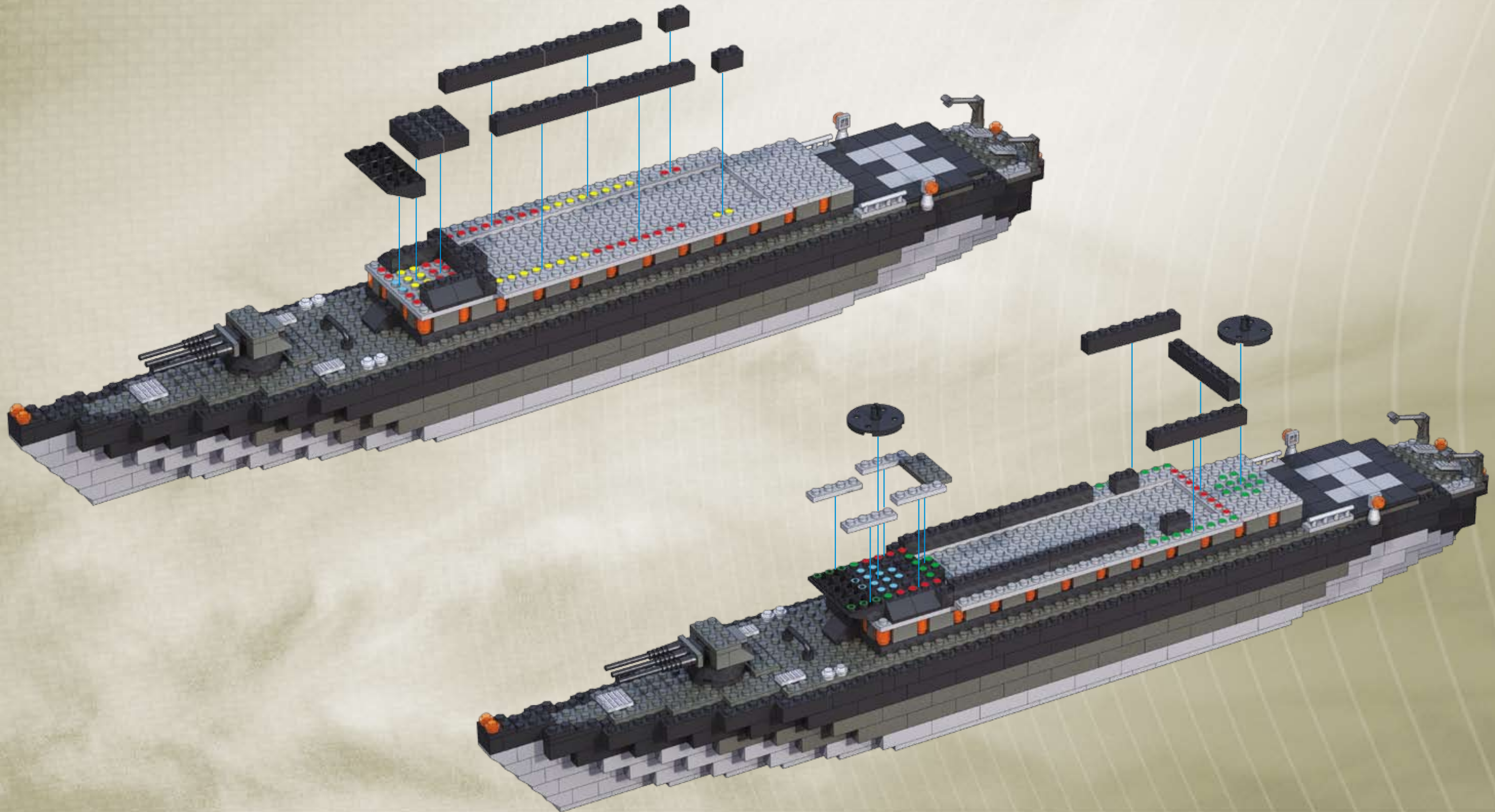
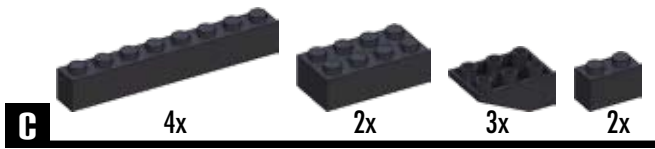

C





- A**  1x
- B**  2x
- C**  8x  2x  3x

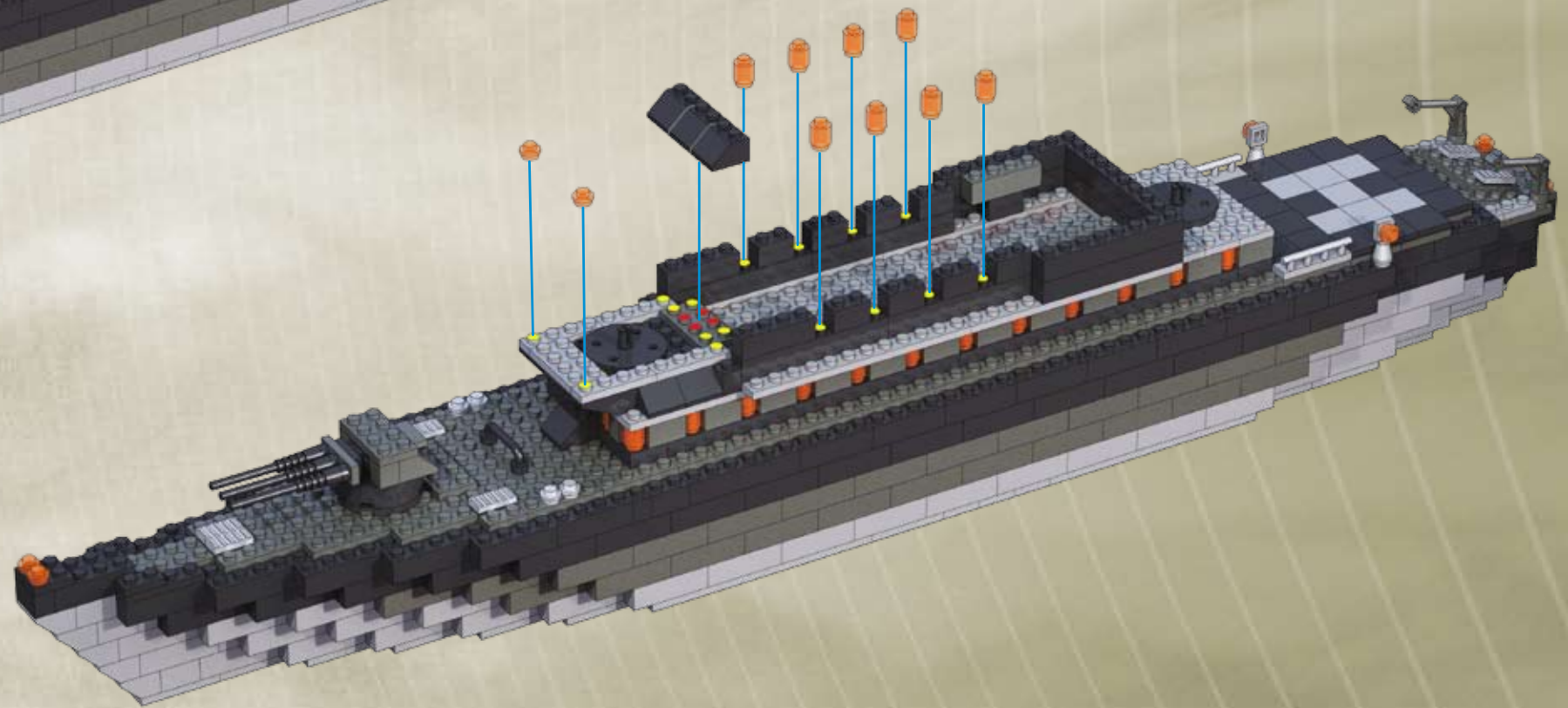
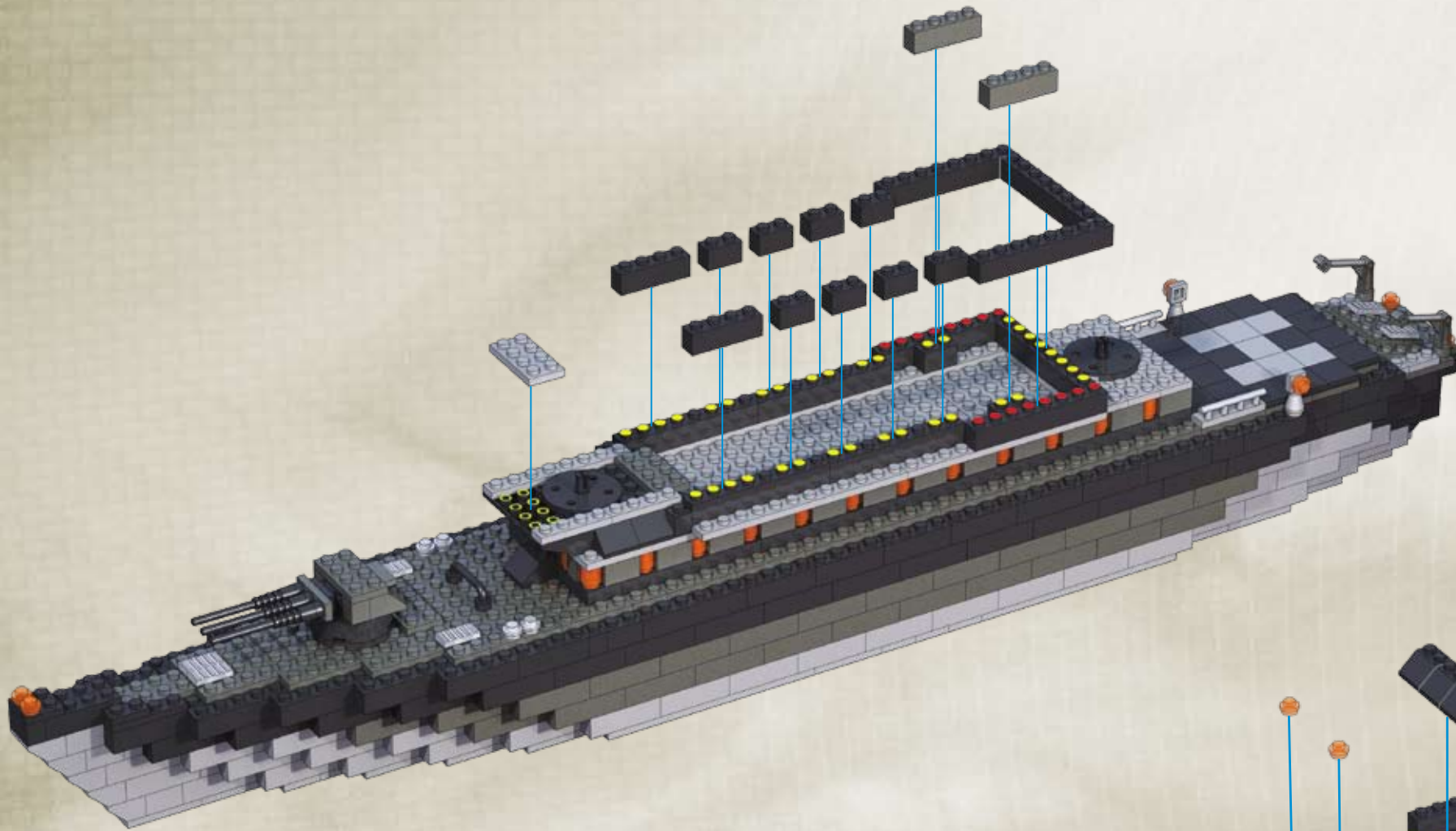

- C**  3x
- D**  8x  2x

- C** 8x
- 2x
- 2x

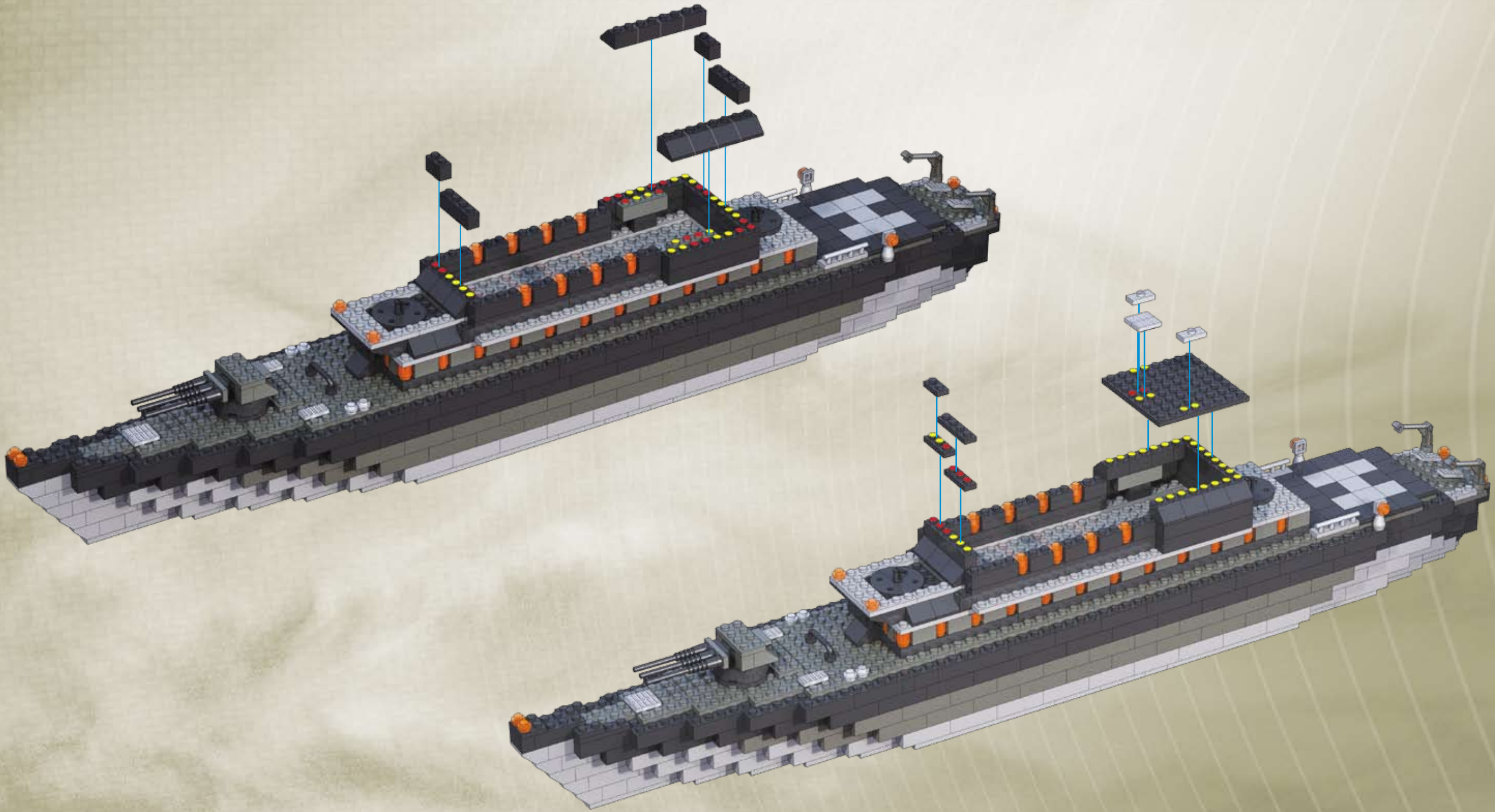

- A** 2x
- C** 1x
- 1x
- 2x
- 1x
- D** 2x

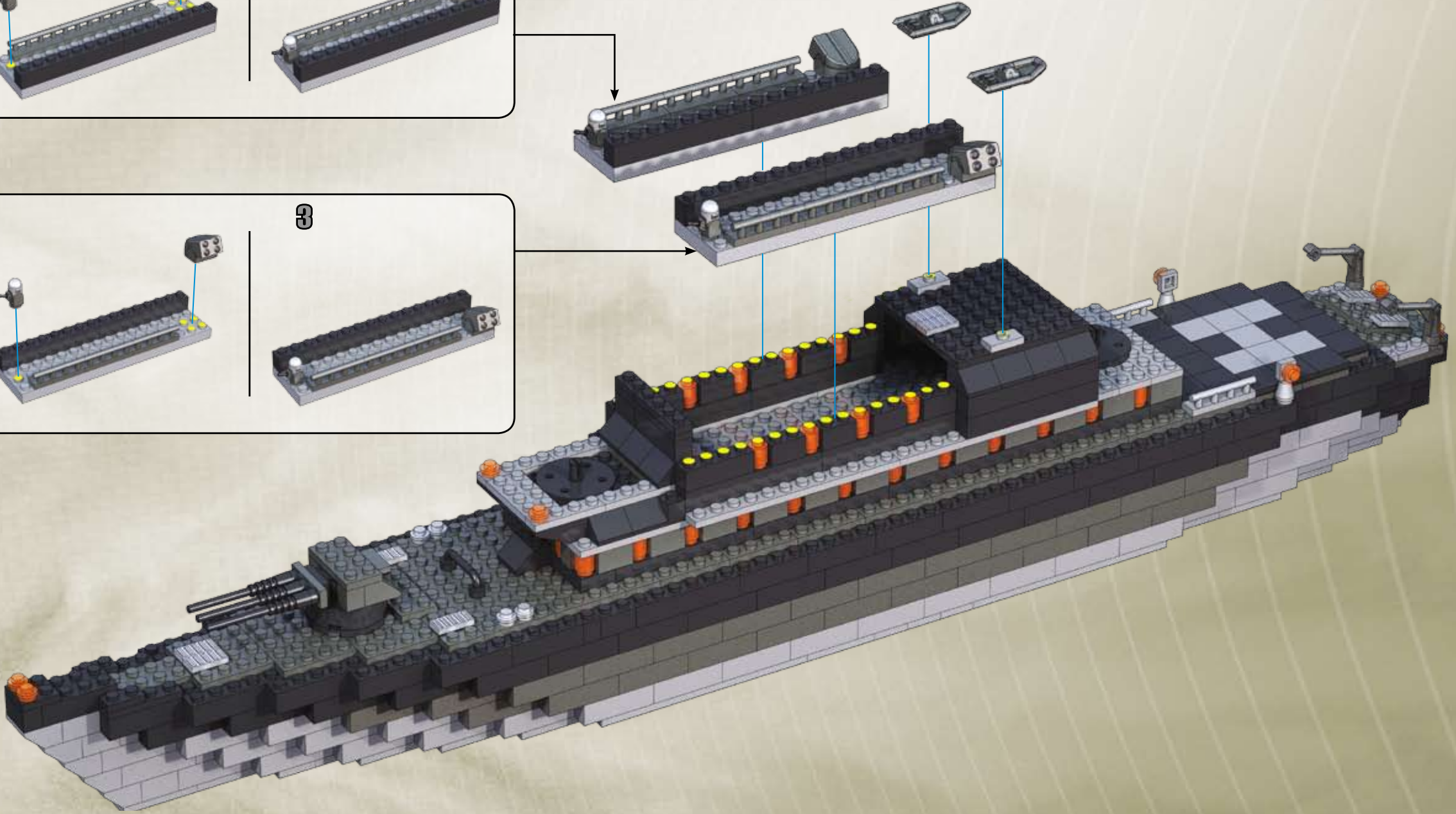
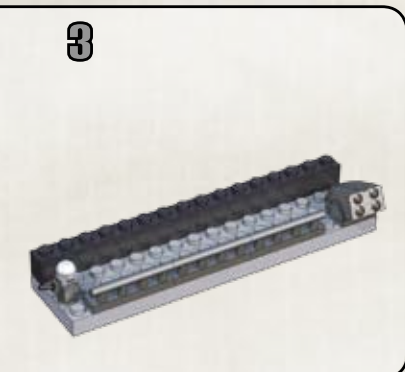
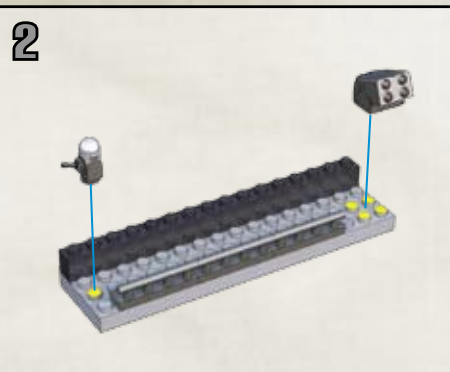
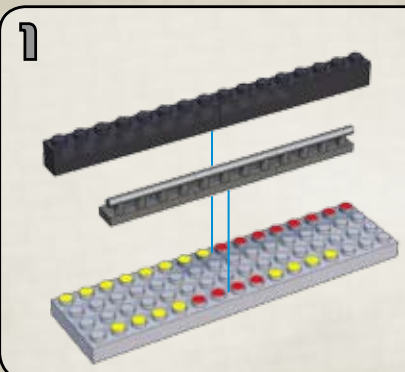
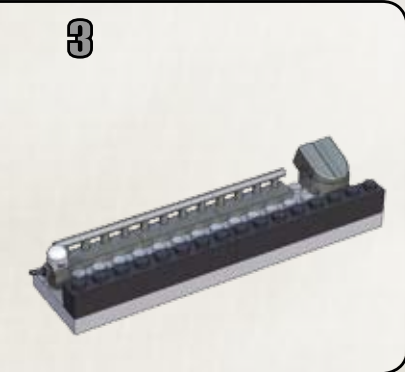
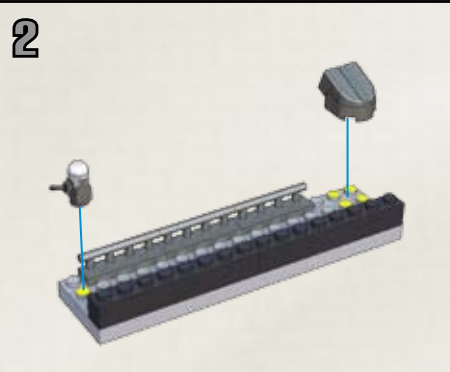
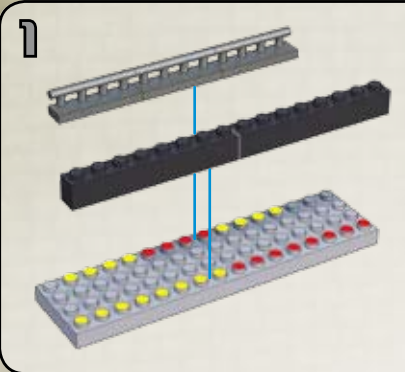
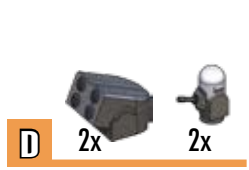
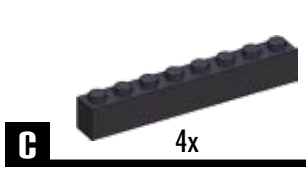
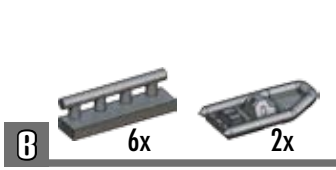
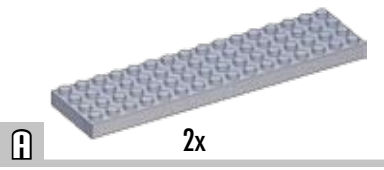

- B** 1x 1x
- C** 2x 3x 2x 1x 2x

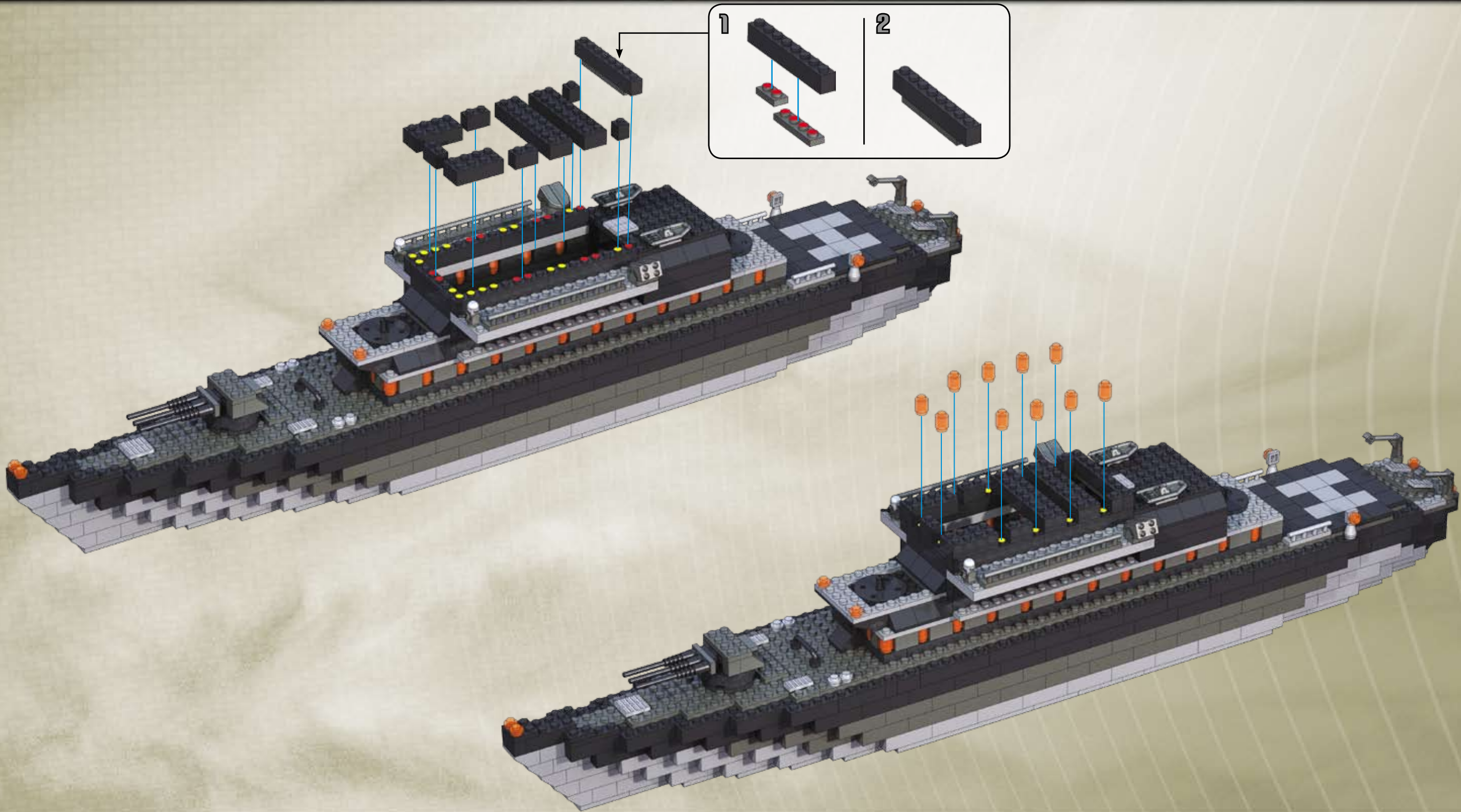

- D** 10x



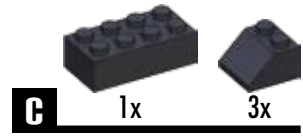
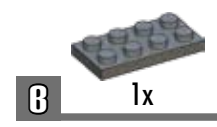
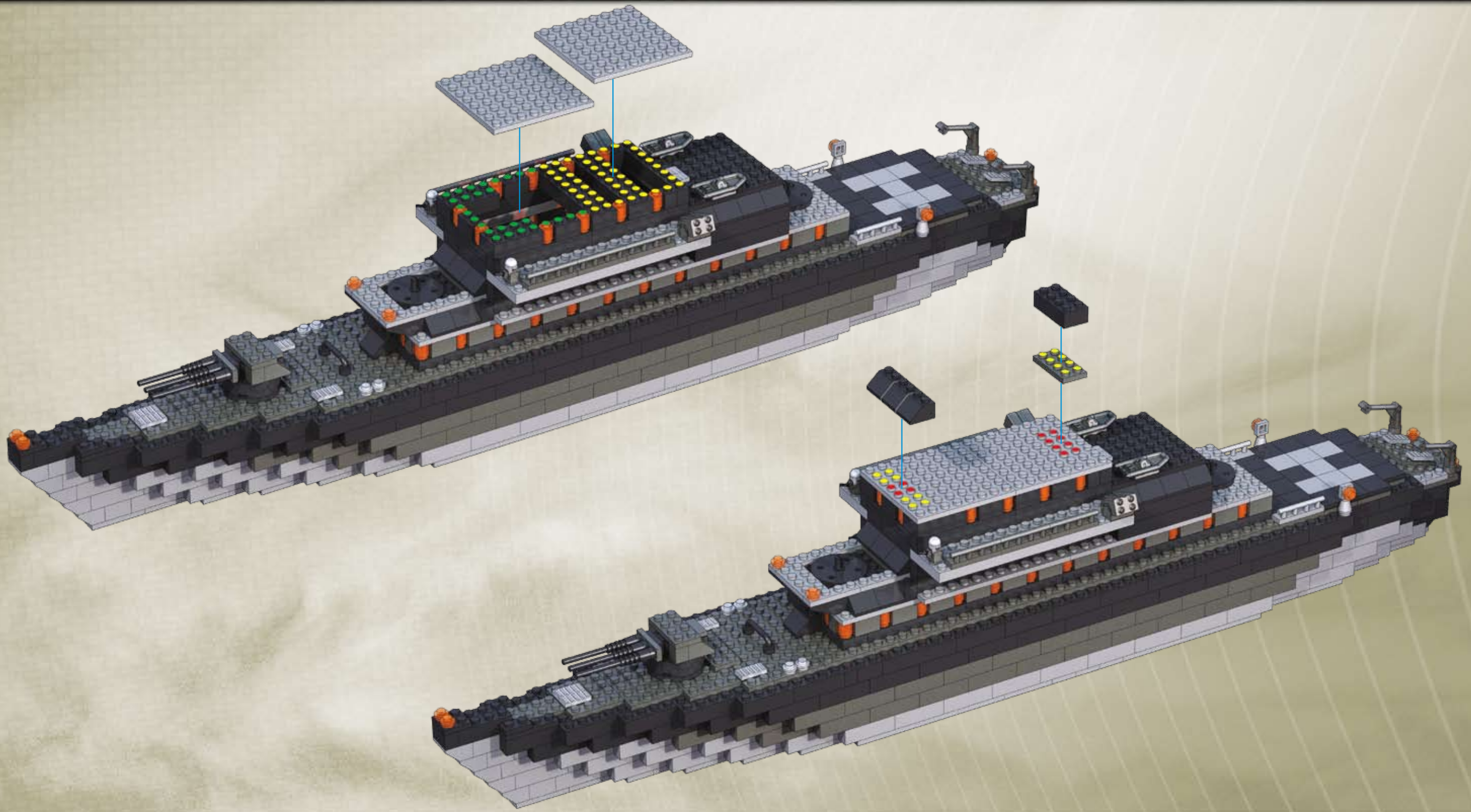
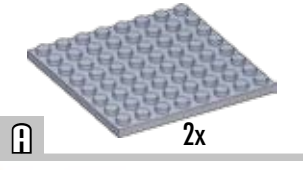

- C** 2x [1x 1-5 Technic Brick]
- 3x [1x 1-3 Technic Brick]
- 2x [1x 1-2 Technic Brick]



- C** 4x [1x 1-4 Technic Brick]
- 4x [1x 1-3 Technic Brick]
- 1x [1x 1-2 Technic Brick]
- 1x [1x 1-1 Technic Brick]
- 2x [1x 1-1 Technic Brick]
- D** 2x [1x 1-1 Technic Pin]

46

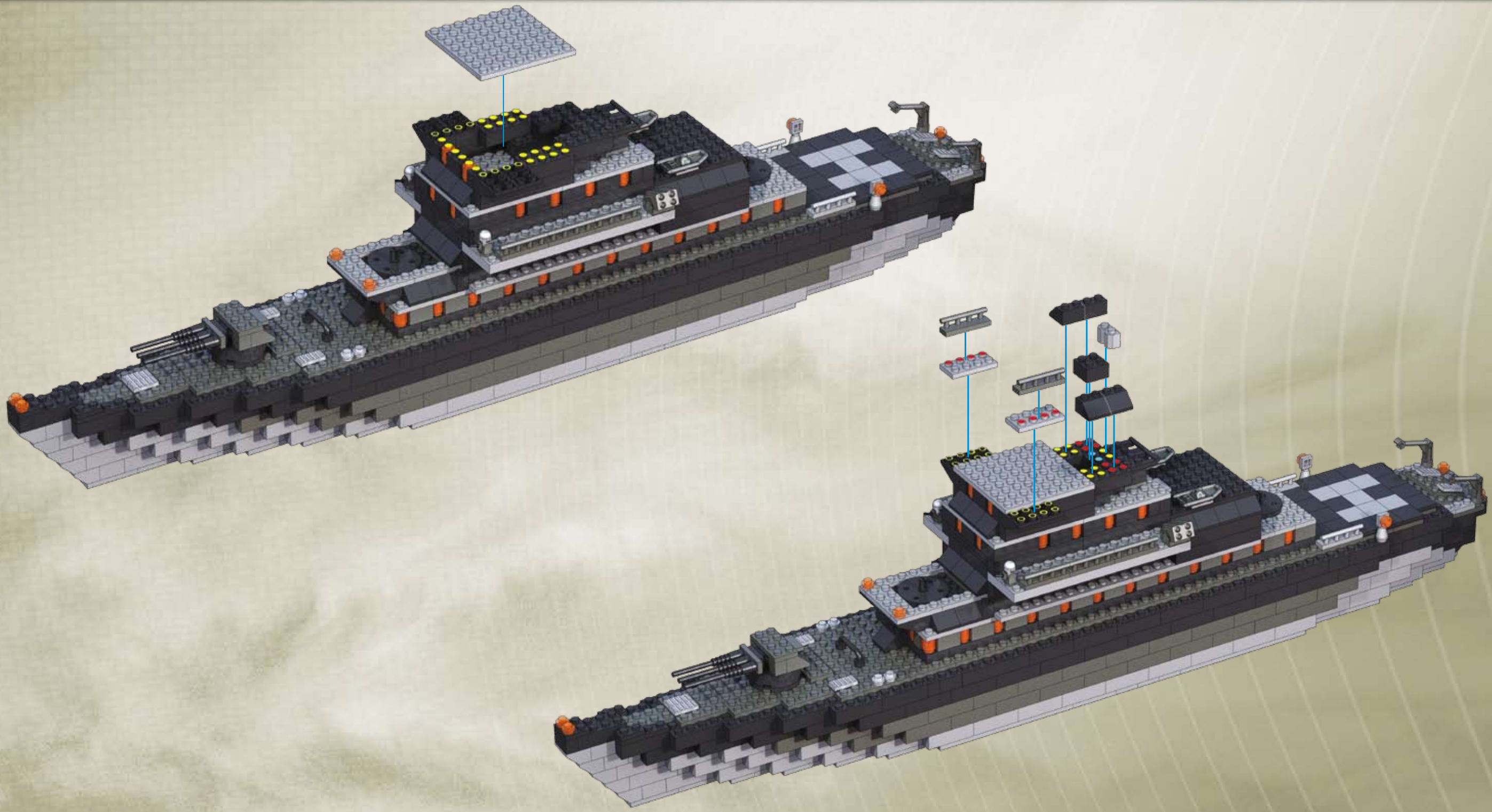
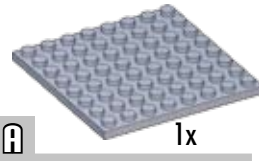

35

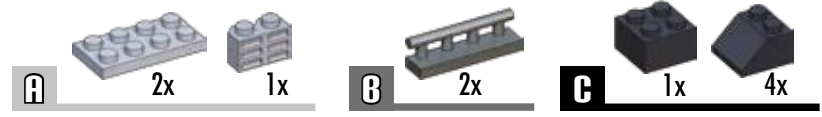

47

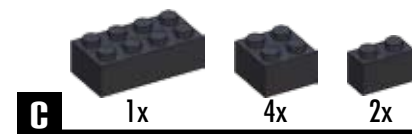
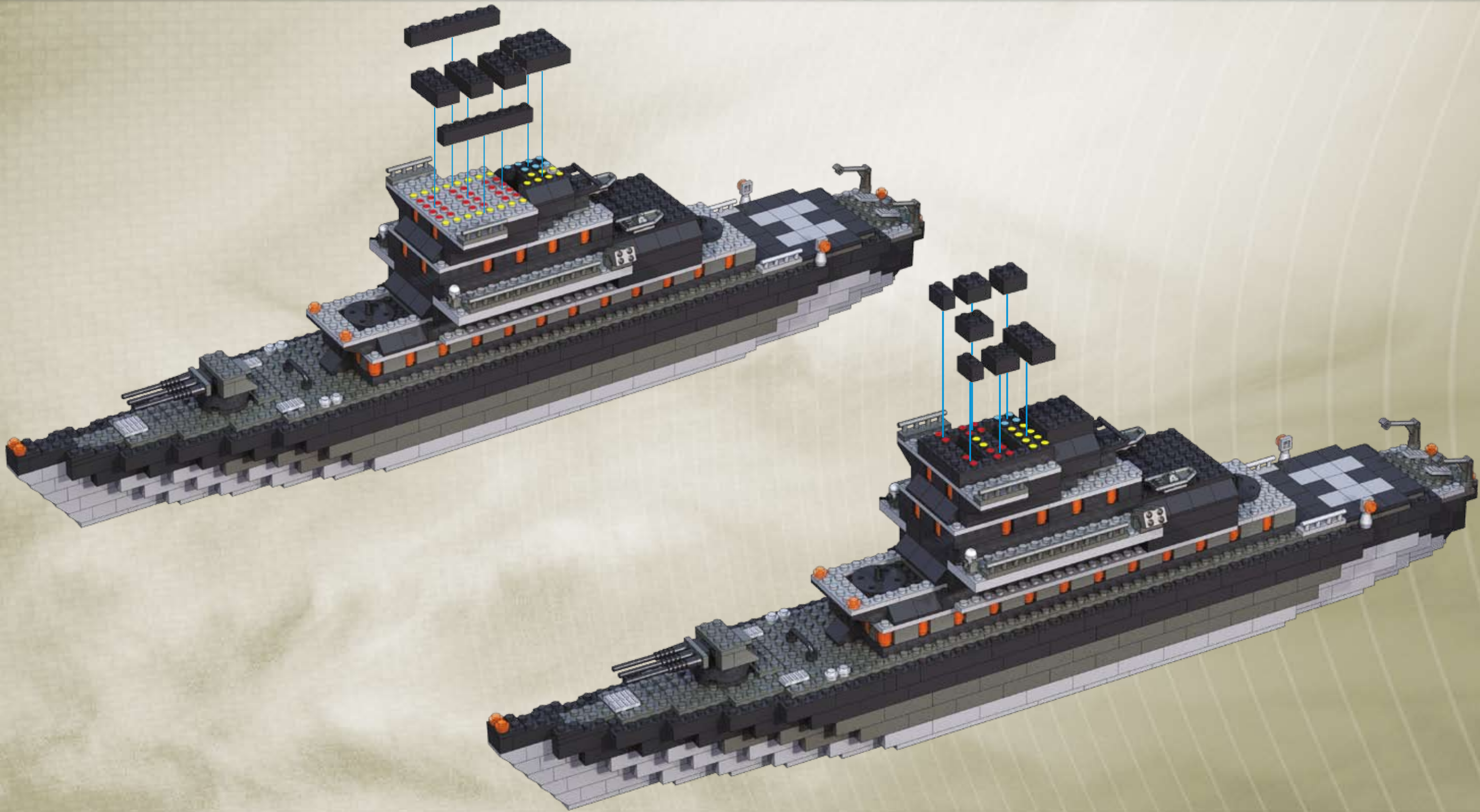
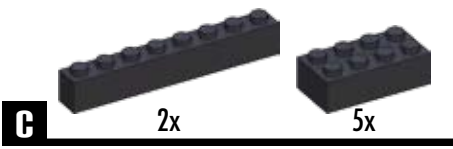

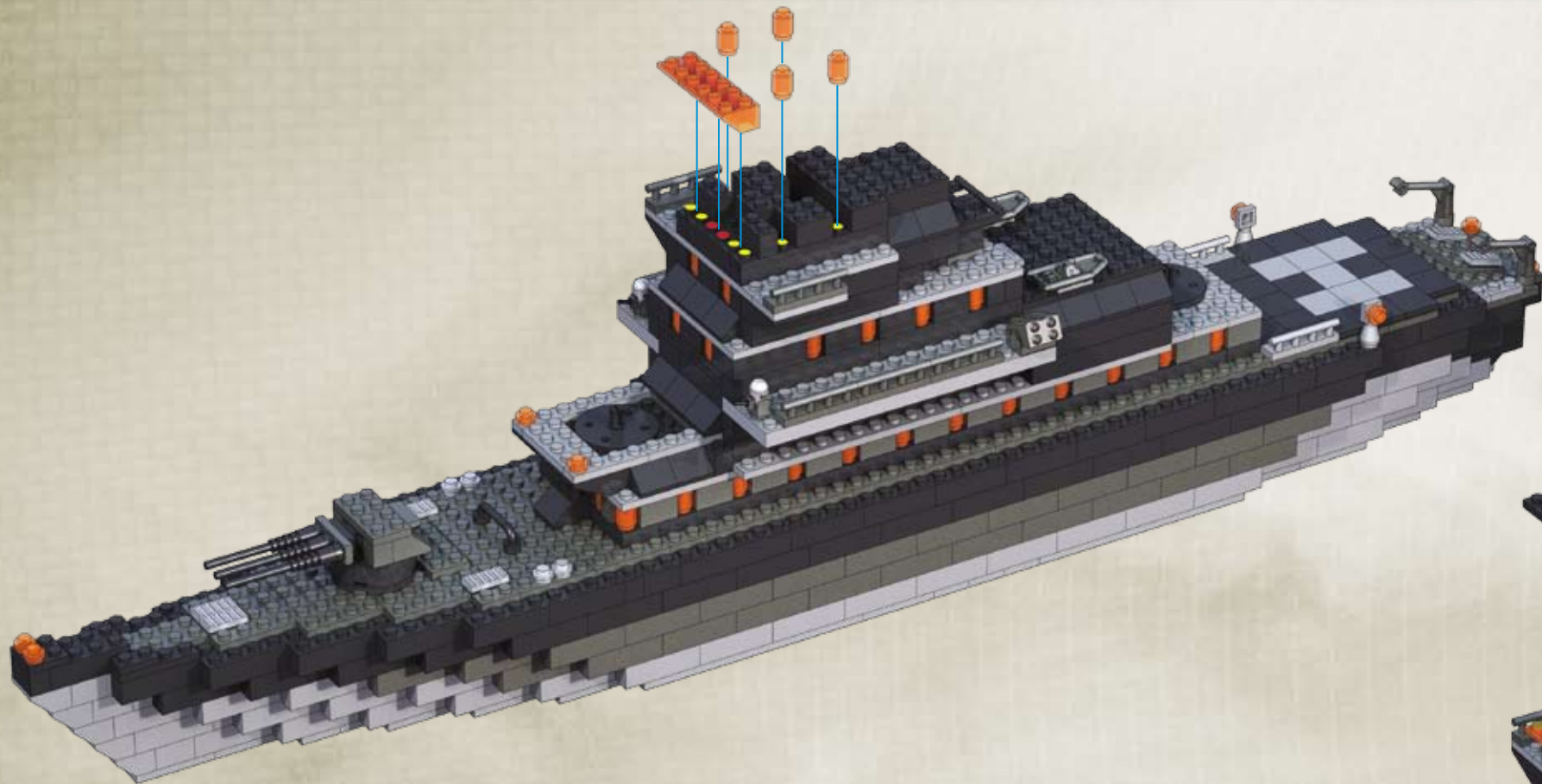
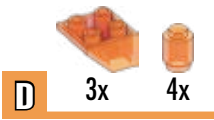

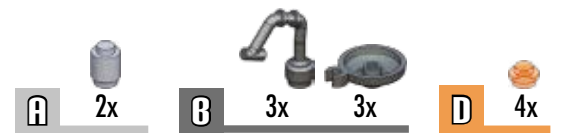
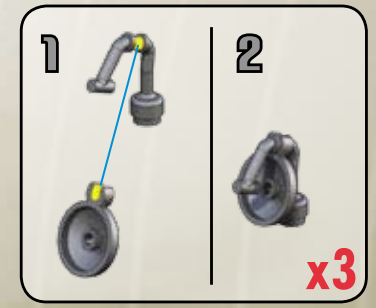
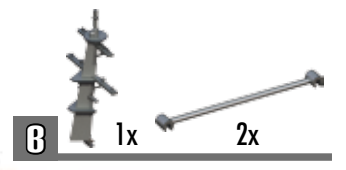

- D 1x  1x 

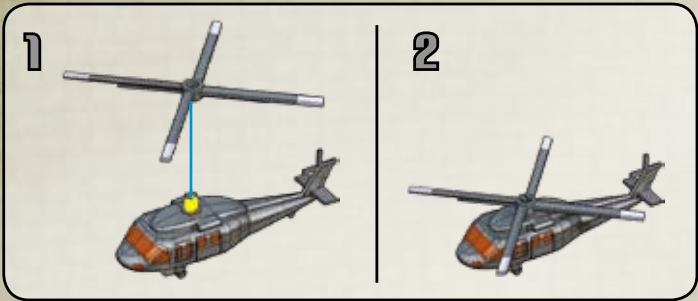

3263

# Probuilder

Carbon Series™

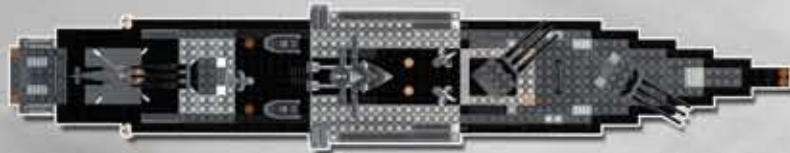

76.1 in x 44.3 cm



Ultimate collection!  
¡Una colección indispensable!  
Collection ultime !  
Die ultimative Sammlung!  
Uitme verzameling!  
La collezione all'ultimo grido!  
Uma coleção a não perder!



3271

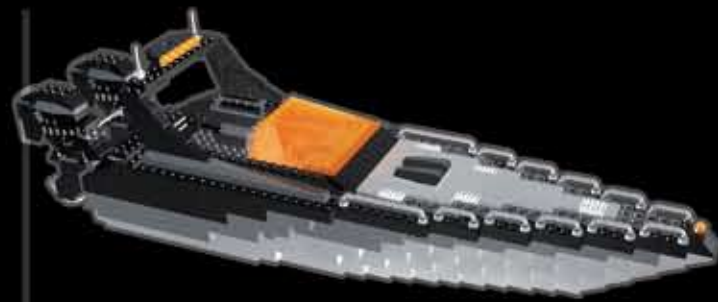

3272



3268



3269



3274



3275

© 2009, MEGA Brands Inc.  
MEGA Brands Inc. and the MEGA Brands Inc. logo are registered trademarks of MEGA Brands Inc.  
MEGA Brands Inc. y el logotipo MEGA Brands Inc. son marcas registradas de MEGA Brands Inc.  
MEGA Brands Inc. et le logo de MEGA Brands Inc. sont des marques de commerce déposées de MEGA Brands Inc.  
MEGA Brands Inc. und das MEGA Brands Inc.-Logo sind eingetragene Warenzeichen von MEGA Brands Inc.  
MEGA Brands Inc. en het MEGA Brands Inc. logo zijn gedeponeerde handelsmerken van MEGA Brands Inc.  
MEGA Brands Inc. ed il logo di MEGA Brands Inc. sono marchi di fabbrica di MEGA Brands Inc.  
MEGA Brands Inc. e o logo MEGA Brands Inc. são marcas registradas de MEGA Brands Inc.

Printed in China AD032631A

