

**MEGA
BLOKS**

SUPER TECH HEROES™
CONSTRUCTION TOY

2027

Battle Damage Spider-Man™

6+

95 €



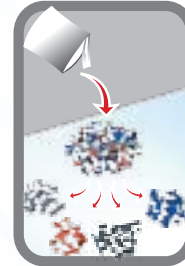
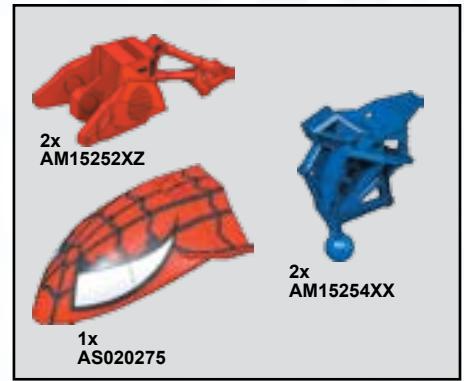
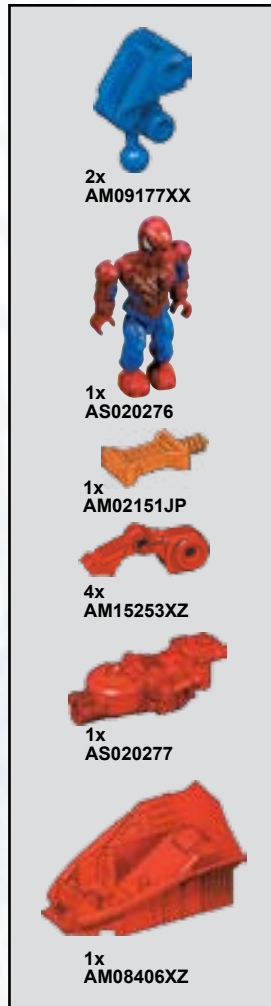
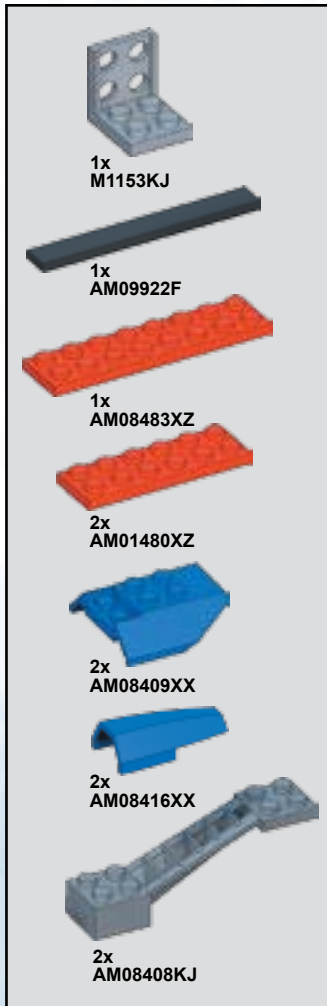
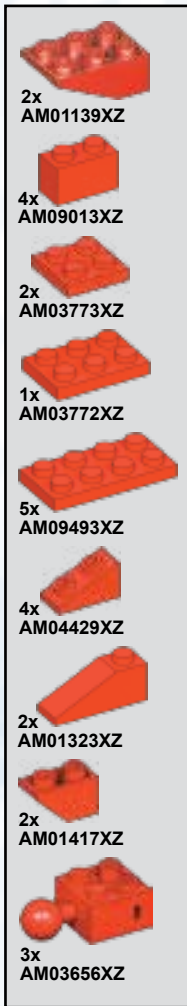
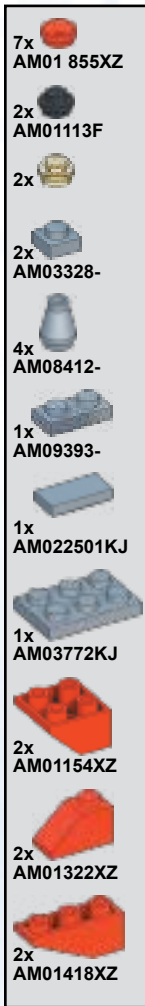

LIFETIME GUARANTEE / GARANTIZADO DE POR VIDA / GARANTIE À VIE / LEBENS-LANGE GARANTIE / LEVENSLANGE GARANTIE / GARANZIA A VITA / TEM GARANTIA VITALÍCIA

COMMENTS, QUESTIONS ? / ¿COMENTARIOS, PREGUNTAS ? / COMMENTAIRES, QUESTIONS ? / KOMMENTARE, FRAGEN ? / COMMENTARIES, VRAGEN ?
COMMENTI?, DOMANDE? / PERGUNTAS?, COMMENTÁRIOS?

1-800-465-MEGA

U.S. & Canada only / Solamente en EEUU y Canadá / É.U. et Canada seulement / Nur für U.S. und Kanada / Utsluitend in de V.S. en Canada / USA e Canada solamente / Somente EE.UU. e Canada

www.megabrands.com

MARVEL MARVEL, Spider-Man:™ & © 2008 Marvel Characters, Inc. All rights reserved. www.marvel.com

This construction toy is produced under license from Marvel Characters, Inc. Super Hero(es) is a co-owned registered trademark.

ⓘ Please read these instructions carefully before first use and keep them for future reference. Ⓢ Leer estas instrucciones cuidadosamente antes de la primera utilización y guardarlas para referencia futura. Ⓣ Il est recommandé de lire attentivement ce feuillet avant la première utilisation et de le conserver pour référence future. Ⓤ Die Gebrauchsanleitung bitte durchlesen und aufbewahren. Ⓟ Wij raden u aan deze handleiding zorgvuldig te lezen en te bewaren voor eventuele raadpleging op een later tijdstip. Ⓠ Leggere le istruzioni prima di cominciare ad usare il gioco e conservarle per referenze future. Ⓡ Leia as instruções antes do primeiro uso e guarde-as para futura referência.

ⓘ ⚠ **WARNING:**
CHOKING HAZARD. - Small parts.
Not for children under 3 years.

Ⓢ ⚠ **ADVERTENCIA:**
PELIGRO DE ASFIXIA. - Contiene piezas pequeñas.
No recomendado para niños menores de 3 años.

Ⓣ ⚠ **AVERTISSEMENT:**
RISQUE DE SUFFOCATION. - Présence de petits éléments.
Ne convient pas aux enfants de moins de 3 ans.

Ⓤ ⚠ **WARNUNG:**
ERSTICKUNGSGEFAHR. - Enthält kleine Teile.
Nicht für Kinder unter 3 Jahren geeignet.

Ⓠ ⚠ **WAARSCHUWING:**
VERSTIKKINGSGEVAAR. - Bevat kleine onderdelen.
Niet geschikt voor kinderen onder de 3 jaar.

Ⓡ ⚠ **ADVARSEL:**
KVÆLNINGSFARE. - Inneholder smådeler.
Ikke til barn under 3 år.

Ⓡ ⚠ **ΠΡΟΕΙΔΟΠΟΙΗΣΗ:**
ΚΙΝΔΥΝΟΣ ΠΝΙΞΙΜΑΤΟΣ. - Περιέχει μικρά αντικείμενα
Όχι για παιδιά κάτω των 3 ετών.

Ⓡ ⚠ **VAROITUS:**
TUKEHTUMISVAARA. - Sisältää pieniä osia.
Ei alle 3-vuotiaalle lapsille.

Ⓟ ⚠ **ATTENZIONE:**
PERICOLO DI SOFFOCAMENTO. - Contiene piccole parti.
Non indicato per bambini sotto i 3 anni.

Ⓡ ⚠ **ADVARSEL:**
KVÆLNINGSFARE. - Inneholder smådeler.
Kun for barn over 3 år.

Ⓡ ⚠ **ATENÇÃO:**
PERIGO DE ASFIXIA. - Contém peças pequenas.
Não é concebido para crianças de menos de 3 anos.

Ⓡ ⚠ **VARNING:**
KVÄVNINGSRISK. - Innehåller små delar.
Inte för barn under 3 år.

Ⓡ ⚠ **警告:**
窒息の危険性 小さな部品が含まれています
3歳以下の子供には与えないで下さい。

Ⓡ ⚠ **警告:**
有窒息危險。包含有小部件
不适合3岁以下的小孩玩。

Ⓡ ⚠ **تحذير:**
خطر اختناق - قطع صغير.
غير صالحة للاطفال أقل من 3 سنوات.

1



2



3

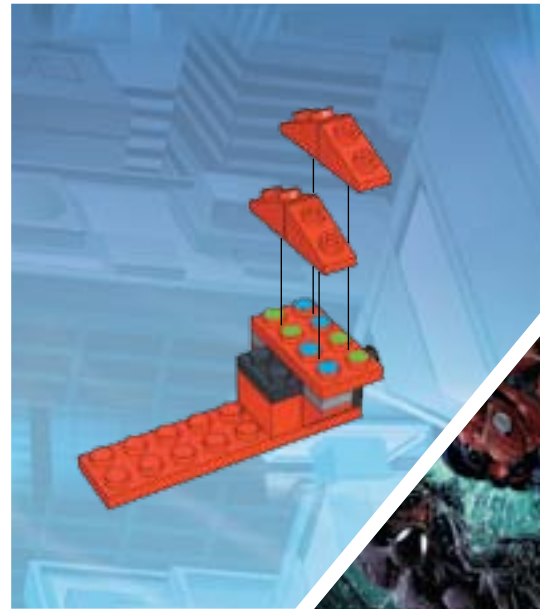
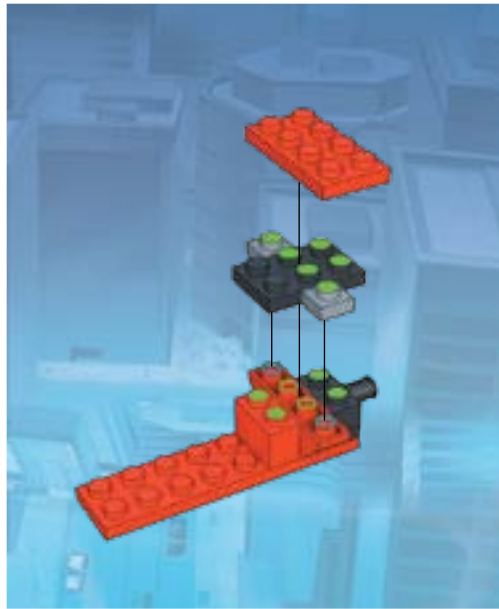
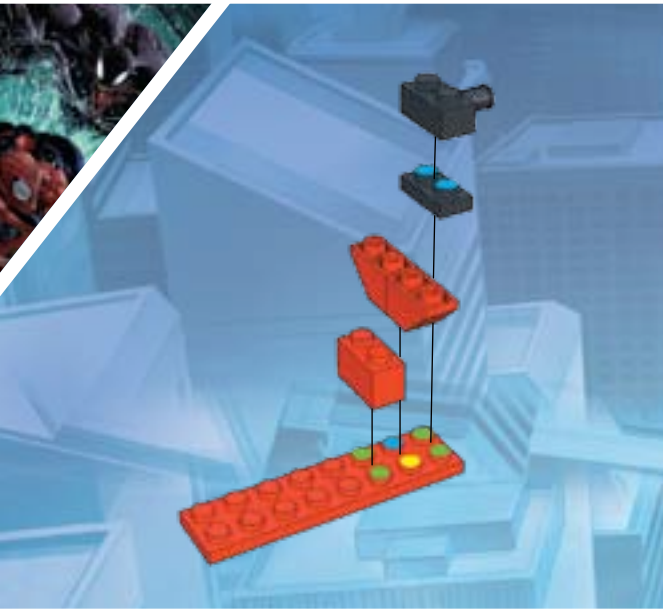

4



1

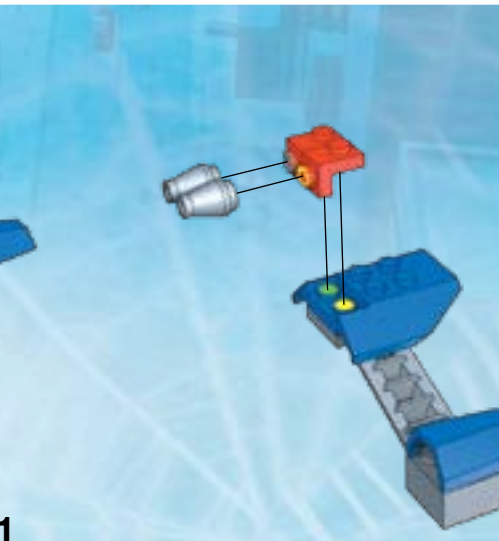

2

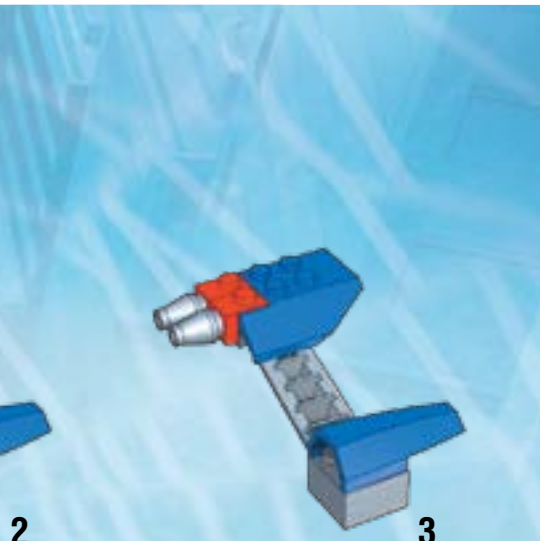

3

5

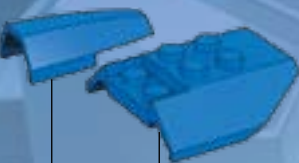
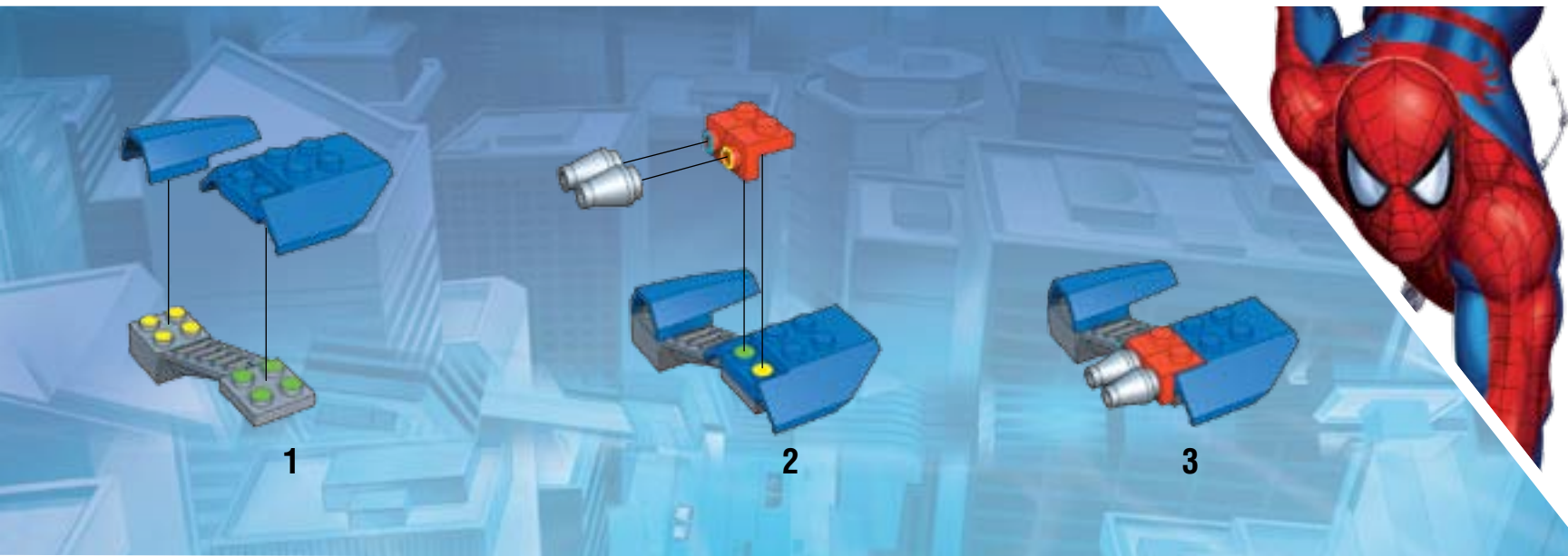

1

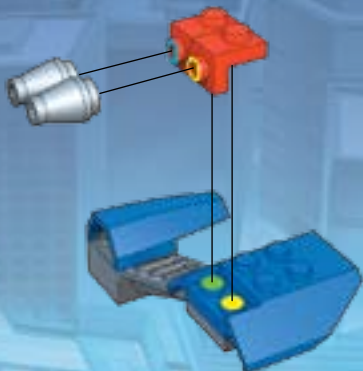

2

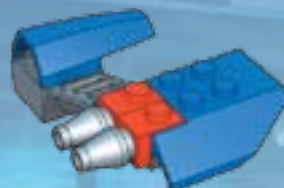

3

6

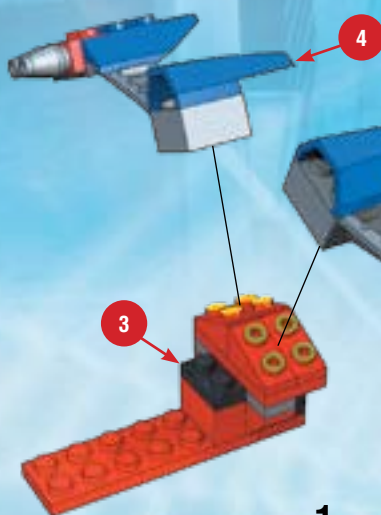

1



4



5

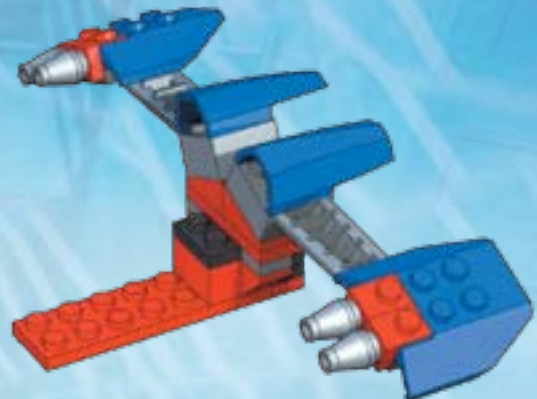

2

7

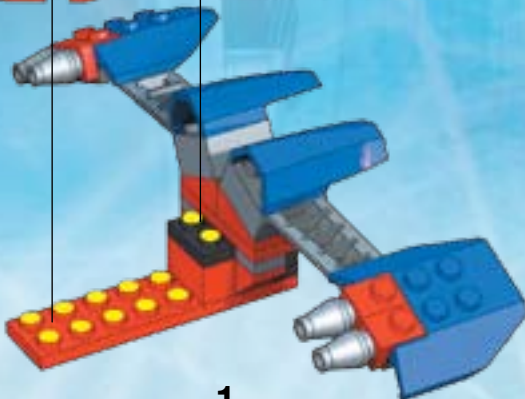
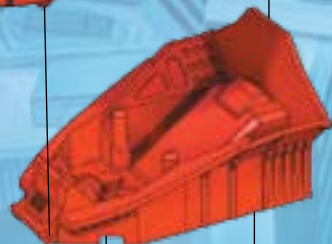

1



2

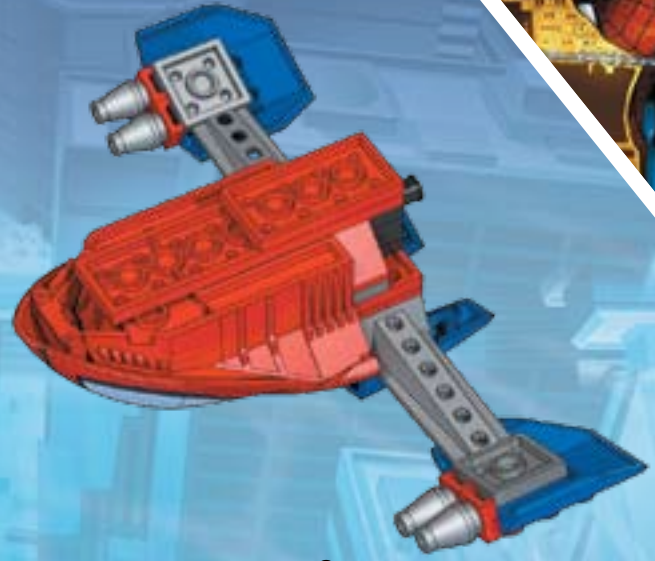
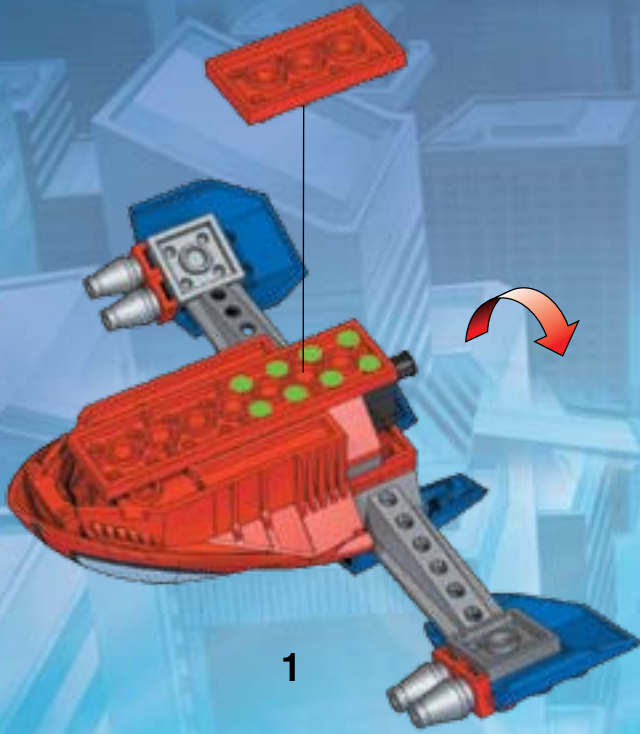

9

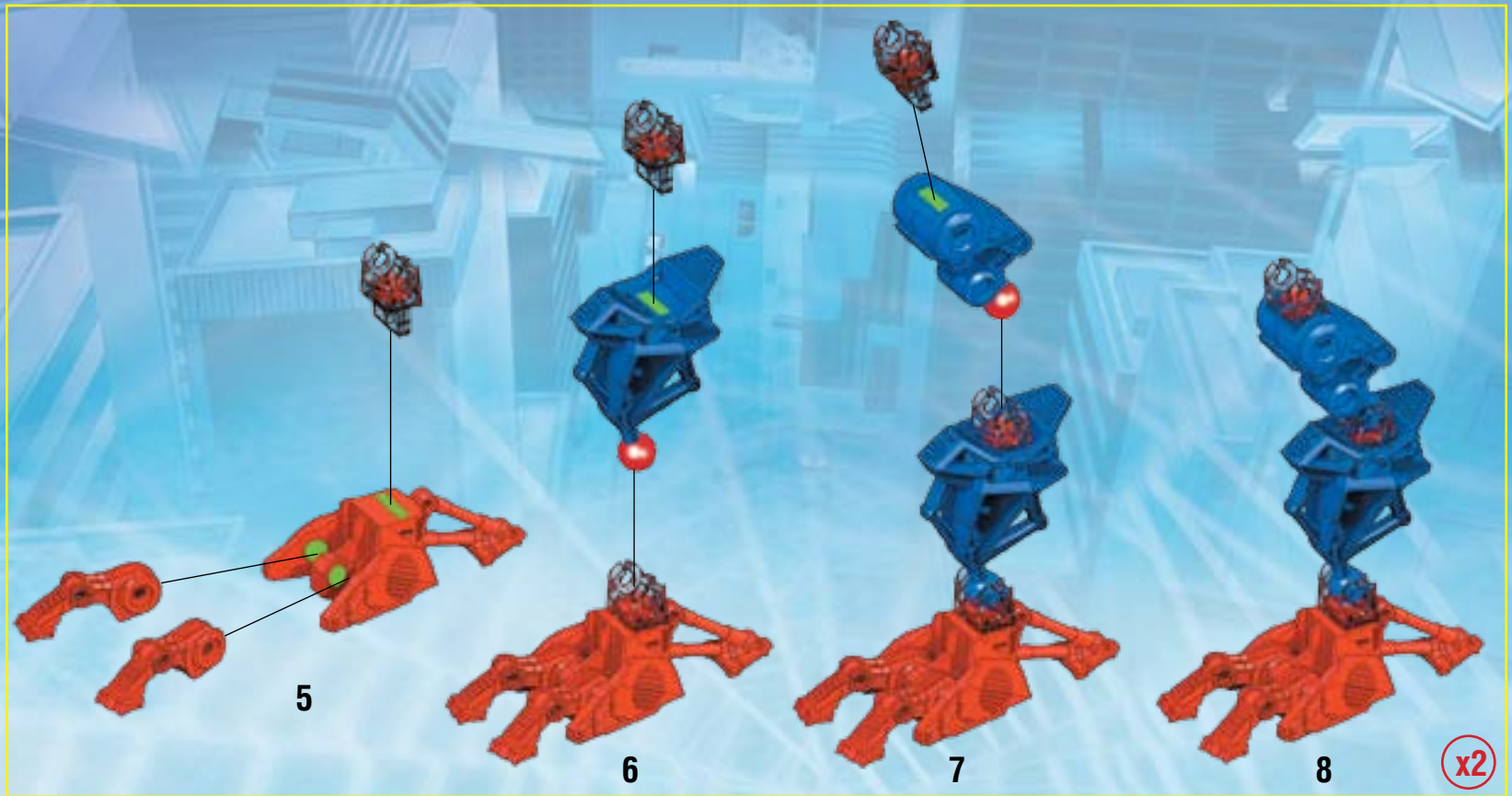

10



11



1X



2X

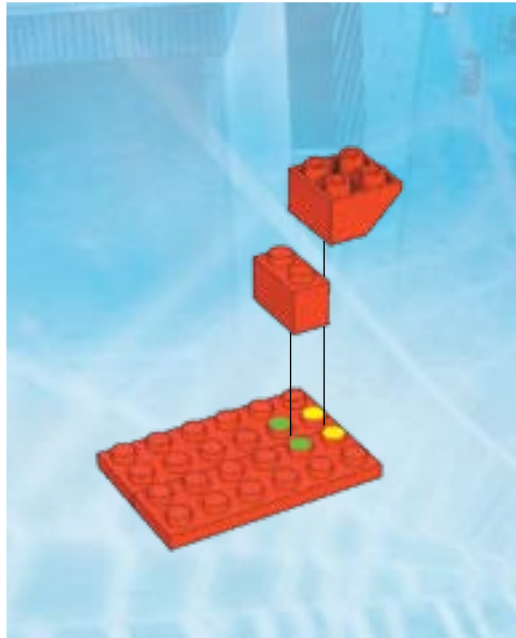

12



2X



1X

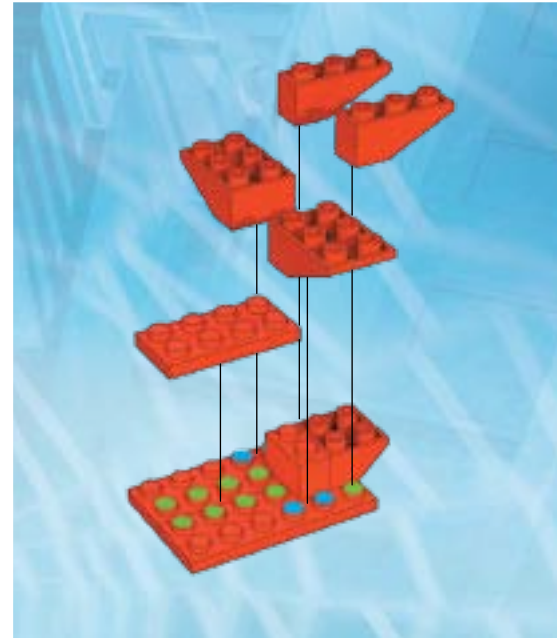

13

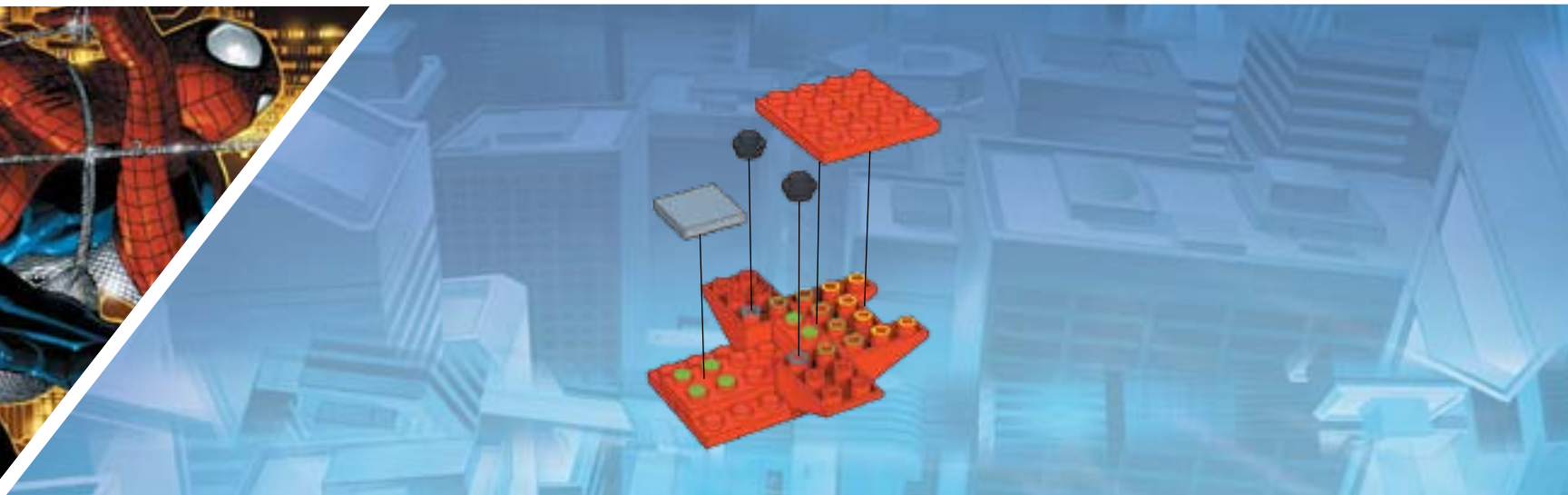

14

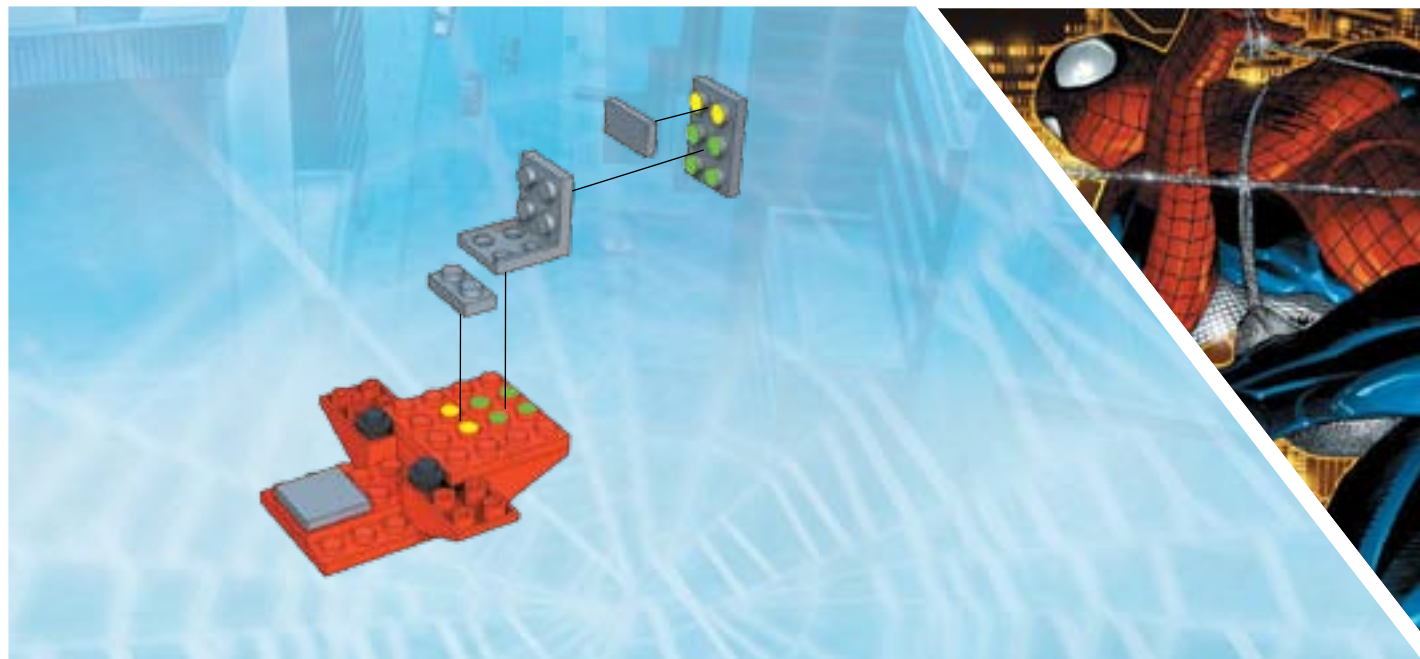

15



16



17

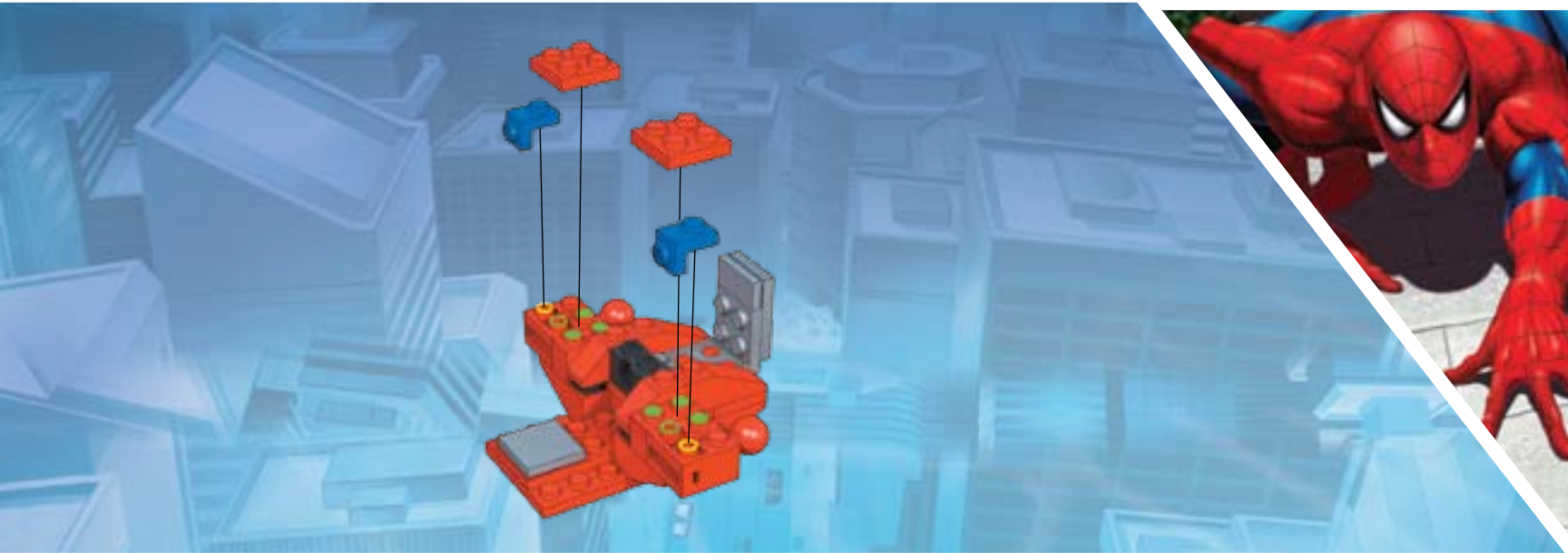

18

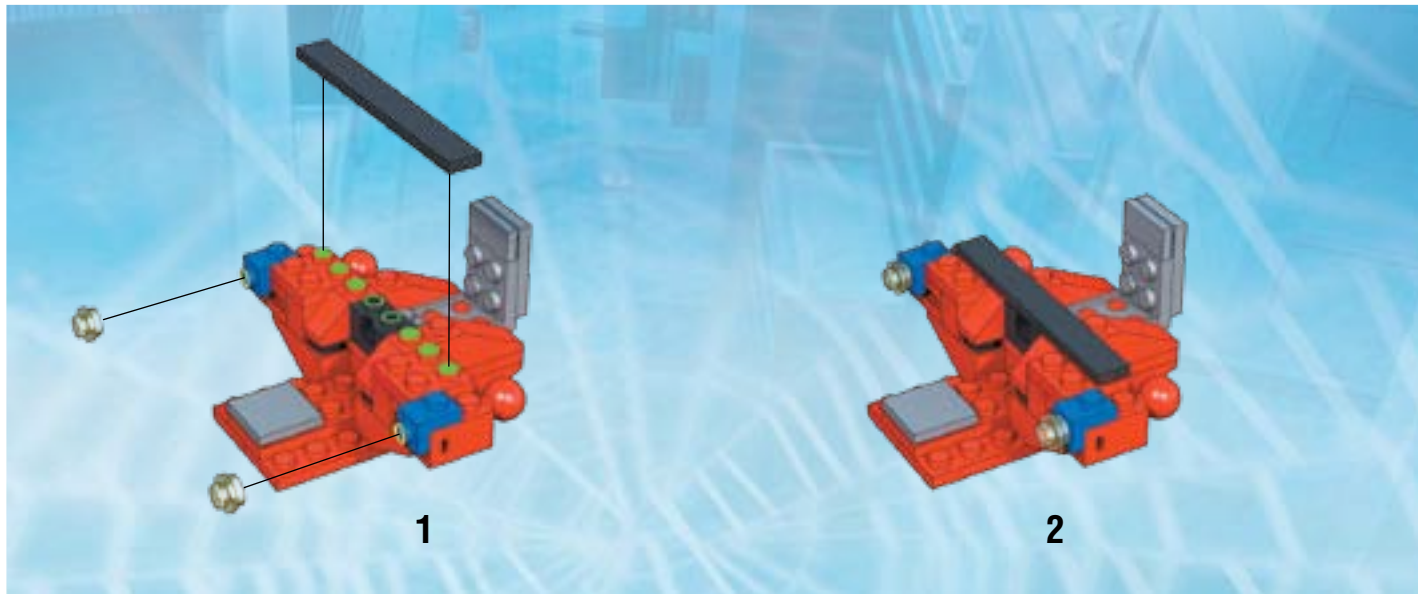
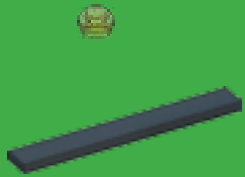

1

2

19

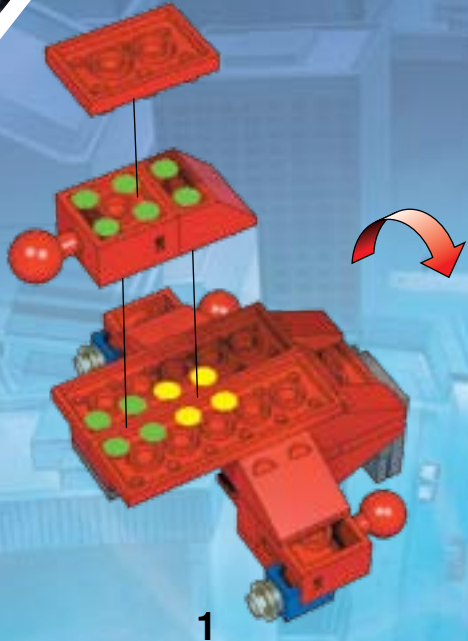

1



2

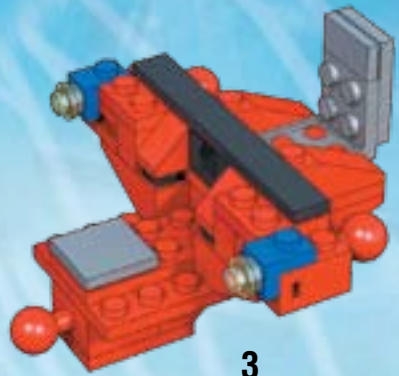

3

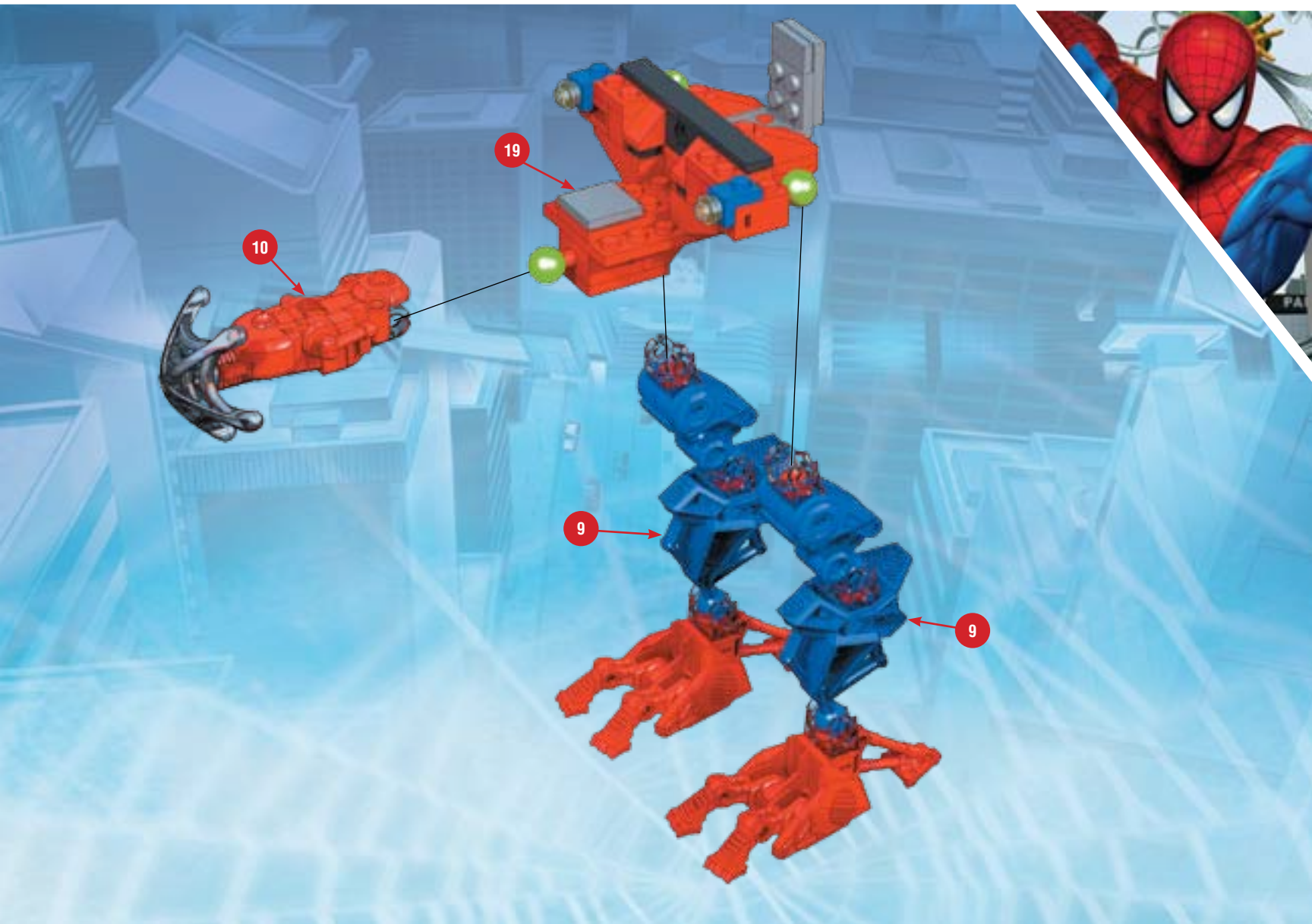

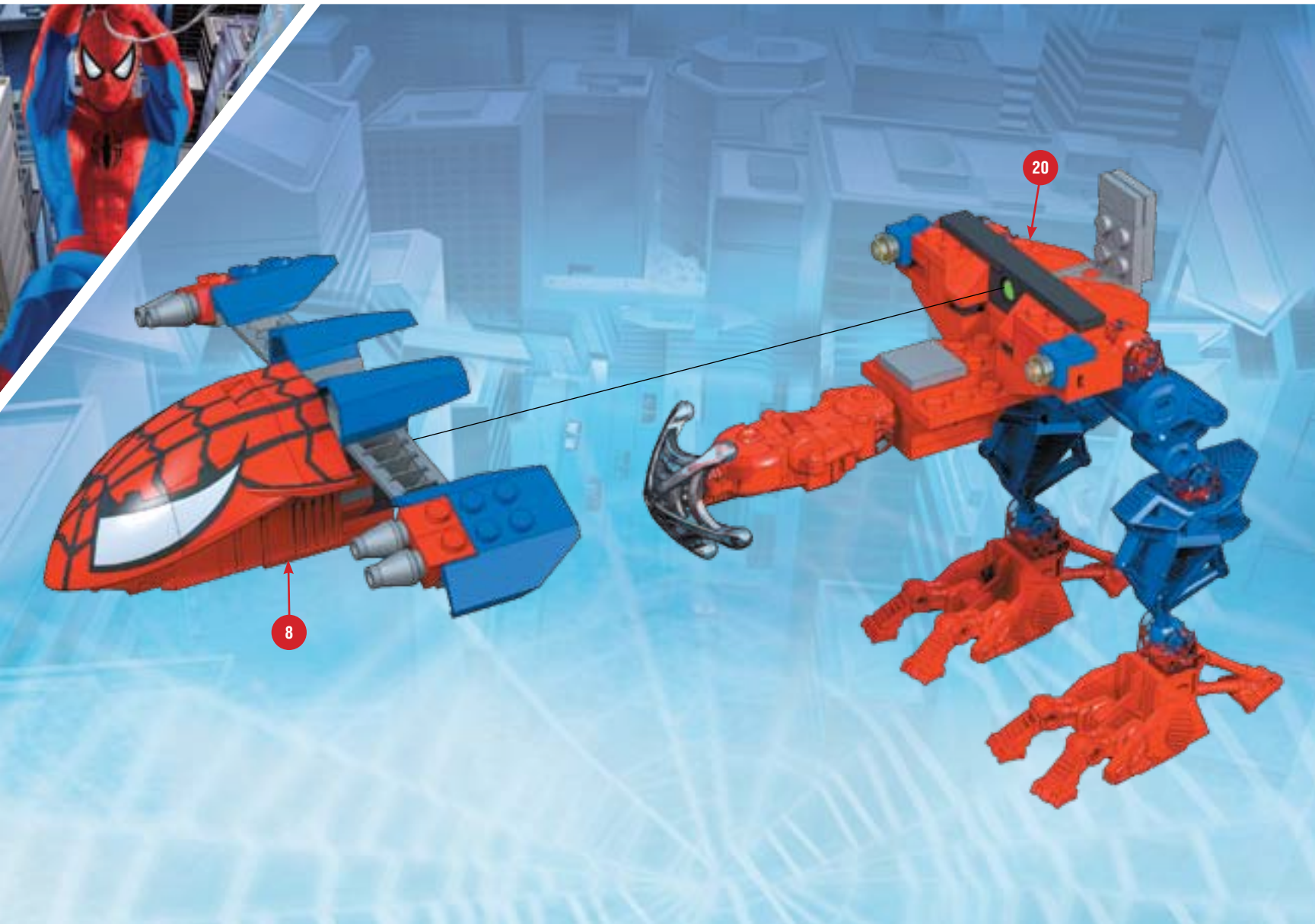

8

20



THE AMAZING SPIDER-MAN

MEGA BLOKS

2027



2023
Spider-Man®

Also available
También disponible / Également disponible
Ebenfalls erhältlich / Ook beschikbaar
Anche disponibile / Também disponível



2023 + 2027 =



2028
Venom®



2024
Black Costume Spider-Man™



© 2008, MEGA Brands Inc. MEGA Brands Inc. and the MEGA Brands Inc. logo are registered trademarks of MEGA Brands Inc. / MEGA Brands Inc. y el logotipo MEGA Brands Inc. son marcas registradas de MEGA Brands Inc. / MEGA Brands Inc. et le logo de MEGA Brands Inc. sont des marques de commerce déposées de MEGA Brands Inc. / MEGA Brands Inc. und das MEGA Brands Inc.-Logo sind eingetragene Warenzeichen von MEGA Brands Inc. / MEGA Brands Inc. en het MEGA Brands Inc. logo zijn gedeponeerde handelsmerken van MEGA Brands Inc. / MEGA Brands Inc. ed il logo di MEGA Brands Inc. sono marchi di fabbrica di MEGA Brands Inc. MEGA Brands Inc. e o logo MEGA Brands Inc. são marcas registradas de MEGA Brands Inc.

Printed in China AD020271