

IRON MAN 2™



MARK II

MARK VI



16x
AV01113AU

5x
AV01113SE

4x
AV01113AD

2x
AV0910AGV

4x
AV0910AGV

2x
AM154B5AGV

2x
AM154B5KM

2x
AV0910AGV

7x
MA12251SF

4x
AV0884AGV

3x
MA1140AGV

1x
MA1140SF

1x
AV0272AGV

1x
AM17161F

2x
AM16914AD

2x
AM16915AD

7x
MA1086AGV

11x
AV0390AGV

4x
AM07590SE

7x
AM0883AGV

4x
AM09898SE

1x
AM09898SF

2x
AM04428SE

1x
AM17162F

1x
AM0373AGV

2x
AM03013AGV

1x
AS0195906

2x
M0948W

8x
AV01322AGV

1x
AM09013SF

2x
AM09013FH

3x
MA1154AGV

2x
MA10273AGV

2x
MA10273KM

1x
AM09023KM

2x
AM09023AGV

1x
AM1500AGV

1x
AM15017AGV

1x
AM15022AGV

1x
AM15023AGV

1x
AM15018AGV

1x
AM15024AGV

1x
AM15021AGV

1x
AM15019AGV

2x
AV0486AGV

2x
AM01314SE

7x
AM01314AGV

2x
AM03772AGV

1x
AM03888AGV

1x
AM09593AGV

1x
AM09493SE

1x
AM07475SF

1x
AM07475AGV

1x
AM09292SF

3x
AM03292AGV

2x
AM01480AGV

5x
AM0883AGV

1x
AM16384SF

2x
MA1087AGV

2x
AM08600AU

1x
AM03033KM

3x
AM03083AGV

2x
AM01313AGV

1x
AM04883AGV

2x
AM04883KM

1x
AM15001AKM

1x
AM15003KM

1x
AM15009AKM

1x
AM15002AKM

1x
AM15009AKM

1x
AM15007AKM

1x
AM15009AKM

1x
AM15004AKM

1x
AM15064SF

2x
AM08514SF

1x
AM01880SF

2x
MA1123SE

5x
AM03767AU

2x
AM06618AGV



1x
AS0195901



1x
AS0195902



1x
SA1116SF



1x
AM02809SF

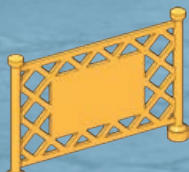

1x
AM02391SF

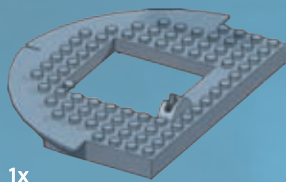

1x
AM16878AGV

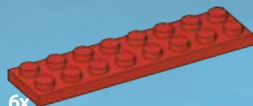

6x
AV03483AKM



1x
AM08488SE

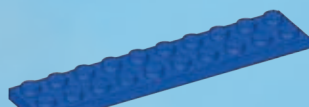

1x
AM09923SE



2x
AM02412RH

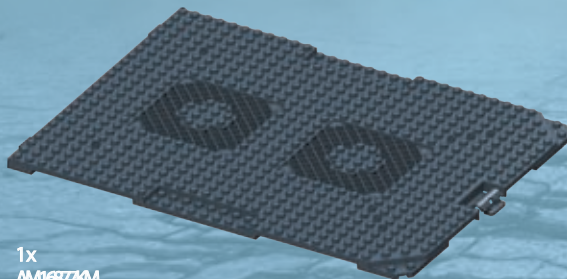

1x
AM16877KM



1x
AS0195903



1x
AL019591



1x
AX019592

EN Please read these instructions carefully before first use and keep them for future reference. / **ES** Leer estas instrucciones cuidadosamente antes de la primera utilización y guardarlas para referencia futura. / **FR** Il est recommandé de lire attentivement ce feuillet avant la première utilisation et de le conserver pour référence future. / **DE** Die Gebrauchsanleitung bitte durchlesen und aufbewahren. / **NL** Wij raden u aan deze handleiding zorgvuldig te lezen en te bewaren voor eventuele raadpleging op een later tijdstip. / **IT** Leggere le istruzioni prima di cominciare ad usare il gioco e conservarle per referenze future. / **PT** Leia as instruções antes do primeiro uso e guarde-as para futura referência.



IRON MAN 2, the Movie: © 2010 MVL Film Finance LLC. Marvel, Iron Man, all related character names and their distinctive likenesses: TM & © 2010 Marvel Entertainment, Inc. and its subsidiaries. All rights reserved.



2x
AS0195905



1x
AS0197303



1x
AS0197305



1x
AS0197302



1x
AM17163AKM

- EN** ⚠️ **WARNING:**
CHOKING HAZARD - Small parts.
Not for children under 3 years.
- ES** ⚠️ **ADVERTENCIA:**
PELIGRO DE ASFIXIA. - Contiene piezas pequeñas.
No recomendado para niños menores de 3 años.
- FR** ⚠️ **AVERTISSEMENT:**
RISQUE DE SUFFOCATION. - Présence de petits éléments.
Ne convient pas aux enfants de moins de 3 ans.
- DE** ⚠️ **WARNUNG:**
ERSTICKUNGSGEFAHR. - Enthält kleine Teile.
Nicht für Kinder unter 3 Jahren geeignet.
- NL** ⚠️ **WAARSCHUWING:**
VERSTIKKINGSGEVAAR. - Bevat kleine onderdelen.
Niet geschikt voor kinderen onder de 3 jaar.
- DA** ⚠️ **ADVARSEL:**
KVELNINGSFARE. - Indeholder smådele.
Ikke til børn under 3 år.
- EL** ⚠️ **ΠΡΟΕΙΔΟΠΟΙΗΣΗ:**
ΚΙΝΔΥΝΟΣ ΠΝΙΓΙΜΑΤΟΣ. - Περιέχει μικρά αντικείμενα.
Όχι για παιδιά κάτω των 3 ετών.
- FI** ⚠️ **VAROITUS:**
TUKEHTUMISVAARA. - Sisältää pieniä osia.
Ei alle 3-vuotiaille lapsille.
- IT** ⚠️ **ATTENZIONE:**
PERICOLO DI SOFFOCAMENTO. - Contiene piccole parti.
Non indicato per bambini sotto i 3 anni.
- NO** ⚠️ **ADVARSEL:**
KVELNINGSFARE. - Inneholder små deler.
Kun for barn over 3 år.
- PT** ⚠️ **ATENÇÃO:**
PERIGO DE ASFIXIA. - Contém peças pequenas.
Não é concebido para crianças de menos de 3 anos.
- SV** ⚠️ **VARNING:**
KVÄVNINGSRISK. - Innehåller små delar.
Inte för barn under 3 år.
- JA** ⚠️ **警告:**
窒息の危険性 - 小さな部品が含まれています
3歳以下の子供には与えないで下さい。
- ZH** ⚠️ **警告:**
有窒息危險 - 包含有小部件
不适合3岁以下的小孩玩。
- AR** ⚠️ **تحذير:**
خطر اختناق - قطع صغيرة.
غير صالحة للأطفال أقل من 3 سنوات.



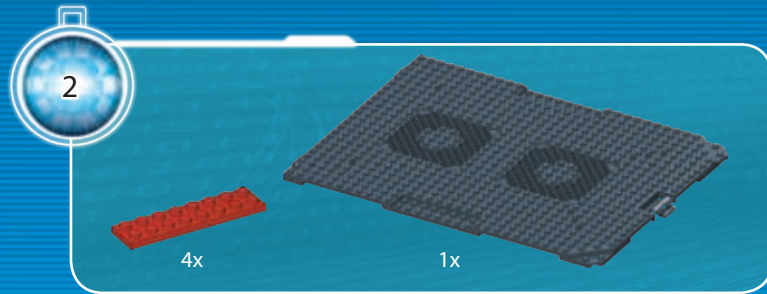
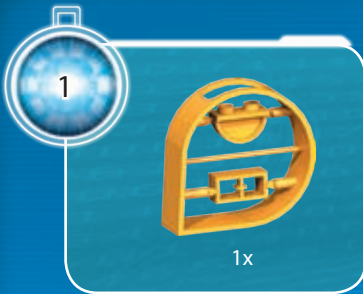

- EN** WARNING: Contains sharp points. Adult assembly required.
- ES** ADVERTENCIA: Contiene puntas muy agudas. Debe ser ensamblado por un adulto.
- FR** MISE EN GARDE: Contient des pièces à bout pointu. L'assemblage doit être fait par un adulte
- DE** ACHTUNG: Enthält scharfe Kanten. Muss von Erwachsenen zusammengebaut werden.
- NL** WAARSCHUWING: Bevat scherpe punten. Vereist montage door volwassene.
- DA** ADVARSEL: Indeholder skarpe spidser. Montering af en voksen er obligatorisk.
- EL** ΠΡΟΕΙΔΟΠΟΙΗΣΗ : Περιέχει αιχμηρά σημεία. Απαιτείται σύνδεση από ενηλίκους.
- FI** VAROITUS: Sisältää teräviä osia. Kokoamiseen tar vitaan aikuinen.
- IT** ATTENZIONE: Contiene punte affilate. Deve essere montato da un adulto.
- NO** ADVARSEL: Spisse dele r. Må settes sammen av voksne.
- PT** ADVERTENCIA: Contém pontas agudas. Requer montagem por adultos
- SV** VARNING: Innehåller vassa spetsar. Bör monteras av en vuxen
- JA** 警告：先の尖ったものが含まれています。組立は大人がしてください。
- ZH** 警告：含有尖刺。需由成人組裝。
- AR** تحذير: تحتوي على حواف حادة. يلزم أن يتم التجميع بمعرفة شخص بالغ.

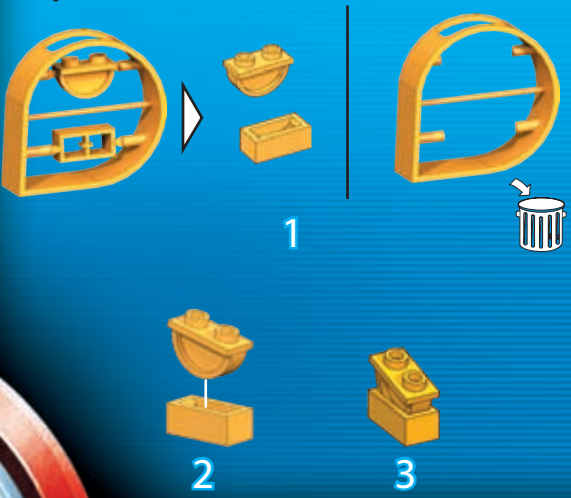
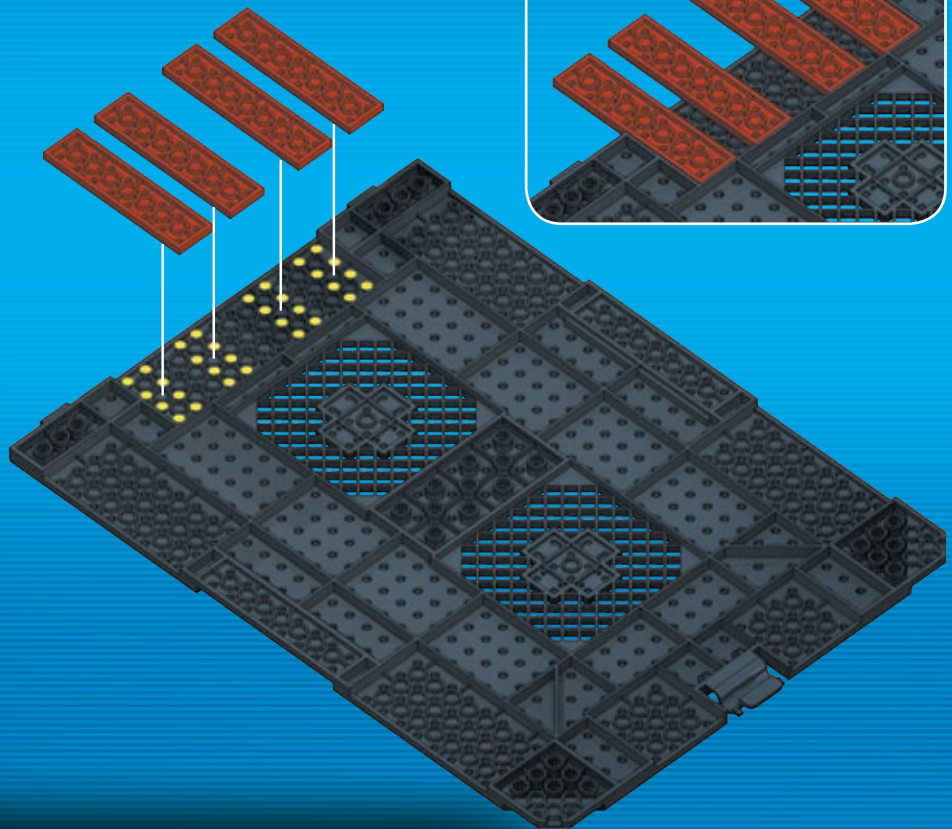
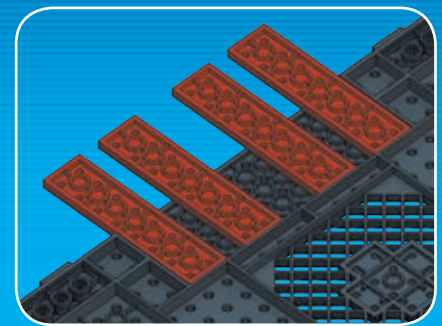

3

12x

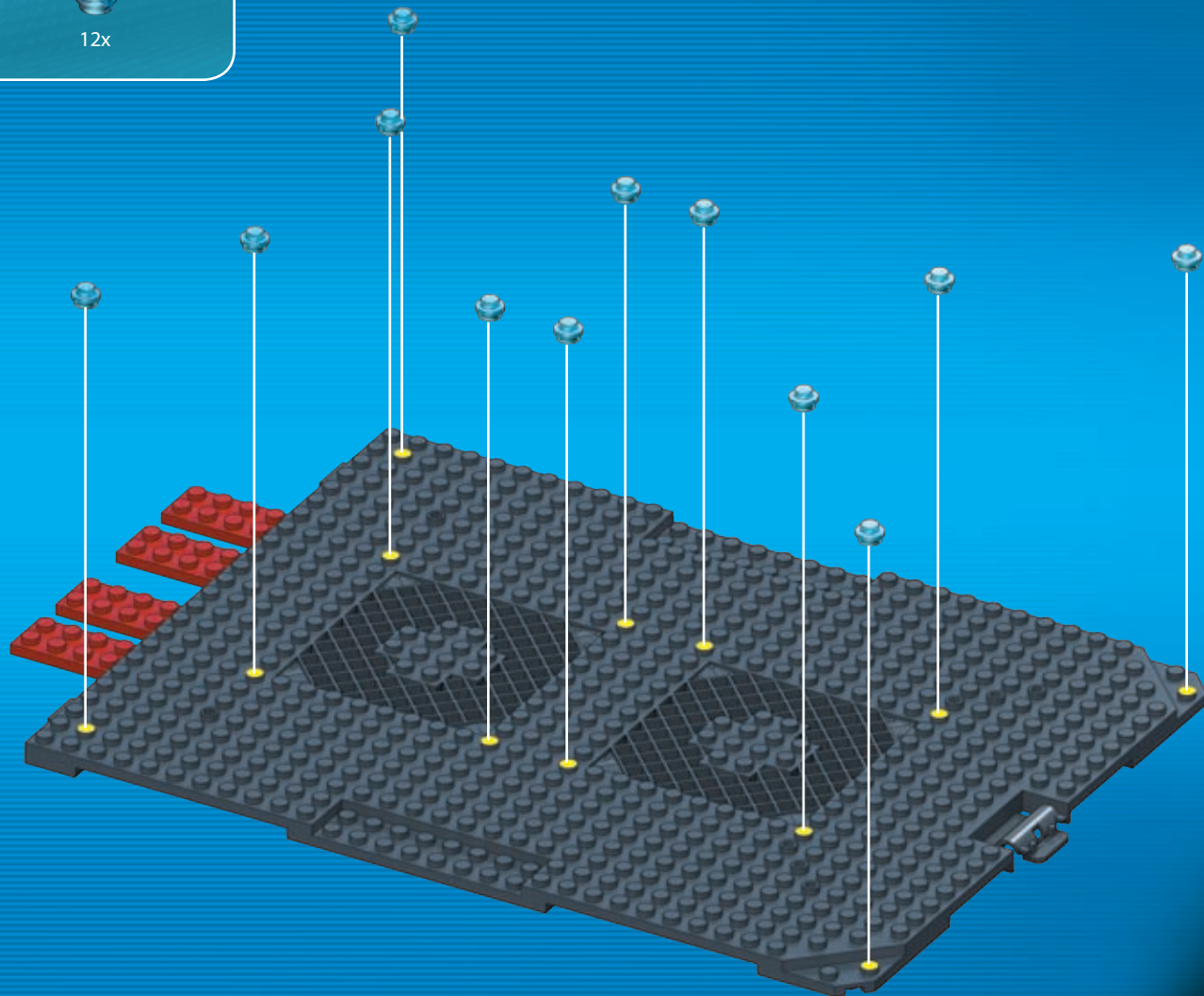
A callout box with a blue background and a white border. It features a circular icon with a blue pin inside, the number '3' in the center, and the text '12x' below it.

4



2x

8x

1x



2x

1x

2x

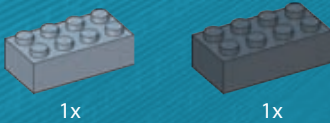

1x

1x

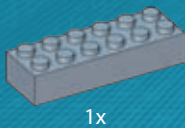

1x

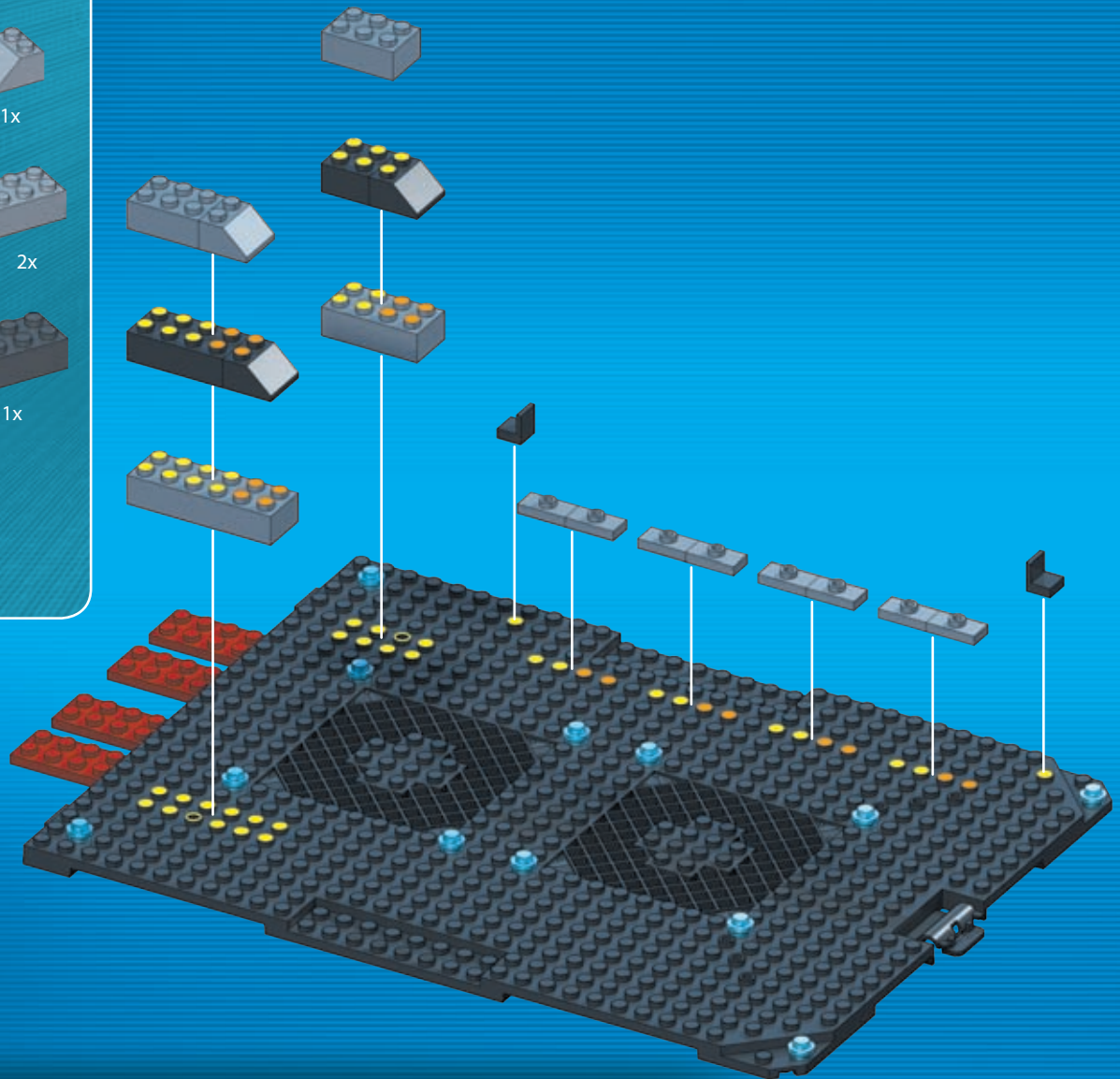

5

5x
2x
3x
1x

2x
2x
1x

1x
1x
2x

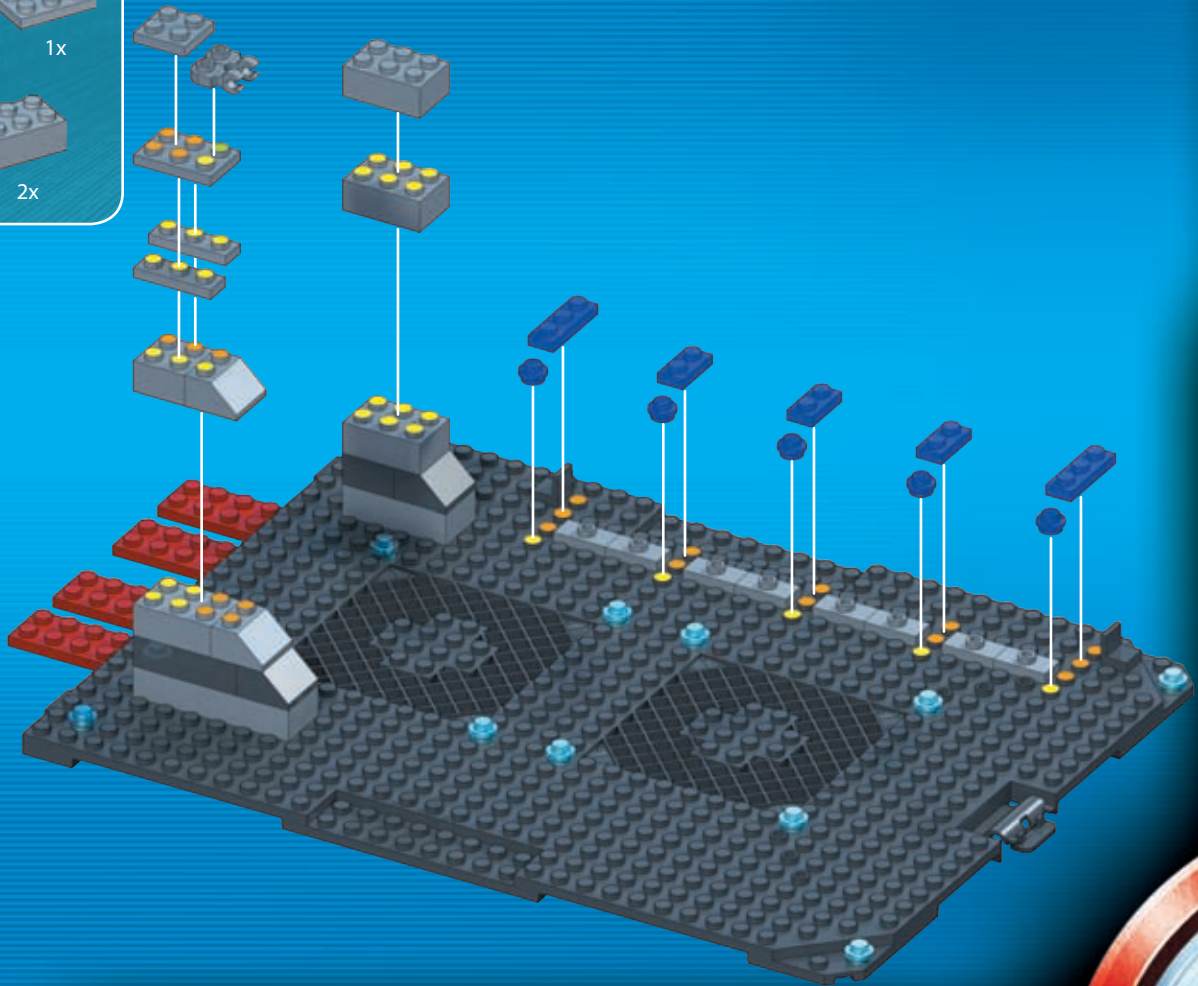

6

5x

5x

2x

2x

2x

2x

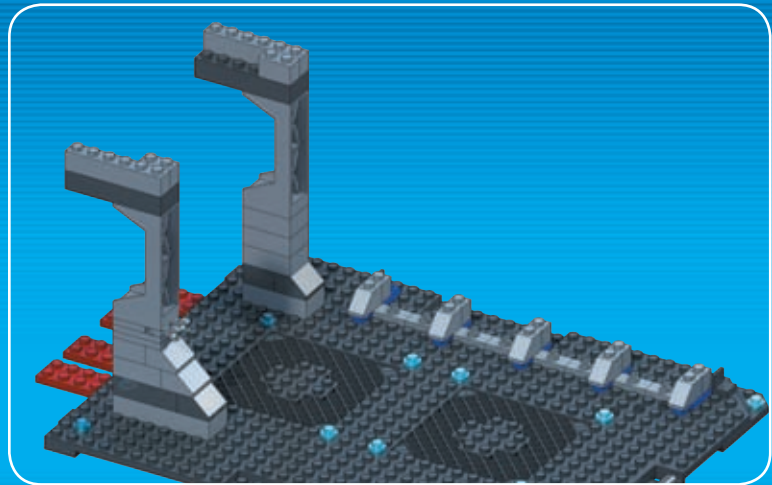
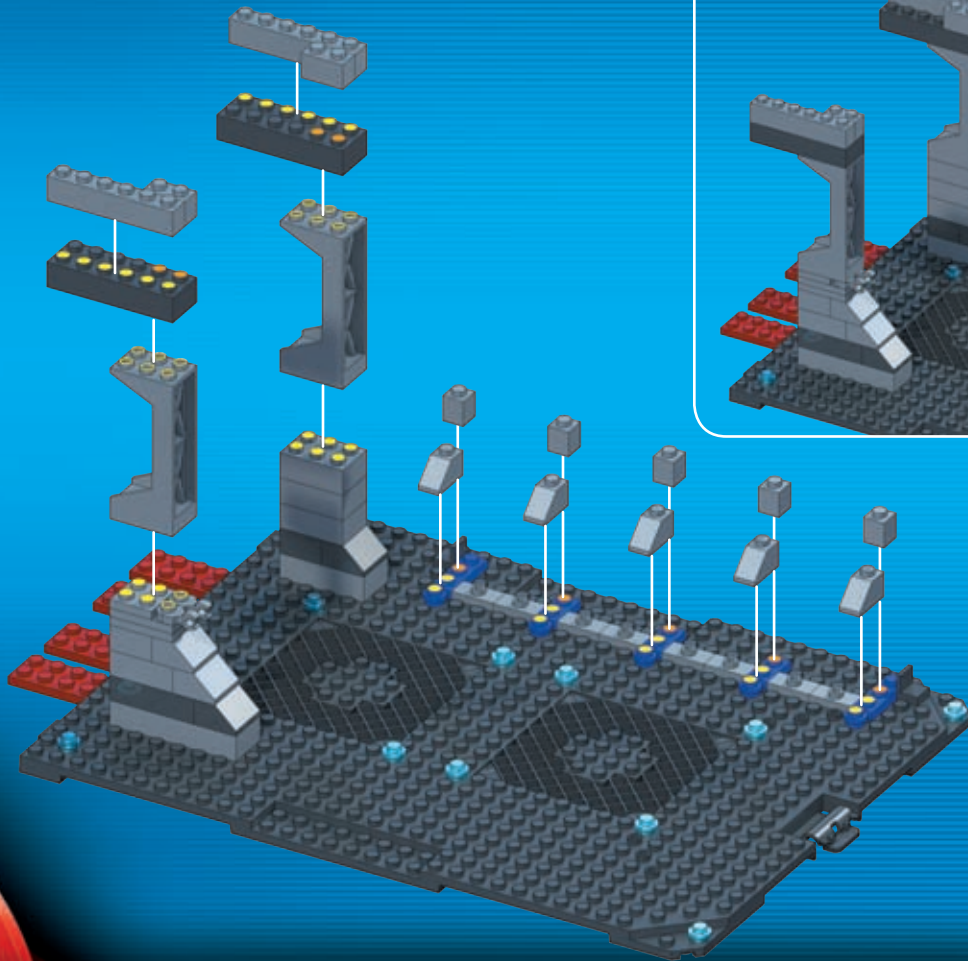

7

4x

1x

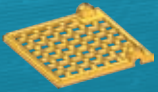

1x



1x



1x

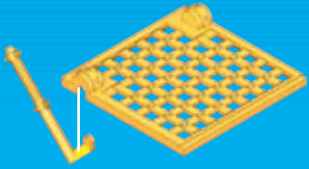

1

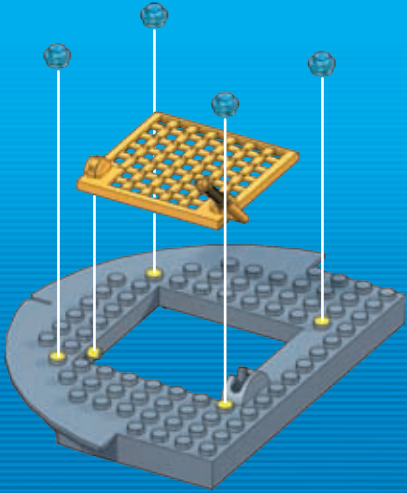

2

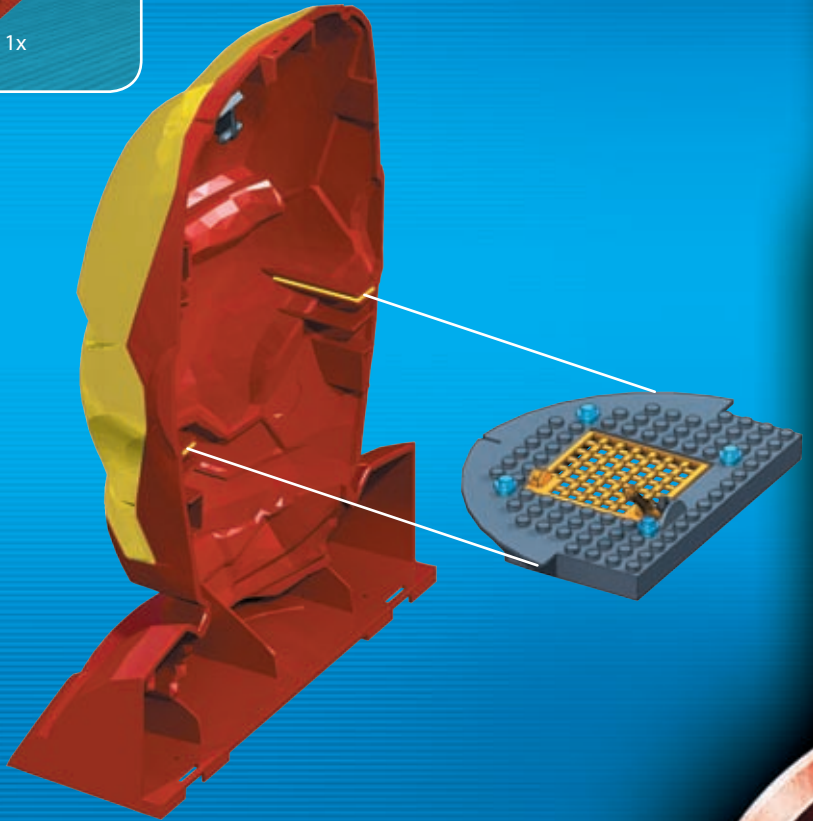

9

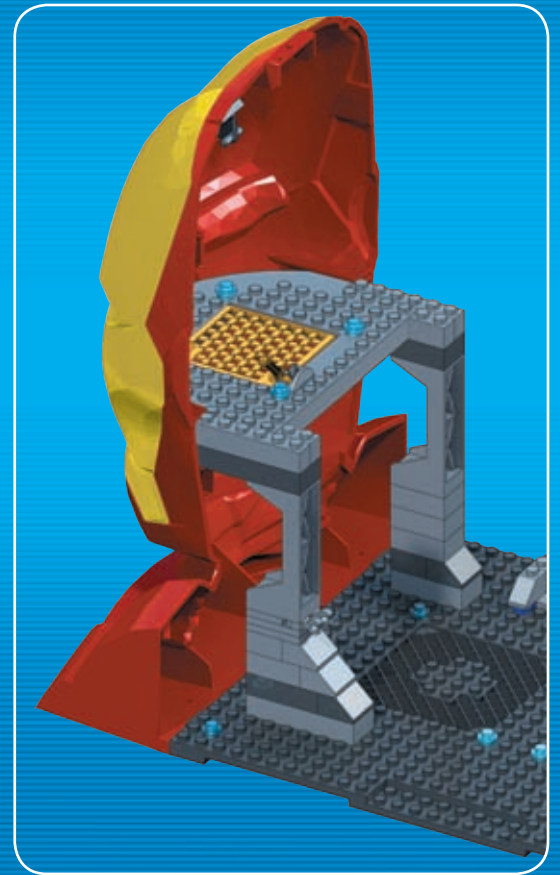
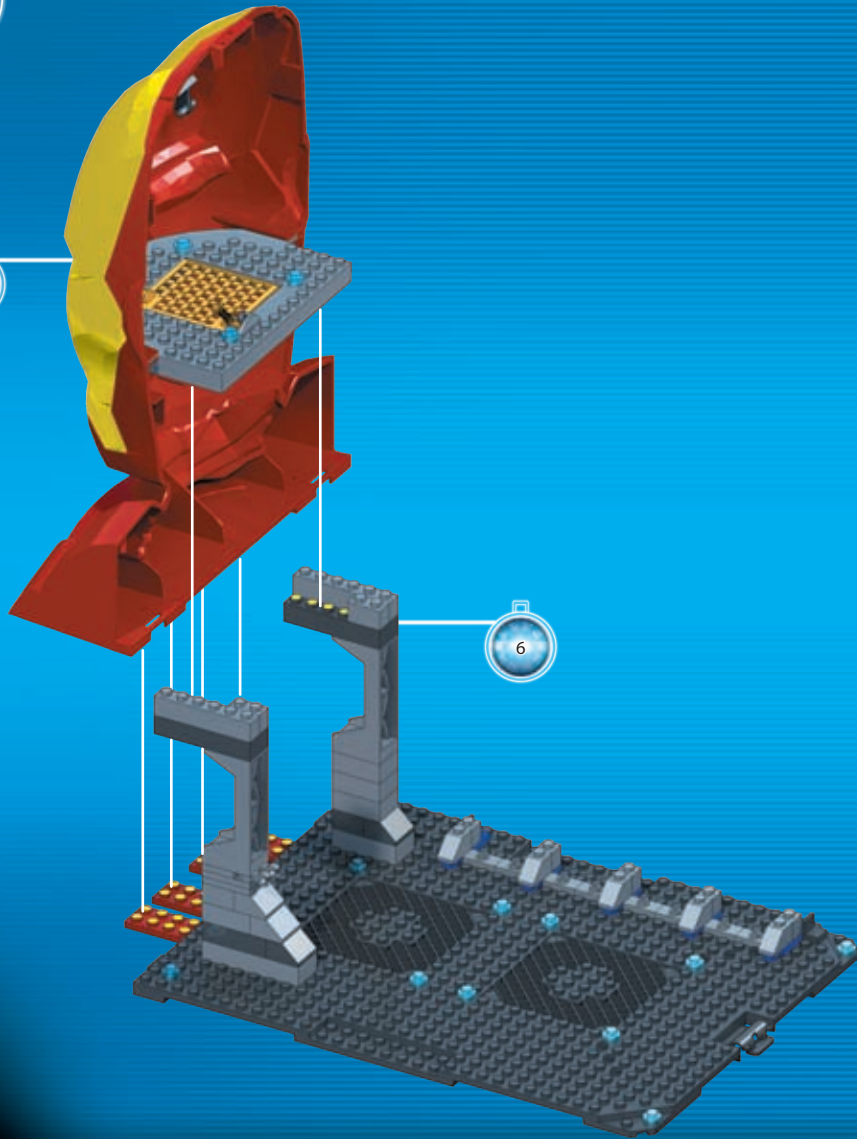

9



2x

1x

2x

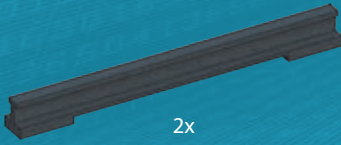

2x

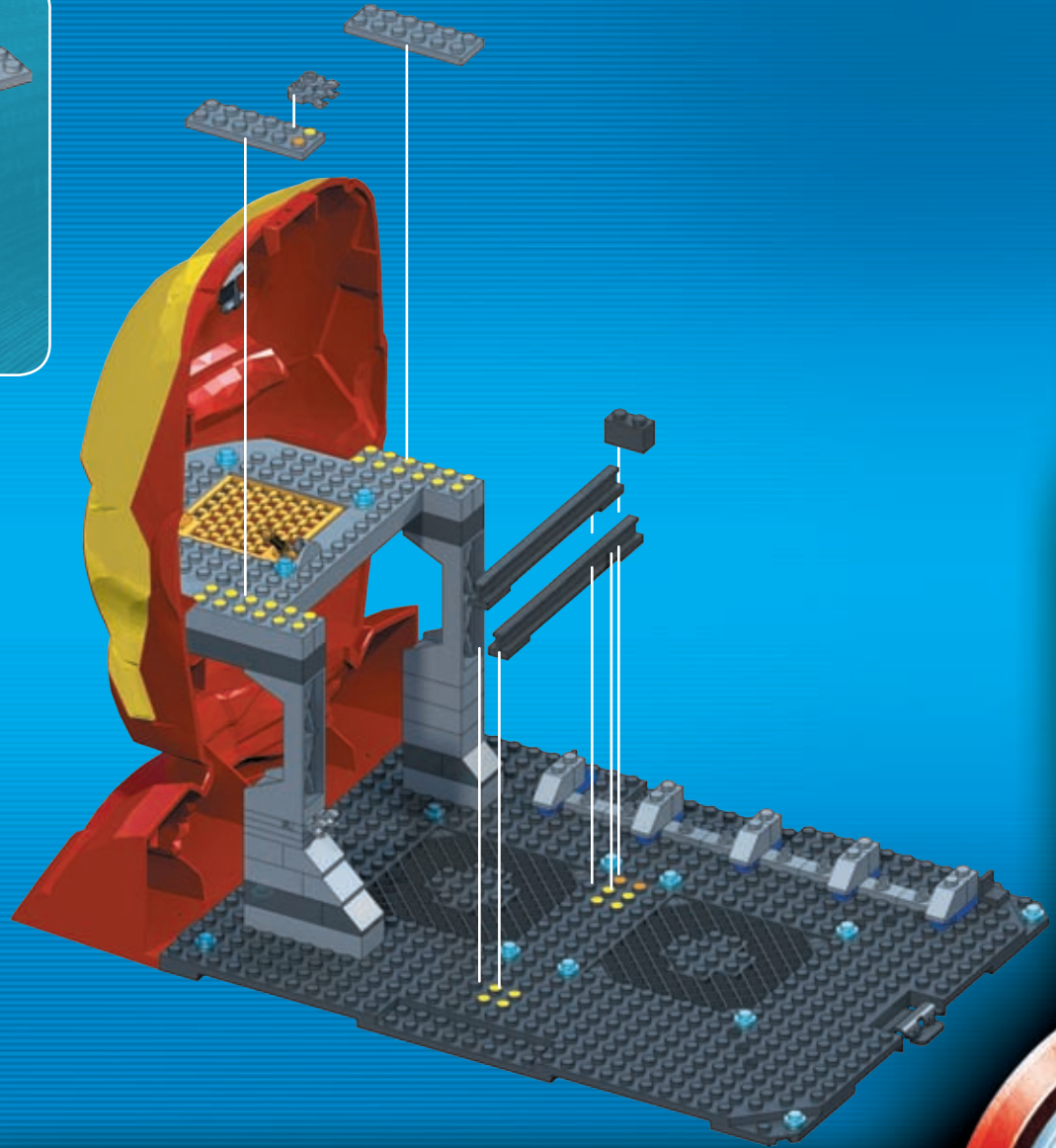

10



1x

2x

1x



5x



2x

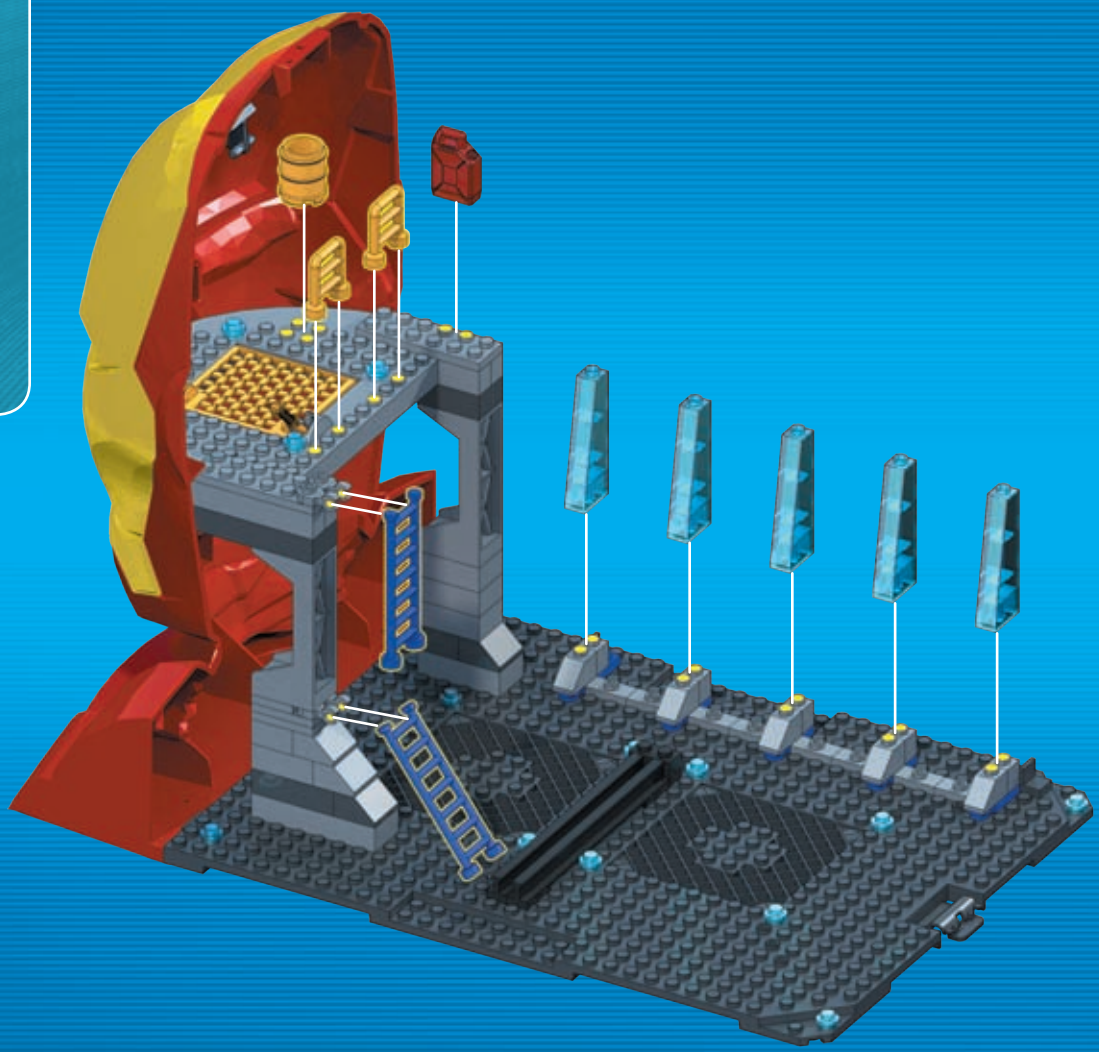

12

11

2x 3x 1x

1x 2x

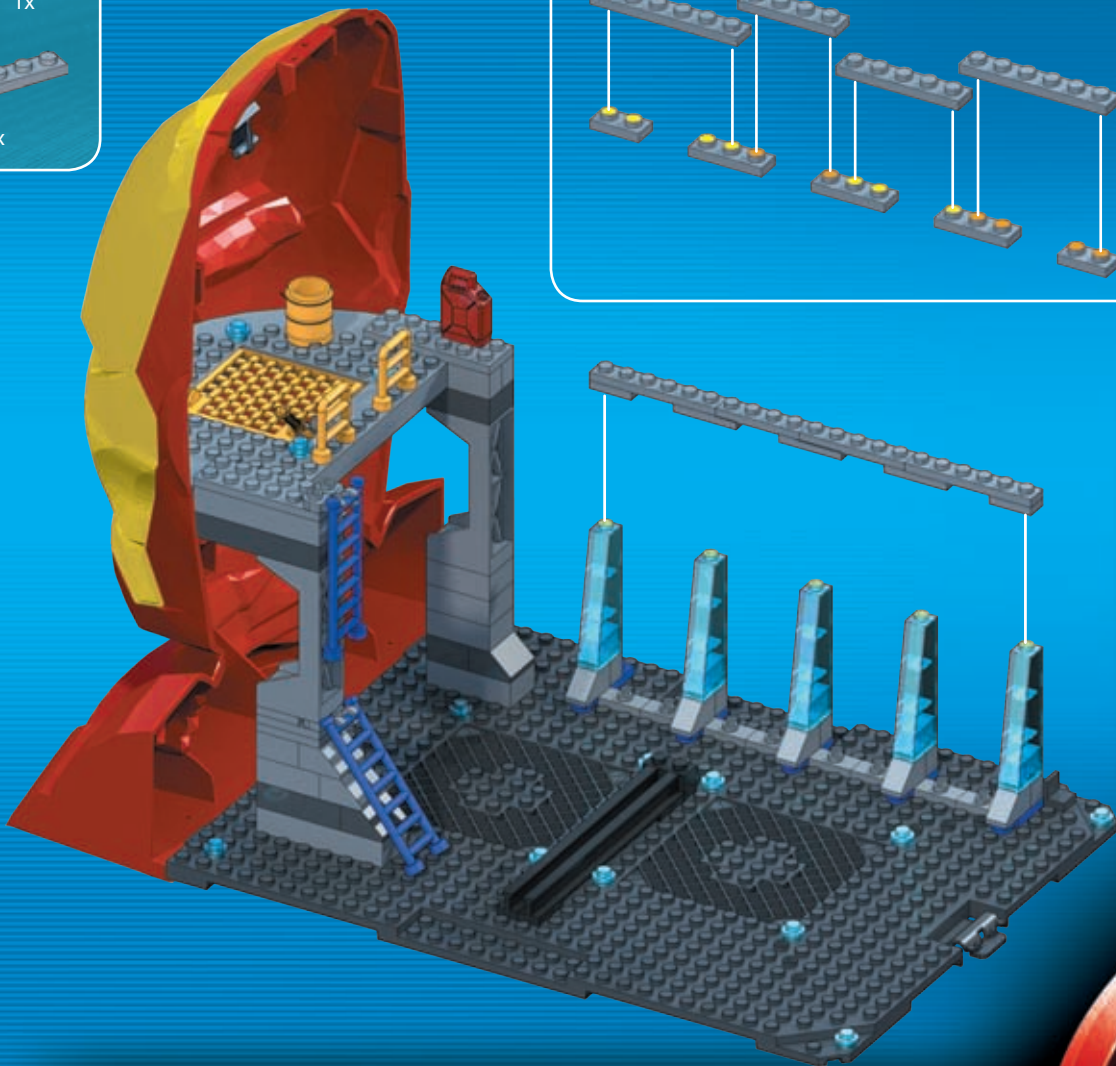
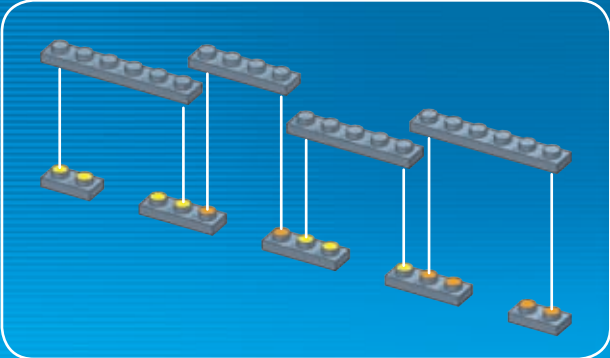

13

12



4x



2x



2x



2x



4x



4x



4x



2x

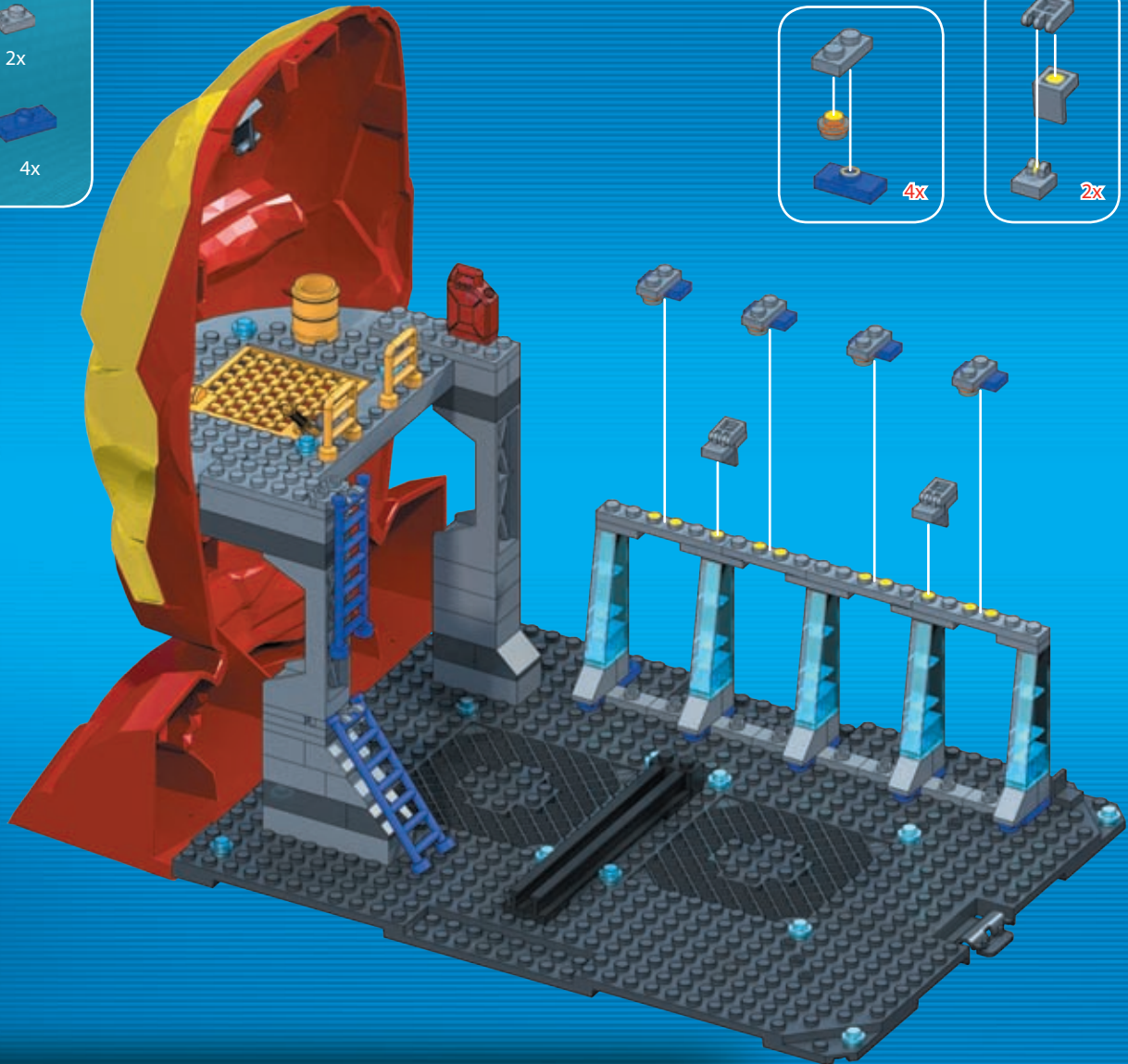

13

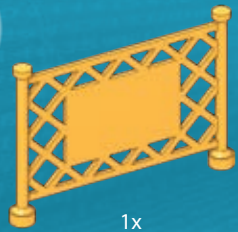

1x



7

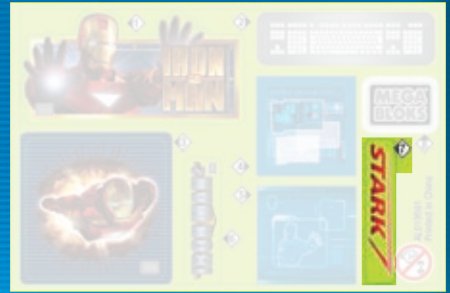

15

14

- 5x Yellow Technic 1x2 Bumpers
 - 1x Blue Technic 1x2 Plate
 - 1x Grey Technic 1x2 Brick with Technic Holes
 - 1x Grey Technic 1x4 Technic Beam
 - 1x Yellow Technic 1x2 Brick with 2 Holes
 - 1x Grey Technic 1x2 Brick with 2 Holes
 - 3x Grey Technic 1x2 Brick with 2 Holes
 - 1x Grey Technic 1x2 Brick with 2 Holes
 - 1x Yellow Technic 1x2 Brick with 2 Holes
 - 2x Grey Technic 1x2 Brick with 2 Holes
 - 1x Grey Technic 1x5 Technic Beam
 - 1x Blue Technic 1x5 Technic Beam
 - 1x Blue Technic 1x10 Technic Beam
 - 1x Blue Technic 1x15 Technic Beam
- Tools:
1x Grey Technic Axle
1x Grey Technic Hammer
1x Grey Technic Pin
1x Grey Technic Wrench
1x Grey Technic Curved Pin

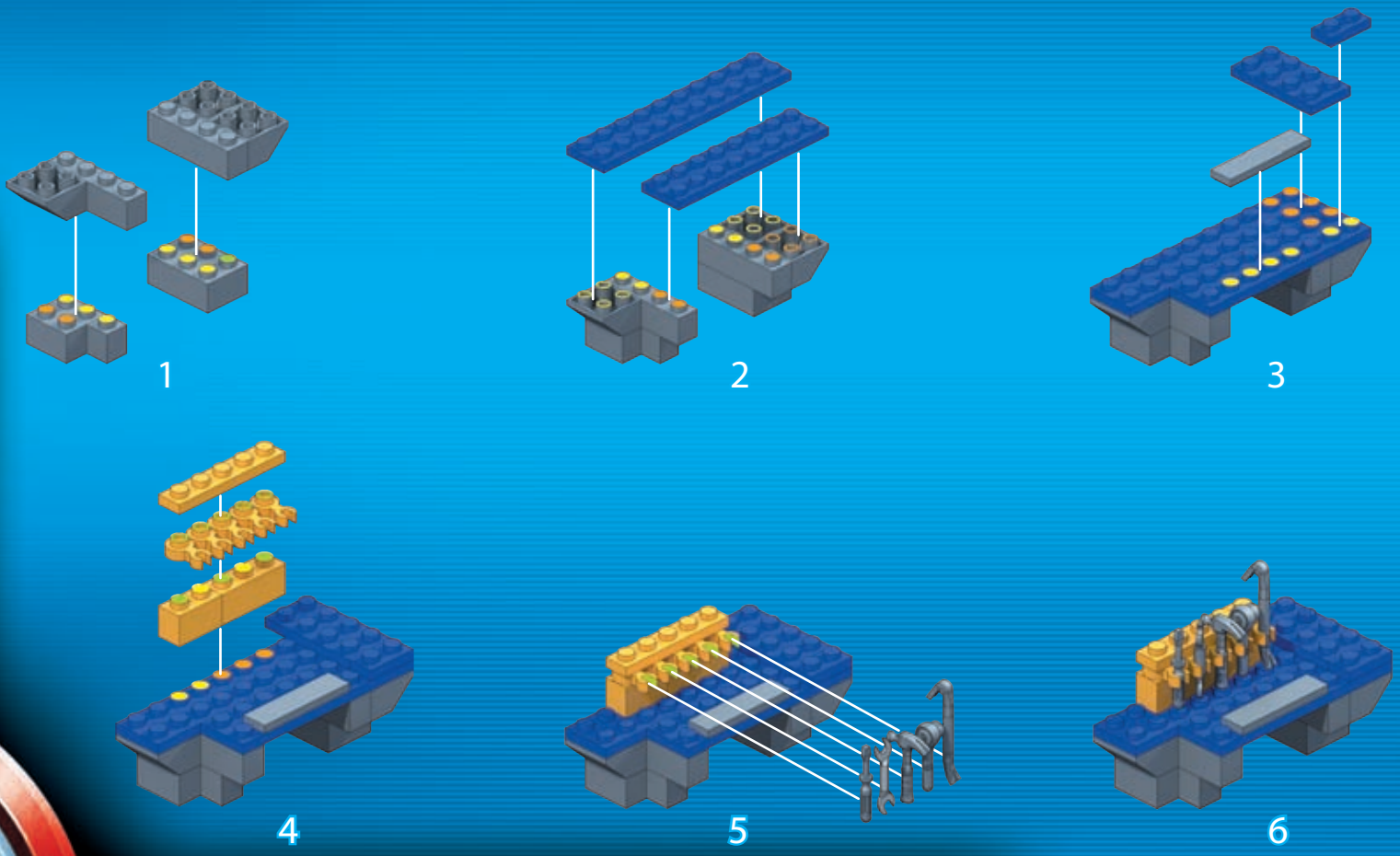

16

15

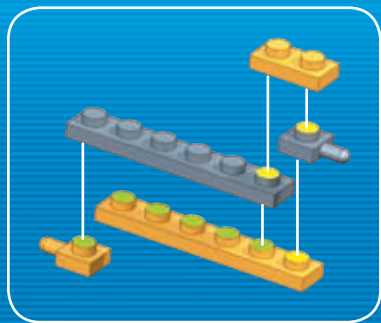
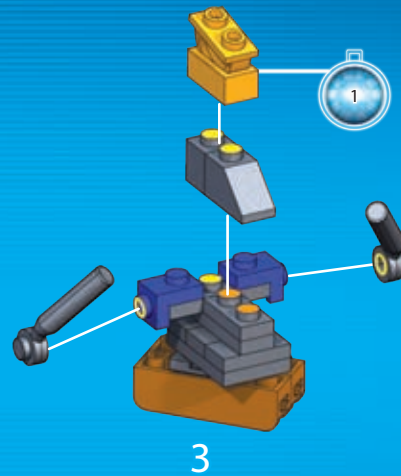
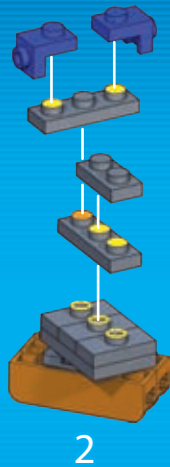
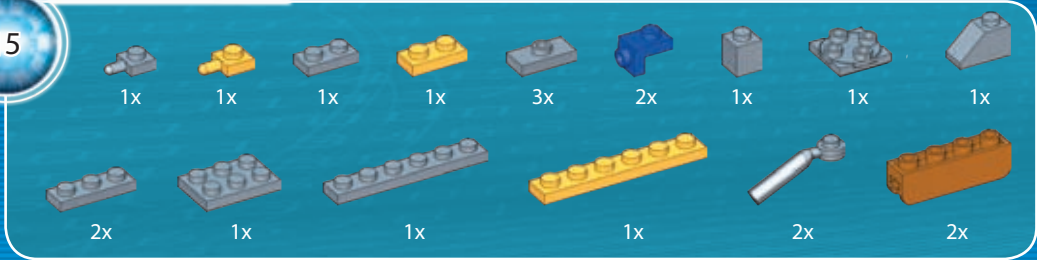

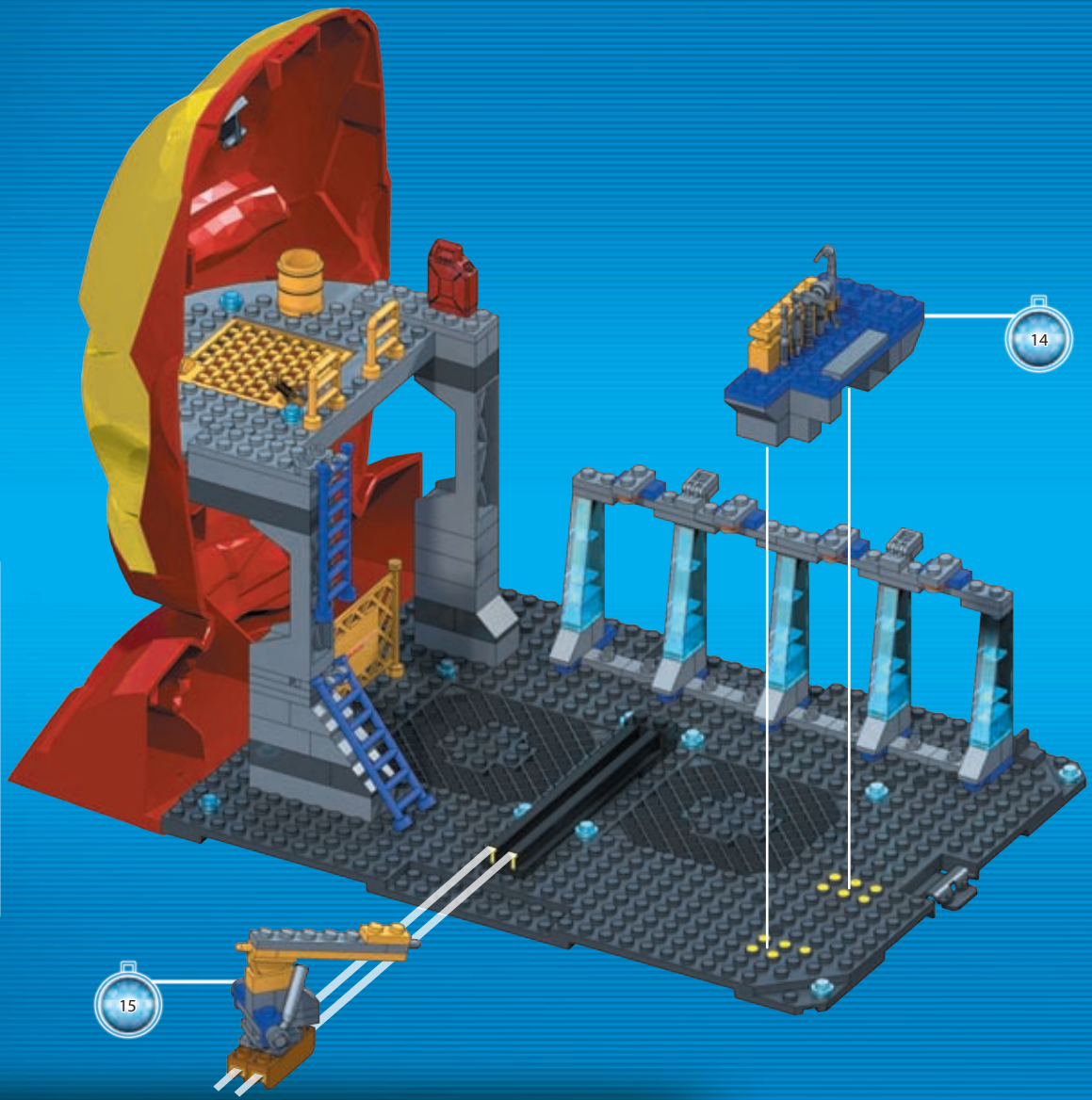
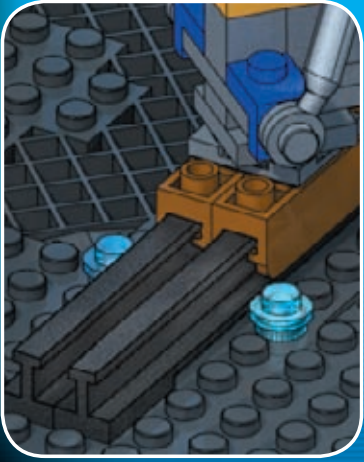

16



15

14

17

- 2x 
- 2x 
- 1x 
- 2x 
- 1x 



2 4 5



Choose best place for extra stickers
| Selecciona el mejor lugar para las
pegatinas adicionales | Place les
autres autocollants à l'endroit de
ton choix | Wähle die ideale Stelle
für Extra-Aufkleber | Kies de beste
plek voor extra stickers | Scegli il
posto migliore per gli altri adesivi
| Escolha o melhor local para os
adesivos extra

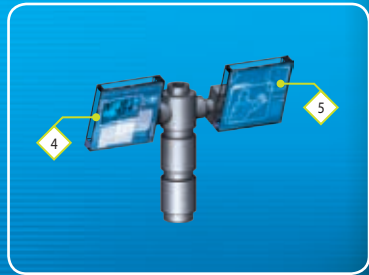
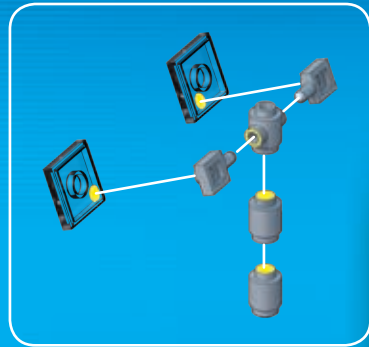

18



1x



1x



1x



2x

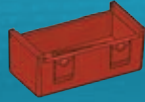

1x

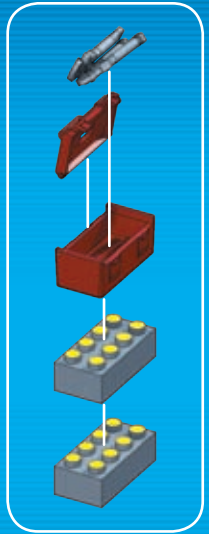
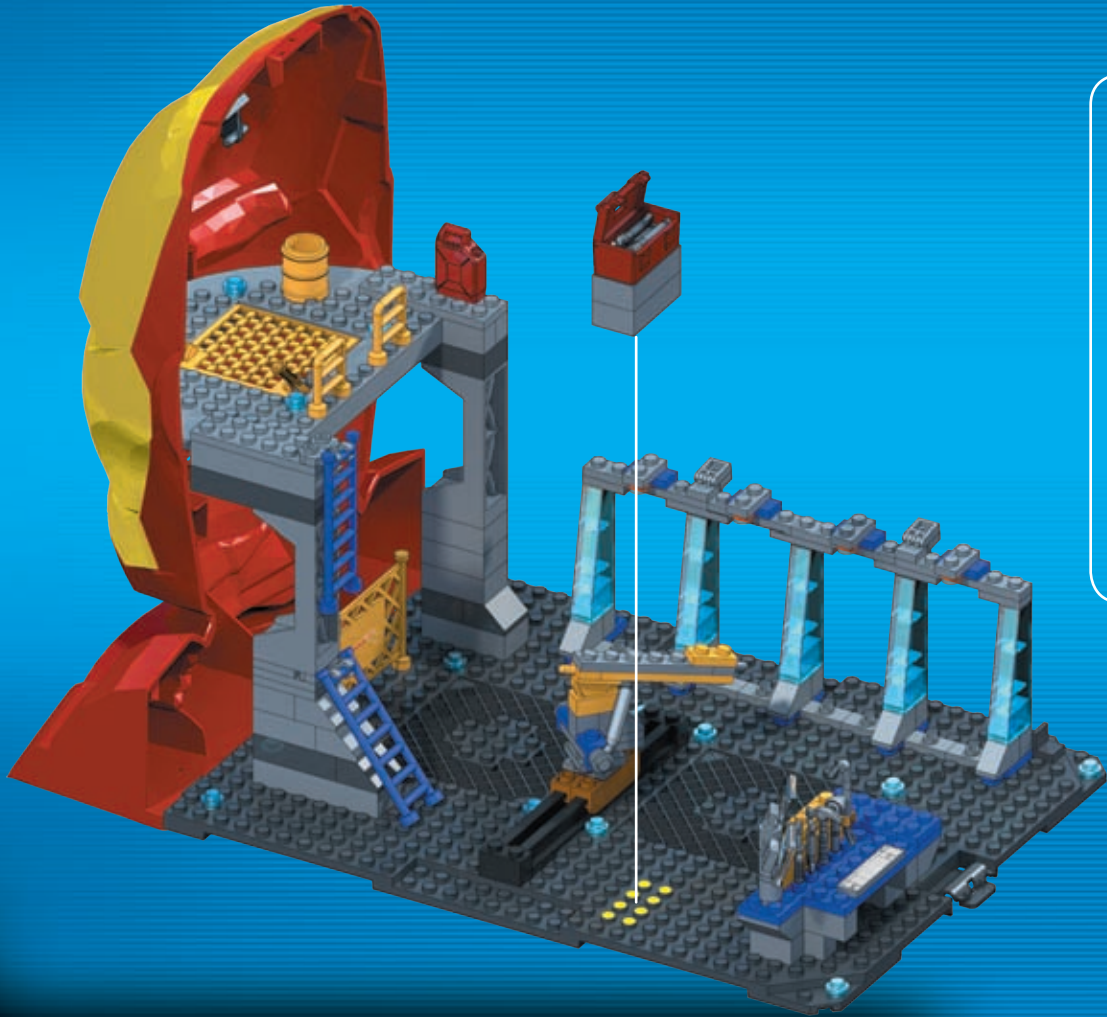

20

19

2x



1x



1x



1x



1x



1x



1x

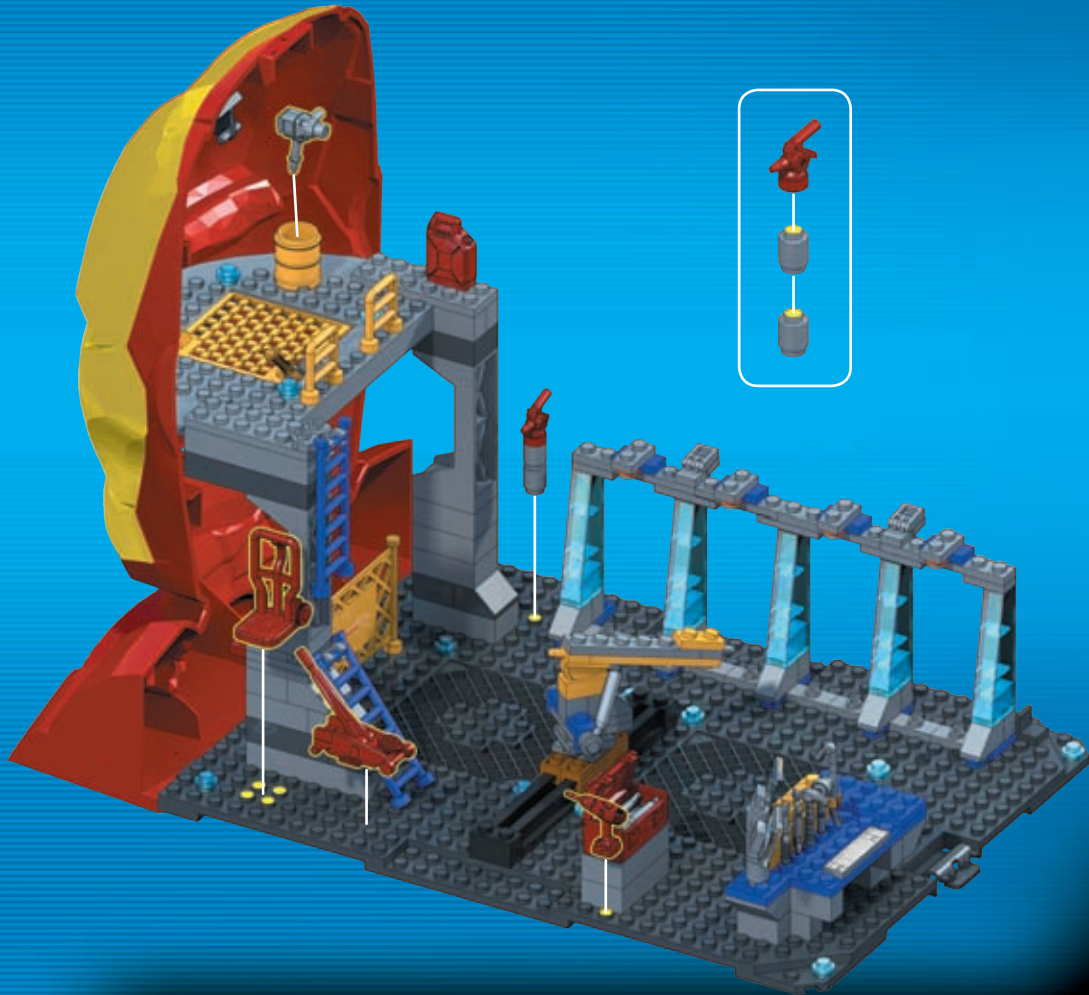
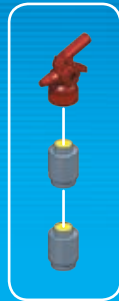

20



2x



1x

COLLECT & DISPLAY IN THE HALL OF ARMOR REPLICA
 COLECCIONAR Y MOSTRAR EN LA GALERÍA DE REPRODUCCIONES DE ARMADURAS
 COLLECTIONNER LES ARMURES ET EXPOSER LES DANS LA RÉPLIQUE DU HALL OF ARMOR
 SAMMELN UND IN DER HALLE DER RÜSTUNGSHACHRAUTEN ZUR SCHAU STELLEN
 VERZAMEL & LAAT ZIEN IN DE HALL OF ARMOR REPLICA
 COLLEZIONA E METTI IN MOSTRA NELLA HALL DELLE REPLICHE DELLE ARMATURE
 RECOLHER E MOSTRAR NA SALA DA RÉPLICA DA ARMADURA



21

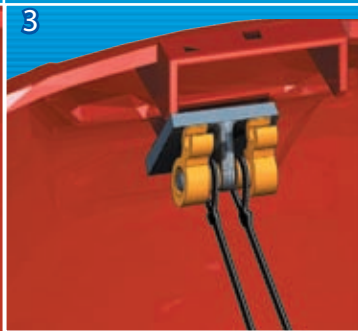
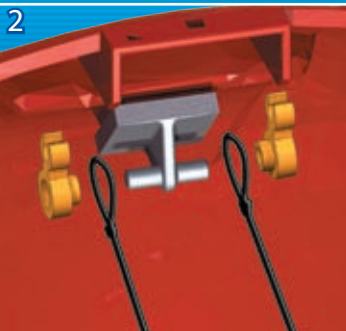
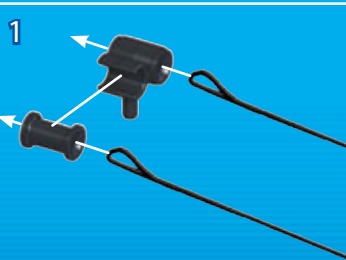

23



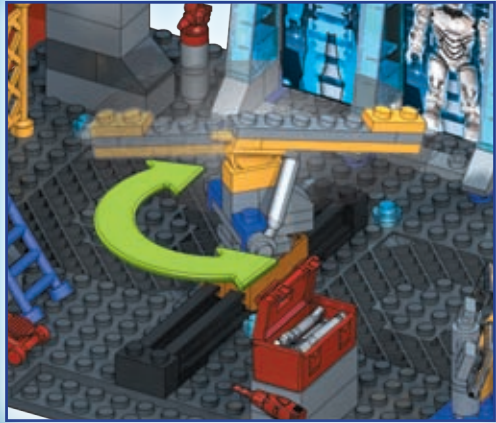
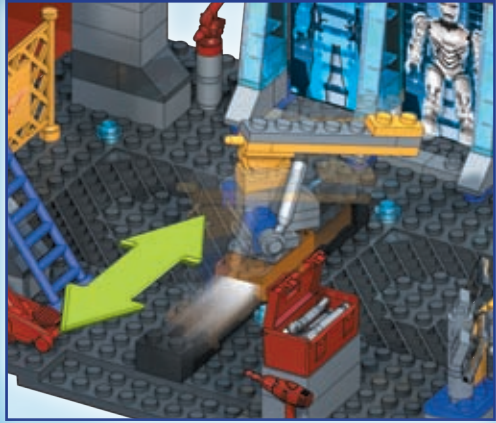
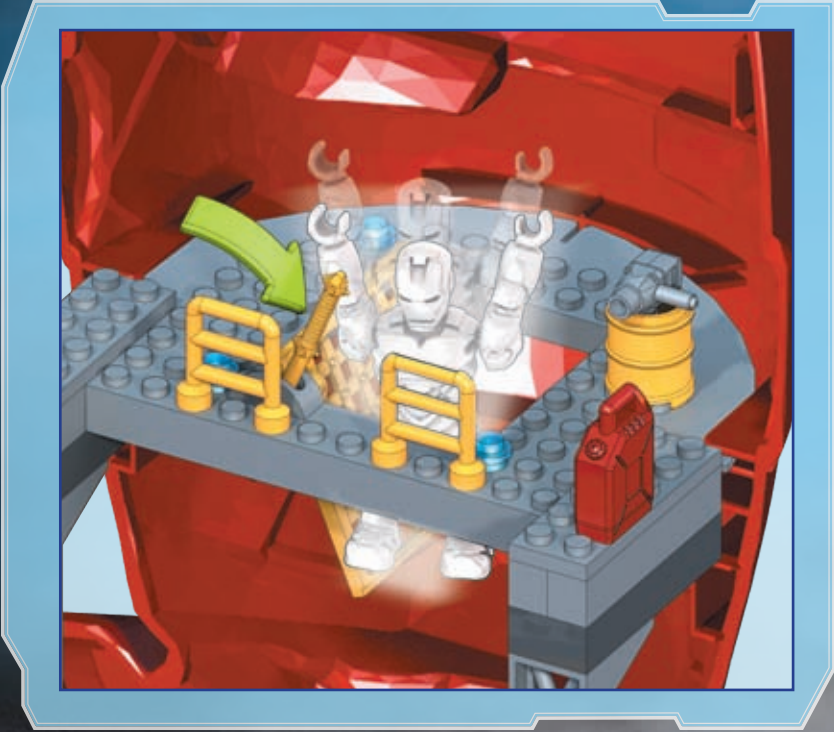

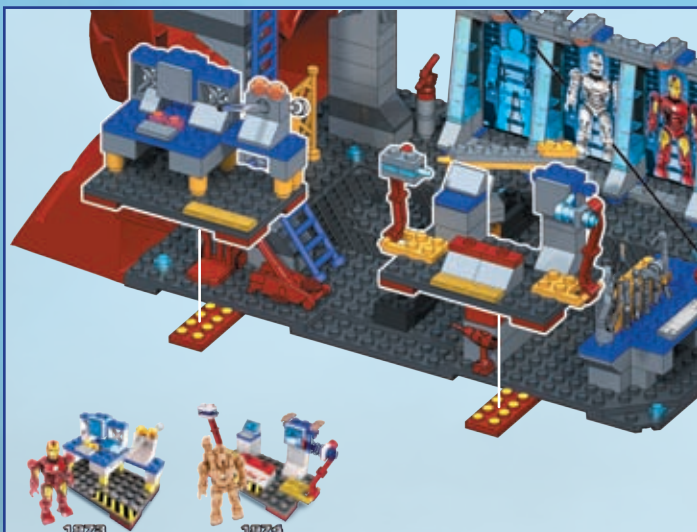
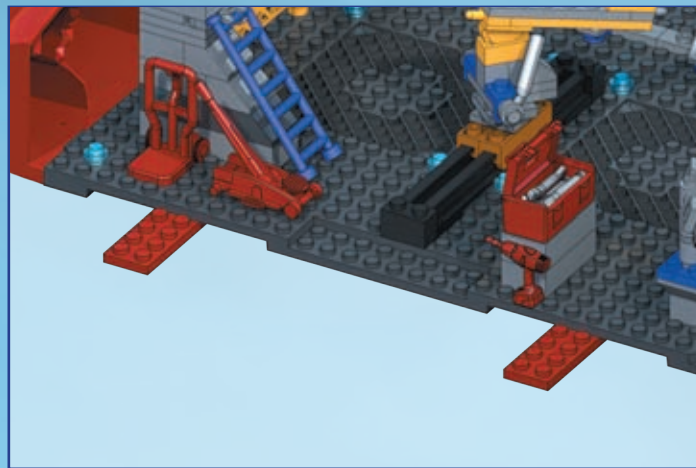
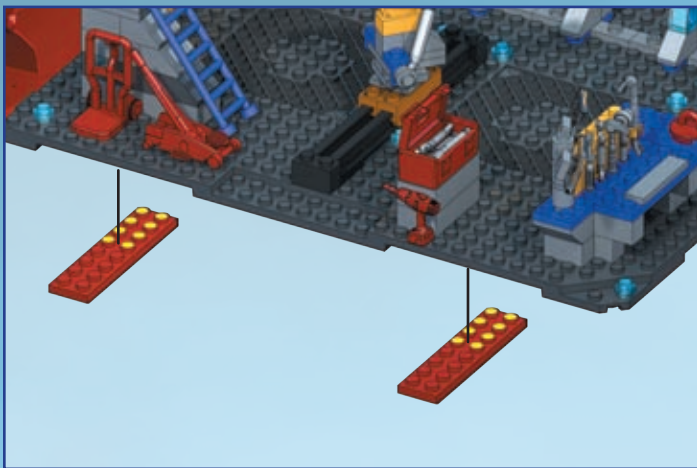

Additional purchases required to collect all elements shown. / Para coleccionar todos los elementos mostrados se precisa realizar unas compras adicionales. / Des achats additionnels sont nécessaires afin d'obtenir tous les articles de la collection illustrés. / Um alle dargestellten Elemente zu sammeln sind zusätzliche Käufe erforderlich. / Verdere aankopen zijn nodig om alle afgebeelde artikelen te verzamelen. / Acquisiti supplementari necessari per collezionare tutti gli elementi illustrati. / Compras adicionais são necessárias para coleccionar todos os elementos exibidos



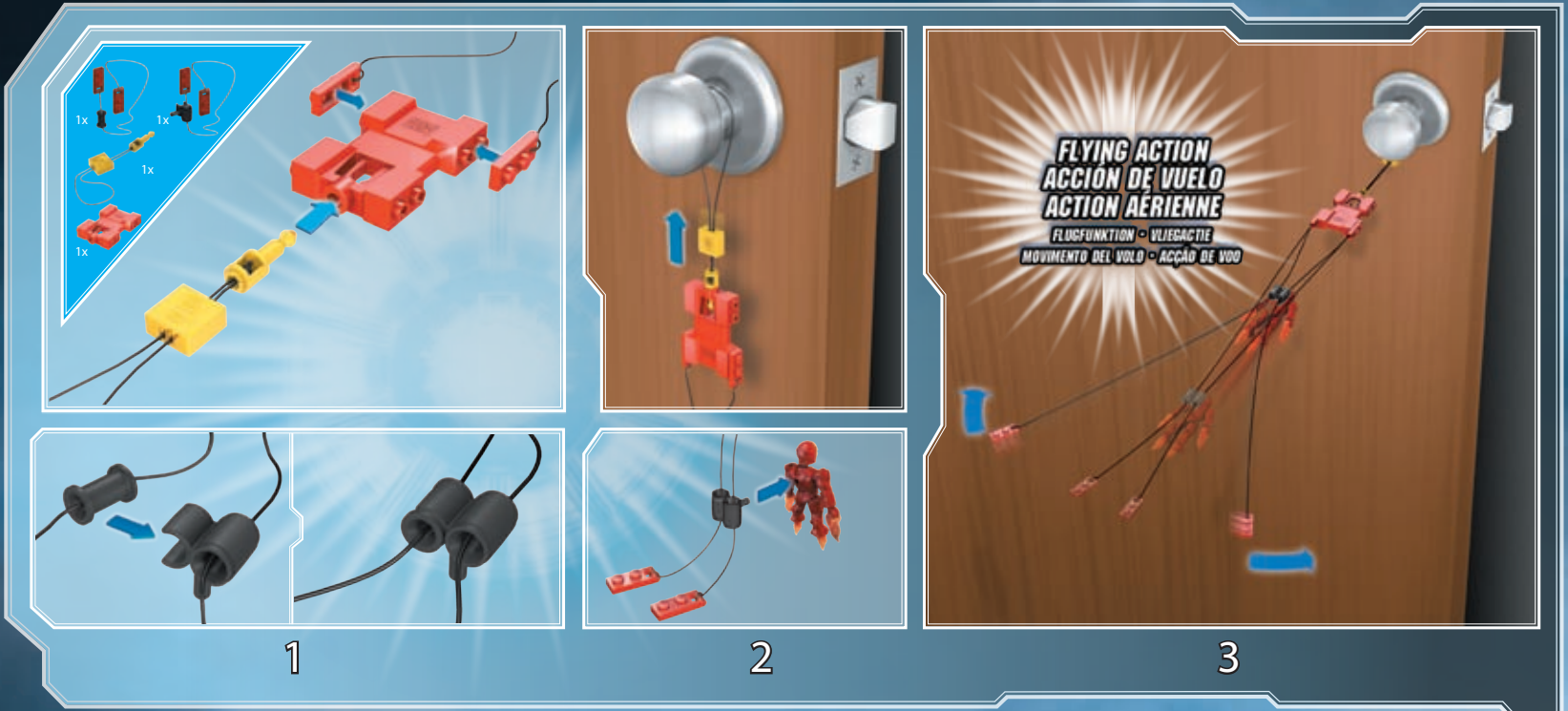

Storage / Para guardar / Rangement / Lagerung / Opberging / Deposito / Armazenagem



WARNING: Cords could be strangulation hazards. • ADVERTENCIA: Los cables constituyen un peligro de estrangulación. • MISE EN GARDE : Les cordons peuvent représenter des dangers de strangulation. • ACHTUNG: Bei den Kabeln besteht Erstickungsgefahr. • WAARSCHUWING: Koorden kunnen gevaar voor wurging opleveren. • ADVARSEL: Ledninger kan have strangulerings risiko. • ΠΡΟΕΙΔΟΠΟΙΗΣΗ: Τα καλώδια είναι επικίνδυνα για στραγγαλισμό. • VAROITUS: Johto voi aiheuttaa kuristumisriskin. • ATTENZIONE: Questo filo può creare rischio di strangolamento. • ADVARSEL: Ledningene kan utgjøre en kvelningsrisiko. • ADVERTENCIA: As cordas podem causar perigos de estrangulação. • VARNING: Sladdene kan förorsaka strypning. • 警告：コードで首を絞める危険があります。 • تحذير: قد تمثل الأسلاك خطر اختناق.

IRON 2 MAN

STARK INDUSTRIES



1973



1974



1955



1956

Collect Them All! • *Alle sammeln!* • *¡Colecciónalos todos!* • *Collezionelele tutti!* • *Collectionneles tous!*



1980



1974



1973



1956



1956



1980



© 2010, MEGA Brands Inc.
MEGA Brands Inc. and the MEGA Brands Inc. logo are registered trademarks of MEGA Brands Inc.
MEGA Brands Inc. y el logotipo MEGA Brands Inc. son marcas registradas de MEGA Brands Inc.
MEGA Brands Inc. et le logo de MEGA Brands Inc. sont des marques de commerce déposées de MEGA Brands Inc.
MEGA Brands Inc. und das MEGA Brands Inc.-Logo sind eingetragene Warenzeichen von MEGA Brands Inc.
MEGA Brands Inc. en het MEGA Brands Inc. logo zijn gedeponeerde handelsmerken van MEGA Brands Inc.
MEGA Brands Inc. ed il logo di MEGA Brands Inc. sono marchi di fabbrica di MEGA Brands Inc.
MEGA Brands Inc. e o logo MEGA Brands Inc. são marcas registradas de MEGA Brands Inc.

Printed in China

AD019591A

www.megabrand.com