

**LEGO**

# POWER MINERS

8959  
+  
8961



1

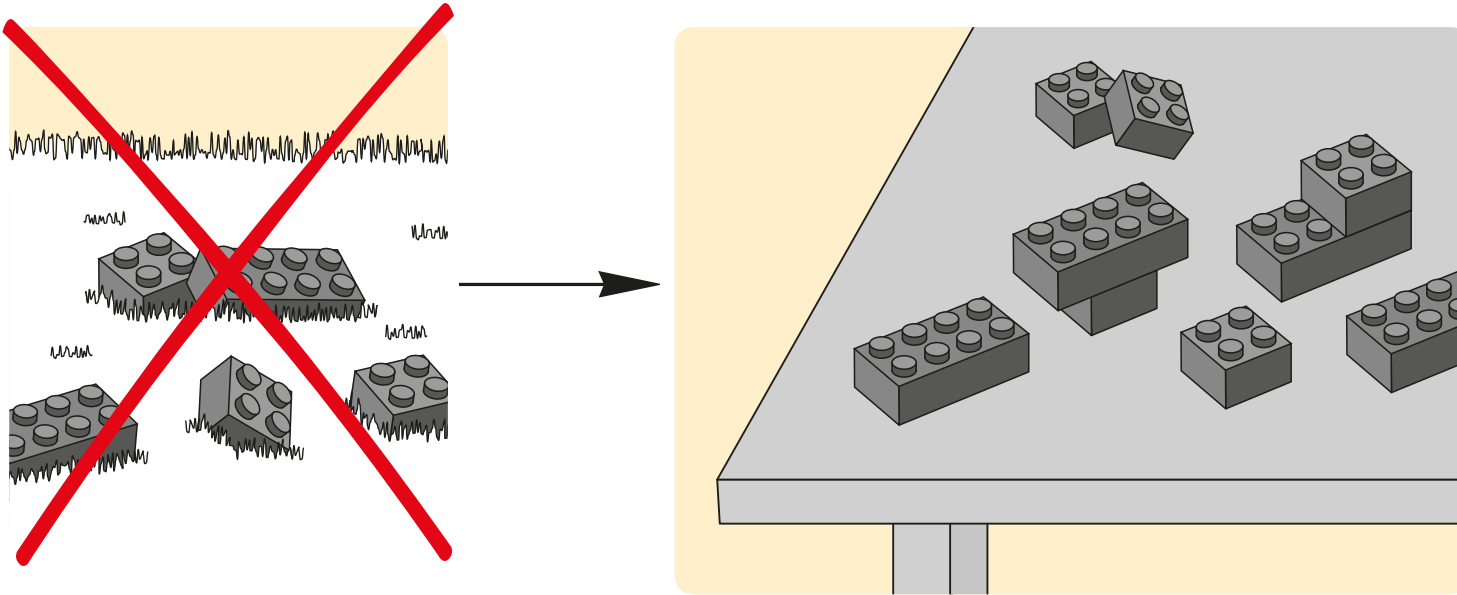

2

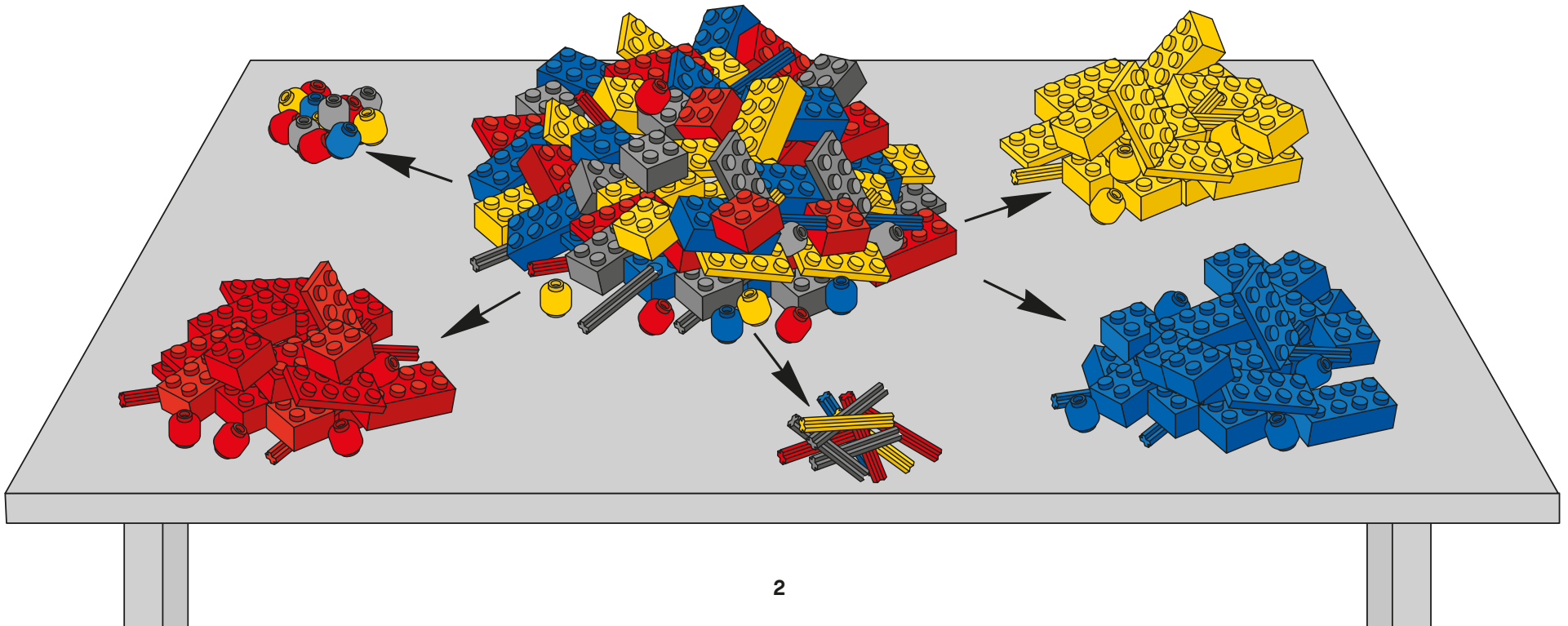



3

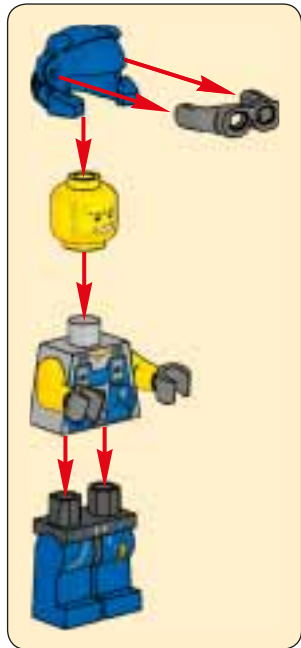



1x

**1**



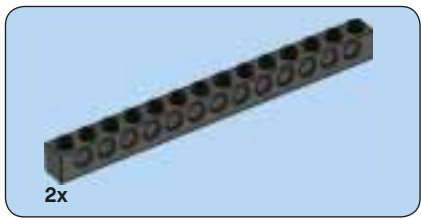

2

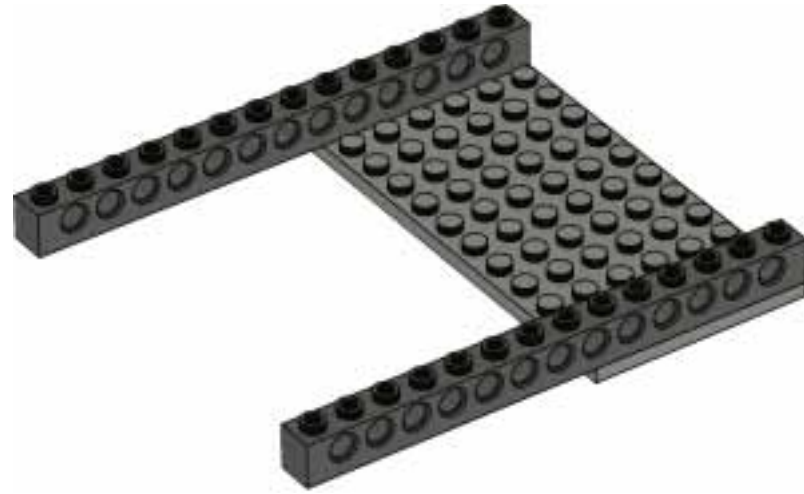

3

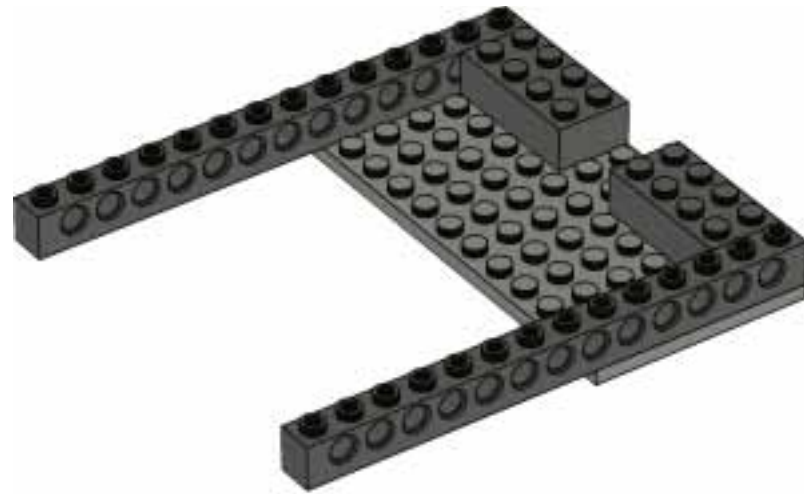

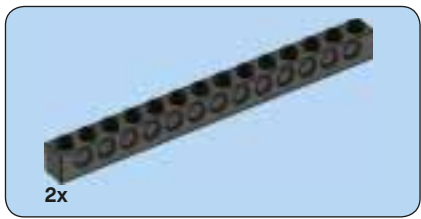

4



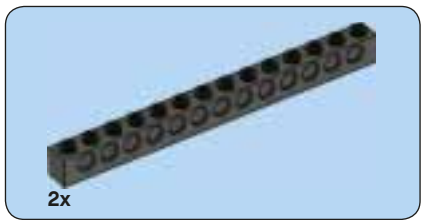

5





6





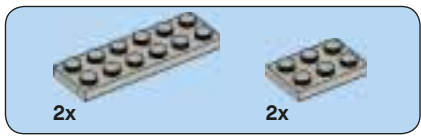

7



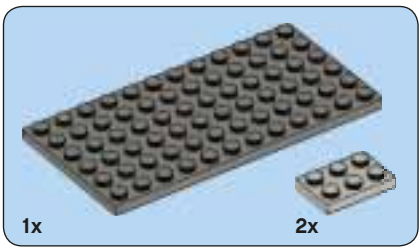

8

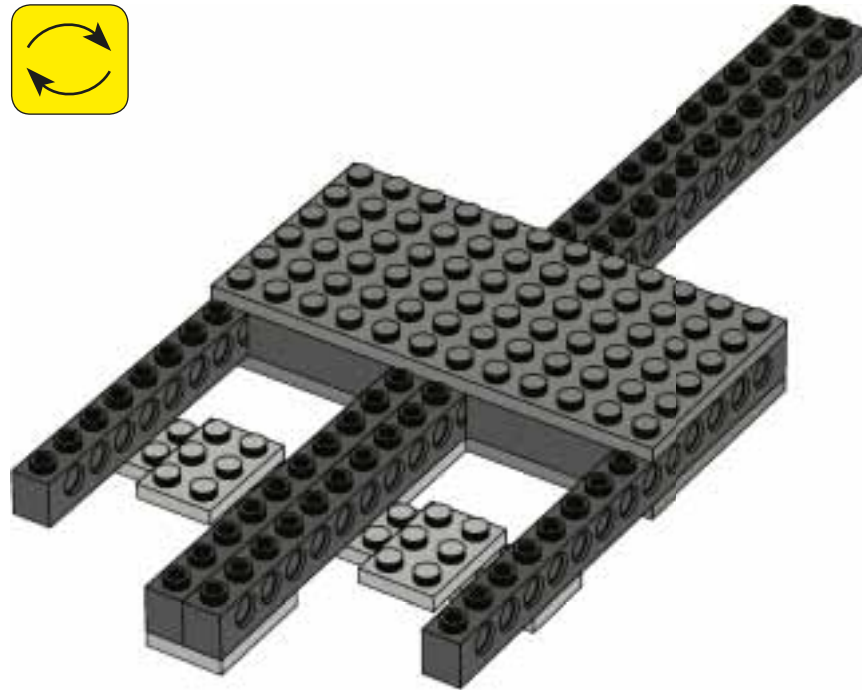

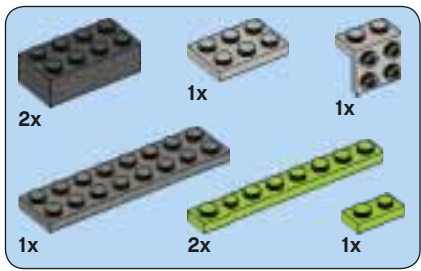

9



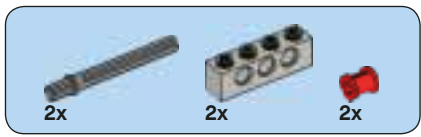

# 10

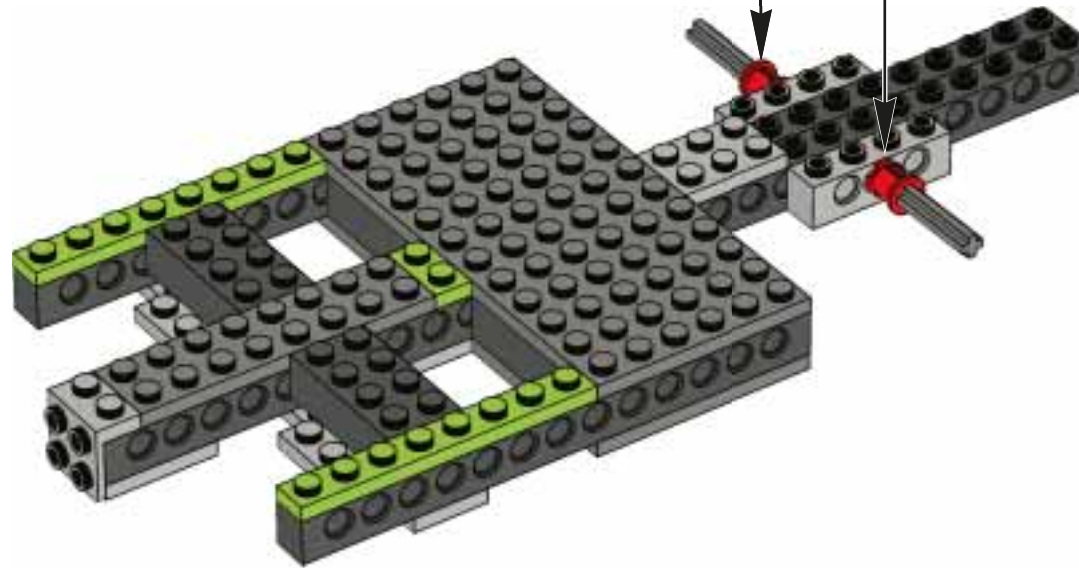
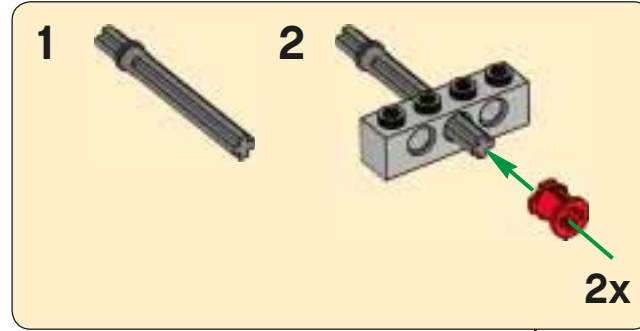

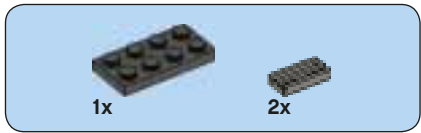

# 11

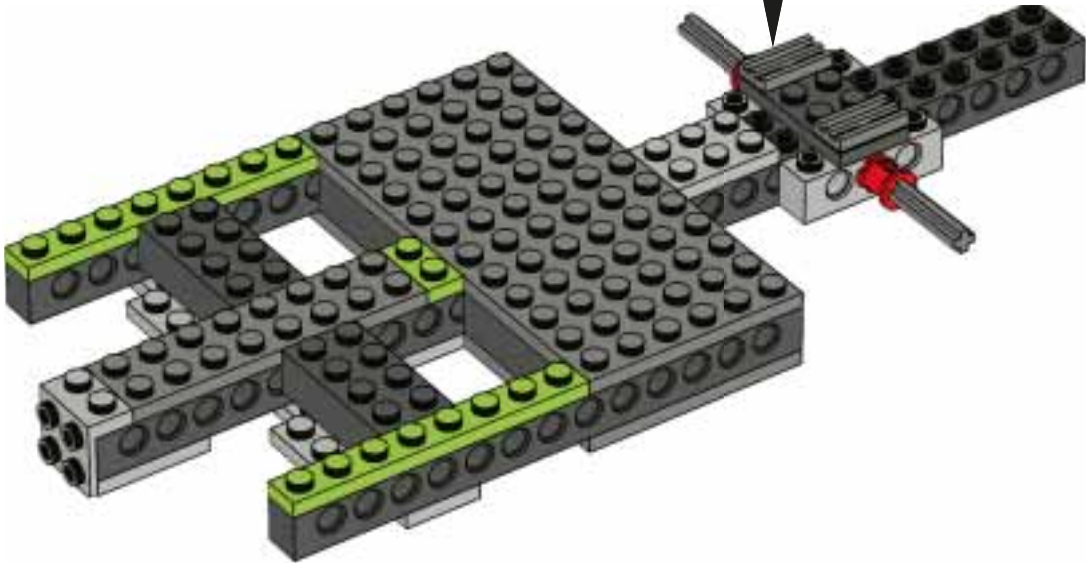
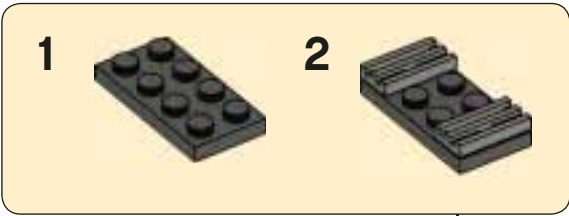



12

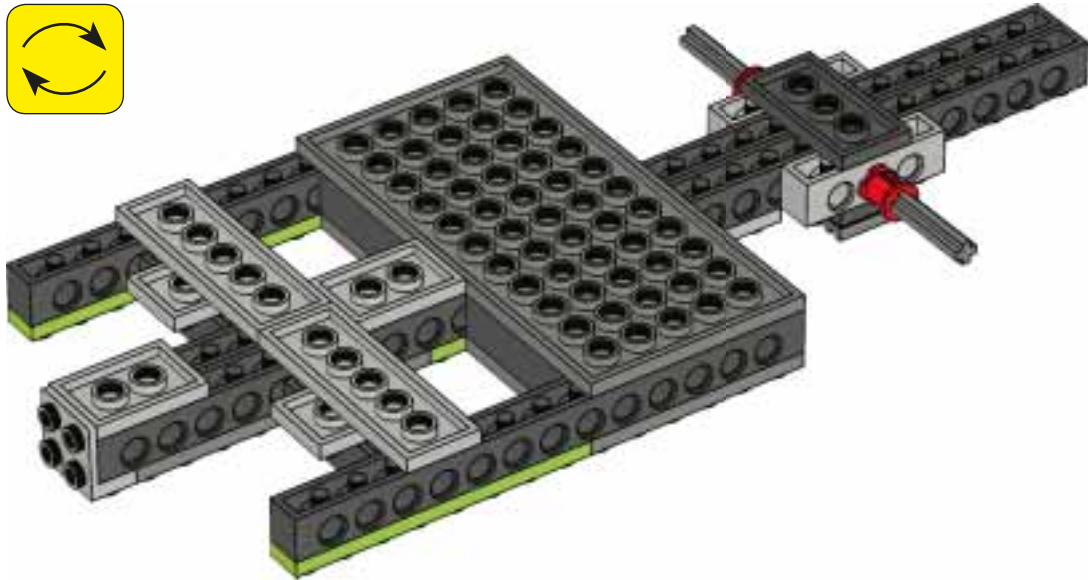

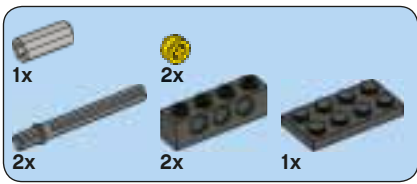

# 13

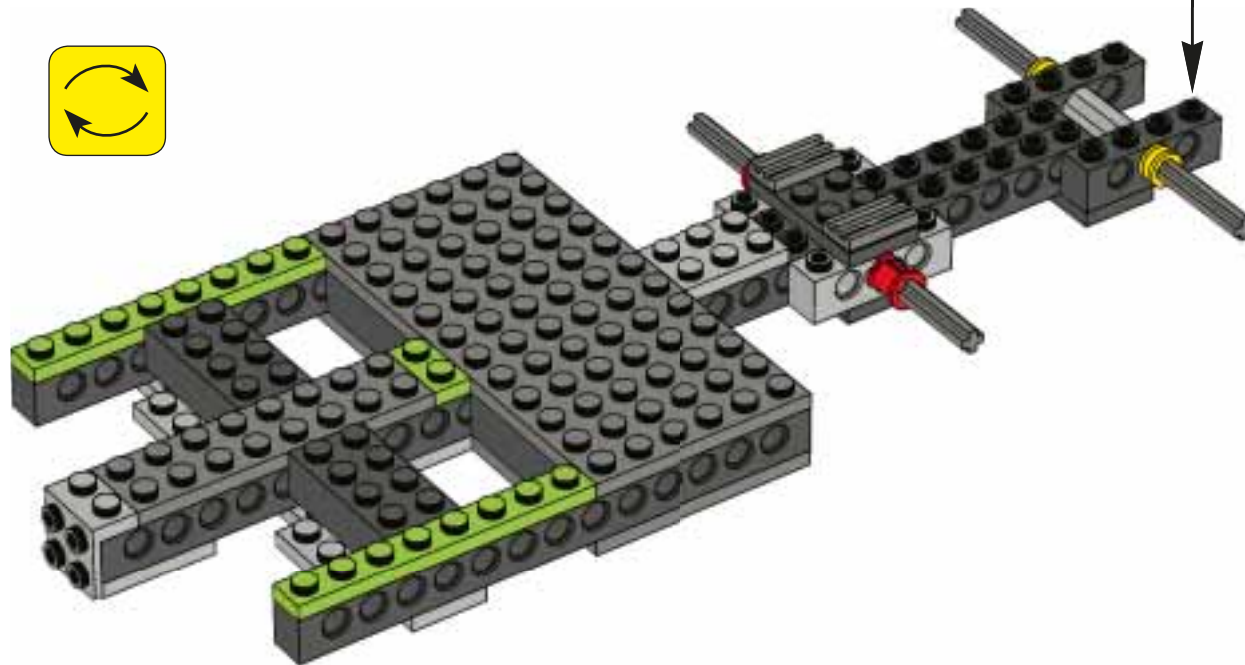
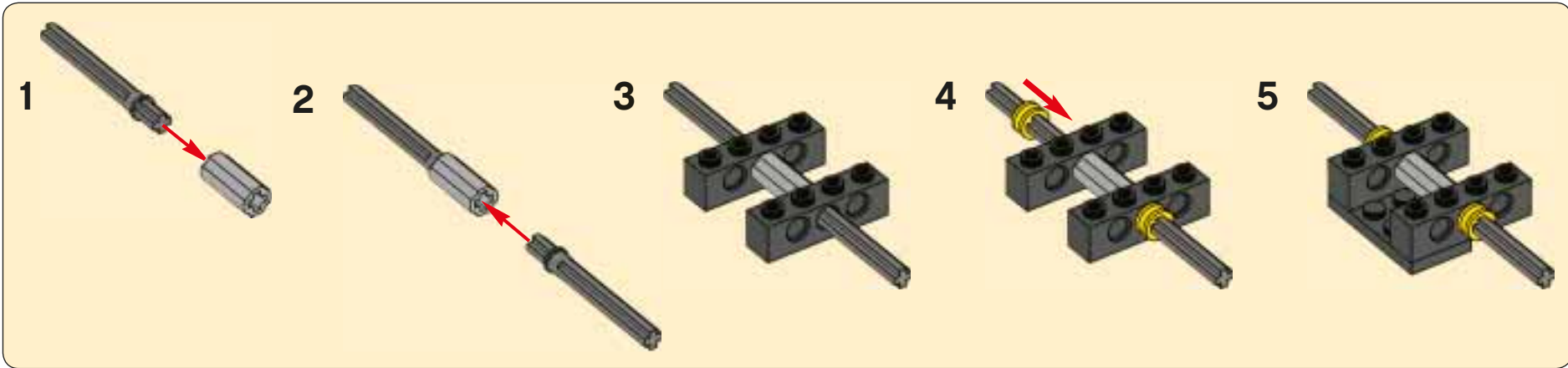



14

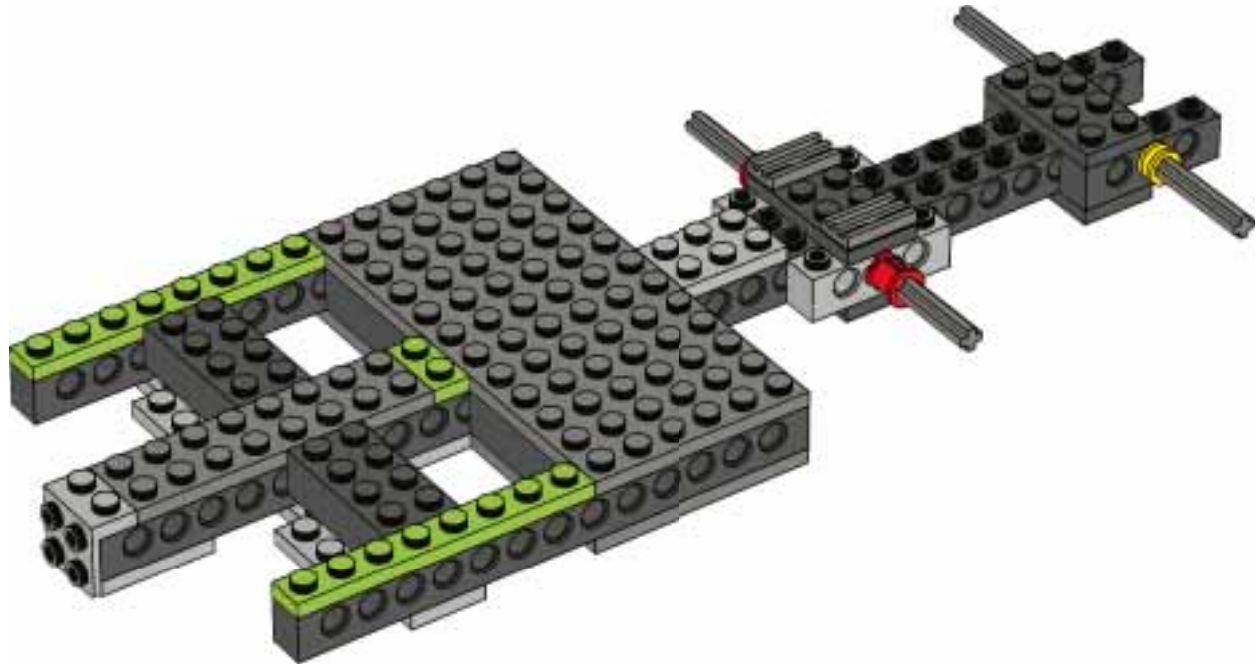



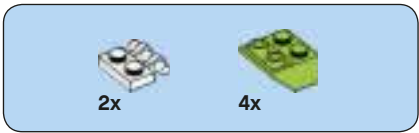

# 15

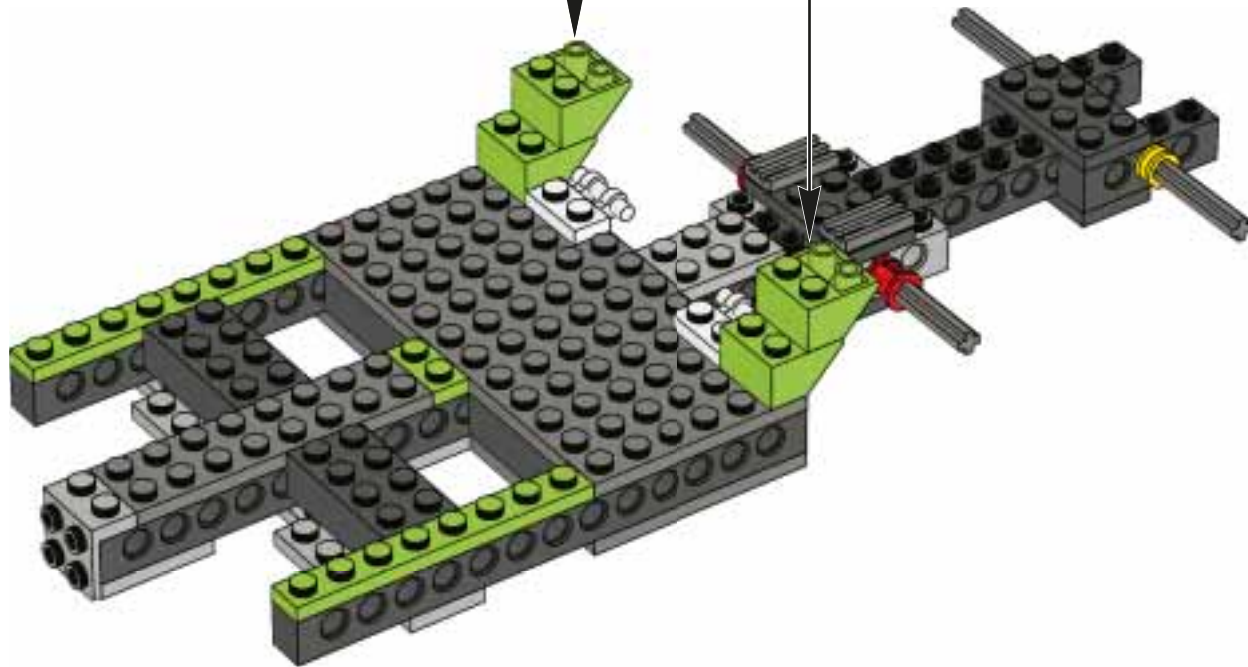
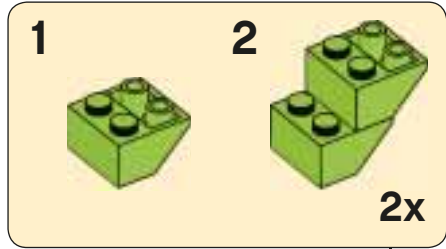



16

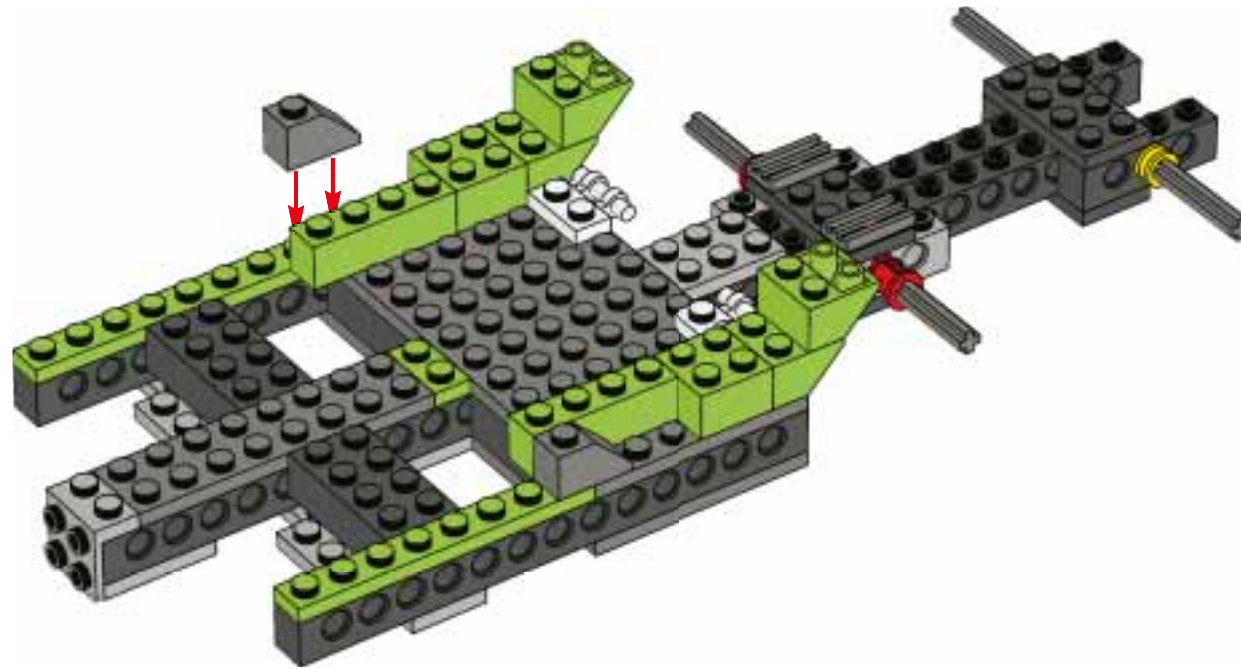



17

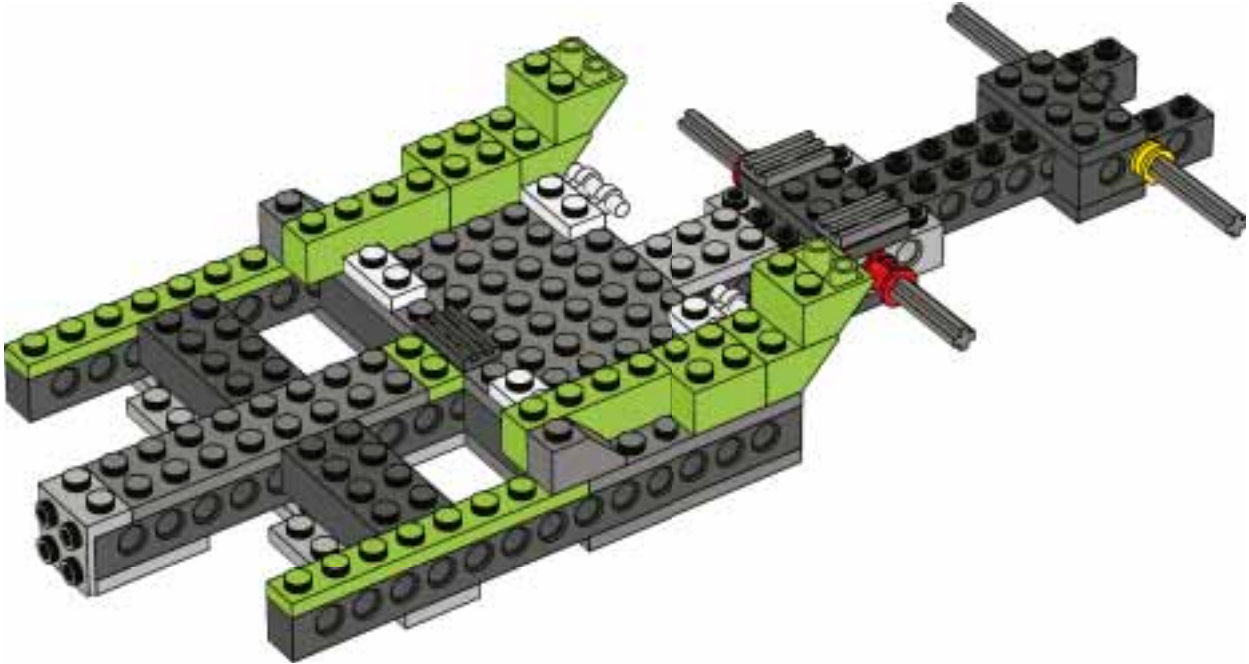

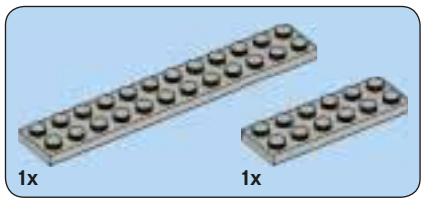

18

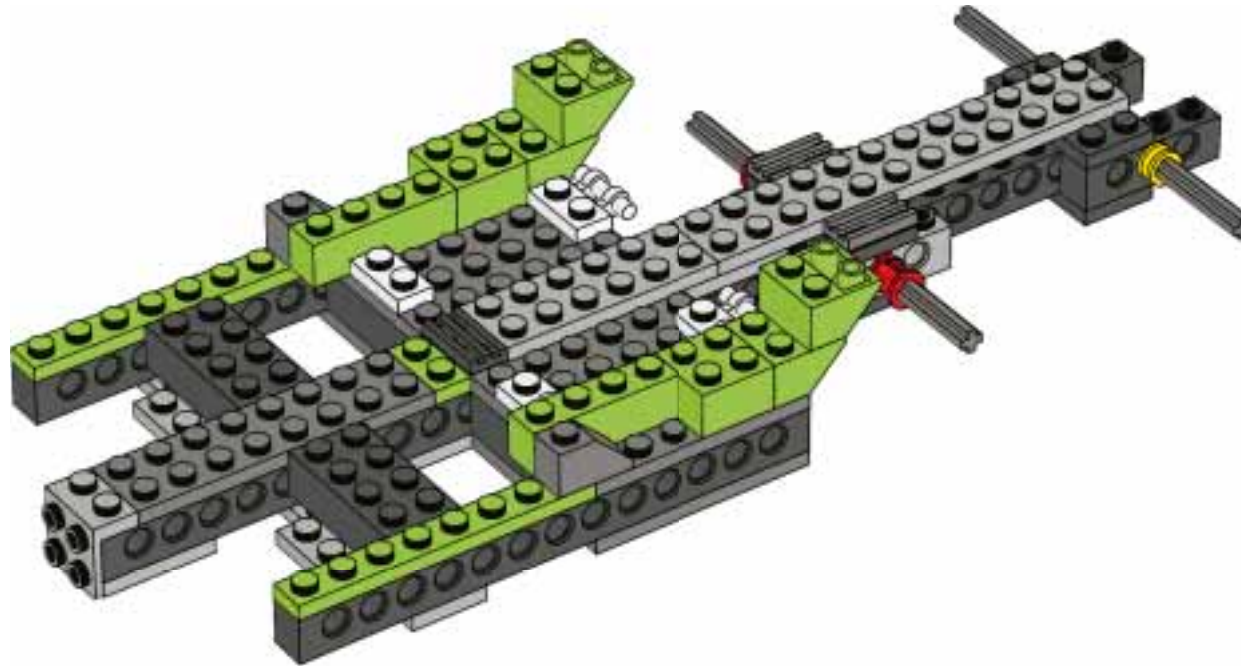

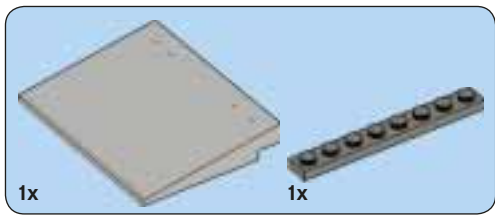

19

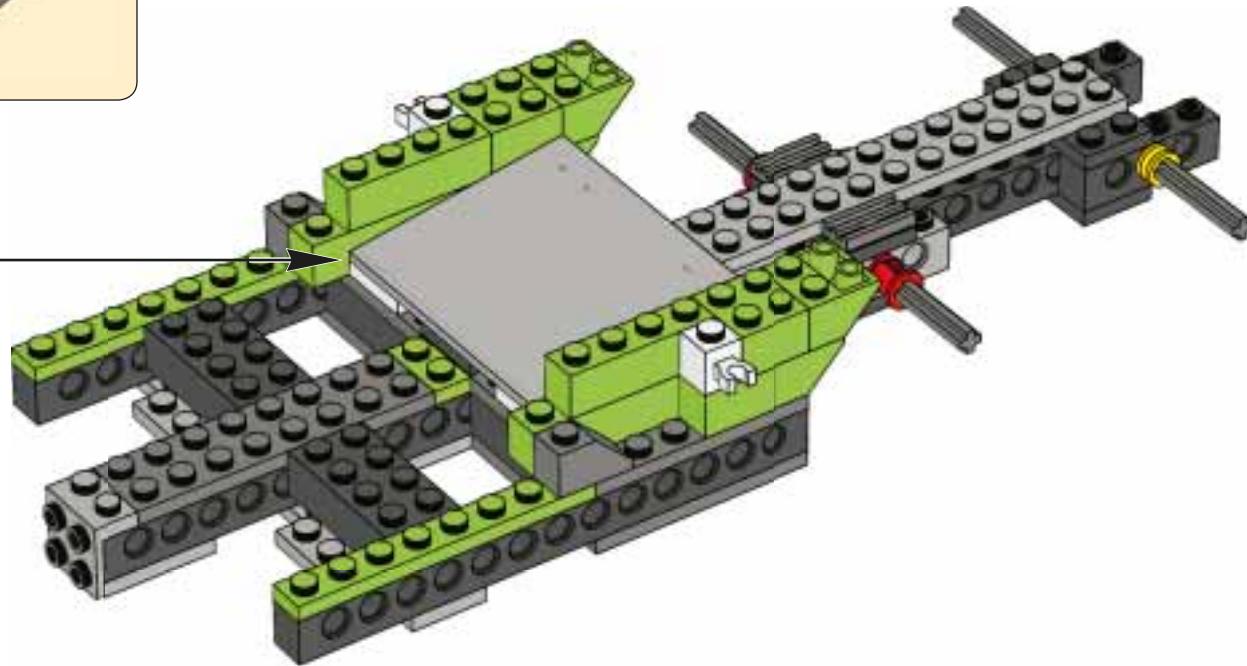
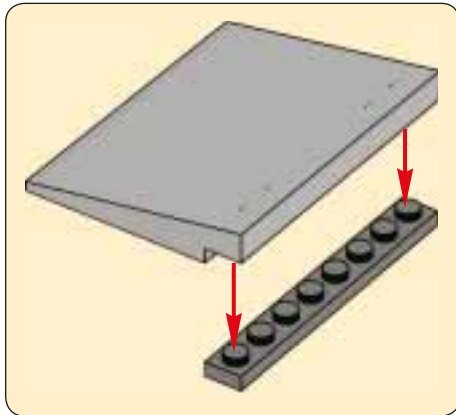



20

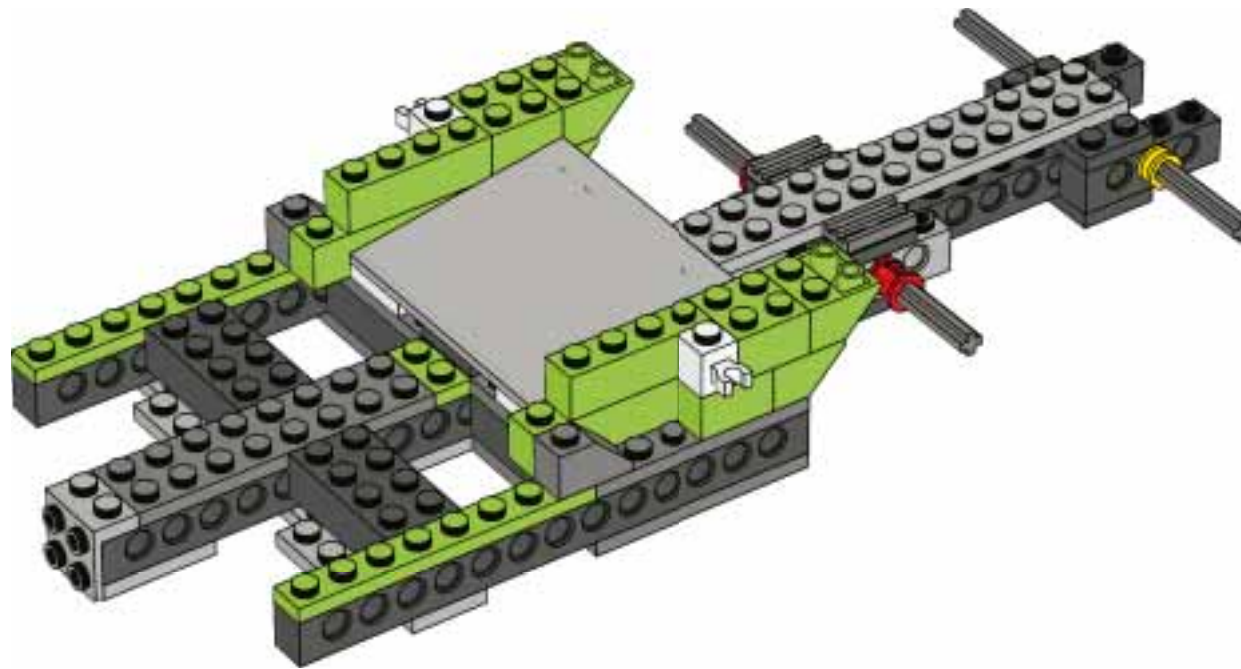

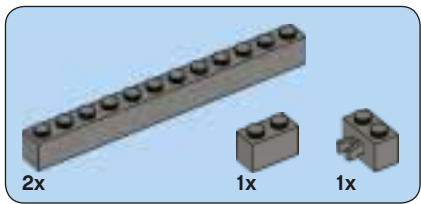

21

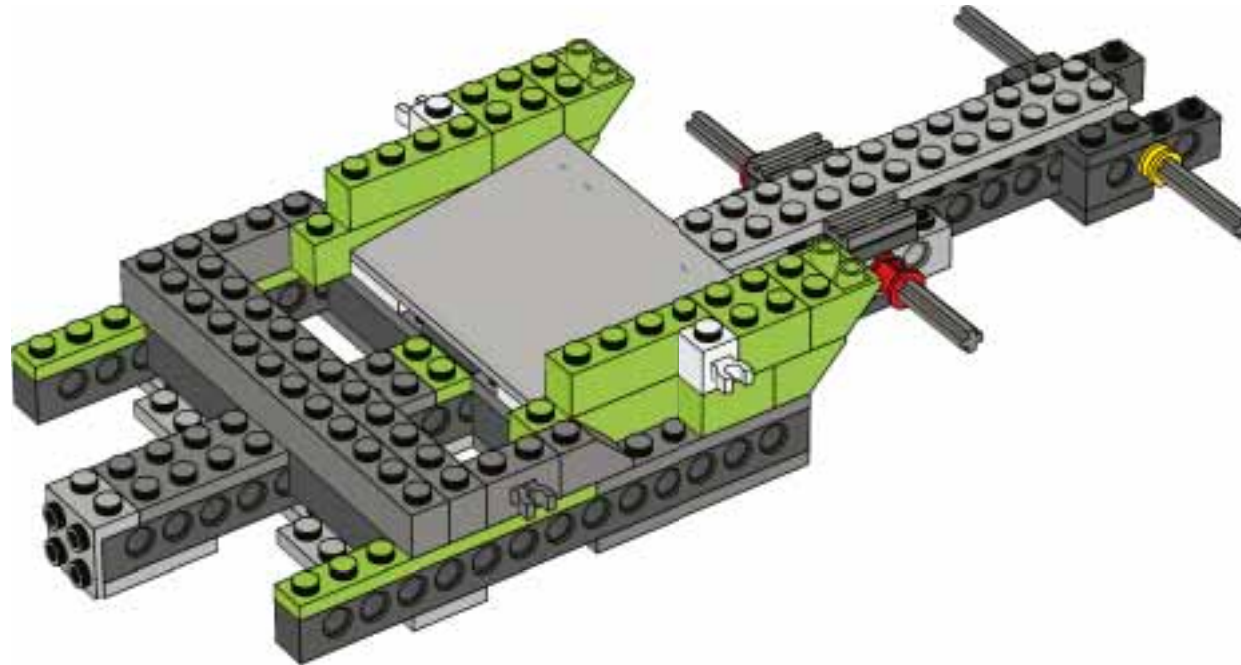

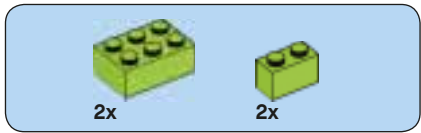

22

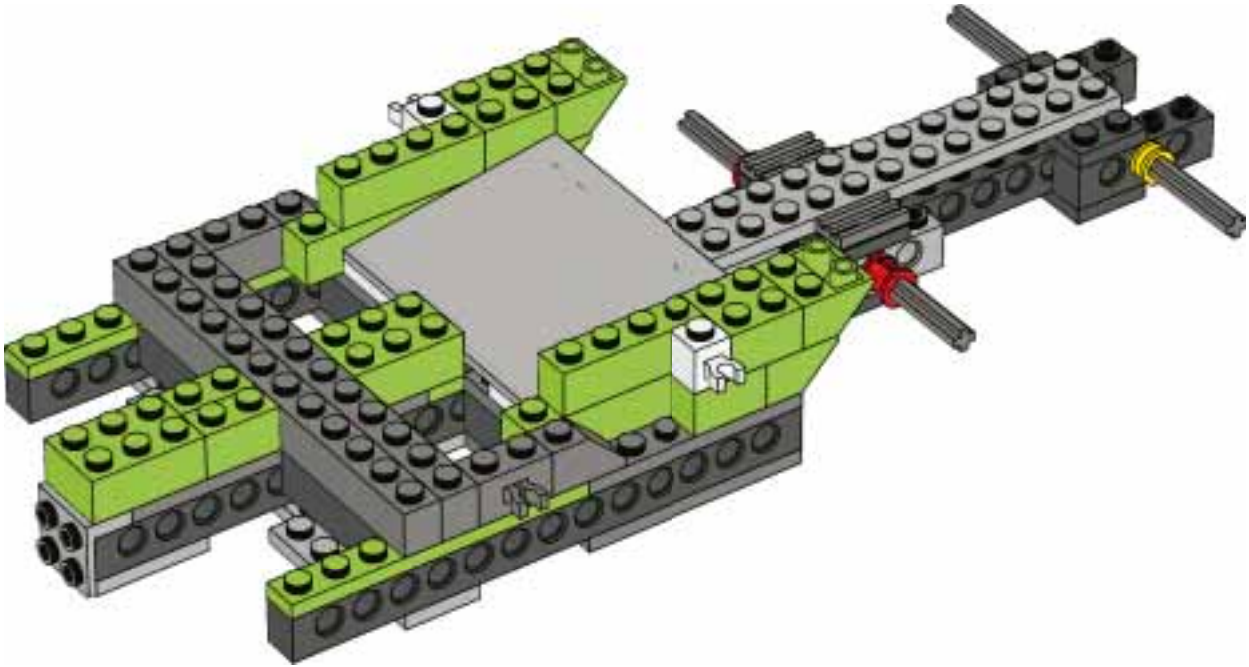



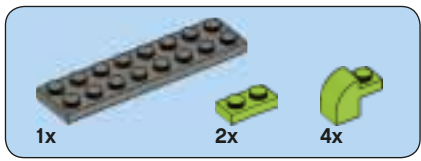

23

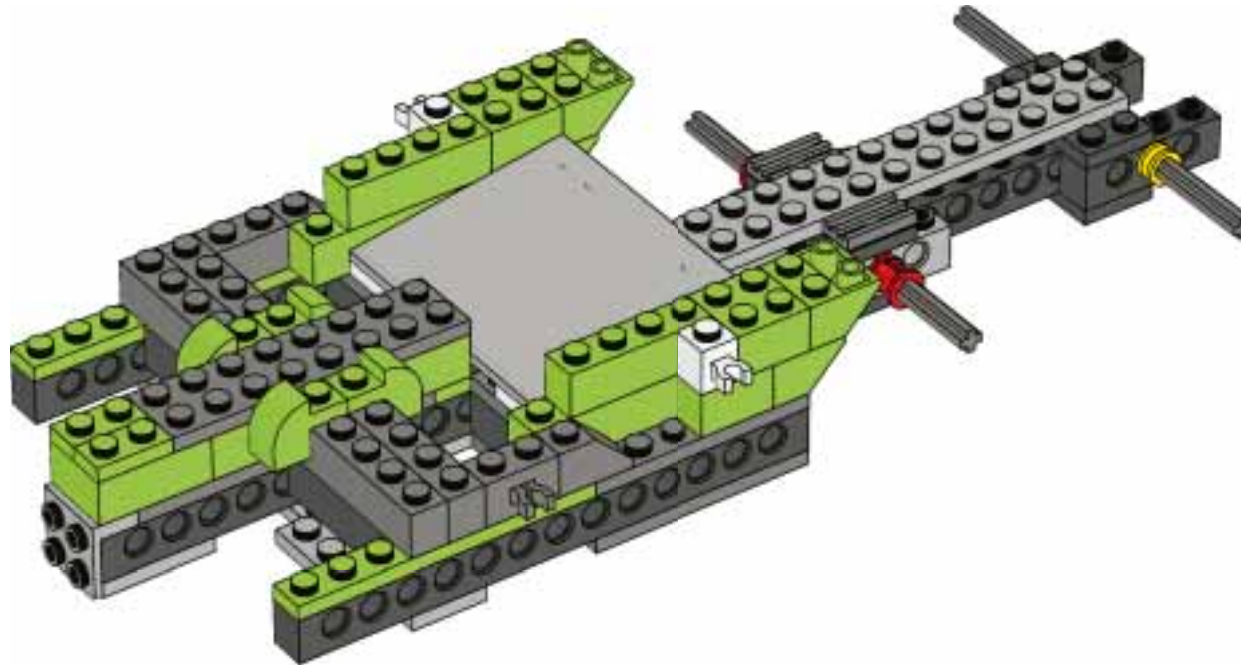

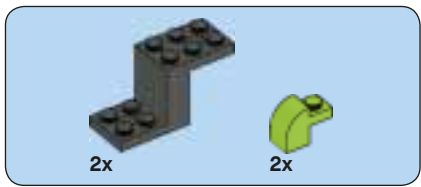

24

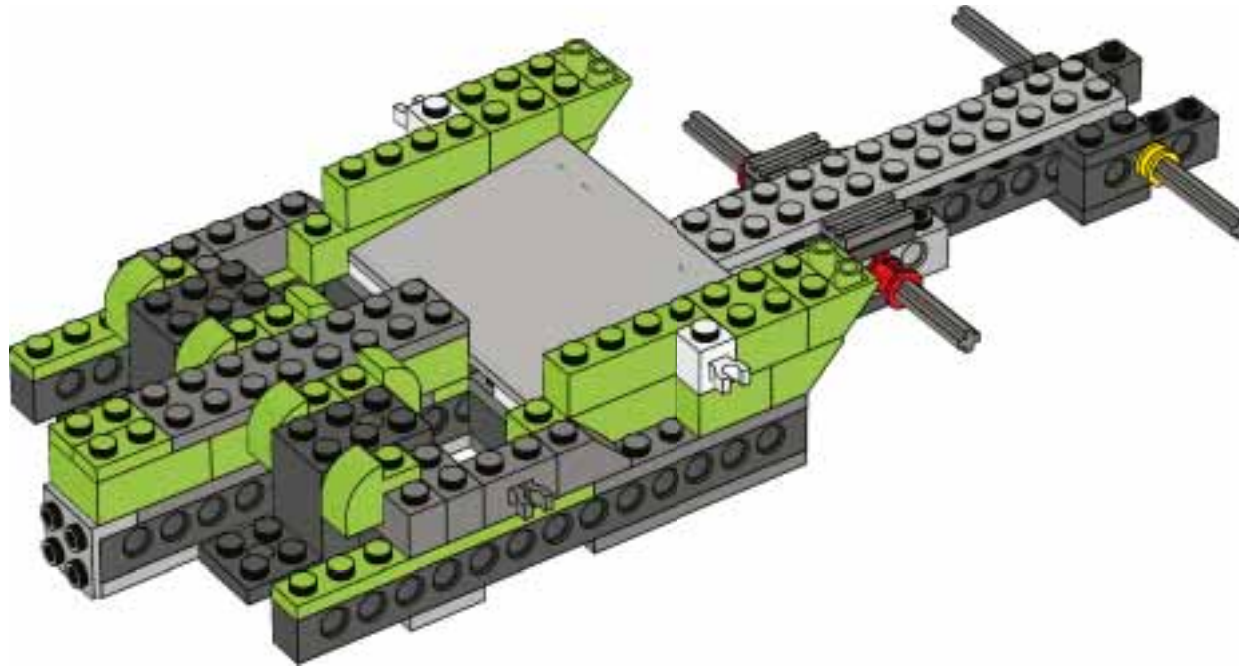

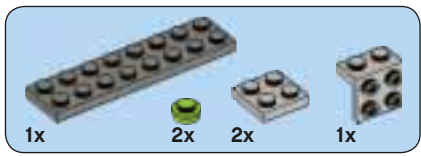

25

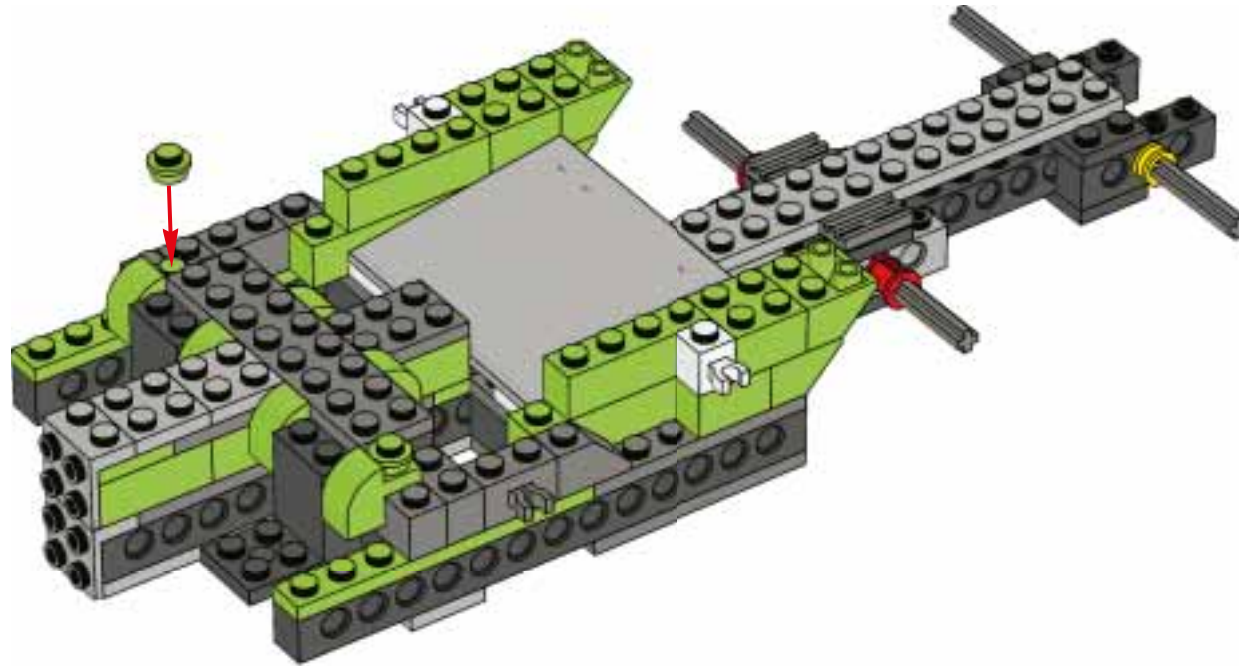



2x



1x

# 26

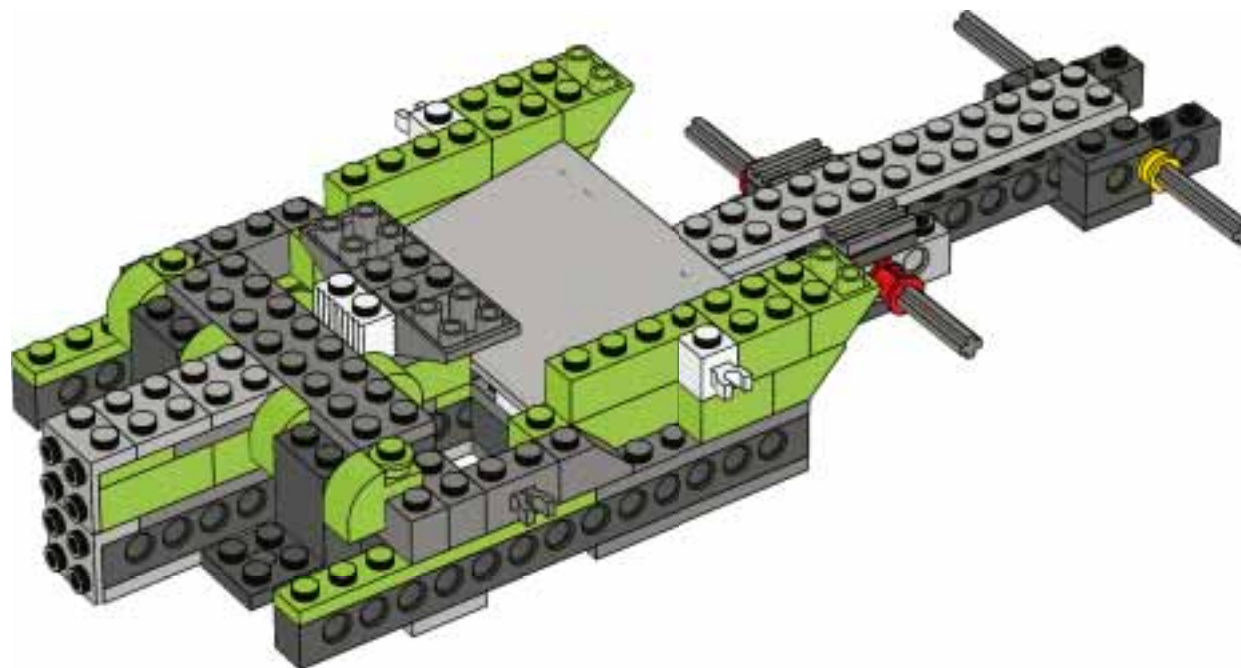

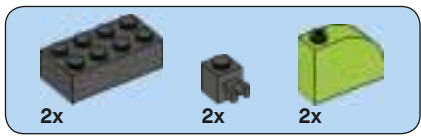

27

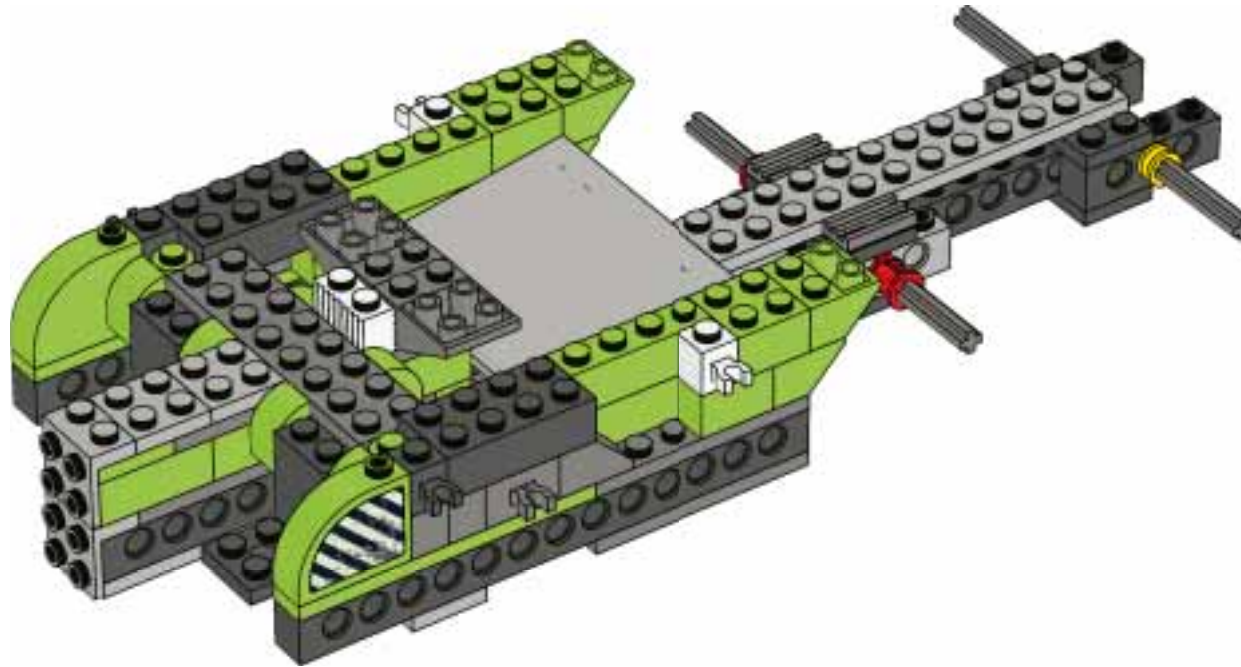

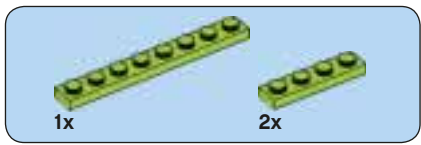

28

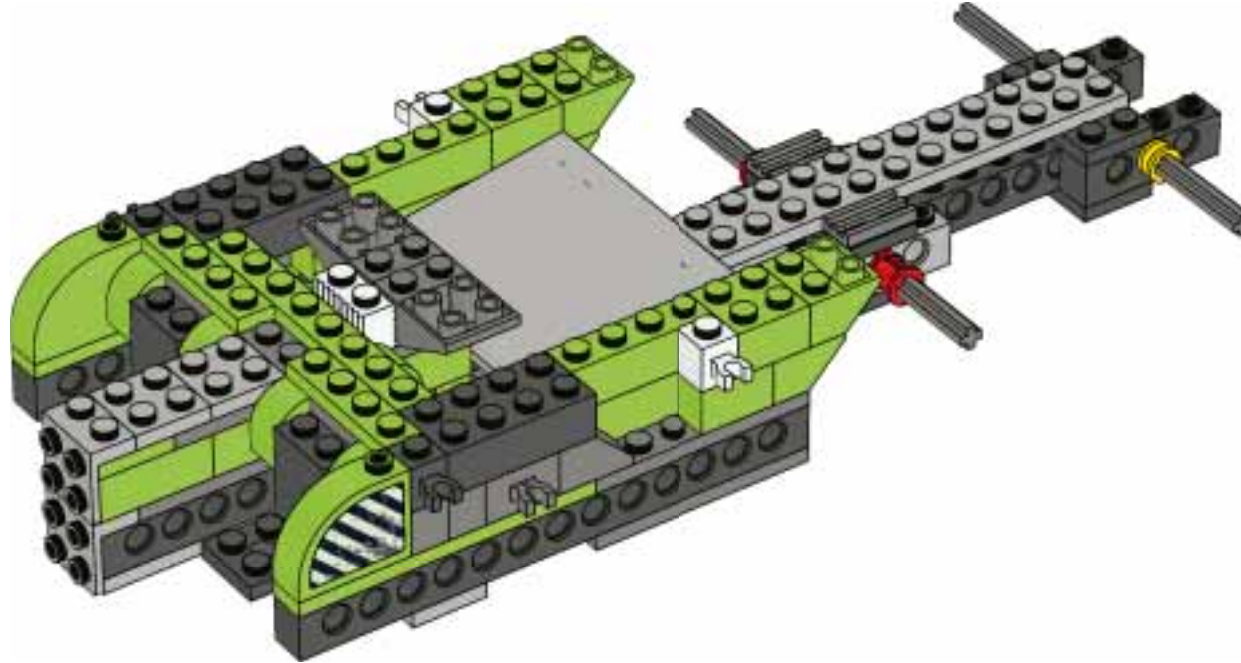

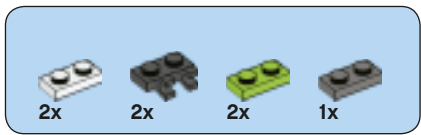

29

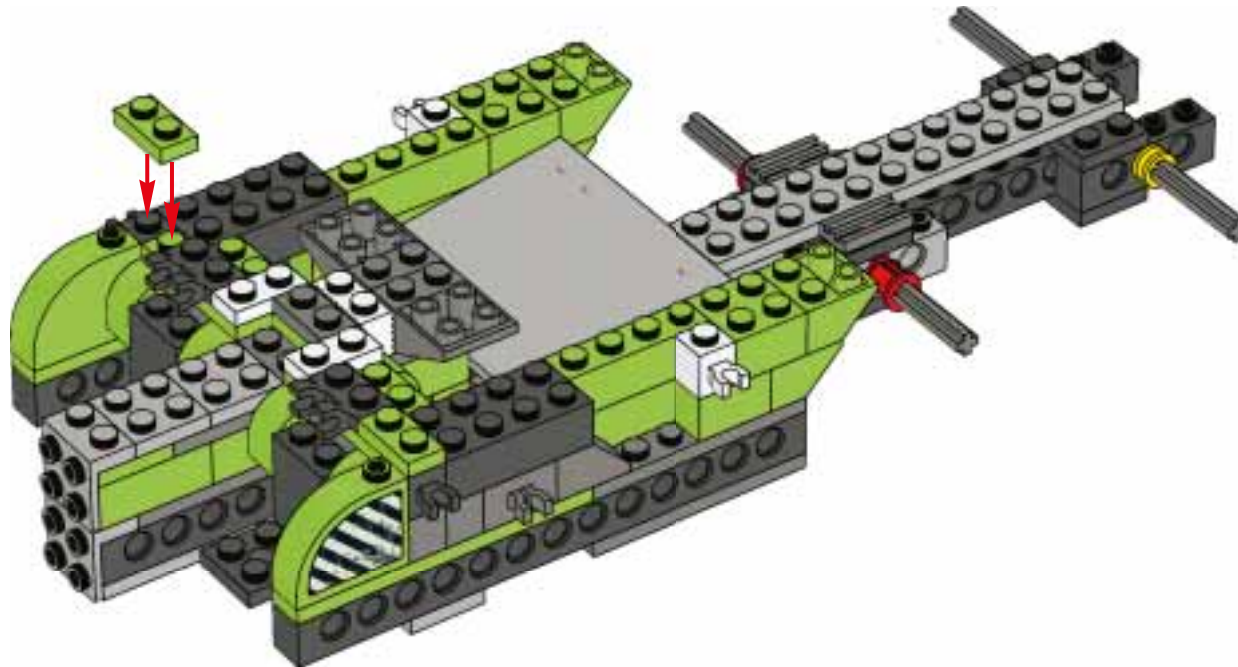

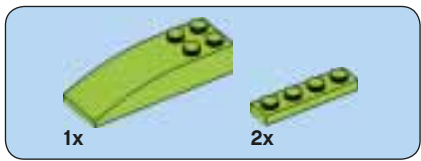

30

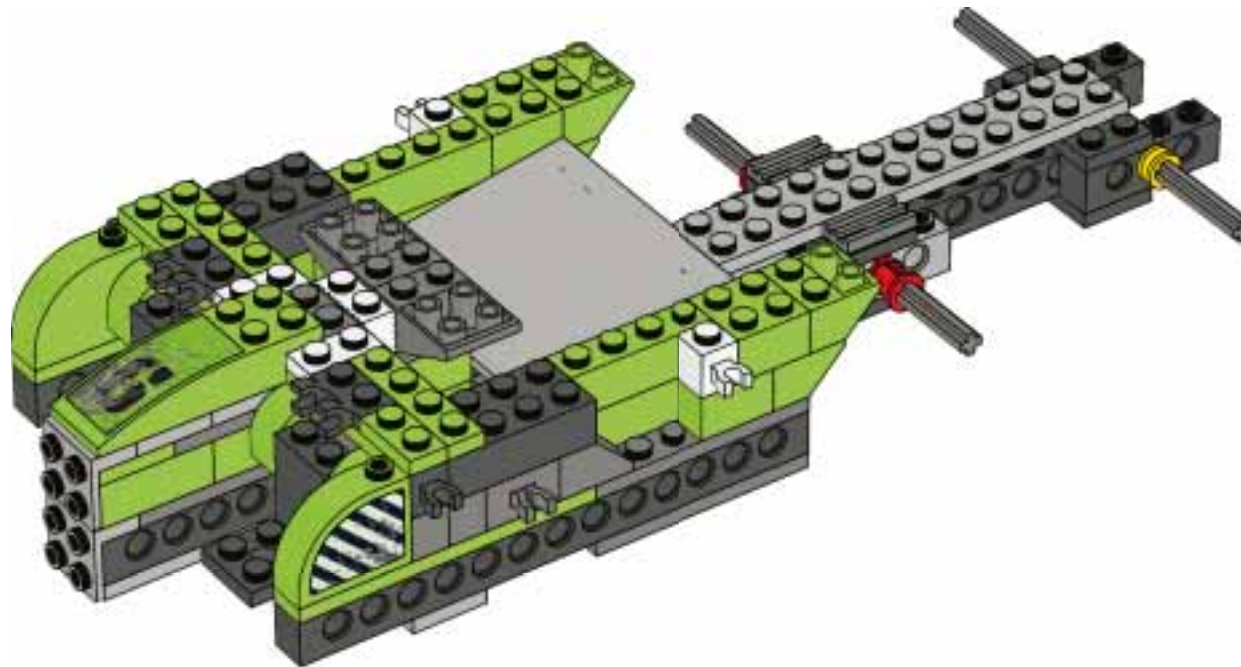





31

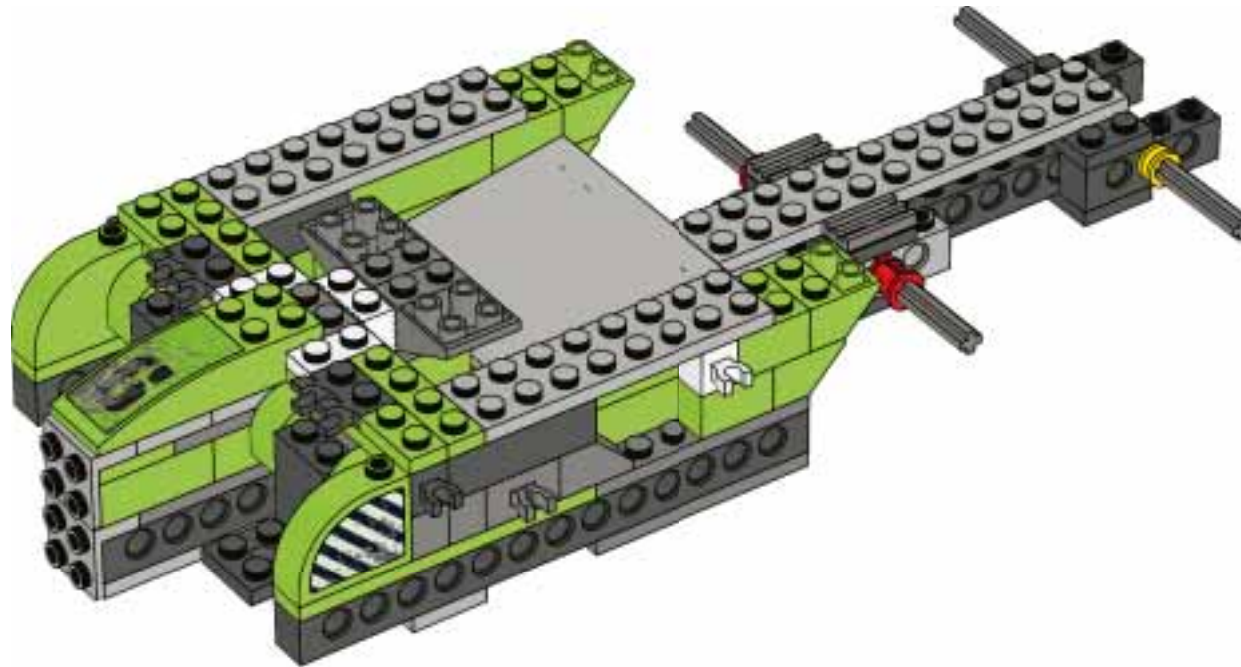

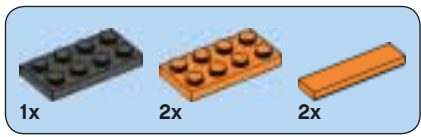

32

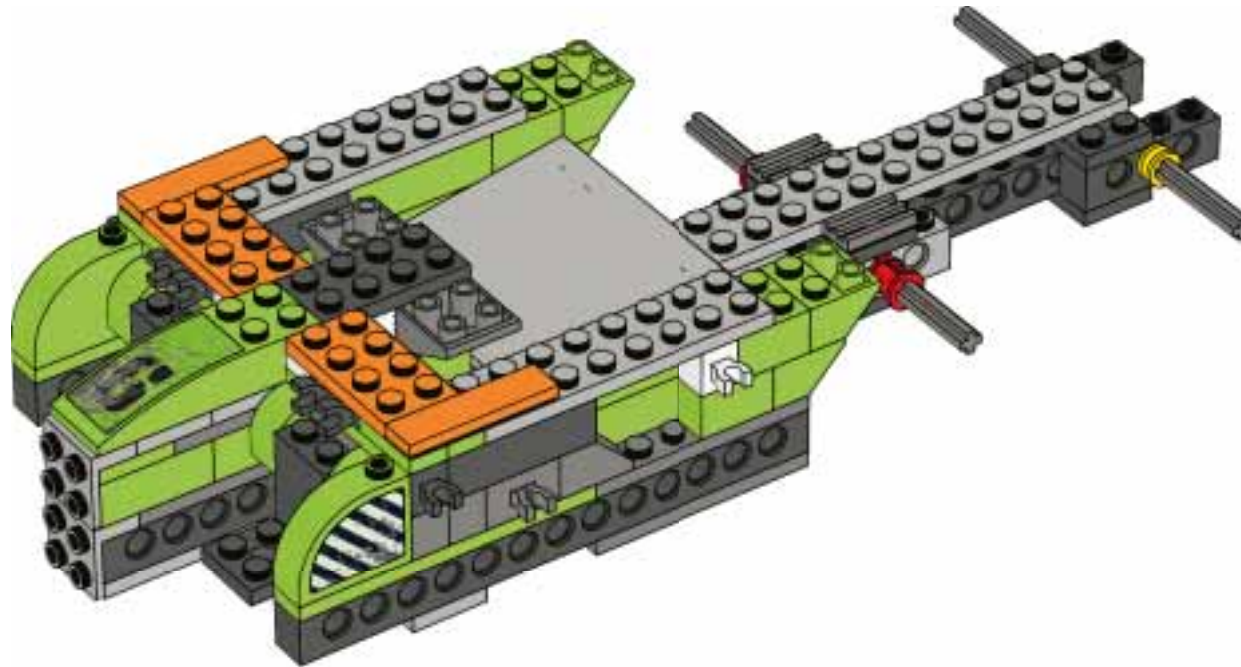

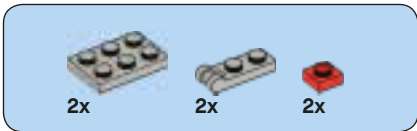

**33**

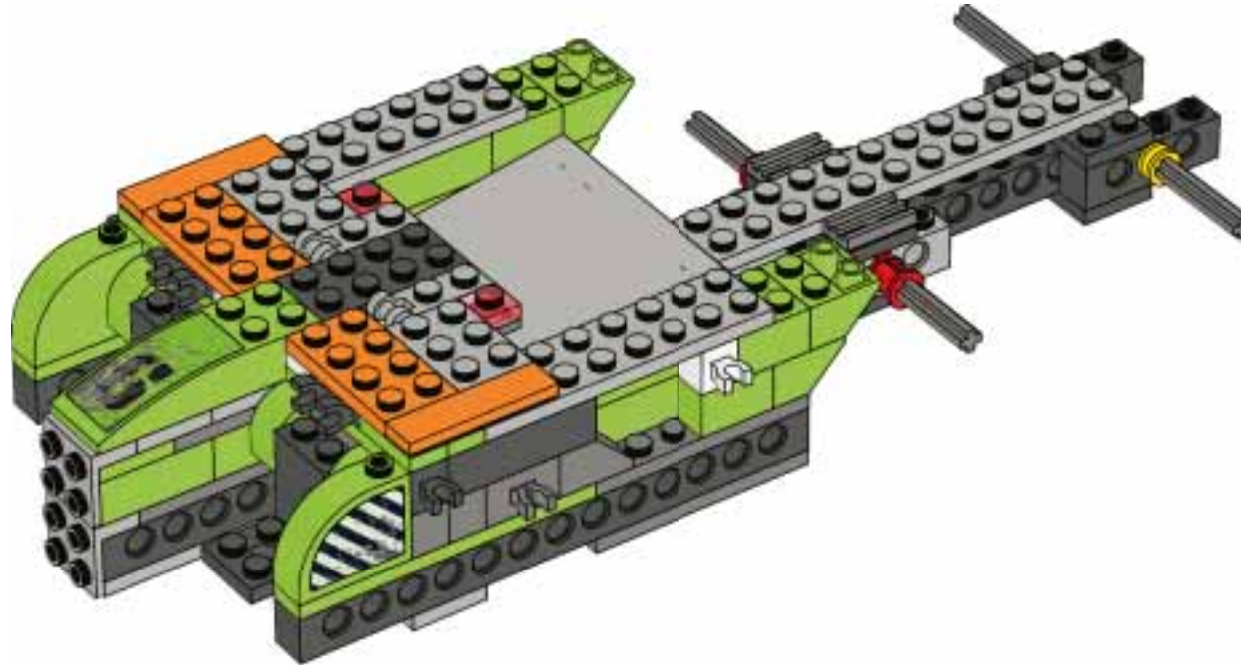



4x

# 34

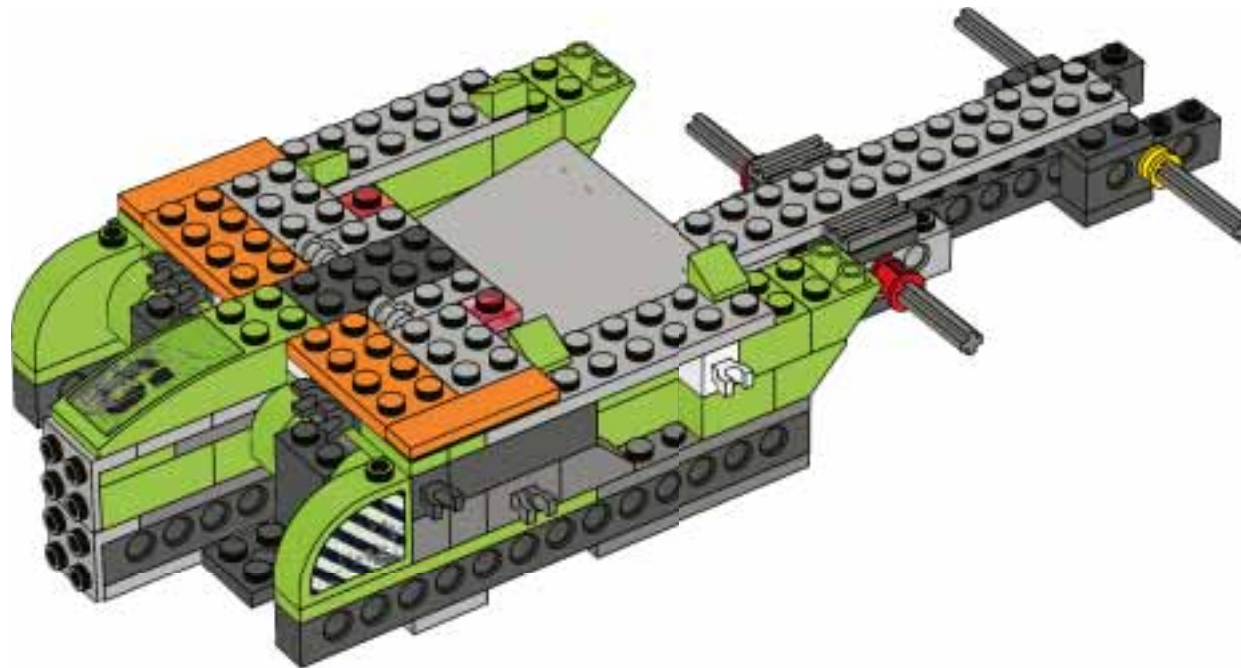

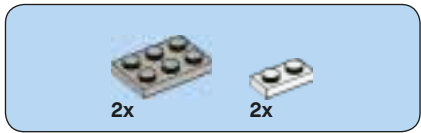

# 35

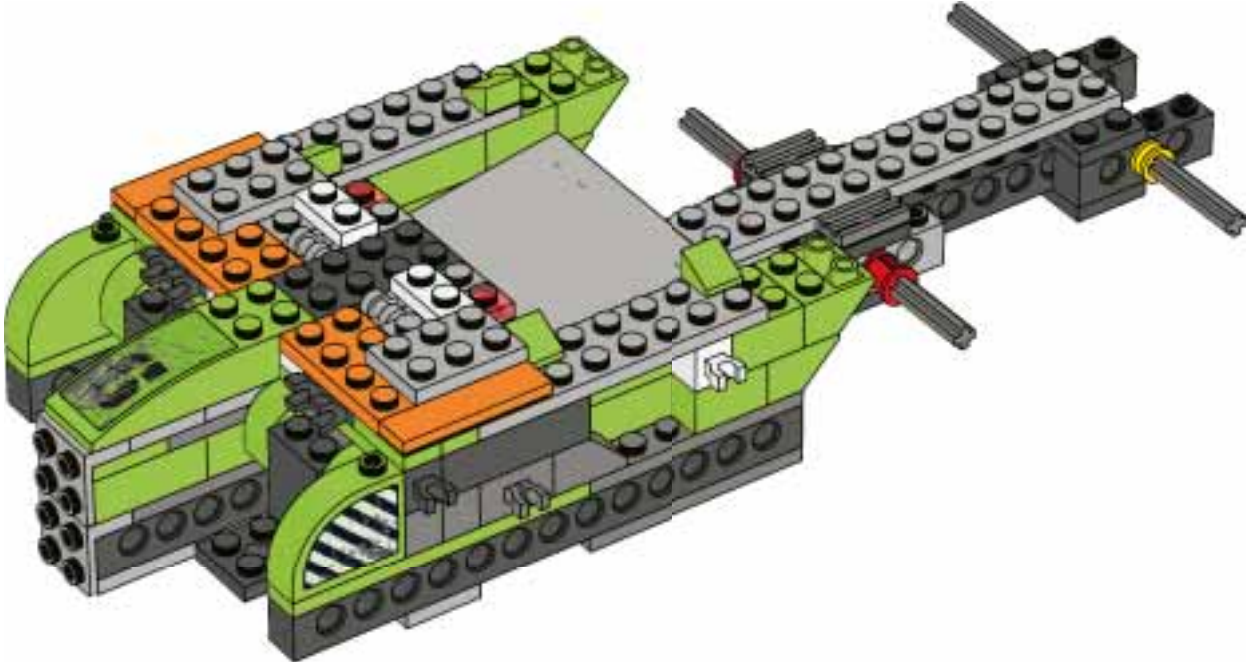



36

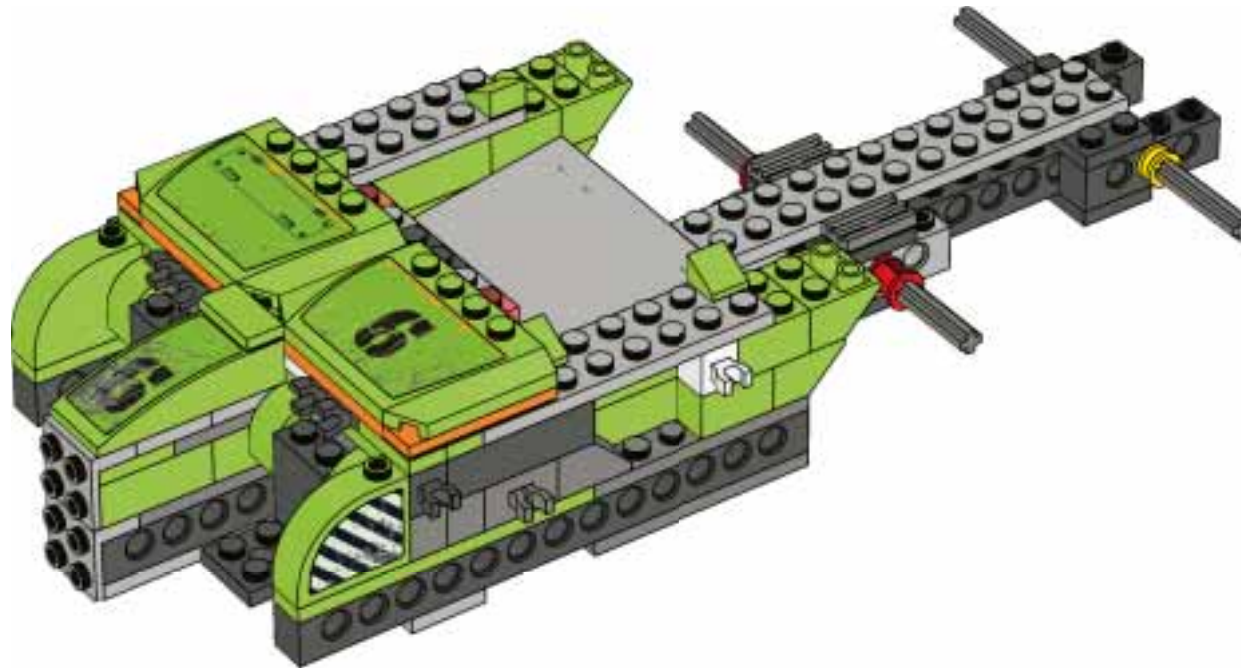



# 37

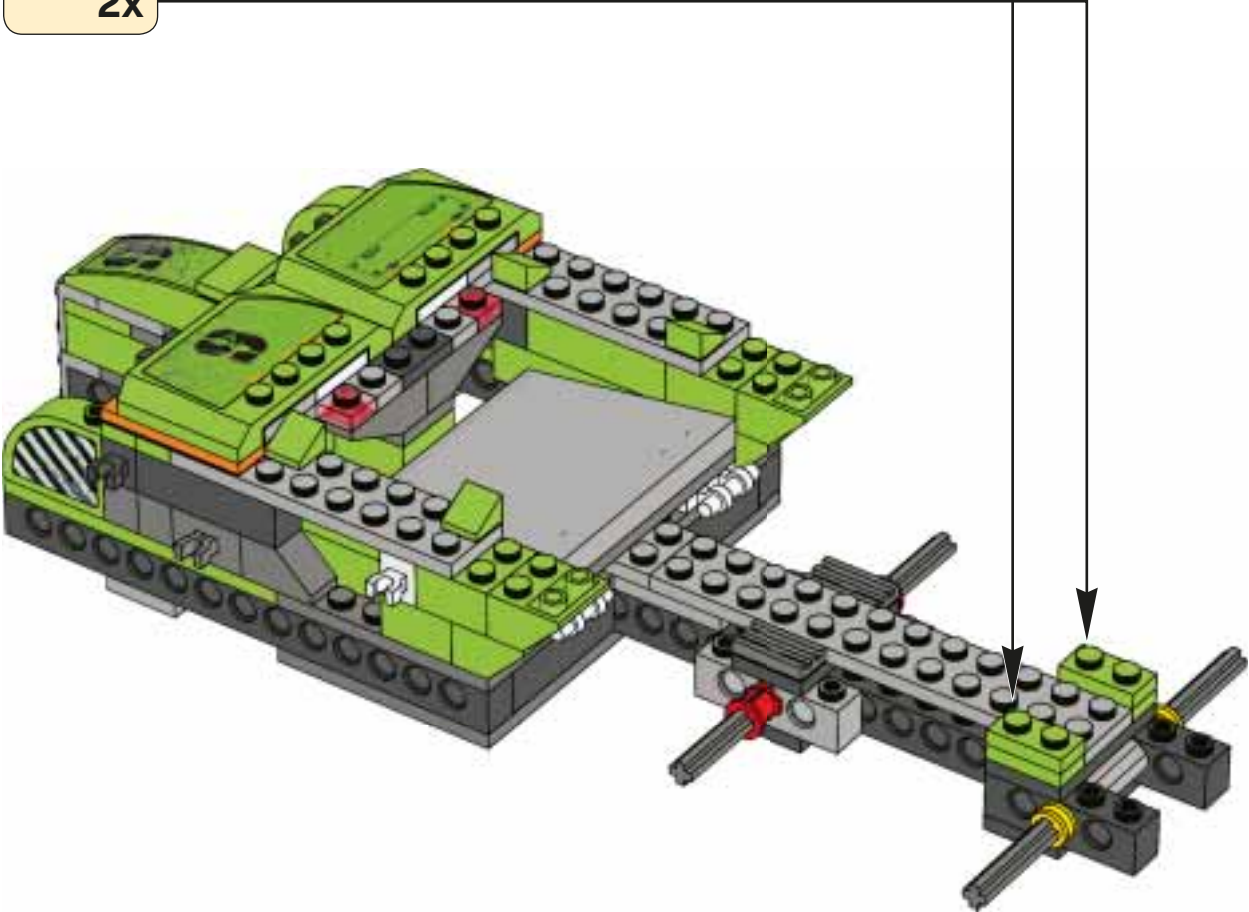
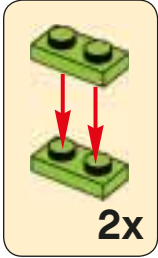

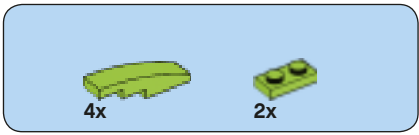

# 38

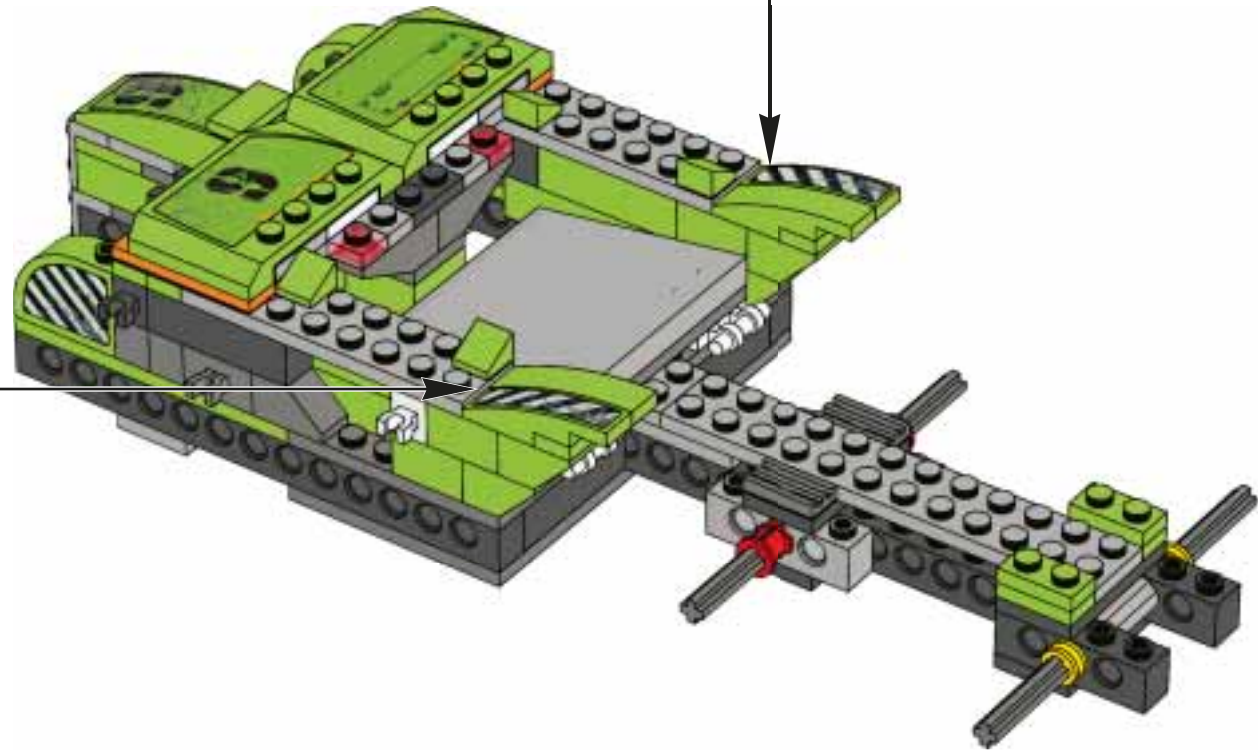
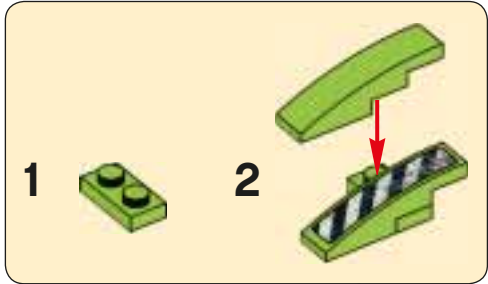
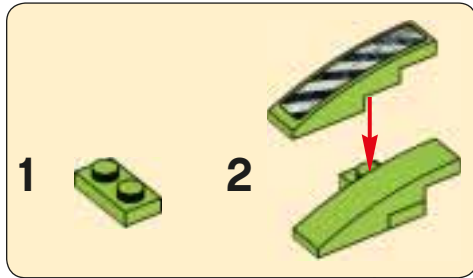





2x

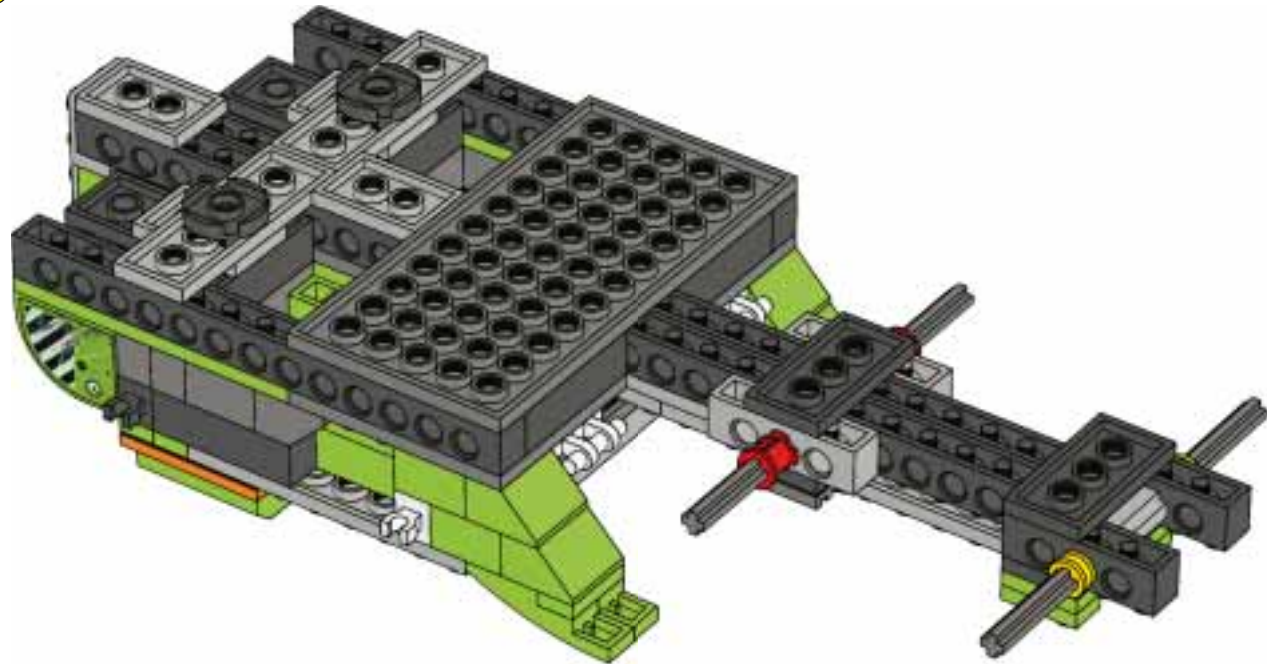

# 39

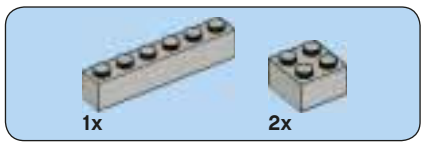

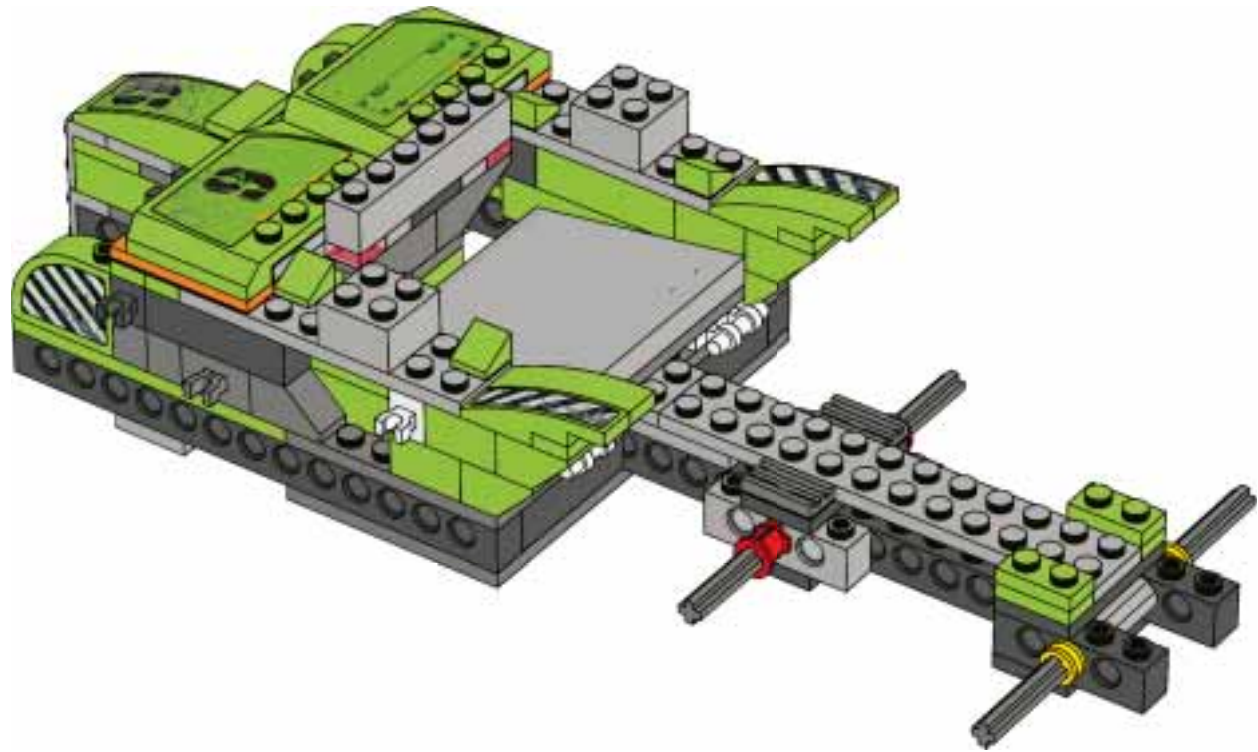

40



4x  2x 

41

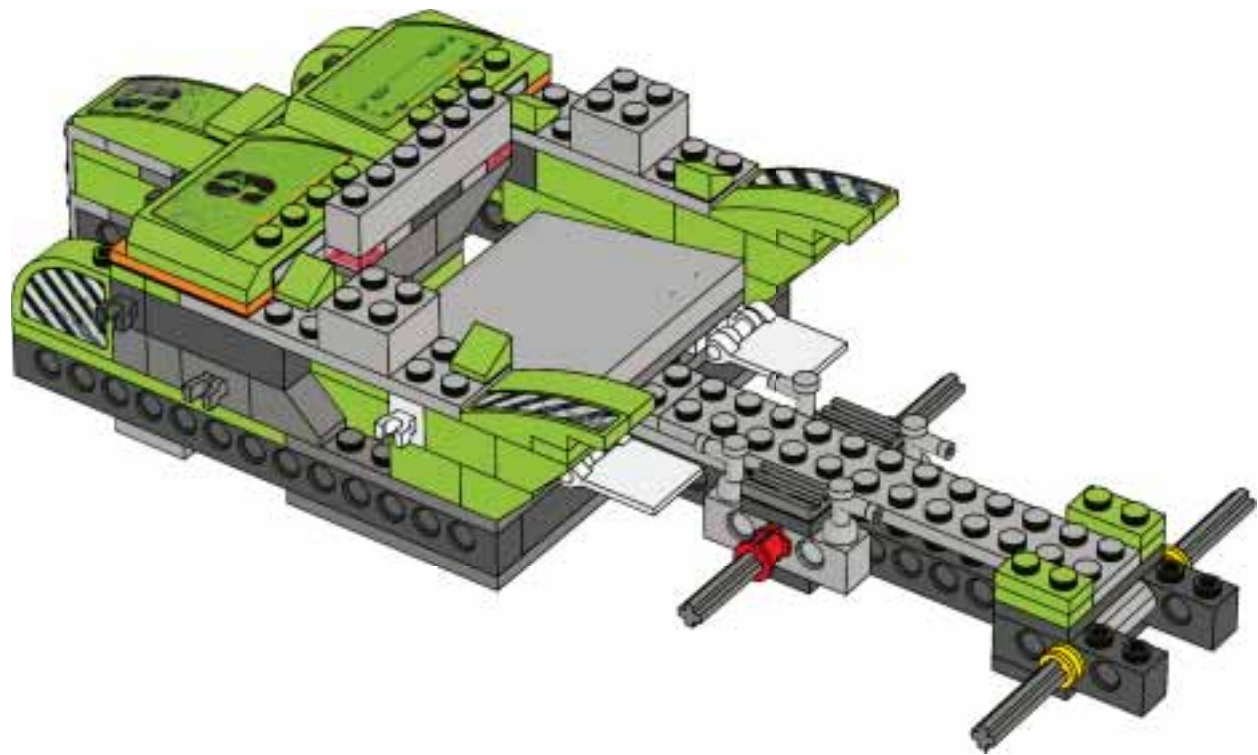

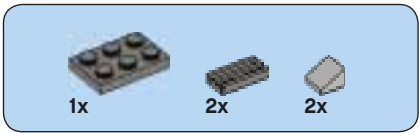

# 42

- 1
- 2
- 3

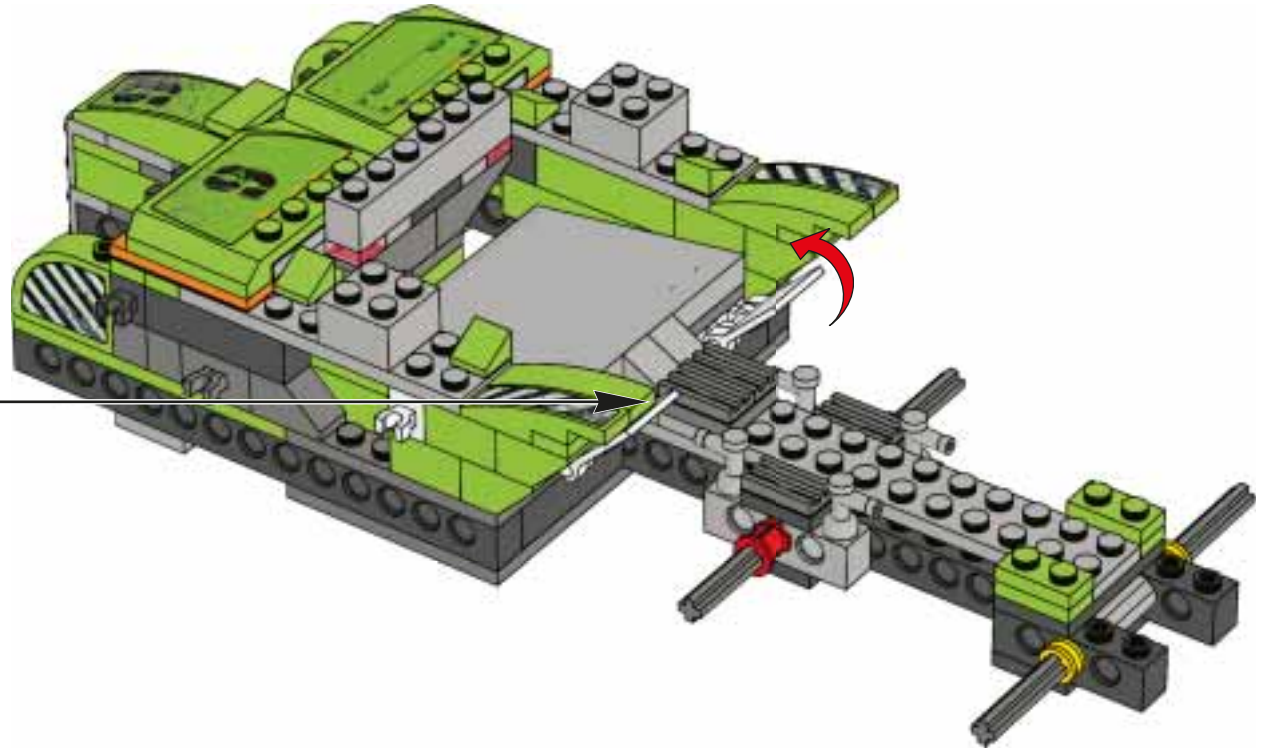

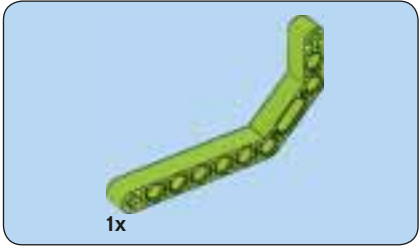
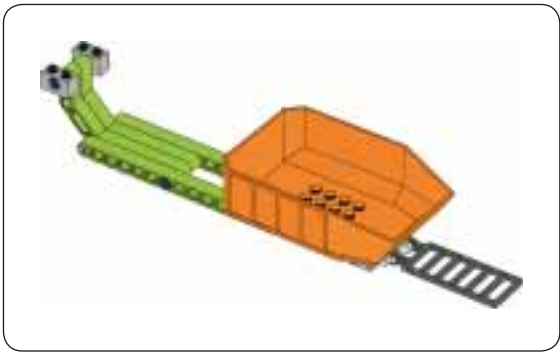

1

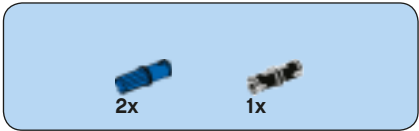
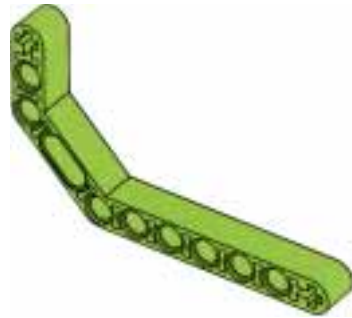

2

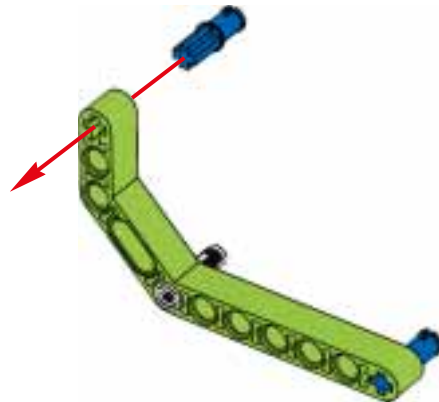

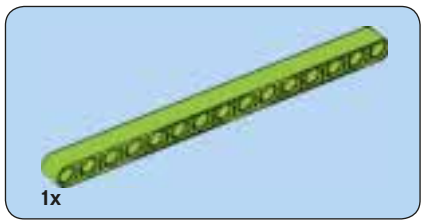

3

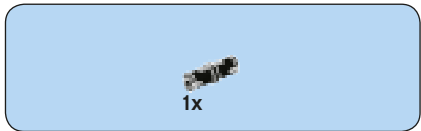
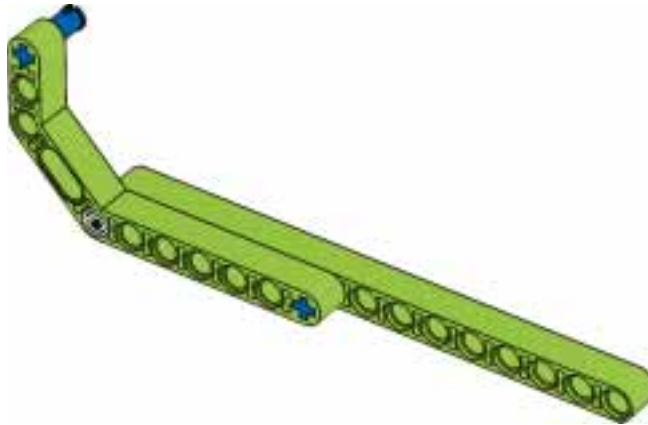

4

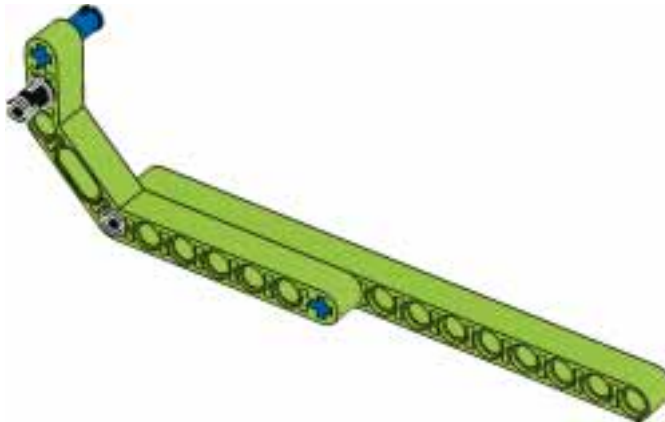

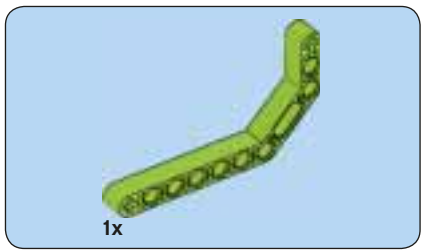

5

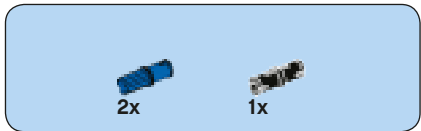
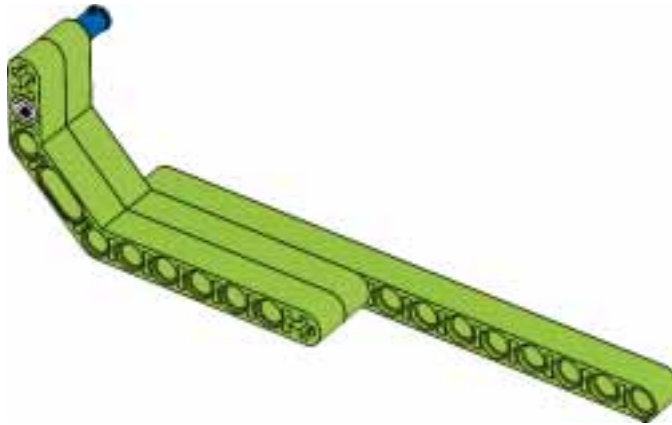

6

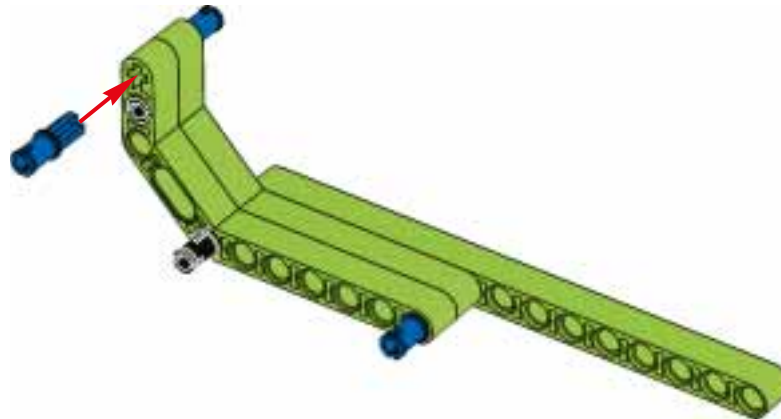

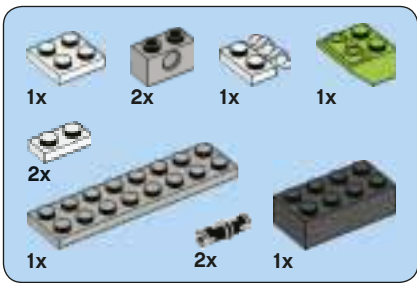

# 7

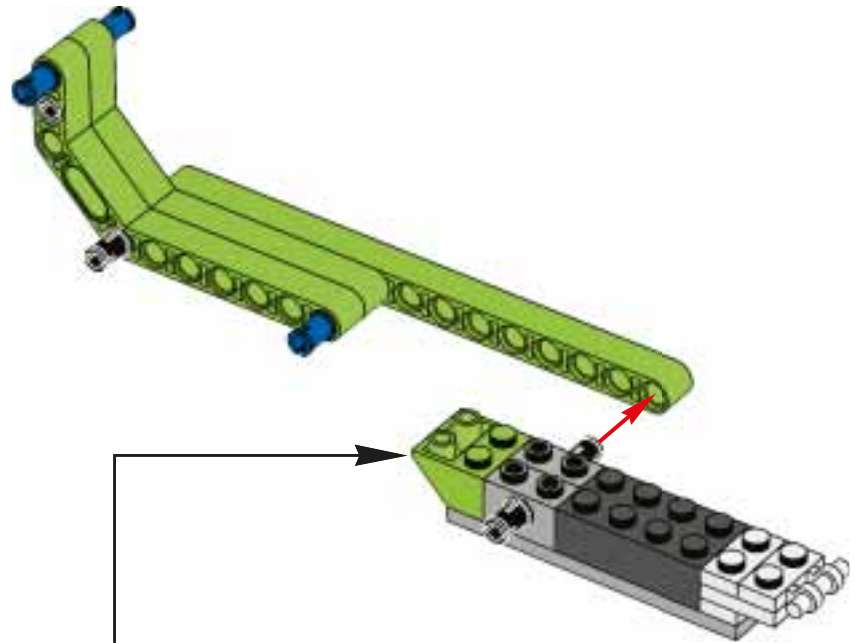
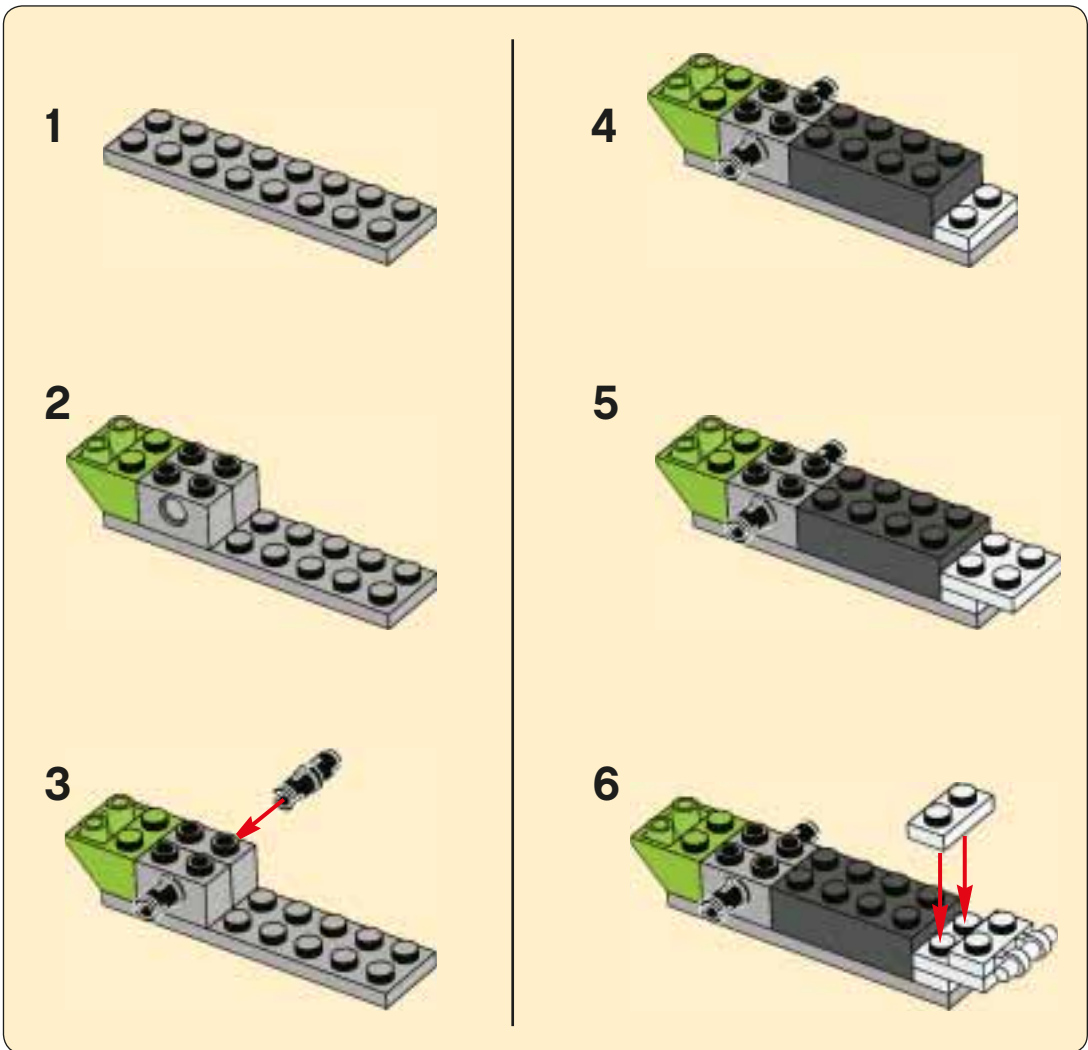



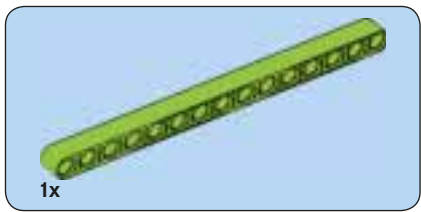

8

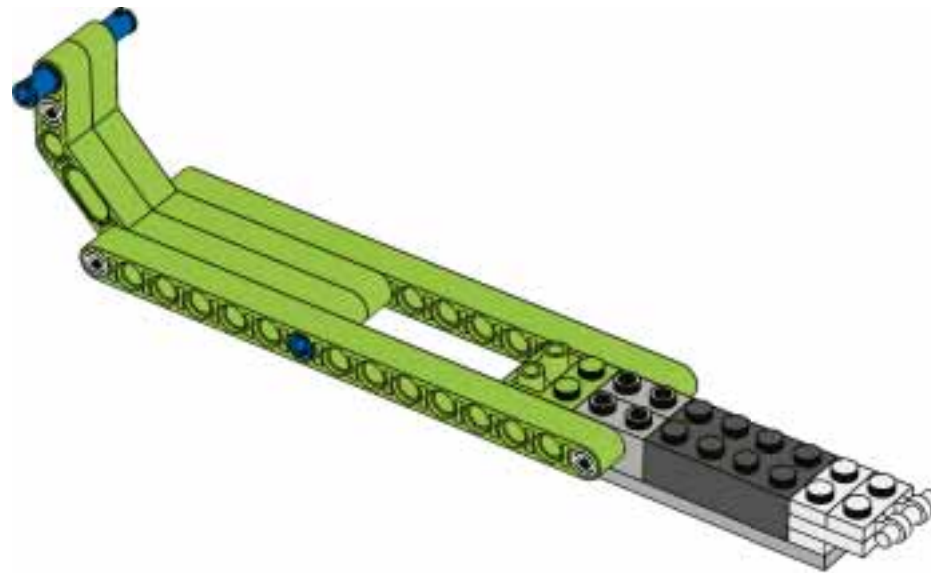



9

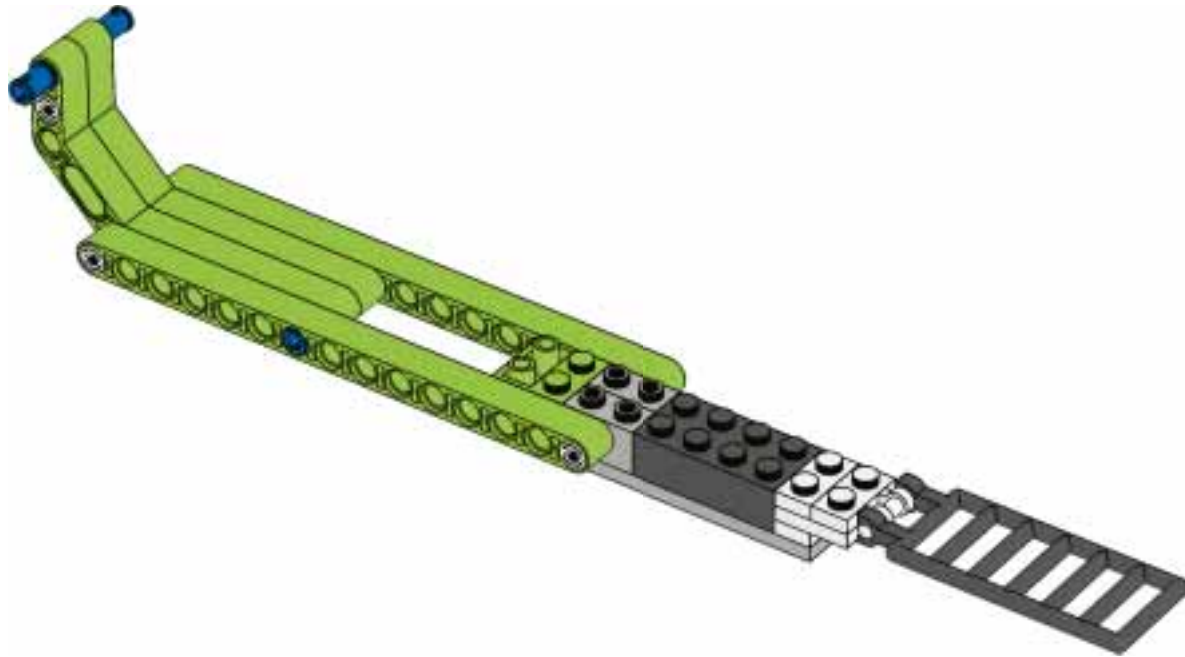

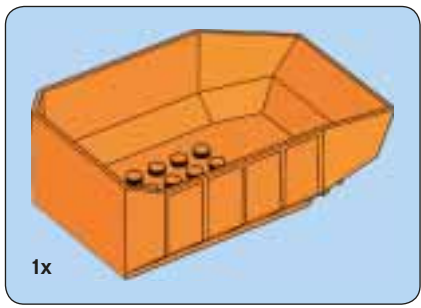

10

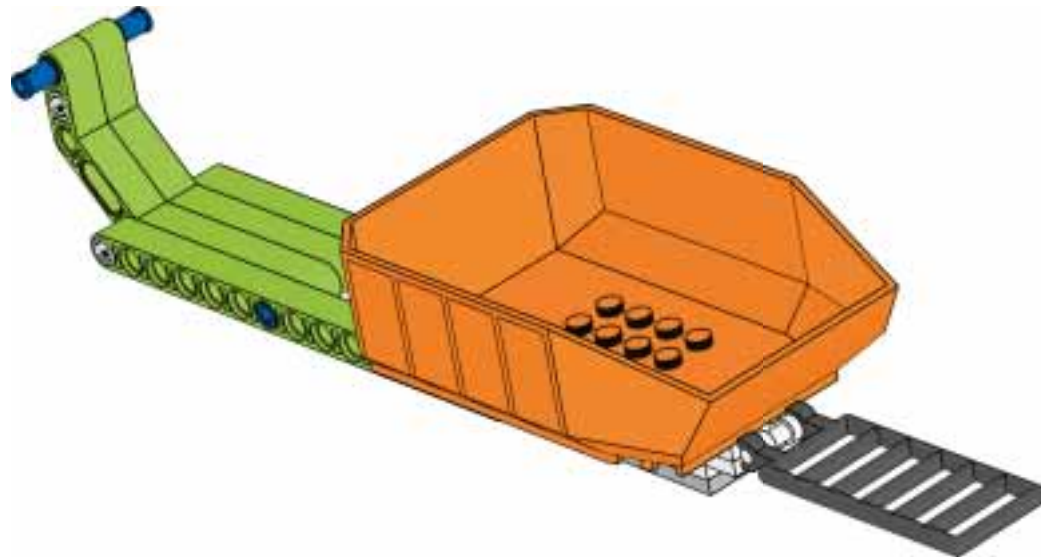

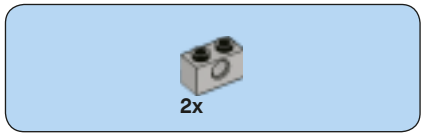

11

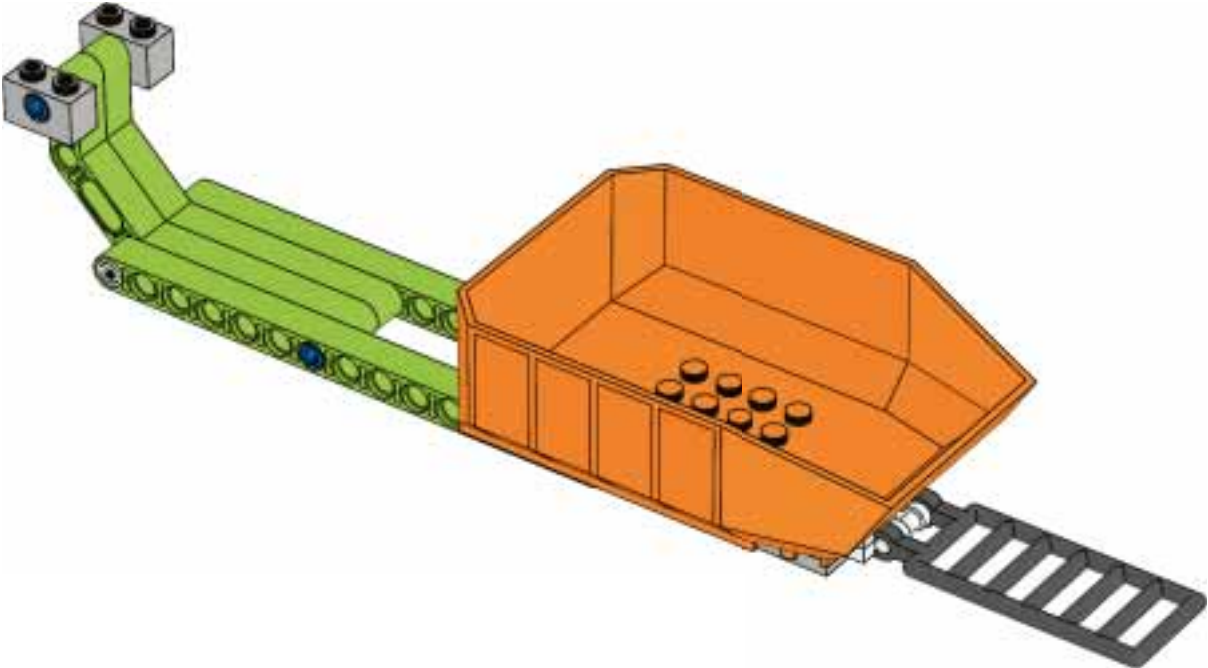

43

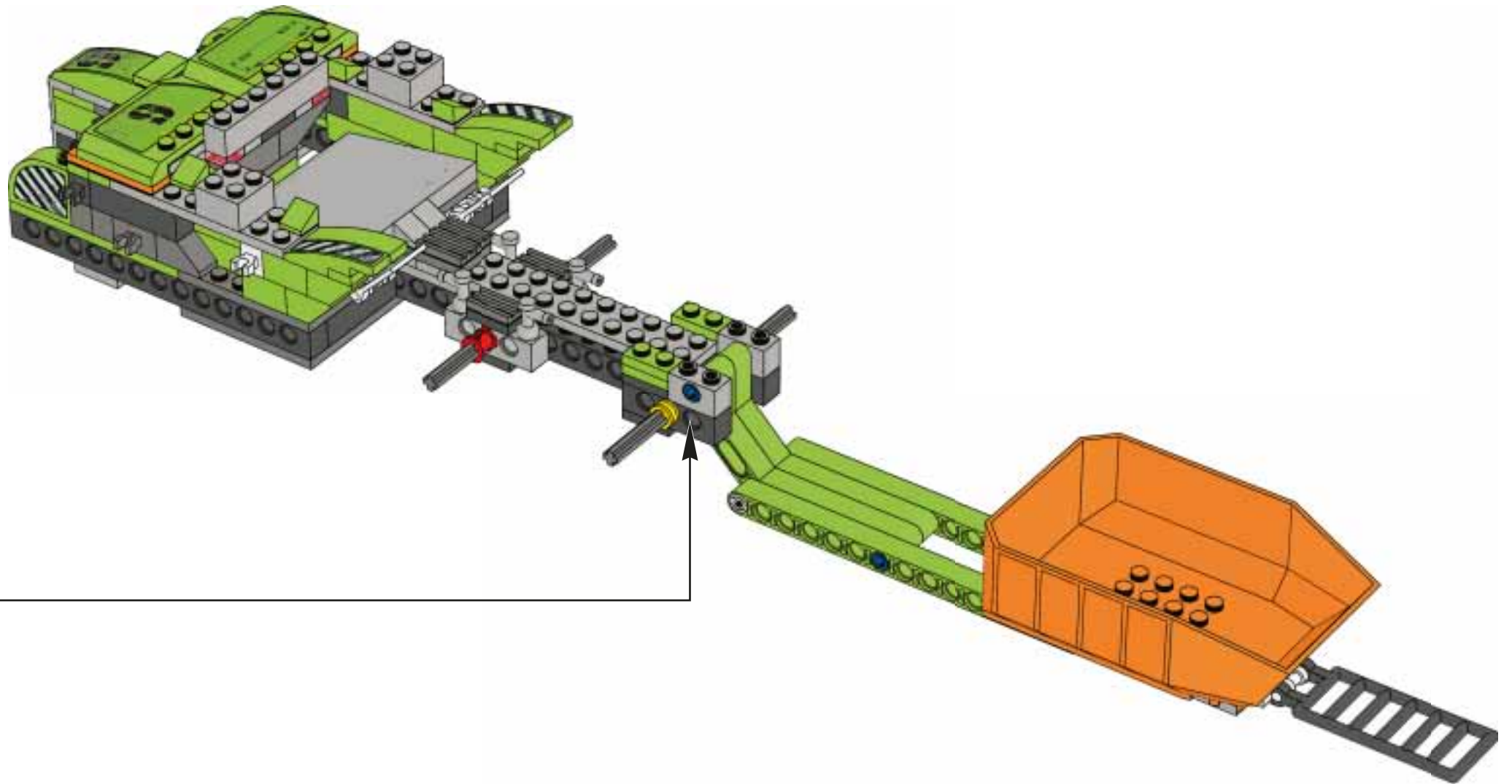

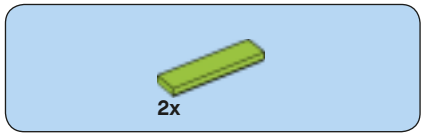

44

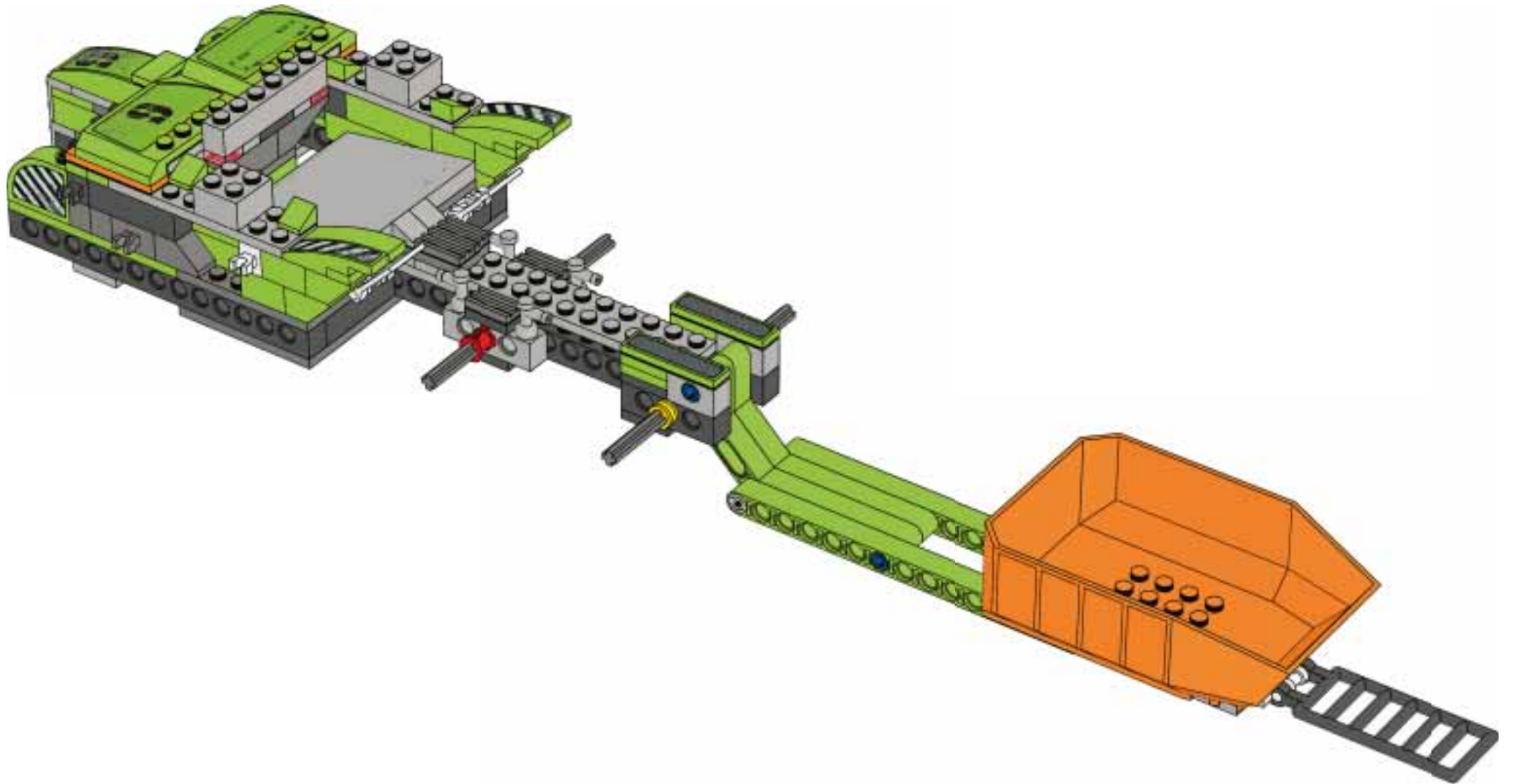

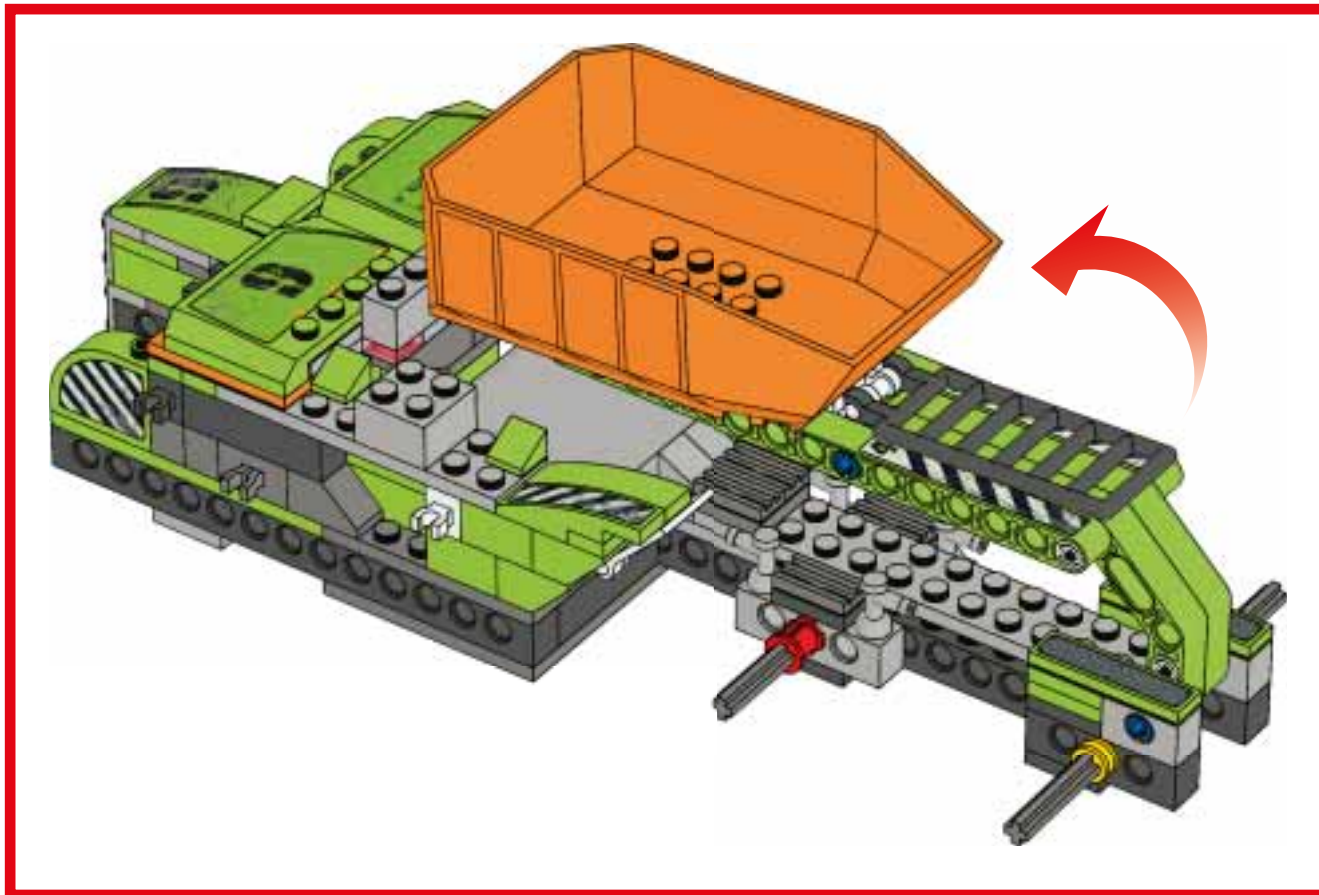

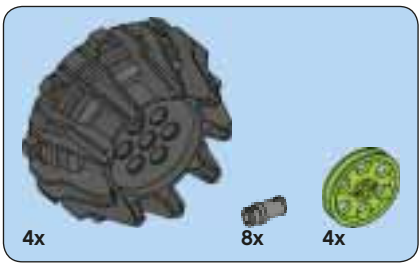

45

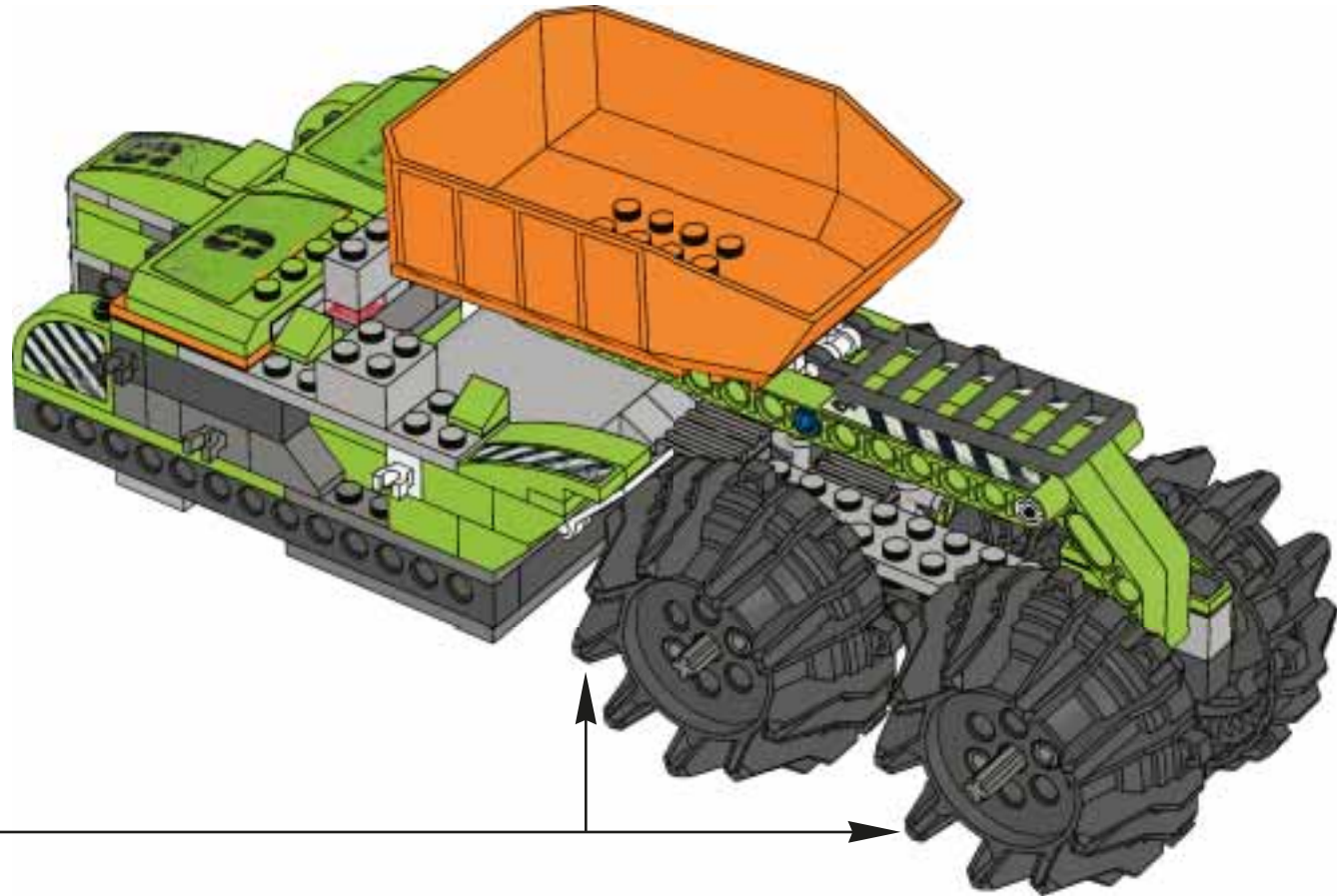



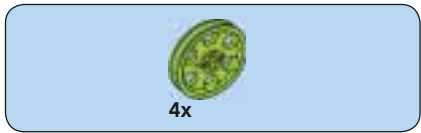

46

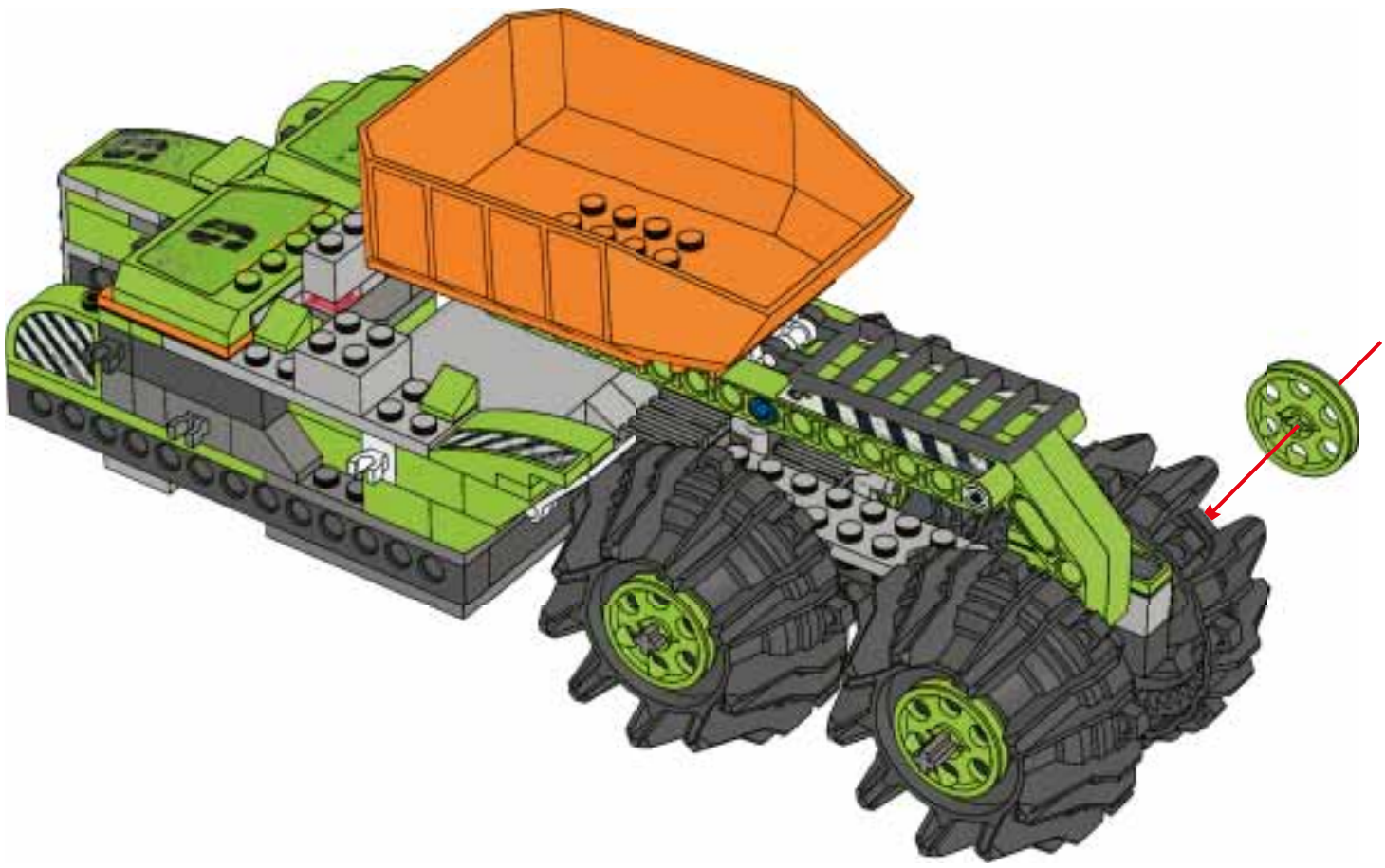

1x

1x

47

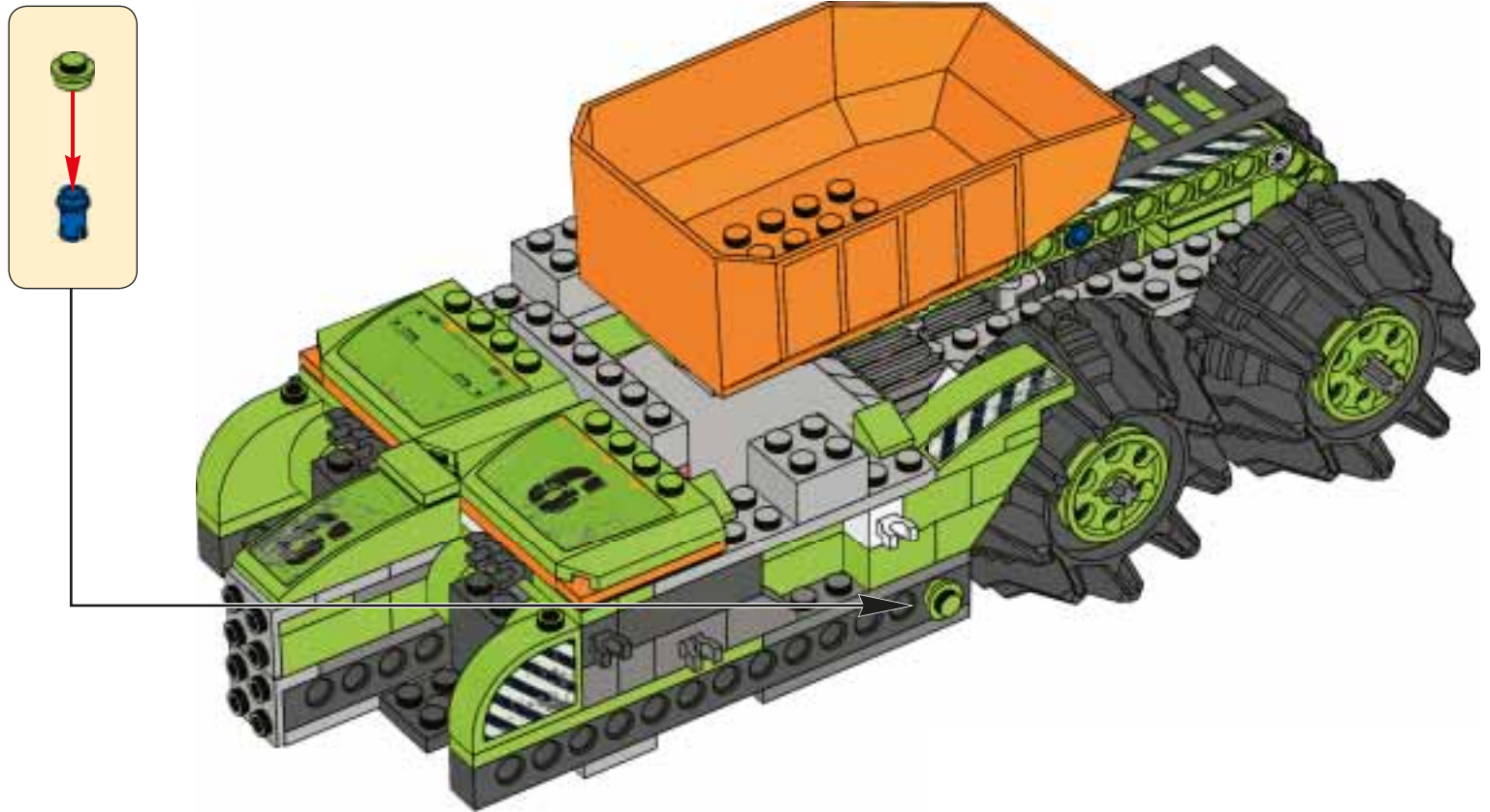

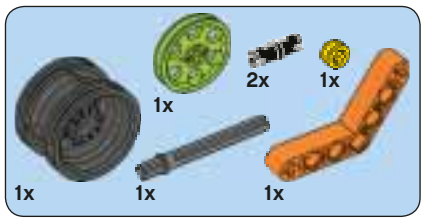

48

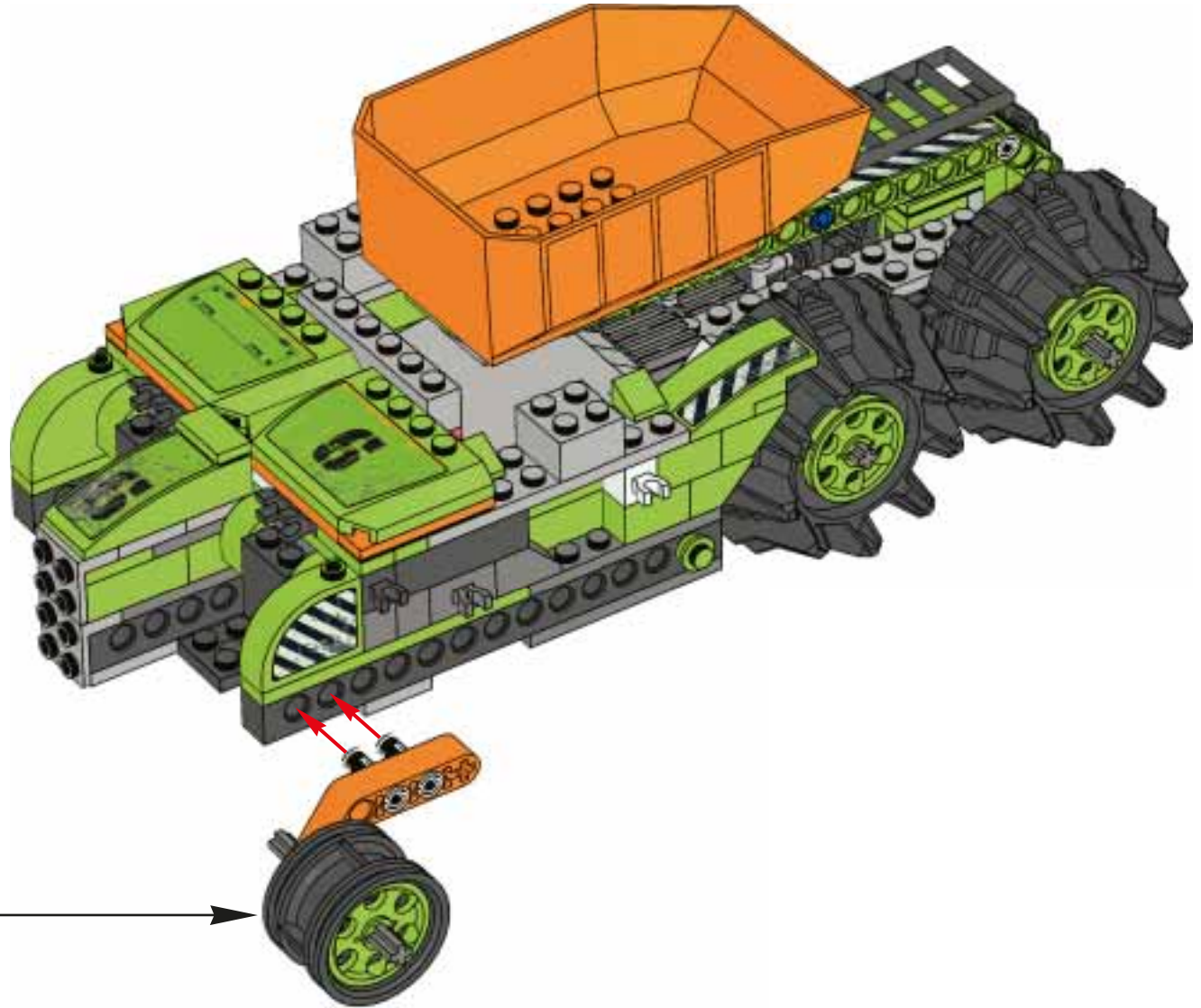
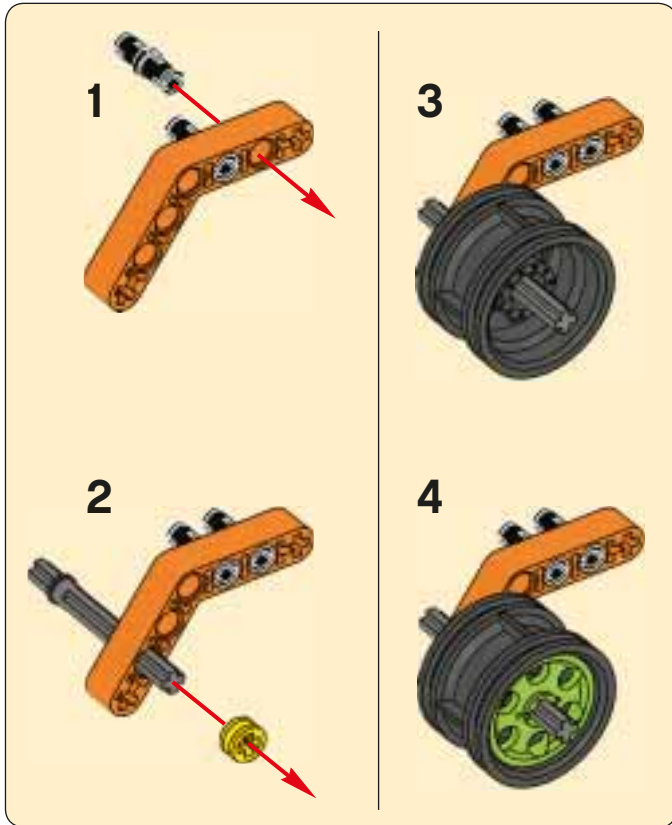



49

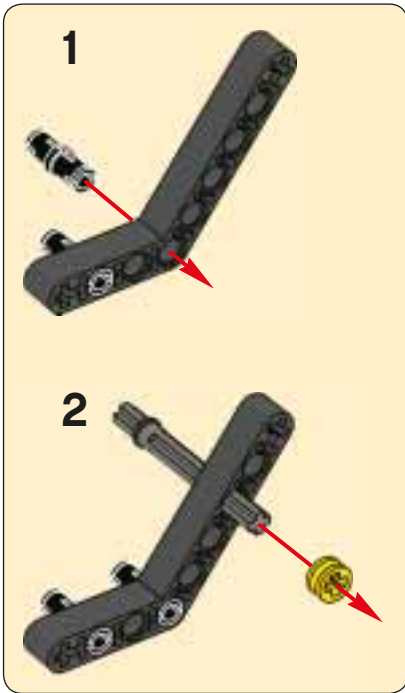
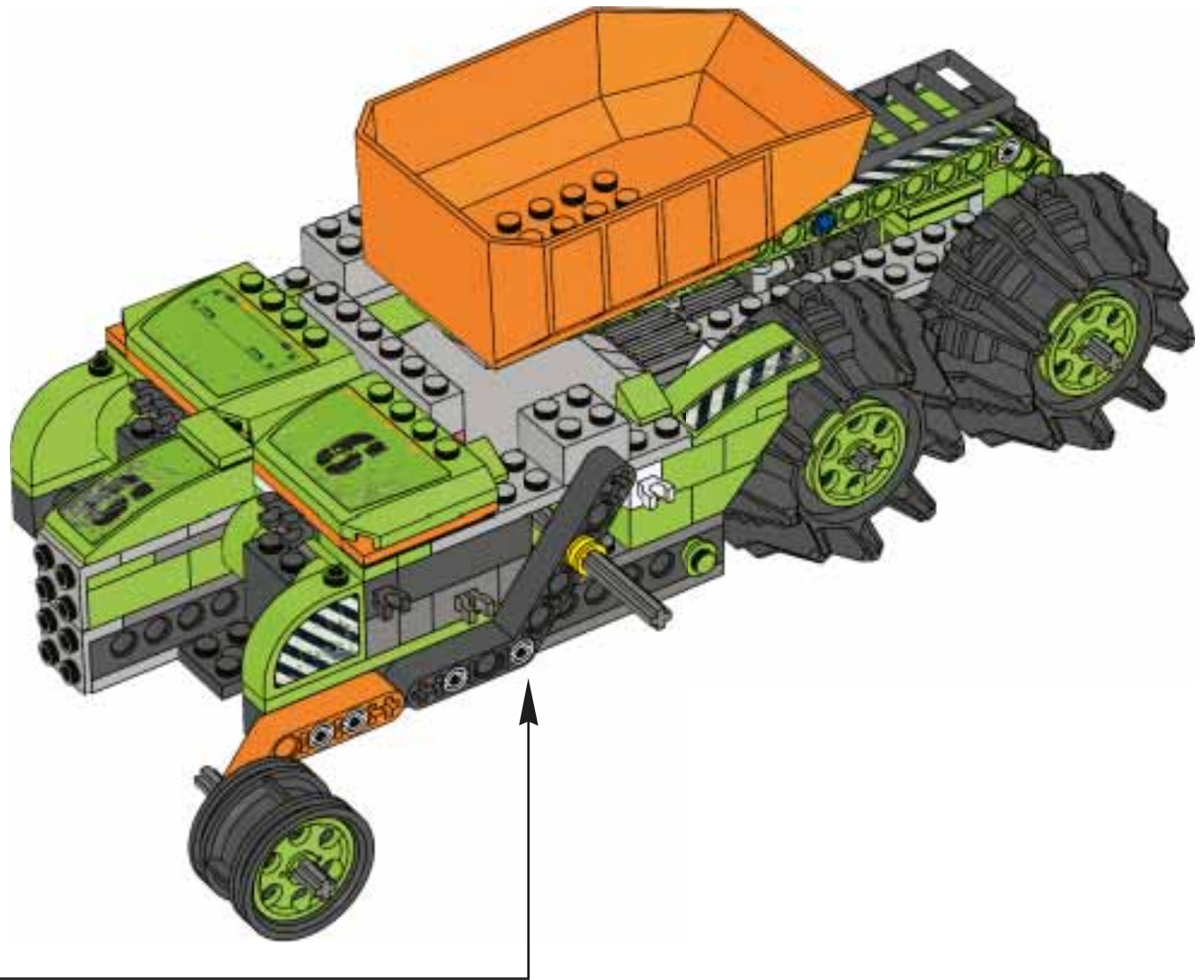

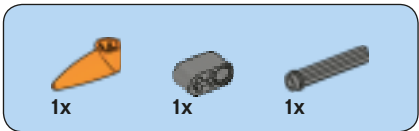

# 50

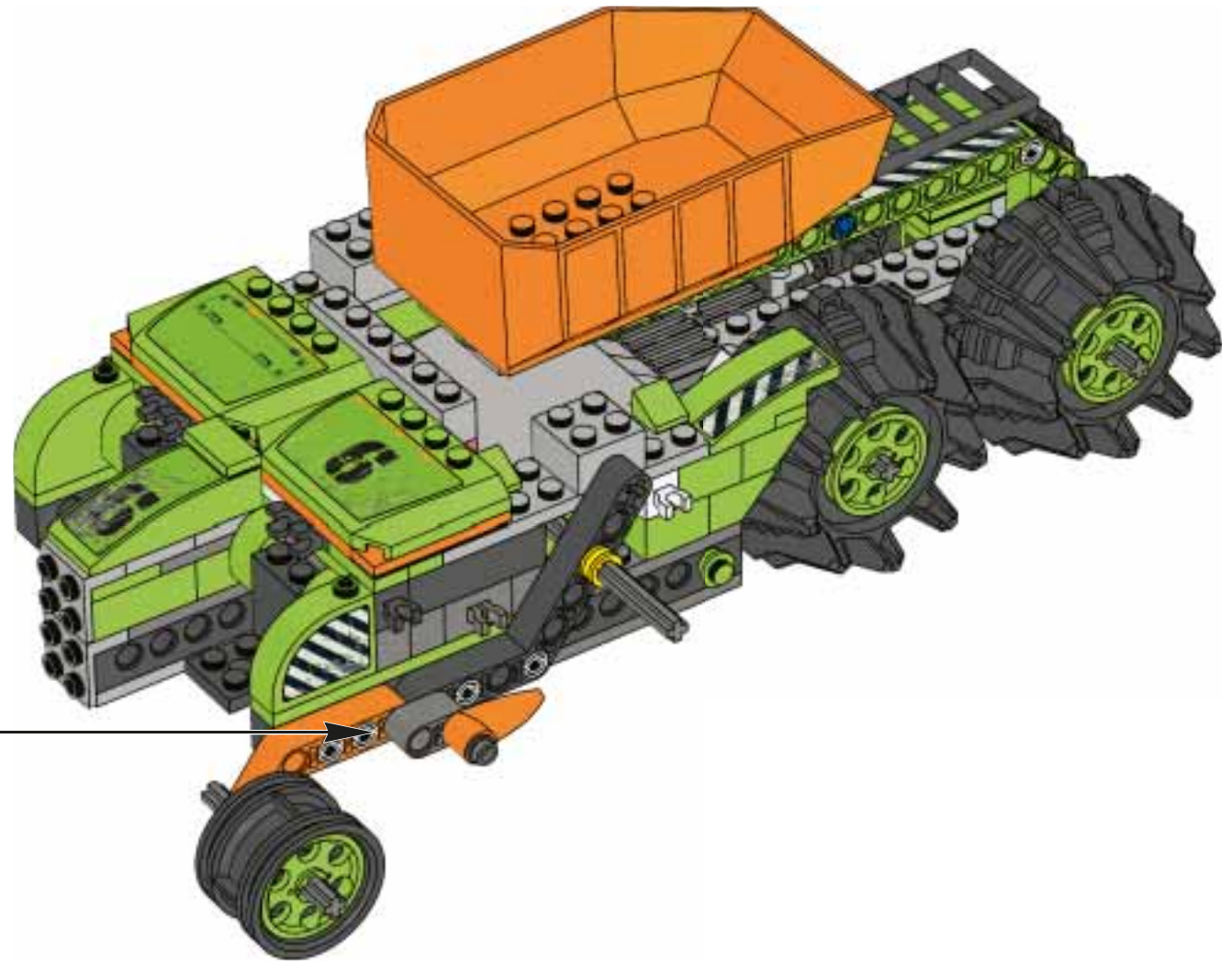
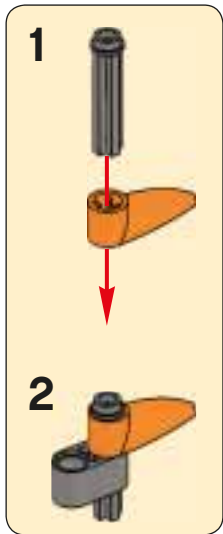

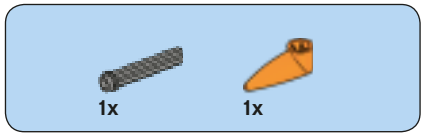

# 51

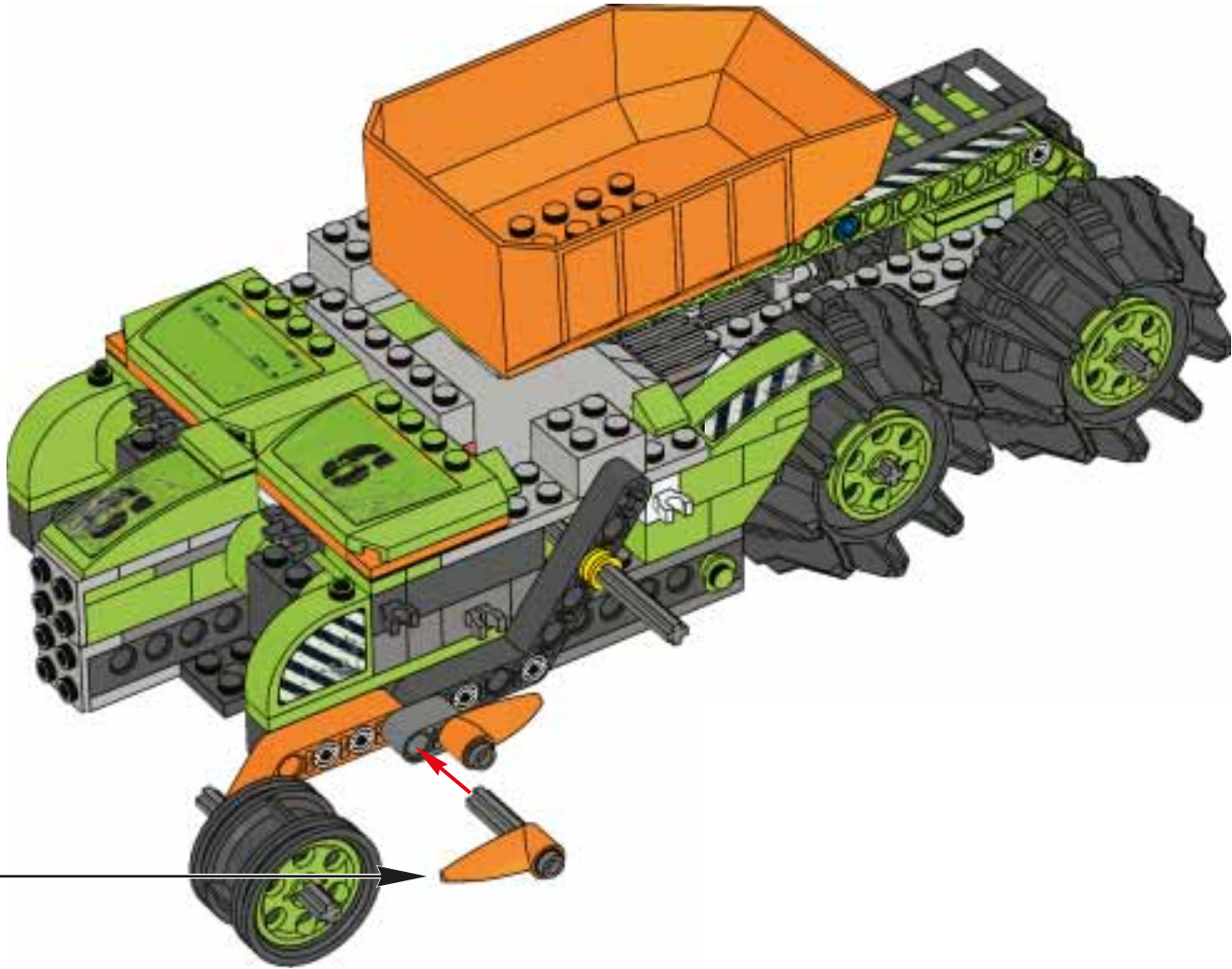
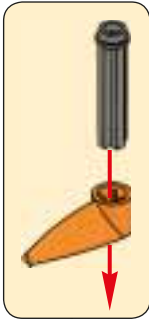

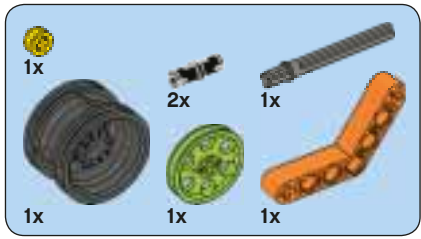

52

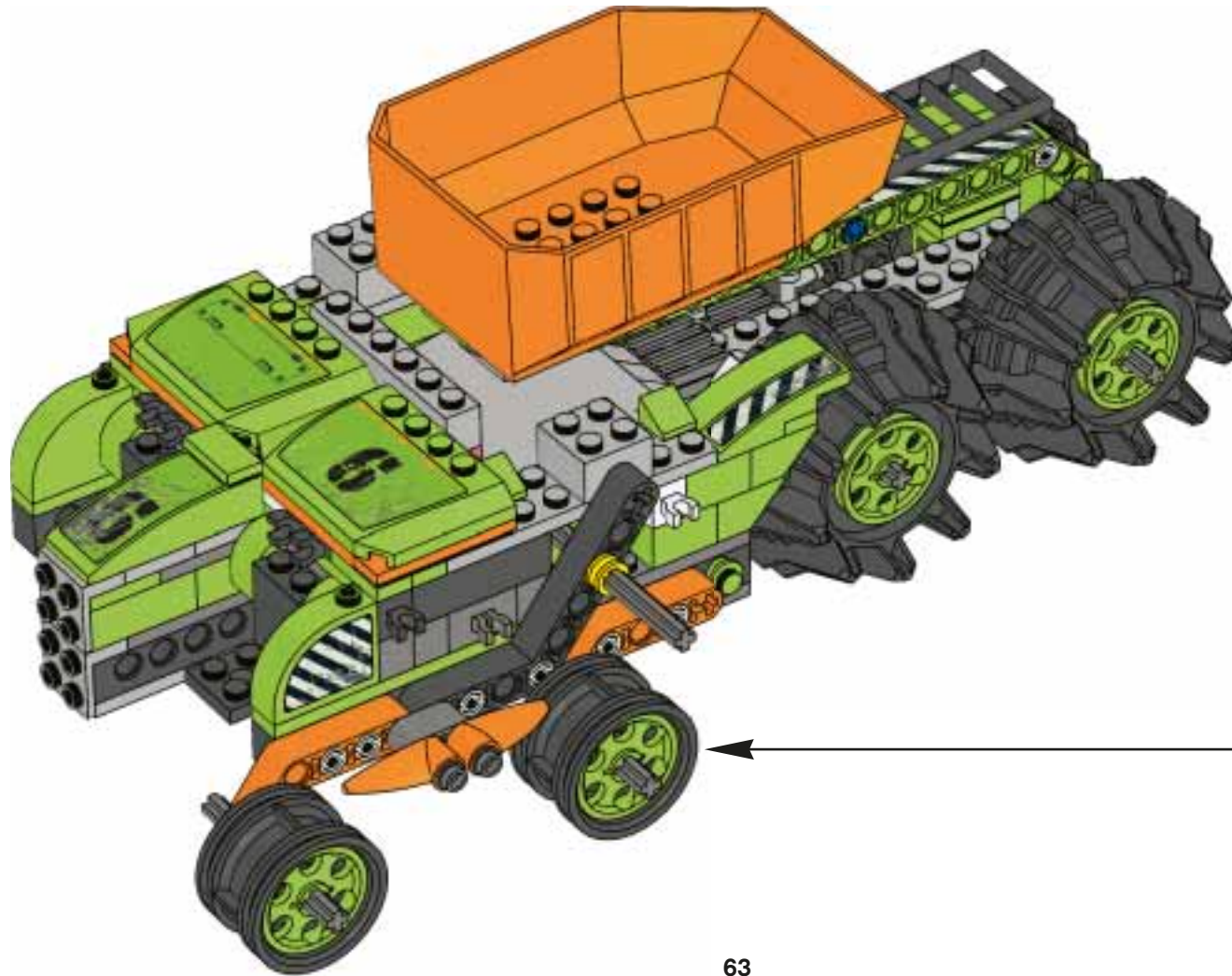
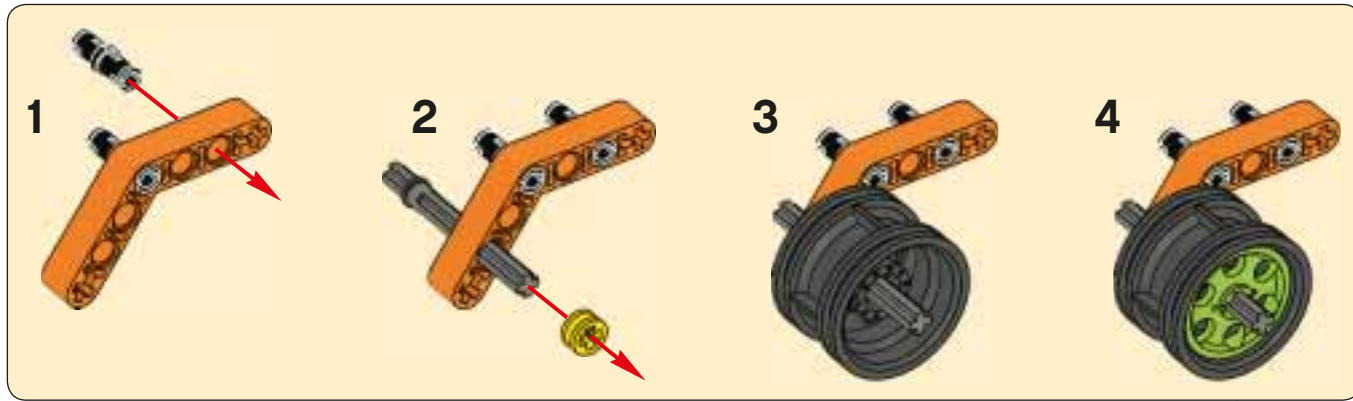

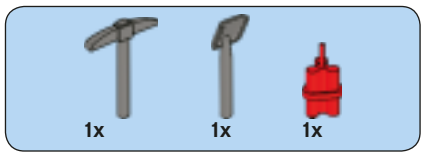

53





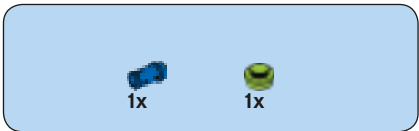

# 54

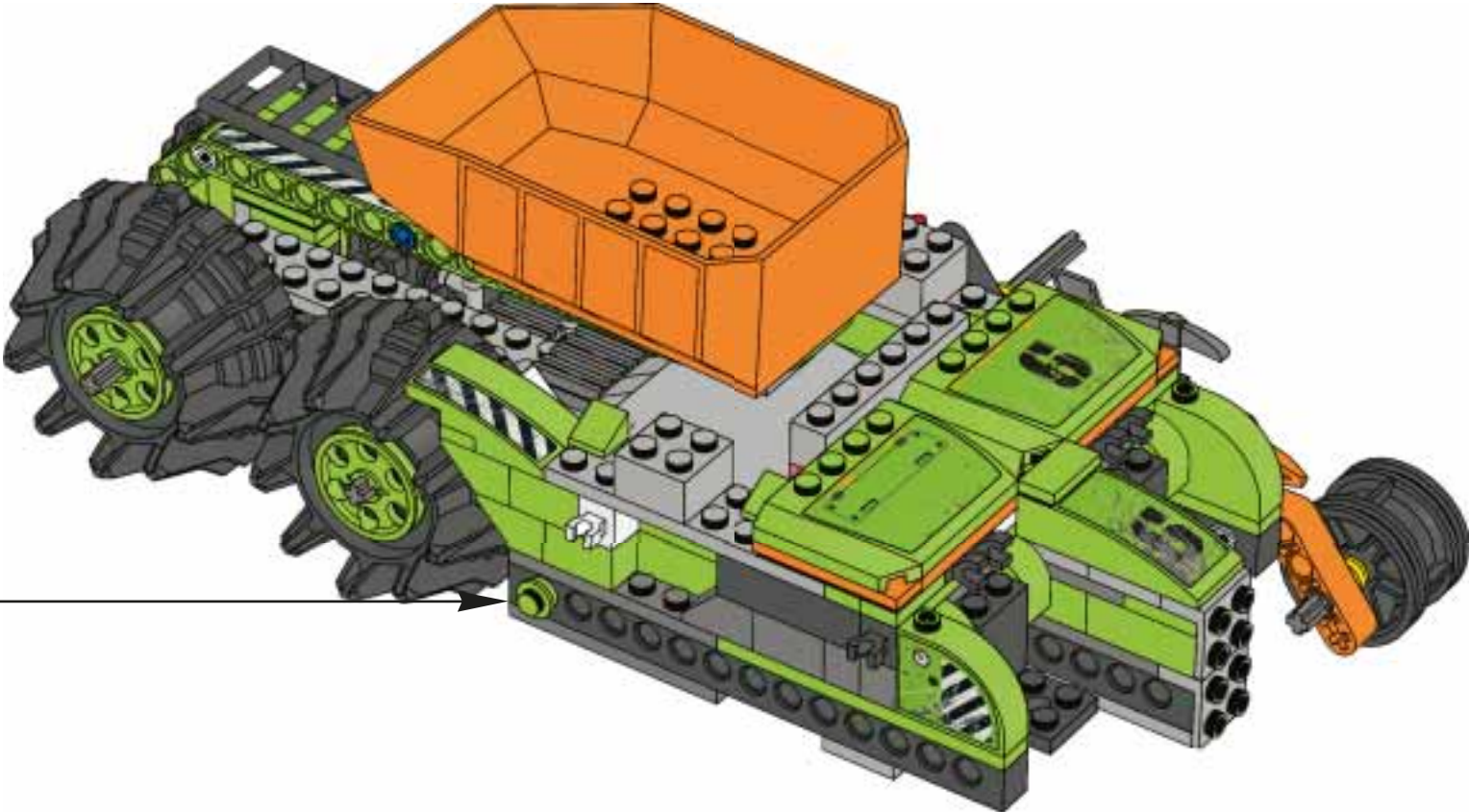
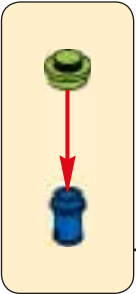



55

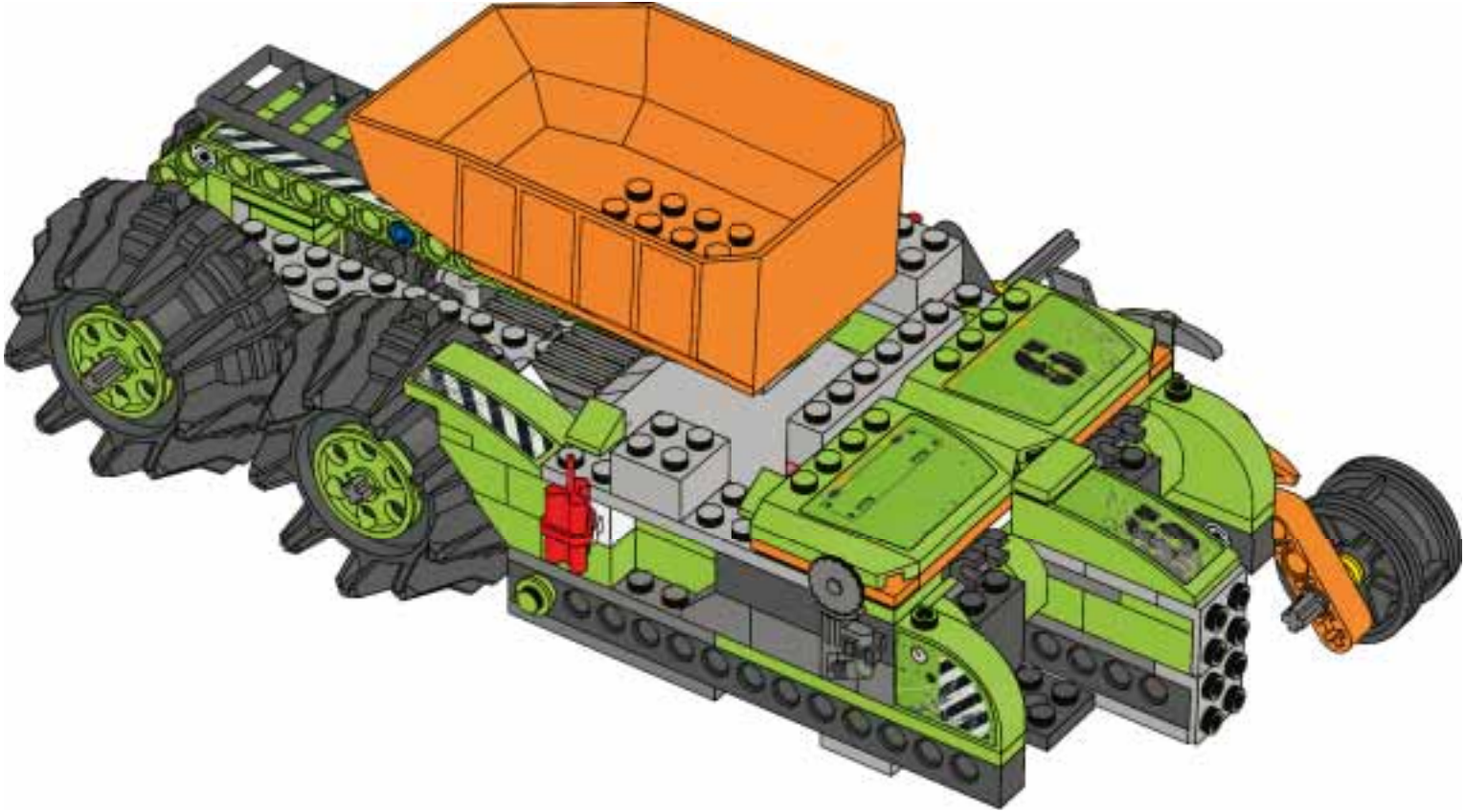



# 56

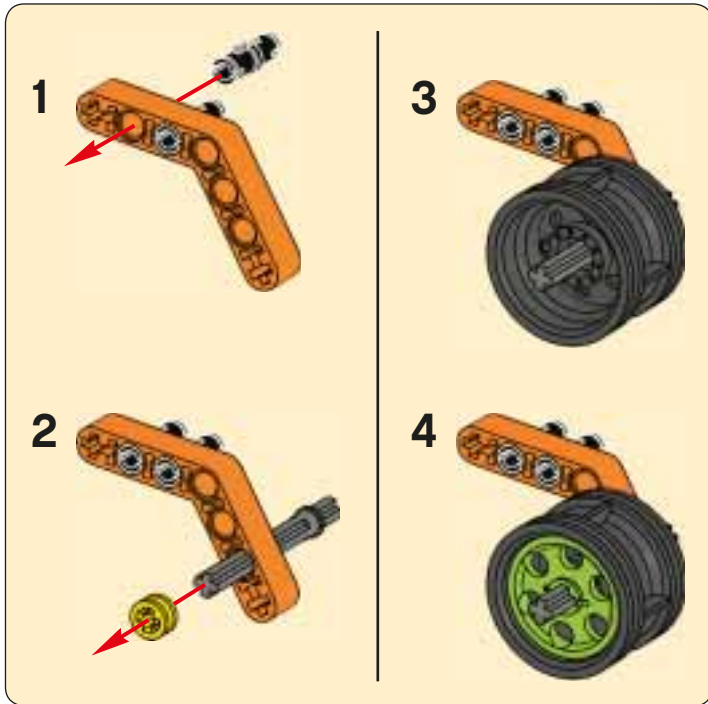
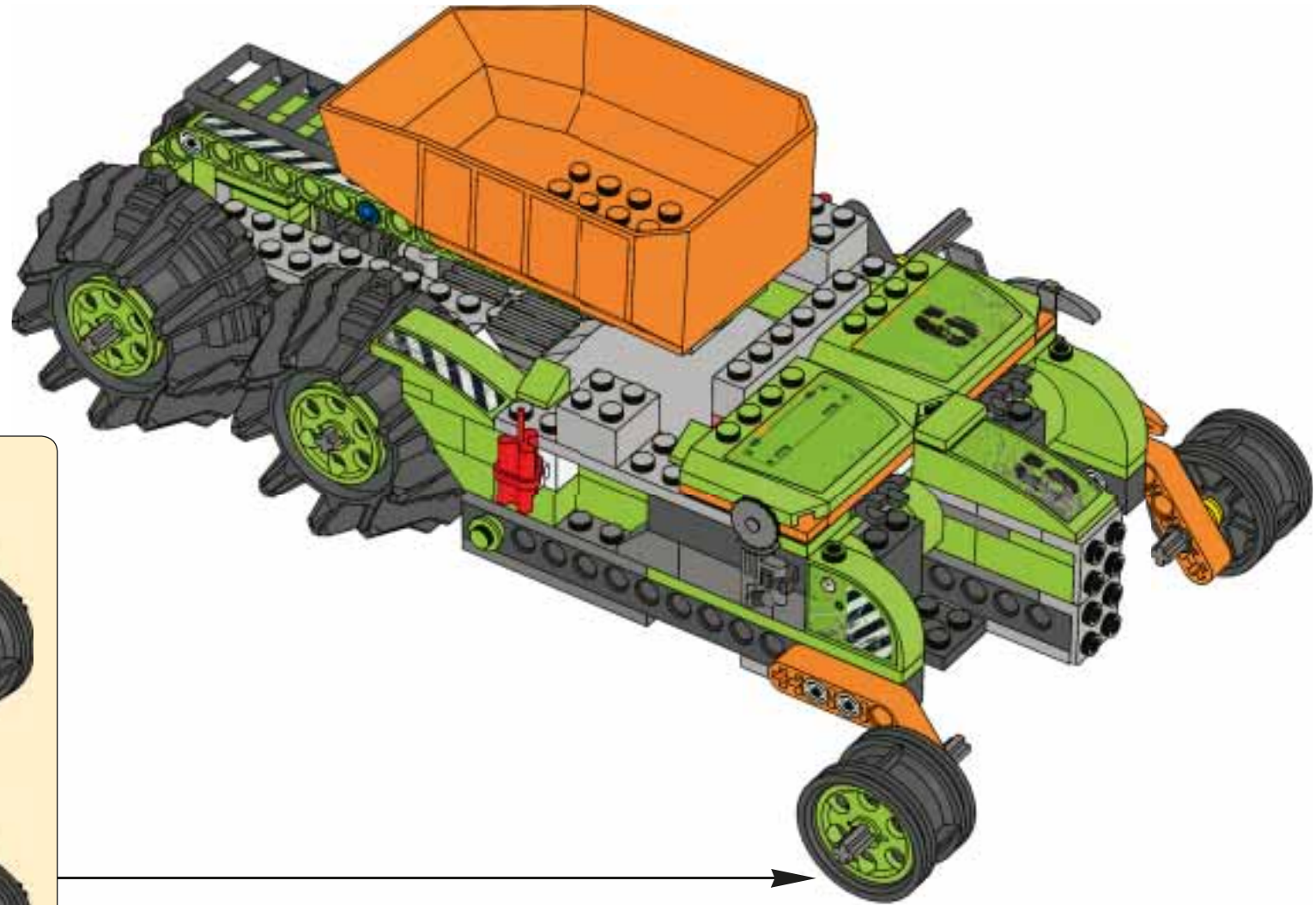



57

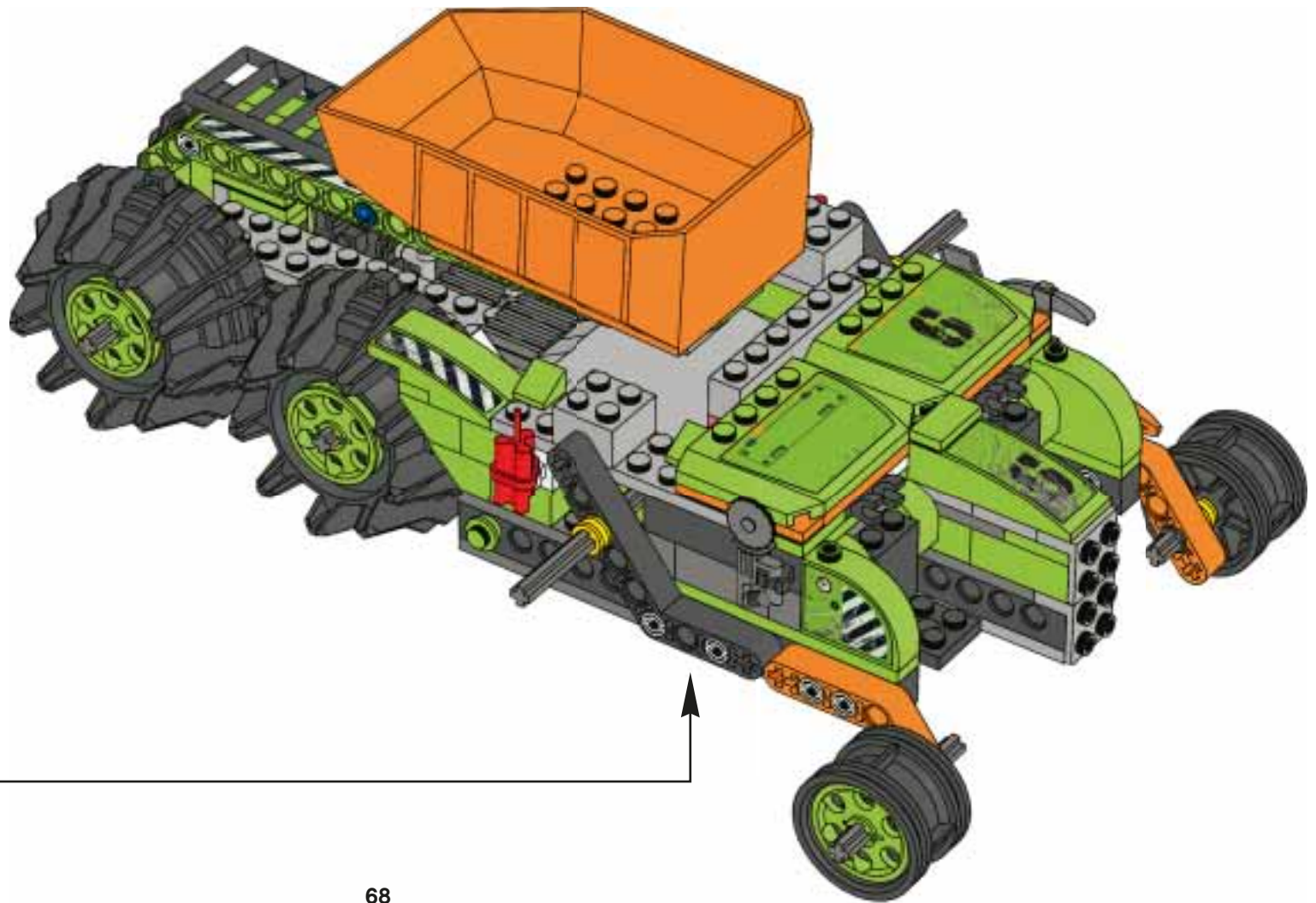
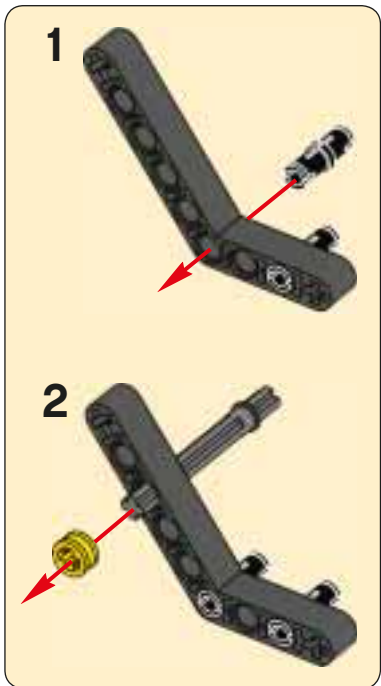

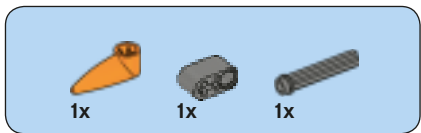

# 58

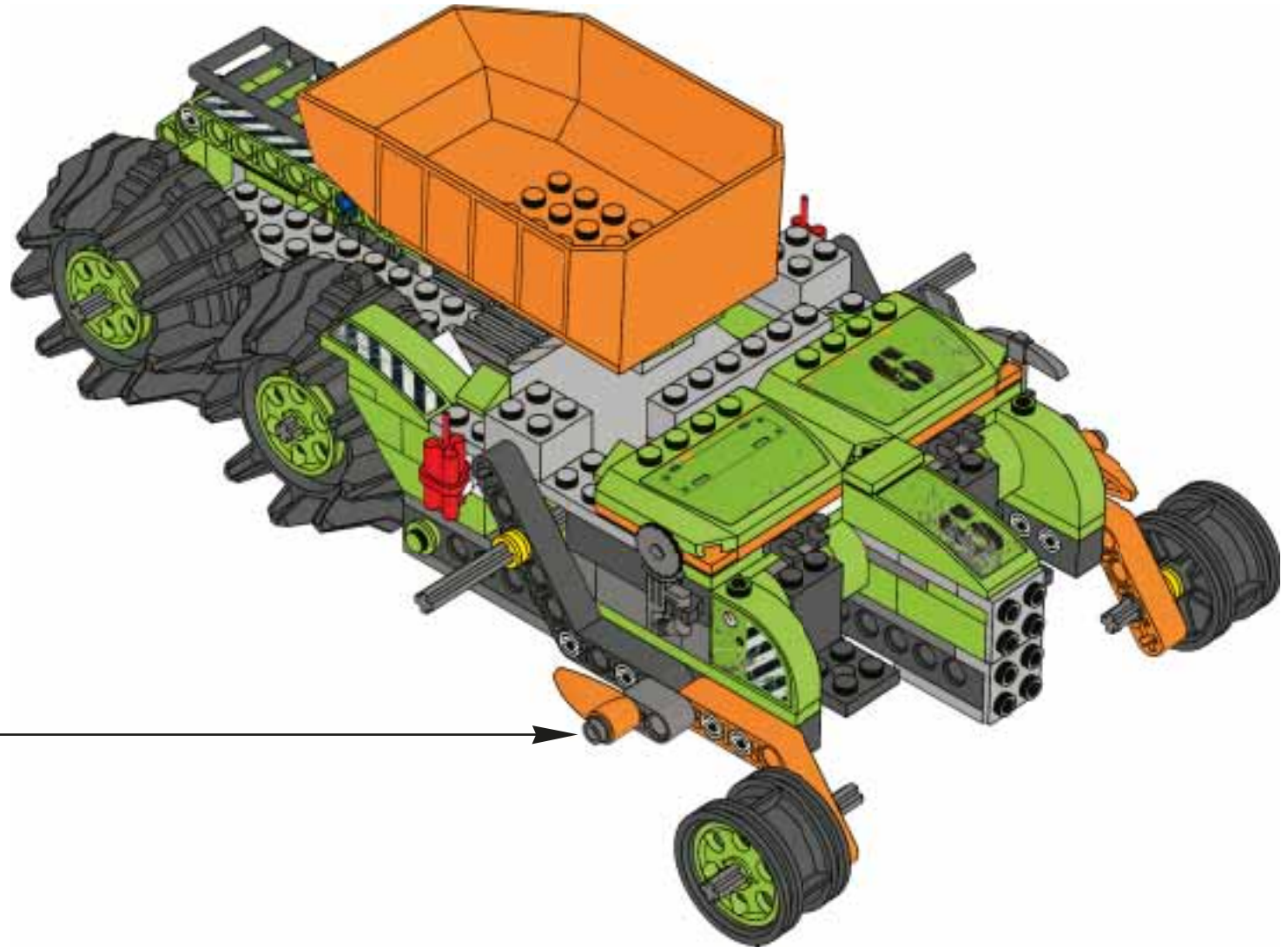
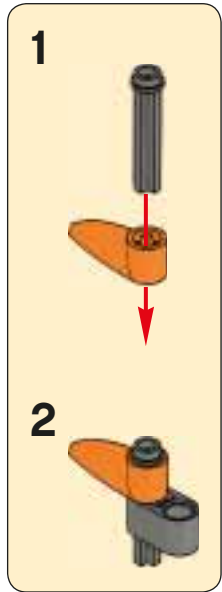

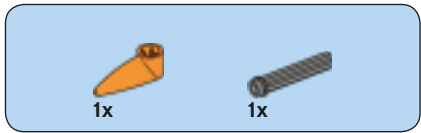

# 59

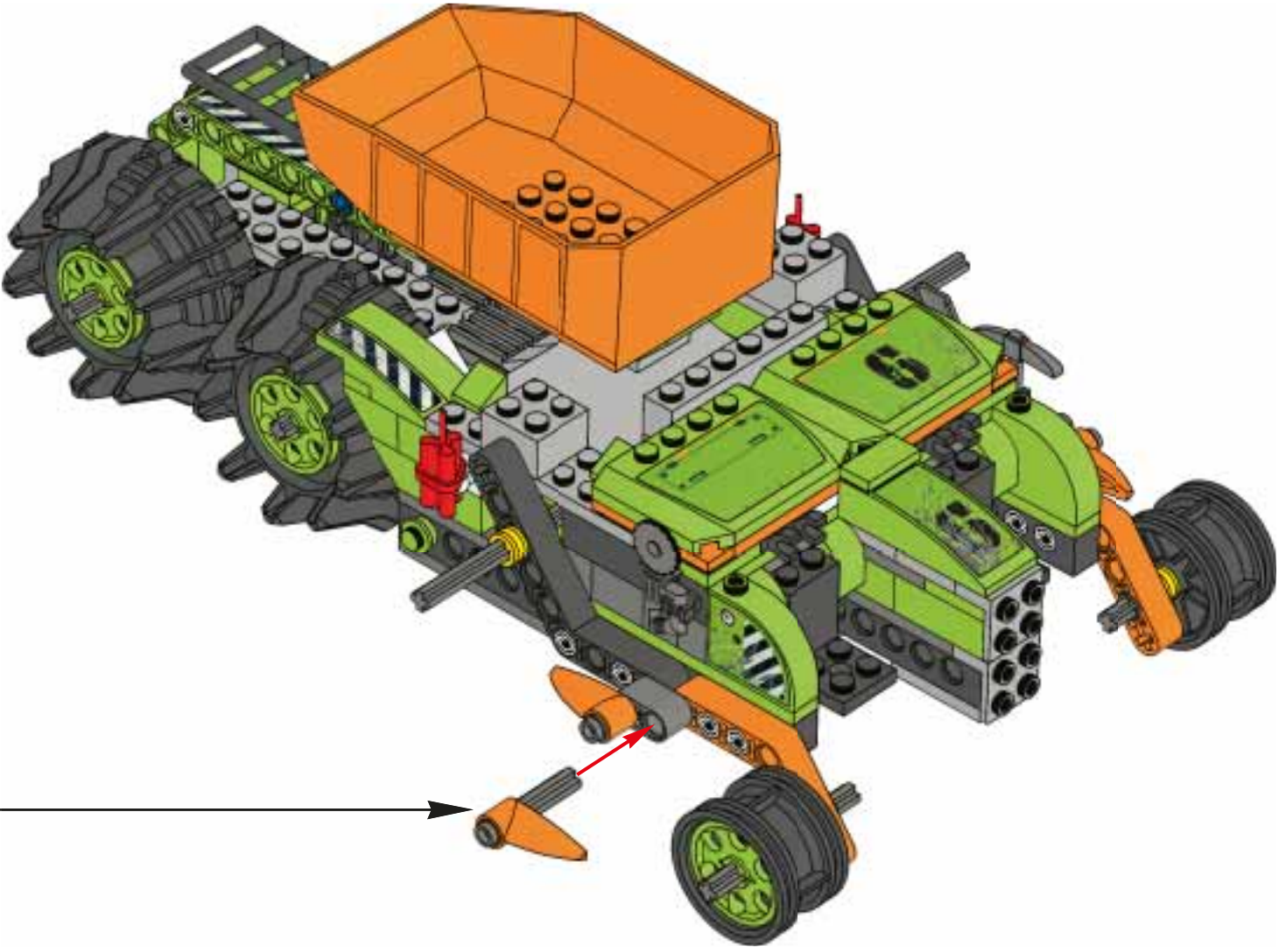
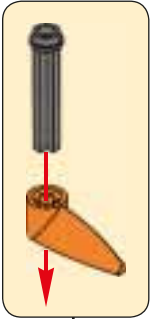

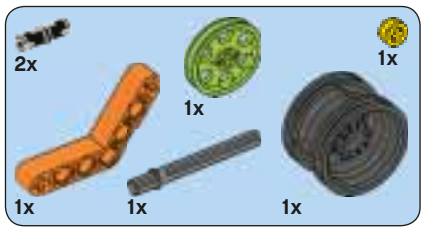

60

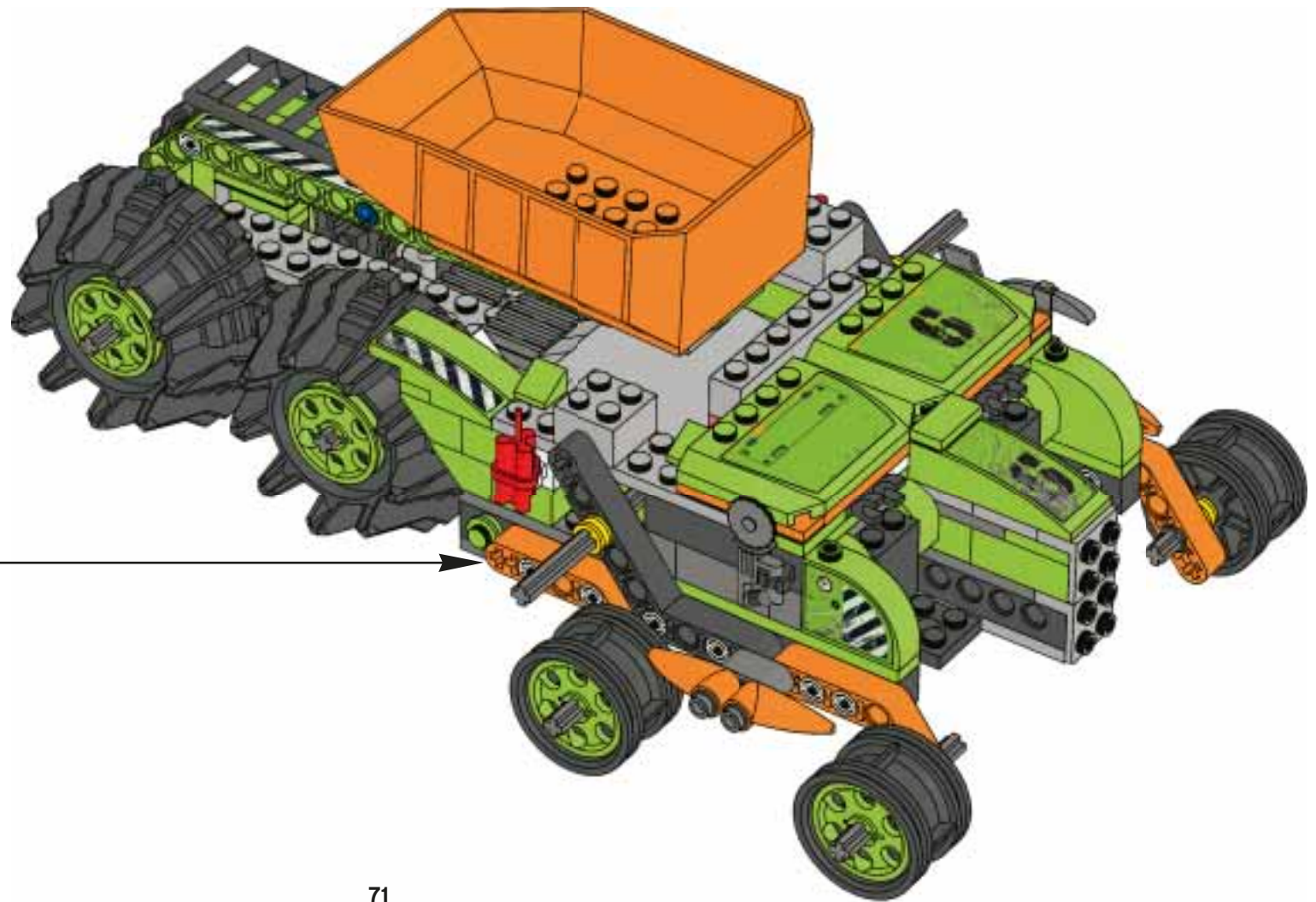
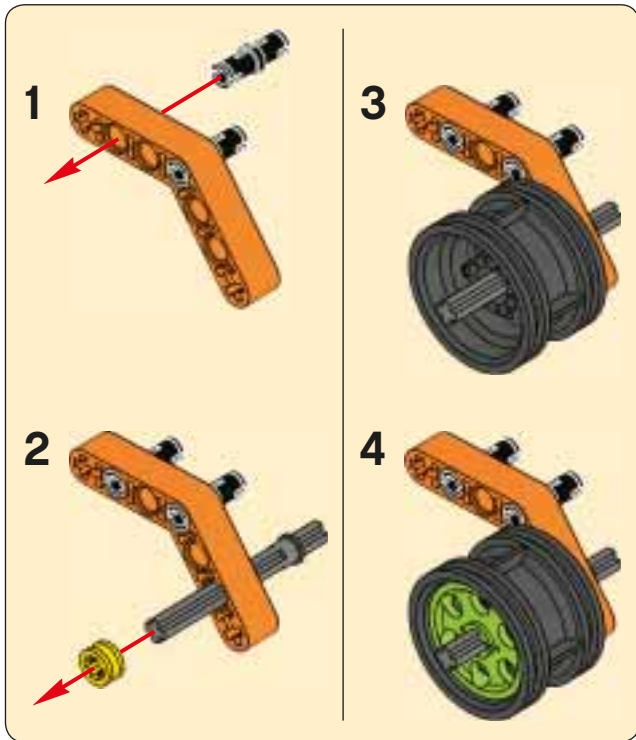



61

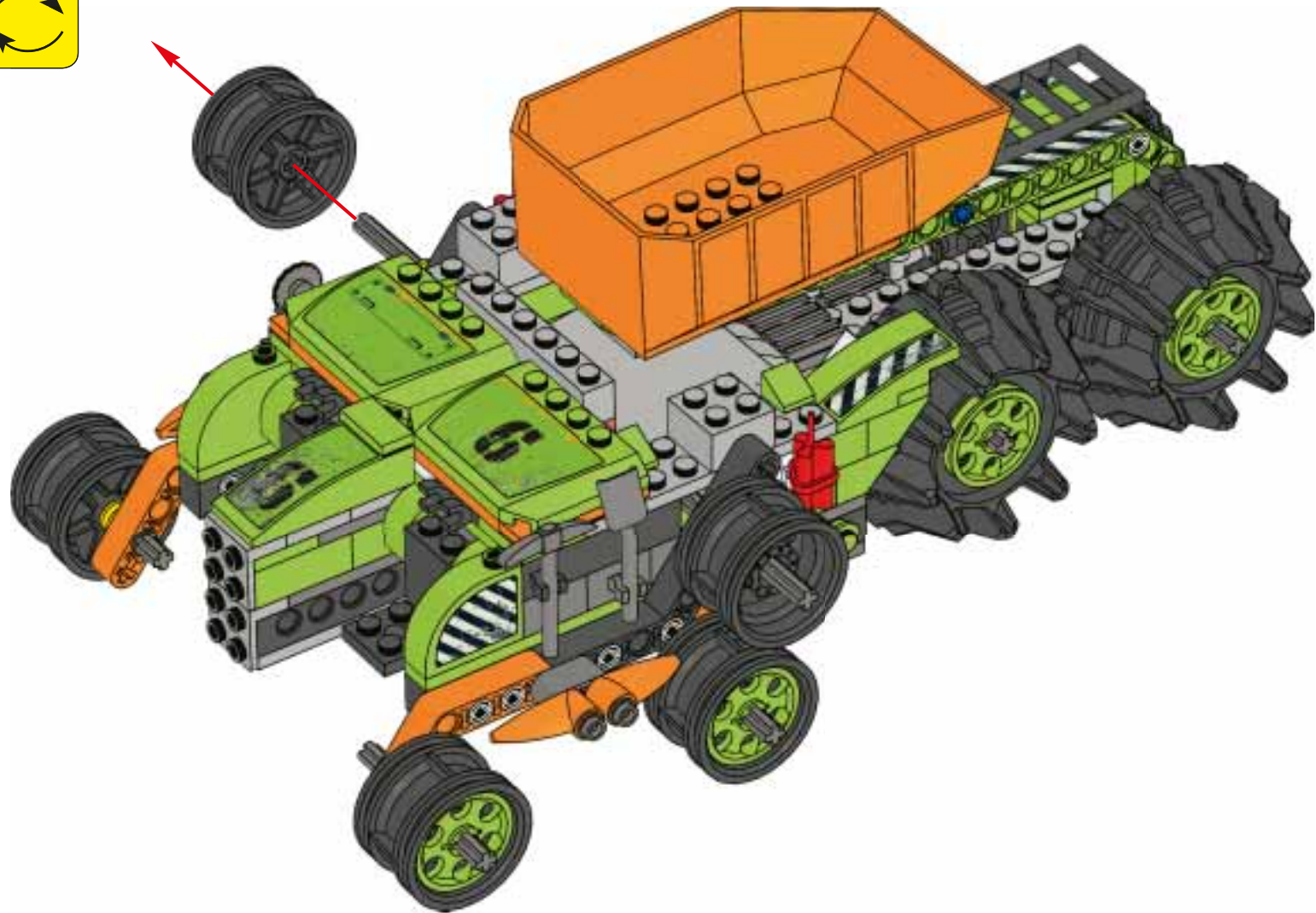





62

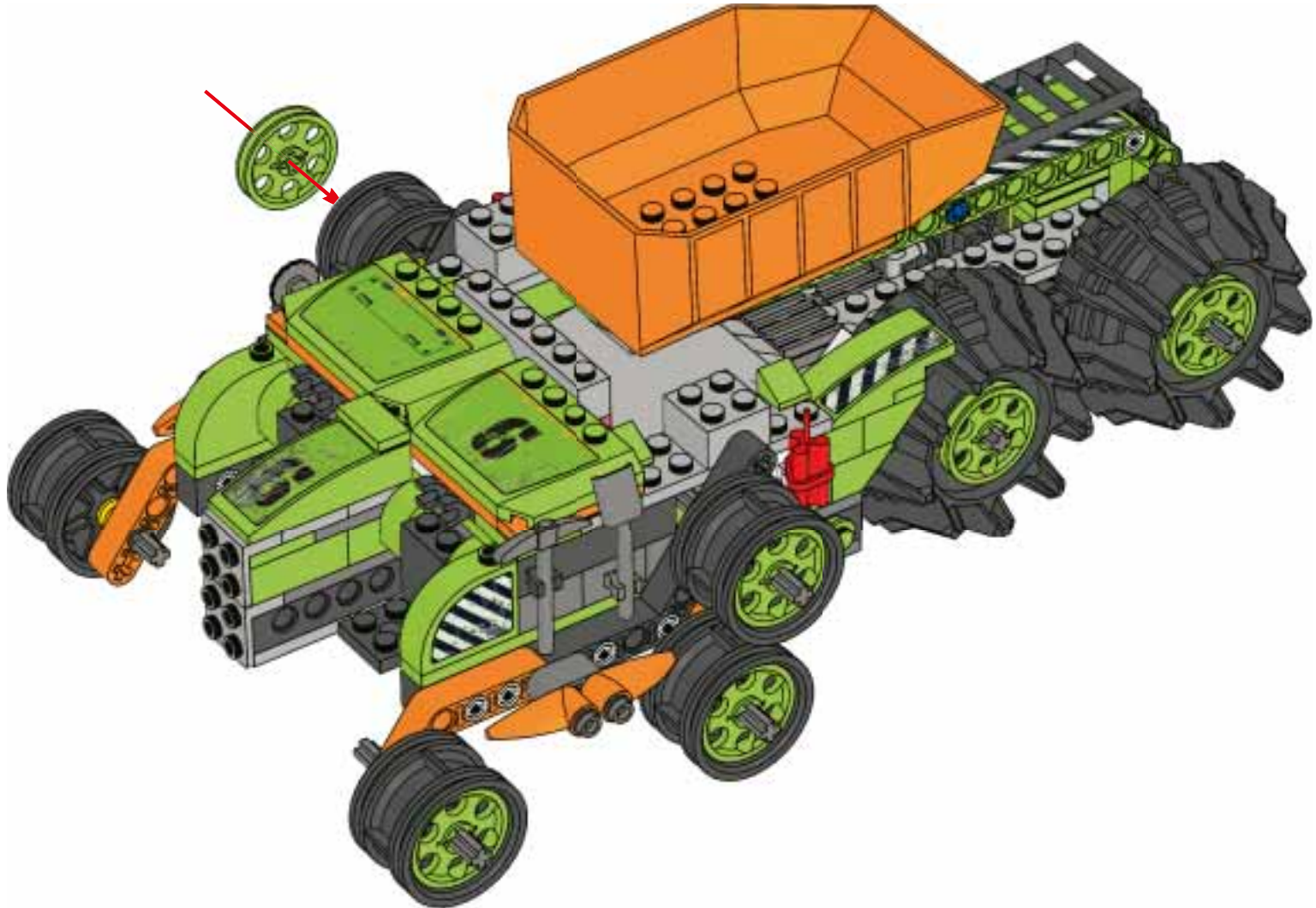

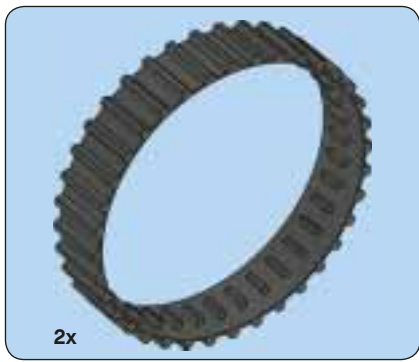

63

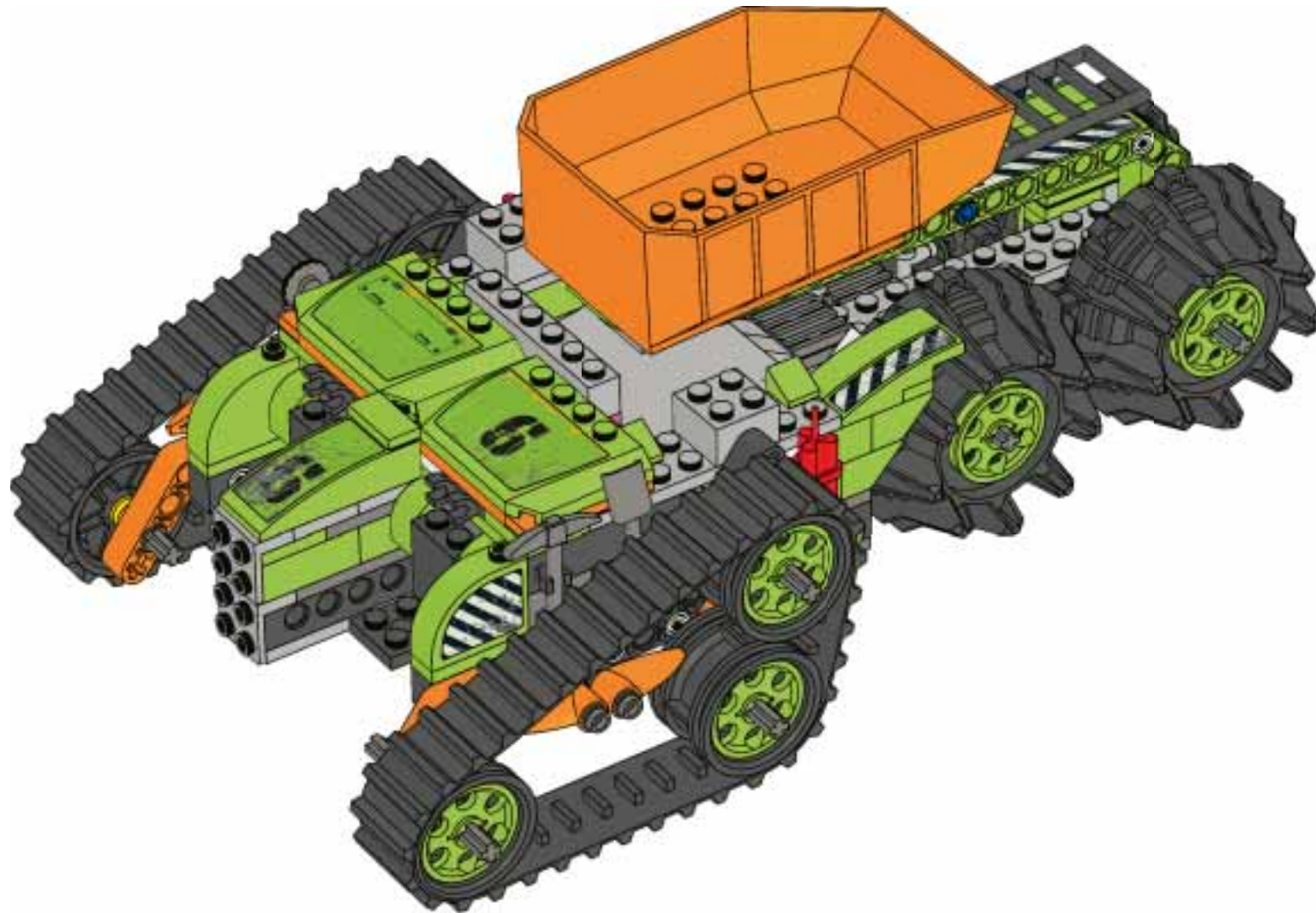

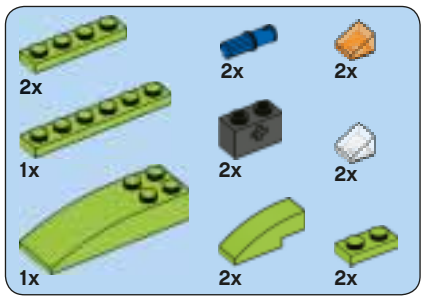

# 64

1



2



3

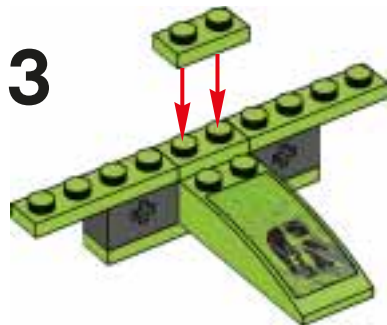

4

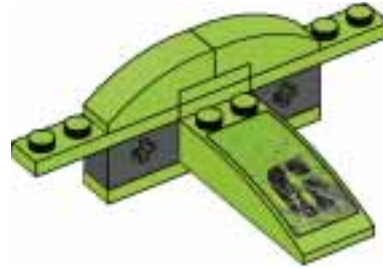

5

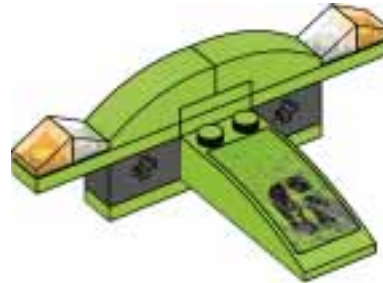

6

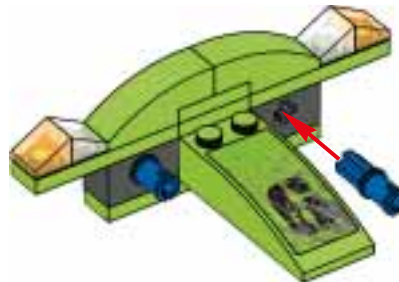

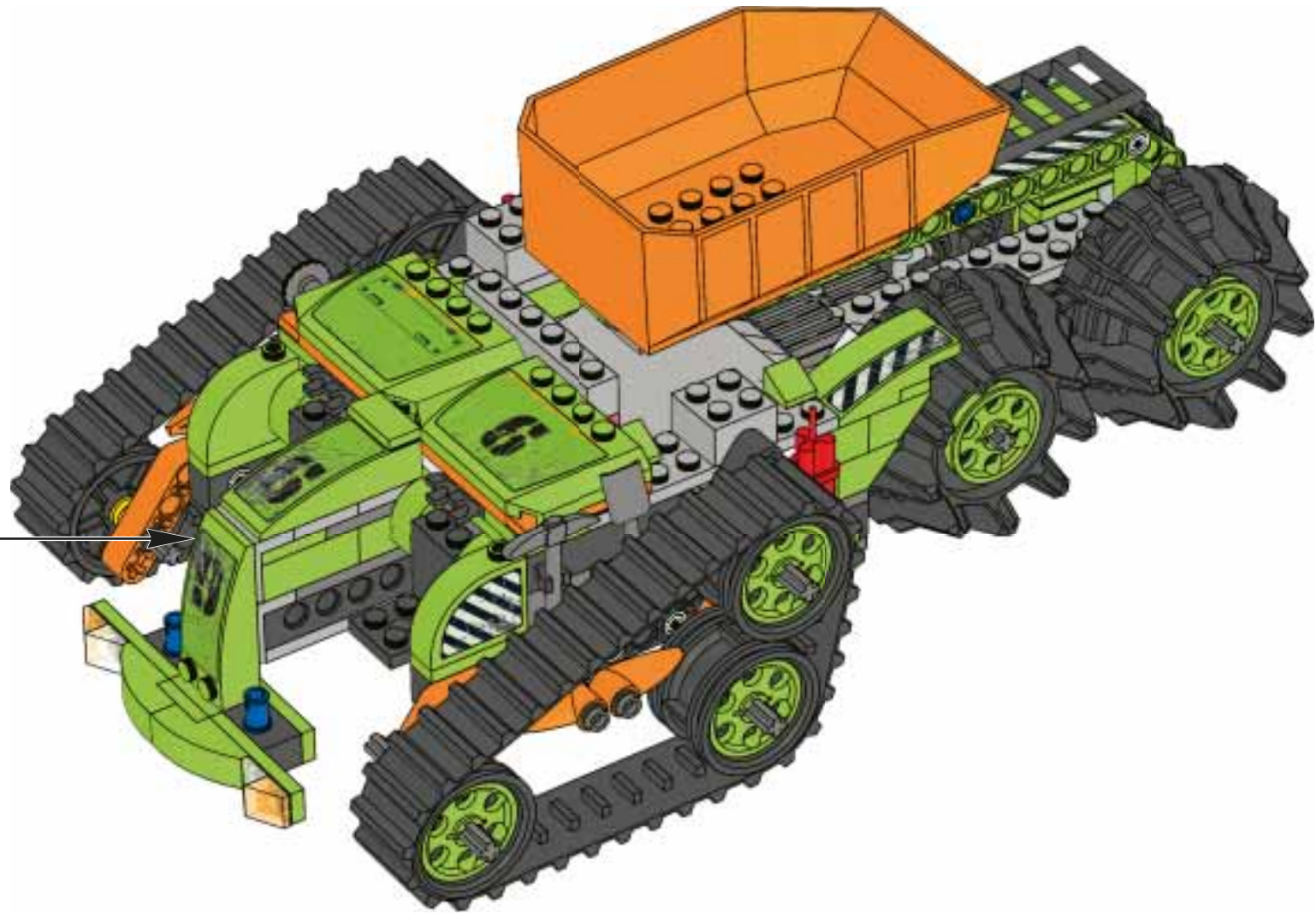

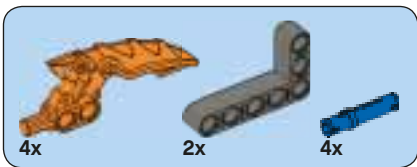

# 65

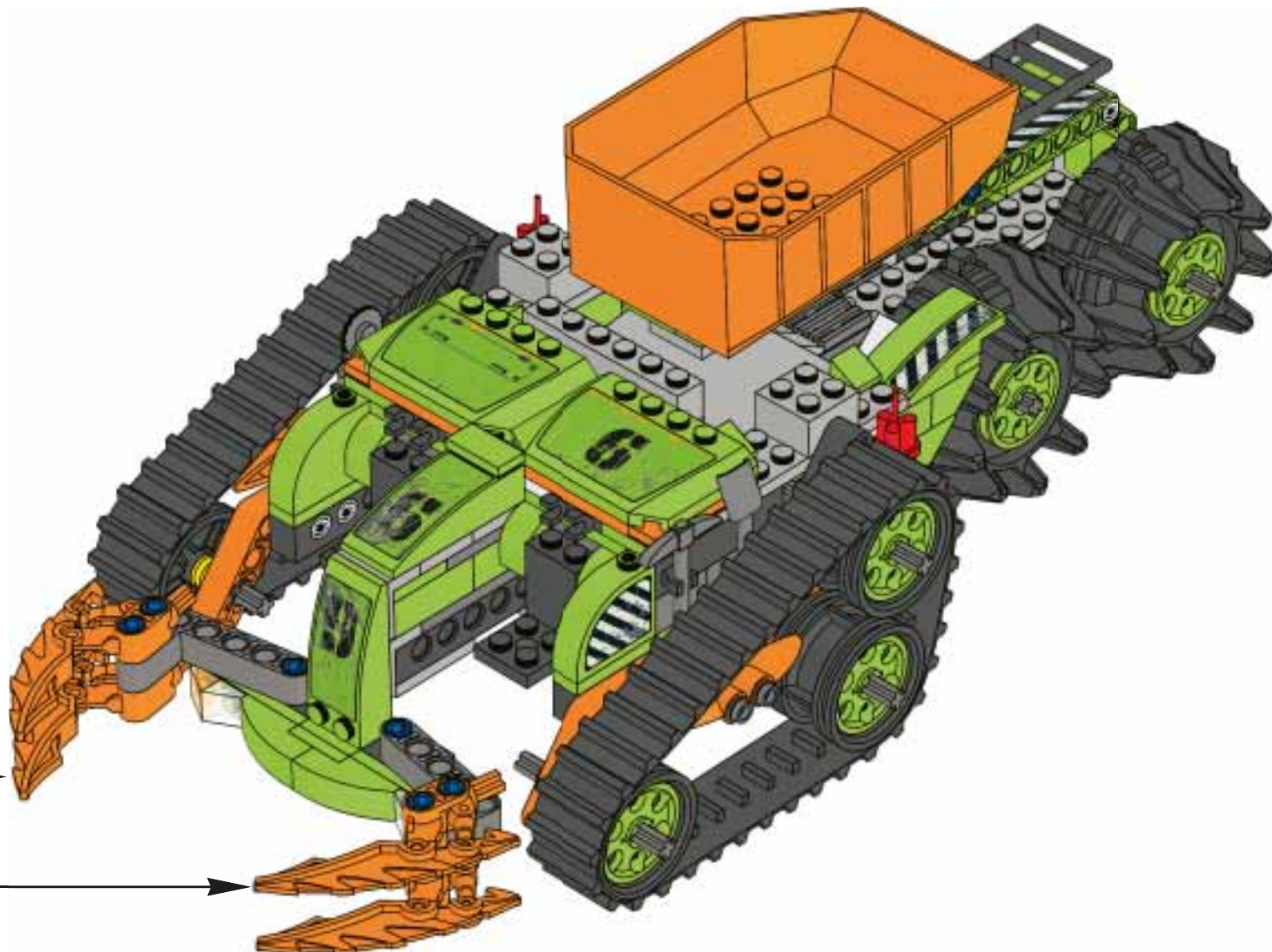
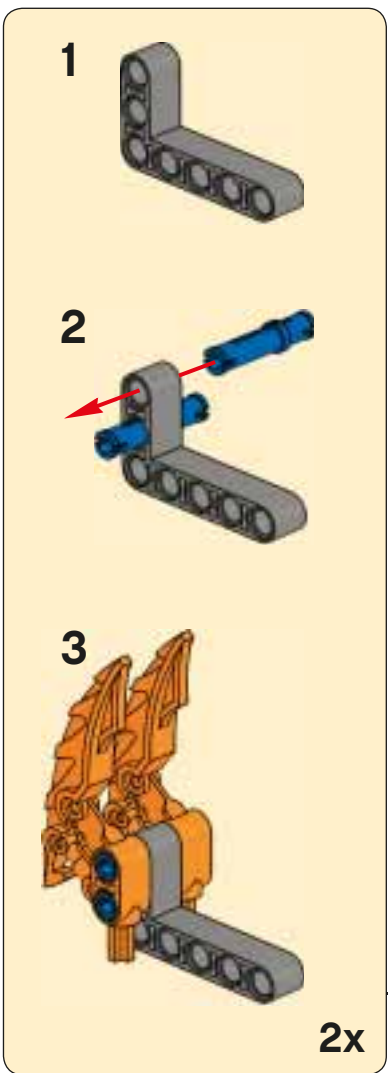

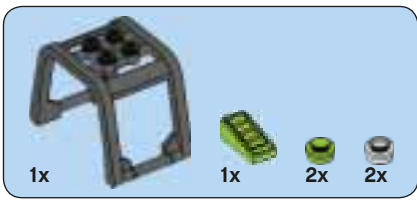

# 66

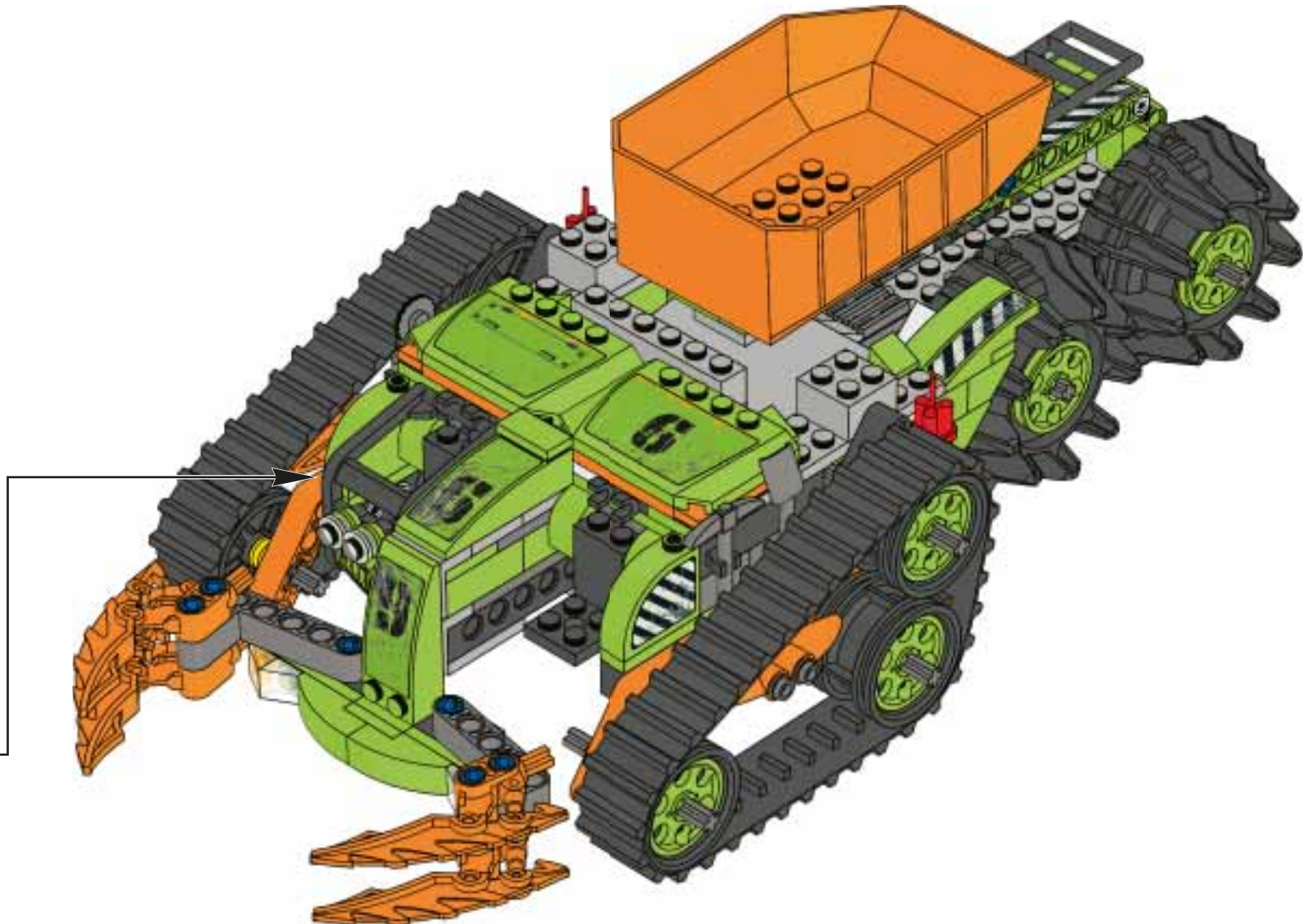



67

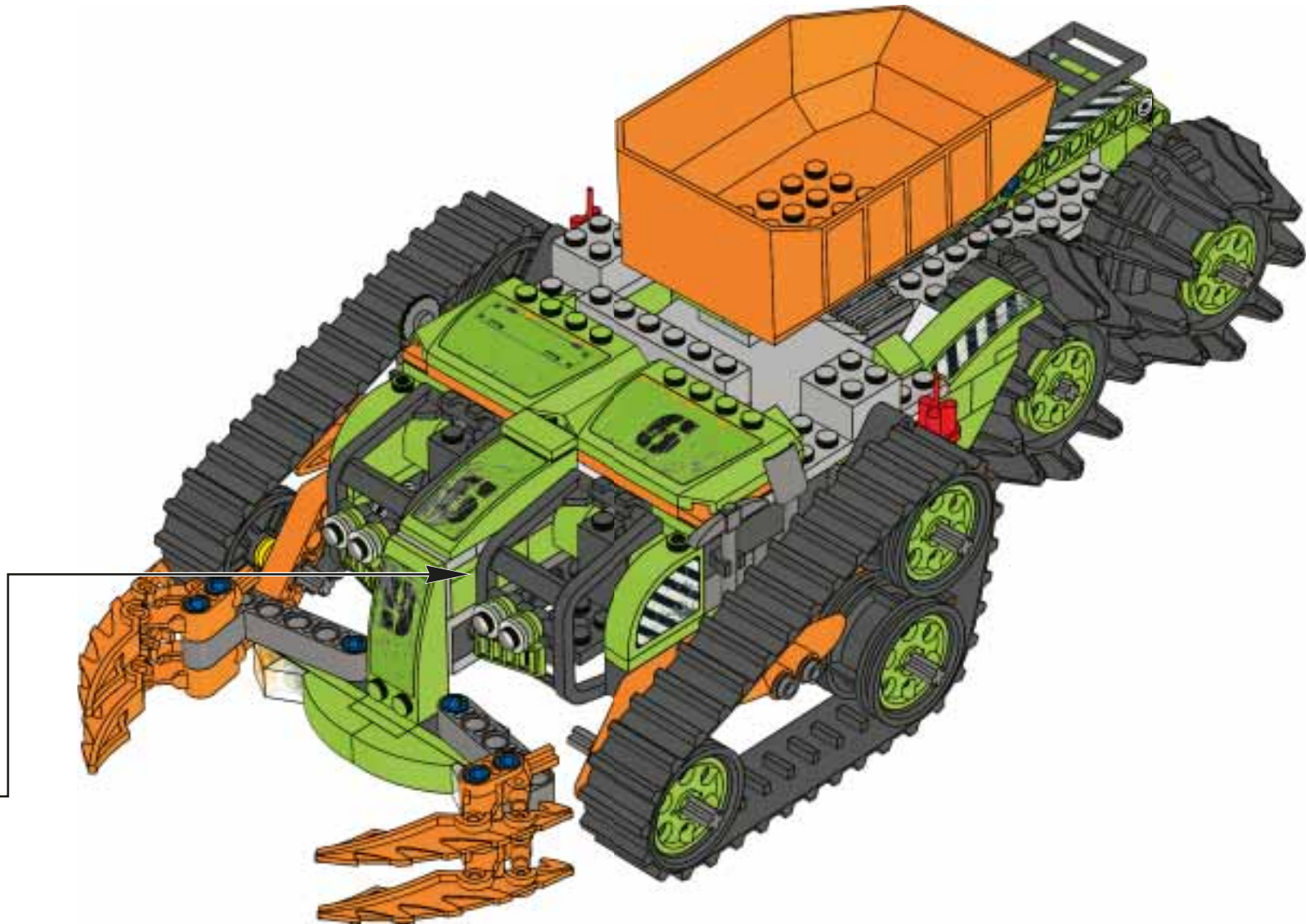
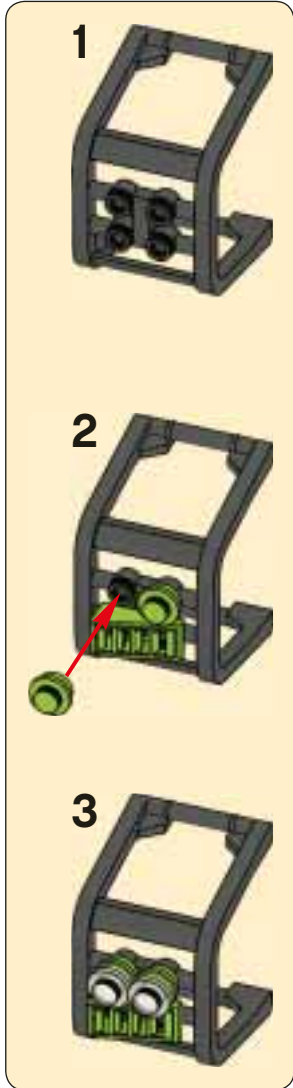

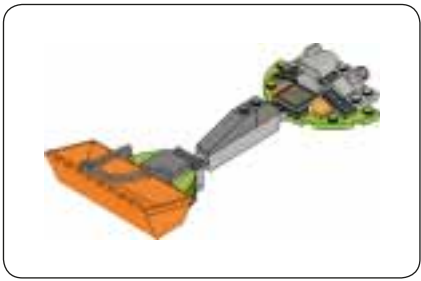

1

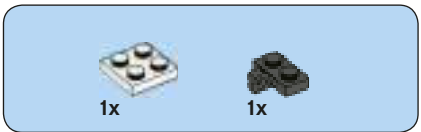
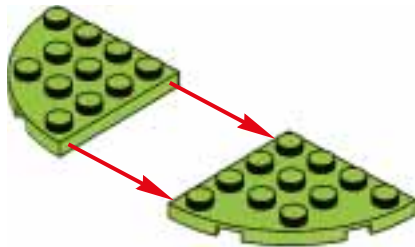

2







3



4



5



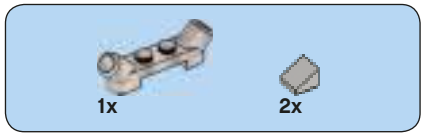

6

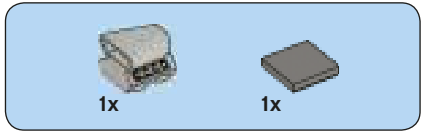

7



8

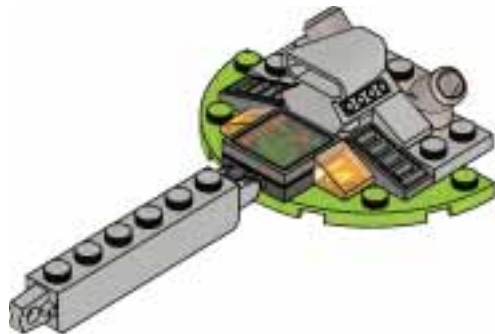

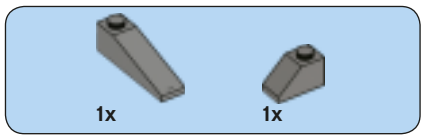

9

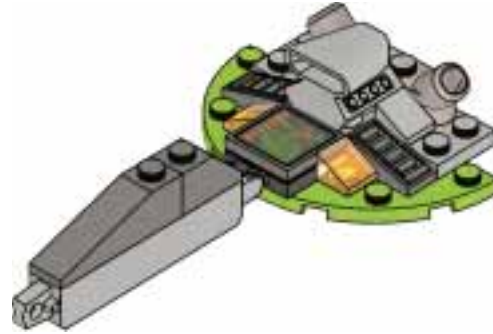

10

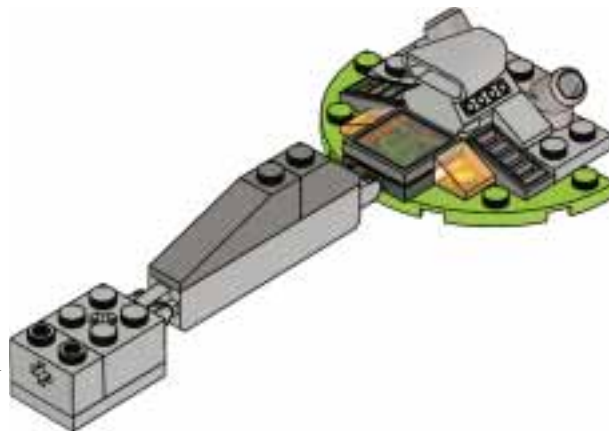
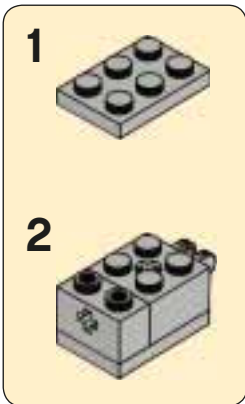

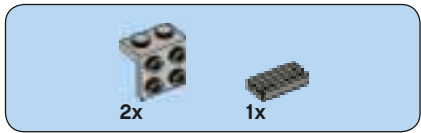

11

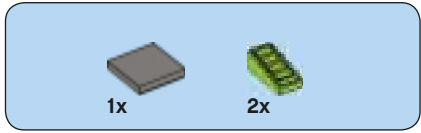
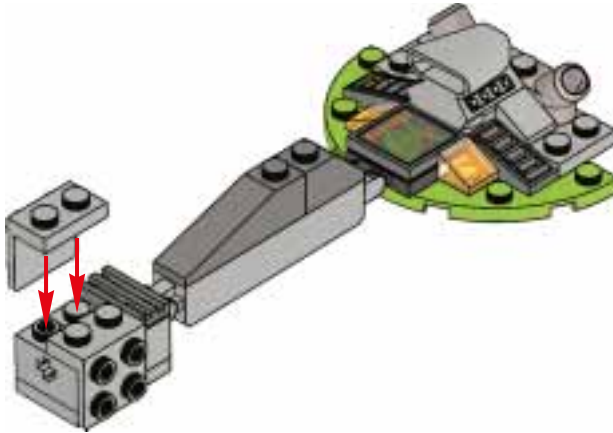

12

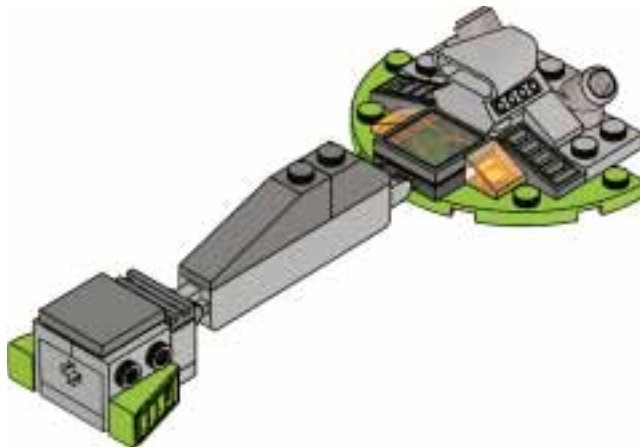

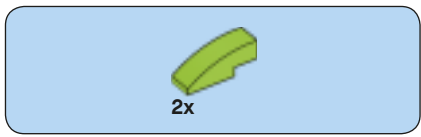

13

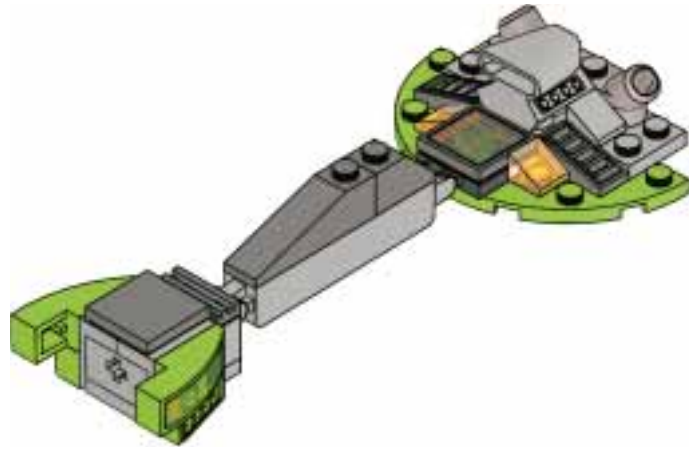

14

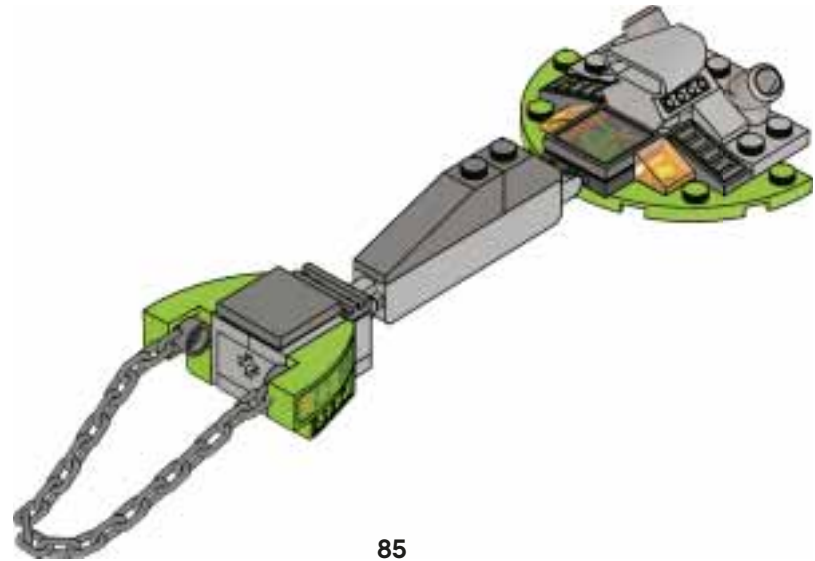

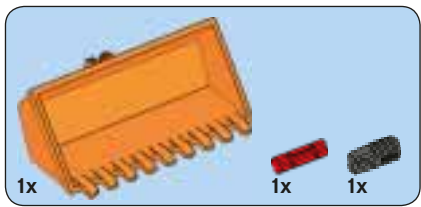

15

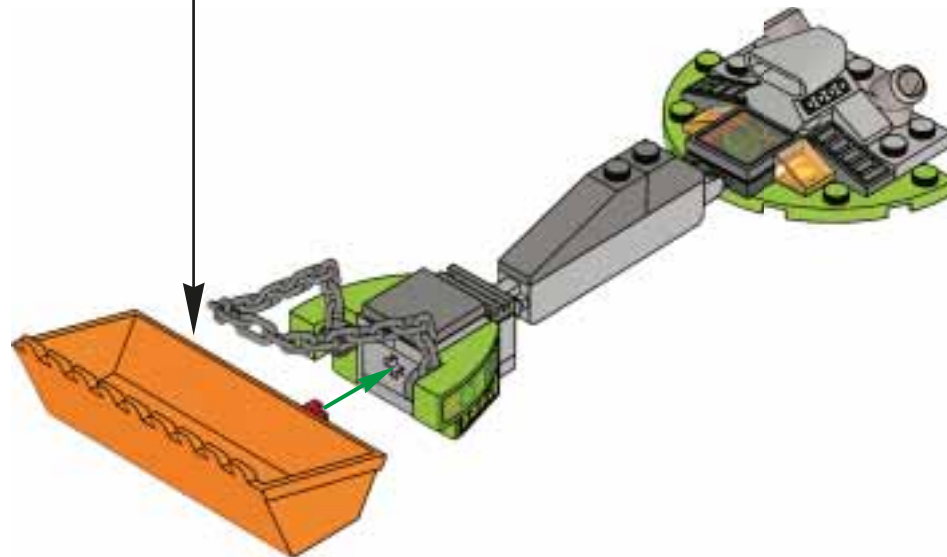
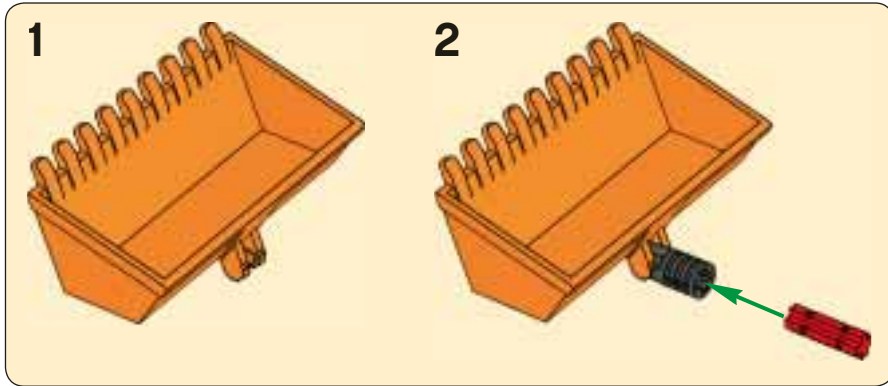

68

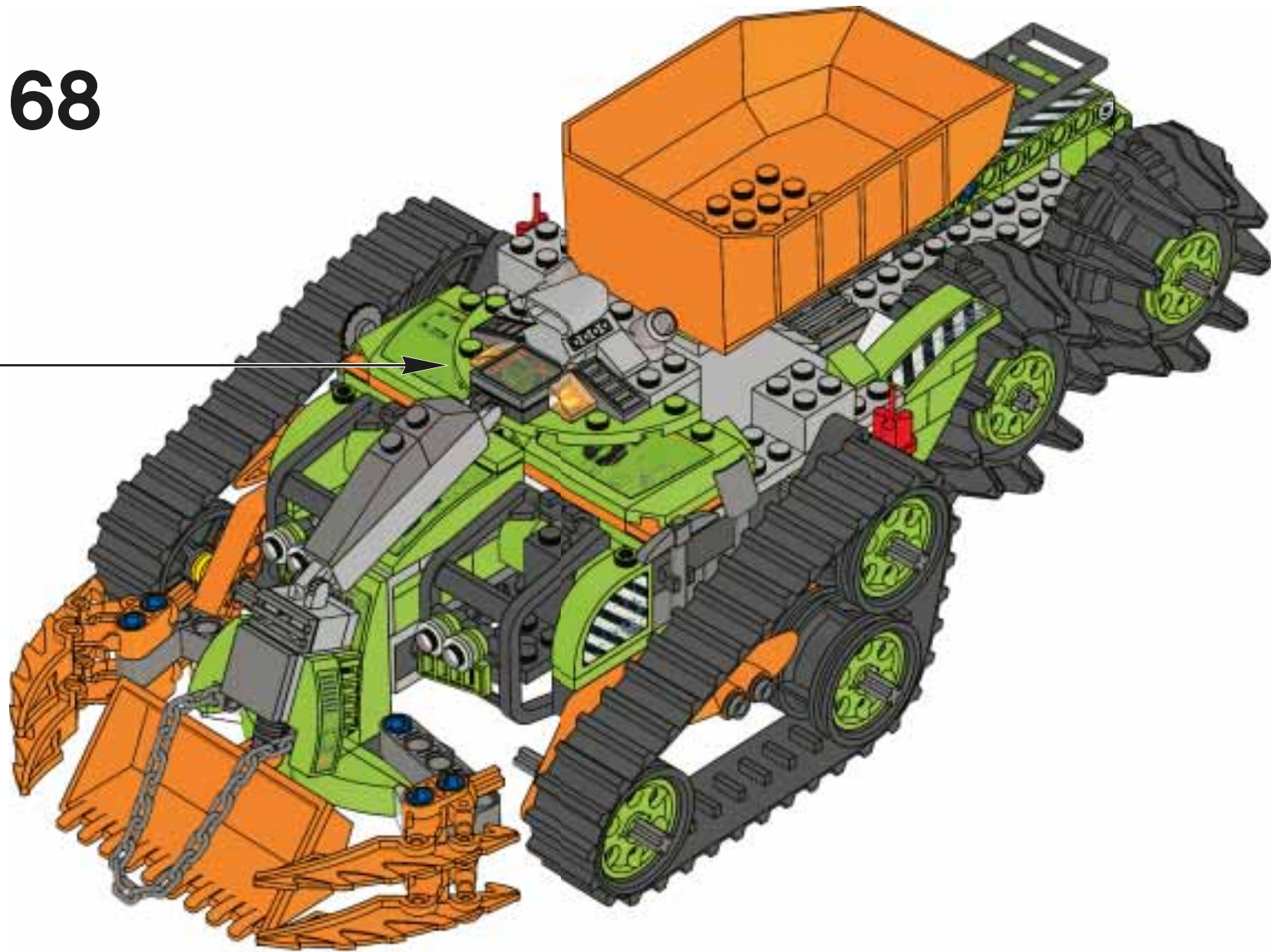

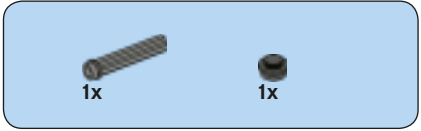

1



2

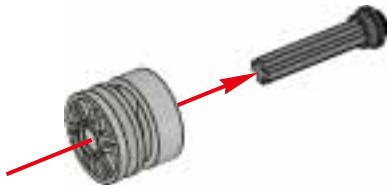



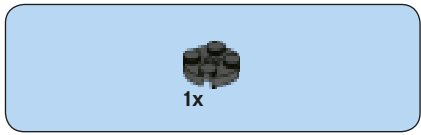

3

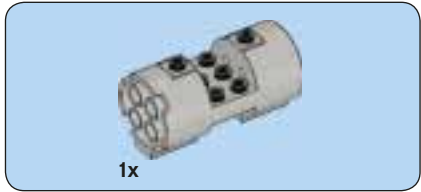

4

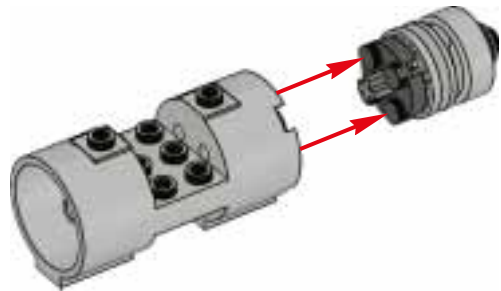

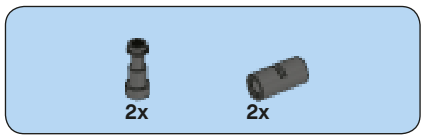

5

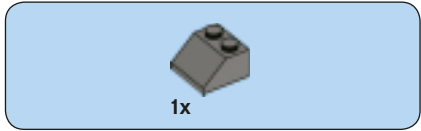
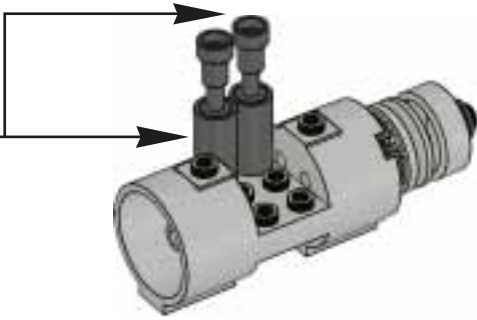
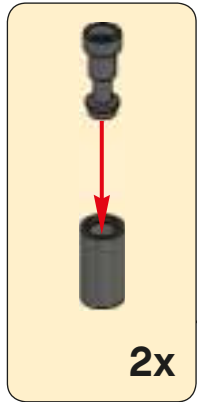

6



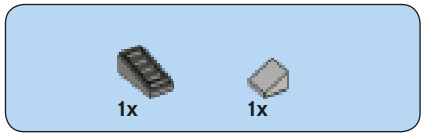

7

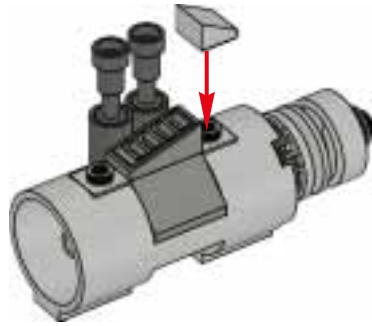

8

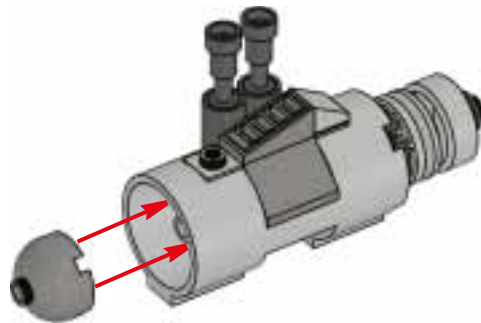

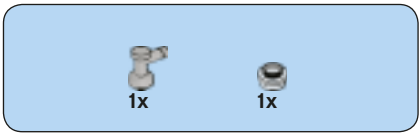

9



69

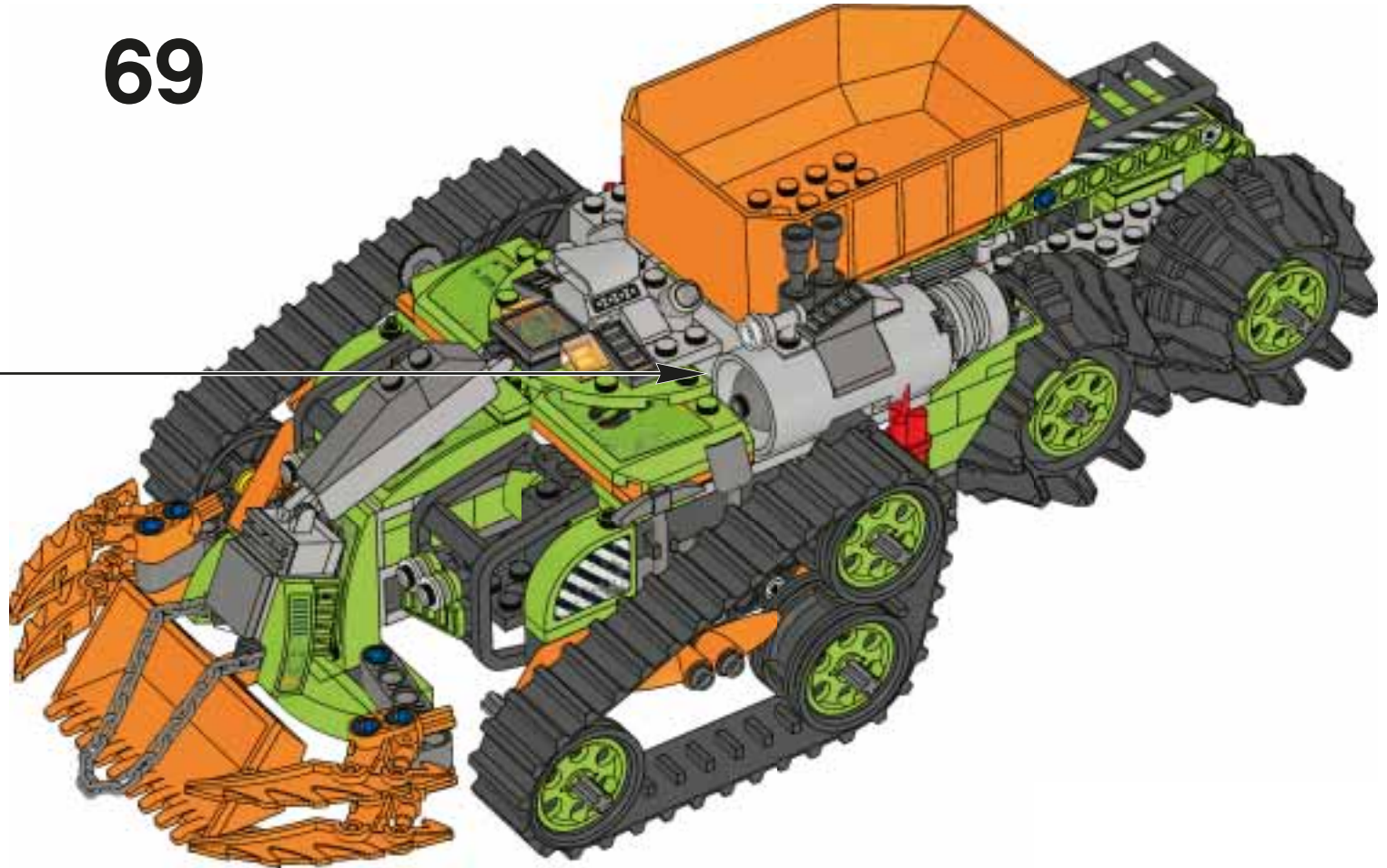

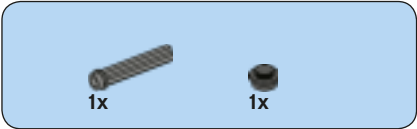

1



2



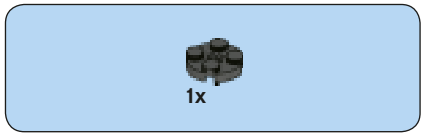

3

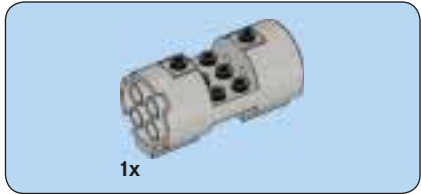

4

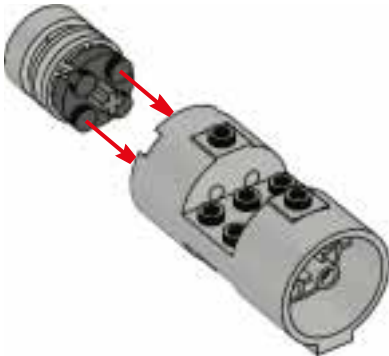

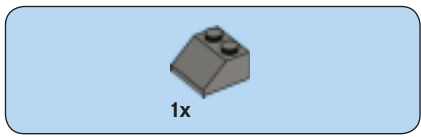

5

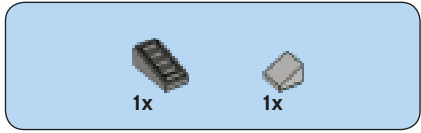

6

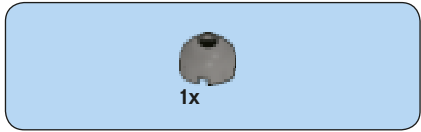
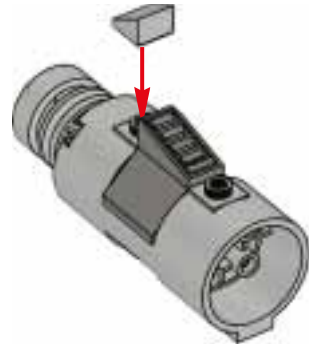

7

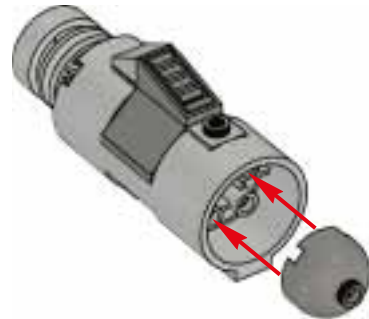

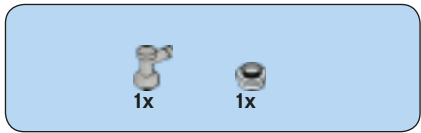

8

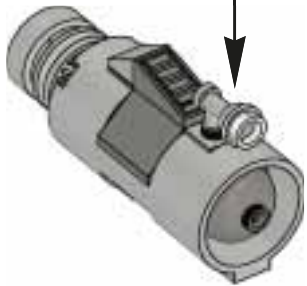
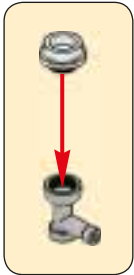

70

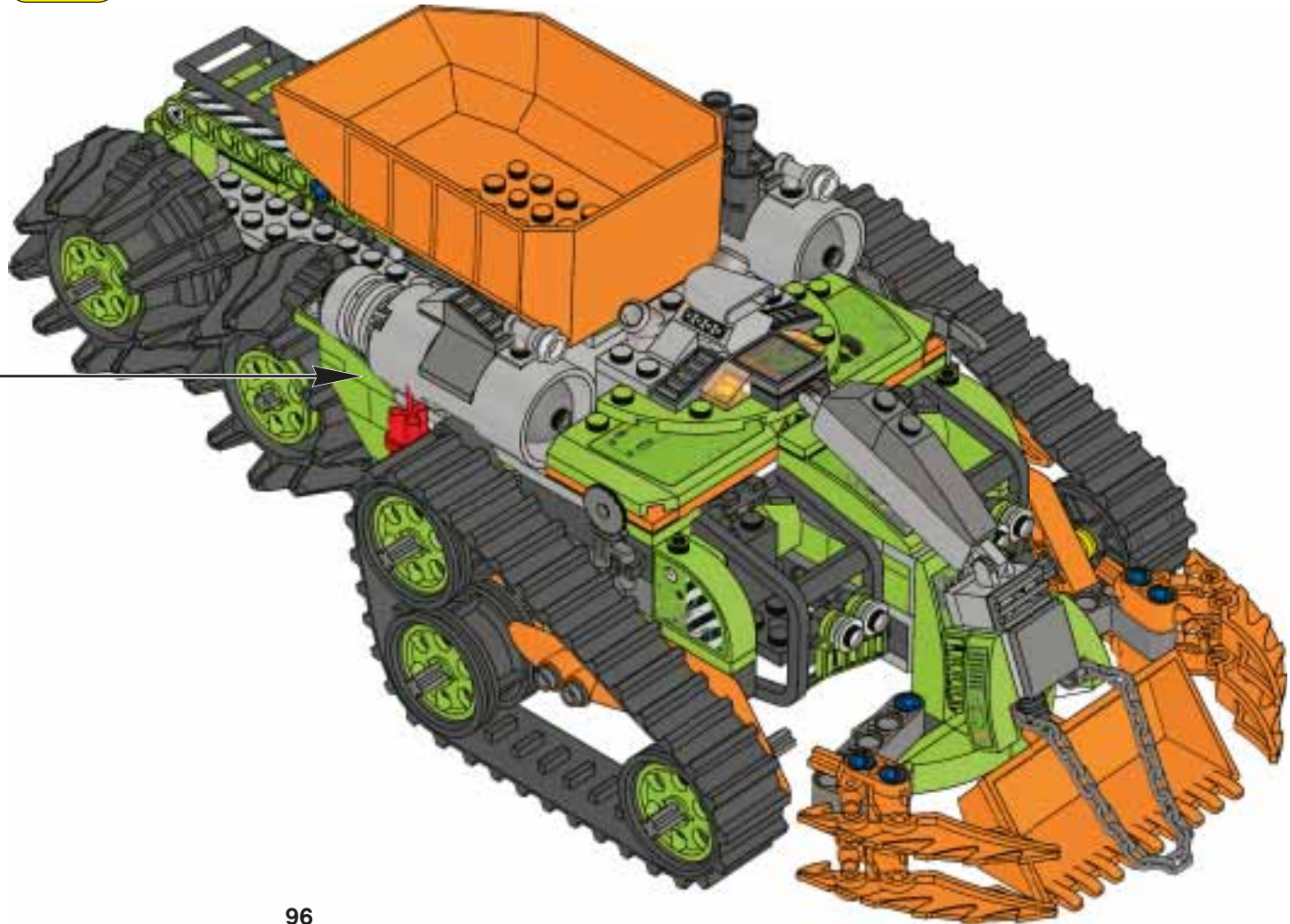



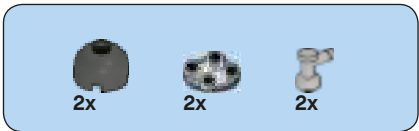

# 71

