

LEGO



8639



 **WARNING:** CHOKING HAZARD.
Toy contains small parts and a small ball.
Not for children under 3 years.



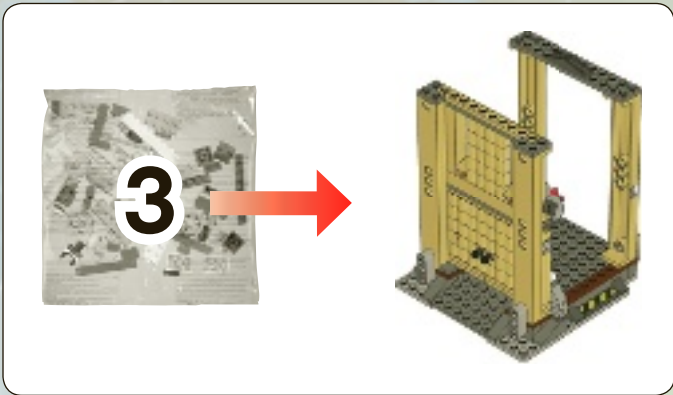
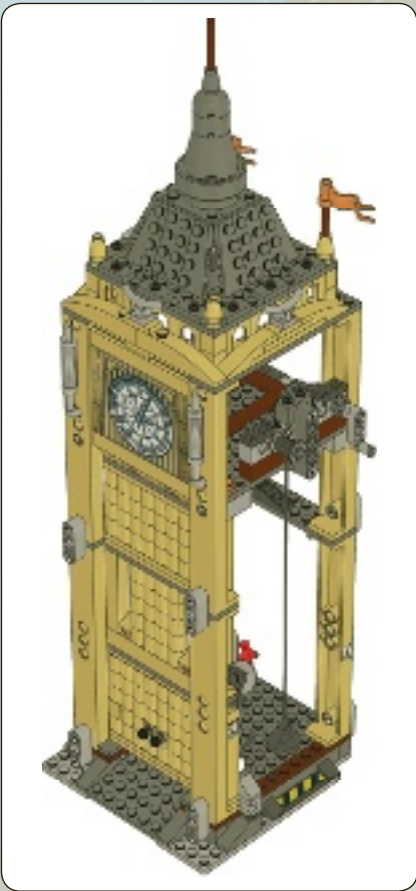

⚠️ **AVERTISSEMENT : RISQUE D'ÉTOUFFEMENT.**
Le jouet contient des petites pièces ainsi qu'une petite boule.
Il ne convient pas aux enfants de moins de 3 ans.

⚠️ **ADVERTENCIA: PELIGRO DE ASFIXIA.**
Juguete que contiene partes pequeñas y una pelota pequeña.
No recomendado para niños menores de 3 años.

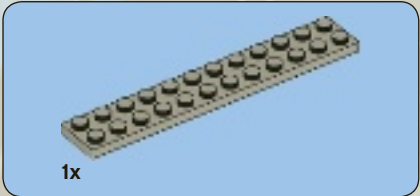

1



2

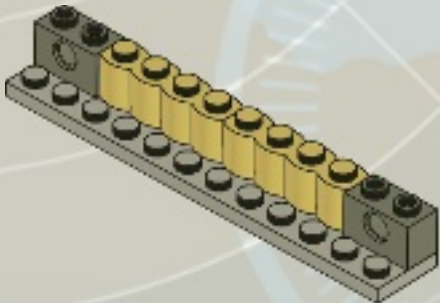

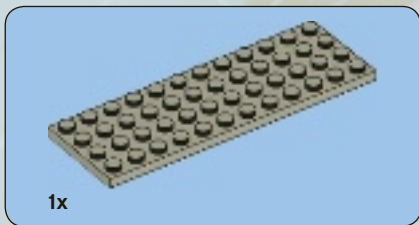

3

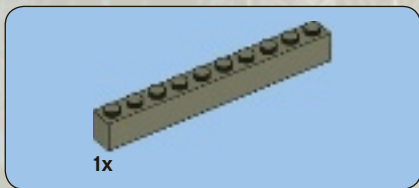
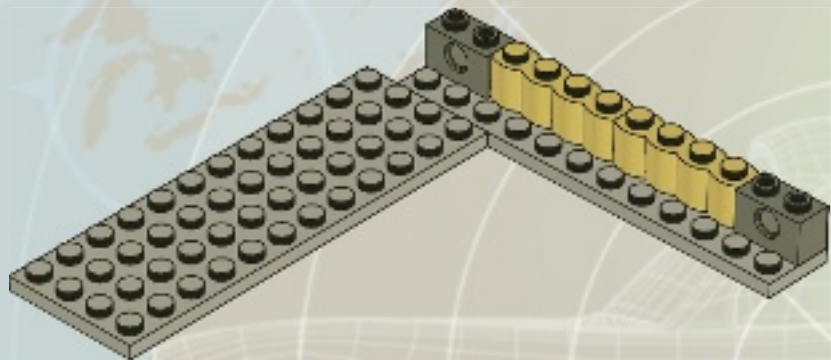

4

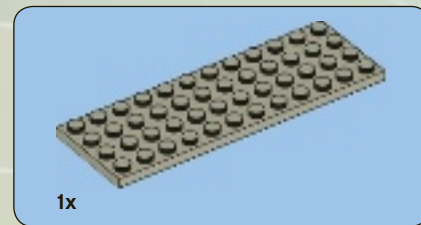
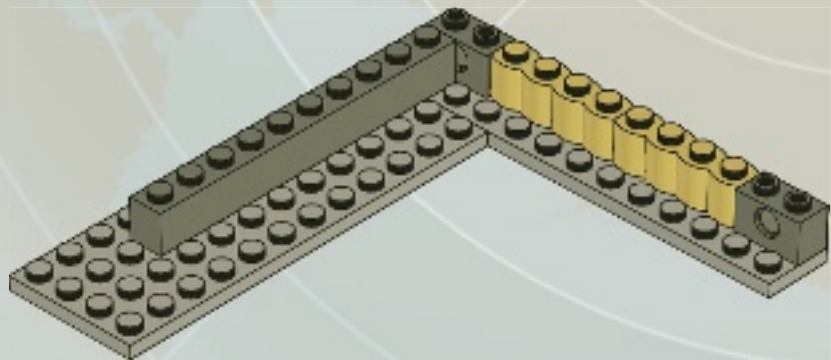

5

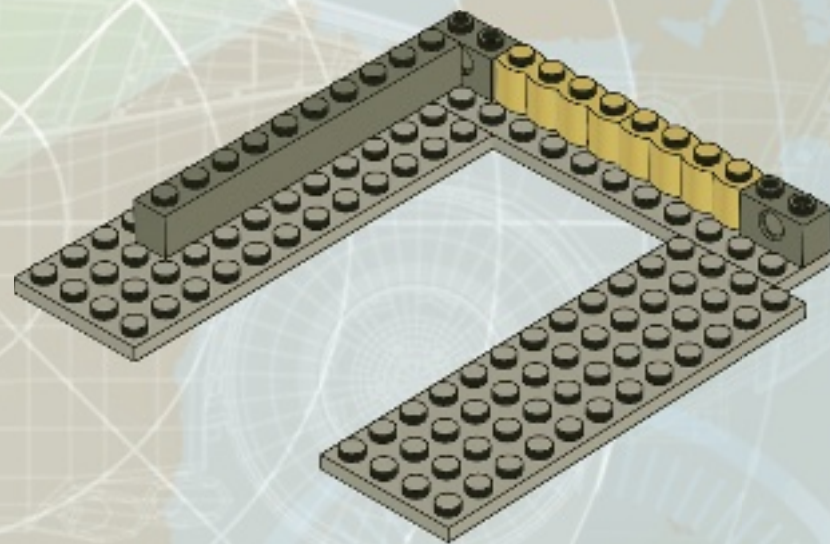

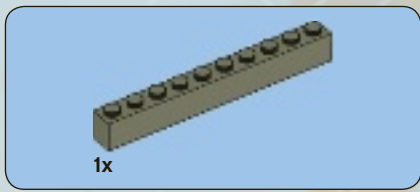

6

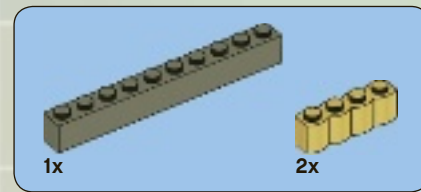
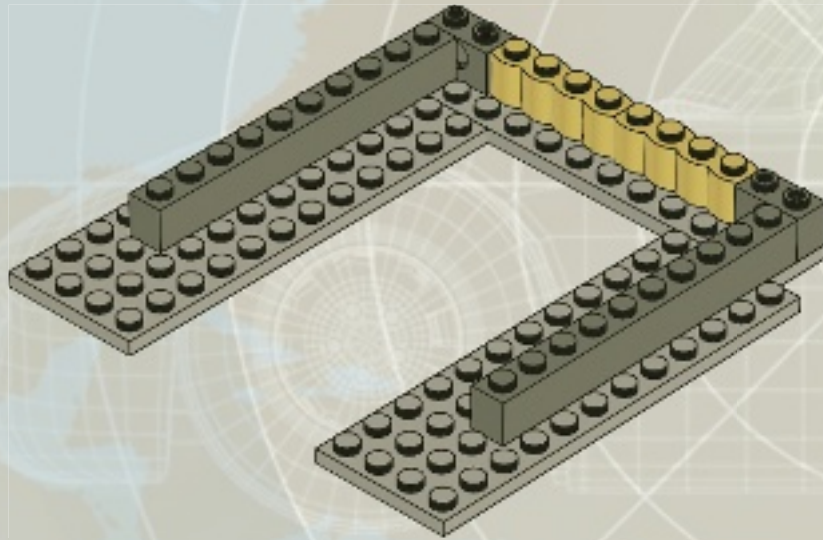

7

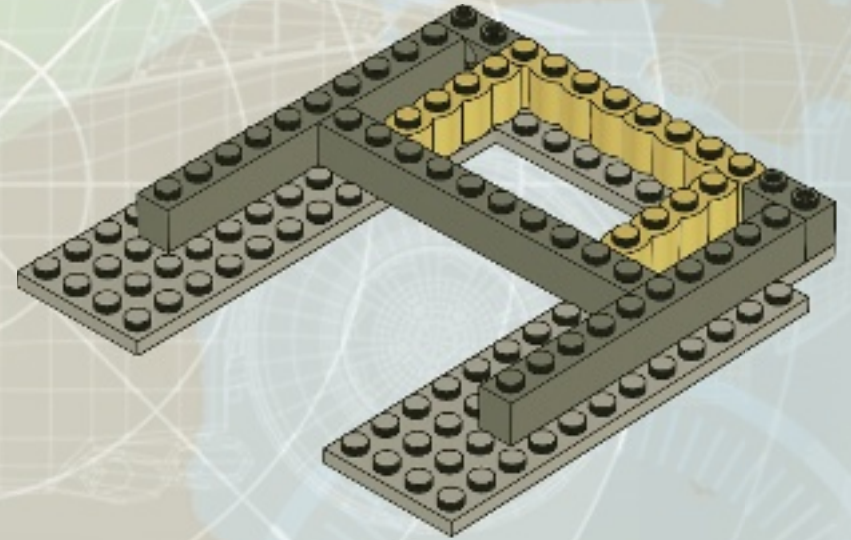



2x

8

Waypoint 1

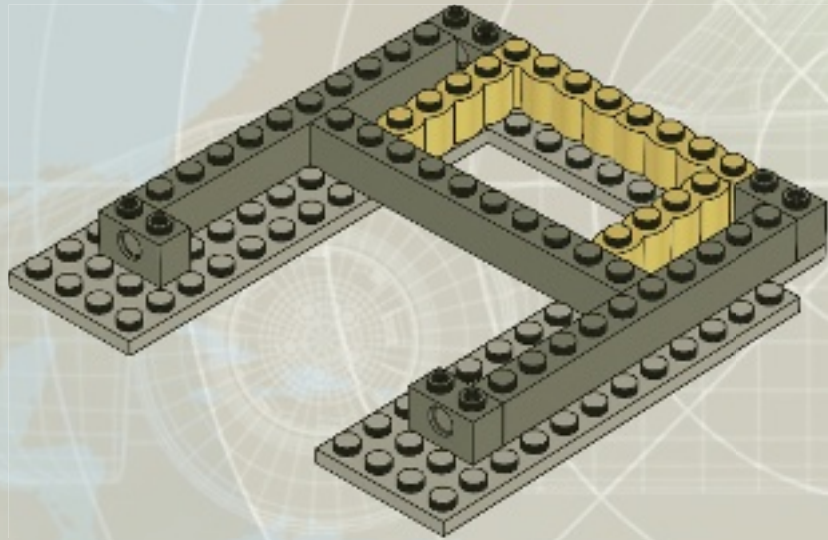

4x

9

target acquired

Waypoint 2

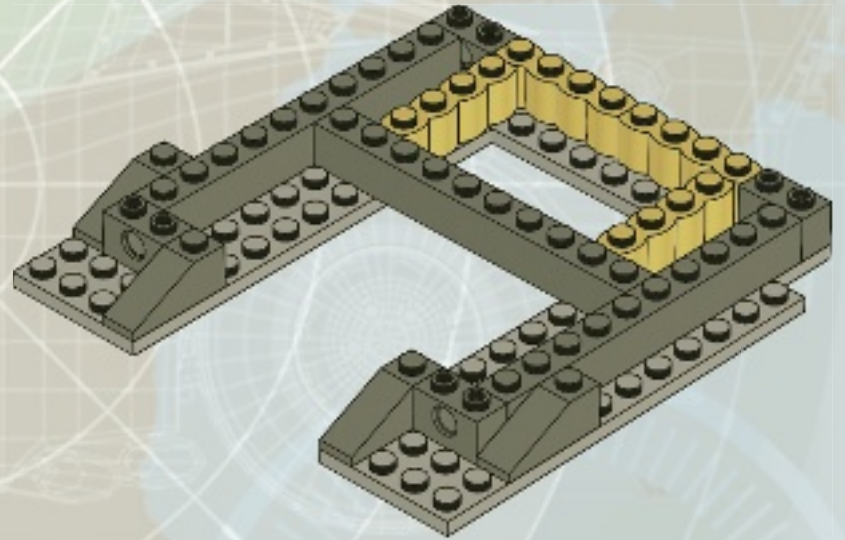

2x

2x

2x

10

1



2



2x

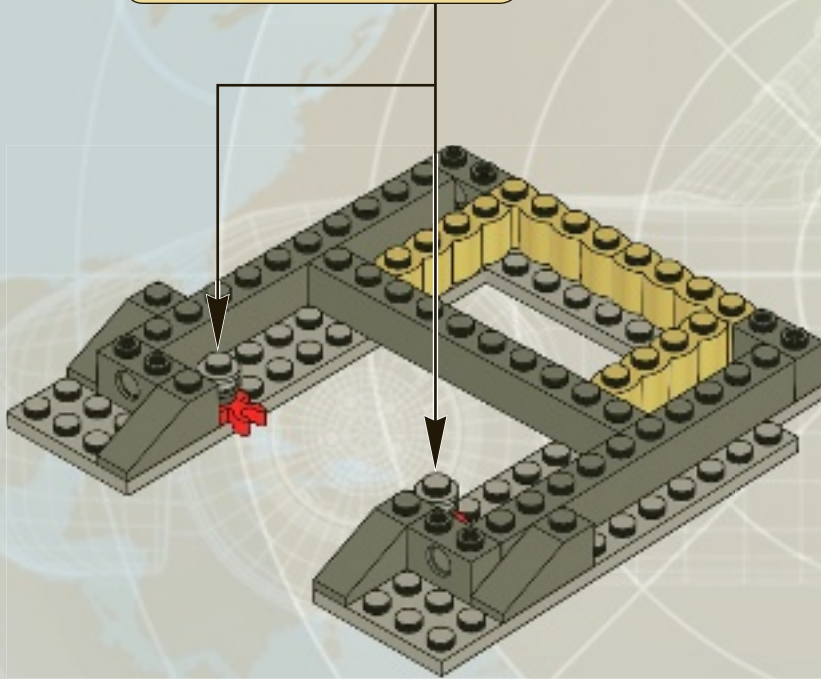

2x

11

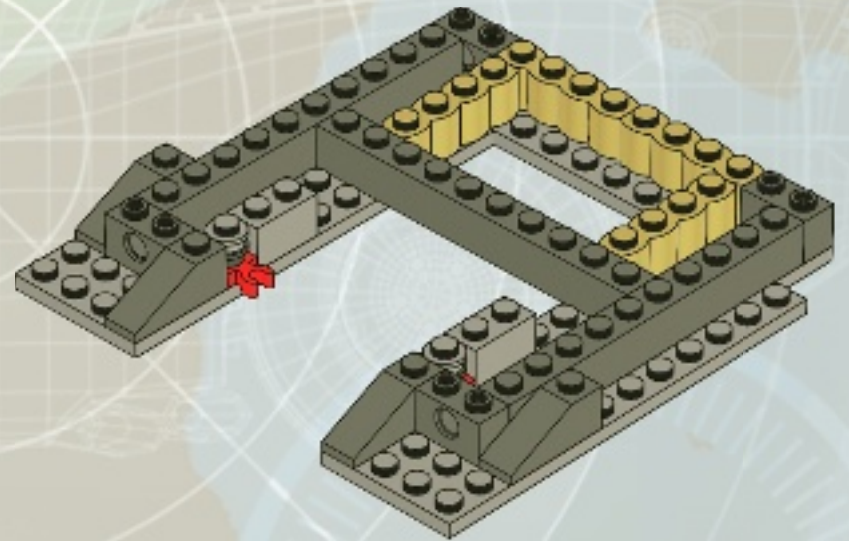

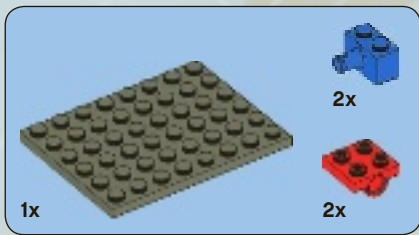

12

1



2

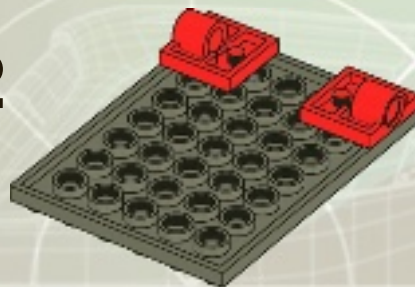

3

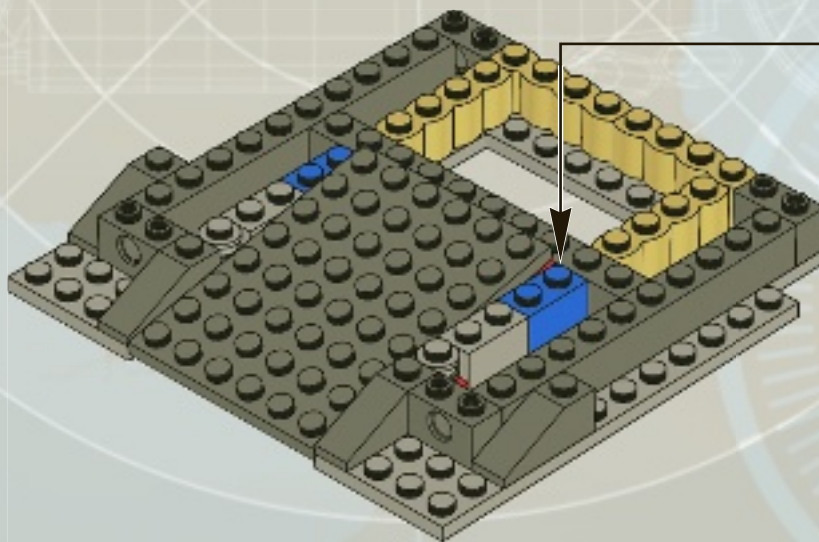
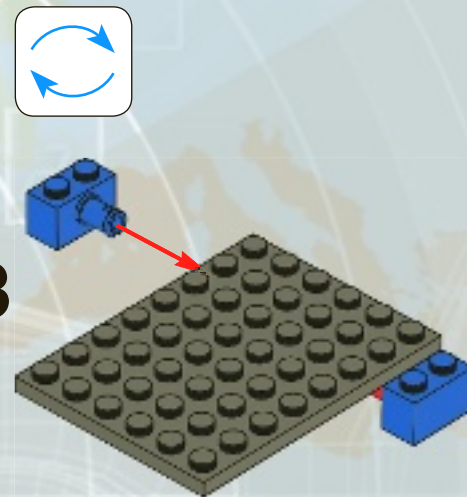



13

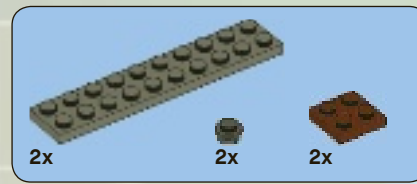
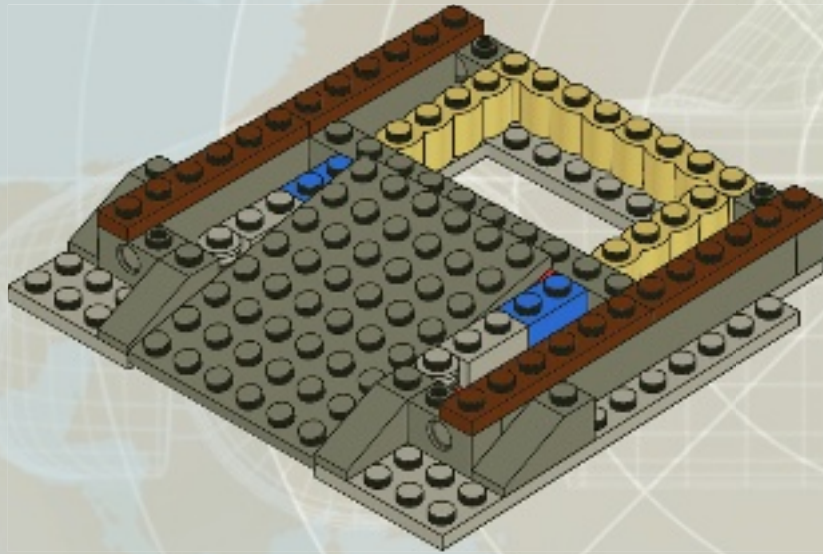

14

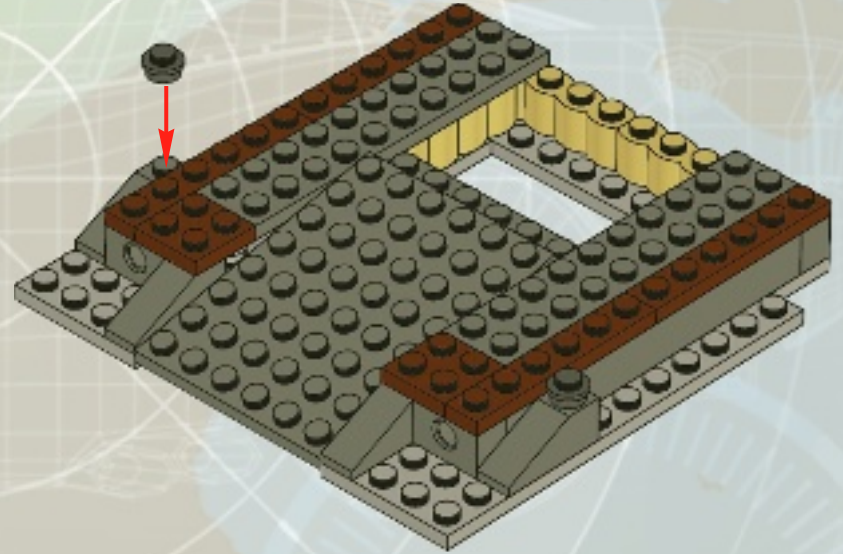



1x

15

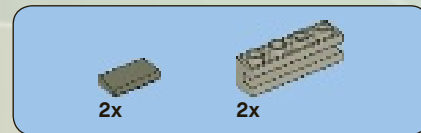

2x

2x

16





17

waypoint 1

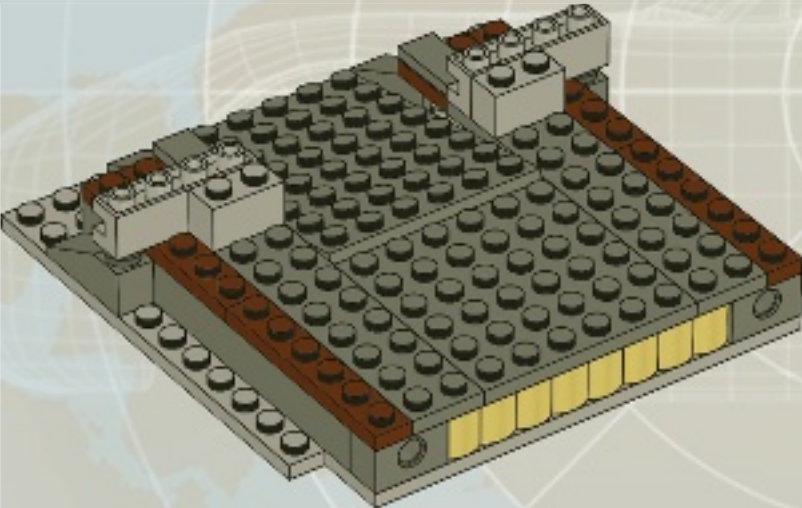

18

target acquired

waypoint 2

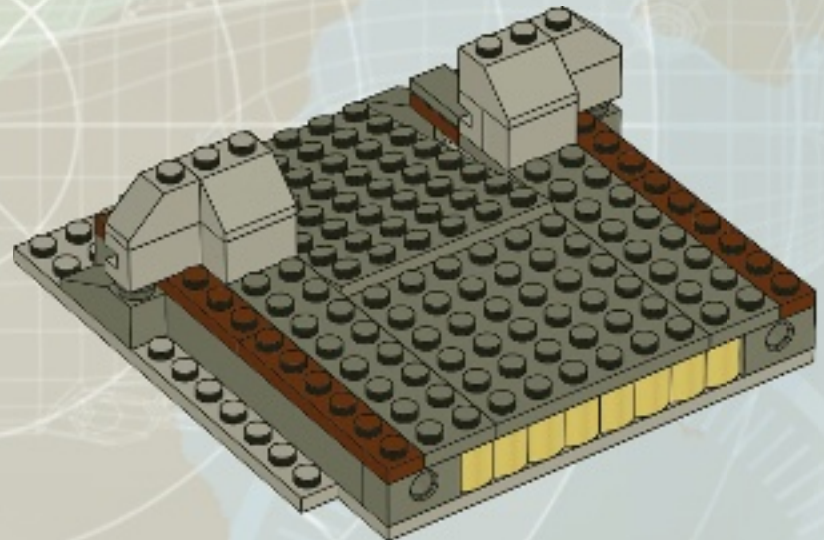

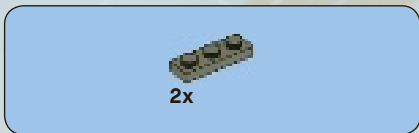

19

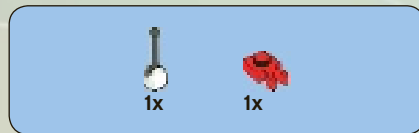
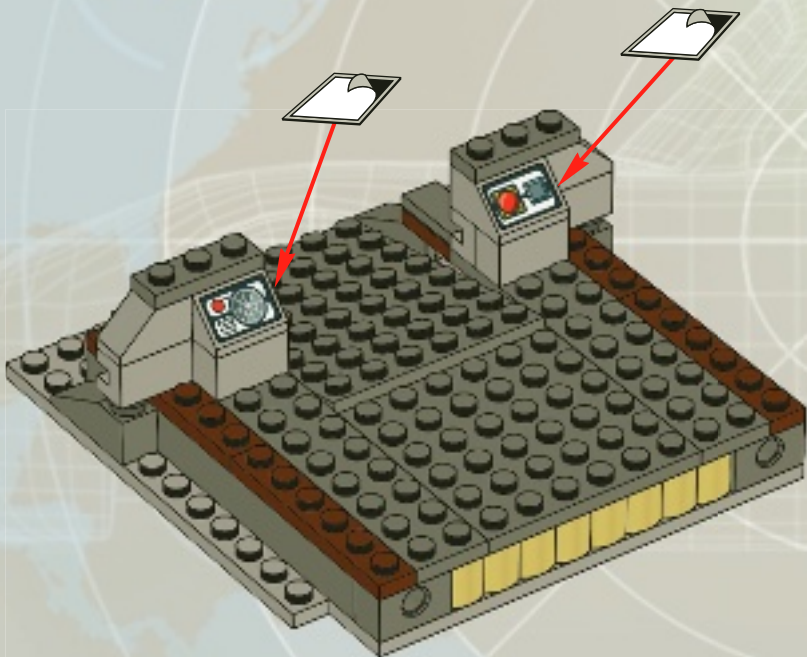

20

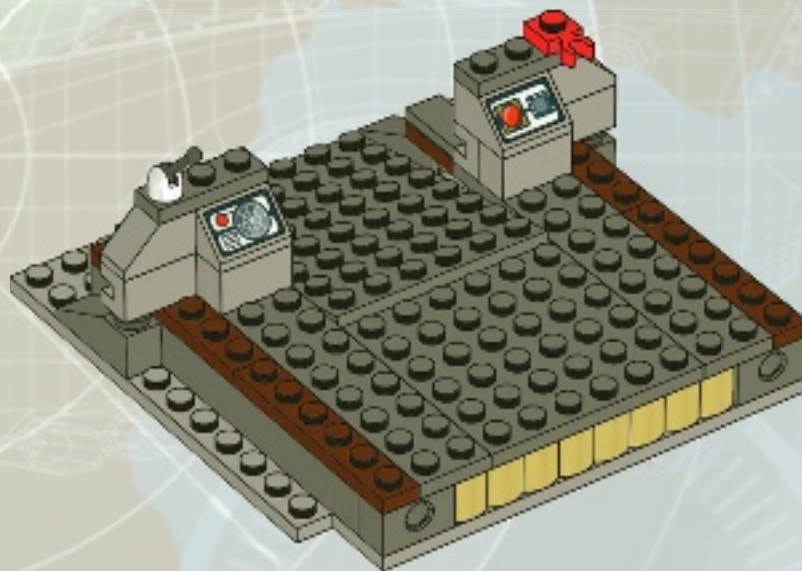



21

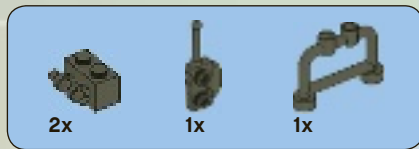
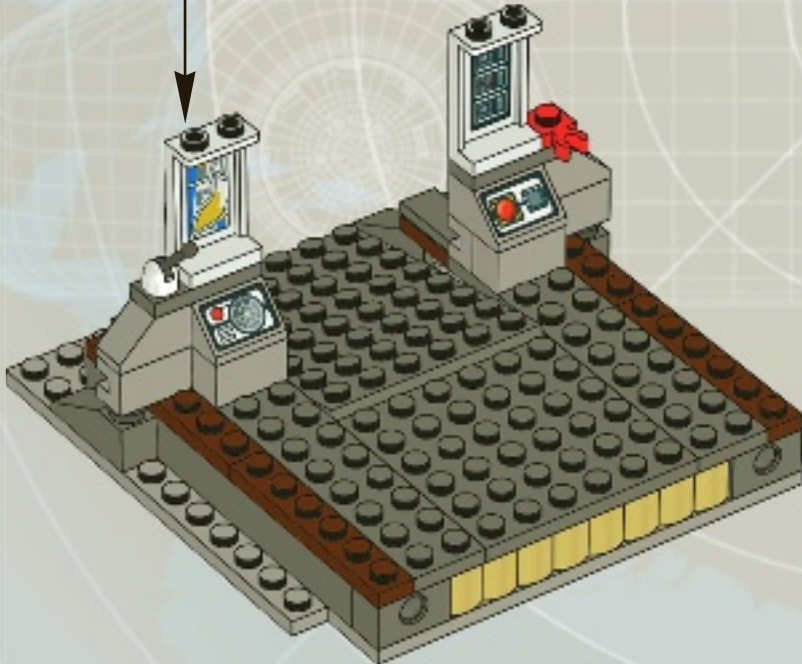
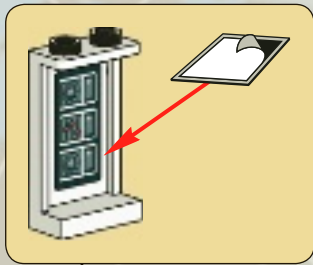
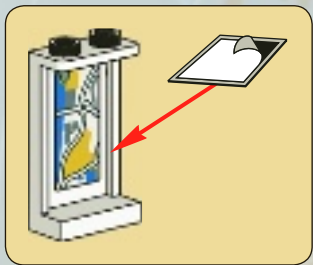

22

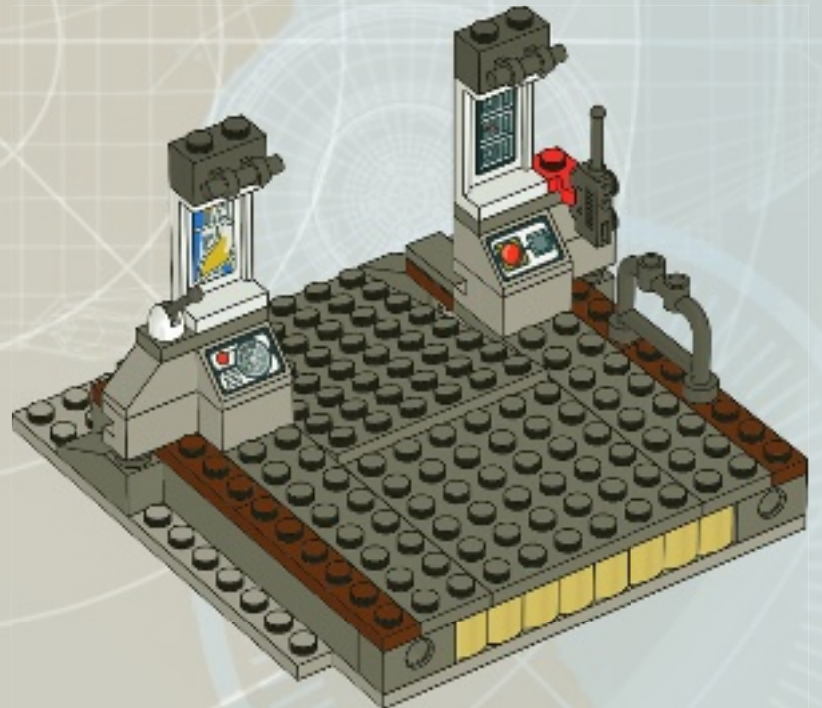

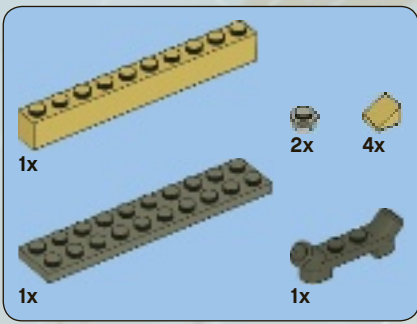

23

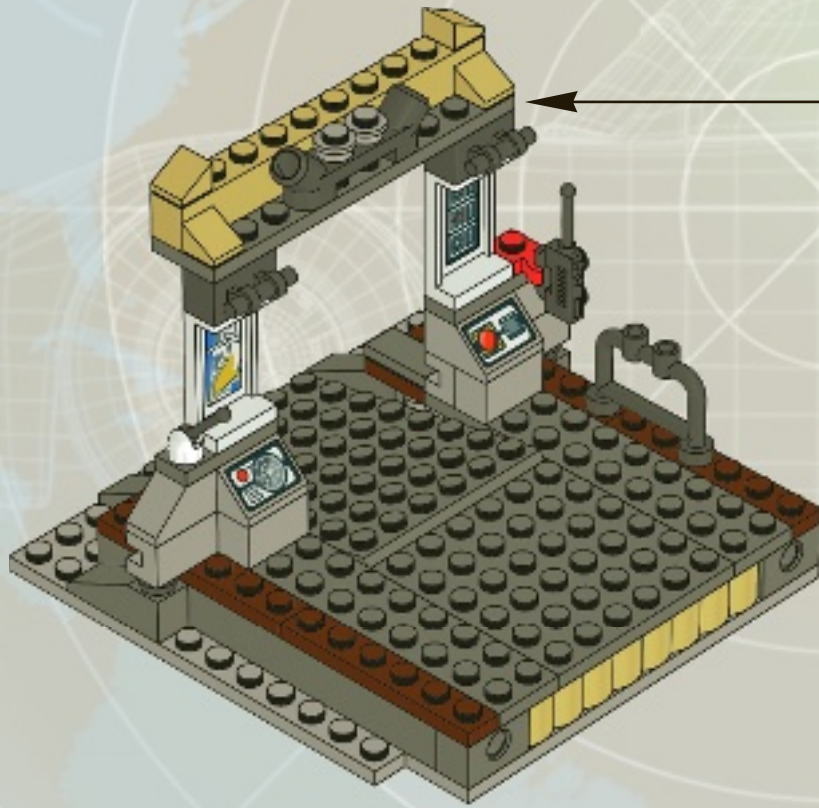

1

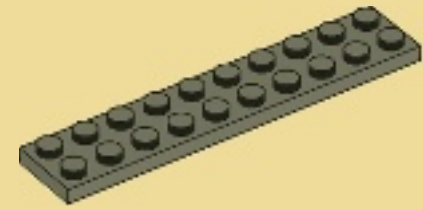

2

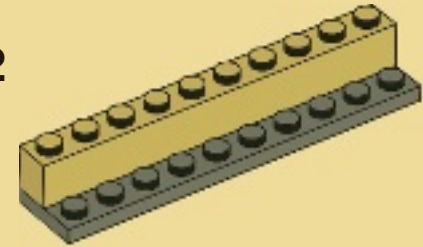

3

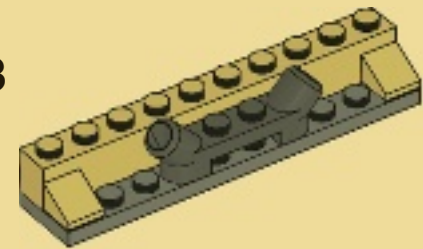

4

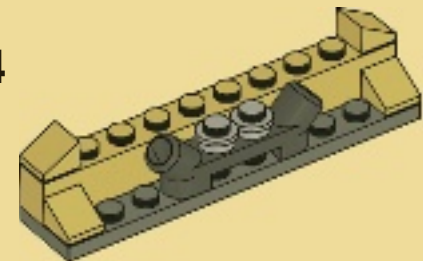

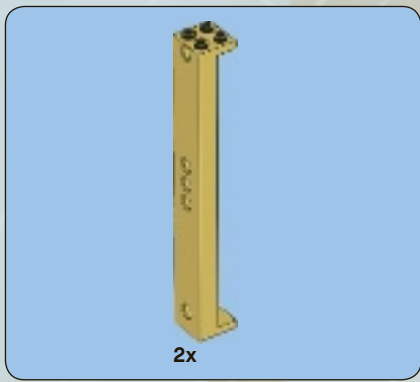

24

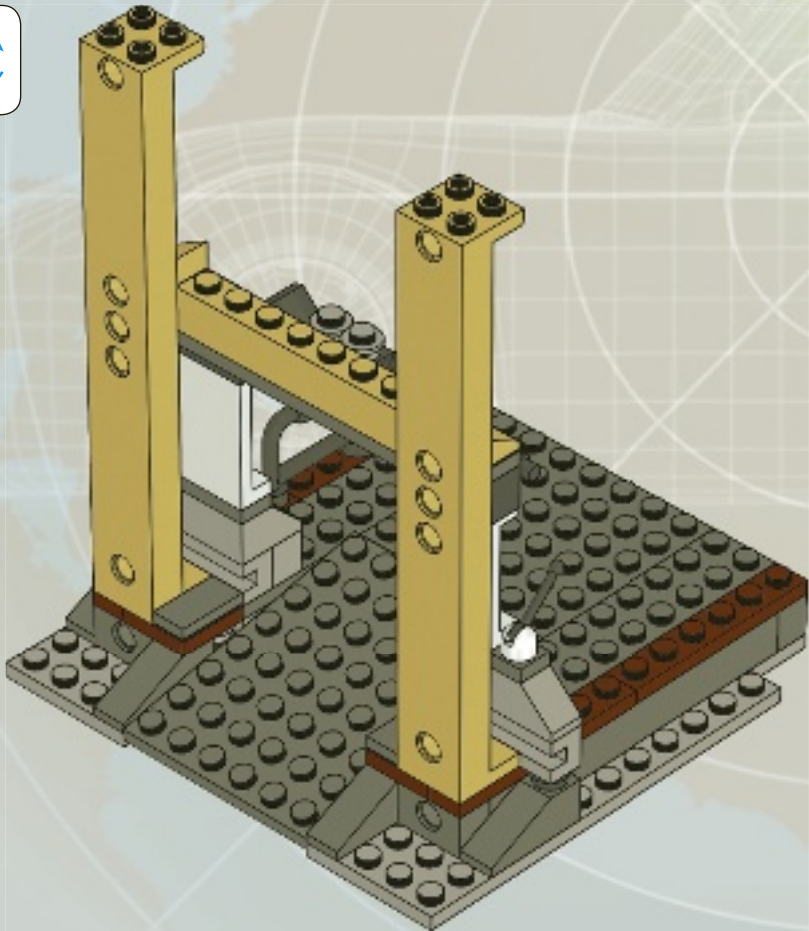

25

*target
acquired*

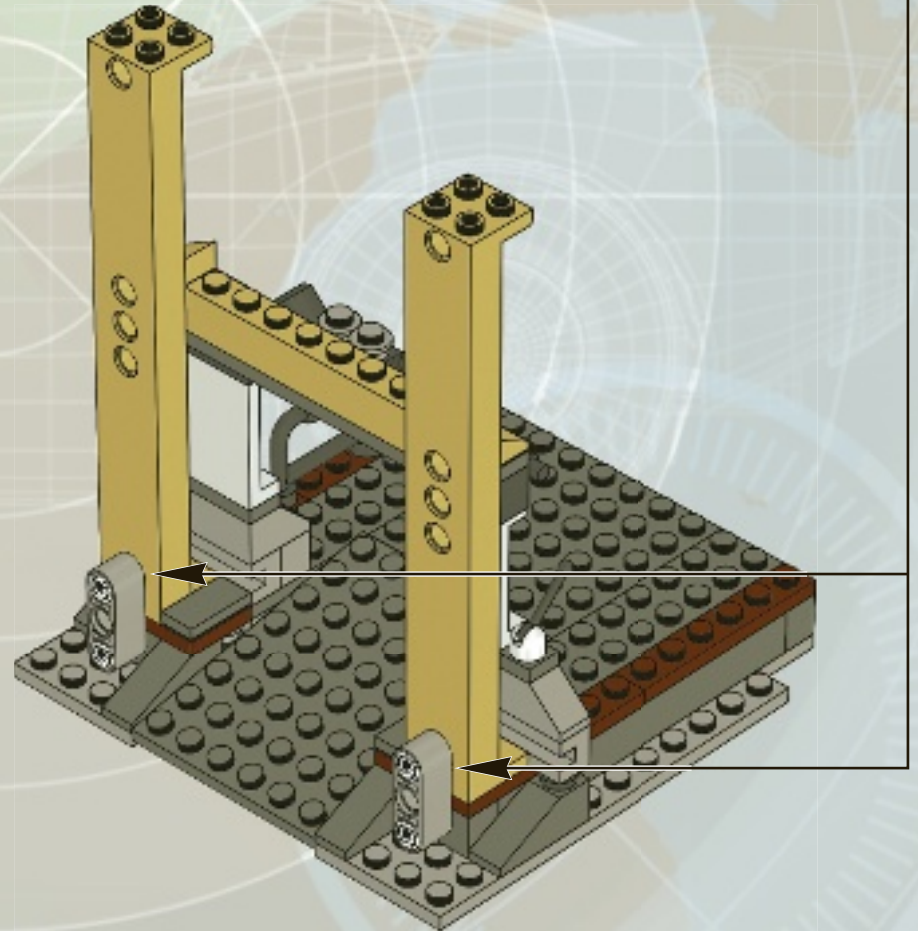
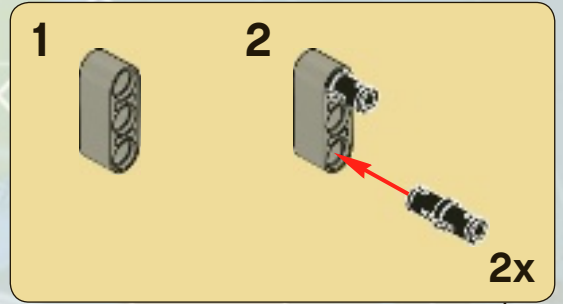

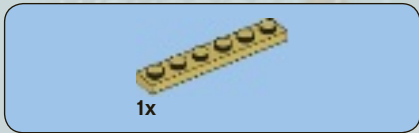
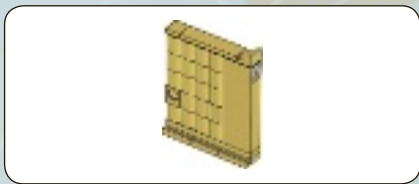

1

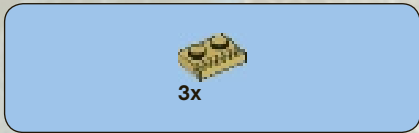

2

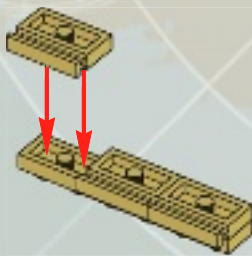

3

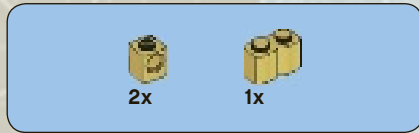
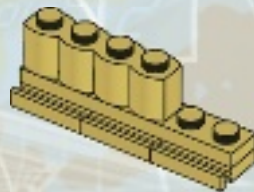
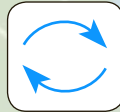

4

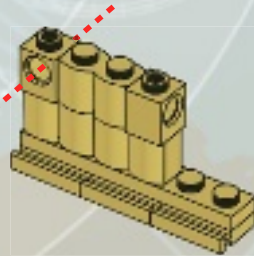

target acquired



5

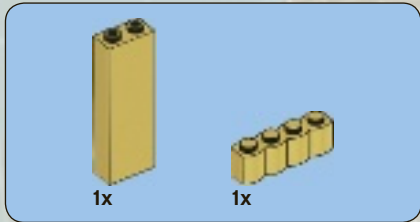
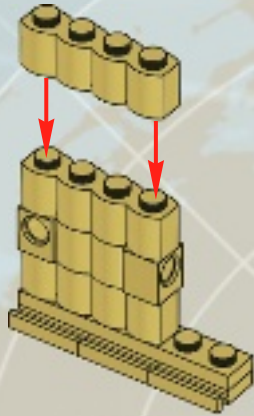

6

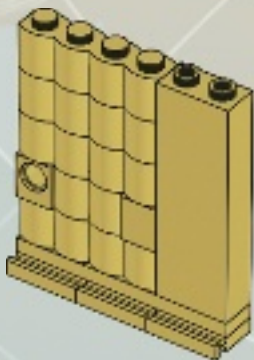

7

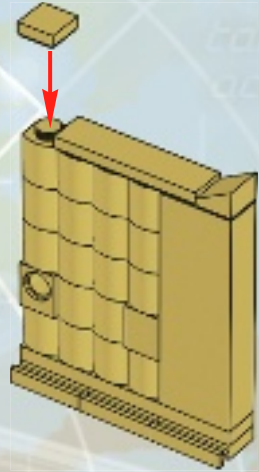

8

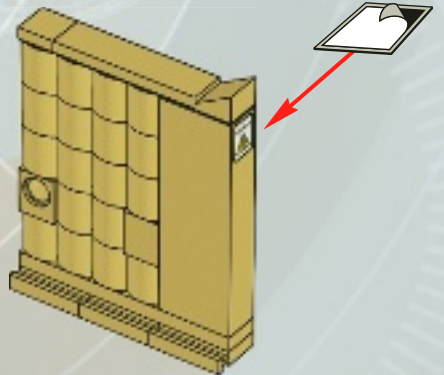

26

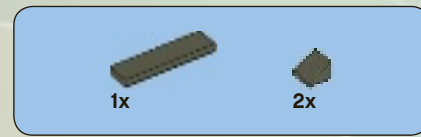
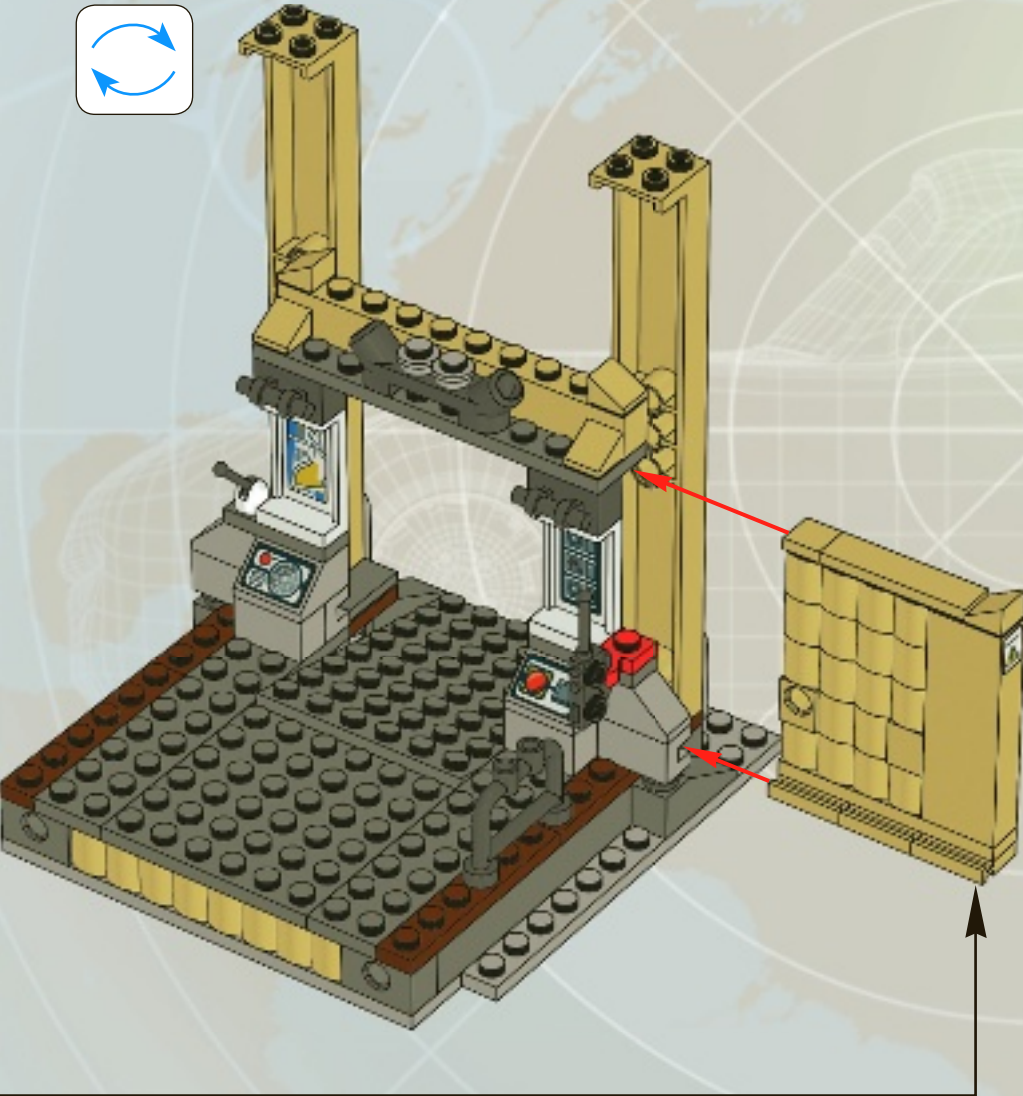

27

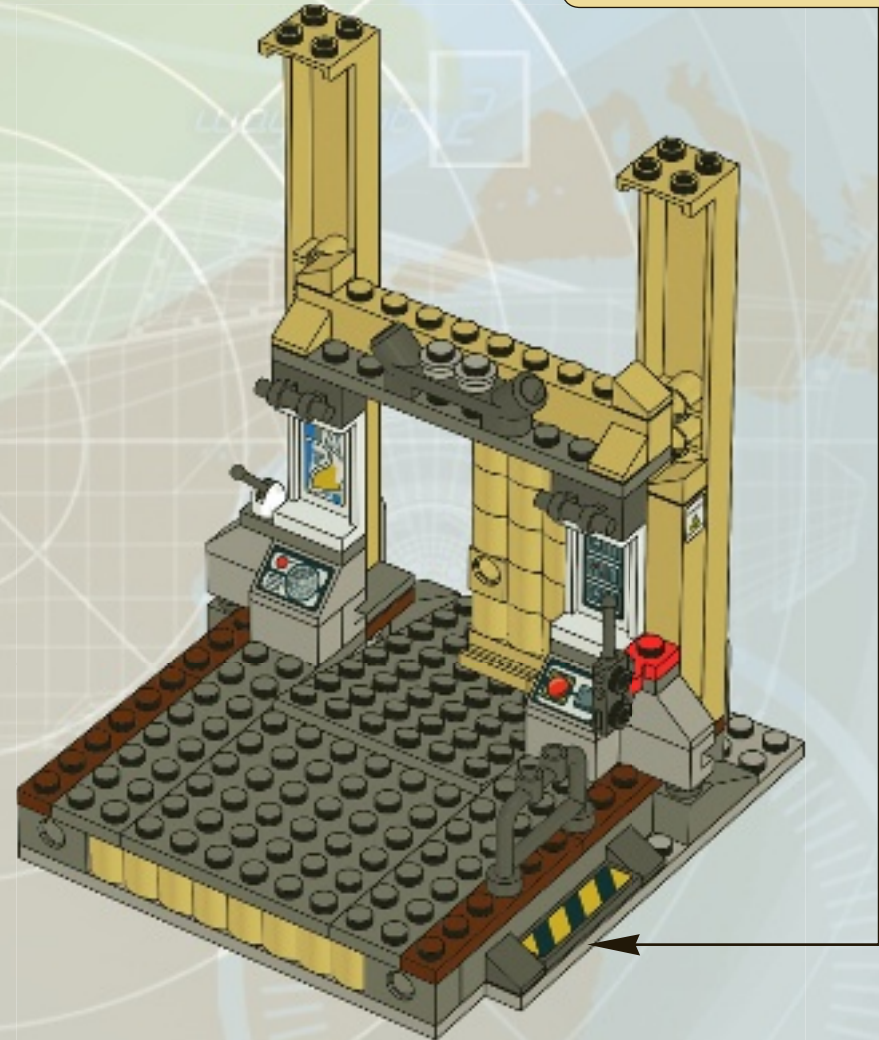
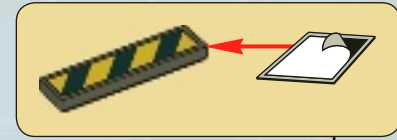

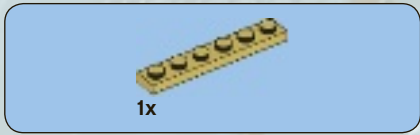

1

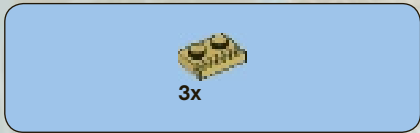

2

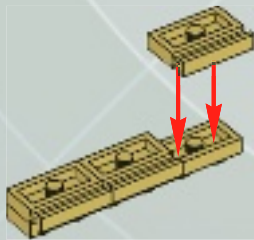

3

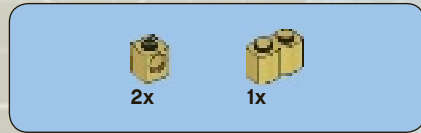
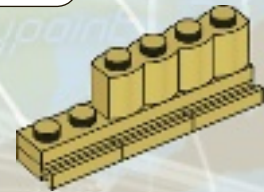
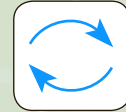

4

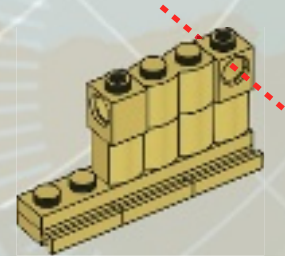



5

waypoint 1

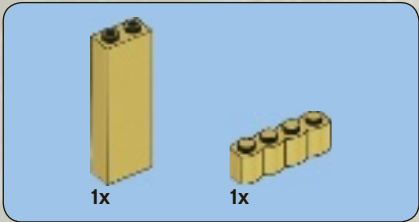
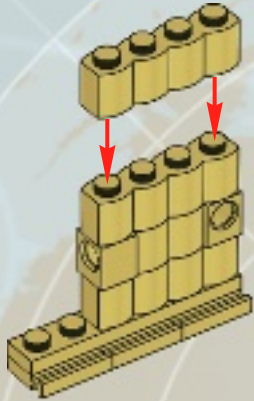

6

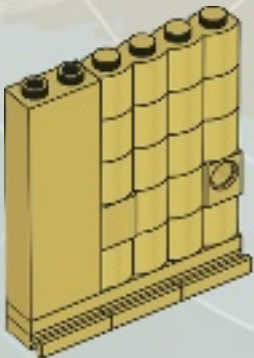

7

target acquired

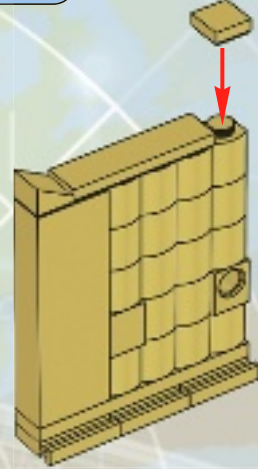

8

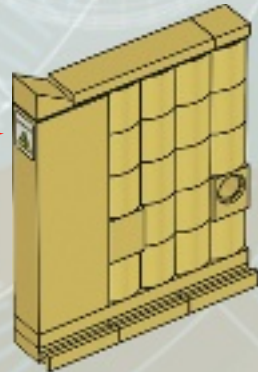

28

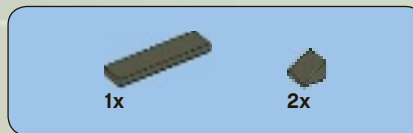
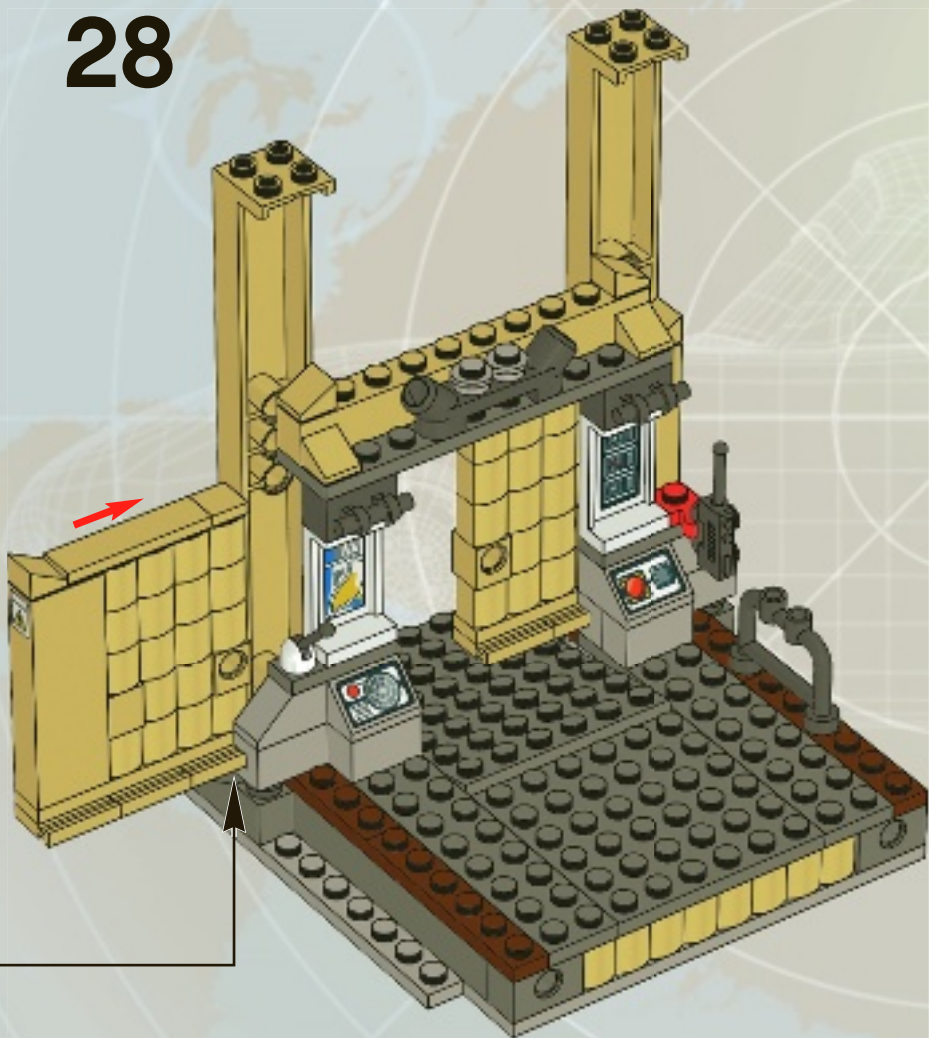

29





30



31

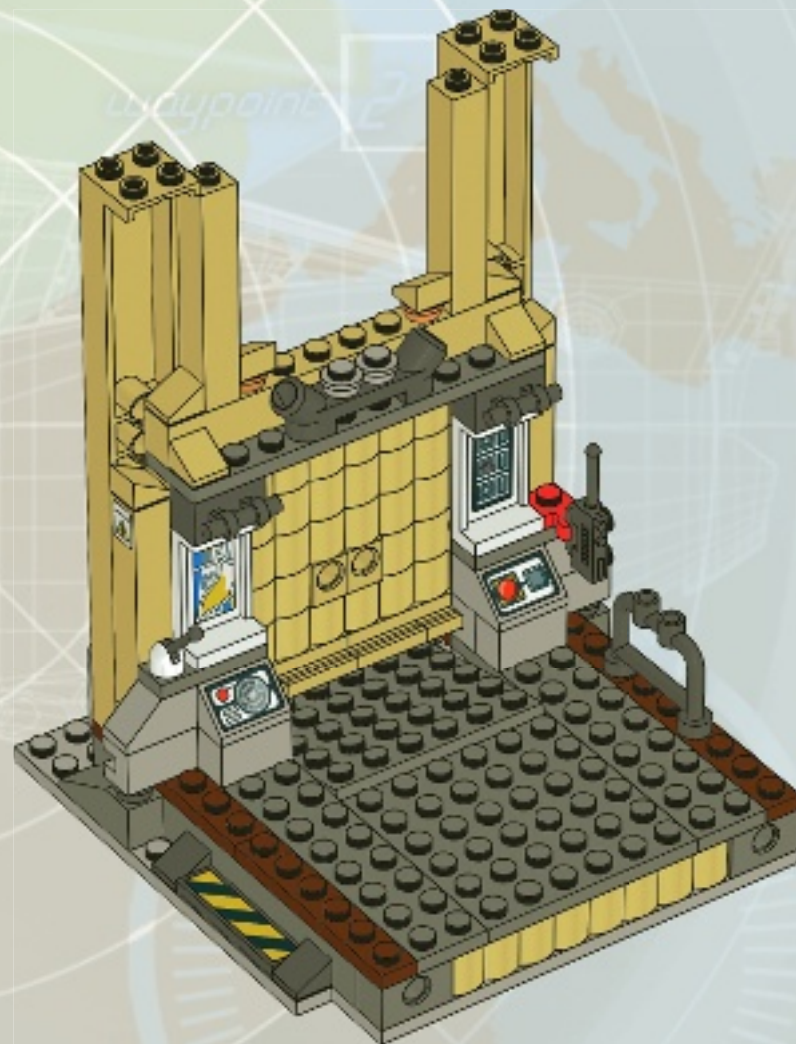



32

Waypoint 1

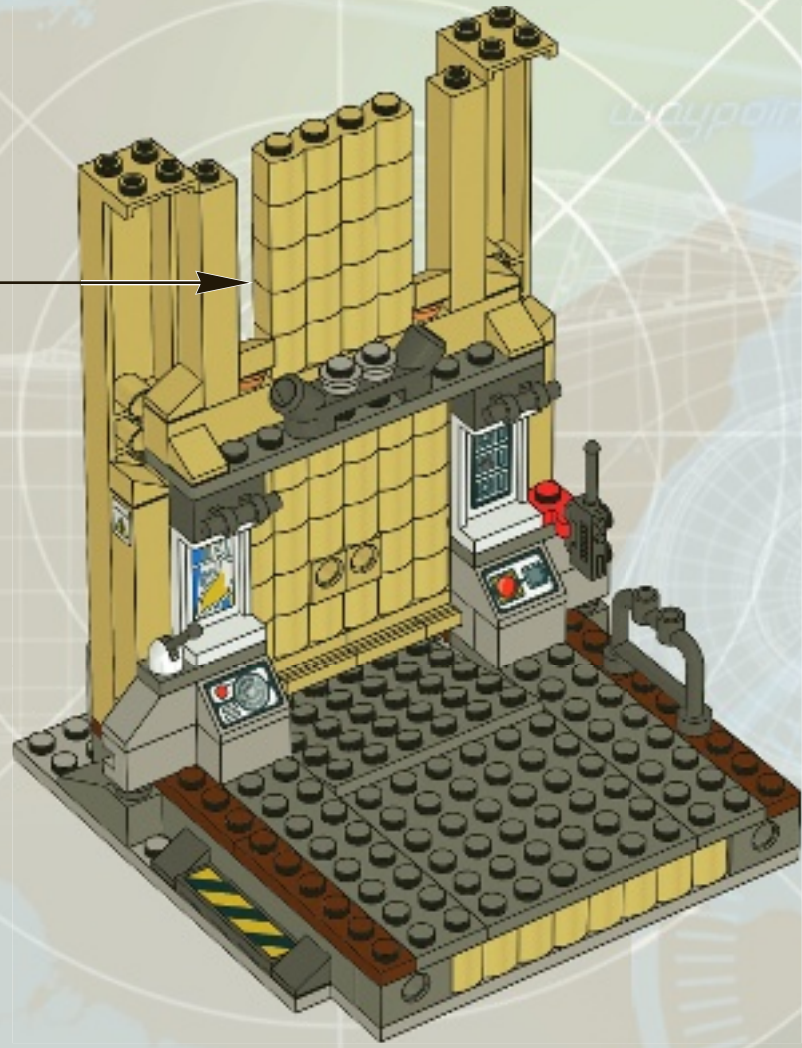
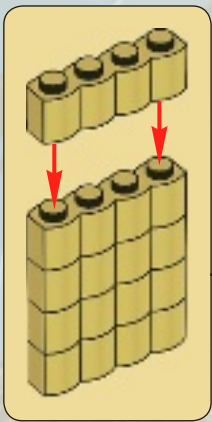

Waypoint 2

target acquired

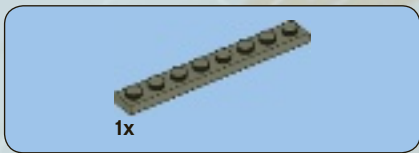

33

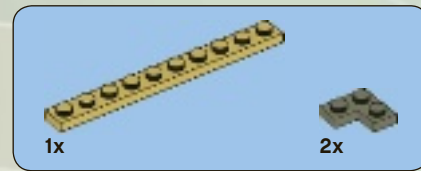

34



target
acquired

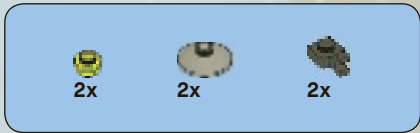

35

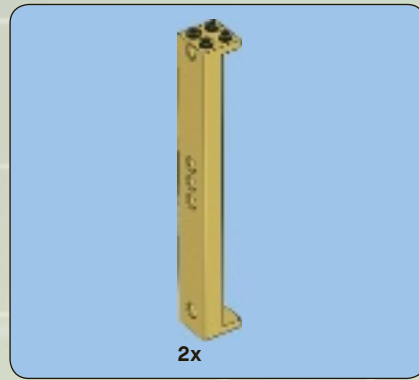
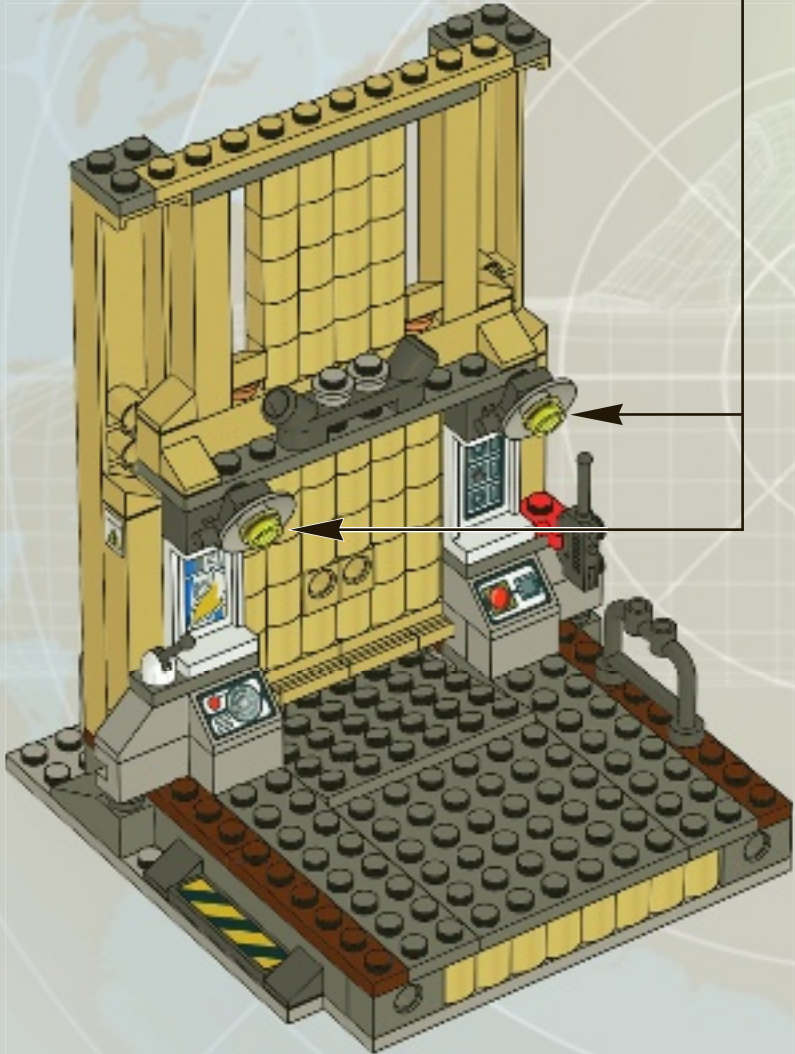

36

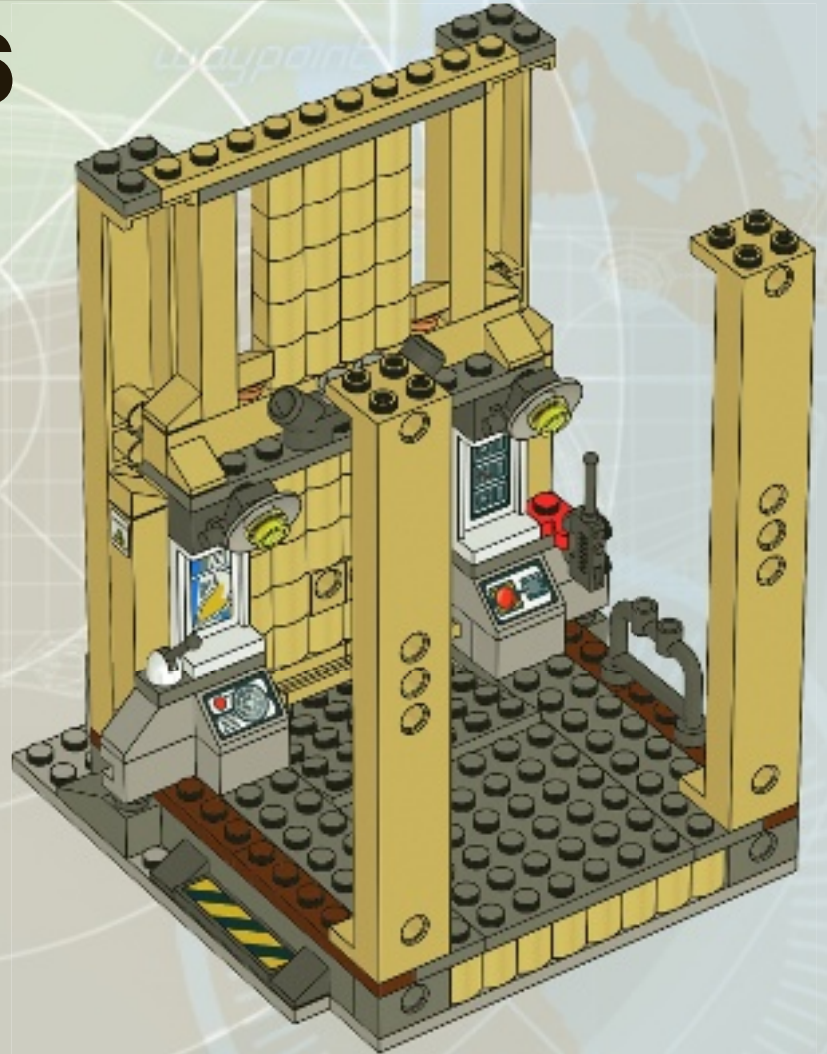

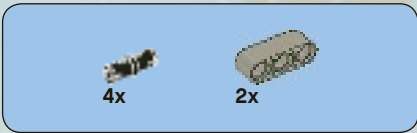

37

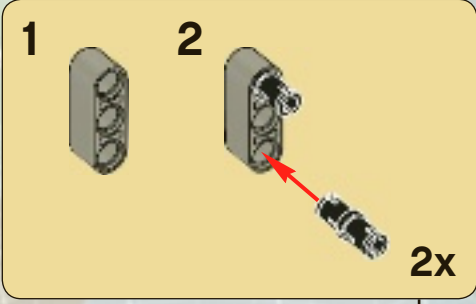
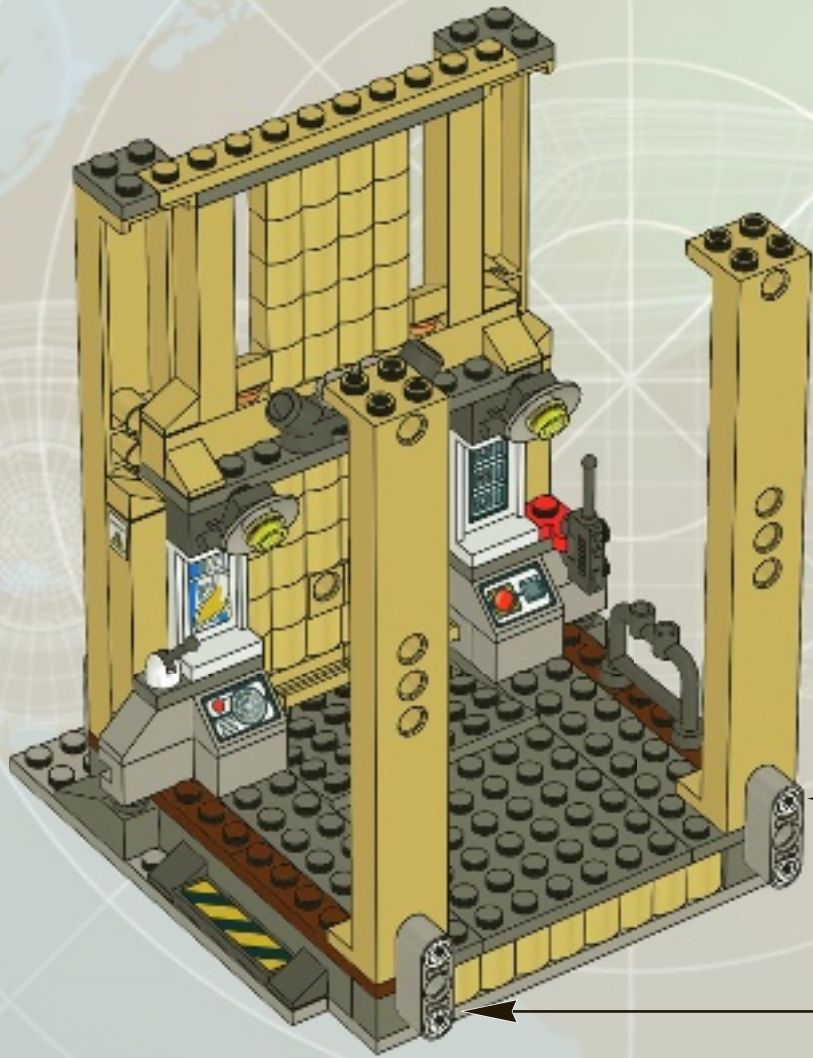

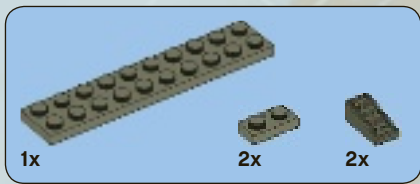

38

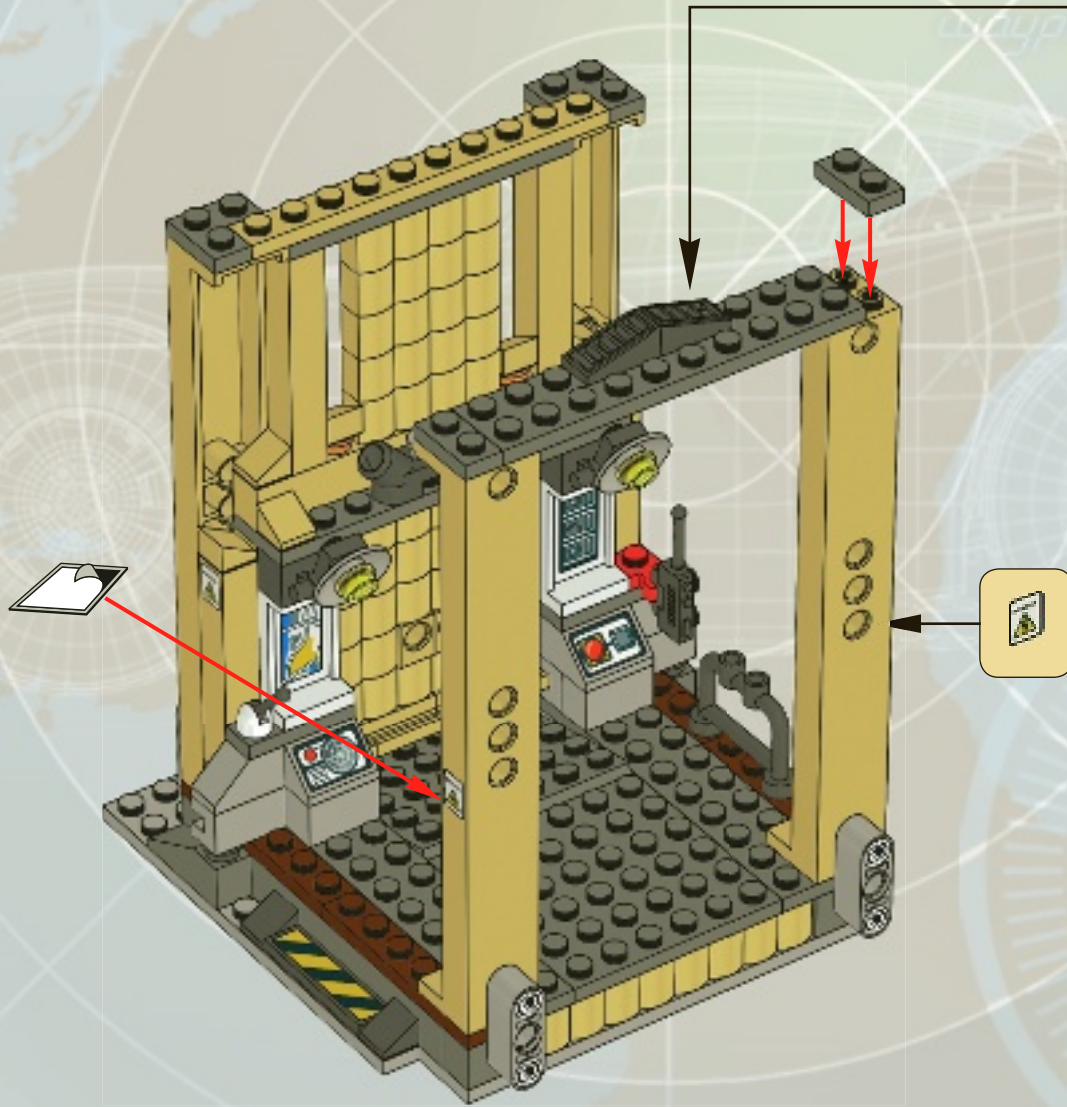
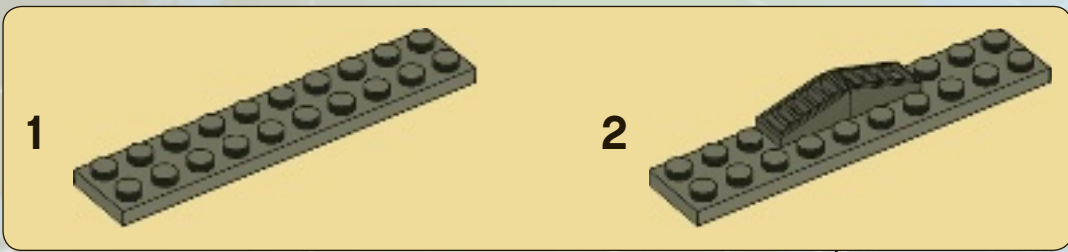

1x  1x 

39

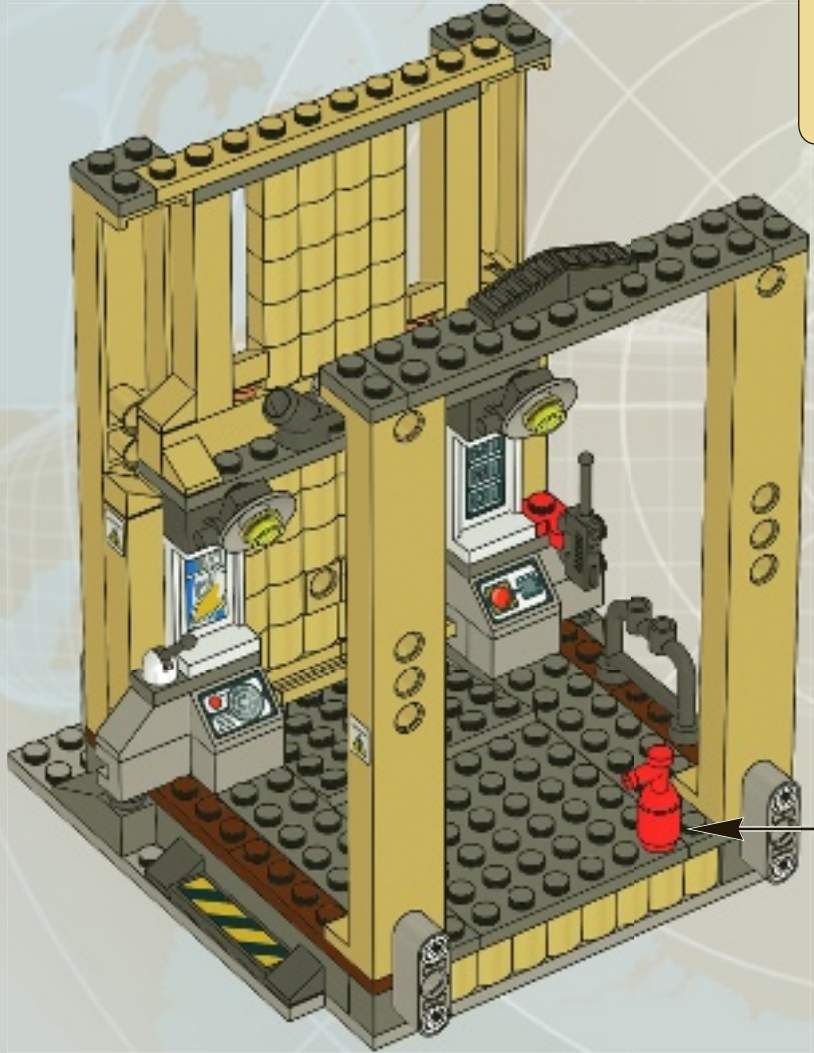

2x 

40

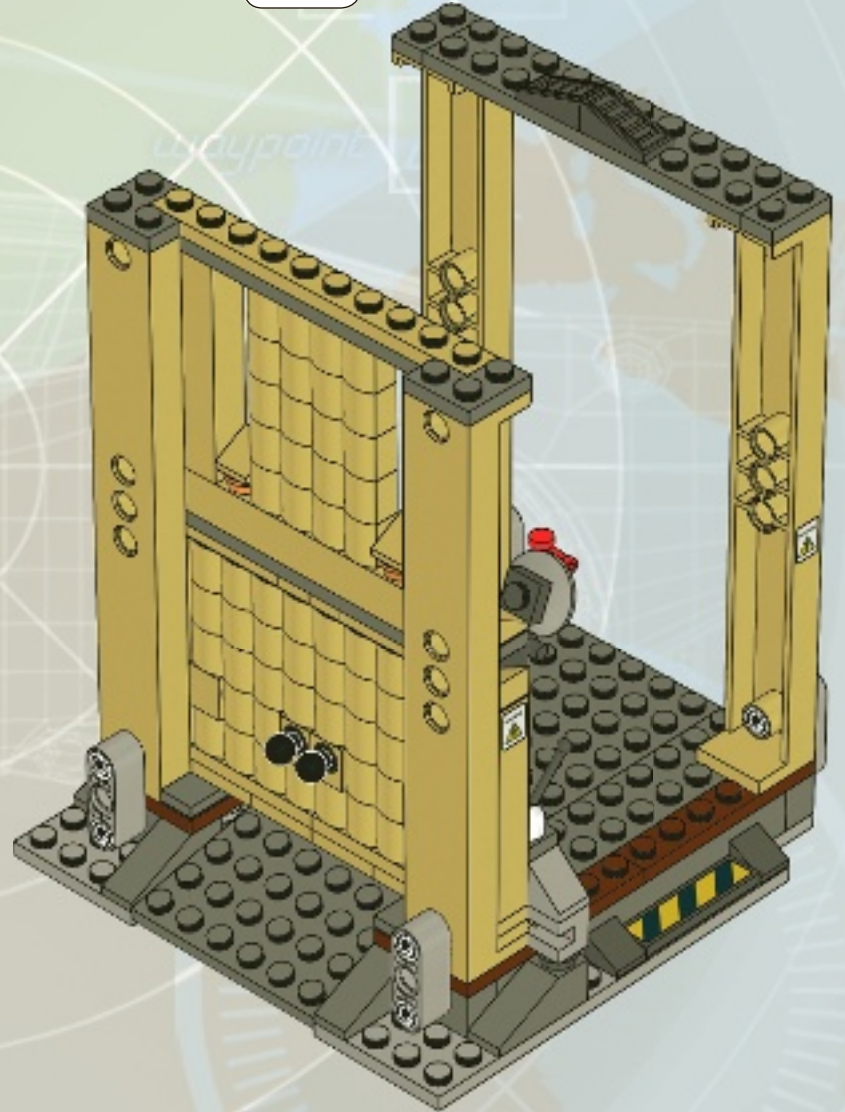

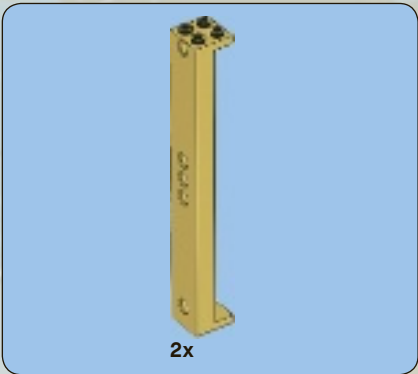

41

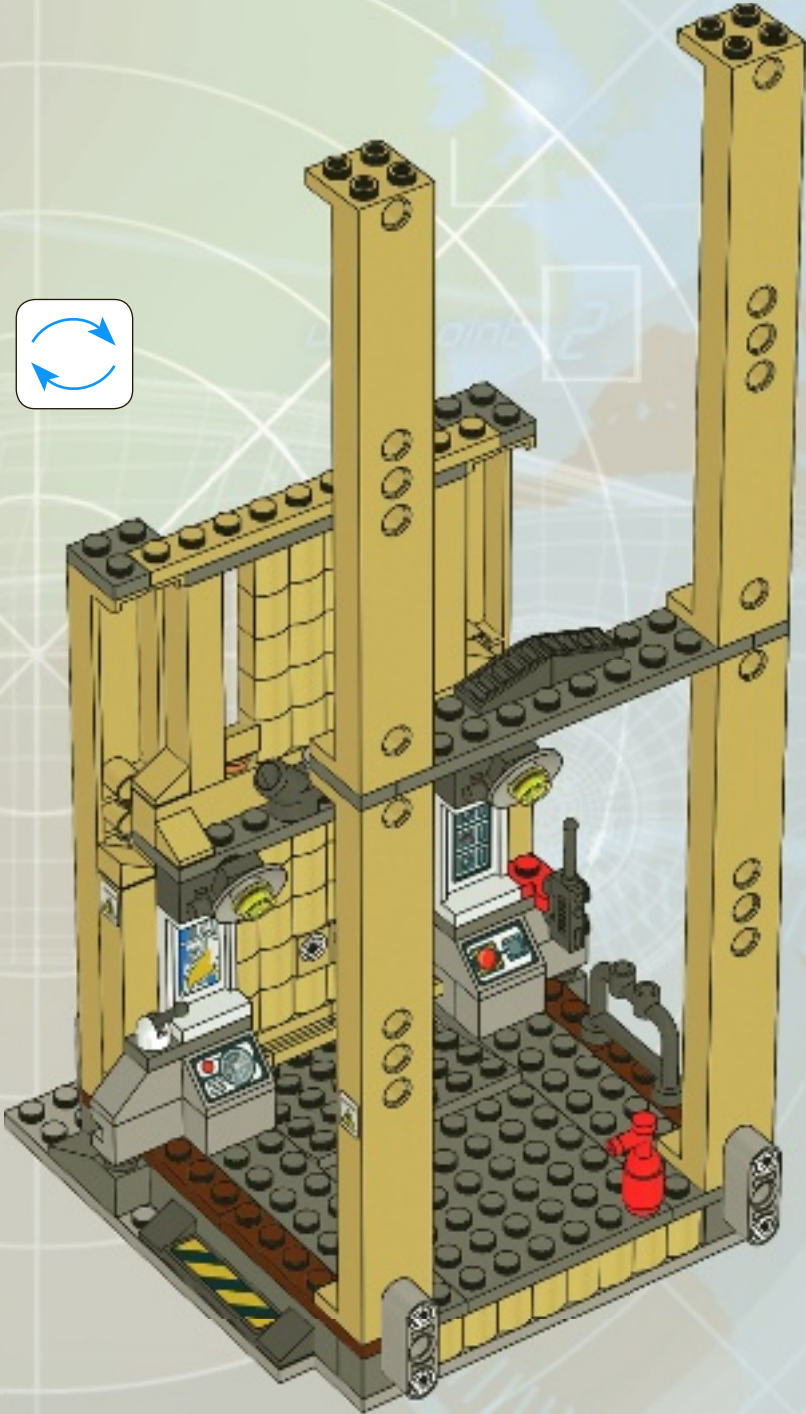
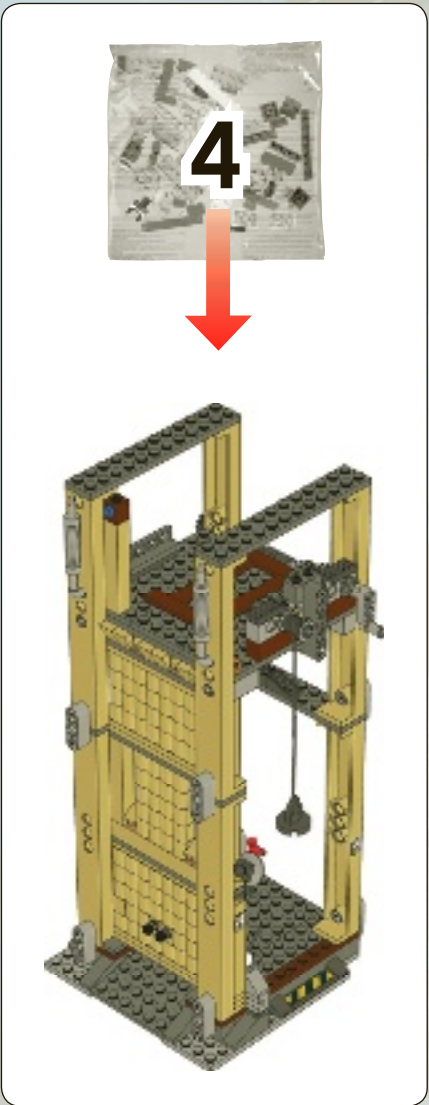

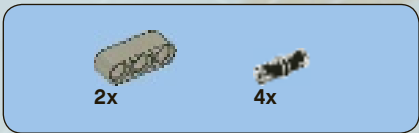

42

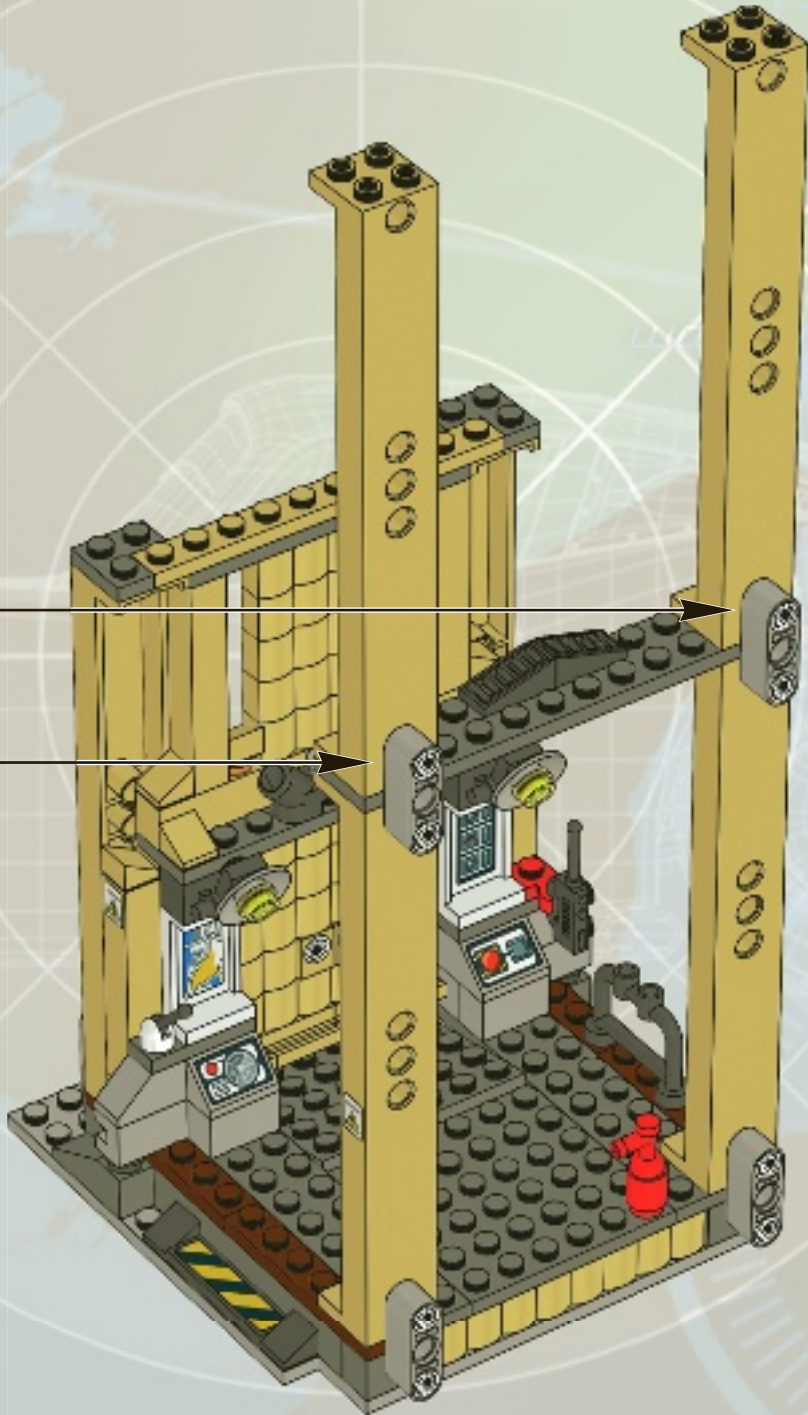
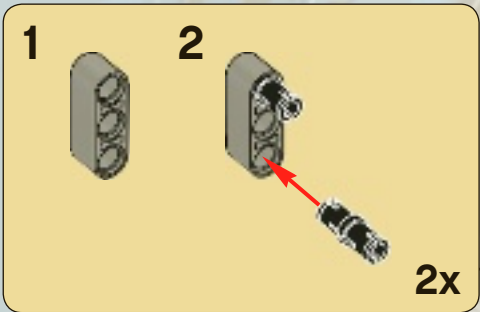

target acquired

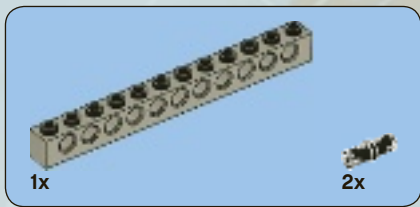

43

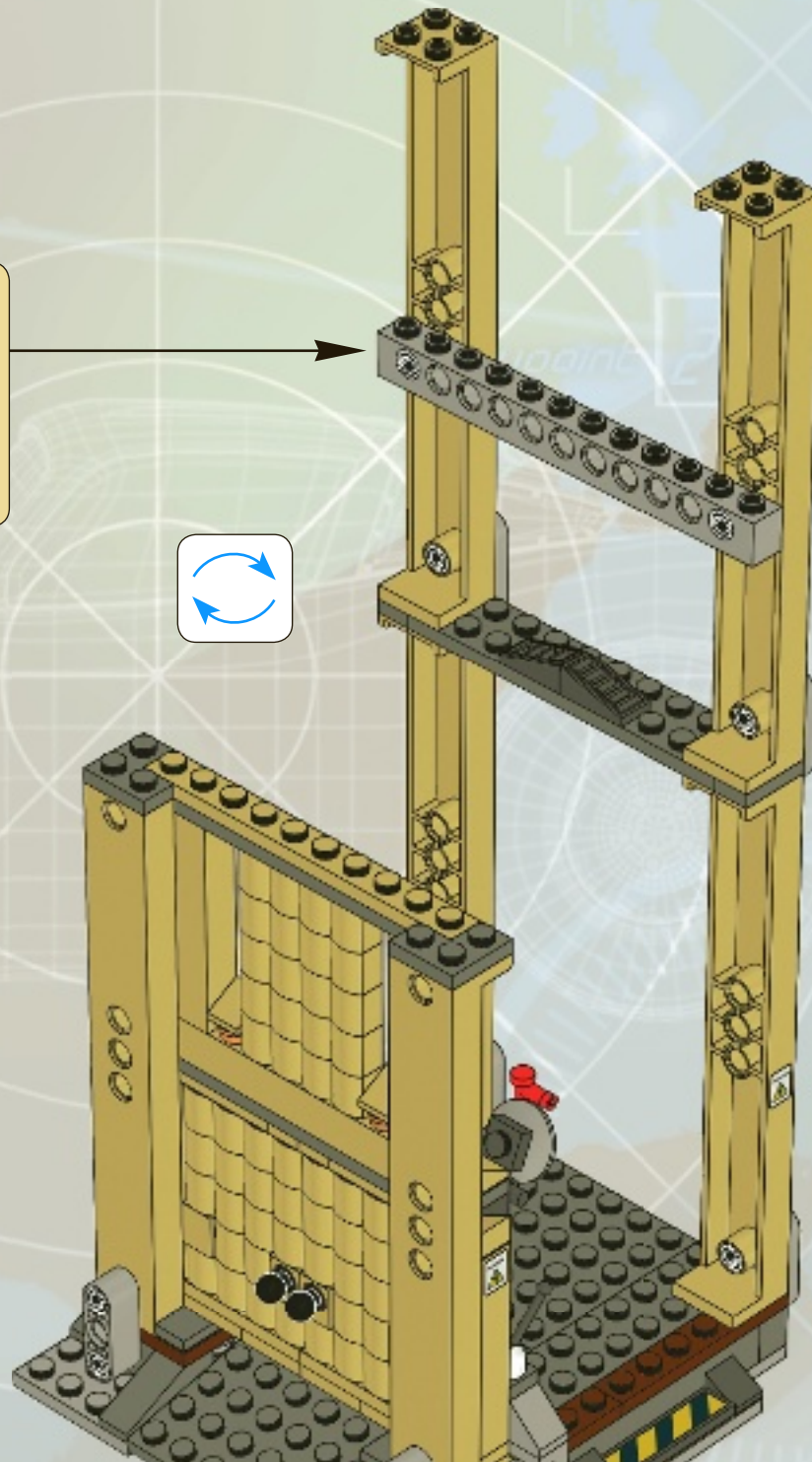
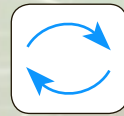
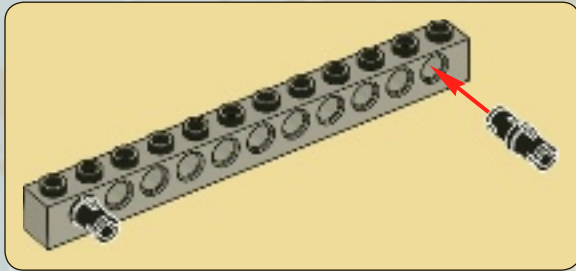

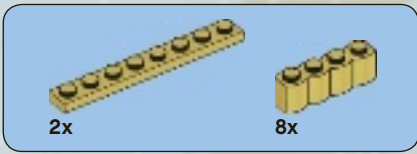

44

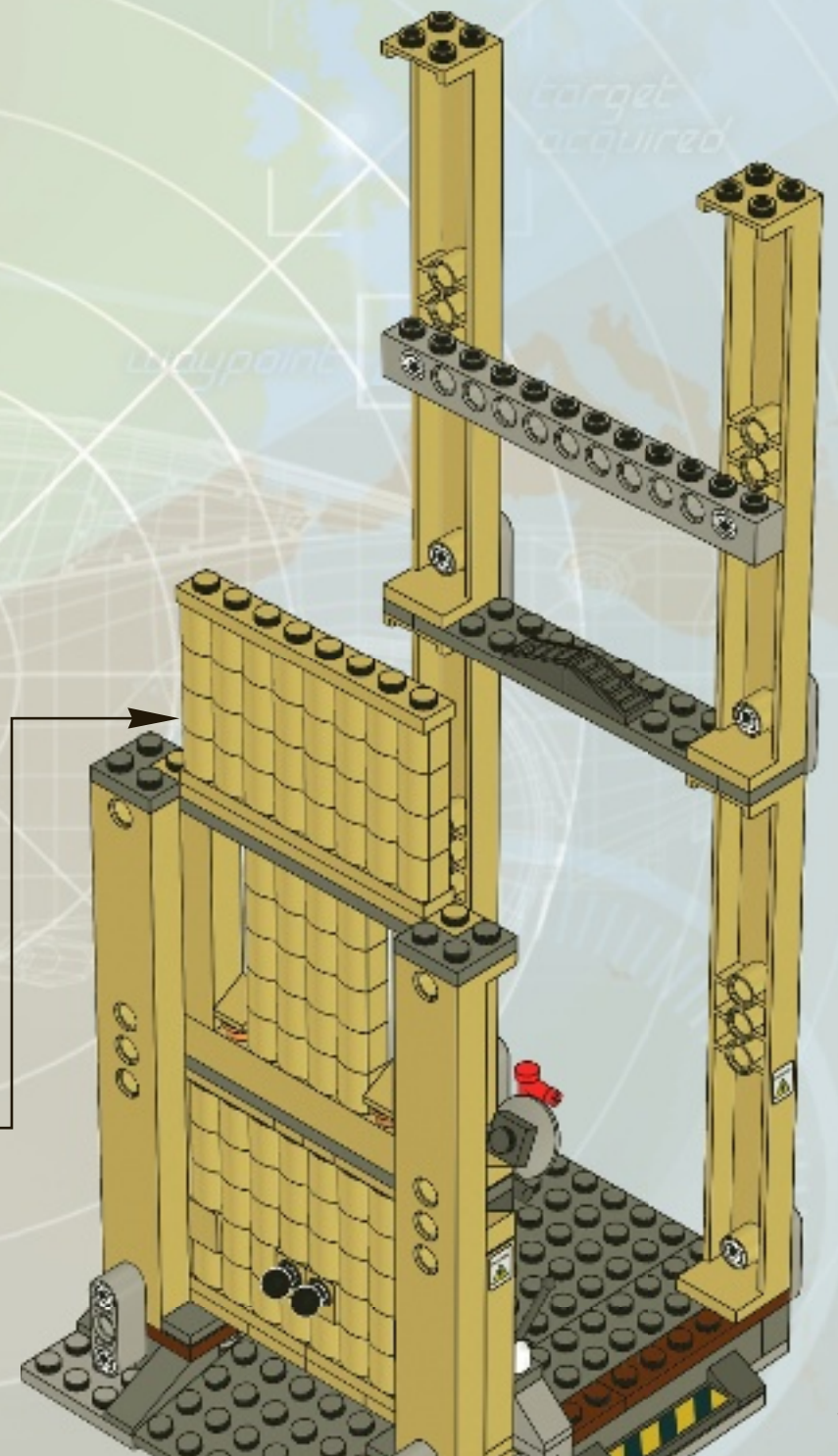
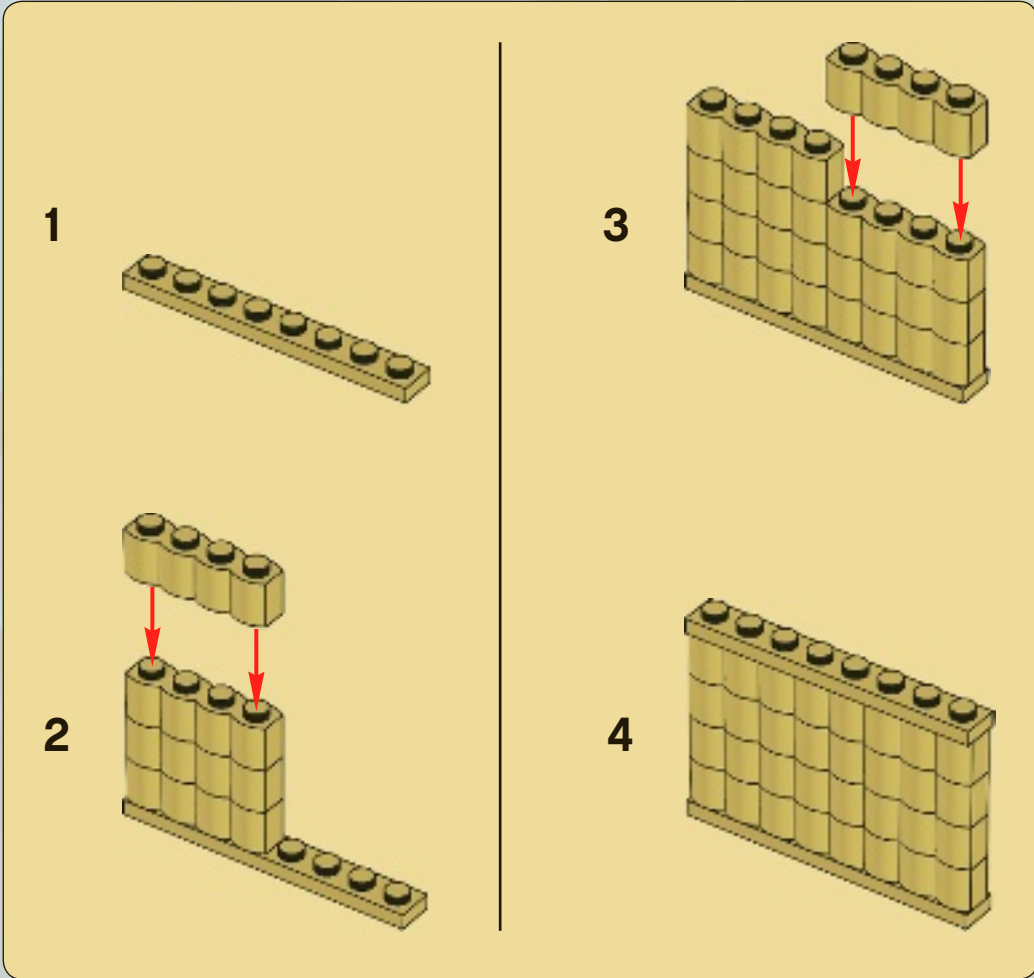



45

1

2

3

4

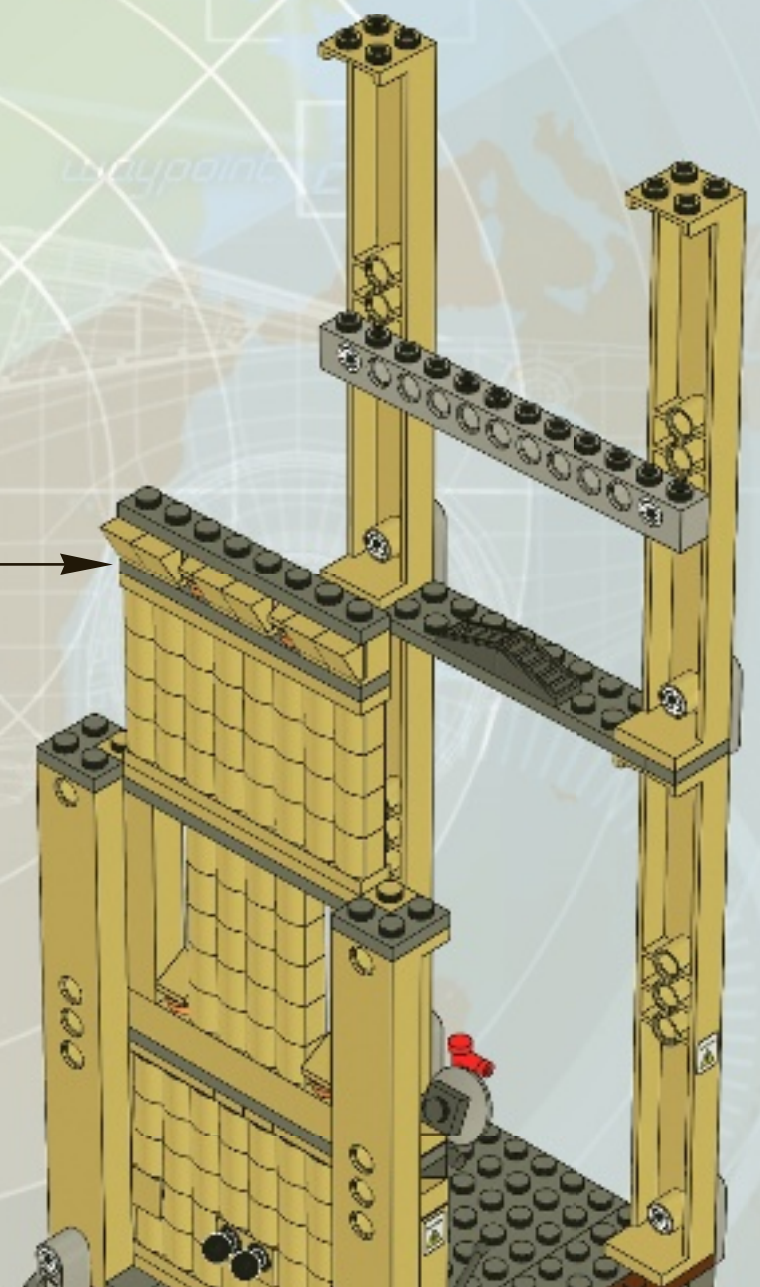

target
acquired

waypoint

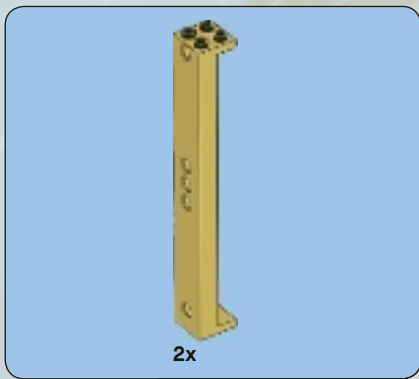

46

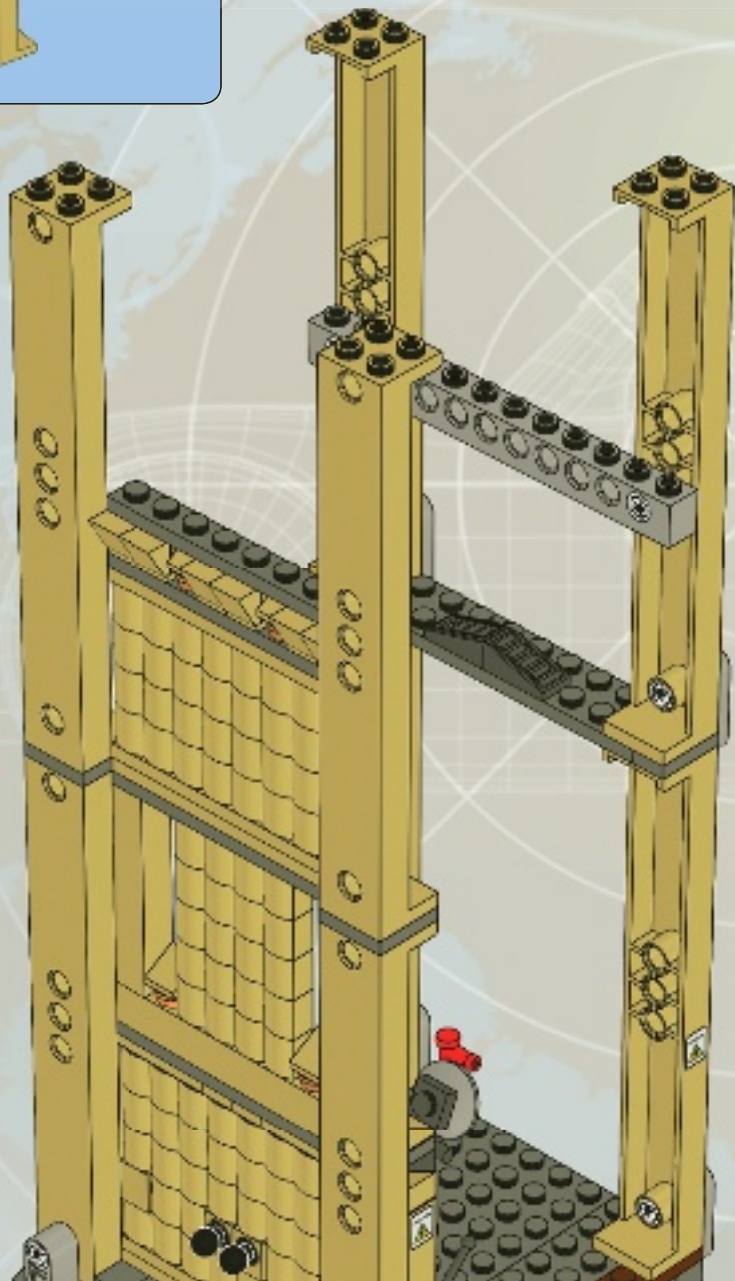

47

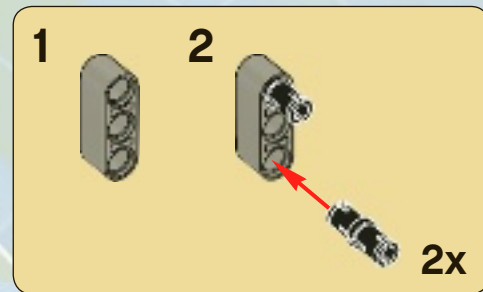
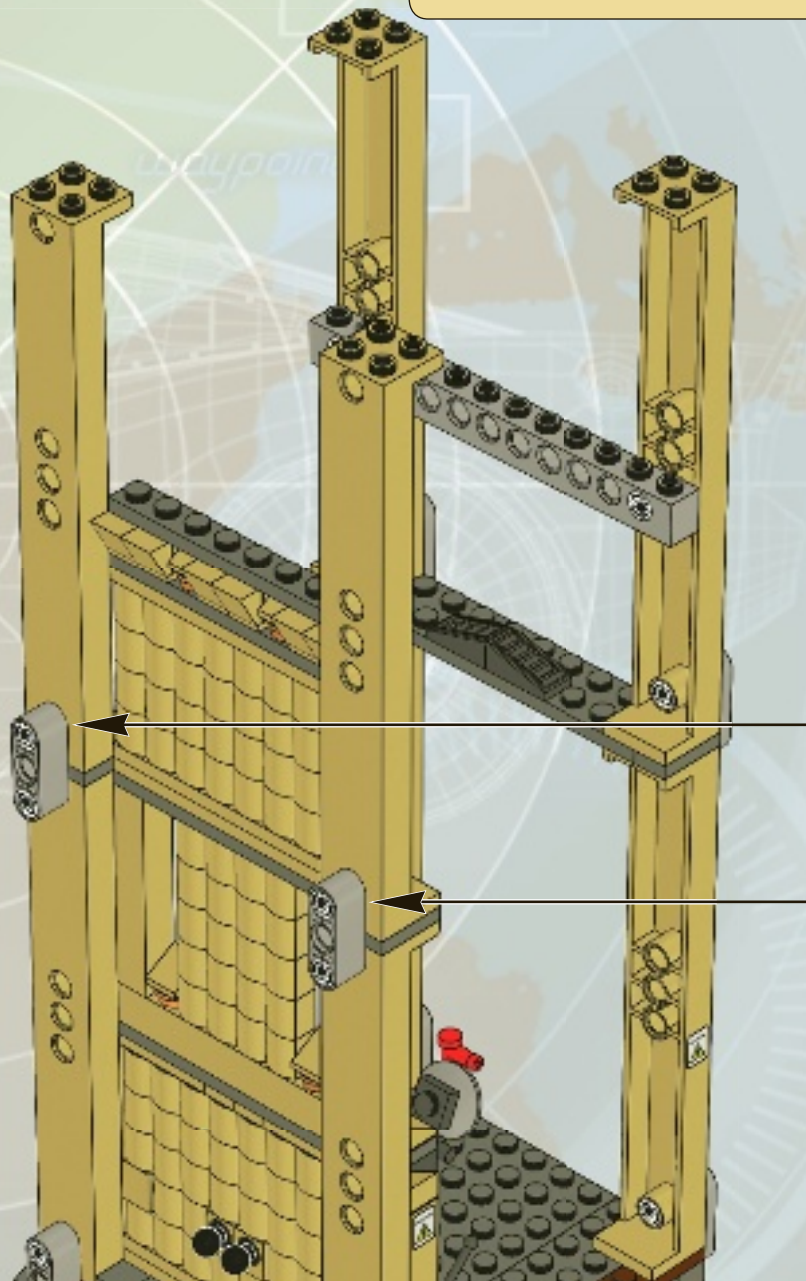



2x

48

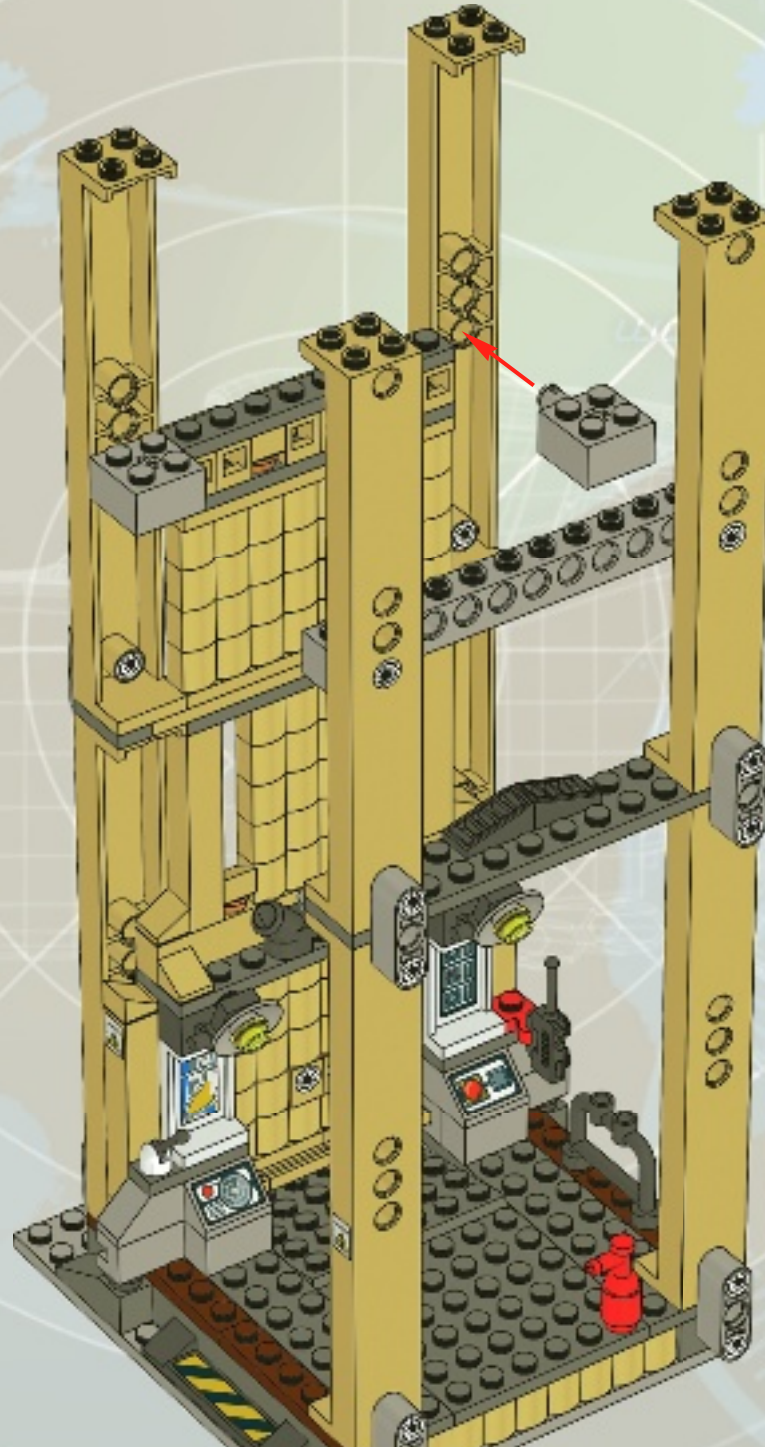

target
acquired

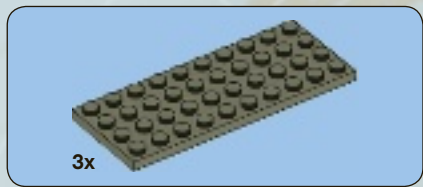

49

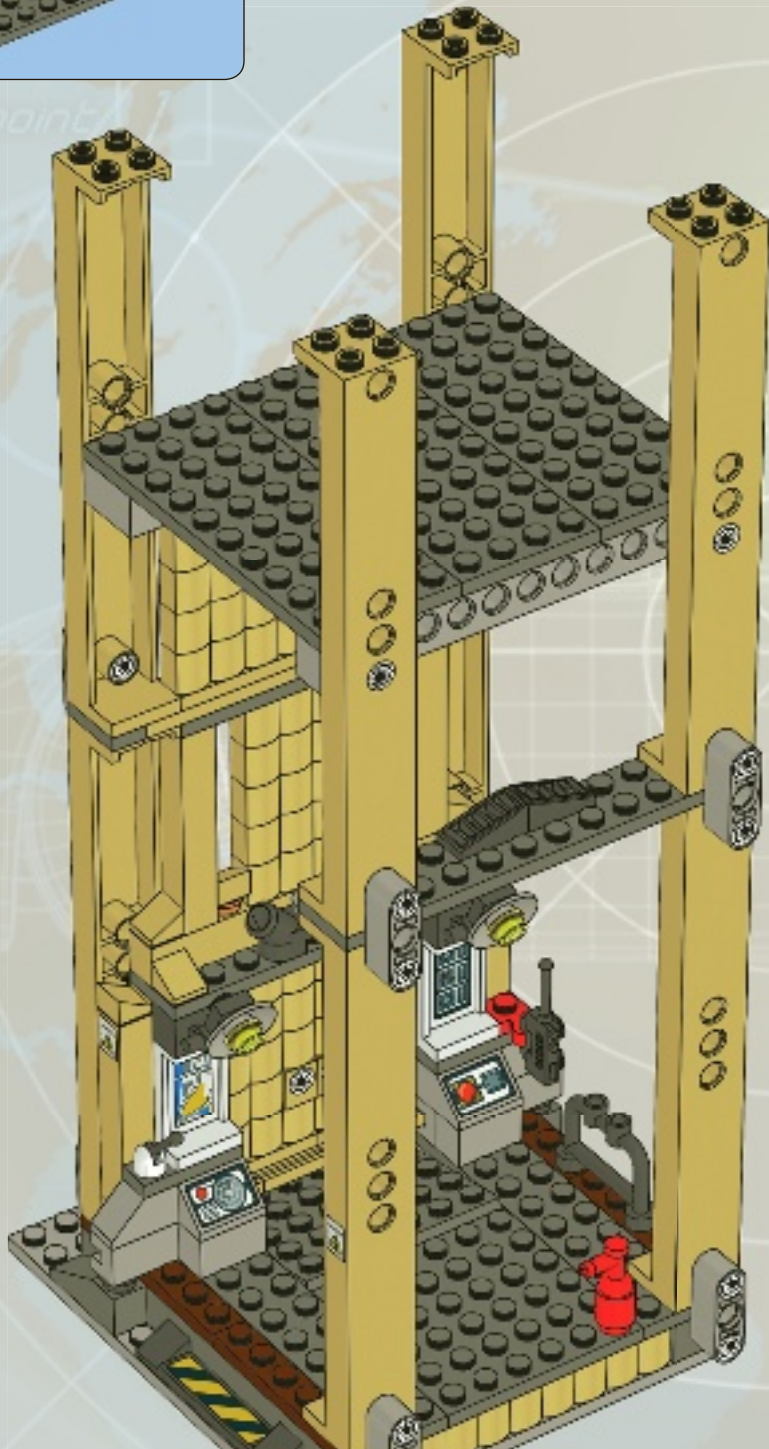

50

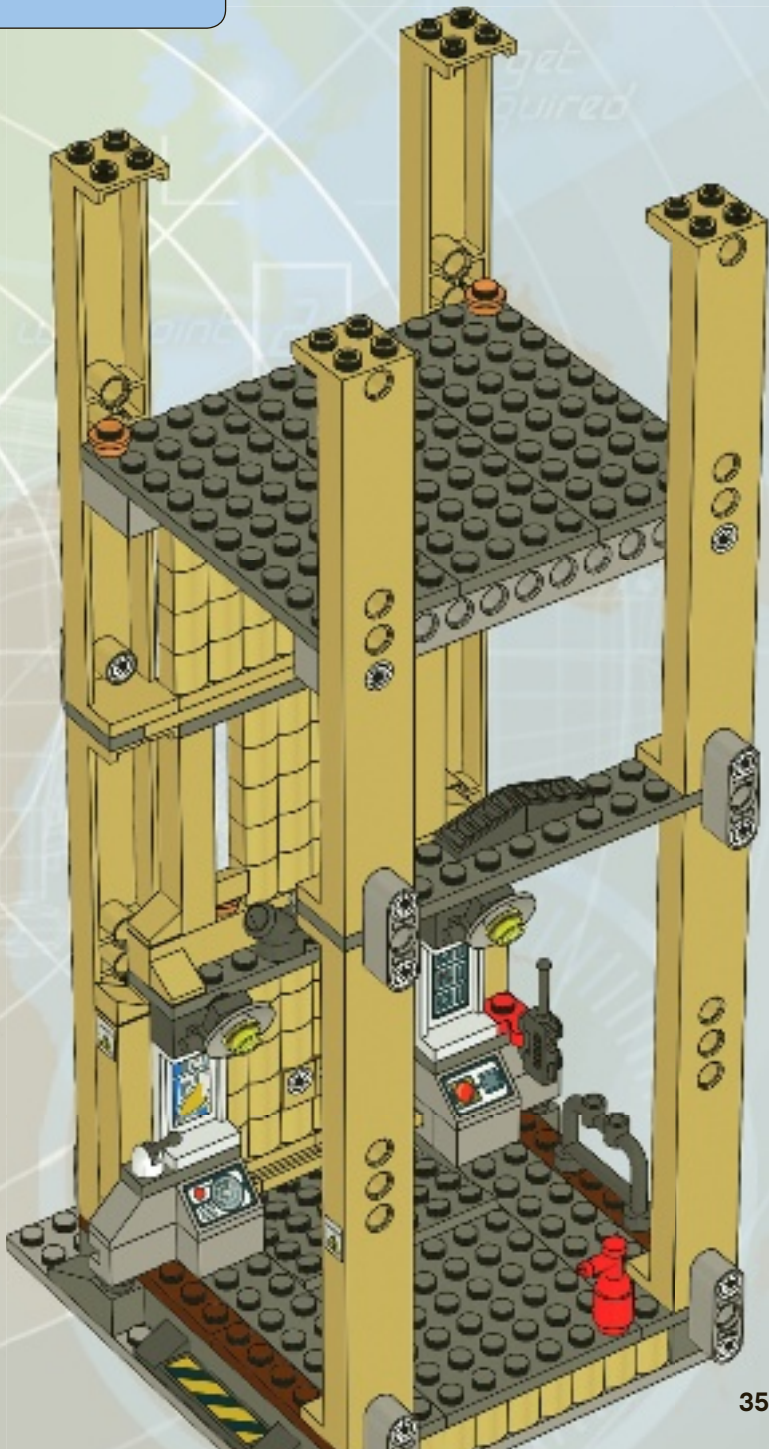

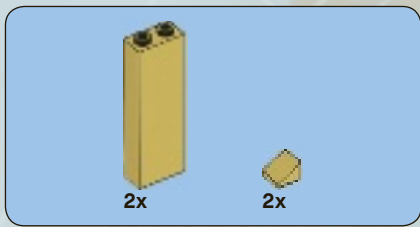

51

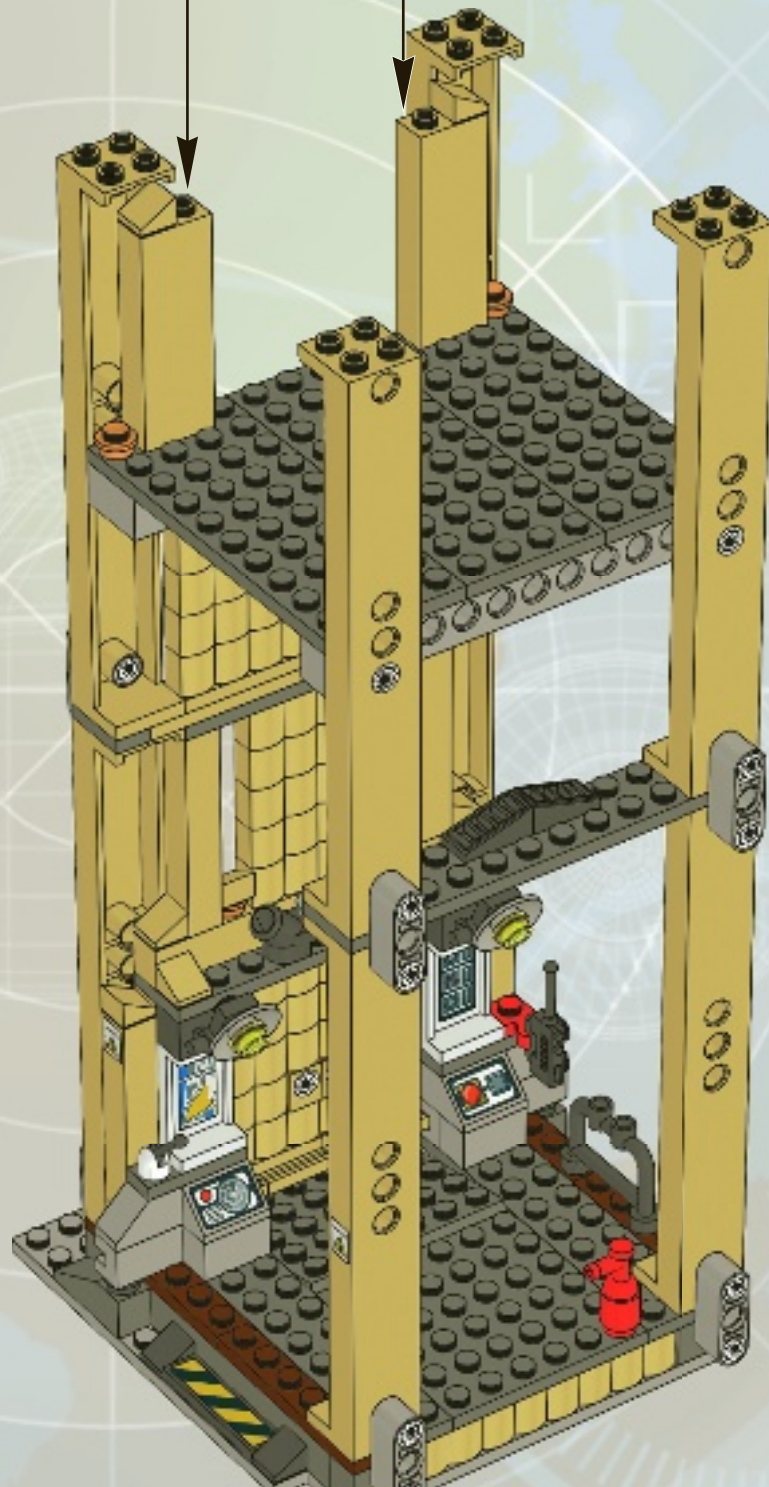
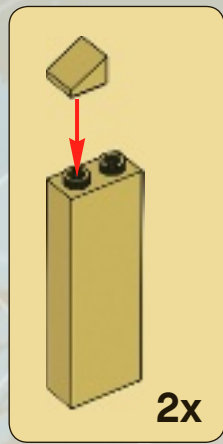



52

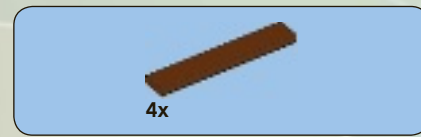
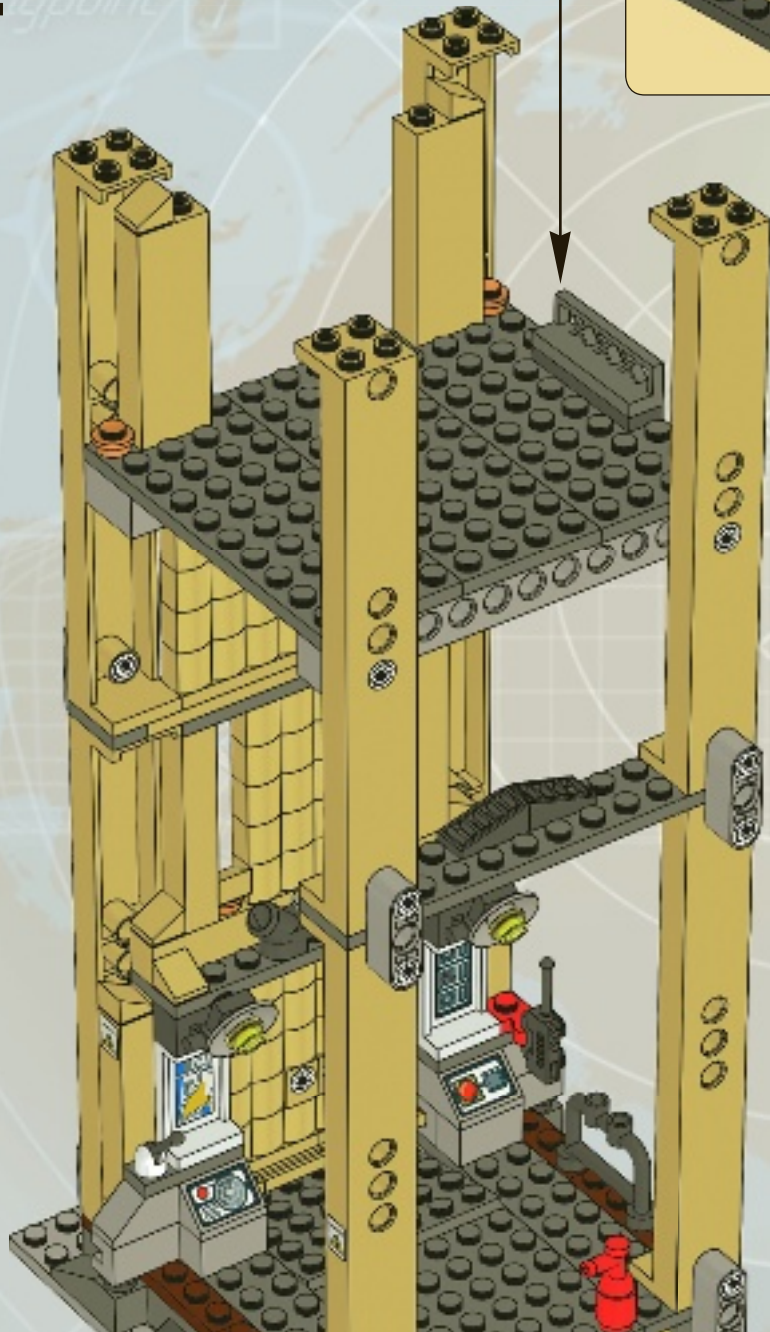
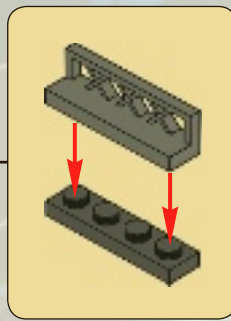

53

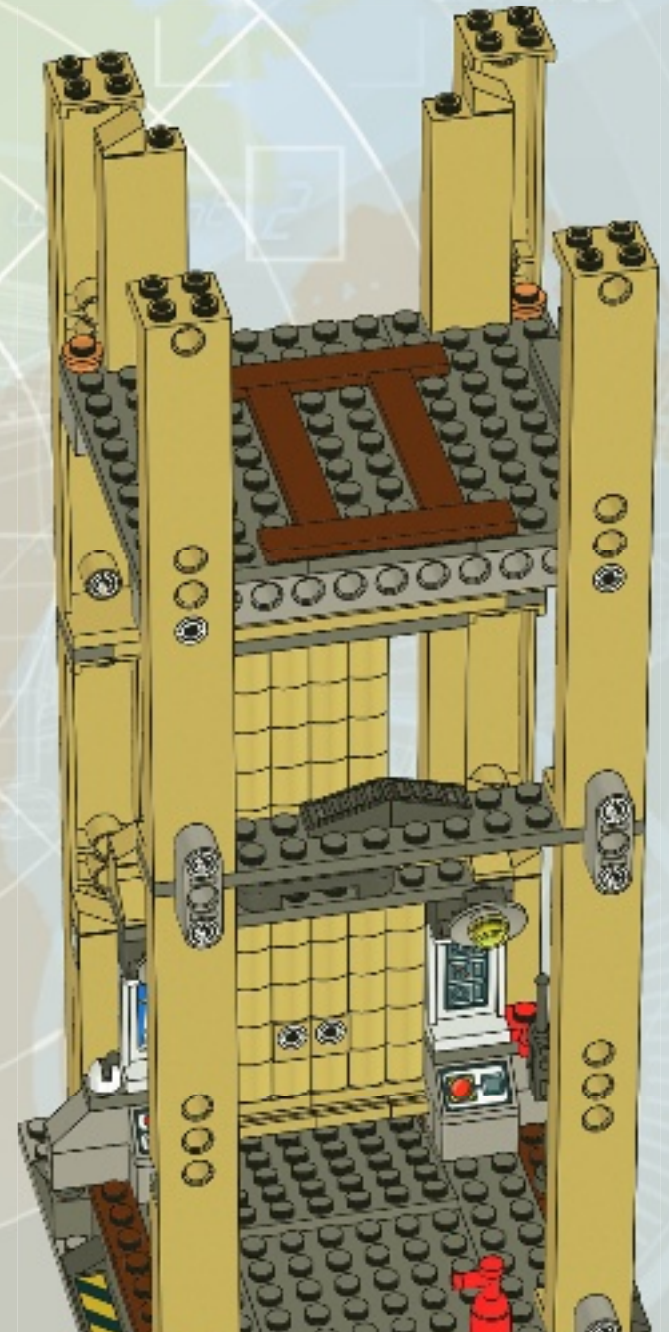



54

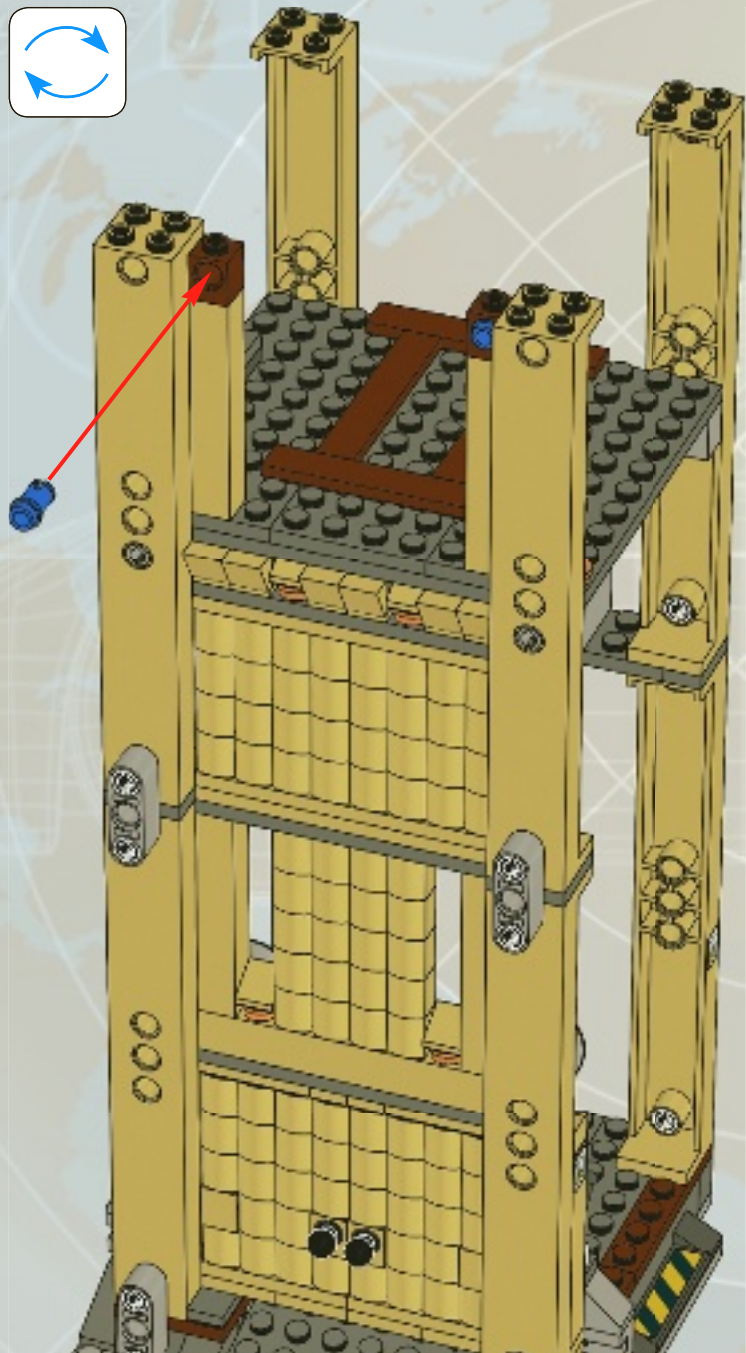

55

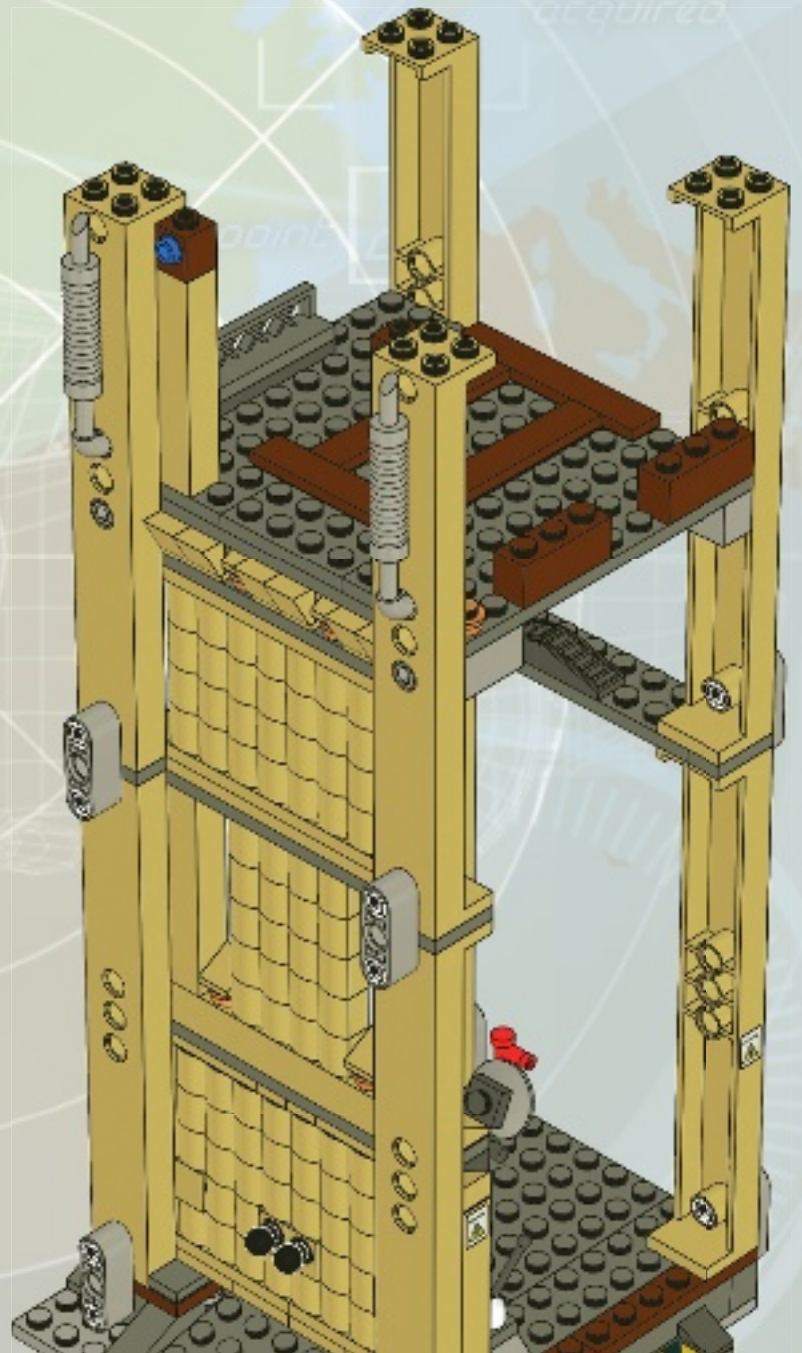



56

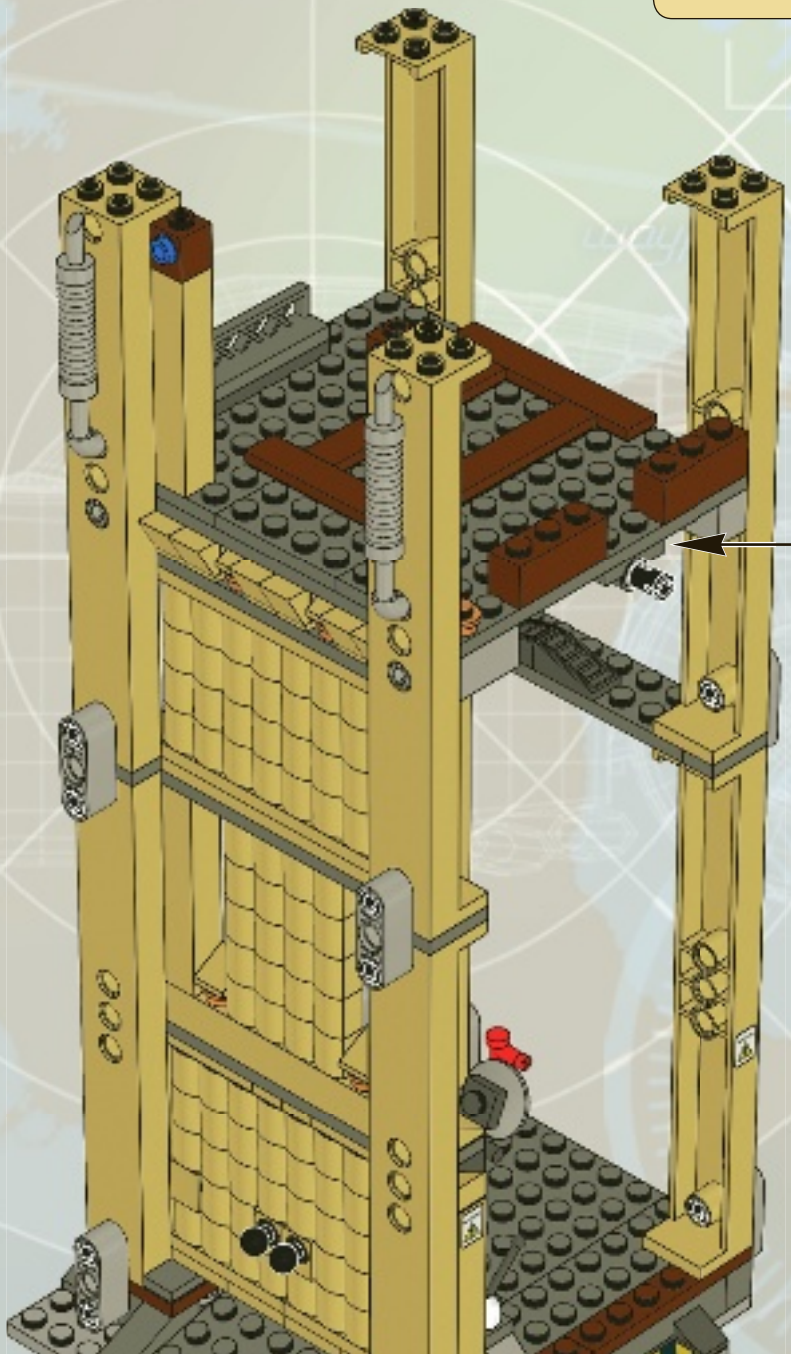
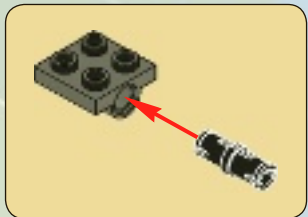

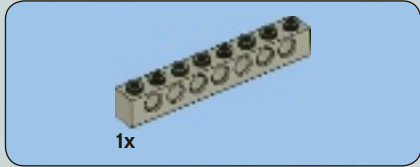

1

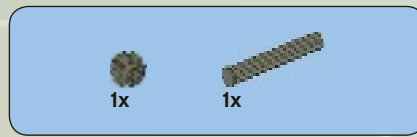

2

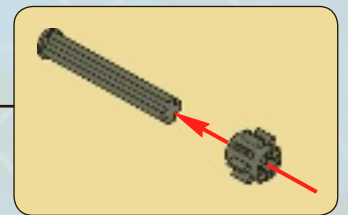

3

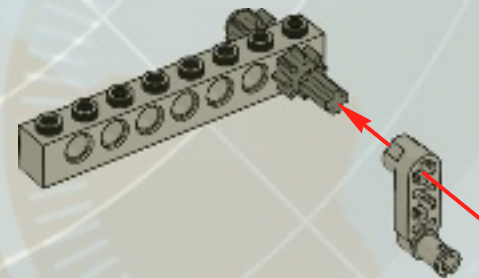



4 *waypoint 1*

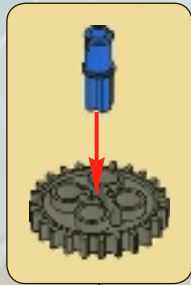

5



6

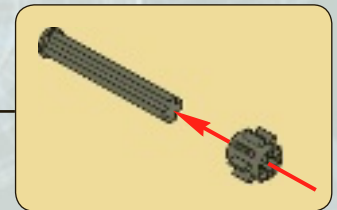

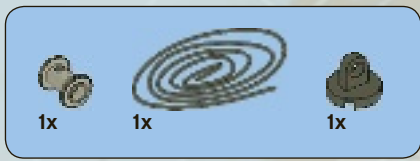

7

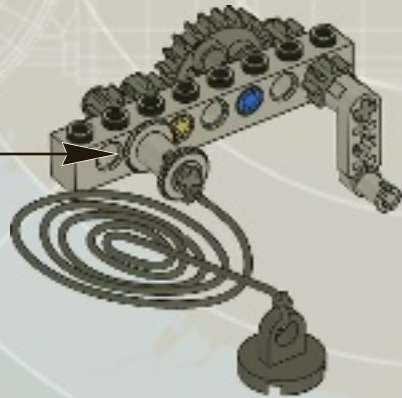
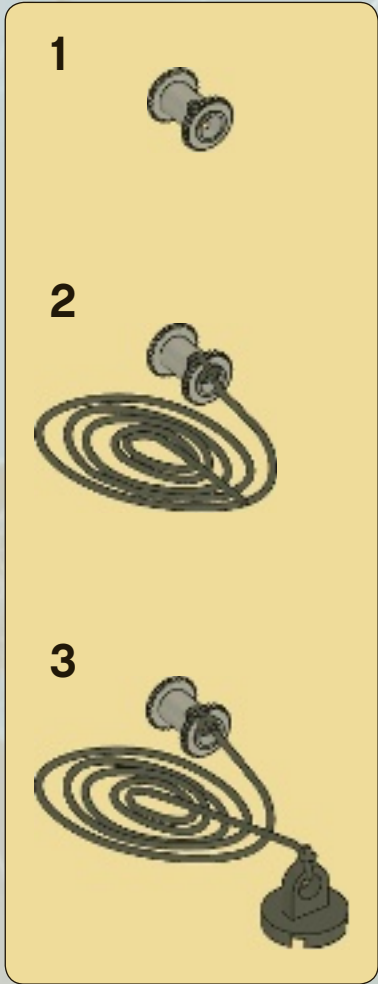

57

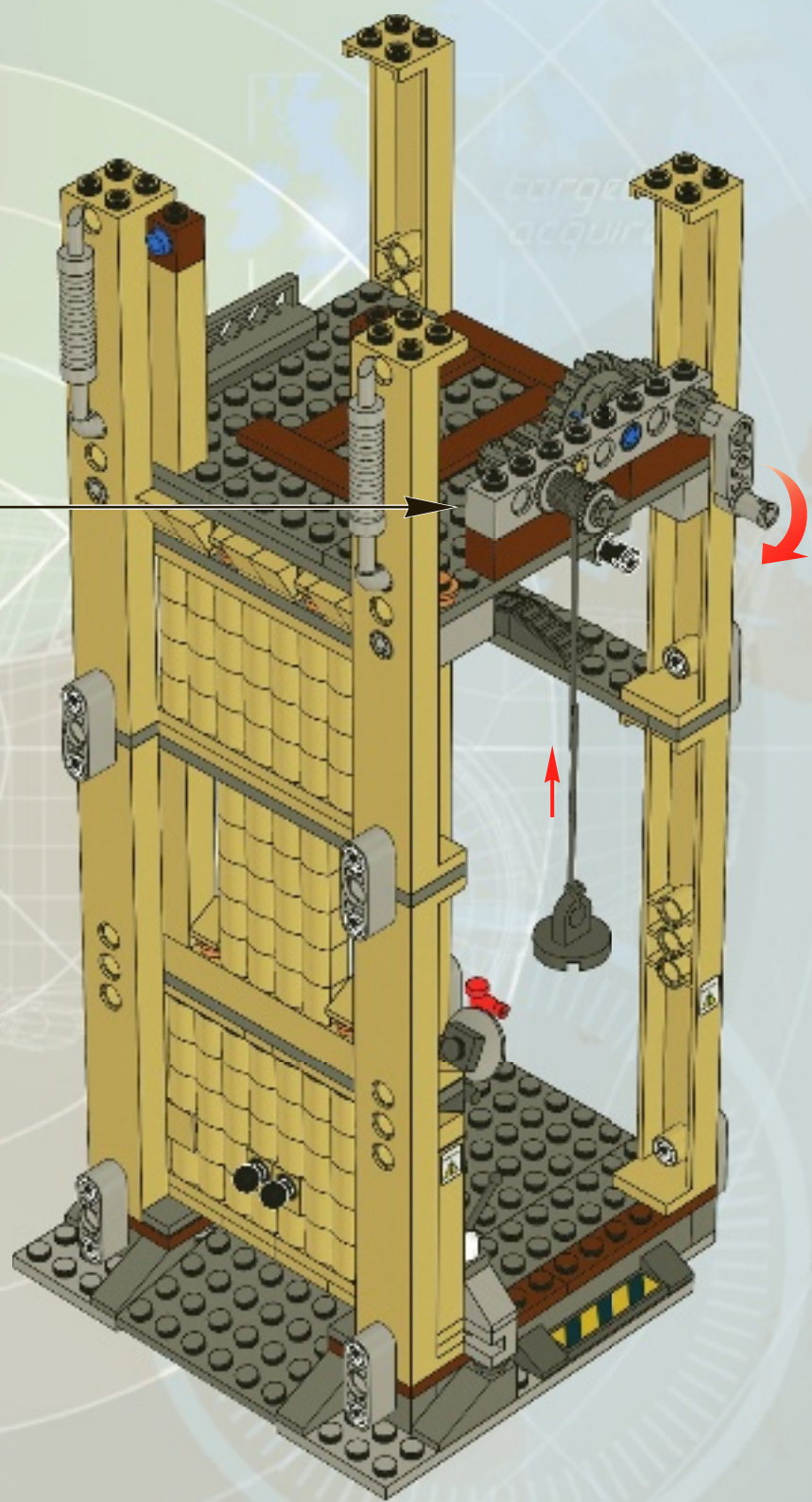

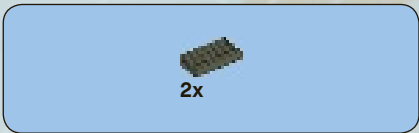

58

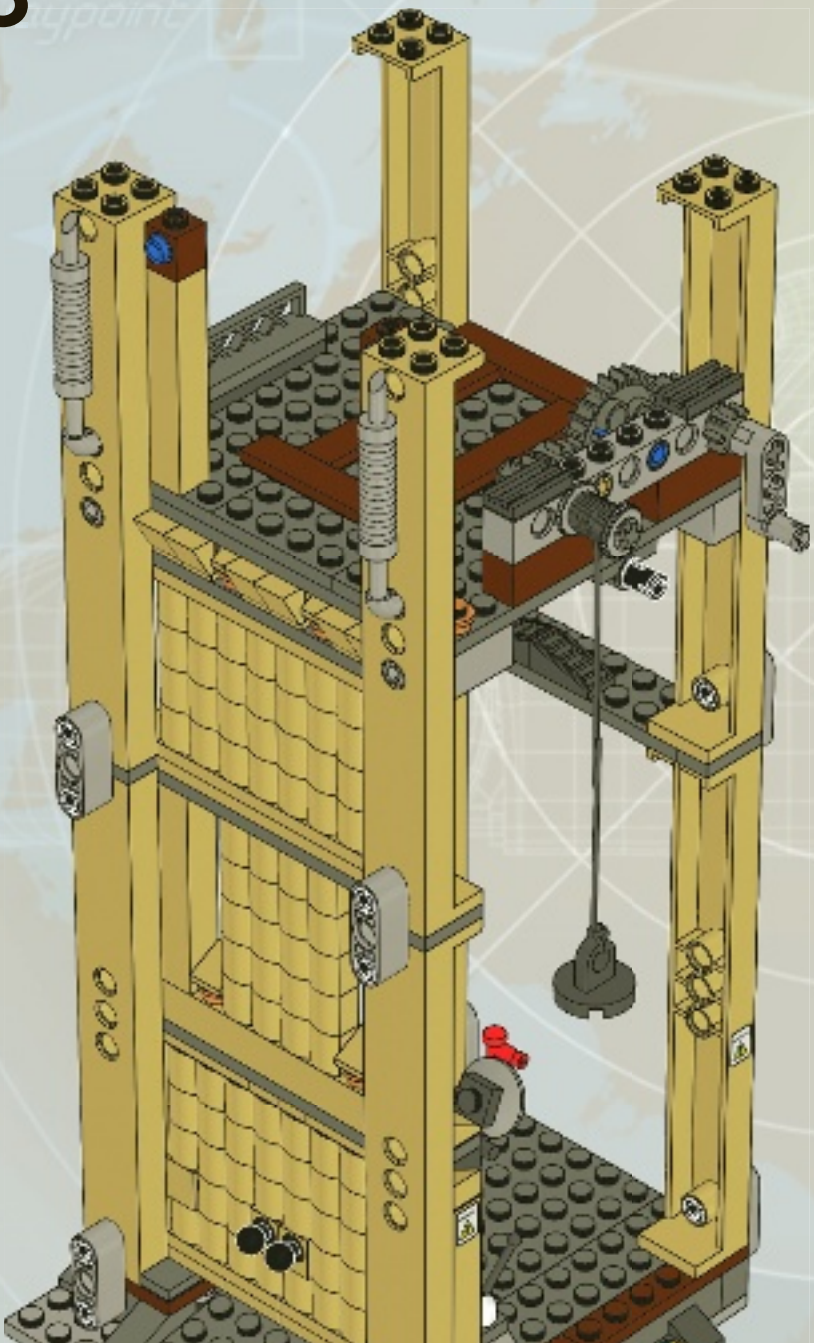

59

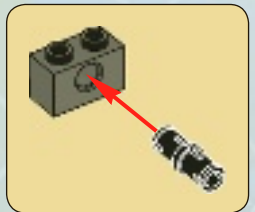
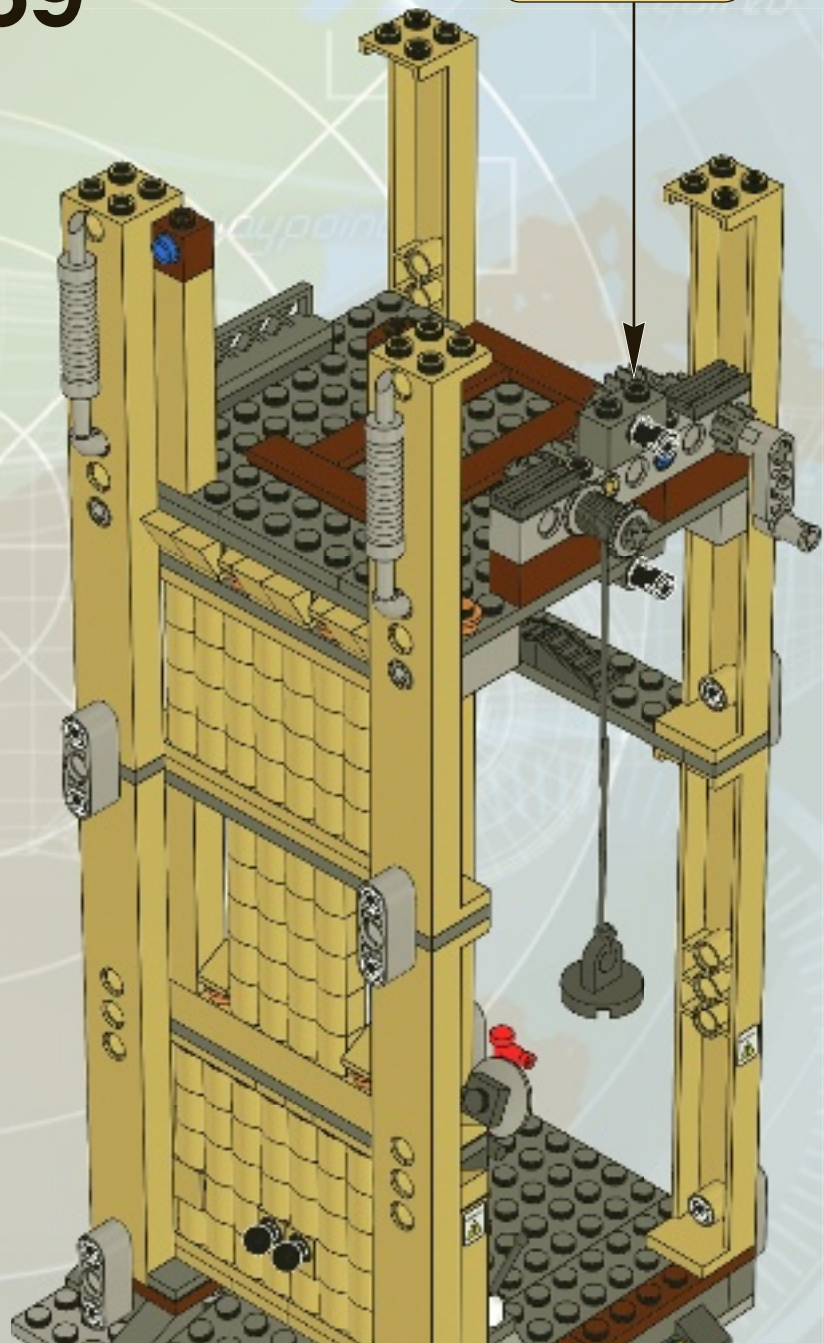



60

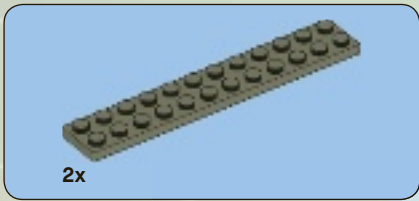
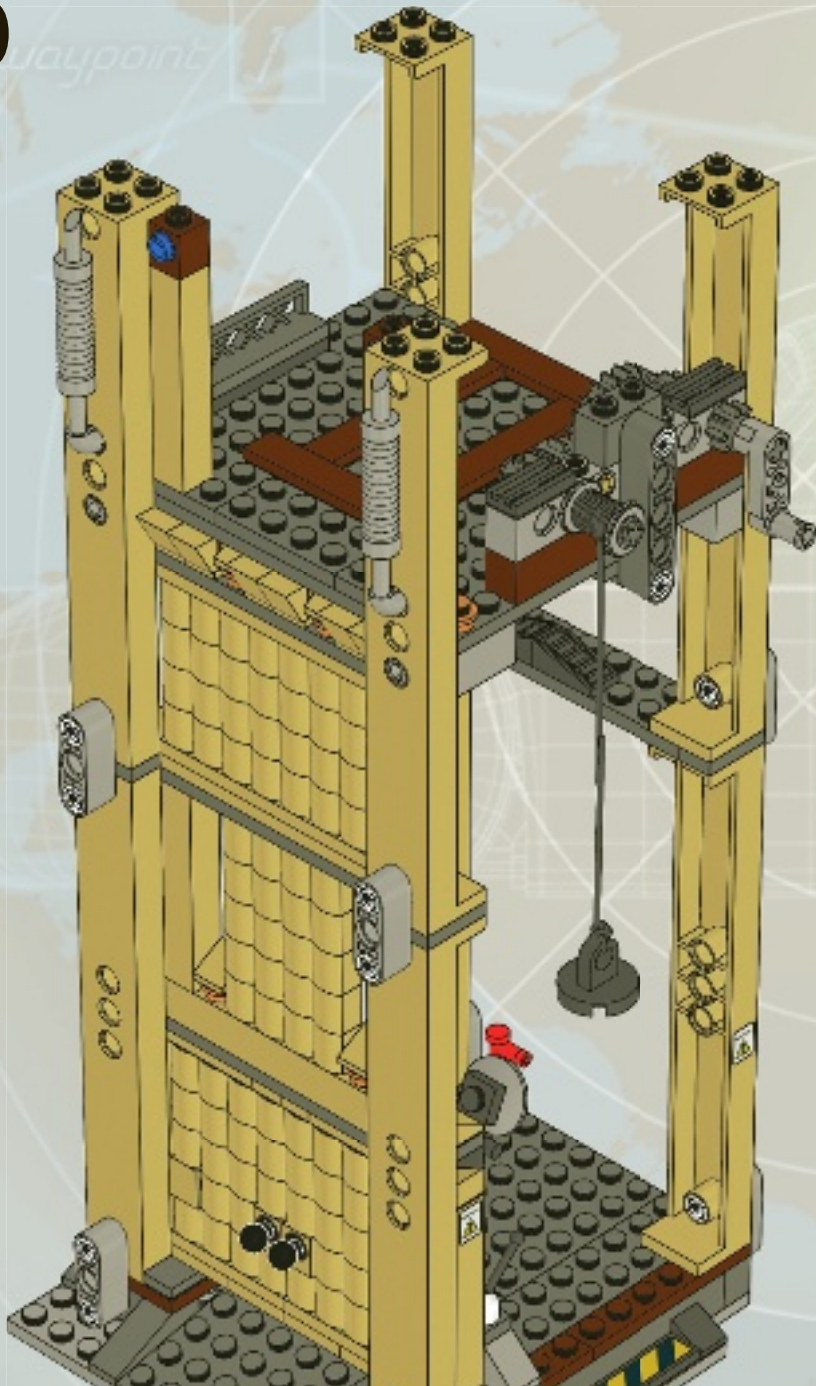

61

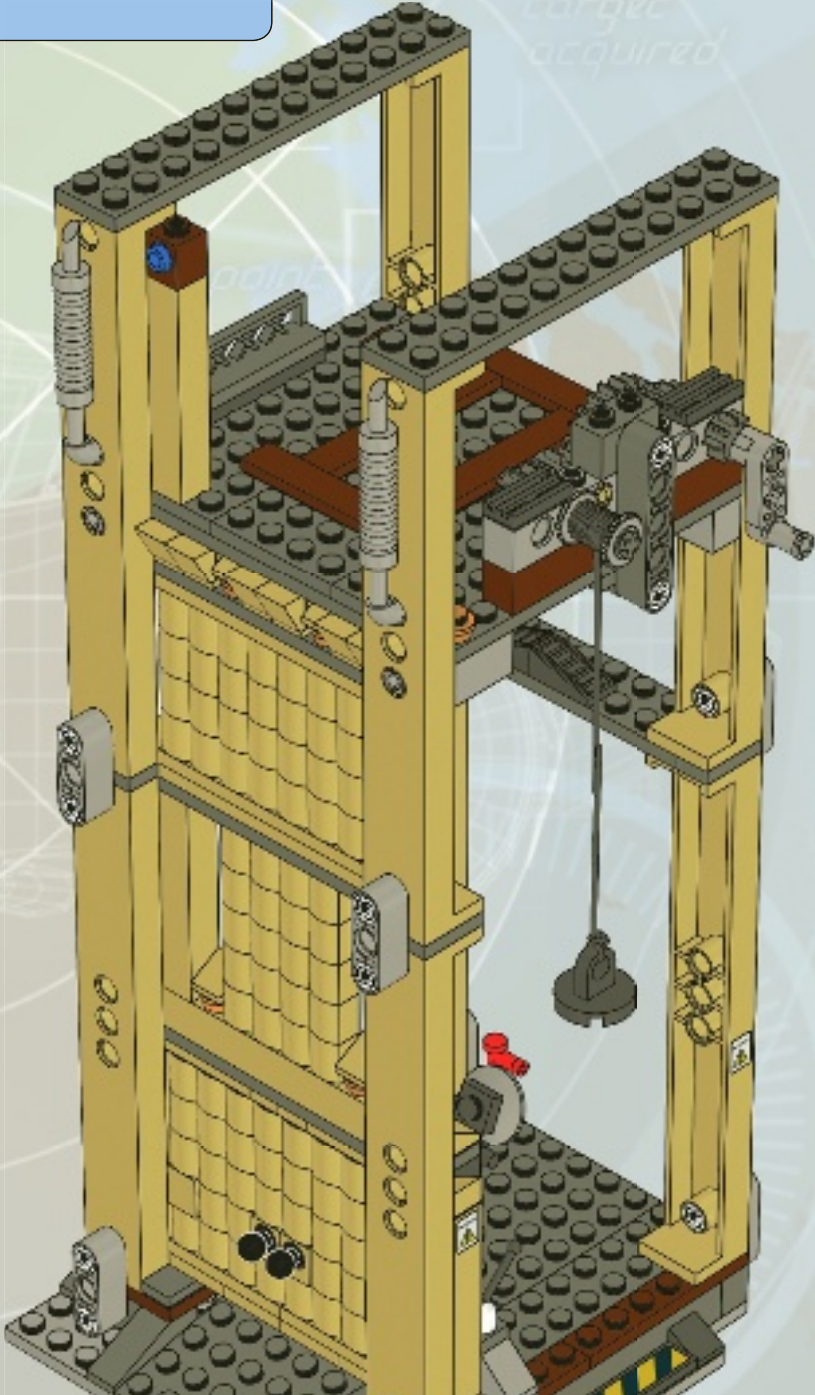



1

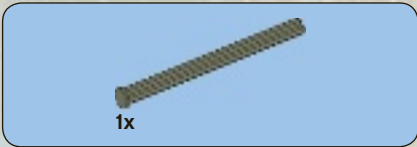
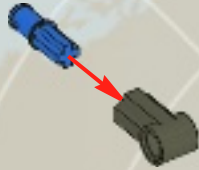

2

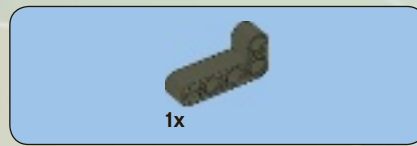
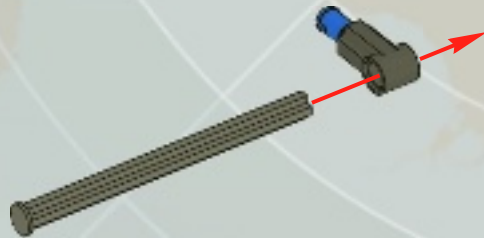

3

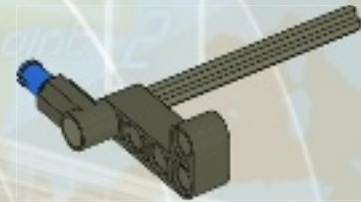

4



target acquired

waypoint 2



5

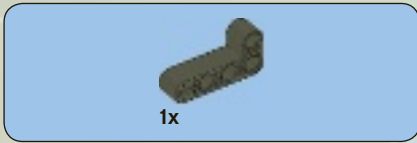
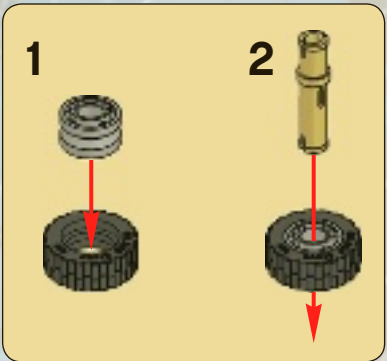

6

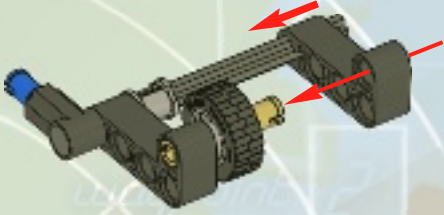

target acquired



7

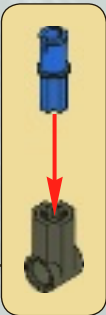

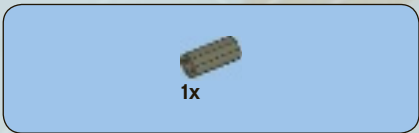

8

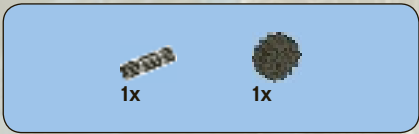

9

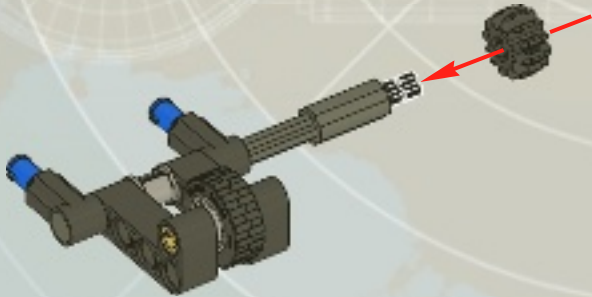

62

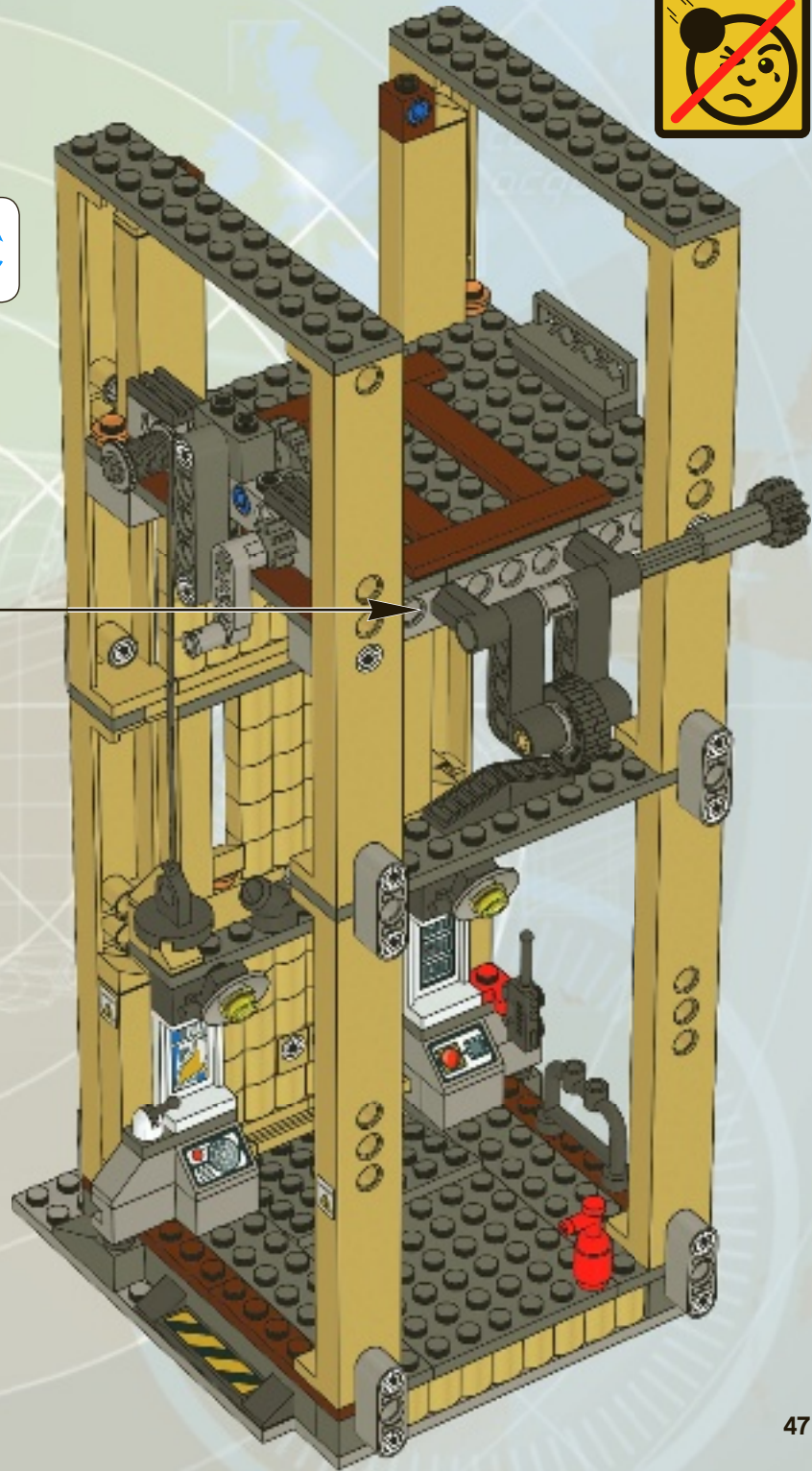
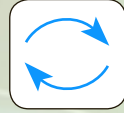



5

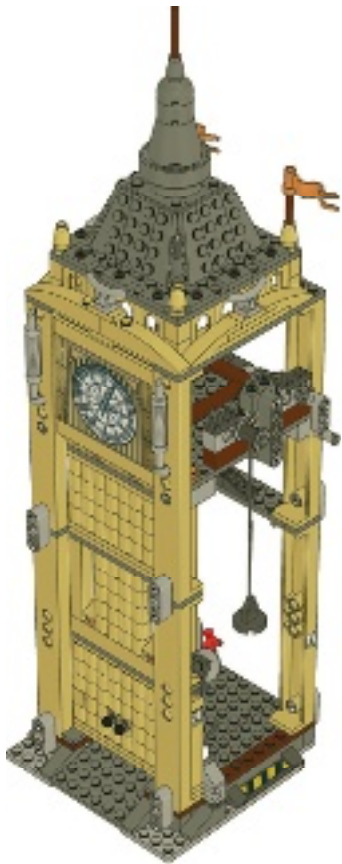

63

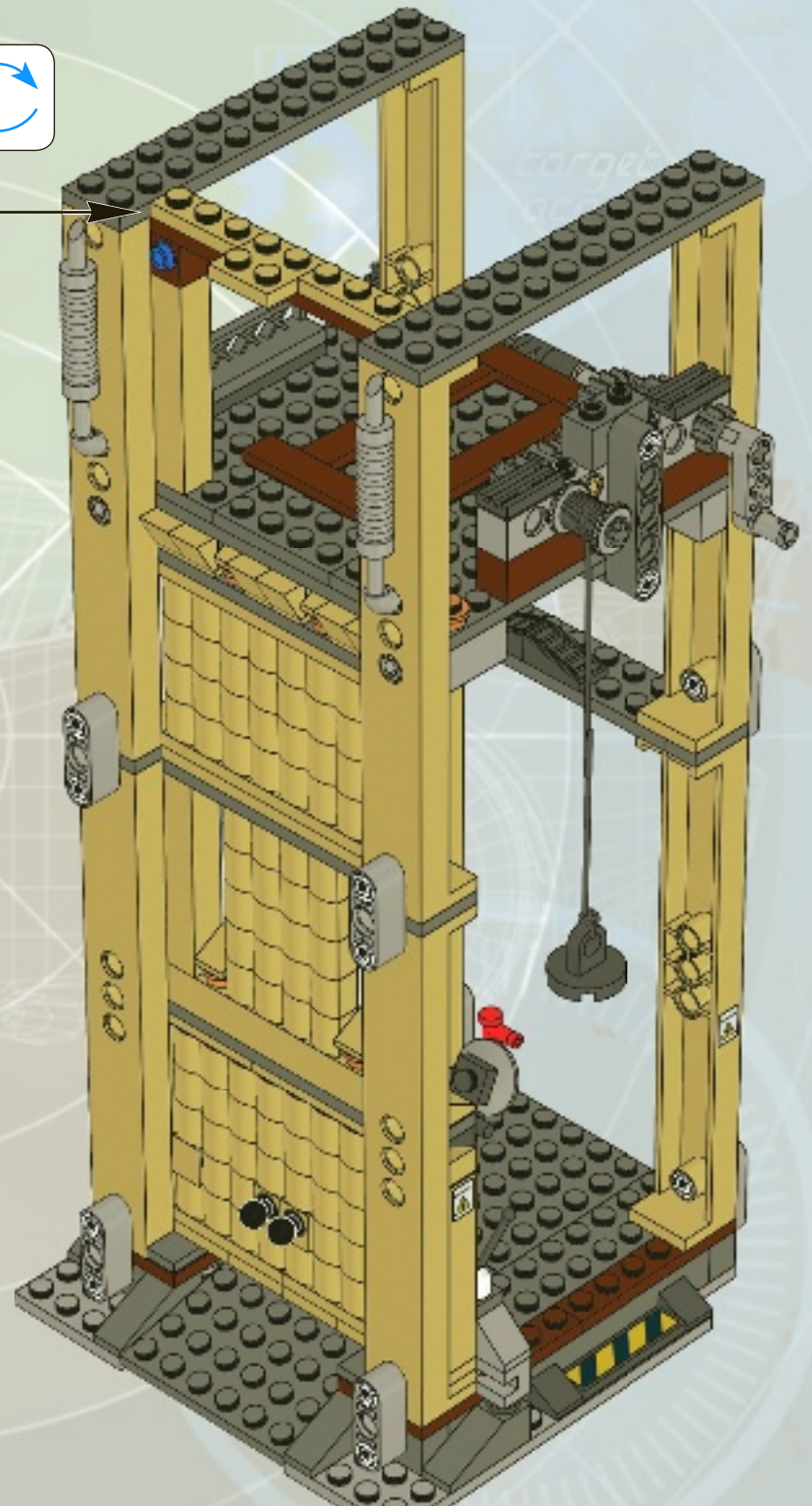
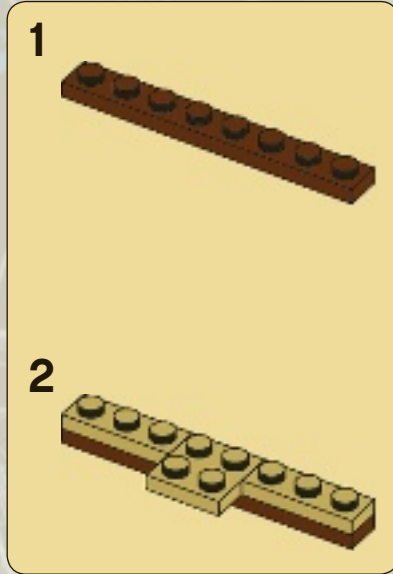
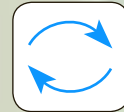

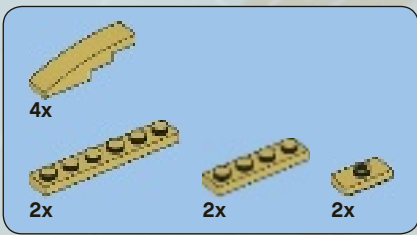

64

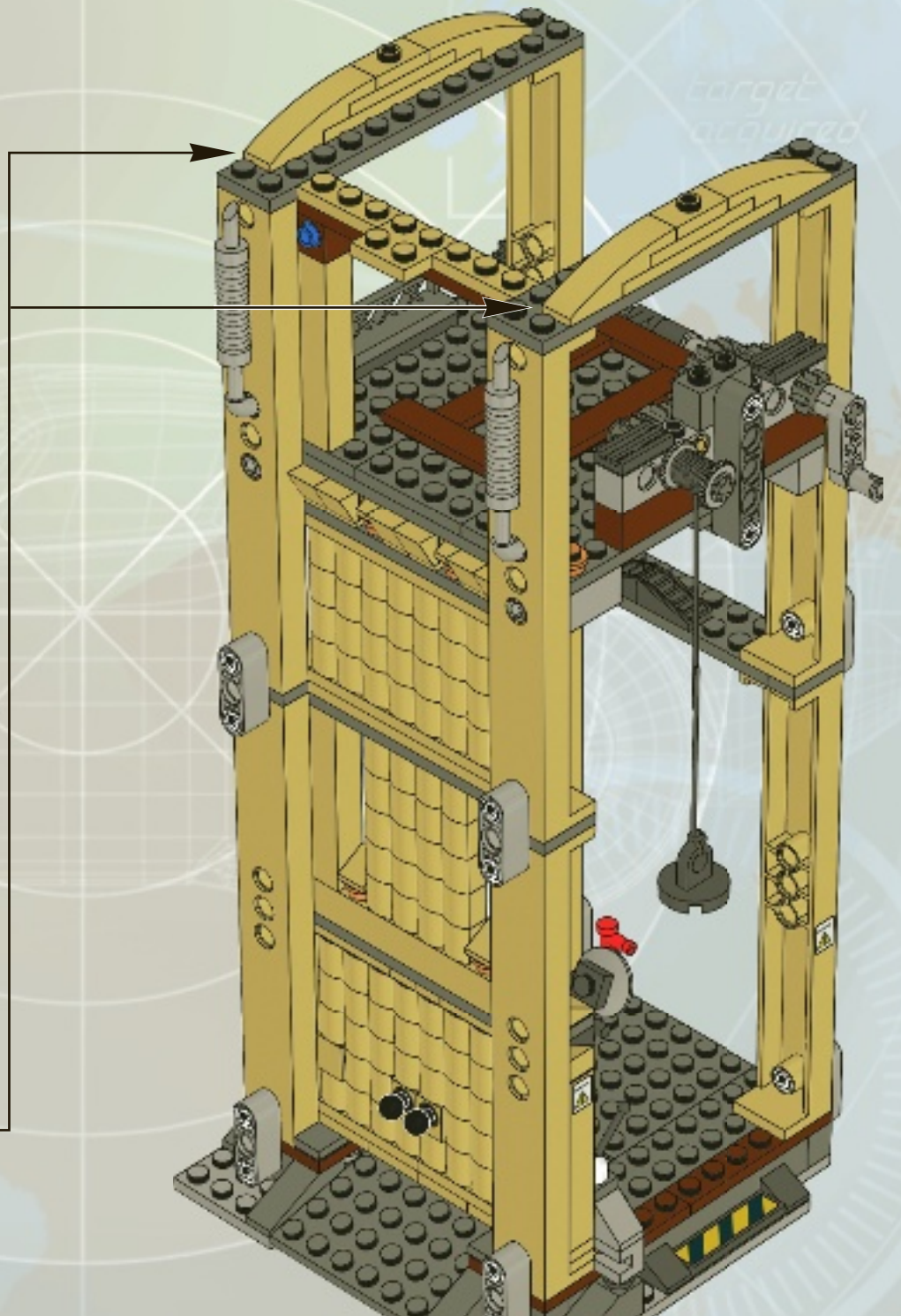
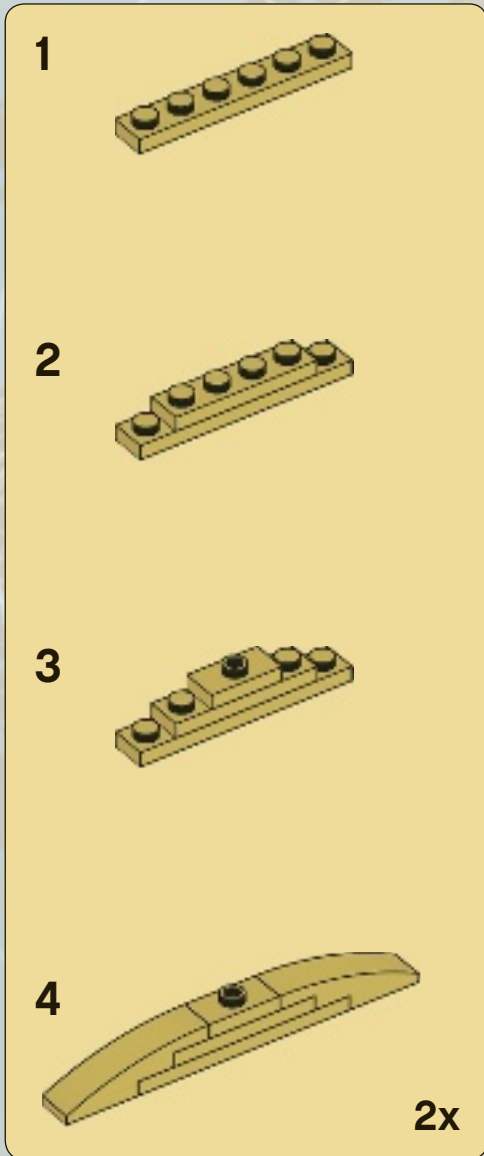

target
acquired



4x

65

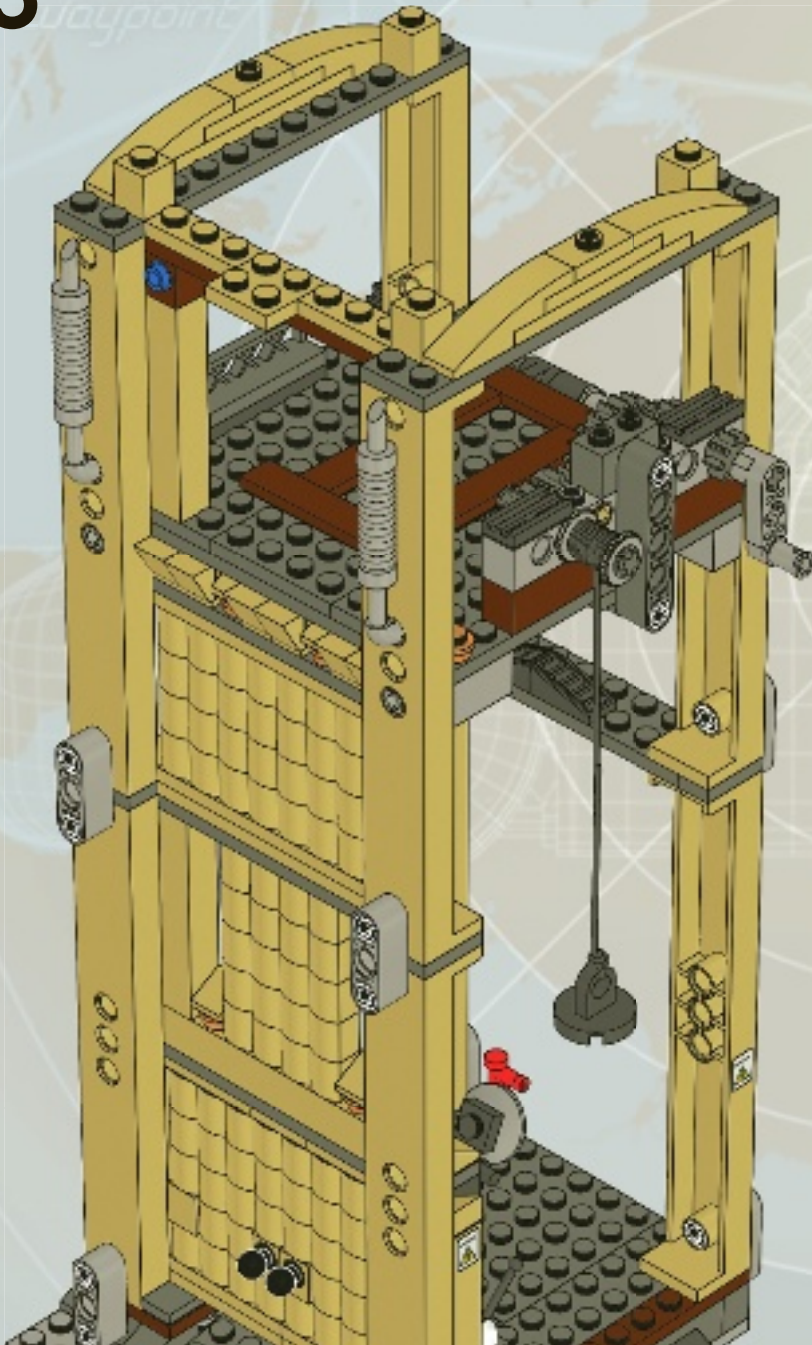

2x

66

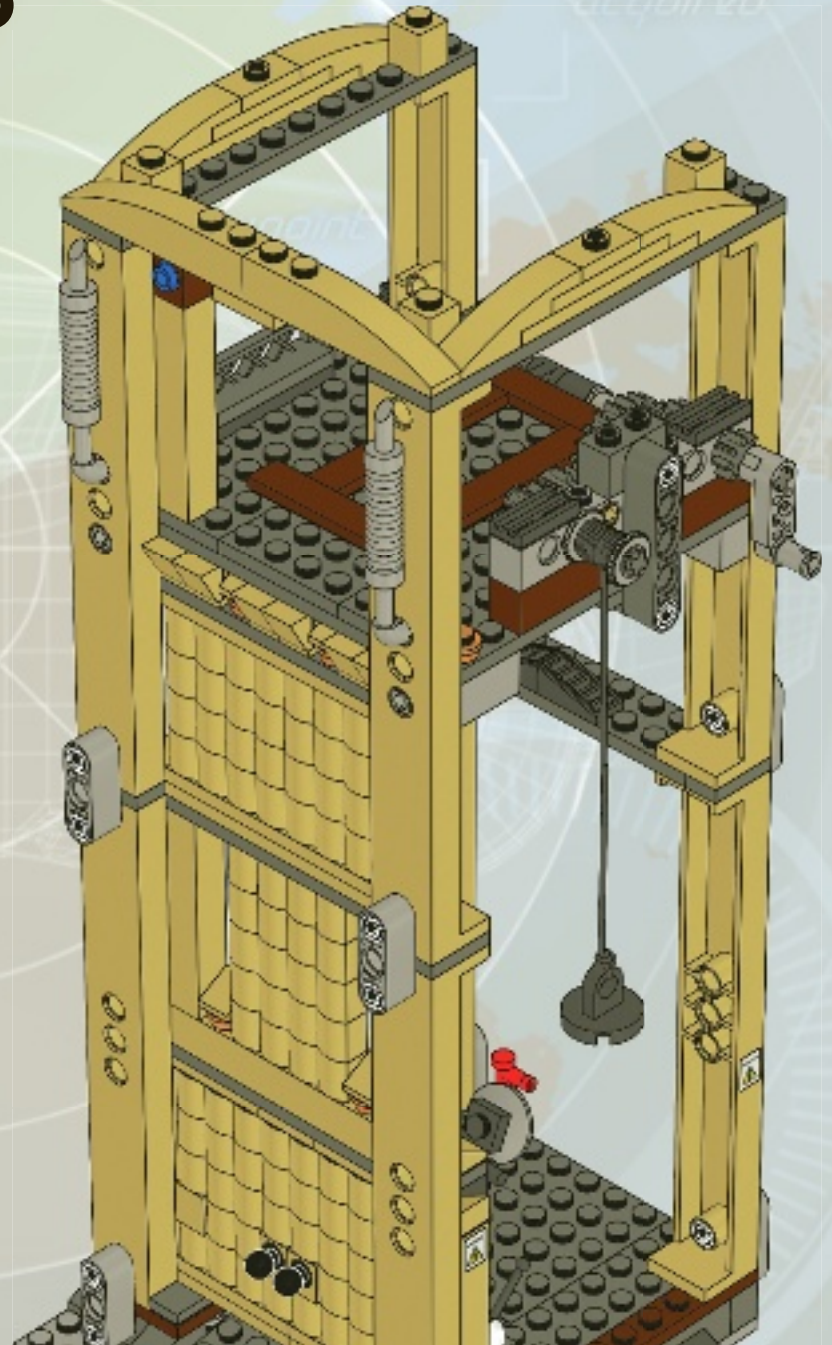

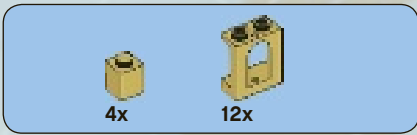

67

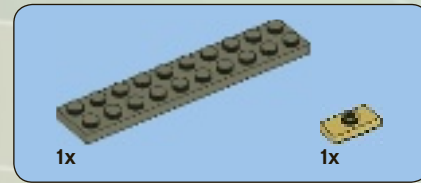
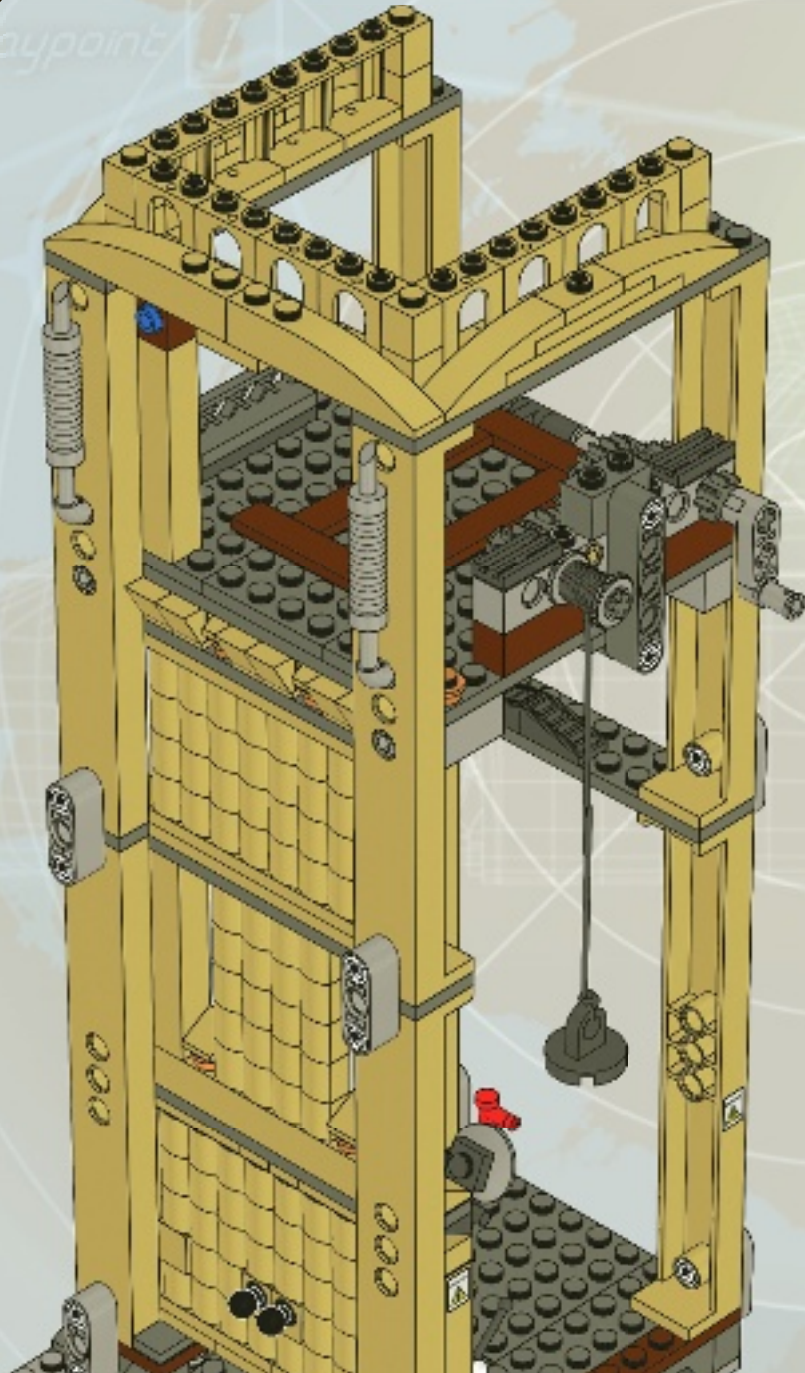

68

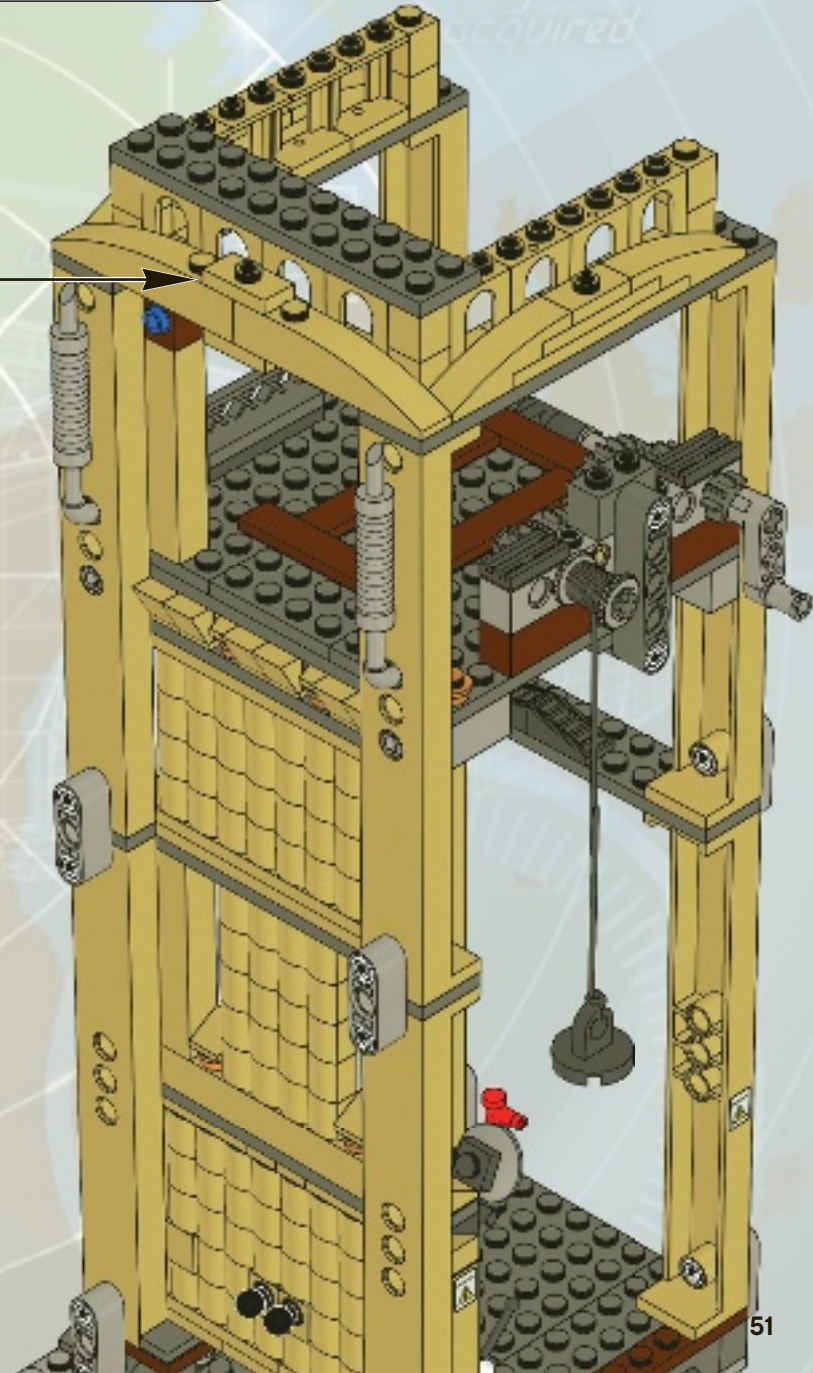

target
acquired

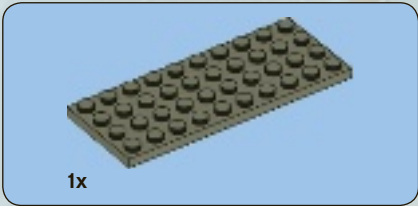

1x

1



1x

2

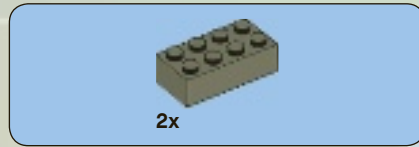
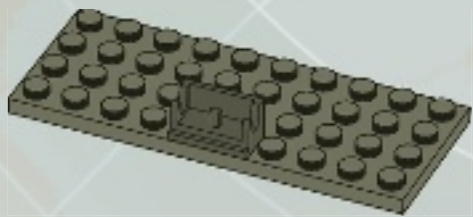

2x

3

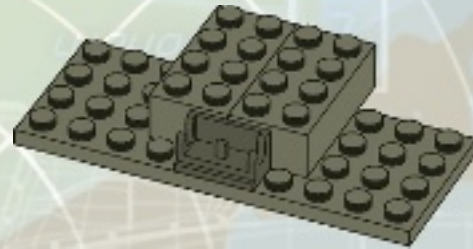

*target
acquired*

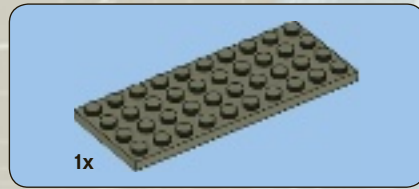

1x

4

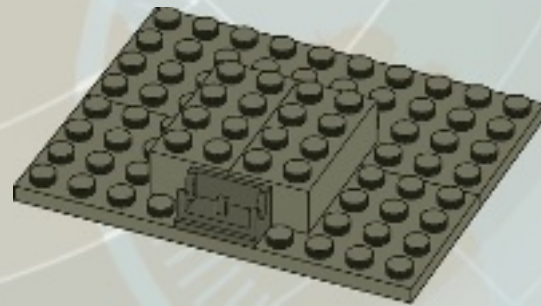



2x

5

waypoint 1

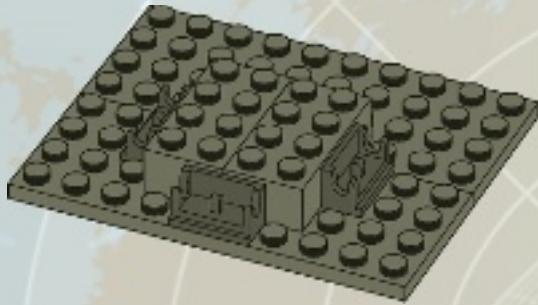

4x



2x

6



2x

7

waypoint 2

target acquired

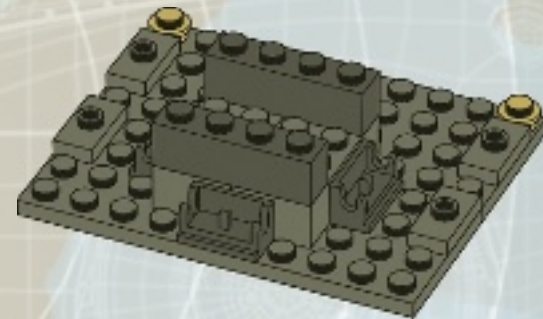



1x

8

waypoint 1

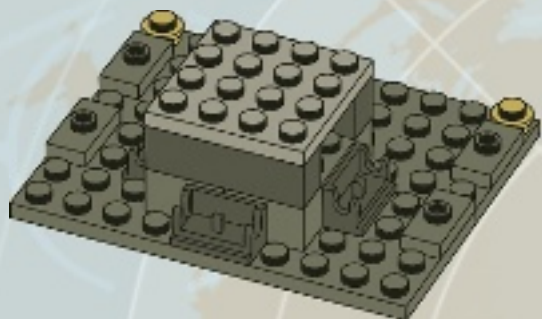

2x



1x

9

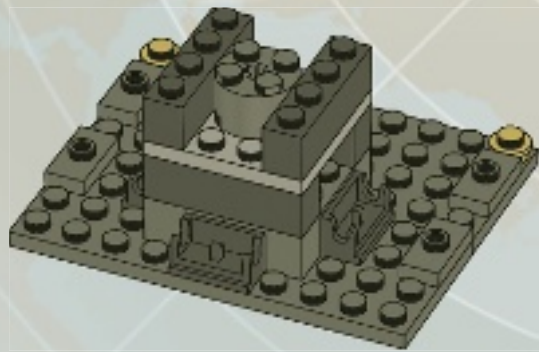

2x



2x

10

target acquired

waypoint 2

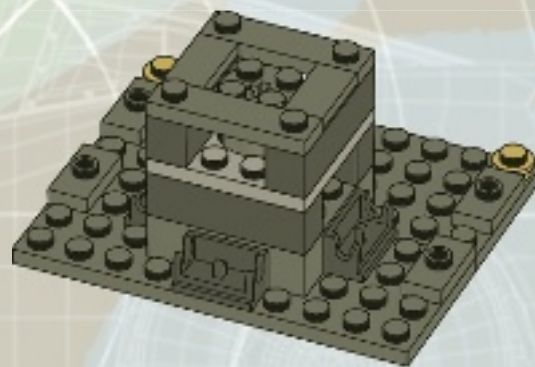

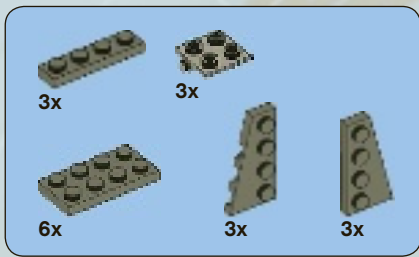

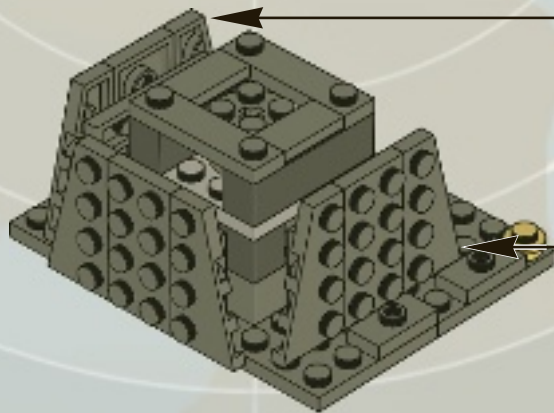
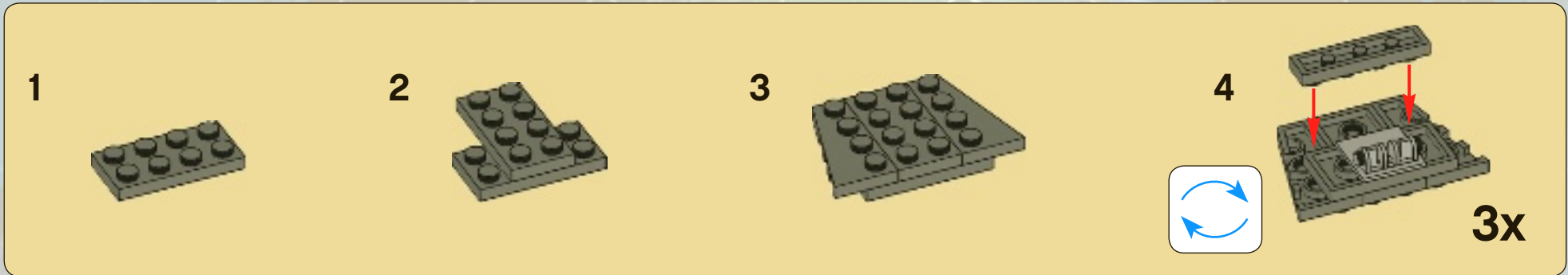

11

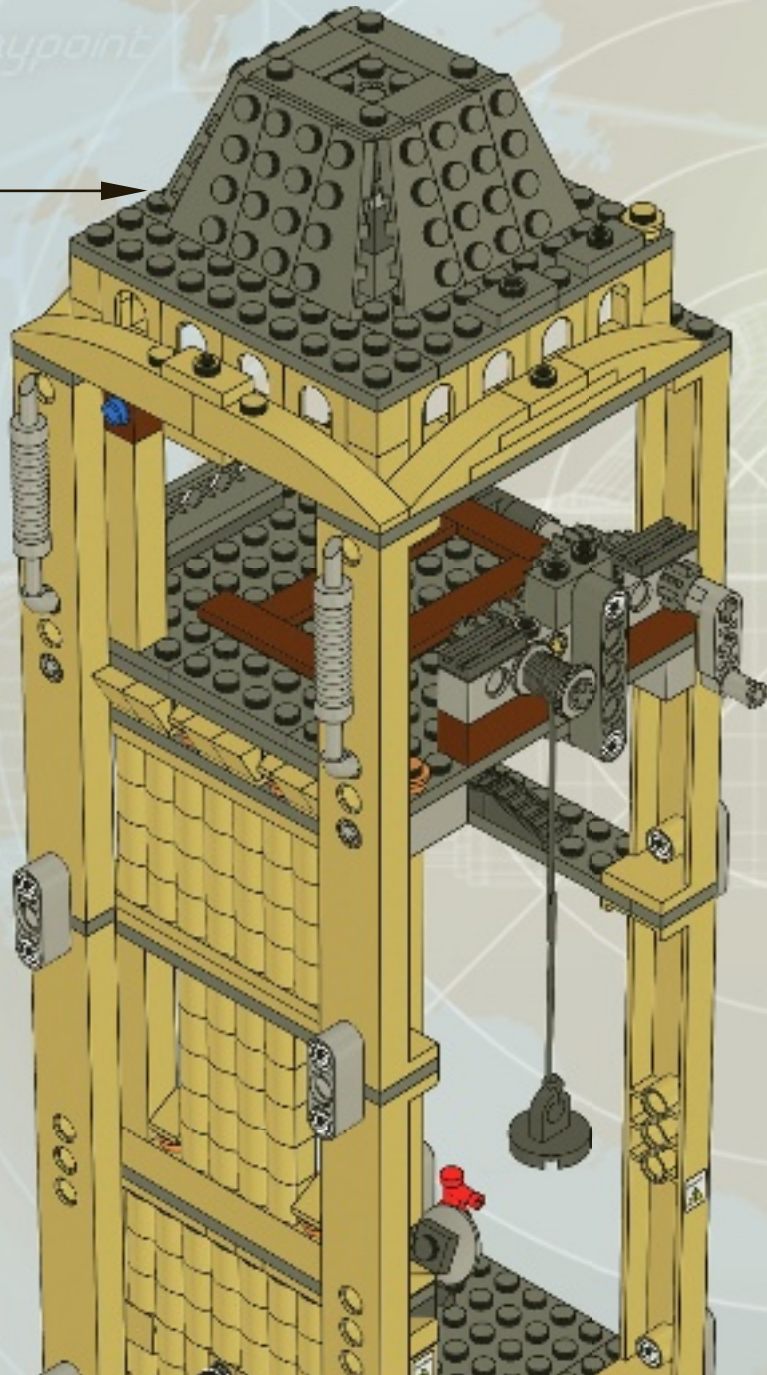

69



2x  5x 

70

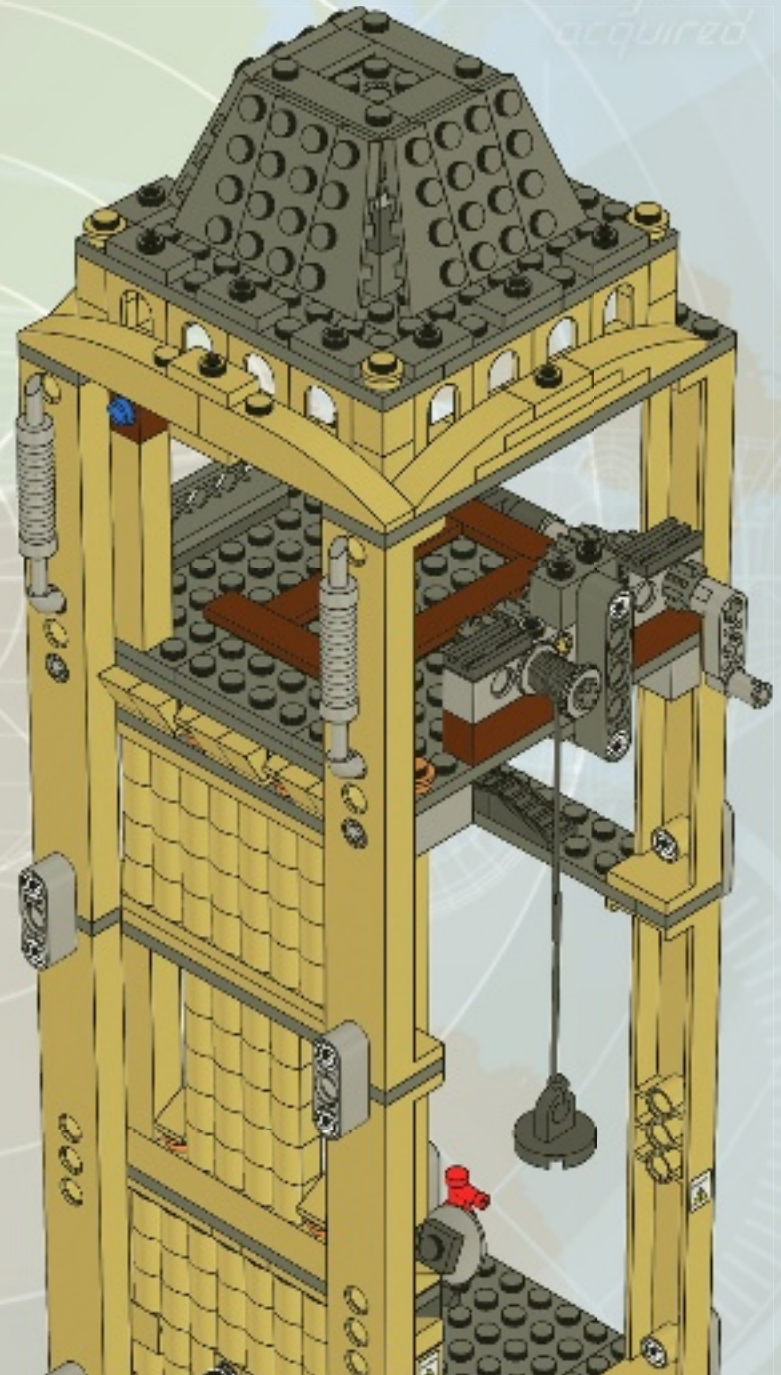

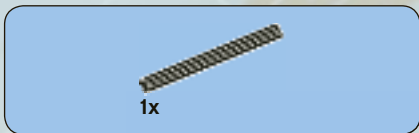

71

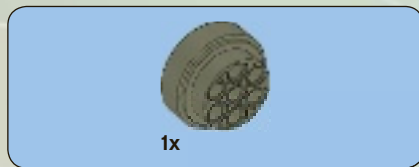
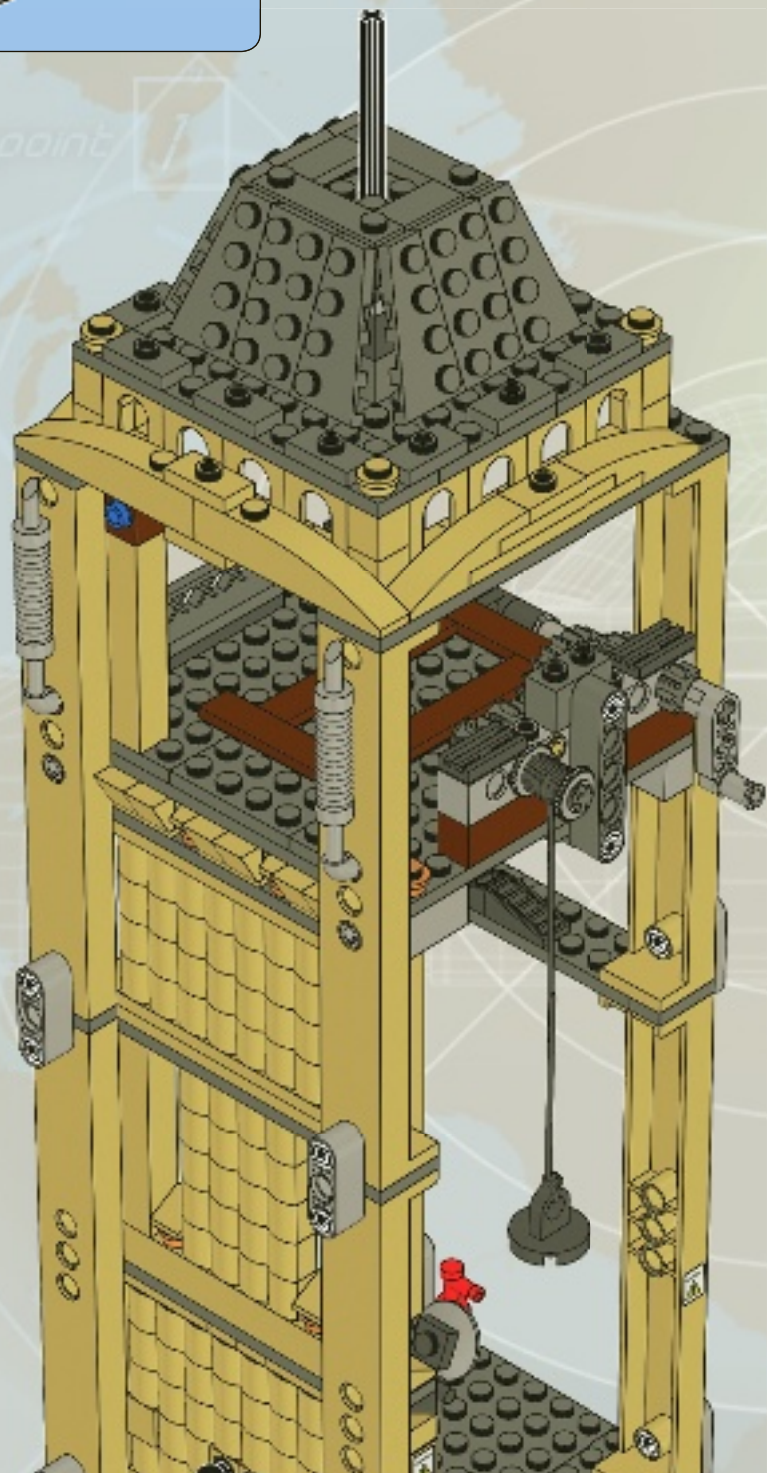

72

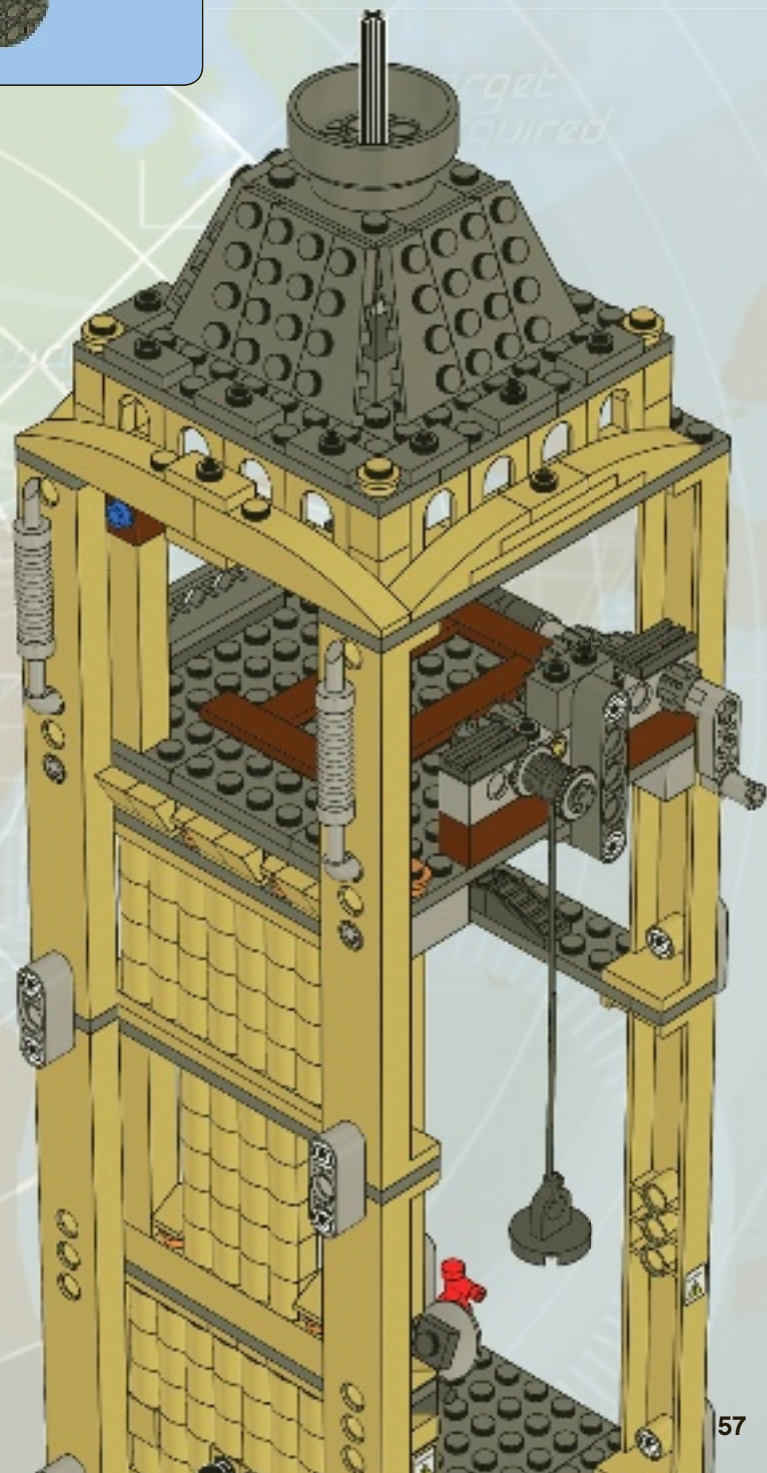

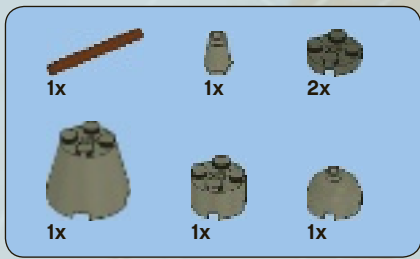

73

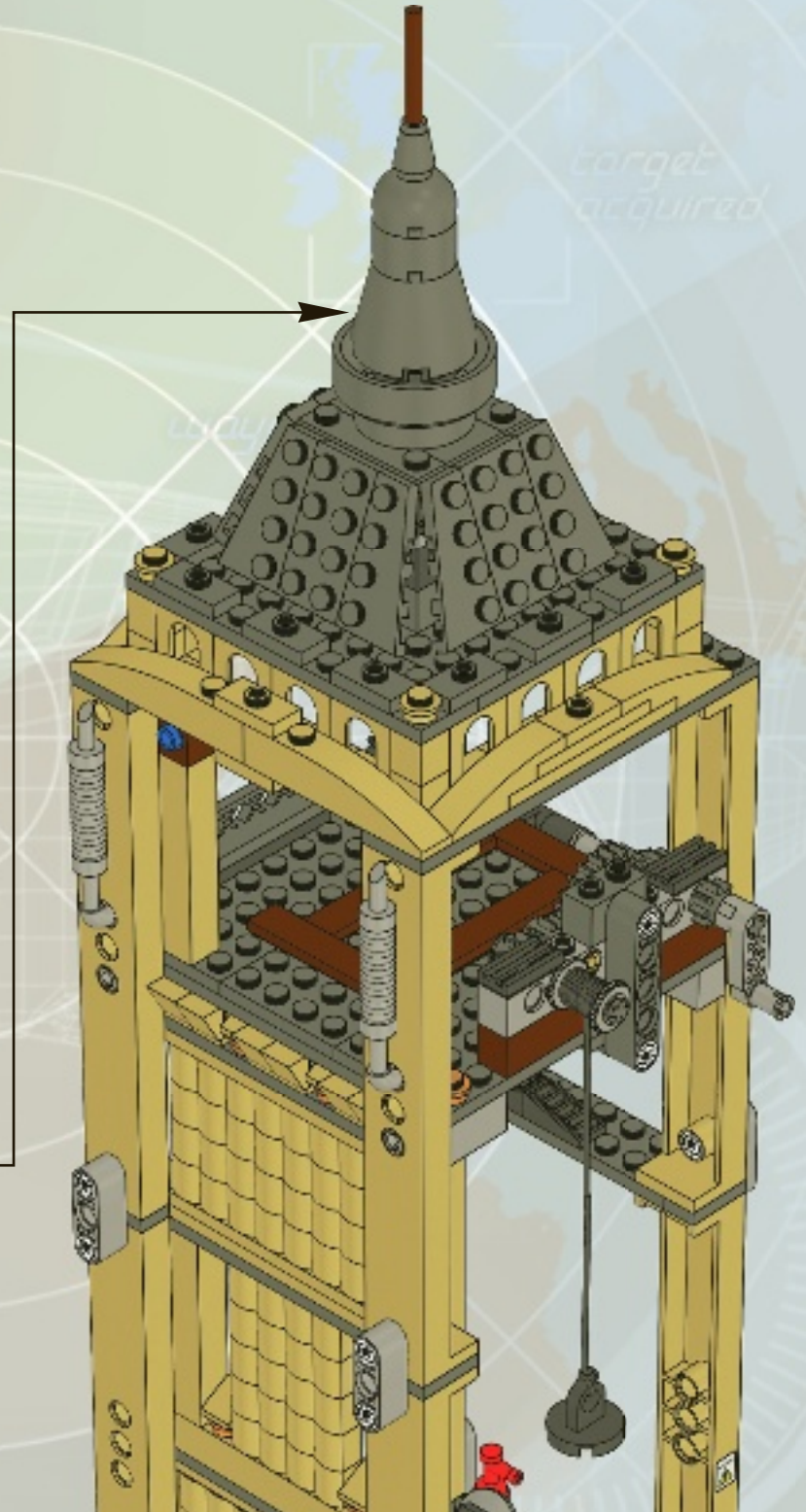
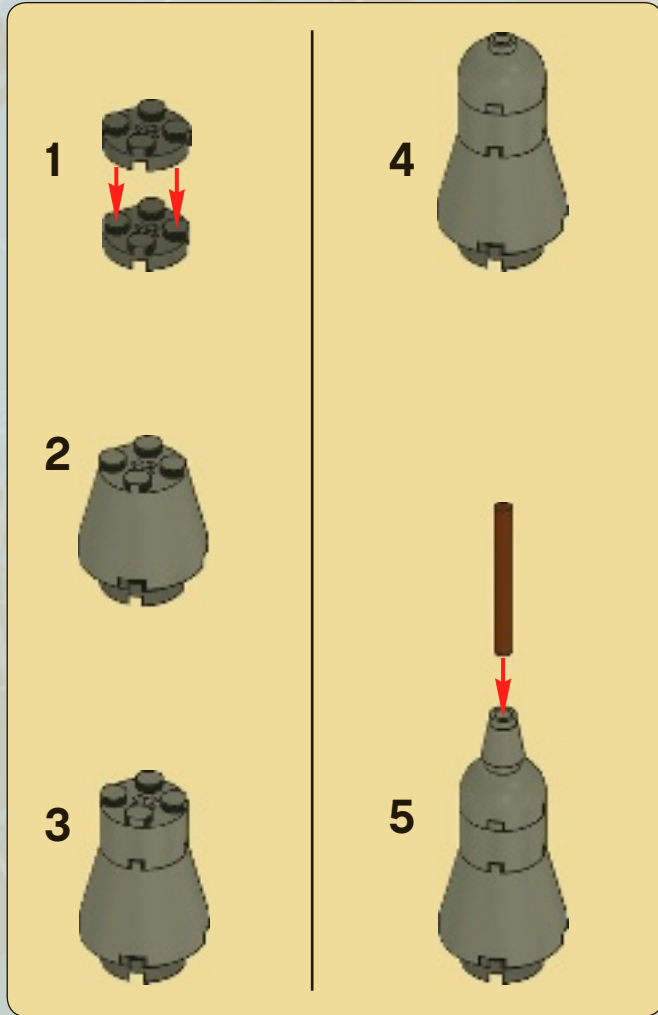



4x

74

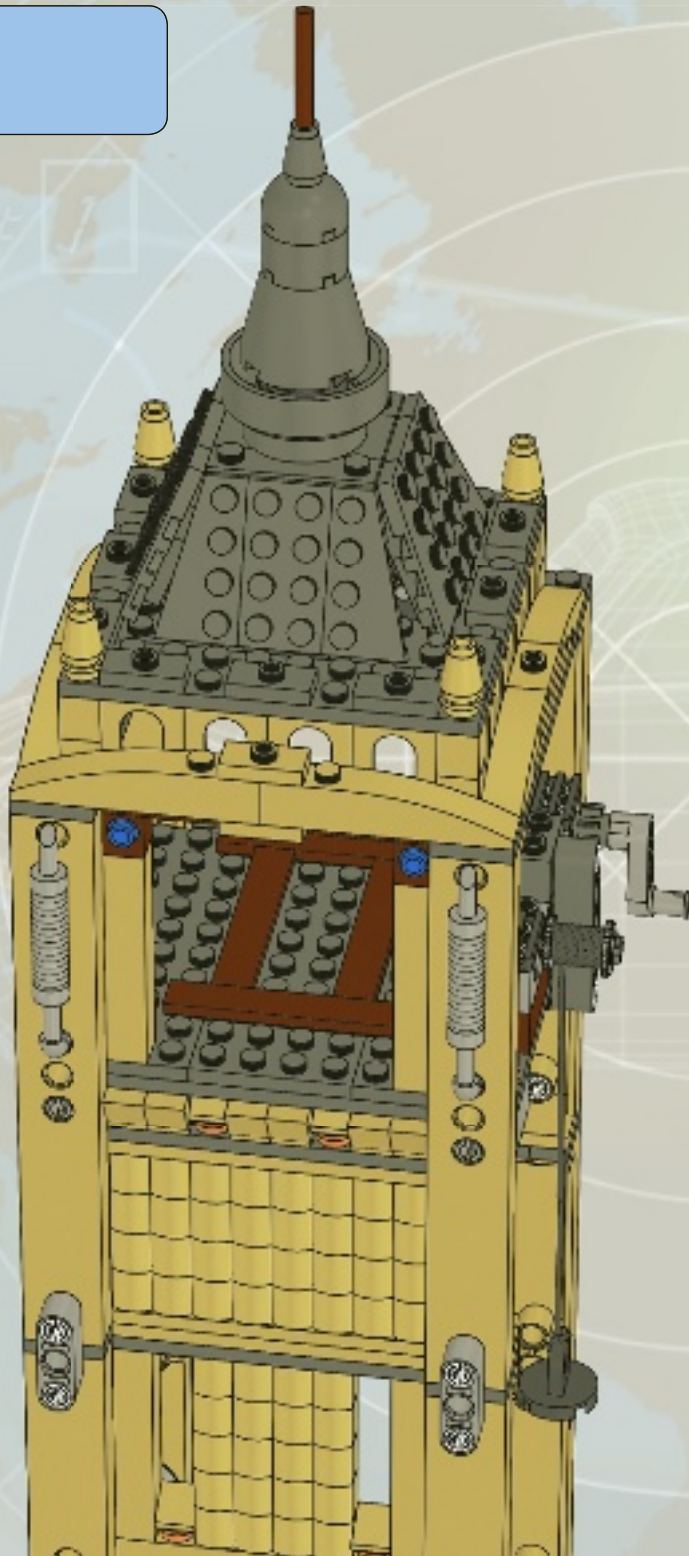

2x



2x

75

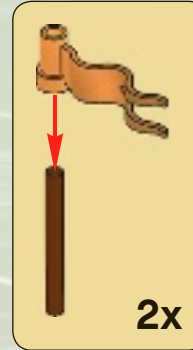

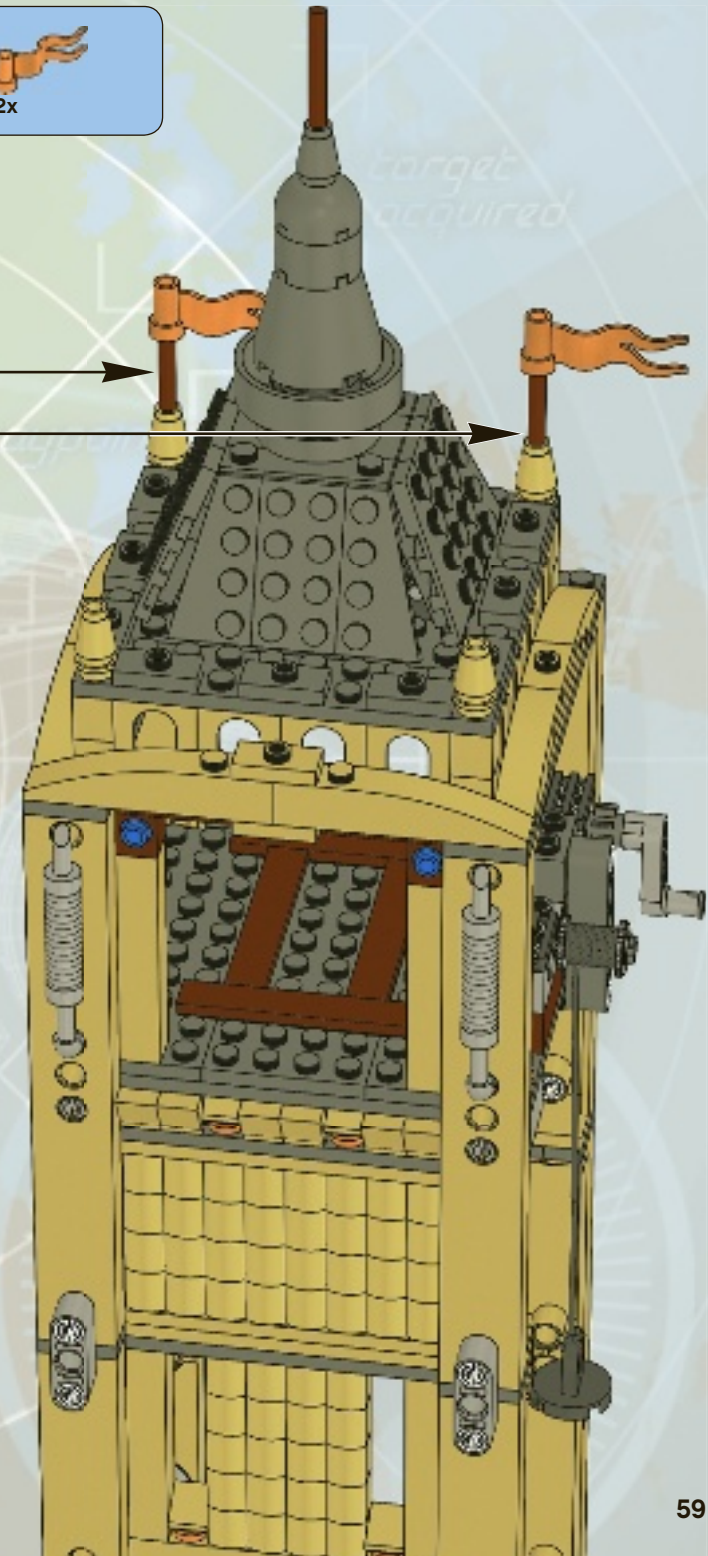

2x



3x  3x 

76

↓
 3x

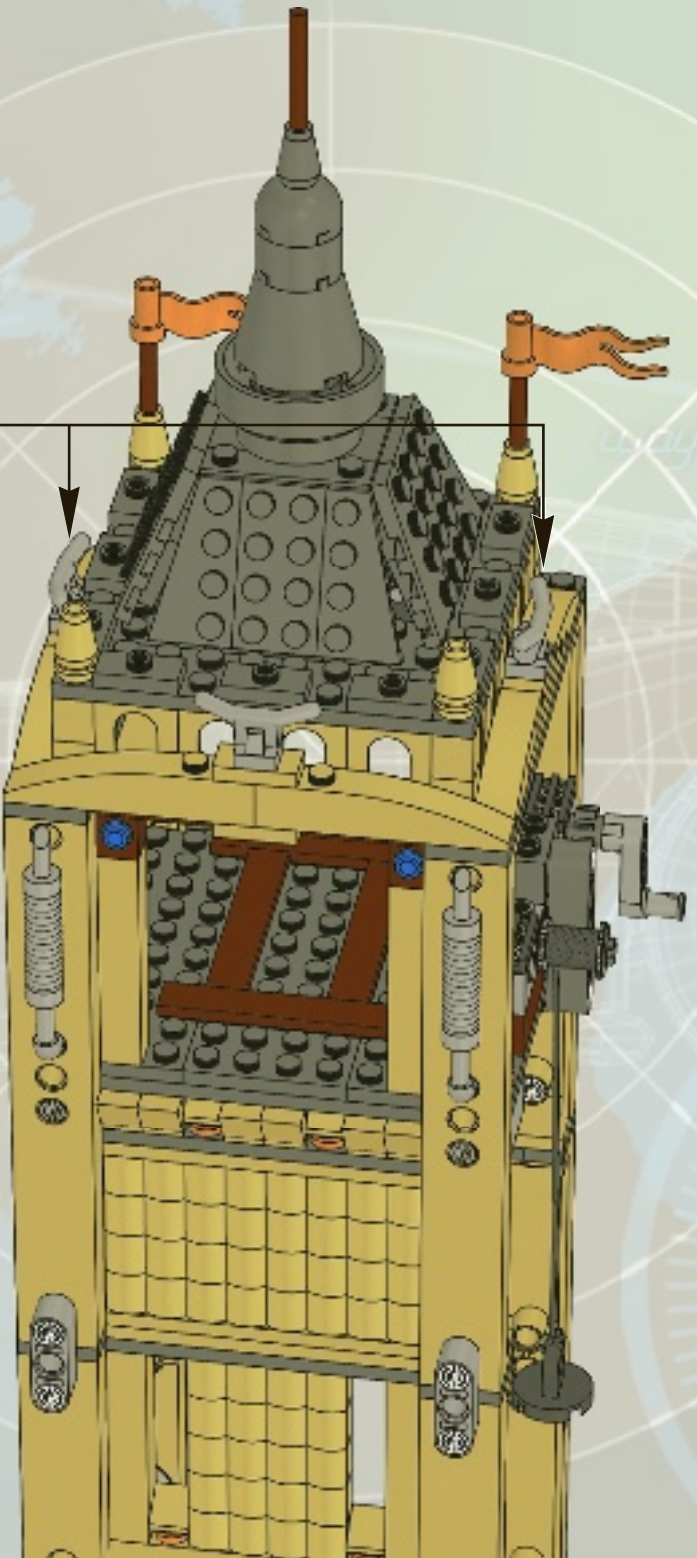

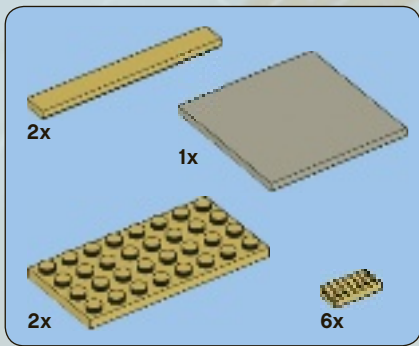

77

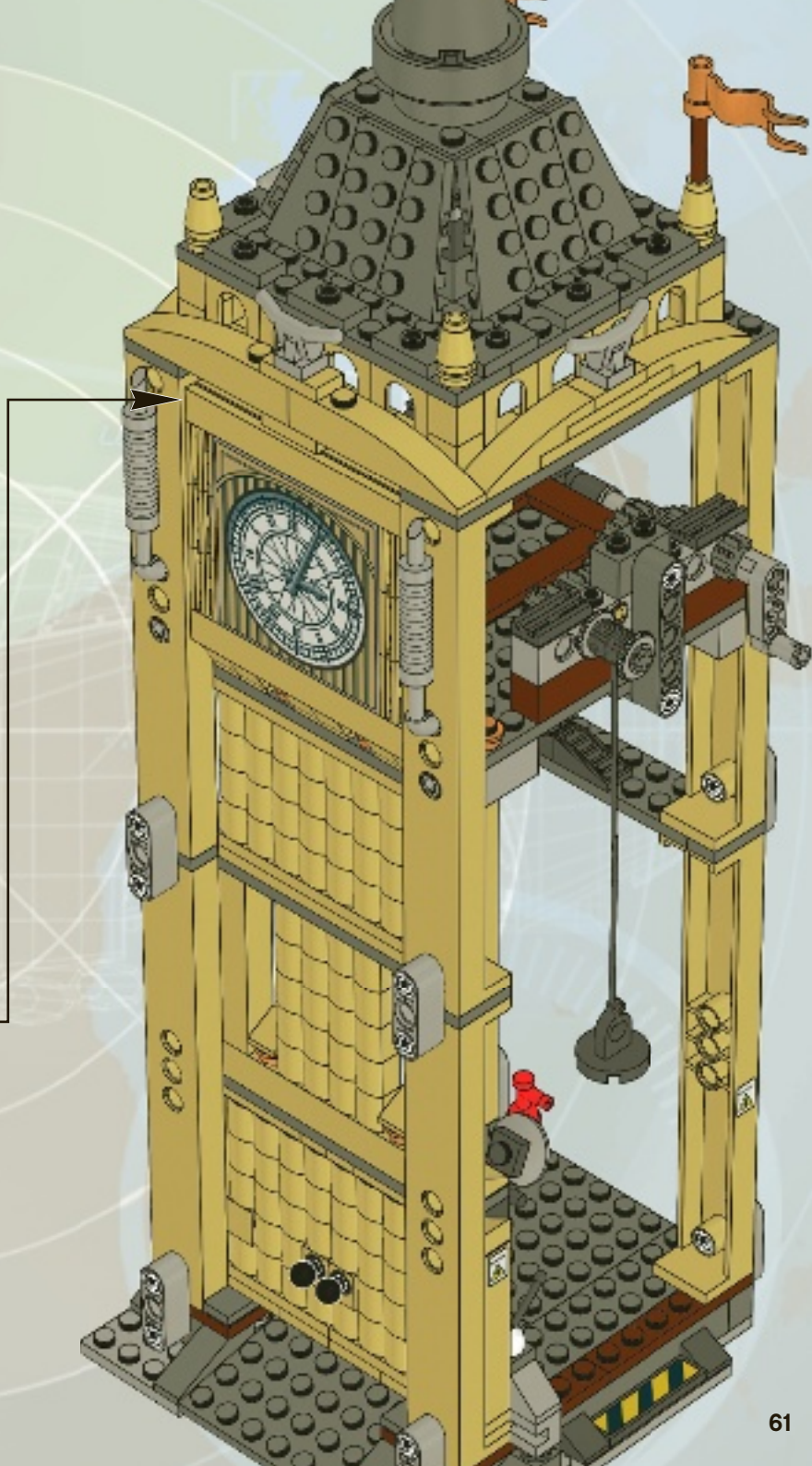
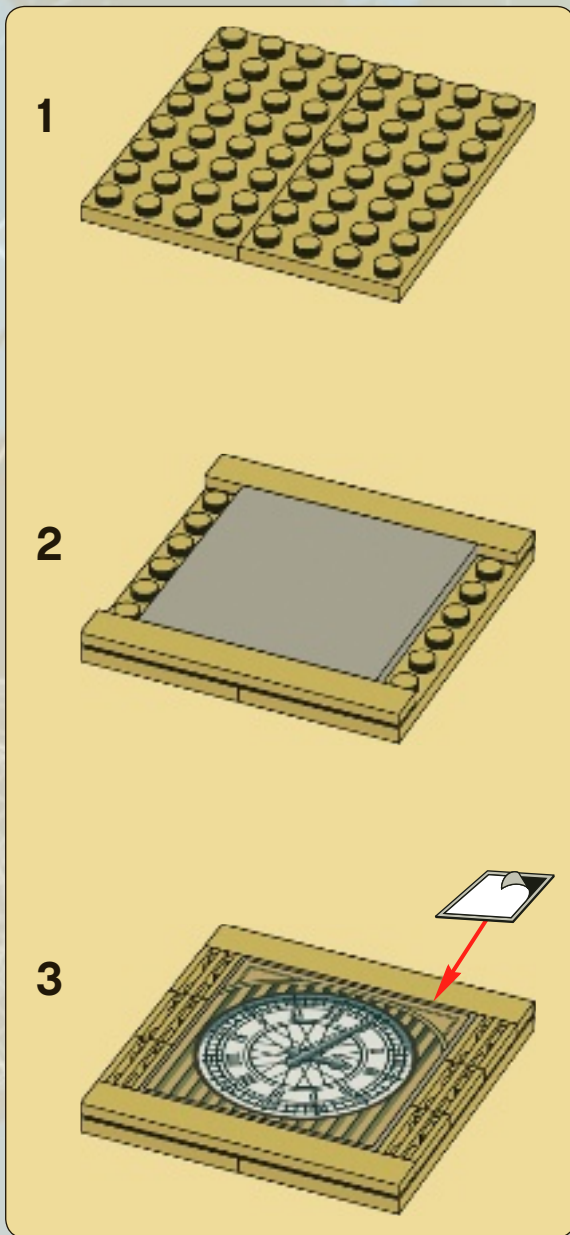



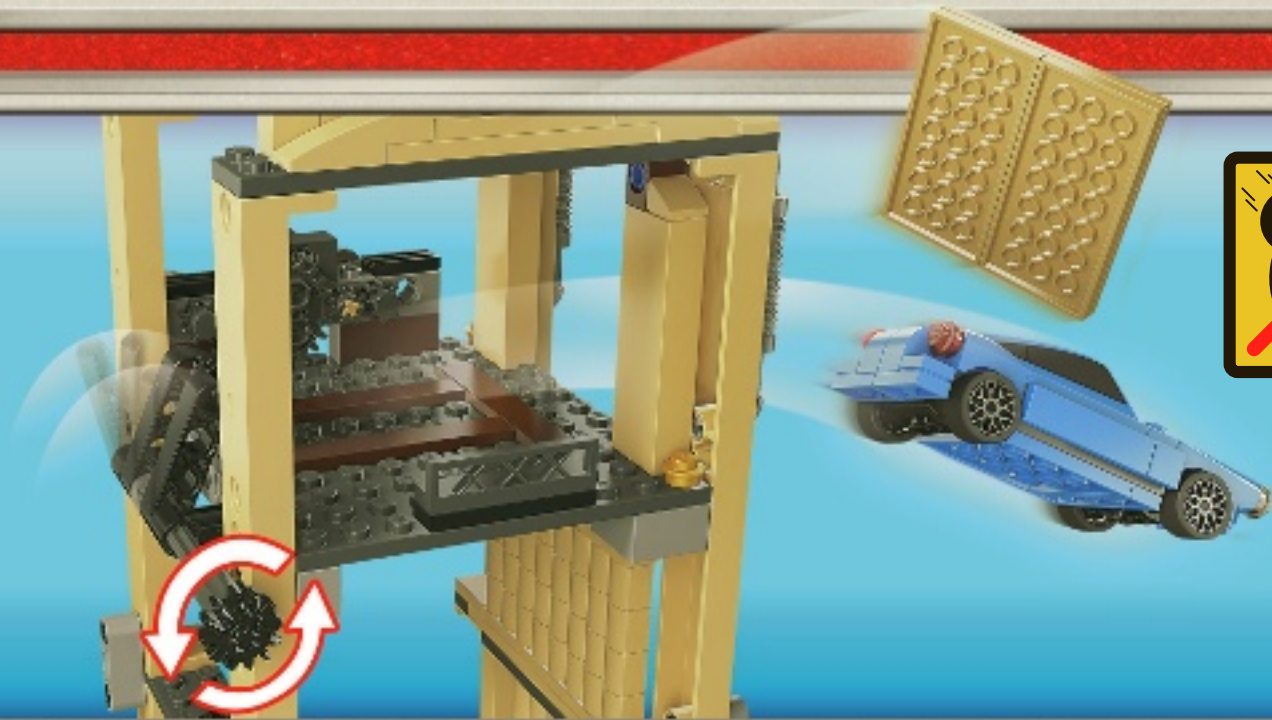
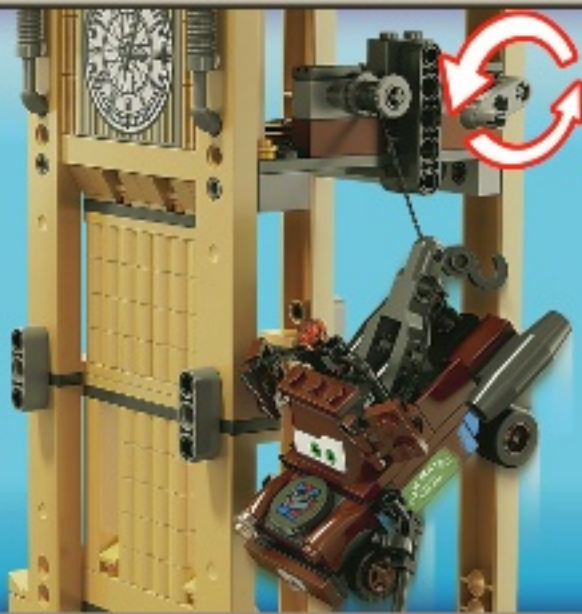



4x 300501
 2x 362201
 1x 300201
 1x 611101
 1x 4111971
 2x 4533763
 2x 446001
 3x 4249112
 2x 4620761
 1x 306801
 1x 362301
 1x 4558168
 1x 302101
 2x 243101
 4x 302001

4x 379401
 2x 4585448
 2x 459901
 1x 73737
 1x 4119500
 2x 4523403
 2x 4129836
 4x 4623355
 1x 4624697
 2x 4112980
 8x 4113915
 4x 4114064

2x 4121921
 3x 4550324
 6x 4118793
 4x 4218749
 8x 4529237
 4x 4179771
 8x 4620133
 20x 4516055
 2x 4618651
 4x 4161734
 12x 4642933
 1x 4186017
 2x 4125253
 1x 4114084

1x 4166138
 25x 4523148
 2x 4113233
 4x 4124067
 2x 4544139
 2x 4114324
 1x 4143409
 2x 4509897
 6x 4124456
 3x 4155708
 6x 4160483
 4x 4547720
 2x 4624701
 1x 4514554

1x 4623276
 1x 306221
 5x 302321
 2x 302121
 1x 4623285
 1x 4623286
 1x 4623278
 1x 4623280
 3x 4588003
 2x 244421
 3x 4282742
 1x 459921
 1x 4613132
 1x 4623275
 2x 245823
 2x 4504380

2x 4121936
 2x 302323
 1x 302123
 1x 243123
 1x 371023
 2x 4560180
 1x 4243815
 2x 379423
 2x 4631265
 1x 4600182
 2x 4143005
 3x 4206482
 2x 303424
 4x 301026
 2x 4288212
 4x 4504382

2x 4541191
 2x 302326
 2x 302226
 3x 243126
 1x 371026
 2x 302026
 2x 379526
 1x 303426
 2x 4517925
 2x 4550017
 1x 4144024
 4x 379426
 2x 241226
 3x 4282746
 13x 615726
 2x 4600178

4x 614126
 2x 403226
 1x 237626
 2x 408326
 1x 4505757
 1x 4623154
 2x 4223247
 1x 396226
 2x 4549989
 4x 4248538
 20x 4246901
 2x 4508215
 2x 4617848
 4x 4616406
 6x 4516843
 1x 4516196

1x 4191191
 3x 393726
 1x 4297719
 2x 4120017
 2x 4184169
 2x 4107085
 1x 4109810
 22x 4121715
 1x 370626
 1x 4177431
 5x 302328
 9x 3005740
 1x 4114128
 10x 3005741
 2x 4567332
 2x 3005744

2x 4617019
 4x 4527526
 4x 4598010
 2x 4597999
 1x 4179828
 1x 4616408
 1x 4616698
 1x 4622708
 1x 4622712
 1x 4622713
 2x 4621182
 1x 4611415
 2x 4621180
 1x 4243826

2x 4621181
 1x 4621175
 1x 4621184
 1x 4621177
 2x 4616581
 4x 4521950
 1x 4624442
 1x 4624395
 1x 4624400
 2x 4633697
 2x 4633698
 1x 4624403
 2x 4616710
 1x 4633693
 1x 4633695



Customer Service
Kundenservice
Service Consommateurs
Servicio Al Consumidor

www.lego.com/service or dial

: 00800 5346 5555
: 1-800-422-5346



8486



8638



8639



8201, 8487



8200, 8487



8639



8638



8424



8638



8423, 8639



8424



8426



8639



8426, 8639



8486



8638



8487



8487



8206



8639



8423



8206, 8484



8638



8487



8639



8426



8638



8487

8426



8484





8487



8638





LEGO.com/CARS



www.LEGOclub.com

LEGO club

FREE! GRATIS! GRATUIT!



LEGO® Club Magazine



LEGO® Club Email



VISIT THE WORLD'S
BIGGEST LEGO® SHOP
www.LEGOshop.com
6376
www.LEGOclub.com

00800 5346 5555*
1-866-534-6258 • 1-877-518-5346

* Freephone. Mobile charges may apply. * Numéro sans frais. Des frais peuvent s'appliquer avec les téléphones cellulaires. * Gebührentfrei. Kosten für Anrufe aus Mobilfunknetzen können abweichen. * Gratis telefoonnummer vanaf vaste lijn. * Det er et gratis nummer, når du ringer fra fasttelefon. * Det är gratis, när du ringer från en fast telefon. * Numéro sans frais. Des frais peuvent s'appliquer avec les téléphones portables.

YES! I want to join the LEGO® Club FREE! **OUI!** Je veux m'abonner au LEGO® Club GRATUITEMENT!
Ja! Ich möchte Mitglied im kostenlosen LEGO® Club werden. **Ja!** Ik wil graag GRATIS lid worden van de LEGO® Club.
Ja! Jeg ønsker å melde meg inn i LEGO® Club gratis! **Ja!** Jag vill gå med i LEGO® Club GRATIS!

First name · Prénom
 Vorname · Voornaam
 Fornavn · Förnamn

Last name · Nom de famille
 Name · Achternaam
 Etternavn · Efternamn

Date of Birth · Date de naissance
 Geburtstag · Geboortedatum
 Fødselsdato · Födelsedatum

Boy · Garçon · Junge ·
 Jongen Gutt · Pojke

Girl · Fille Mädchen ·
 Meisje Jente · Flicka

Street · Adresse
 Straße, Hausnr.
 Straat, huisnr.
 Address

City · Ville
 Ort · Woonplaats
 Poststed · Postort

State
 Prov. County

Zip/Postcode · Code
 Postal · PLZ · Postcode ·
 Postnummer

Country
 Pays · Land

Email · Courriel ·
 E-Mail · E-post

- Fill in your email address and we will send you a membership confirmation and monthly email newsletters. If you do not wish to receive the newsletters please tick here. Remplis ton adresse e-mail et nous t'enverrons une confirmation d'adhésion ainsi que le bulletin e-mail mensuel. Si tu ne désires pas recevoir le bulletin, coche cette case. Vul je e-mailadres in en we sturen je een bevestiging van je lidmaatschap en maandelijke e-mail nieuwsbrieven. Als je geen e-mail wilt ontvangen, kruis dan dit vakje aan.
- Ich möchte per E-Mail den monatlichen LEGO Club Newsletter erhalten. Ønsker du at vi skal sende en liten hilsen til barnet ditt for å bekrefte medlemskapet, ber vi deg krysse av i feltet, samt oppgi e-postadressen som hilsenen skal sendes til. Om du vill att vi ska skicka en bekräftelse på ditt barns medlemskap, ber vi dig sätta ett kryss i rutan och skriva den e-post adress som bekräftelsen ska skickas till.
- If you do not wish to receive additional mailings from the LEGO Club please tick here. Si tu ne désires pas recevoir de courrier supplémentaire du Club LEGO, coche cette case. Als je geen verdere post van de LEGO Club wilt ontvangen, kruis dan dit vakje aan.
- Dersom du ønsker å motta annen informasjon fra LEGO Gruppen, setter du et kryss her.

Mail to: Poster à: LEGO® Club P.O. Box 1157 Enfield, CT USA 06083-1157	Per Post an: LEGO® Club Postfach 14 15 D-36243 Niederaula	Send til: LEGO® Club Norge Postboks 58 1314 Vøyenenga
Mail to: LEGO® Club 33 Bath Road Slough SL1 3UF United Kingdom	Stuur op naar: LEGO® Club Postbus 40250 3504 AB Utrecht	Skickas till: LEGO® Club Sverige Ubox 841 202 29 Malmö
	Poster à: LEGO® Club 21 rue de la banque 75 002 PARIS FRANCE	

The English language version of the magazine can only be mailed to addresses in the US, Canada, the UK, and Republic of Ireland. Club membership is valid for two years and includes free copies of the LEGO Club Magazine and e-mail newsletters. In the US and Canada please allow up to 6 weeks for delivery of your first magazine. In the UK and Republic of Ireland please allow six to 14 weeks for delivery of your first magazine. By signing this form you consent the LEGO Club to use your child's data for LEGO mailings. The data will only be used for LEGO mailings and will not be sold, rented or otherwise disclosed to any company outside the LEGO Group except for disclosure to companies acting as our agents to help us provide services requested by the child. This coupon is valid for one free membership per person, group or organization. Photocopied coupons are accepted. La version française du magazine peut être postée uniquement au Canada. L'abonnement est valide pour 2 ans et inclut des exemplaires gratuits du Magazine LEGO. Aux É.-U. et au Canada, allouer 6 semaines pour la livraison initiale. En remplissant ce formulaire, vous consentez à ce que LEGO utilise les informations de votre enfant pour des envois postaux de LEGO. L'information sera utilisée uniquement pour des envois postaux par LEGO et ne sera en aucun cas, vendue, louée, échangée ou divulguée à d'autres compagnies autres que la compagnie LEGO, à l'exception des compagnies affiliées qui nous aident et qui nous prêtent des services auxquels l'enfant en a fait la demande. Formulaires photocopiés acceptés. Mit der folgenden Unterschrift erkläre ich, für mein Kind den Beitritt als Mitglied zum kostenlosen LEGO Club, der von der LEGO GmbH, D-85627 Grasbrunn, betrieben wird. Die Mitgliedschaft beinhaltet die Zusendung des LEGO Club Magazins und kann beiderseits jederzeit beendet werden. Mit der Mitgliedschaft im LEGO Club sind keinerlei Verpflichtungen verbunden. Das deutschsprachige LEGO Club Magazin wird nur an Adressen in Deutschland, Österreich und der Schweiz versendet. Eine Anmeldebestätigung kann nur per E-Mail geschickt werden. Das Magazin erscheint fünfmal jährlich. Daher kann die Zustellung des ersten Heftes bis zu drei Monate dauern. Die Mitgliedschaft ist beidseitig jederzeit kündbar, ohne dass Ihnen Kosten entstehen. Sie können der werblichen Nutzung Ihrer Daten jederzeit widersprechen. Kündigung und Widerspruch können Sie telefonisch erklären (00800 / 5346 5555, Anruf gebührenfrei, Kosten für Anrufe aus dem Mobilfunknetz können abweichen) oder an die LEGO GmbH senden. Het Nederlandse LEGO Club Magazine kan alleen worden gestuurd naar adressen in Nederland. Het lidmaatschap is 2 jaar geldig en geeft recht op toezending van het gratis LEGO Club Magazine en LEGO Club e-mails. Het eerste magazine zal binnen 12 tot 14 weken toegestuurd worden. Het lidmaatschap kan op ieder moment opgezegd worden en kan na 2 jaar gratis worden verlengd, tenzij LEGO met deze activiteit stopt. Uw gegevens worden uitsluitend gebruikt voor mailings van LEGO en zullen niet worden verkocht, verhuurd of op welke wijze dan ook verstrekt aan derden buiten de LEGO Groep, uitgezonderd de organisaties die namens ons optreden om de informatie te sturen waarvoor toestemming is verleend. Den norske utgaven av magasinet sendes kun til adresser i Norge. Medlemskap i klubben gjelder i 2 år og inkluderer gratisutgaver av LEGO Club Magazine. Påregnet minimum optill seks uker leveringstid for første magasin. Ved å undertegne dette skjemaet, gir du ditt samtykke til at LEGO Club kan bruke opplysningene om barnet ditt i LEGO forsendelser. Dataene vil utelukkende bli brukt i LEGO forsendelser og vil ikke bli solgt, utleid eller på annen måte gjøres tilgjengelig for selskaper utenfor LEGO gruppen, unntatt selskaper som er våre agenter og som hjelper oss å tilby tjenestene barnet etterspør. Dette skjemaet gjelder for ett gratis medlemskap per person, gruppe eller organisasjon. Den svenska versionen av tidingen kan endast skickas till adresser i Sverige. Club-medlemskapet är giltigt i 2 år och innefattar gratis exemplar av LEGO Club Magazine. Vånilgen räknas med minimum 6 veckor för leverans av din första tidning. Genom att skicka in det här formuläret godkänner du att LEGO Club använder barnets uppgifter för LEGO utskick. Uppgifterna kommer bara att användas för LEGO utskick och kommer inte att säljas, hyras ut eller vidarebefordras till något företag som inte tillhör LEGO Gruppen, med undantag av företag som agerar som våra ombud för att tillhandahålla tjänster som barnet har begärt. Den här kupongen gäller för ett gratis medlemskap per person, grupp eller organisation. En complément ce bulletin d'adhésion, vous acceptez que LEGO Club utilise les données personnelles à votre enfant pour l'envoi de courriers concernant LEGO. Ces données seront uniquement utilisées pour l'envoi d'information concernant LEGO et ne seront ni vendues, ni louées par d'autres sociétés que le groupe LEGO, à l'exception des sociétés agissant pour le compte de LEGO en tant que sous-traitant de services divers. L'abonnement au LEGO Club est valable pour une période de 2 ans. Il inclut l'envoi par courrier du magazine LEGO Club et par email des newsletters. Un délai de 6 à 14 semaines est à prévoir pour la réception de votre premier magazine. Ce bulletin d'adhésion gratuit est valable pour l'inscription d'une seule personne. Les photocopies sont acceptées. ATTENTION! Le bulletin d'adhésion doit être rempli et signé par un parent ou un tuteur.

Parent's signature · Signature d'un parent ou d'un tuteur _____ Datum _____
 Unterschrift Erziehungsberechtigter/ Handtekening ouders _____ Datum _____
 Foreldres/foresattes underskrift · Förälders/förmyndares underskrift _____ Datum _____



WIN!

Go to www.LEGOsurvey.com/product to fill out a survey for a chance to win a cool LEGO® Product. No purchase necessary. Open to all residents where not prohibited.

 www.LEGO.com



www.LEGOsurvey.com/product

GEWINNE!

Nimm an der Umfrage auf www.LEGOsurvey.com/product LEGO teil und hab die Chance ein cooles LEGO® Produkt zu gewinnen!

Die Teilnahme am Gewinnspiel führt zu keinerlei Kaufverpflichtungen. Teilnahme in allen nicht ausgeschlossenen Ländern möglich.

WIN!

Ga naar www.LEGOsurvey.com/product, vul een enquêteformulier in en maak kans op een cool LEGO® product.

Geen aankoopverplichting. Iedereen mag deelnemen, uitgezonderd ingezetenden van landen waar een enquêteverbod geldt.

GAGNE!

Visite www.LEGOsurvey.com/product pour répondre à un questionnaire et avoir une chance de gagner un produit LEGO® très cool!

Aucune obligation d'achat. Ouvert à tous les résidents des pays autorisés.

当てよう!

www.LEGOsurvey.com/product にアクセスして、アンケートにご記入ください。当選者にはレゴ®製品を差し上げます。

お買い上げの必要はありません。禁止されていない限り、すべての皆様にご利用いただけます。