



80113



The Spring Festival
Das Frühlingsfest
La fête du Printemps
La Festa di Primavera
Fiesta de la Primavera
O Festival da Primavera
春节
Festival Wiosny
Jarní festival
Jarný festival
Tavaszi Fesztivál
Festivalul Primăverii
Пролетният фестивал
Pavasara svētki
Kevadfestival
Pavasario šventė

1



LEGO® Builder



LEGO.com/sustainable-packaging



FR

DONNEZ
OU
RECYCLEZ



OU



OU



ASSOCIATION MAGASIN DÉCHÈTERIE

Adresses sur quefairedemesdechets.fr



🔍 LEGO® Builder

BUILDER



Apple and the Apple logo are trademarks of Apple Inc., registered in the U.S. and other countries and regions. App Store is a service mark of Apple Inc. Google Play and the Google Play logo are trademarks of Google LLC. Tencent and the Tencent logo are trademarks of Tencent Inc.

🔍 LEGO.com/devicecheck

EN Ask parents' permission before going online | DE Eltern um Erlaubnis bitten, bevor du online gehst | FR Demande l'autorisation d'un parent avant d'aller en ligne | IT Chiedi il permesso ai tuoi genitori prima di andare online | ES Pídeles permiso a tus papás antes de conectarte a Internet | PT Peça autorização aos pais antes de acederes online | ZH 上网前应先征得父母的同意 | PL Poproś rodziców o zgodę, zanim wejdiesz do Internetu | CS Než půjdeš na internet, požádej rodiče o svolení | SK Skôr než pôjdeš na internet, vypýtaj si povolenie od rodičov | HU Kérj szülői engedélyt, mielőtt online csatlakoznál! | RO Cere permisiunea părinților înainte de a te conecta online | BG Поискайте разрешение от родител, преди да влезете онлайн | LV Pirms došanās tiešsaistē palūdz atļauju vecākiem | ET Enne Interneti kasutamist küsi vanematelt luba | LT Prieš prisijungdami prie interneto, atsiklauskite tėvų



Family Reunion Celebration

As the saying goes, "food is the first necessity of life". The annual reunion dinner of every Spring Festival is symbolic and meaningful. The whole family enjoys a harmonious and festive atmosphere, sharing the joy of togetherness.

As an important element of the culture of New Year festivities, the reunion dinner is not only a feast for the taste buds but also a celebration of memory and love, symbolising family bonds and harmony.

Familientreffen

„Essen ist die erste Notwendigkeit des Lebens“, besagt ein chinesisches Sprichwort. Das alljährliche Familienessen anlässlich des Frühlingsfestes ist deshalb besonders symbolträchtig und bedeutsam. Die ganze Familie kommt zusammen, um die harmonische, fröhliche Atmosphäre zu genießen und die Freude des Zusammenseins zu teilen.

Als wichtiger Bestandteil des Neujahrsfestes ist das Familienessen nicht nur ein Festmahl für die Geschmackssinne, sondern zelebriert auch den Kreislauf von Erinnerung und Liebe und symbolisiert Familienbande und Harmonie.

La fête de famille

Comme le dit le proverbe, « la nourriture est la première nécessité de la vie ». Le repas de famille annuel du Nouvel An chinois est très important et symbolique. Les membres de la famille partagent de beaux moments dans une ambiance harmonieuse et joyeuse.

Faisant partie intégrante de la « culture du Nouvel An », le repas de famille n'est pas qu'un repas qui émerveille les papilles, c'est aussi une célébration des souvenirs et de l'harmonie qui unit les membres de la famille.

Festa del ritrovo familiare

Come dice il proverbio, "Il cibo è la prima necessità della vita". La cena del ritrovo familiare in occasione di ogni Festa di Primavera è simbolica e particolarmente significativa. L'intera famiglia si ritrova in un'atmosfera armoniosa e festiva, condividendo la gioia di stare insieme.

Un elemento importante della cultura delle festività di Capodanno, la cena del ritrovo non è solo una celebrazione culinaria, ma anche della memoria e dell'amore, che simboleggia i legami familiari e l'armonia.

Celebración Familiar

Sabemos que el alimento es lo más básico que necesitamos para vivir. La cena anual de cada Fiesta de la Primavera reúne a las familias en un acto cargado de simbolismo y significado. Todos disfrutan de un ambiente armonioso y festivo, compartiendo la alegría de estar juntos.

Un elemento indispensable de las fiestas de Año Nuevo, la cena no solo es un festín para las papilas gustativas, sino también la ocasión ideal para celebrar los recuerdos y el amor, además de un símbolo especial de los lazos familiares y la armonía.

Celebração de Reunião Familiar

Como diz o ditado, «Quando há fome, não há pão mal feito». O jantar de reunião anual de cada Festival da Primavera é simbólico e importante. A família inteira desfruta de um ambiente harmonioso e festivo, partilhando a alegria do convívio.

Sendo um elemento importante da cultura de festividades do Novo Ano, o jantar de reunião não só é um banquete para os apreciadores de boa comida como, uma celebração das memórias e do amor, simbolizando a harmonia e os laços familiares.

团圆

俗话说, “民以食为天”。每年春节的团圆饭更是意义非凡。一家人其乐融融, 共享天伦之乐, 洋溢喜庆之气。作为“年文化”的重要元素, 团圆饭不仅是味蕾的盛宴, 更是记忆和关爱的流动, 亲情和美好的象征。

Zjazd rodzinny

Jak mówi przysłowie: „Jedzenie to pierwsza życiowa potrzeba”. Obiad z okazji Święta Wiosny, na którym spotyka się cała rodzina, to nie lada okazja mająca wymiar symboliczny. To wesoły, rodzinny czas, wypełniony harmonią i szczęściem, w którym chodzi o to, aby po prostu być razem.

Wspólny, rodzinny posiłek jest niezwykle ważny podczas świętowania nowego roku – i nie chodzi wyłącznie o pyszne jedzenie. To czas symbolizujący harmonię i więzi w rodzinie, kiedy świętuje się pamięć o tym, co było, i miłość.

Oslava setkání rodiny

Jak se říká: „Jídlo je první životní potřebou“. Každoroční společná večeře během čínského Nového roku má hluboký symbolický význam. Rodina se těší harmonické a sváteční atmosféře a sdílí radost ze sounáležitosti.

Večeře během oslavy setkání rodiny je důležitým prvkem oslav Nového roku. Není jen svátkem pro chuťové pohárky, ale navíc oslavuje vzpomínky a lásku a symbolizuje rodinná pouta a harmonii.

Rodinná oslava

Ako sa hovorí: „Treba jesť, aby sa žilo.“ Každoročná rodinná večera počas čínskeho Nového roku v sebe nesie veľkú symboliku a význam. Celá rodina si vychutnáva príjemnú sviatočnú atmosféru a teší sa zo spoločne strávených chvíľ.

Rodinná oslava predstavuje dôležitý zvyk spojený s oslavami čínskeho Nového roku a prináša omnoho viac než len hostinu. Oslavuje spomienky a lásku, symbolizuje tiež rodinné vzťahy a harmóniu.

Ünnepeljük, hogy együtt a család!

„Az étel az élet elsődleges szükséglete” – A tavaszi fesztivál első közös családi vacsorája minden évben szimbolikus, és nagy jelentőséggel bír. Harmonikus és ünnepi hangulatban élvezi az egész család a nyugodt, boldog, együtt töltött időt.

Az újévi ünnepségek igen fontos elemeként a közösen elköltött vacsora nemcsak az ízékről szól, hanem az emlékek és a szeretetet ünnepléséről is, szimbolizálva a családi kötelékeket.

Petrecere de reunire a familie

După cum se spune, „Hrana este necesitatea primordială a vieții”. Cina anuală în familie din cadrul Festivalului primăverii are un caracter simbolic și special. Întreaga familie profită de atmosfera armonioasă și festivă, împărtășind bucuria de a fi împreună.

Ca element important al festivităților de An Nou, cina în familie nu este doar un festin pentru papilele gustative, ci și o sârbătoare a depășirii amintirilor și a dragostei, simbolizând legăturile familiale și armonia.

Семеен празник

Както се казва: „Храната е първата необходимост в живота”. Годишната семейна вечеря по време на всеки пролетен фестивал е символична и значима. Цялото семейство се радва на хармонична и празнична атмосфера, като споделят радостта от това, че са заедно.

Като важен елемент от културата на новогодишните празници, семейната вечеря е не само празник за вкусовите рецептори, но и празник на паметта и любовта, символизиращ семейните връзки и хармонията.

Ģimenes salidojums

Ticējums apgalvo: „Pārtaika ir pirmā dzīves nepieciešamība”. Katru pavasara svētku ikgadējās kopīgās vakariņas ir simboliskas un jēgpilnas. Visa ģimene bauda harmonisku un svinīgu atmosfēru, daloties kopības priekā.

Kopīgas vakariņas kā svarīgs Jaunā gada svētku elements ir ne tikai svētki garšas kārpīnām, bet tajās tiek svinētas arī atmiņas un mīlestība, simbolizējot ģimenes saites un harmoniju.

Perekokkutuleku tāhistamine

Nagu öeldakse: “Toit on elu alus”. Eriti tähendusriikas on iga kevadfestivali kokkutuleku õhtusöök. Kogu pere naudib harmoonilist ja õnneliku õhkkonda, jagades pereelu rõõmu.

Uusaasta kultuuri olulise sündmusena ei ole kokkutuleku õhtusöök mitte ainult pidu, vaid tähistab ka traditsioonide ja armastuse voogu, sümboliseerides perekondlikke sidemeid ja ilu.

Šeimos susibūrimo šventė

Kaip sakoma: „maistas yra svarbiausias pirminis gyvenimo poreikis”. Kasmetinė susibūrimo vakarienė per kiekvieną Pavasario šventę turi simbolinę prasmę. Visa šeima mėgaujasi darna ir pakilia nuotaika, dalijasi bendrystės džiaugsmu.

Svarbus Naujųjų metų kultūros elementas – susibūrimo vakarienė – yra ne tik puota prie vaišių stalo, bet ir prisiminimų bei meilės šventė, simbolizuojanti šeimos ryšius ir harmoniją.

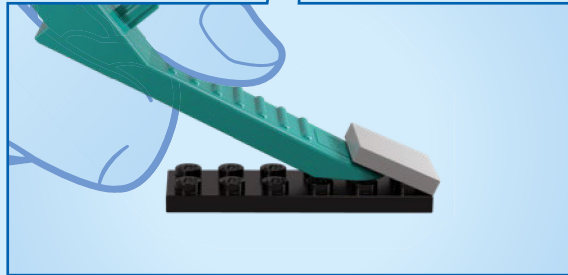
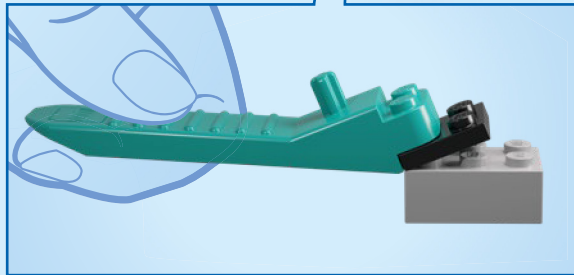
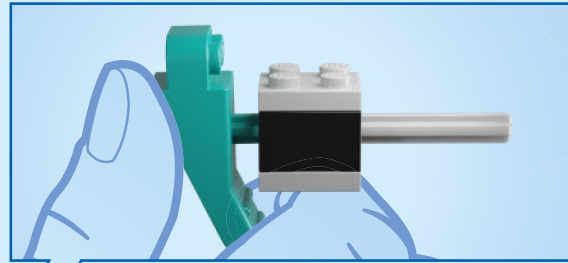
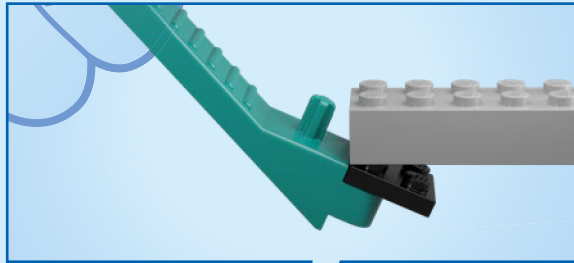

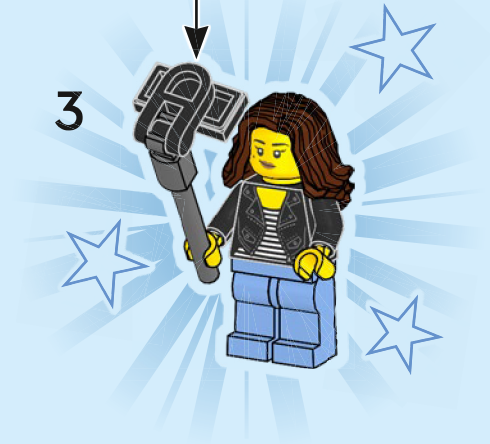
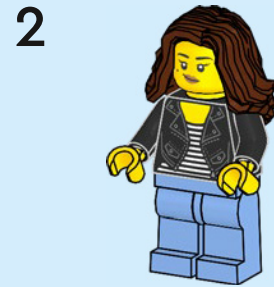
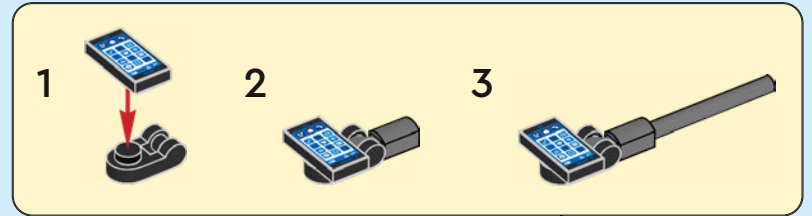
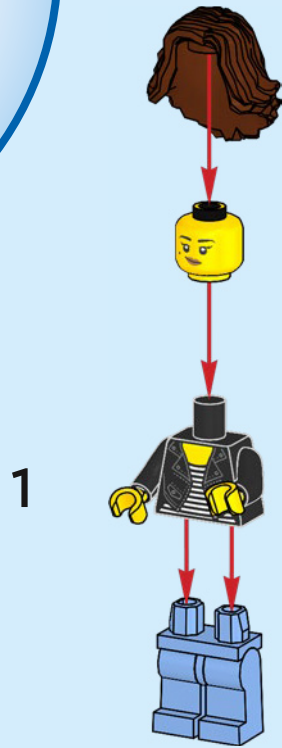

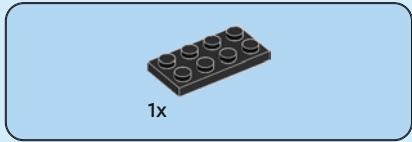

1

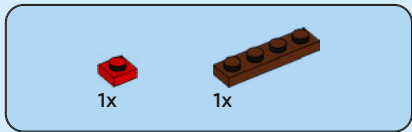
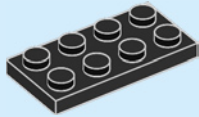

2

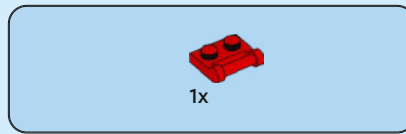
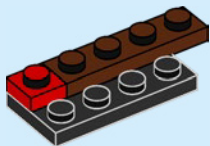

3

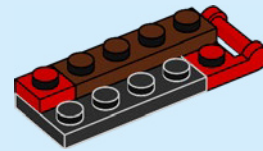

4

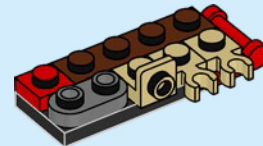

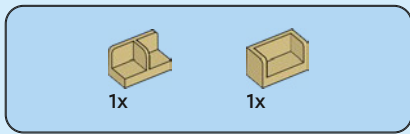

5

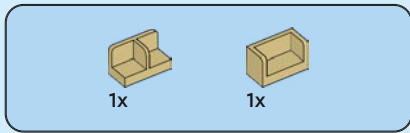
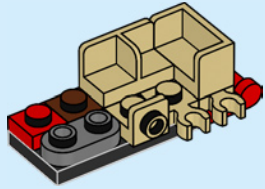

6

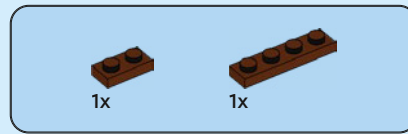
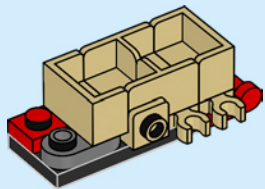

7

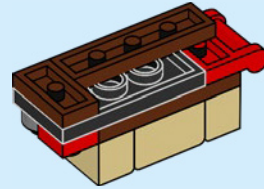

8

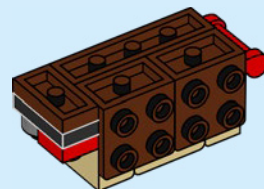



2x

9

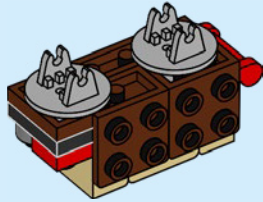

2x

10

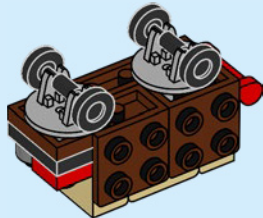

1x



1x



1x

11

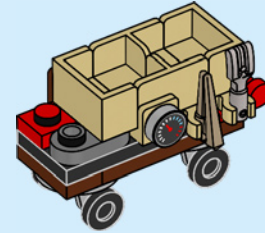

1x

12

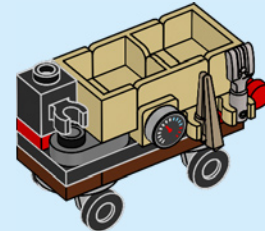

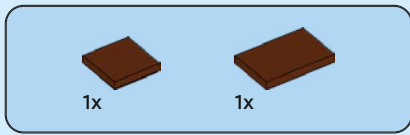

13

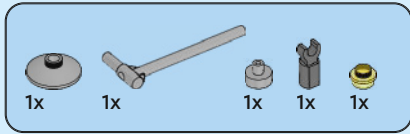
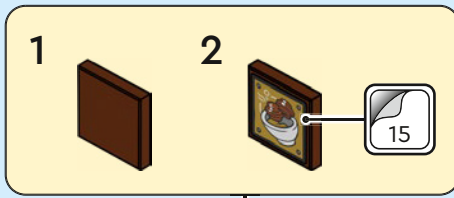

14

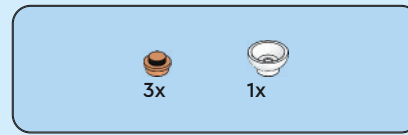
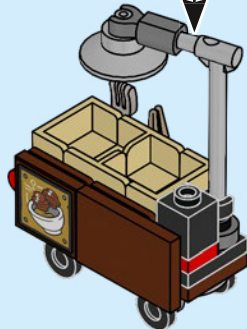
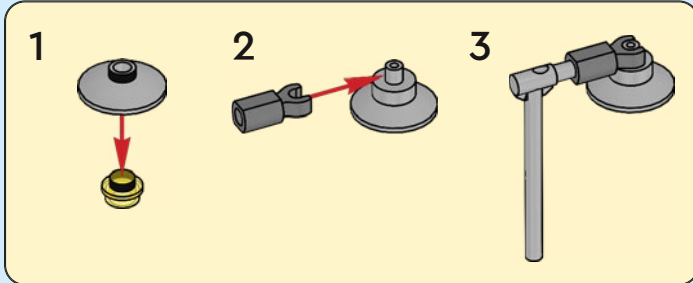

15

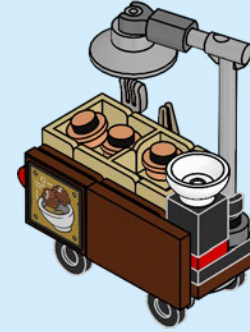

16



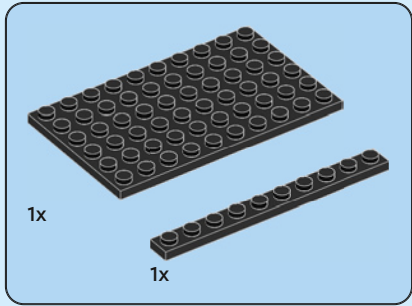
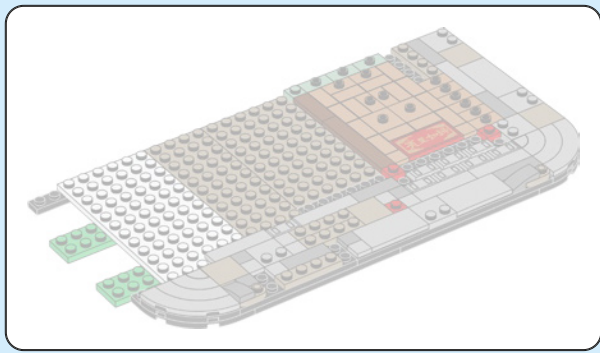

1

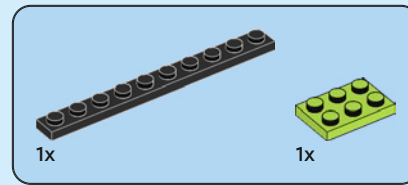
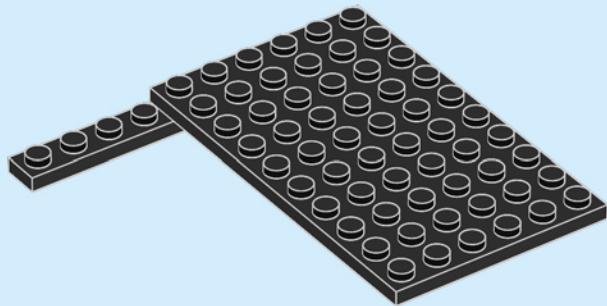

2

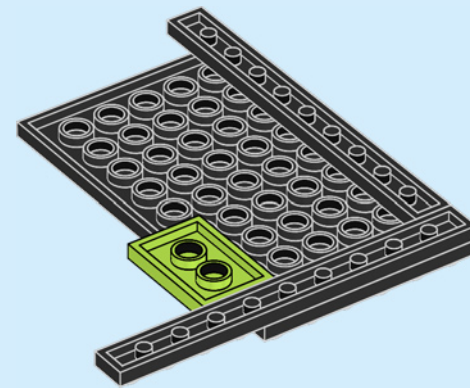

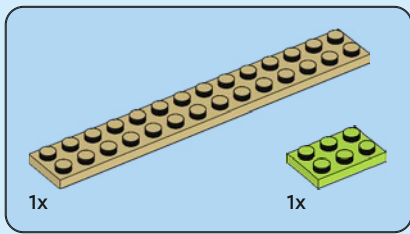

3

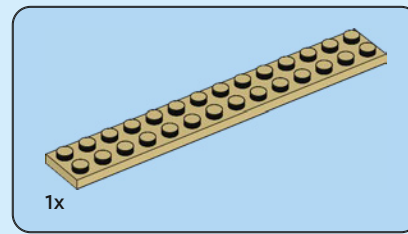
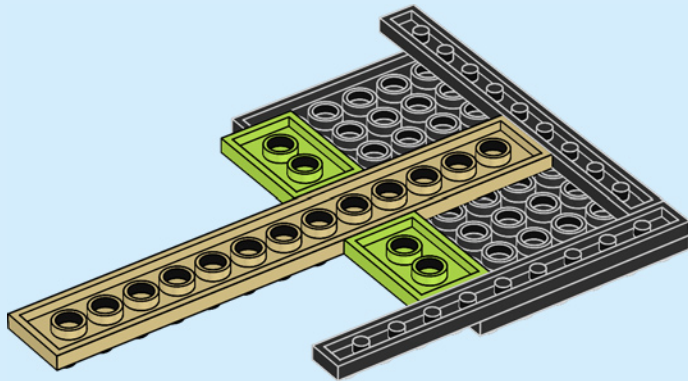

4

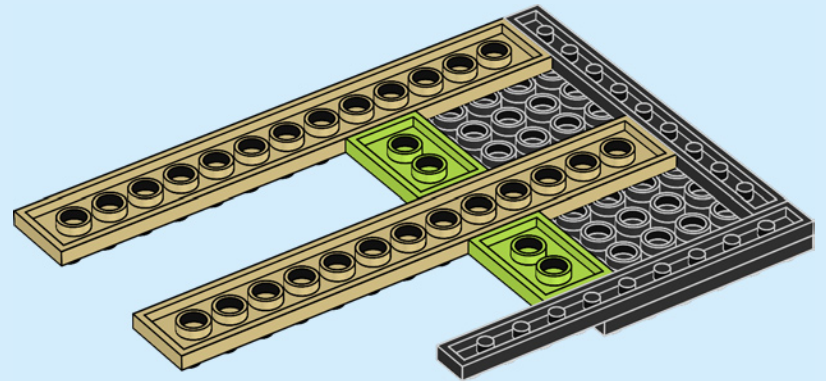

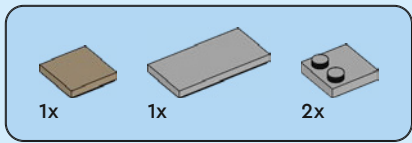

5

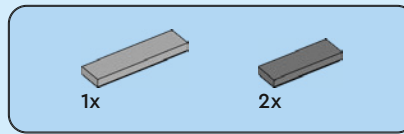
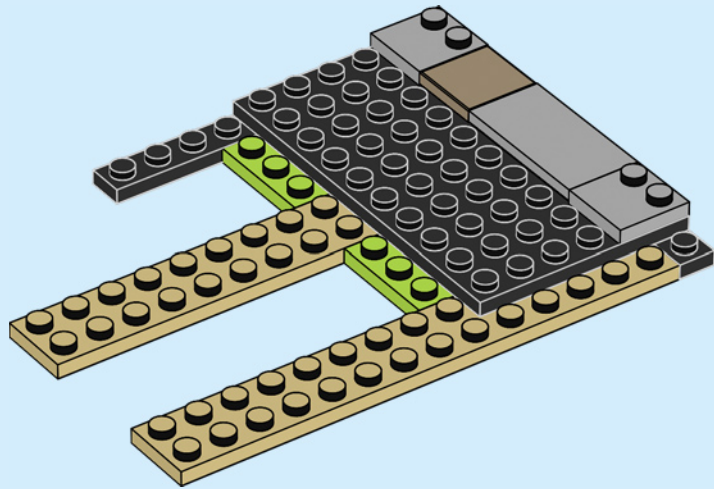

6

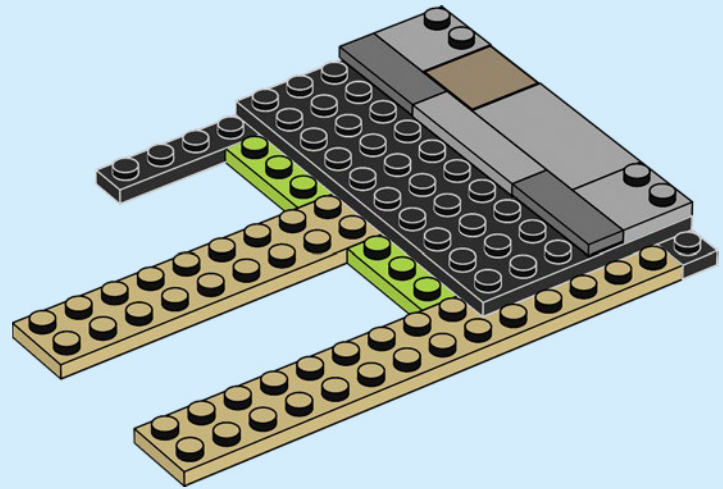

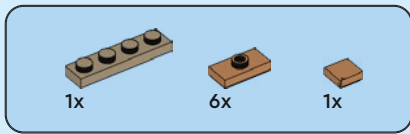

7

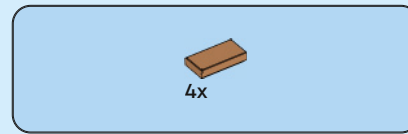
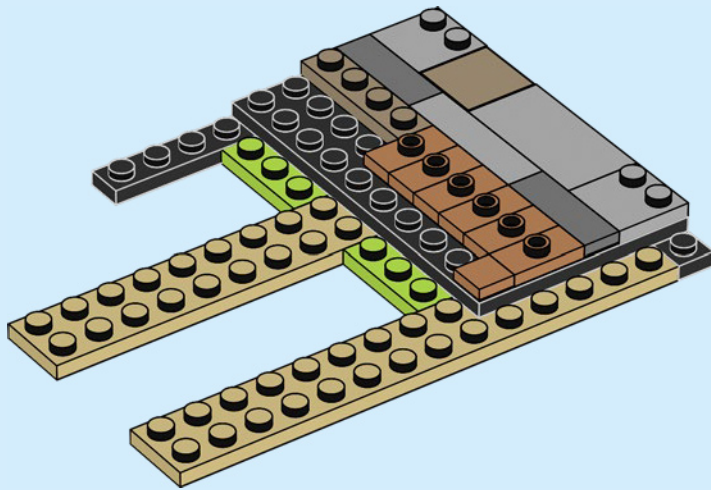

8

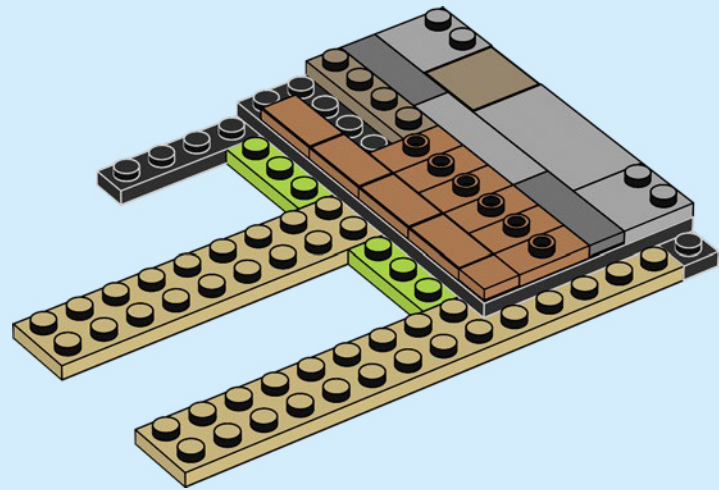

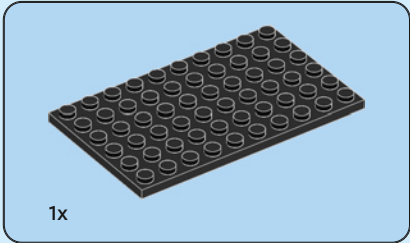
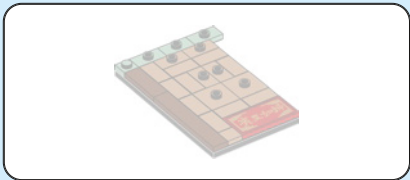

9

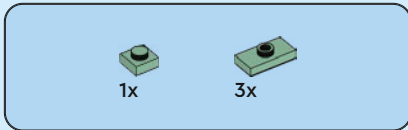
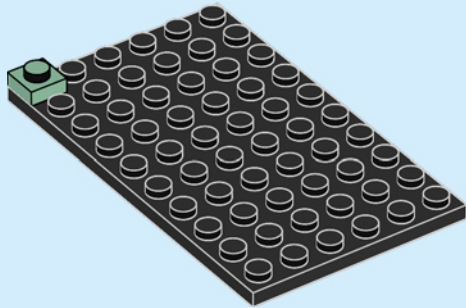

10

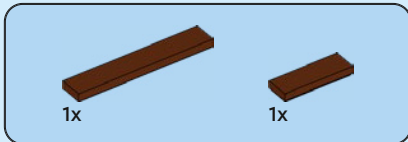
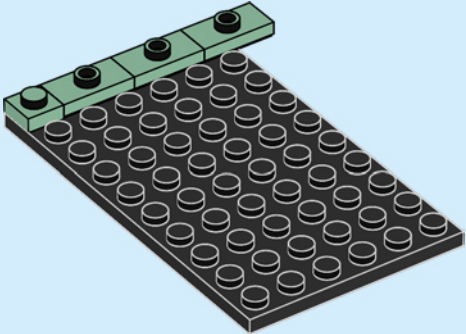

11

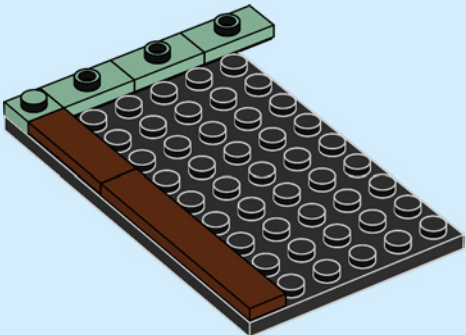

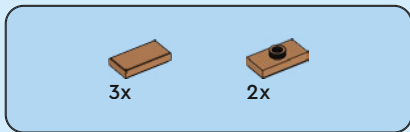

12

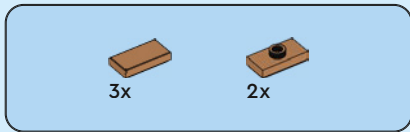
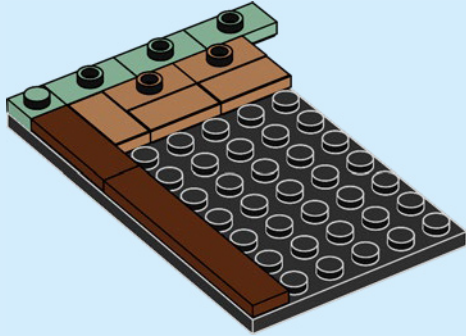

13

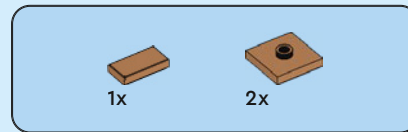
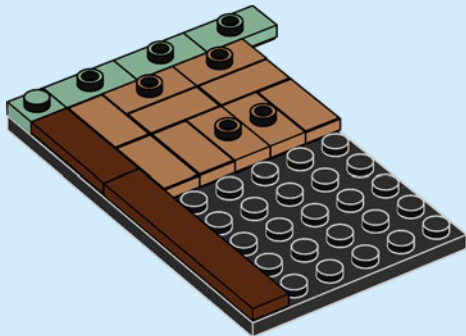

14

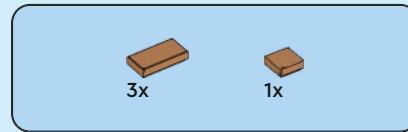
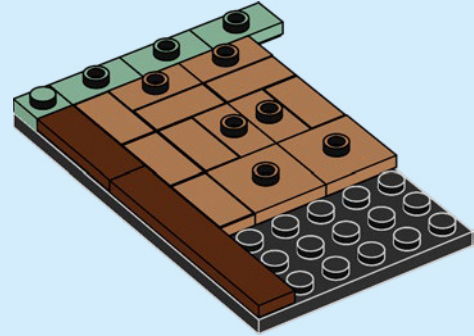

15

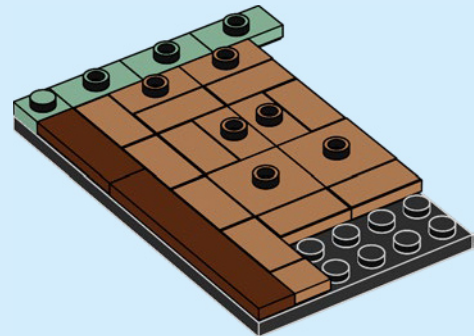

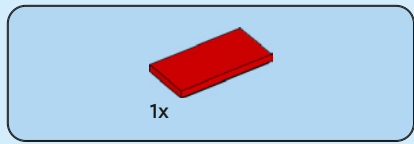

16

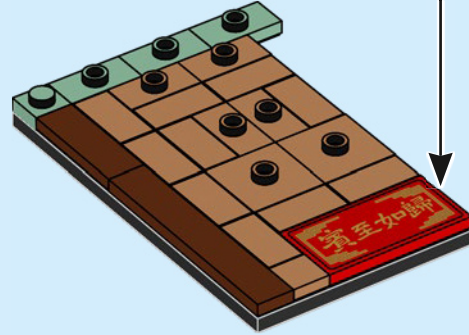
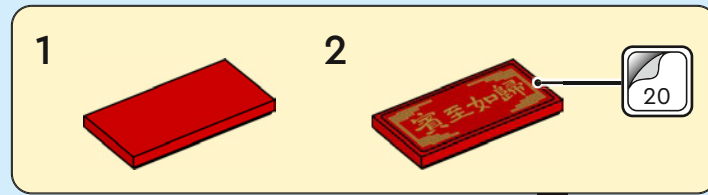

17

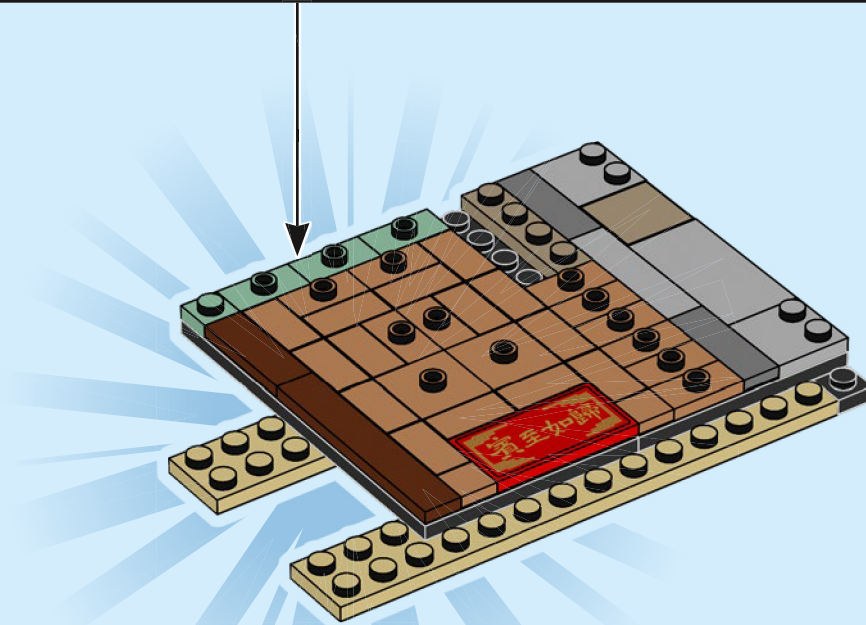

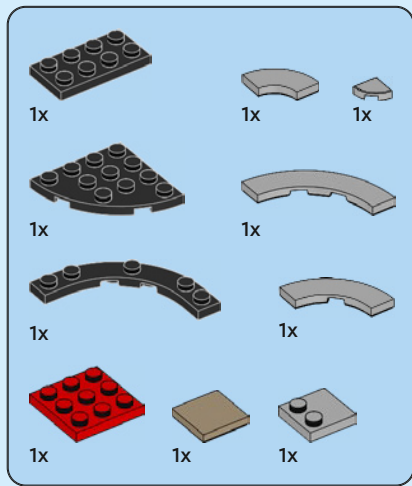

18

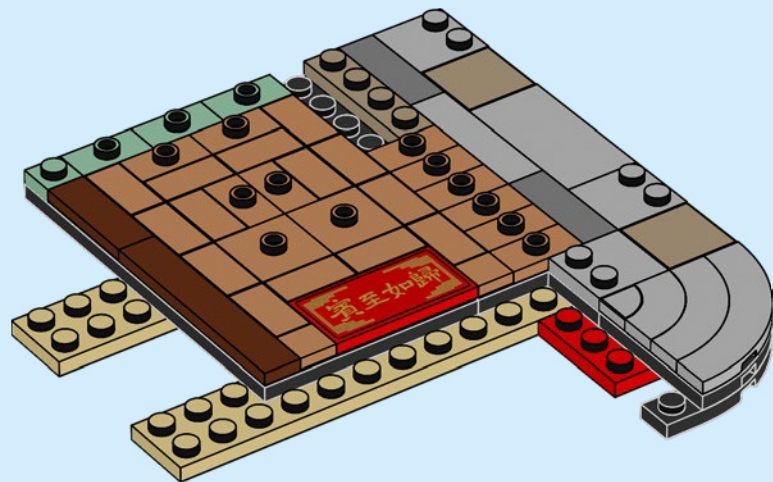
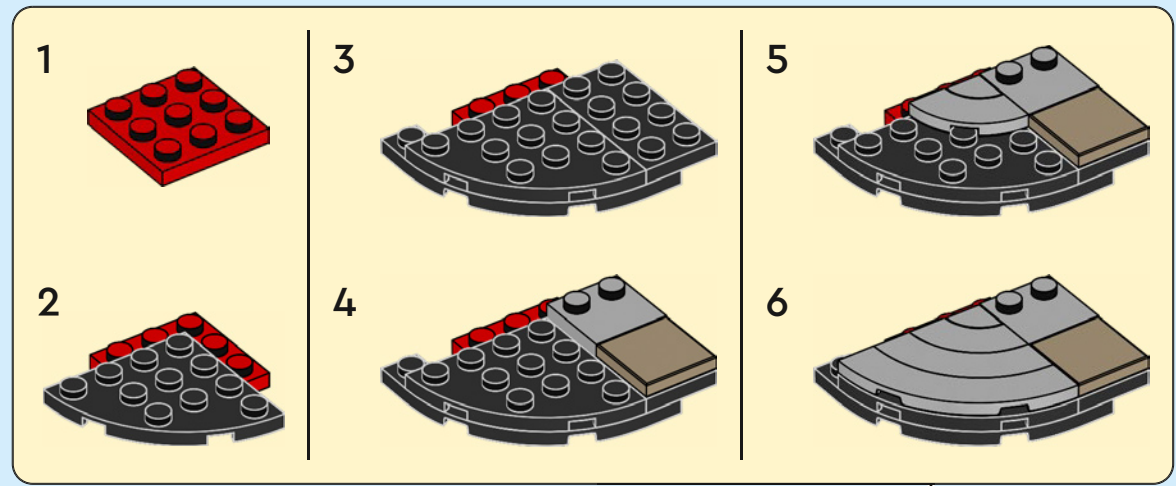

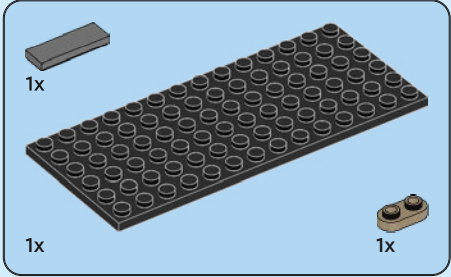
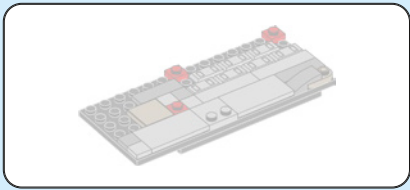

19

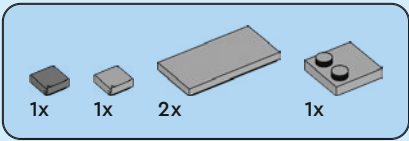
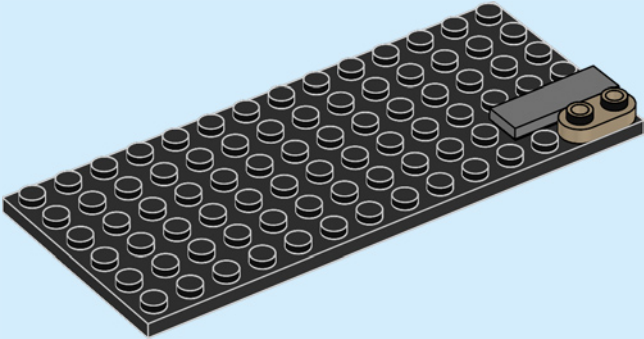

20

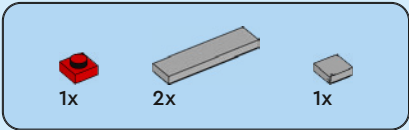
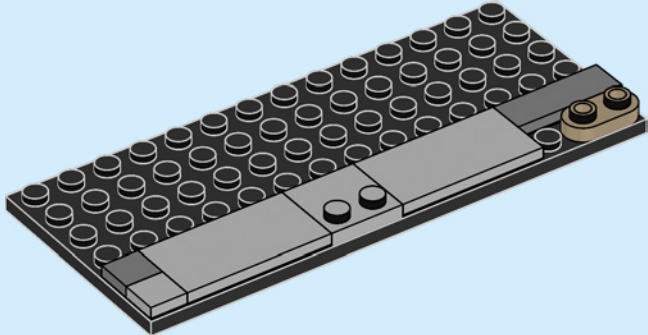

21

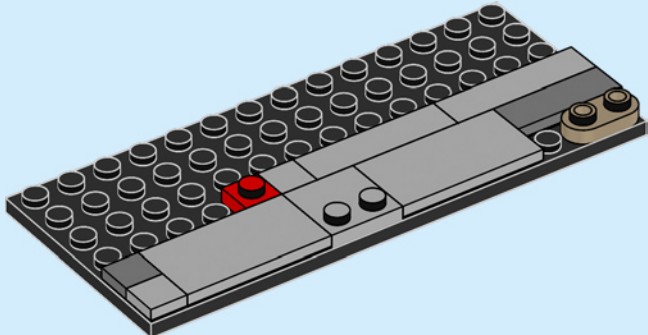

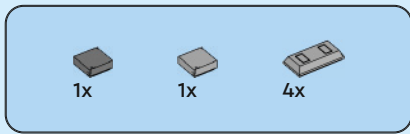

22

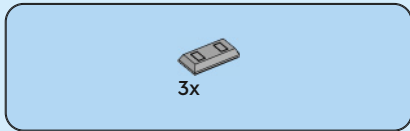
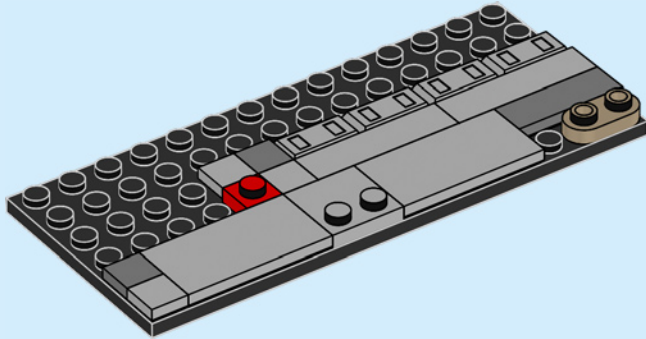

23

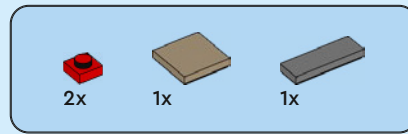
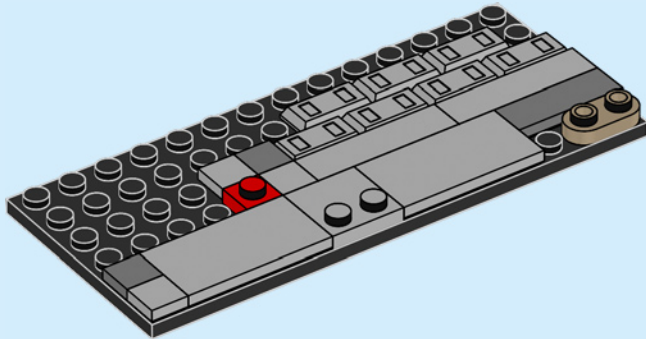

24

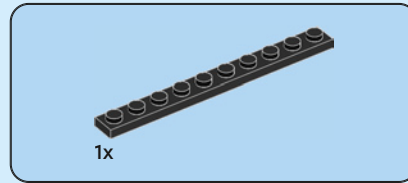
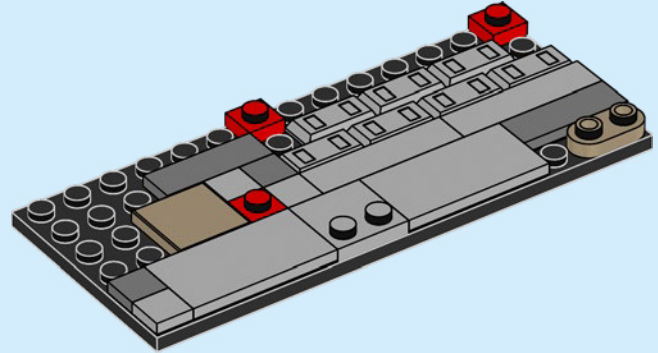

25

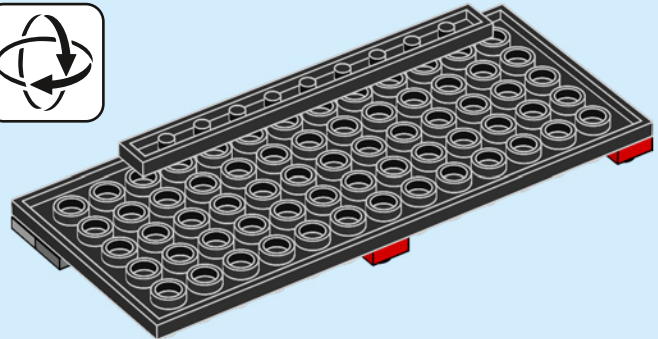



1x

26

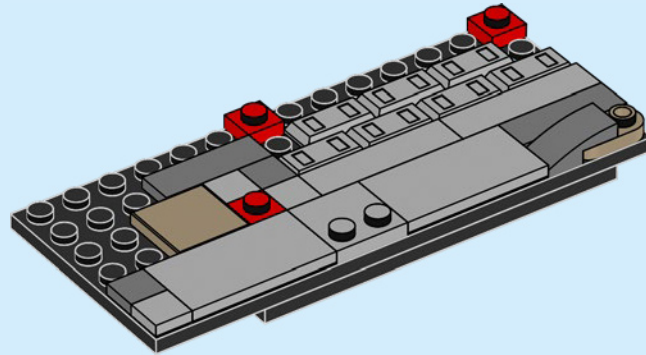

27

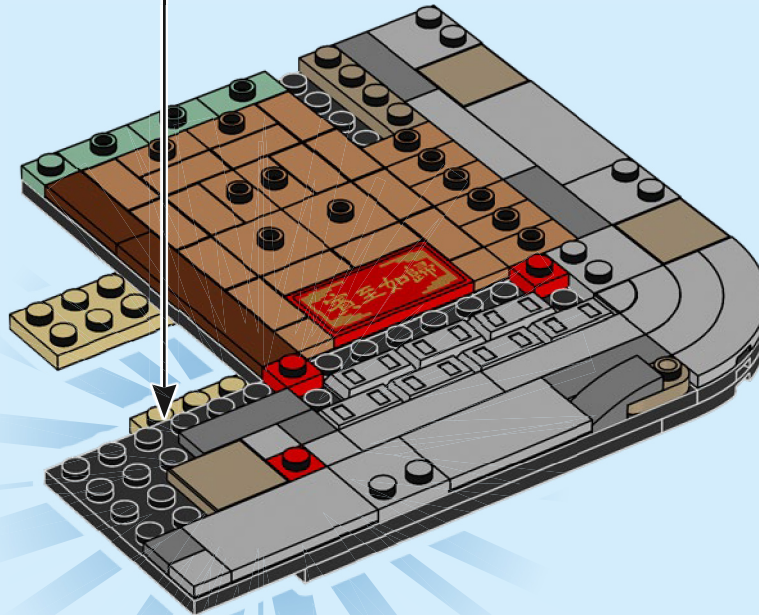

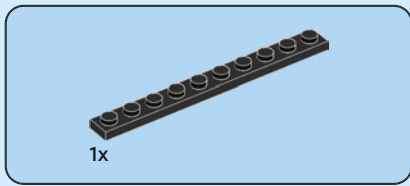

28

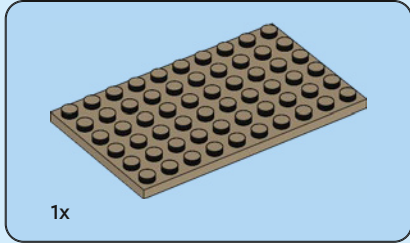
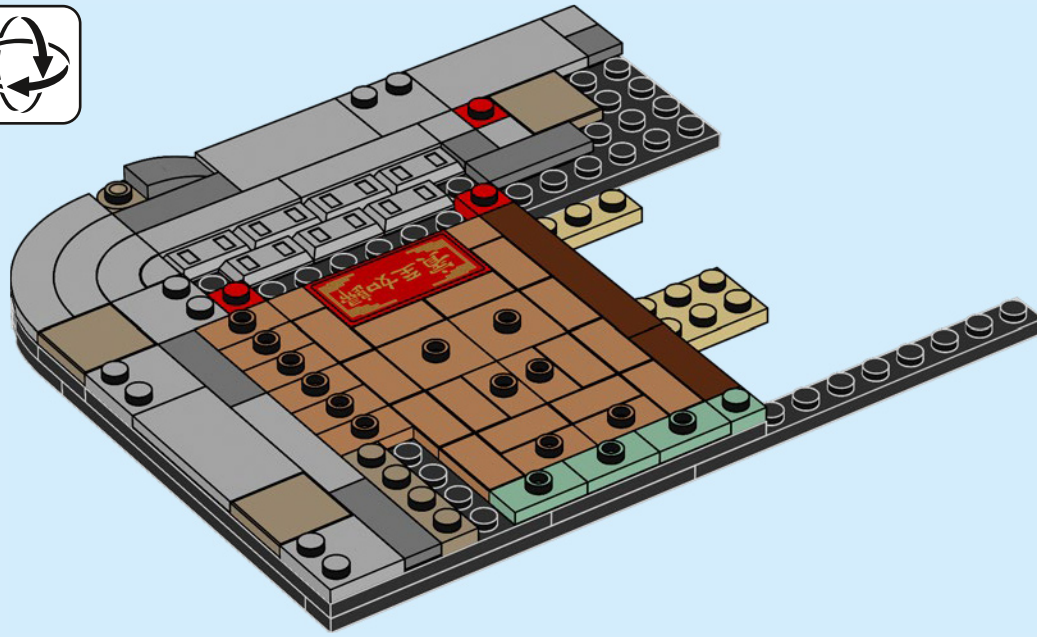

29

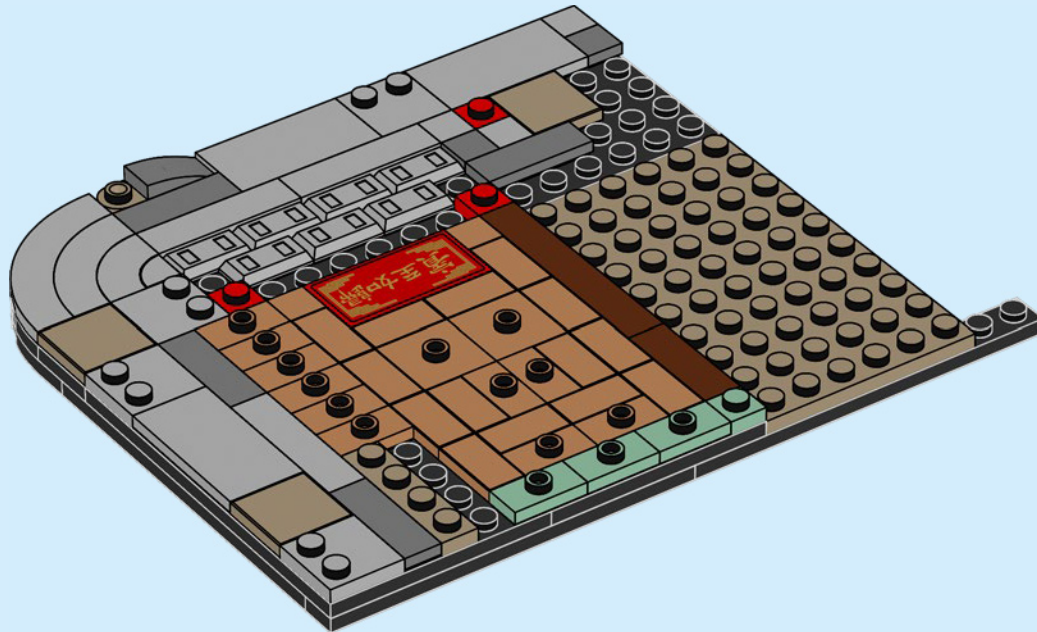

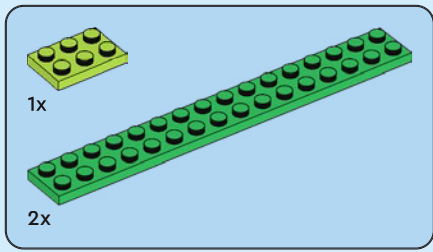

30

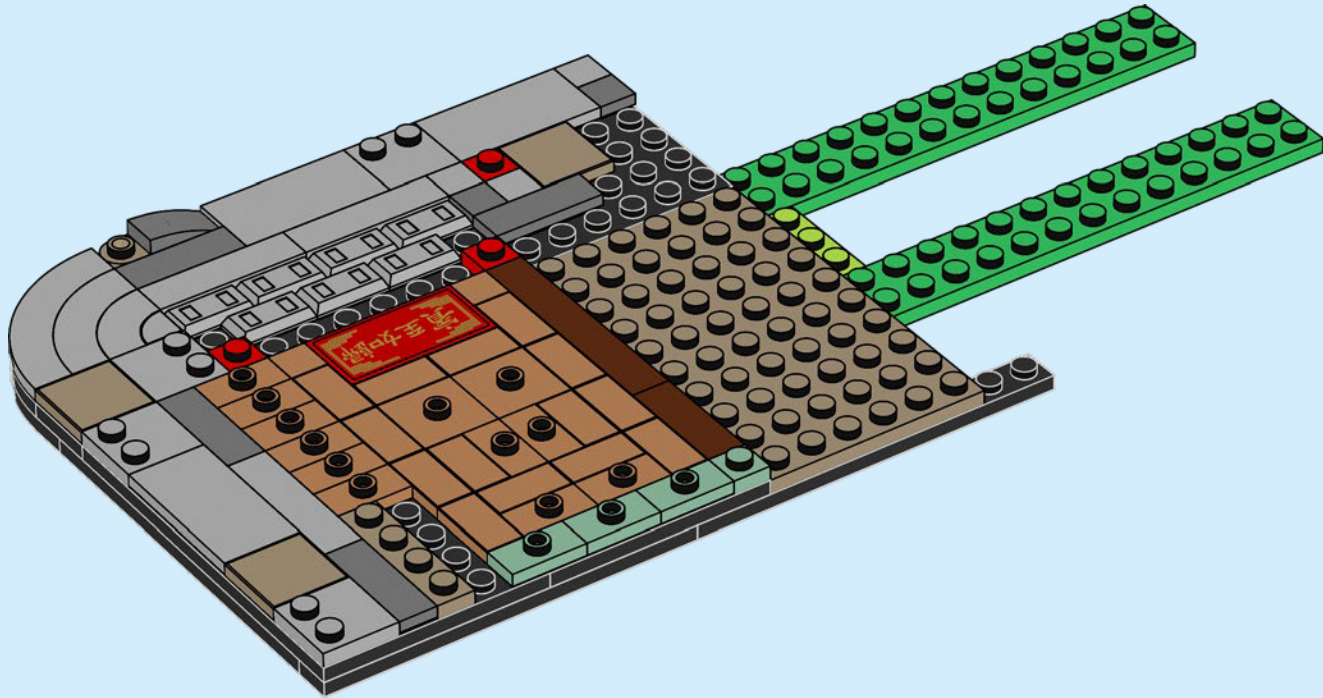

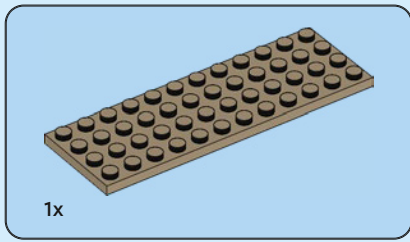

31

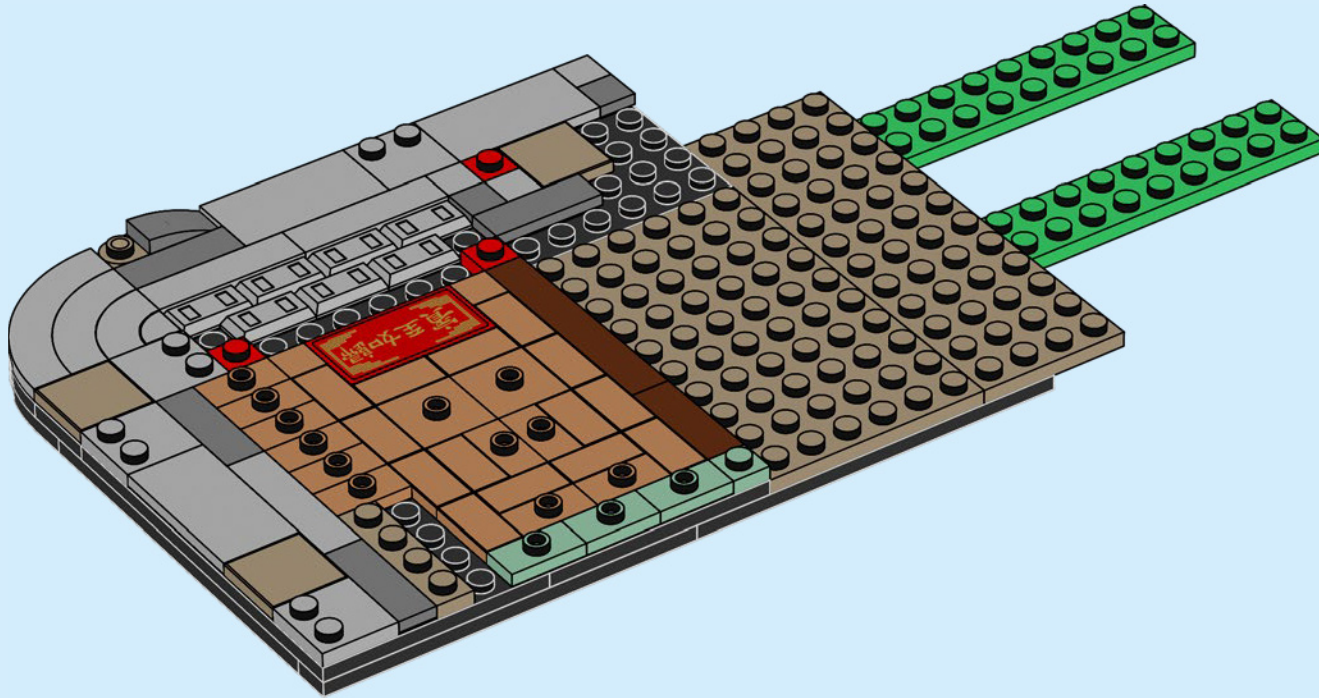

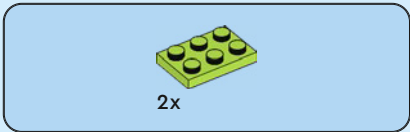

32

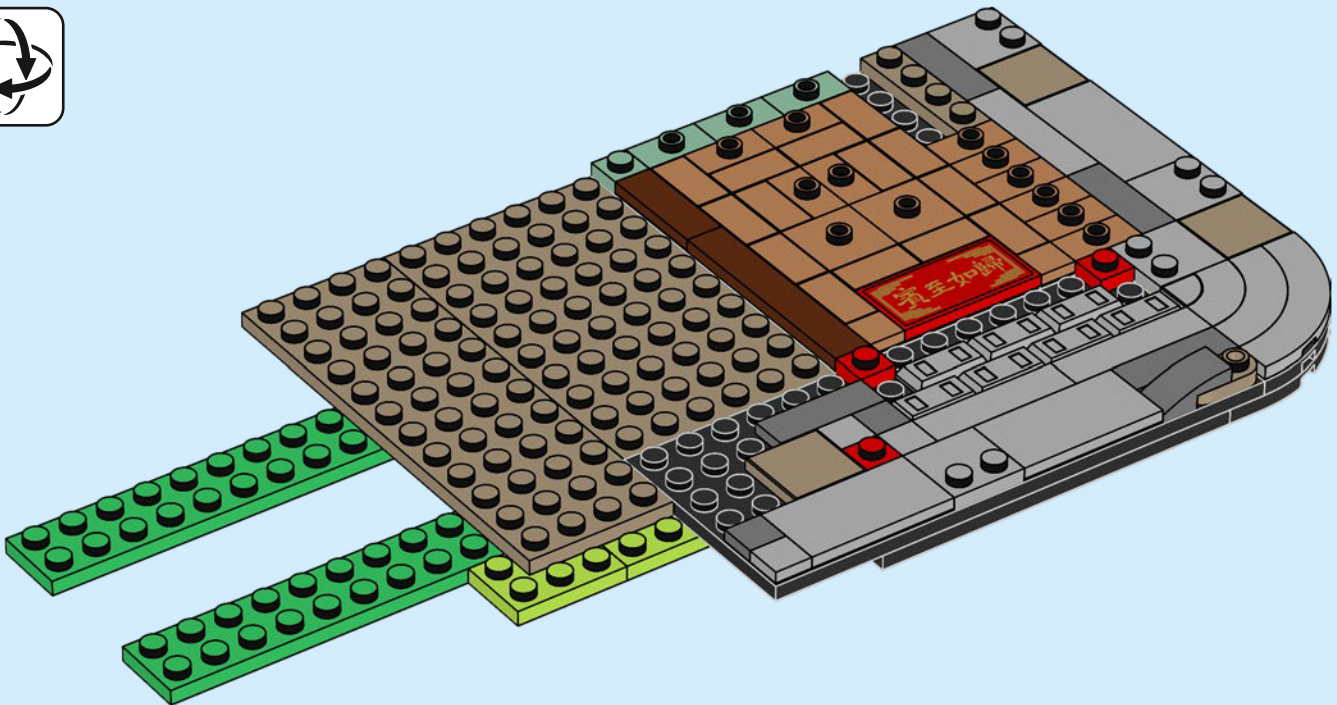

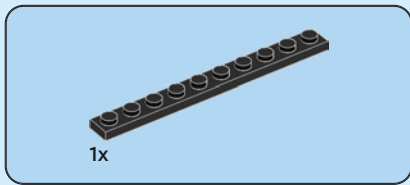

33

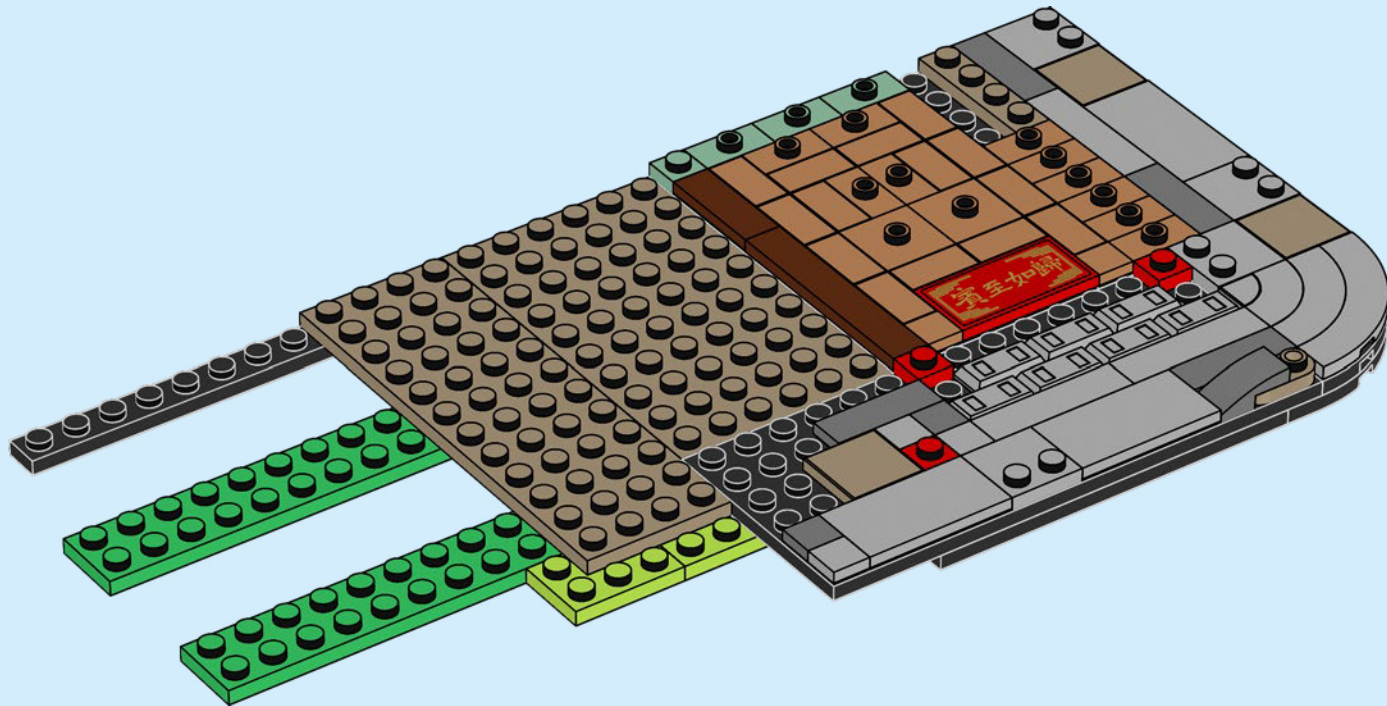

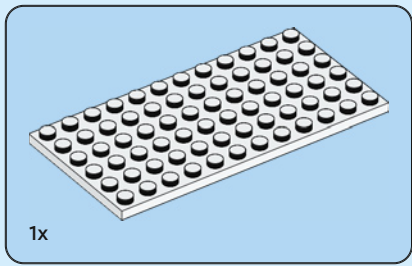

34

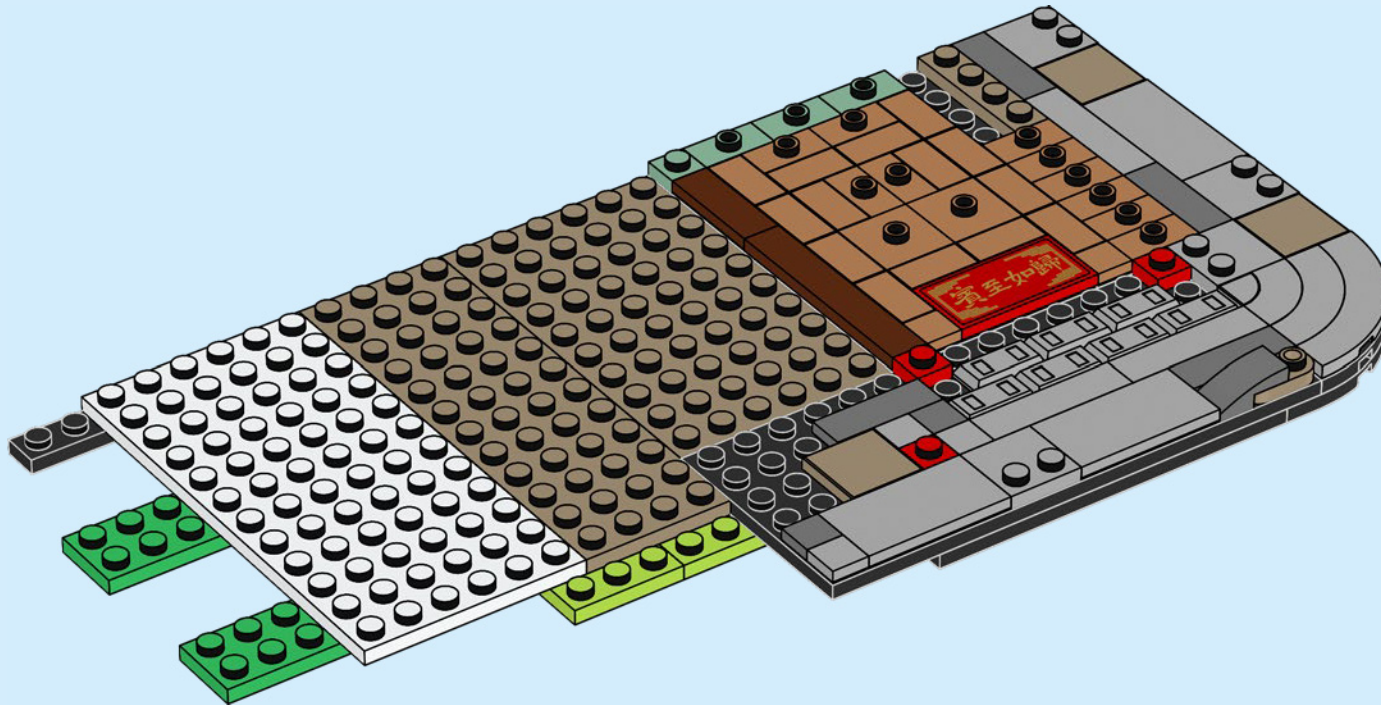

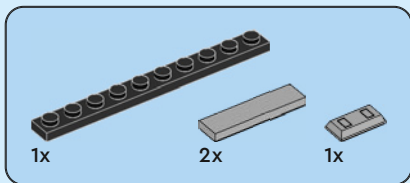

35

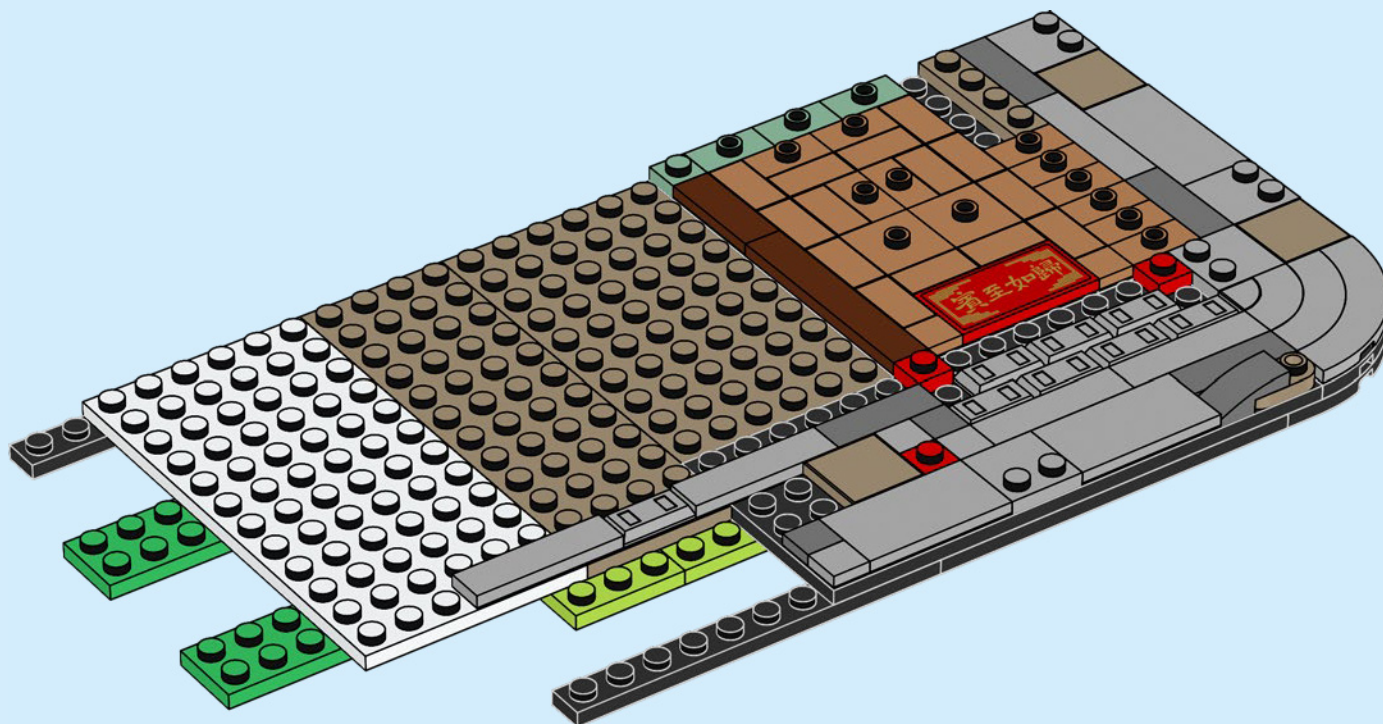

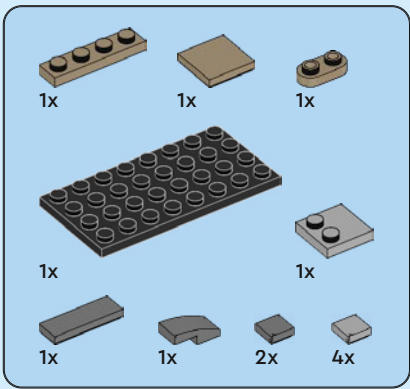

36

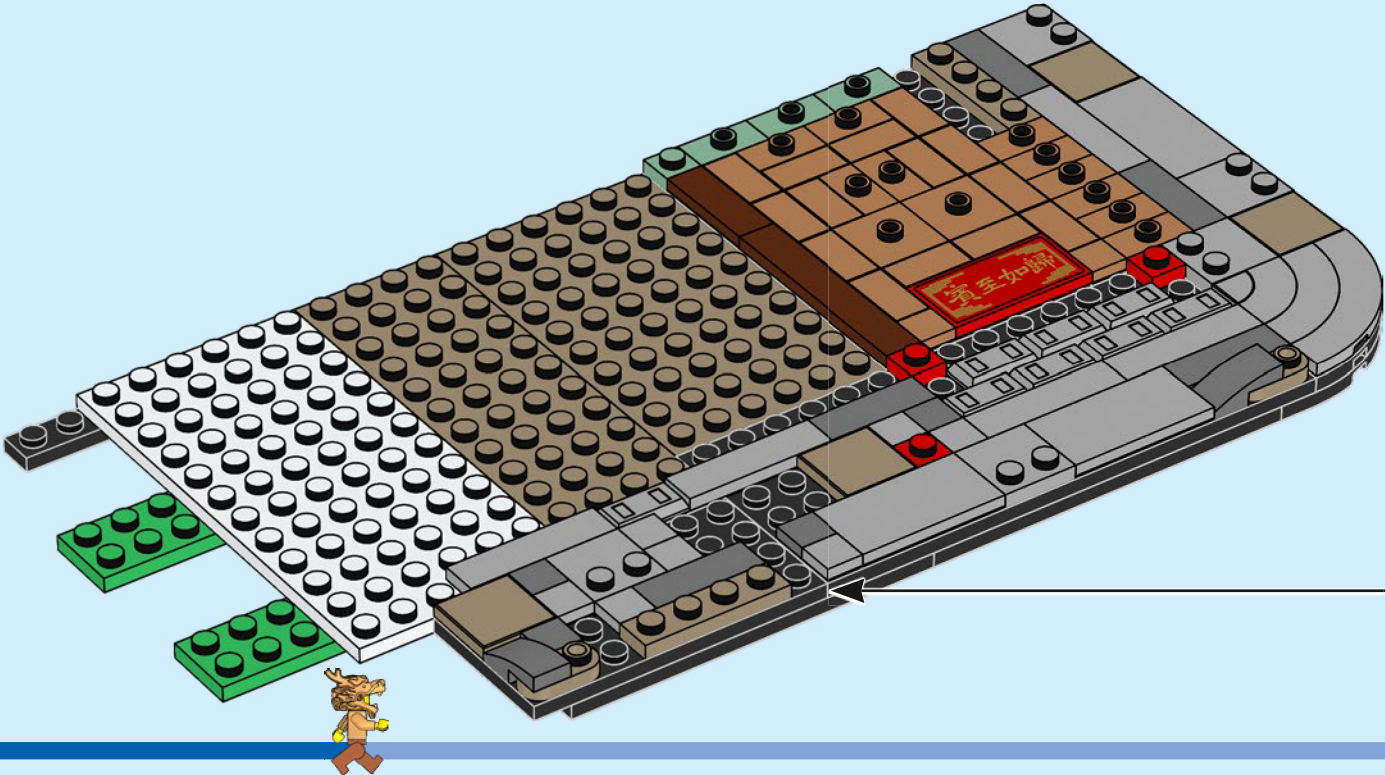
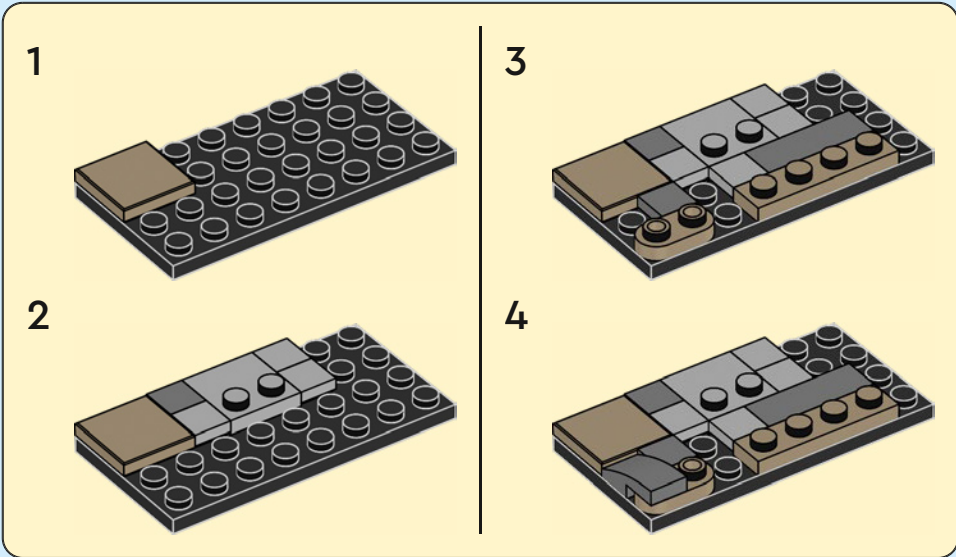

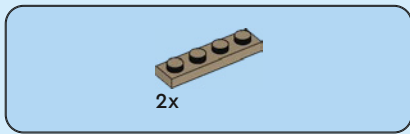

37

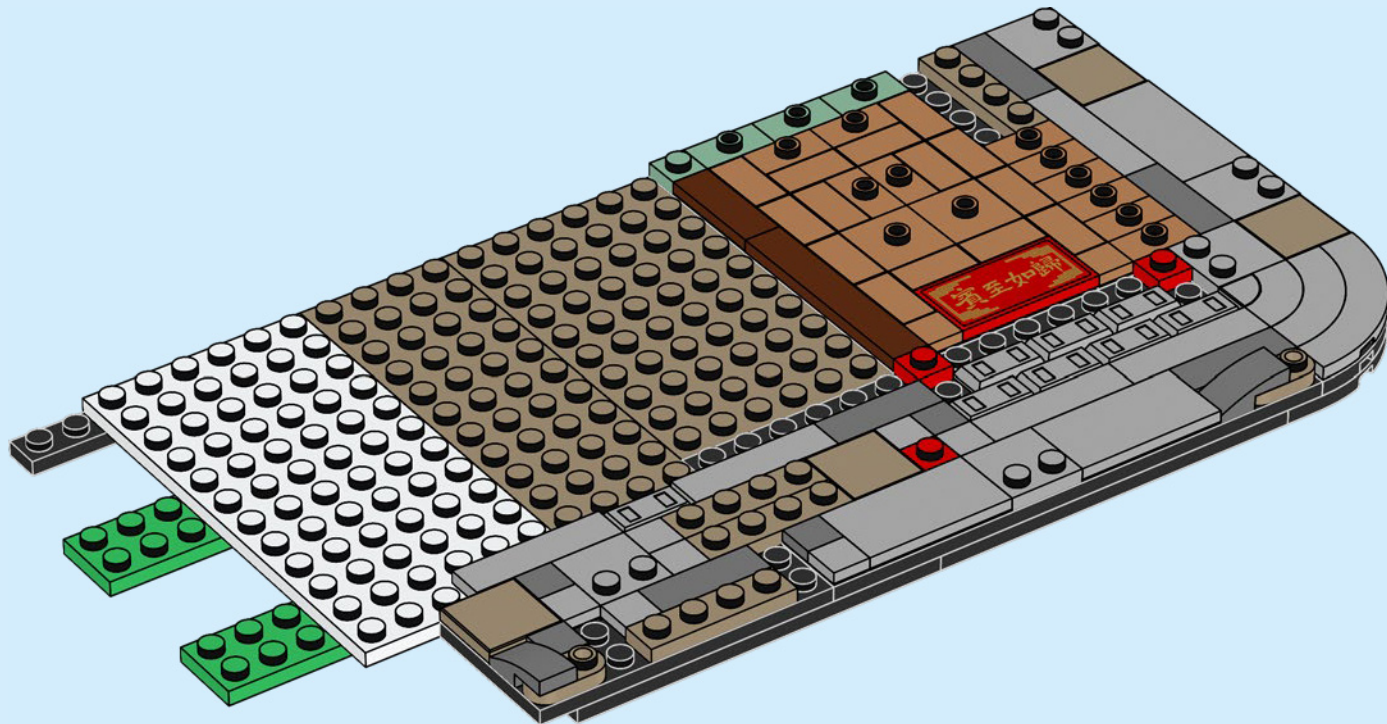

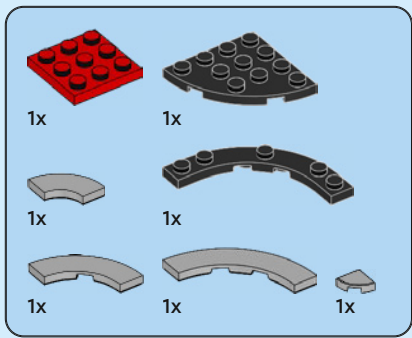

38

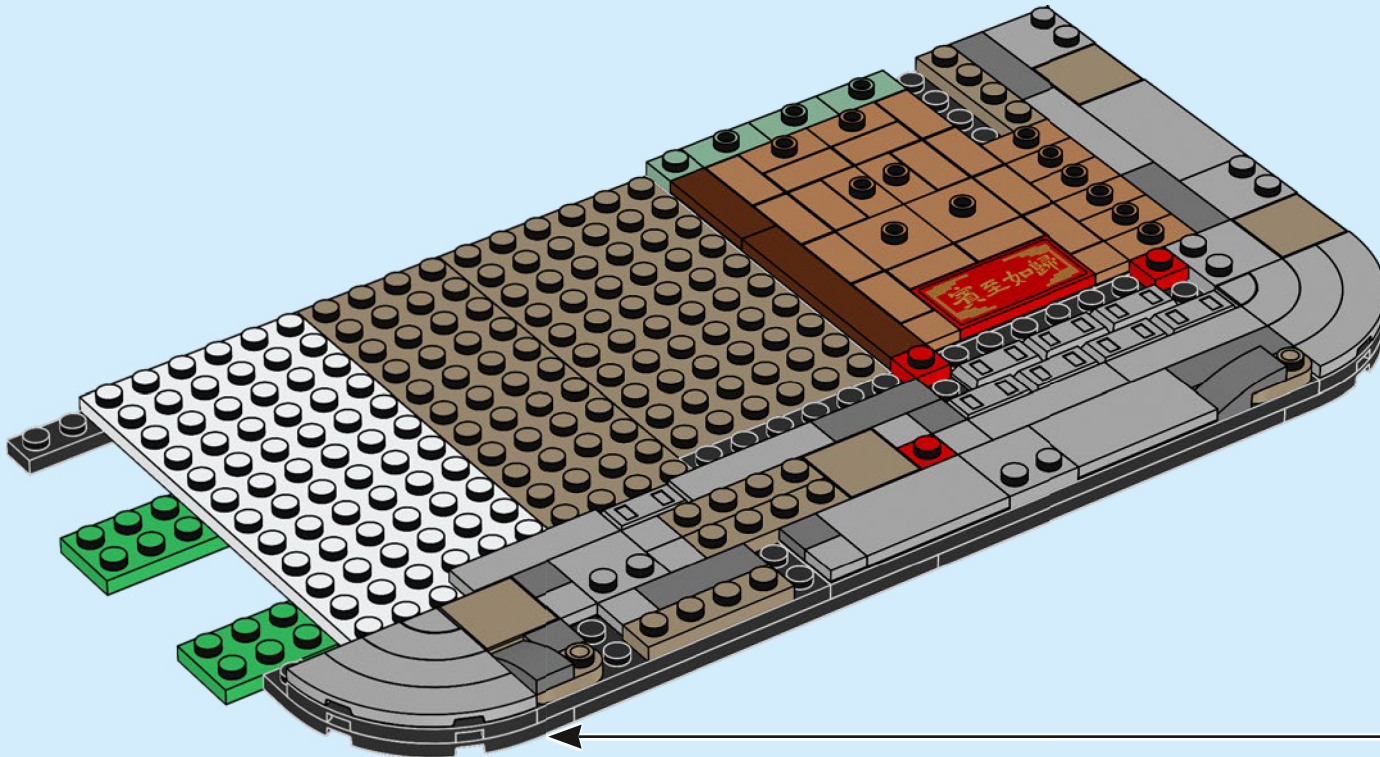
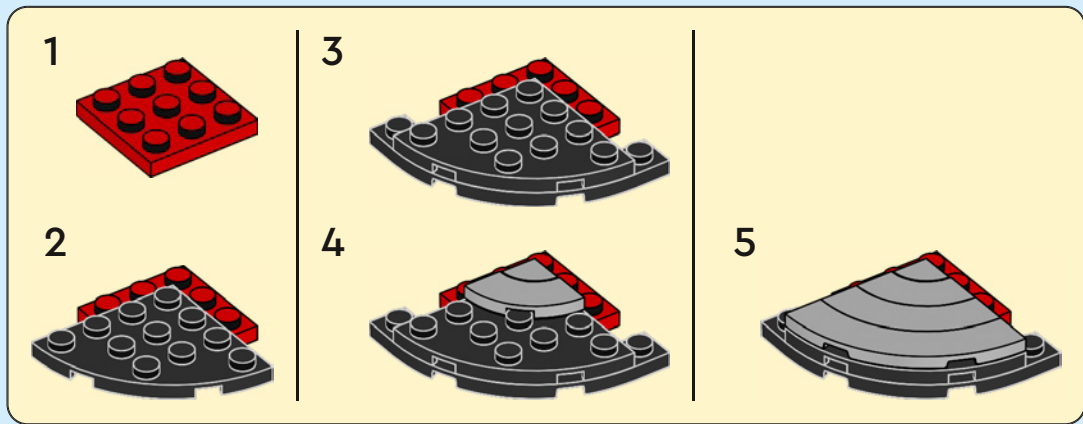

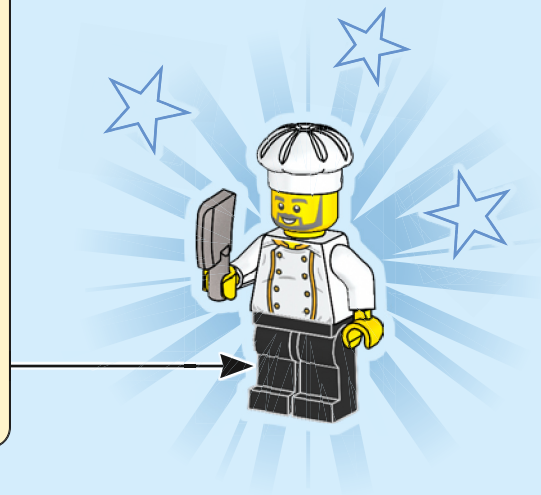
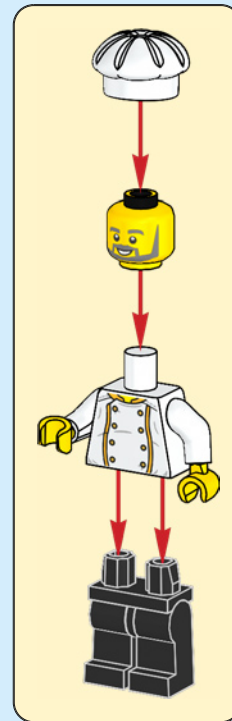

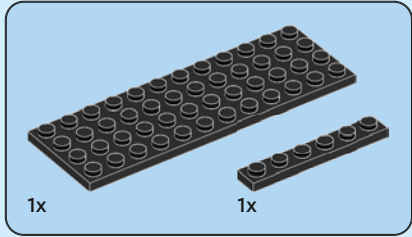
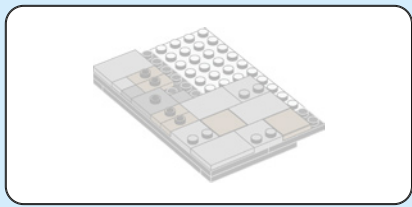

39

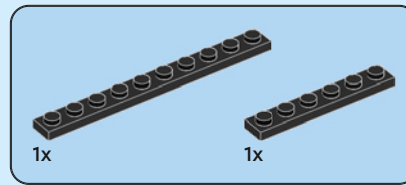
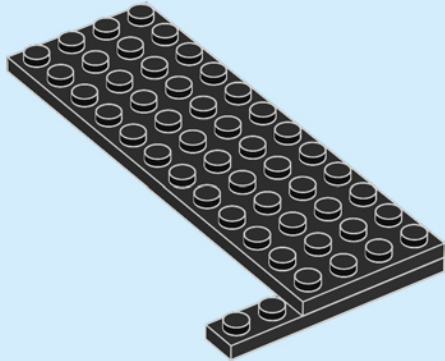

40

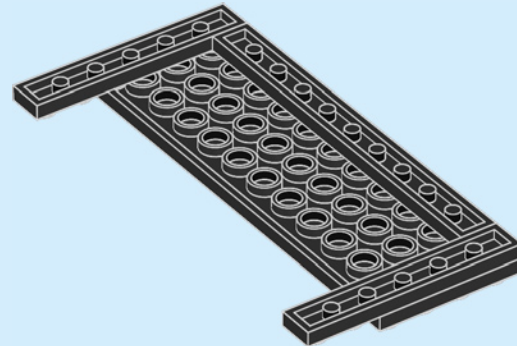

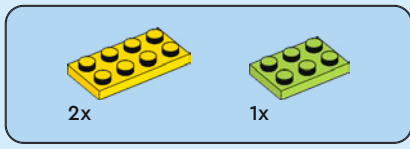

41

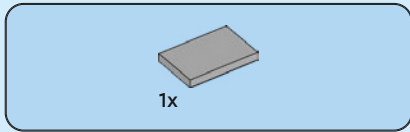
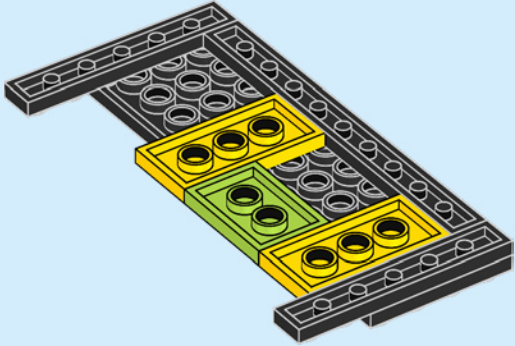

42

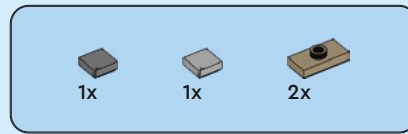
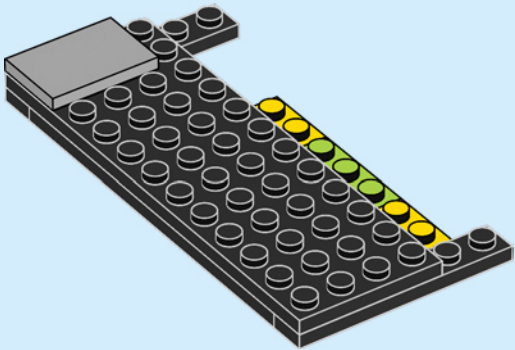

43

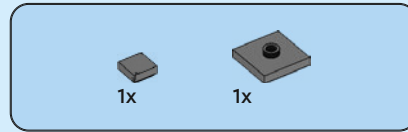
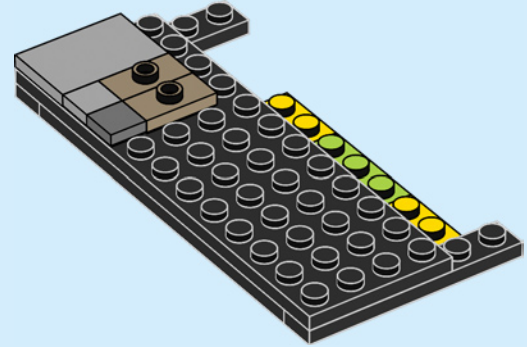

44

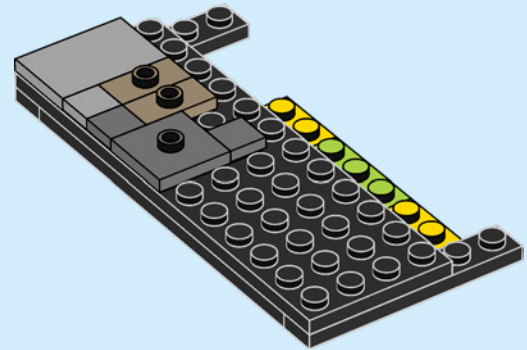

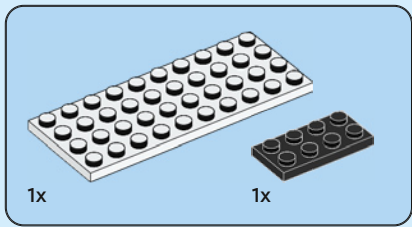

45

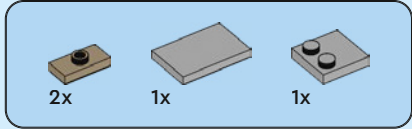
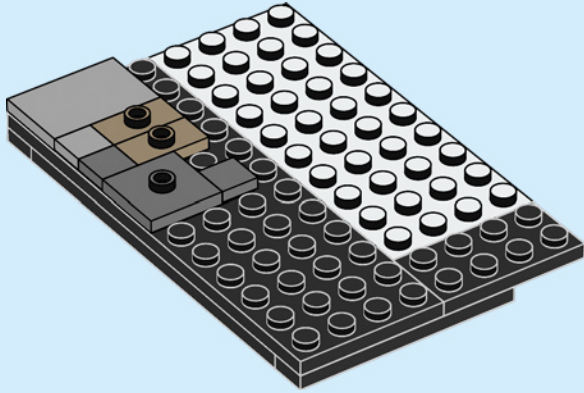

46

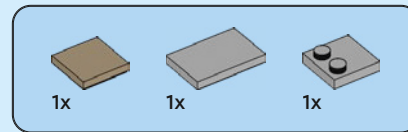
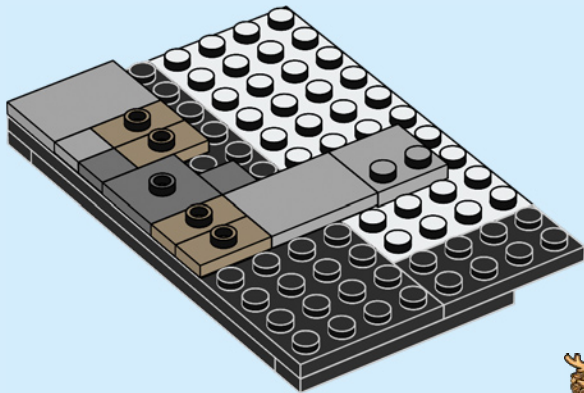

47

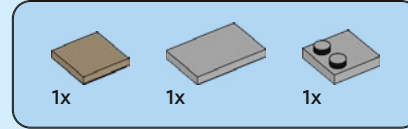
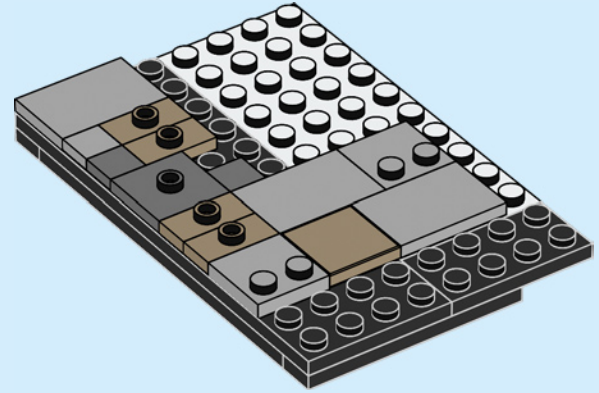

48

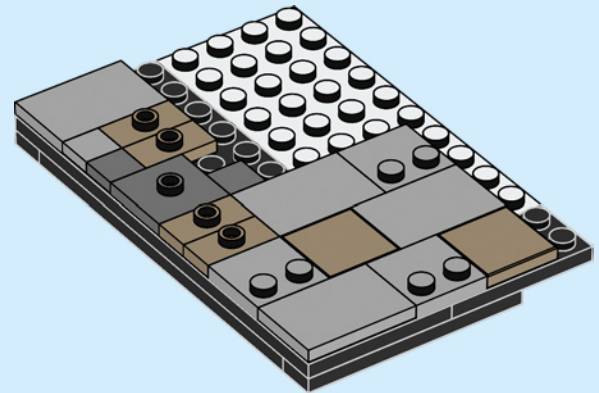

49

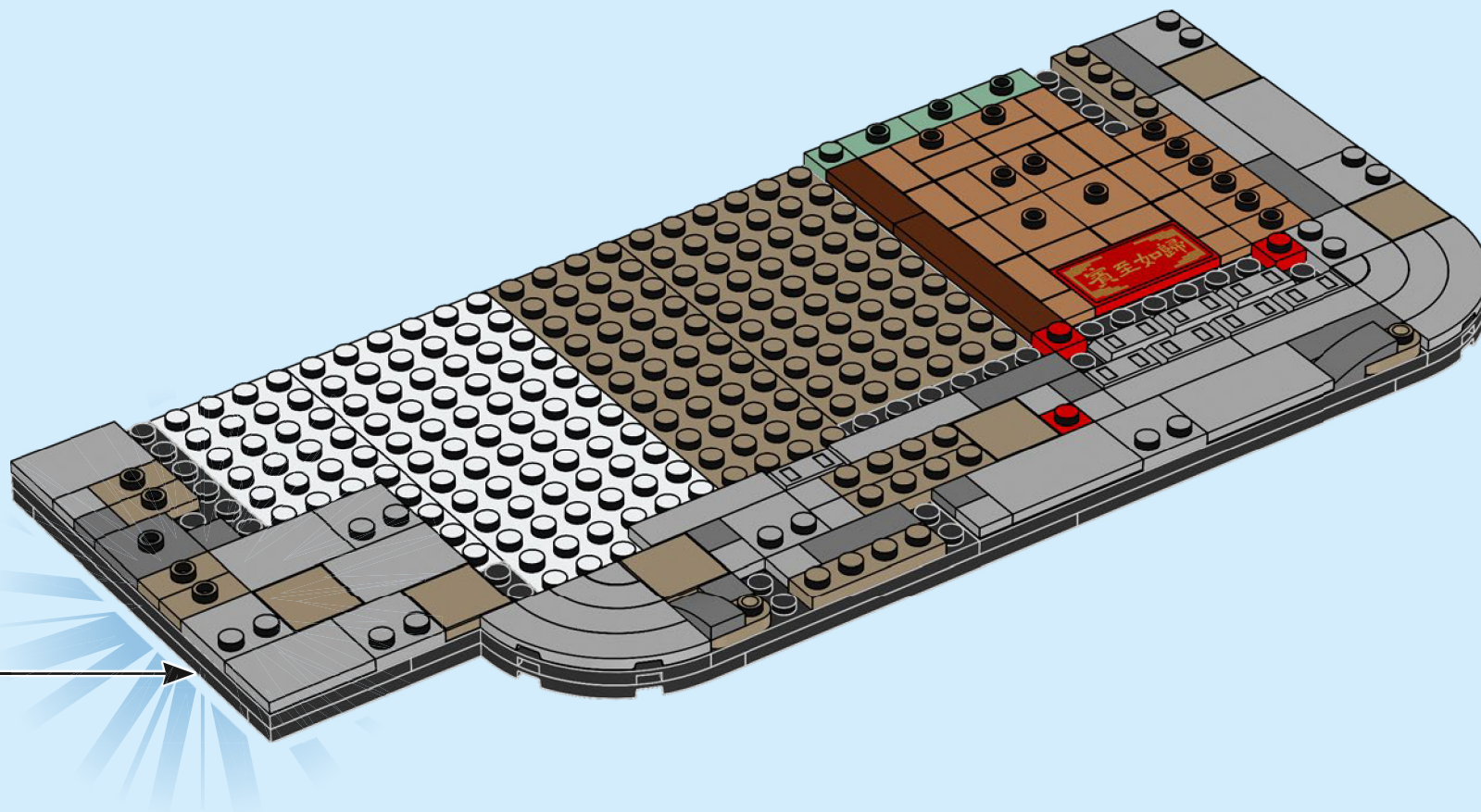

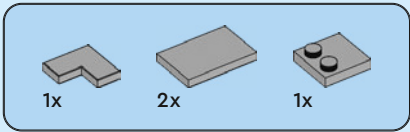

50

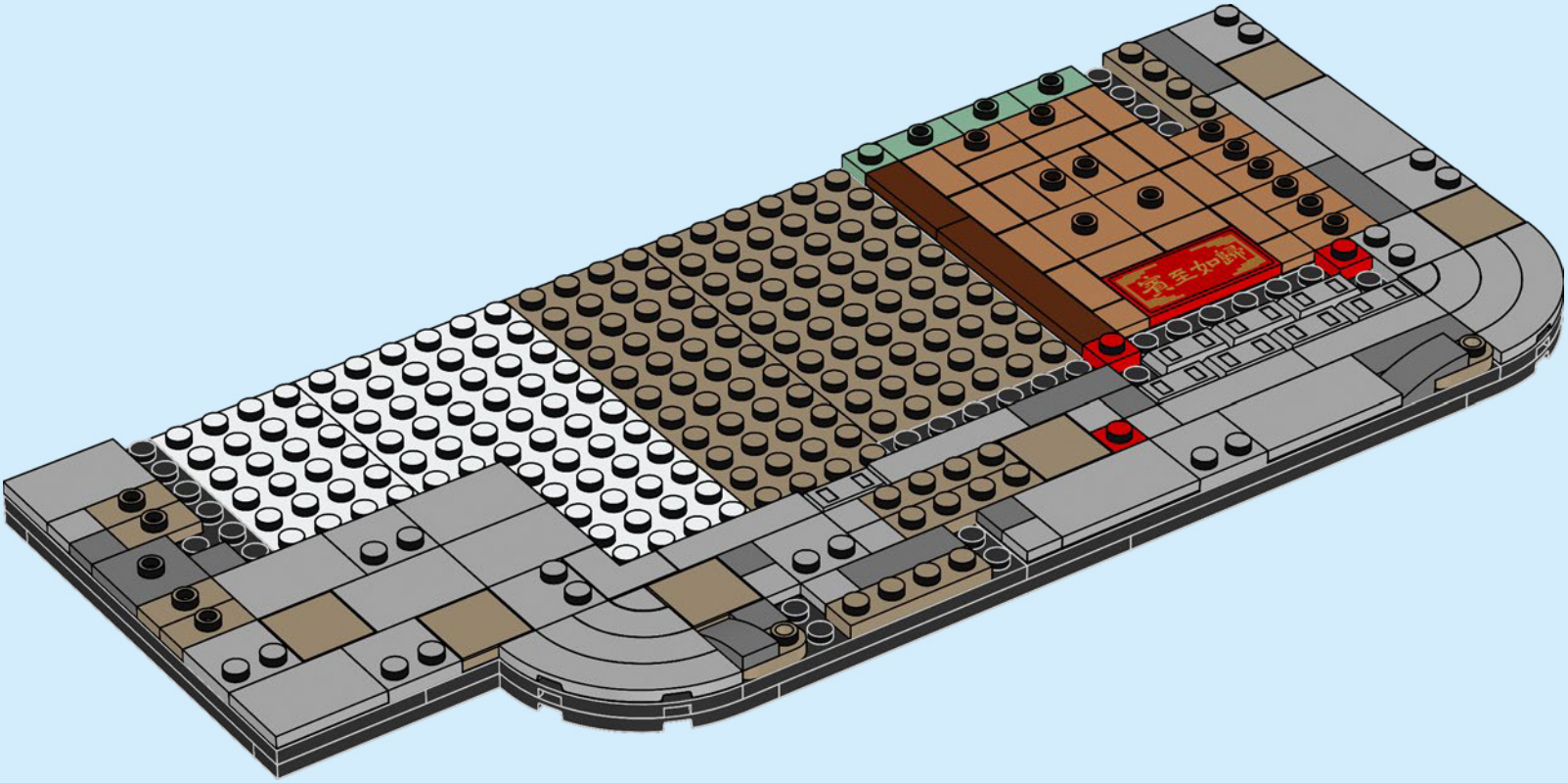

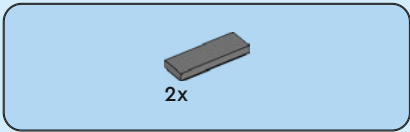

51

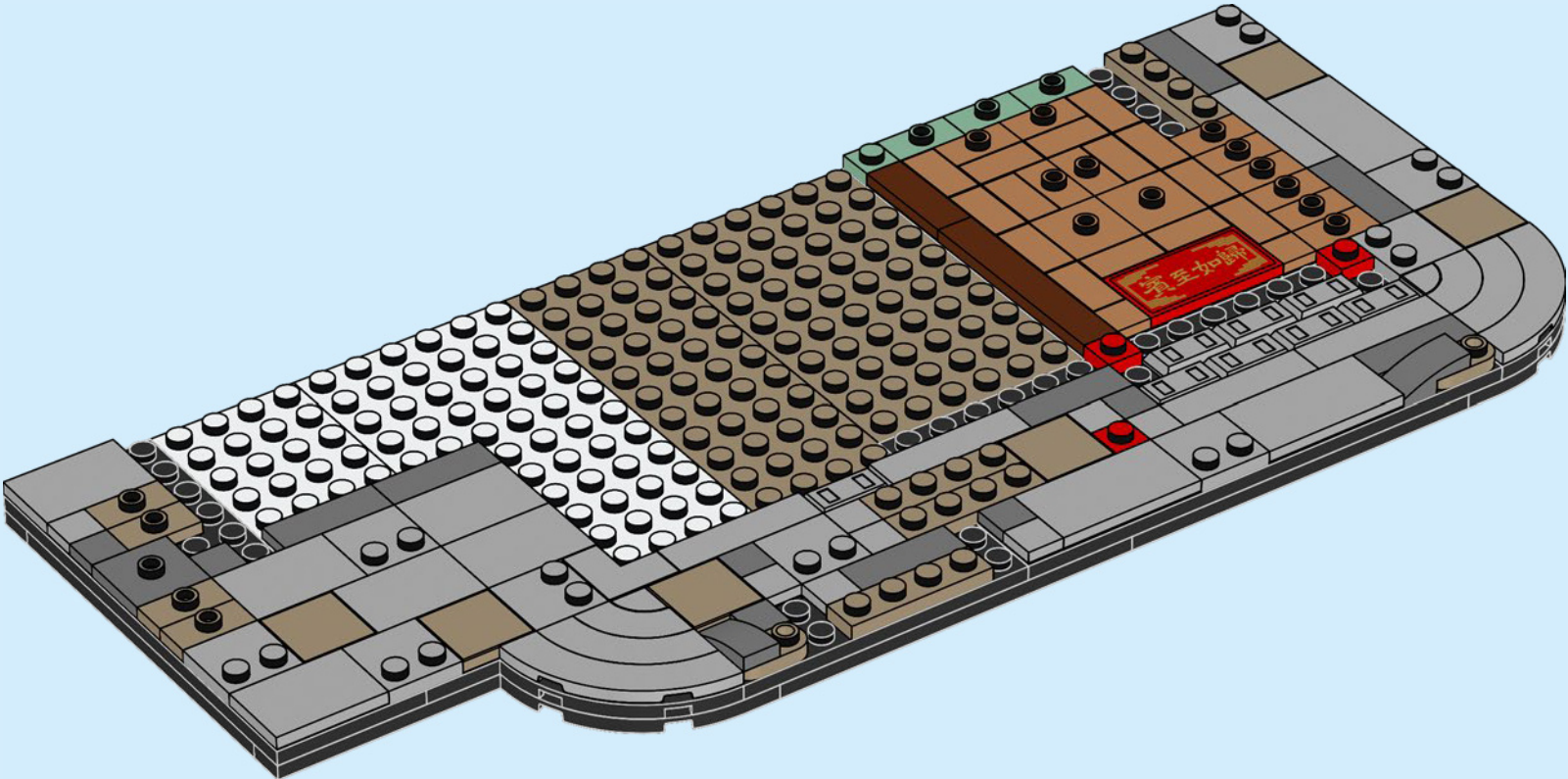

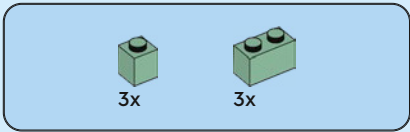

52

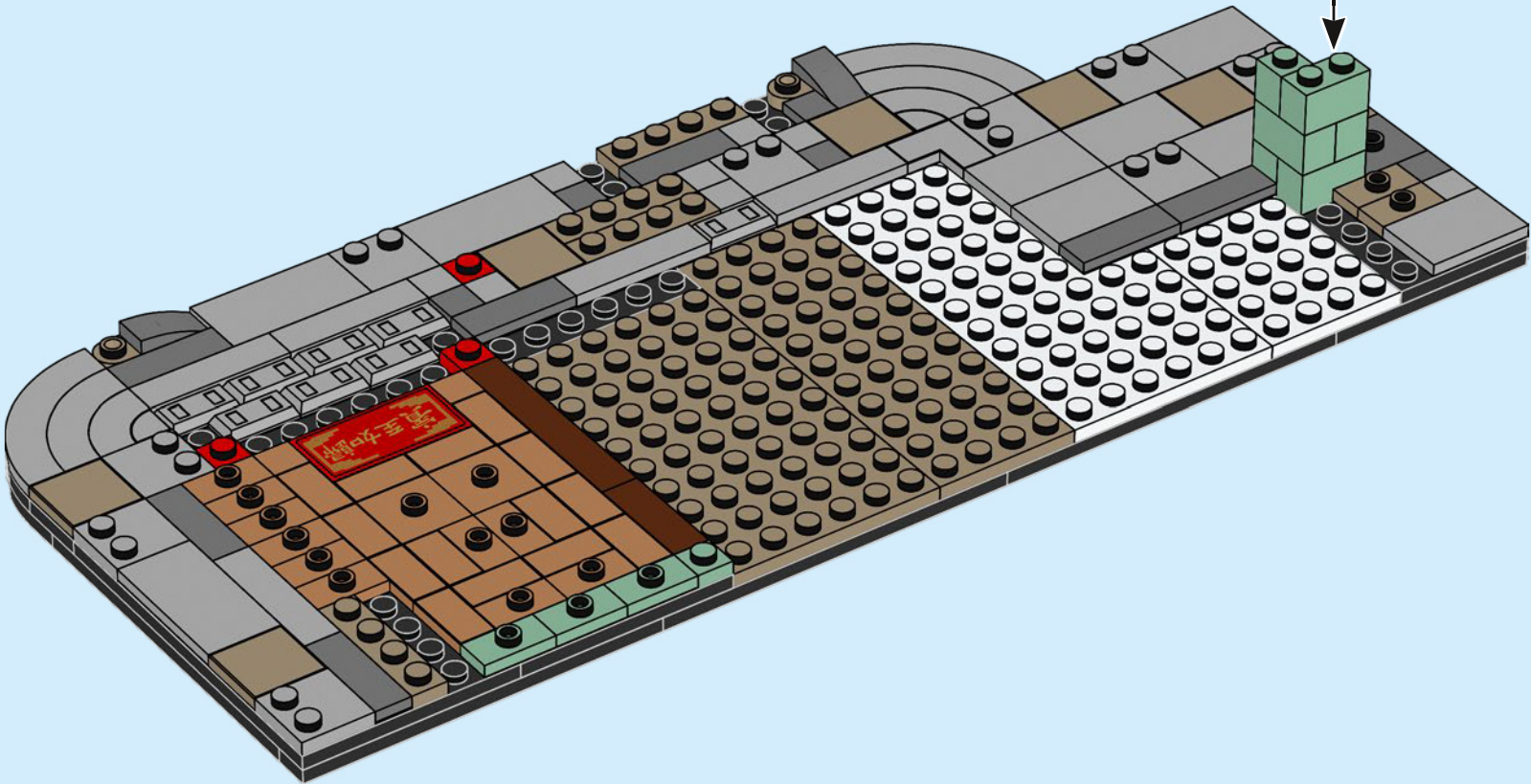
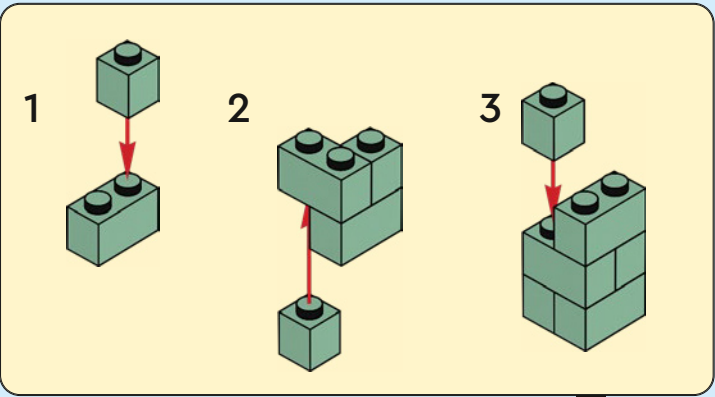

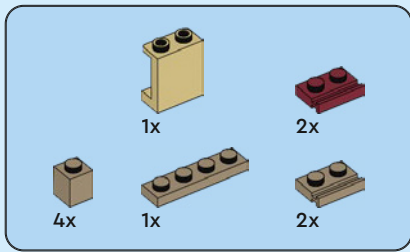

53

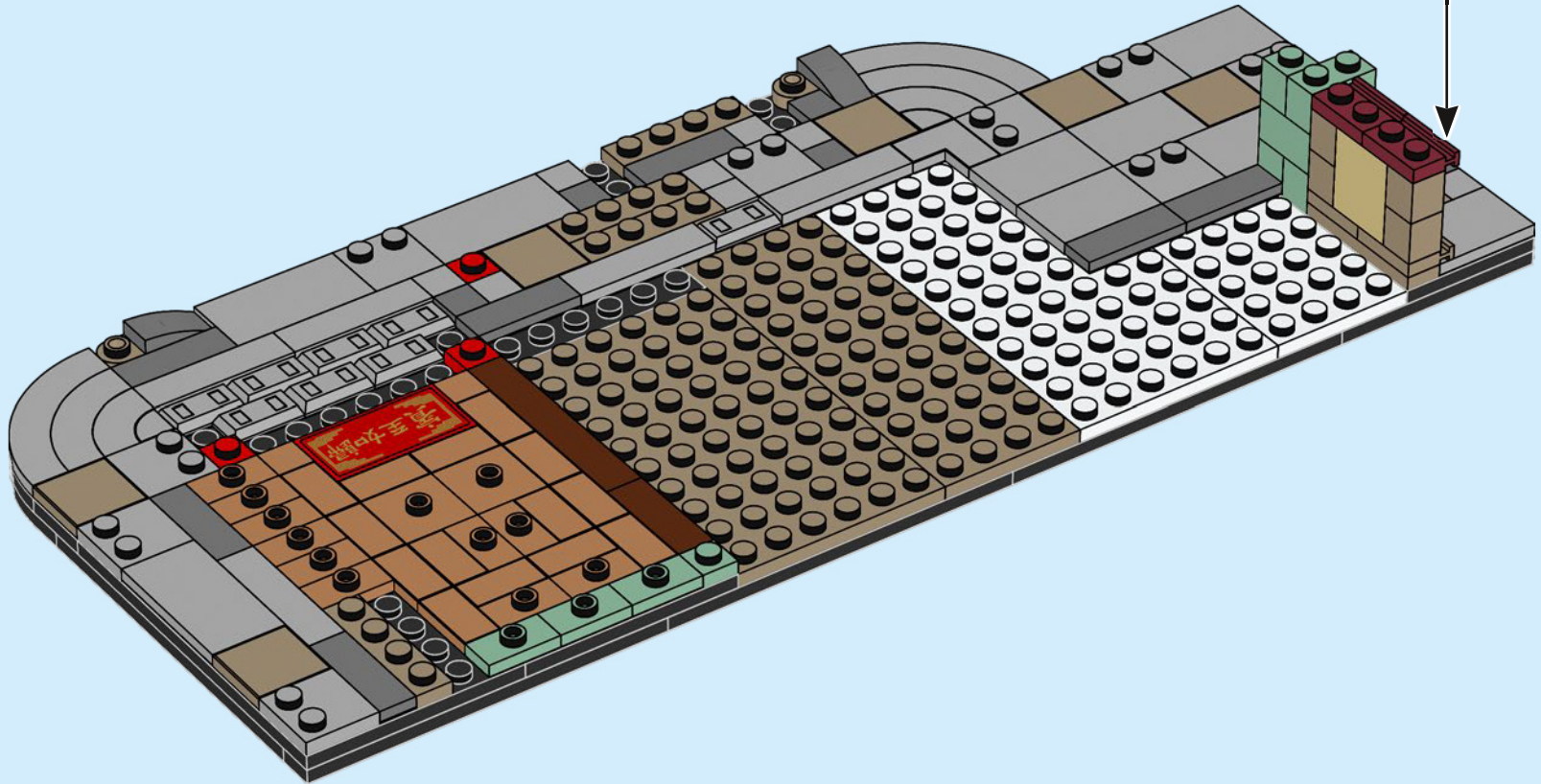
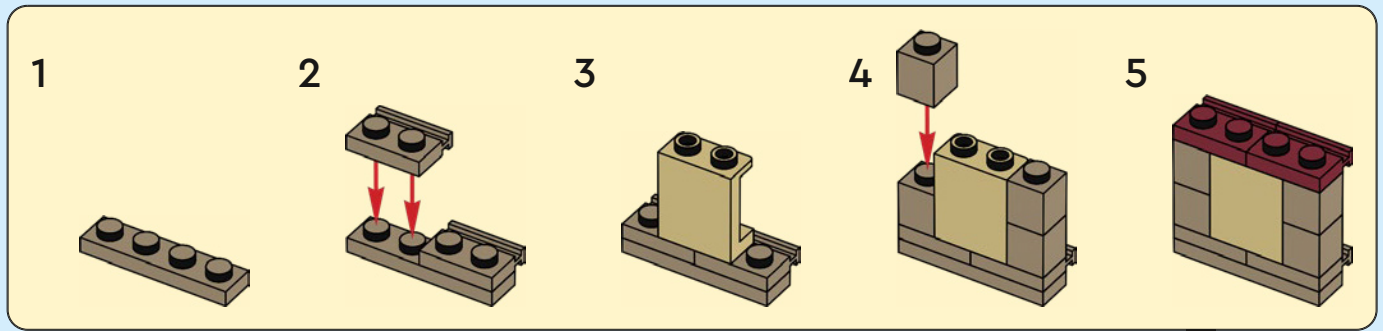

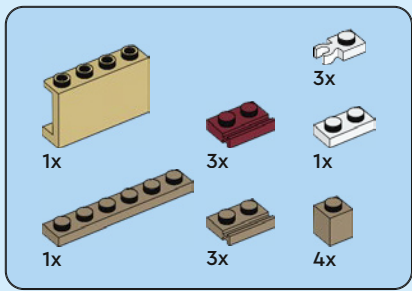

54

1

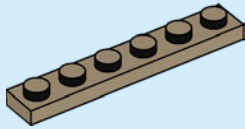

2

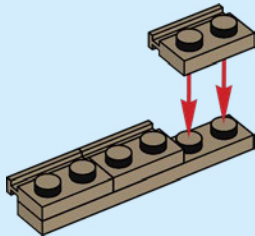

3

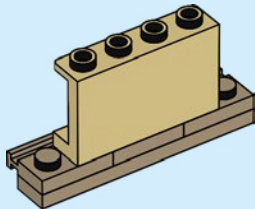

4

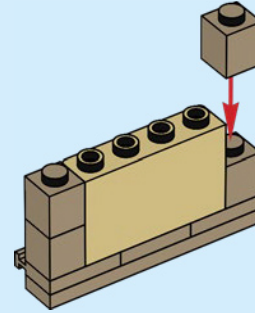

5

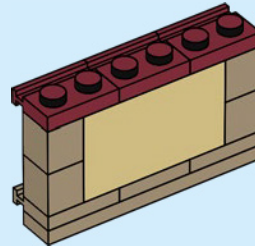

6

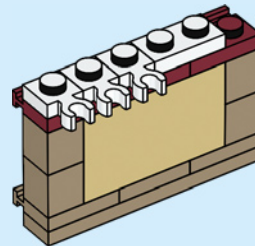

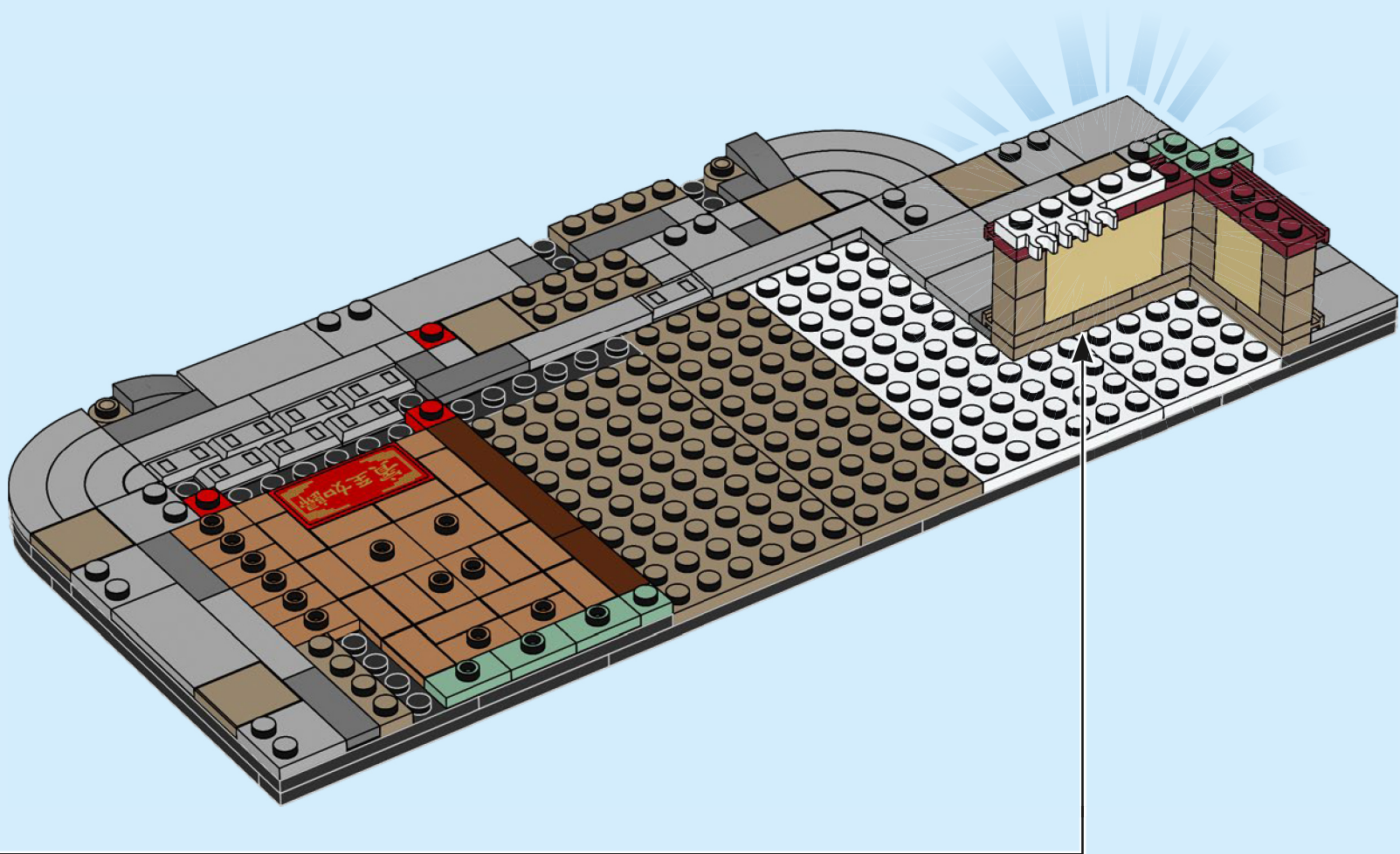

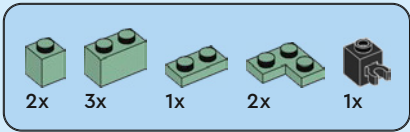

55

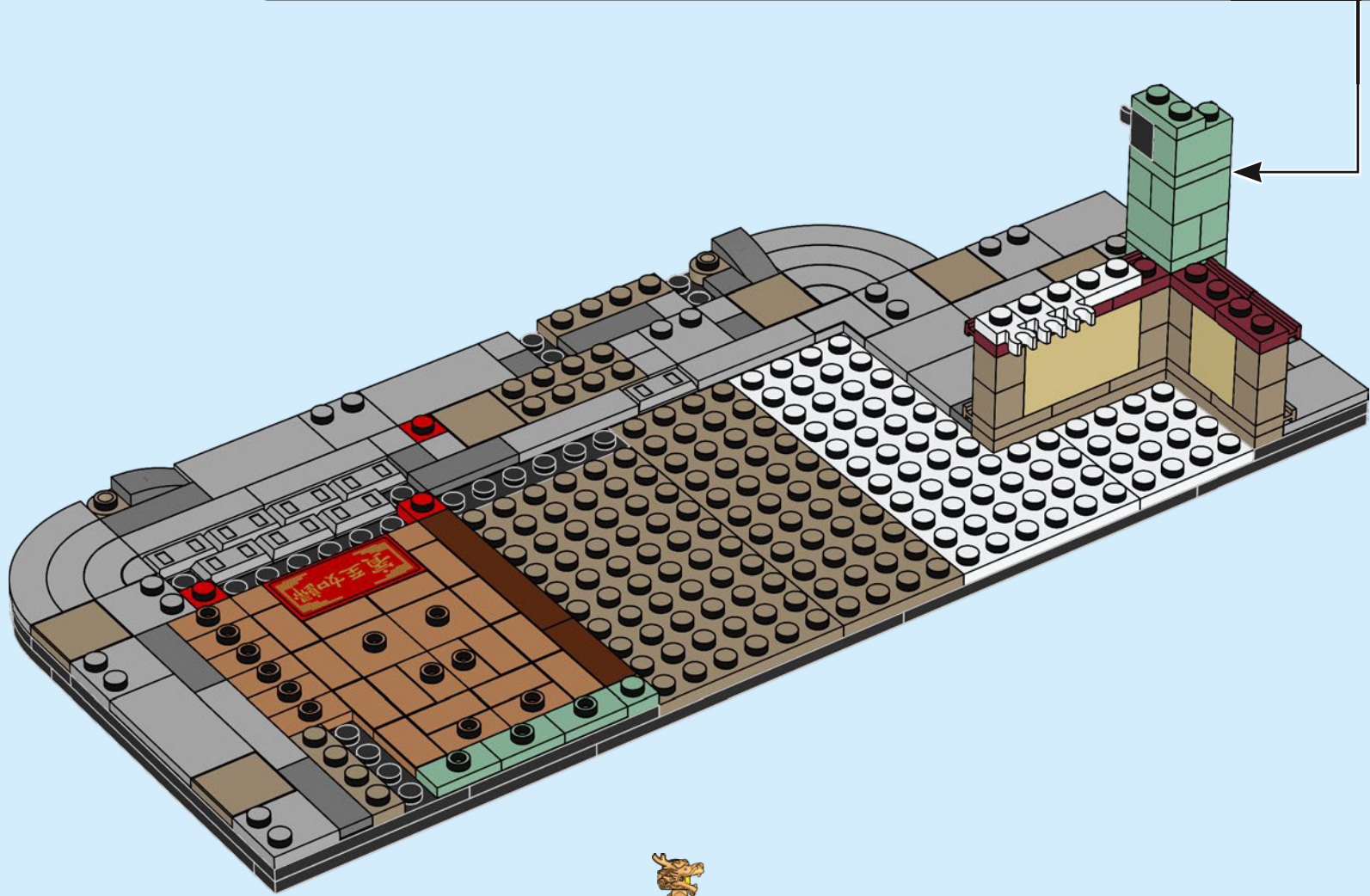
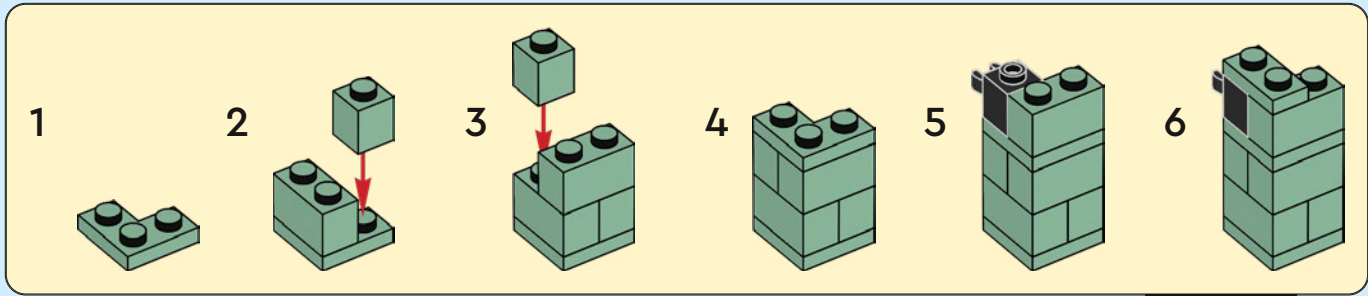

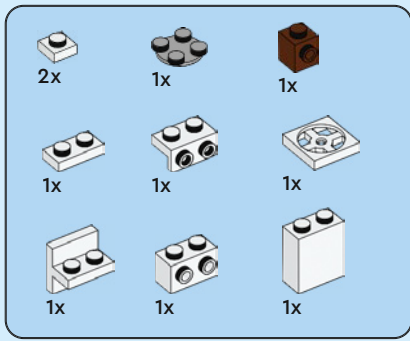

56

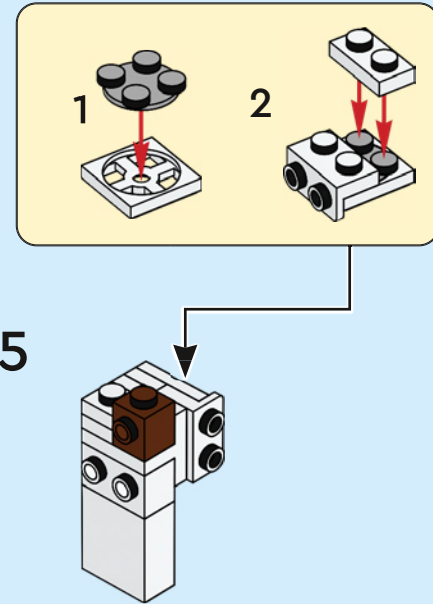
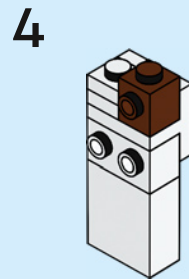
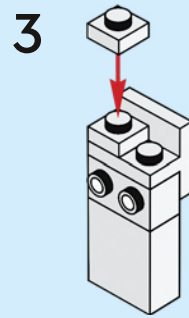
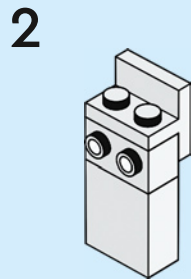
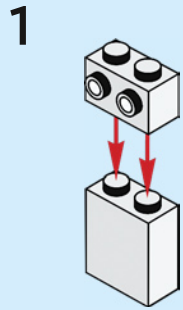

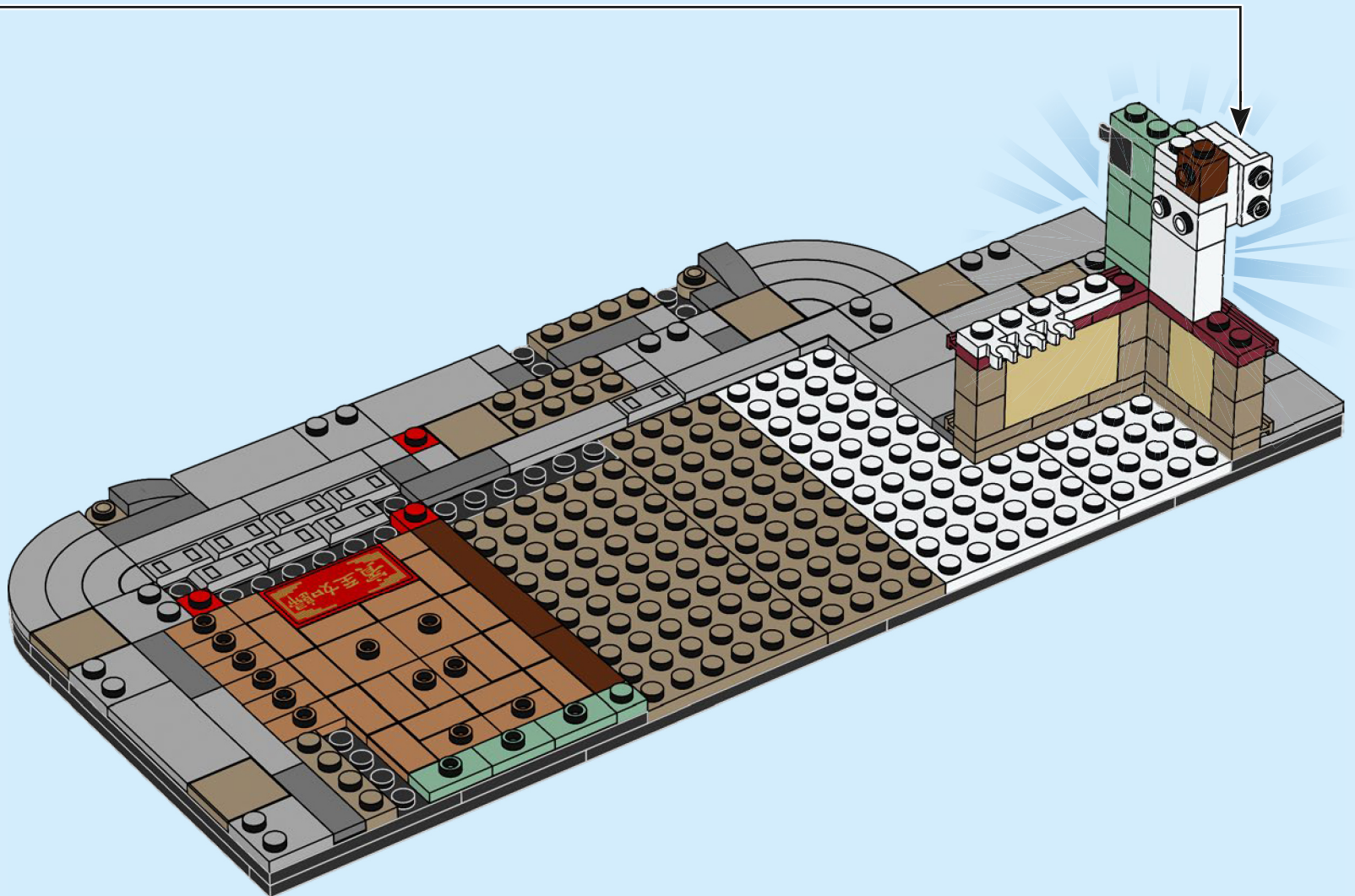

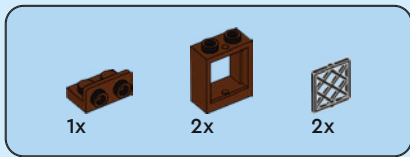

57

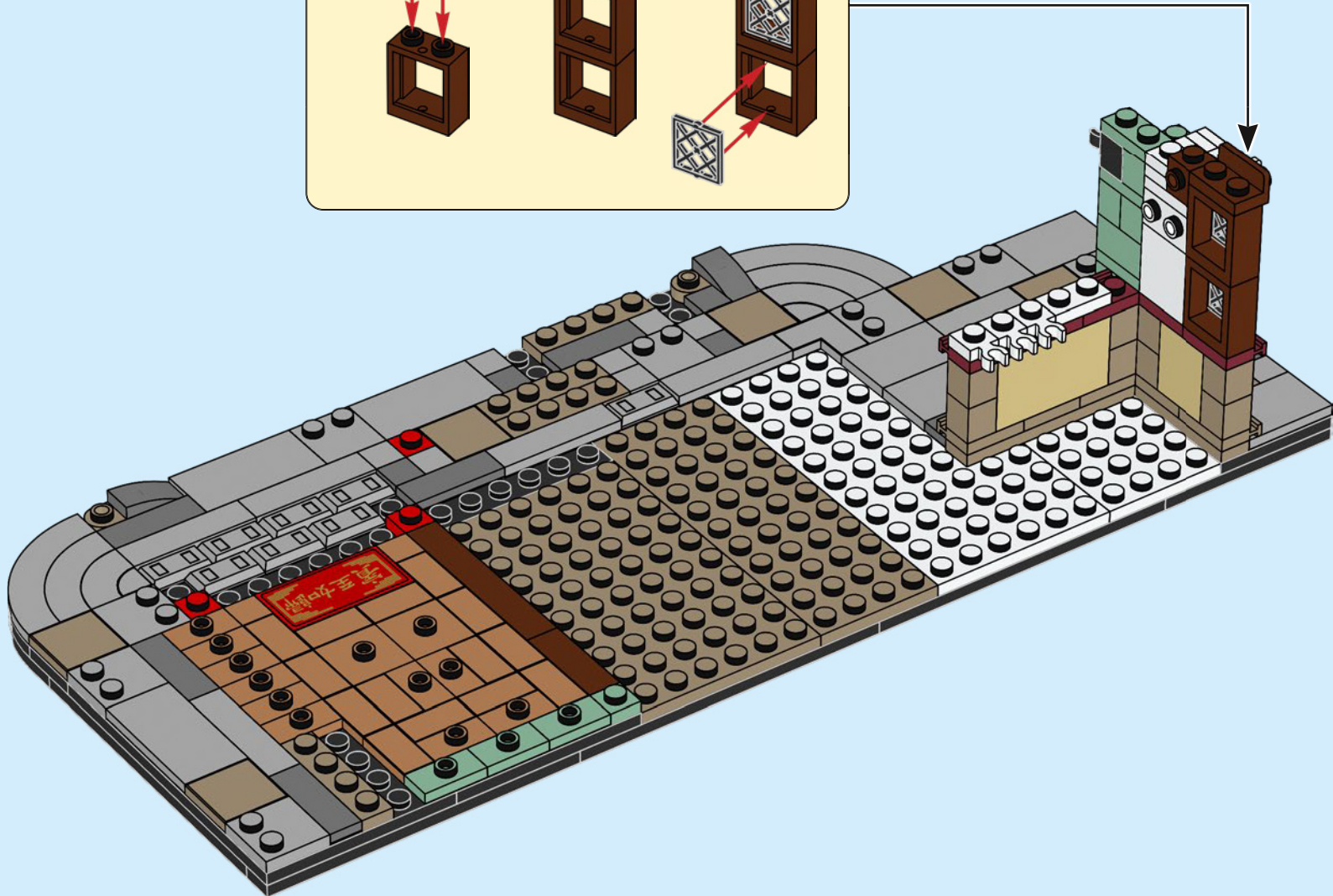
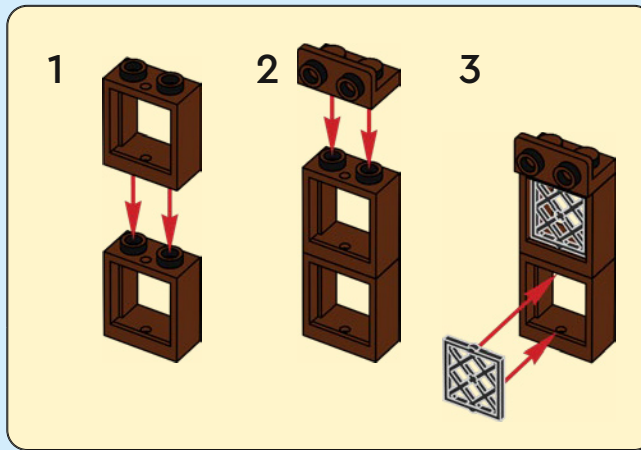

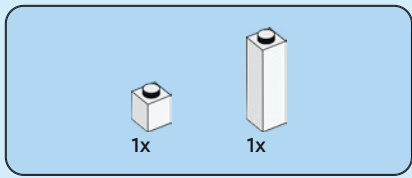

58

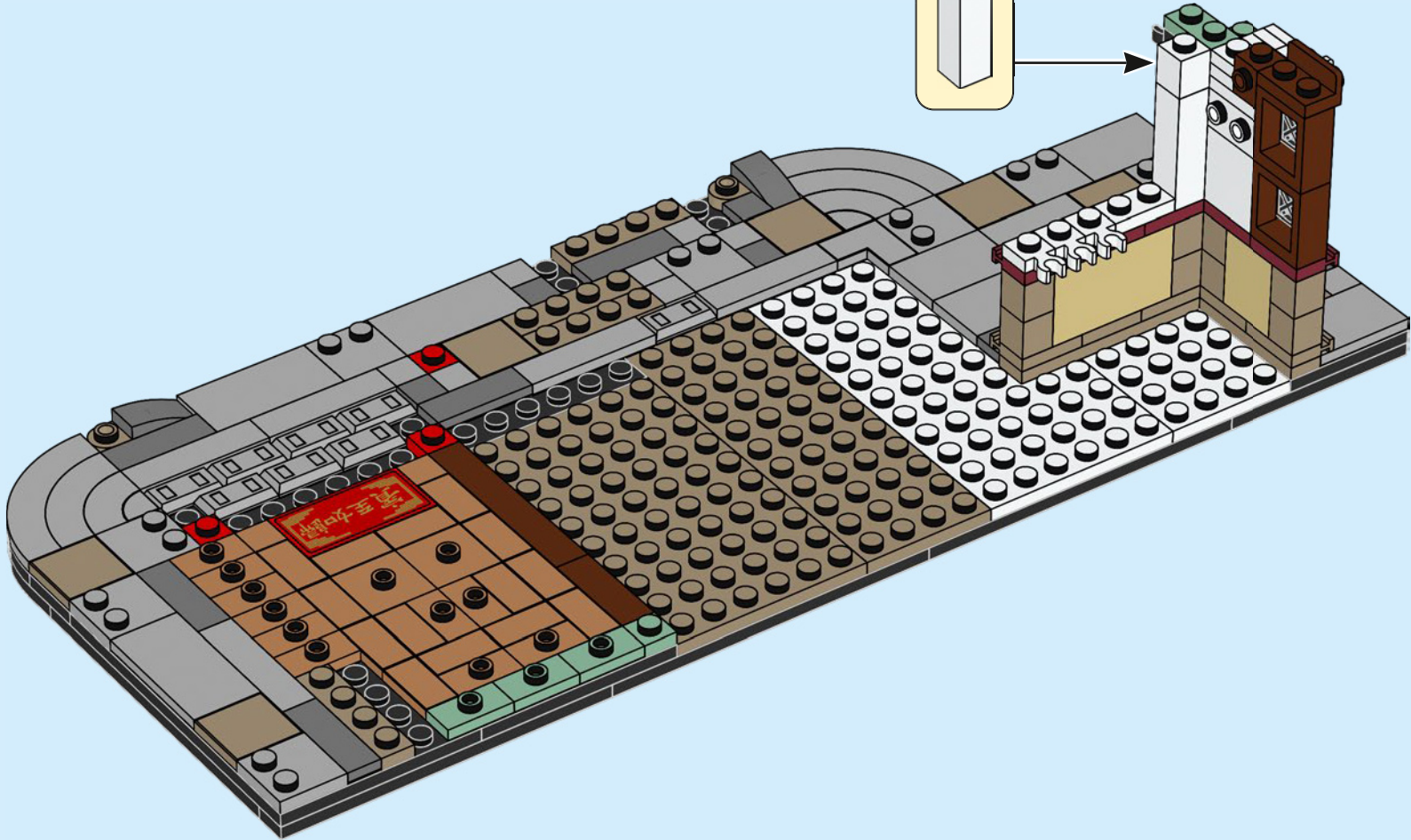
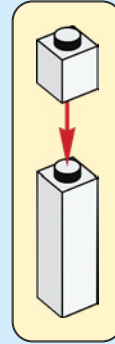

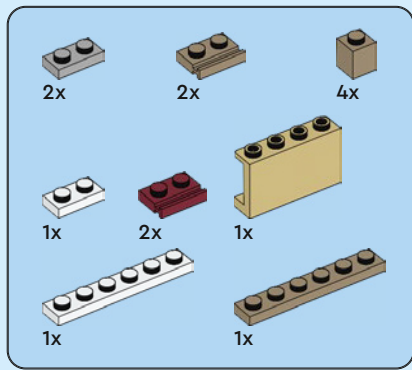

59

1

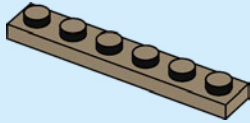

2

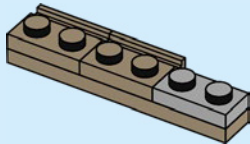

3

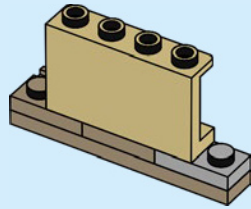

4

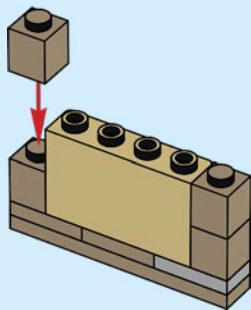

5

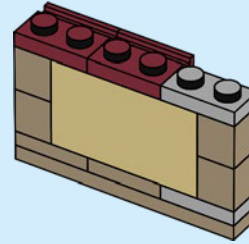

6

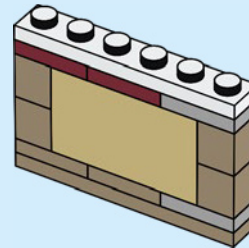

7

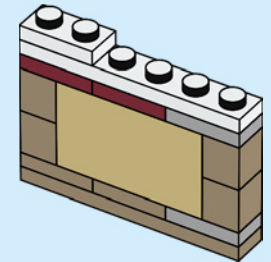

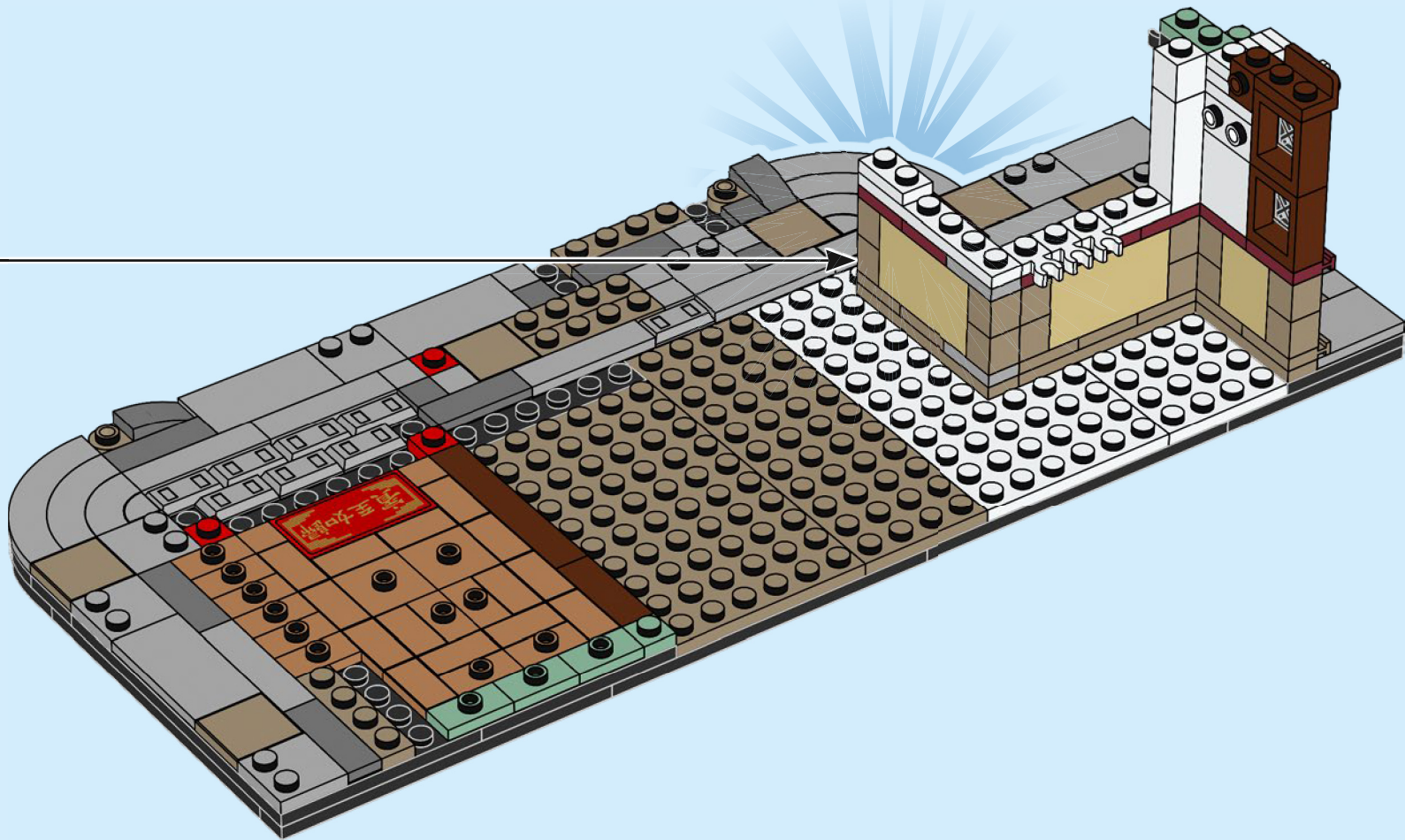

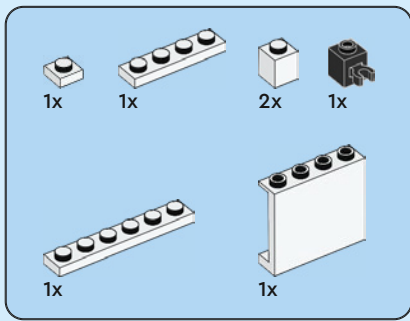

60

1

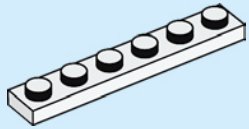

2

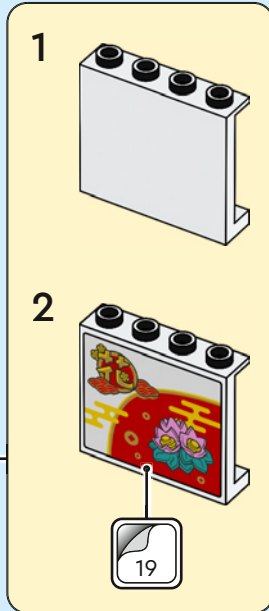
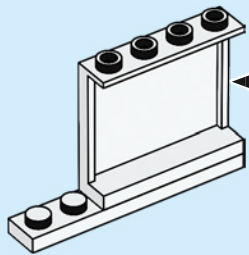

3

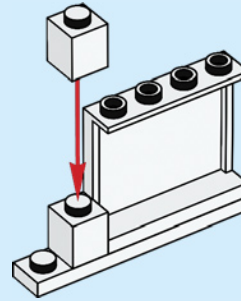

4

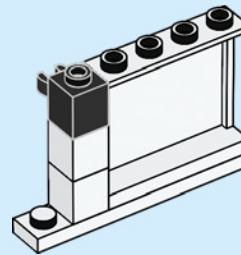

5

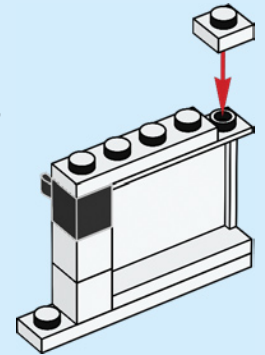

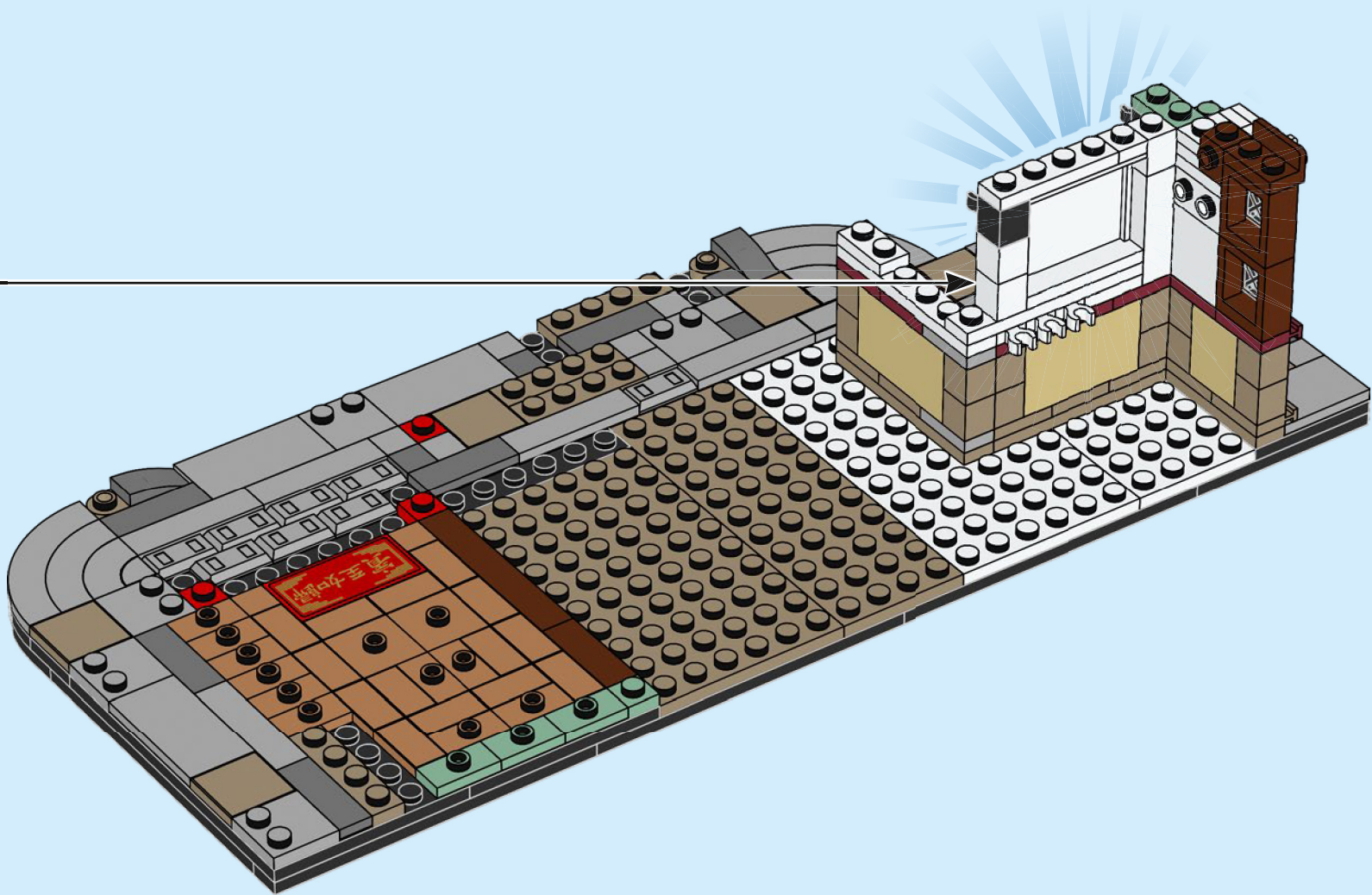

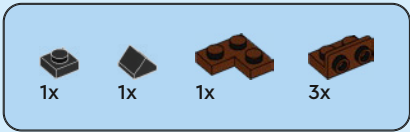

61

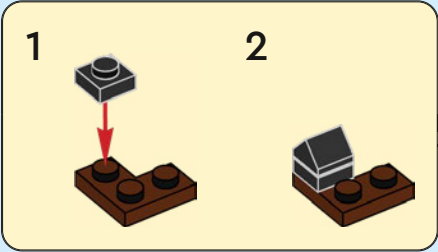

2

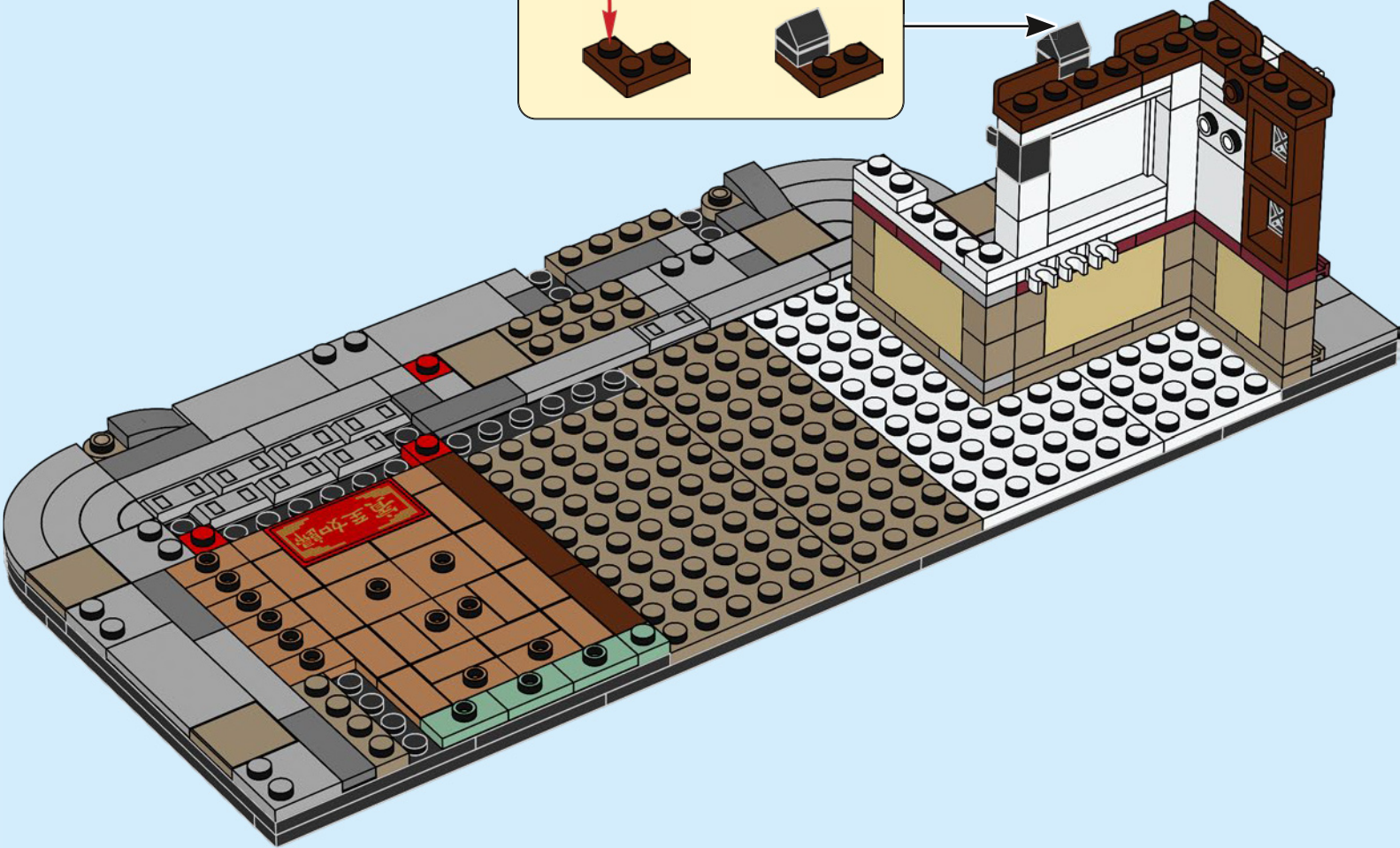

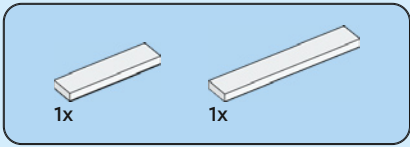

62

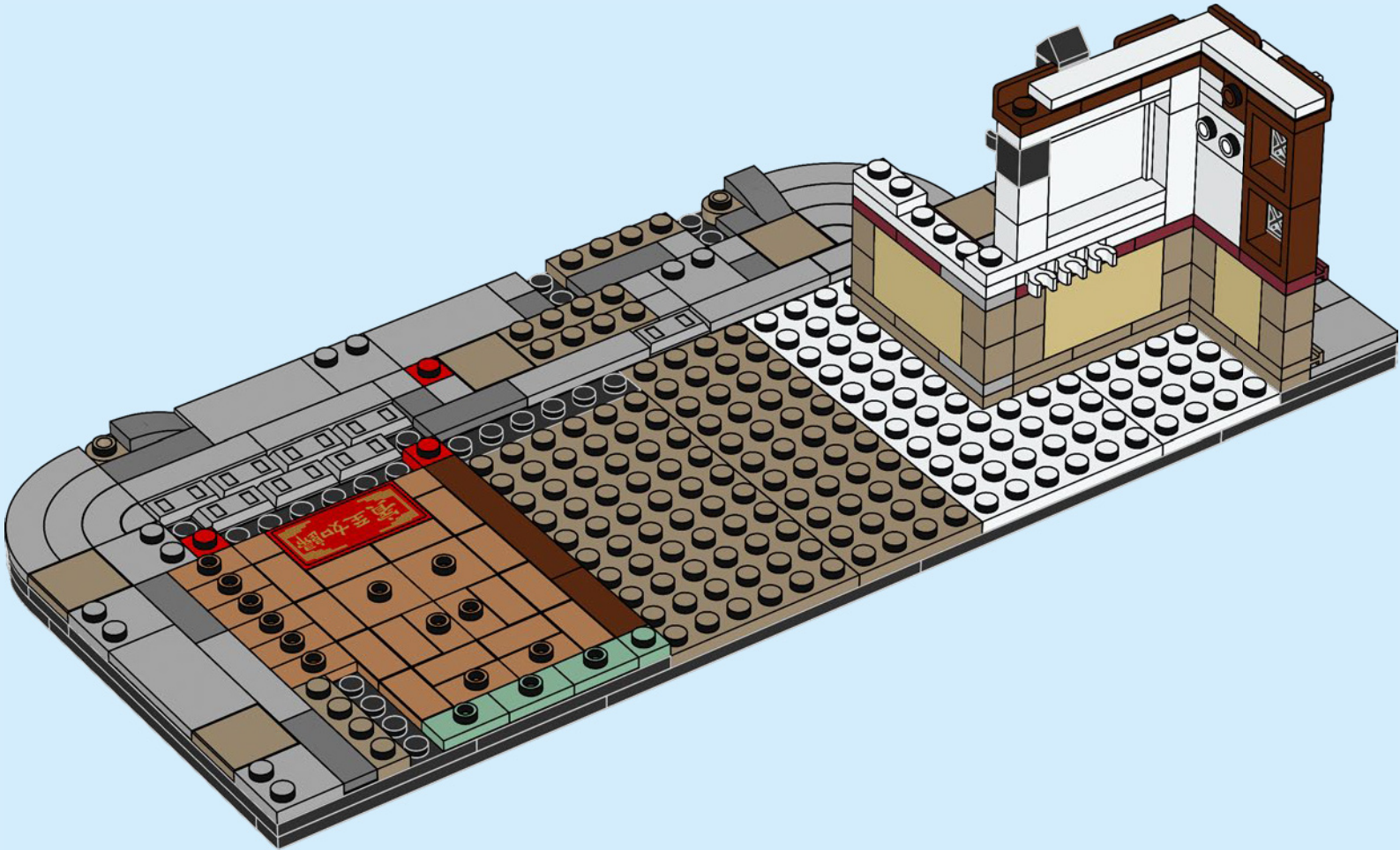

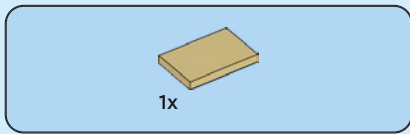

63

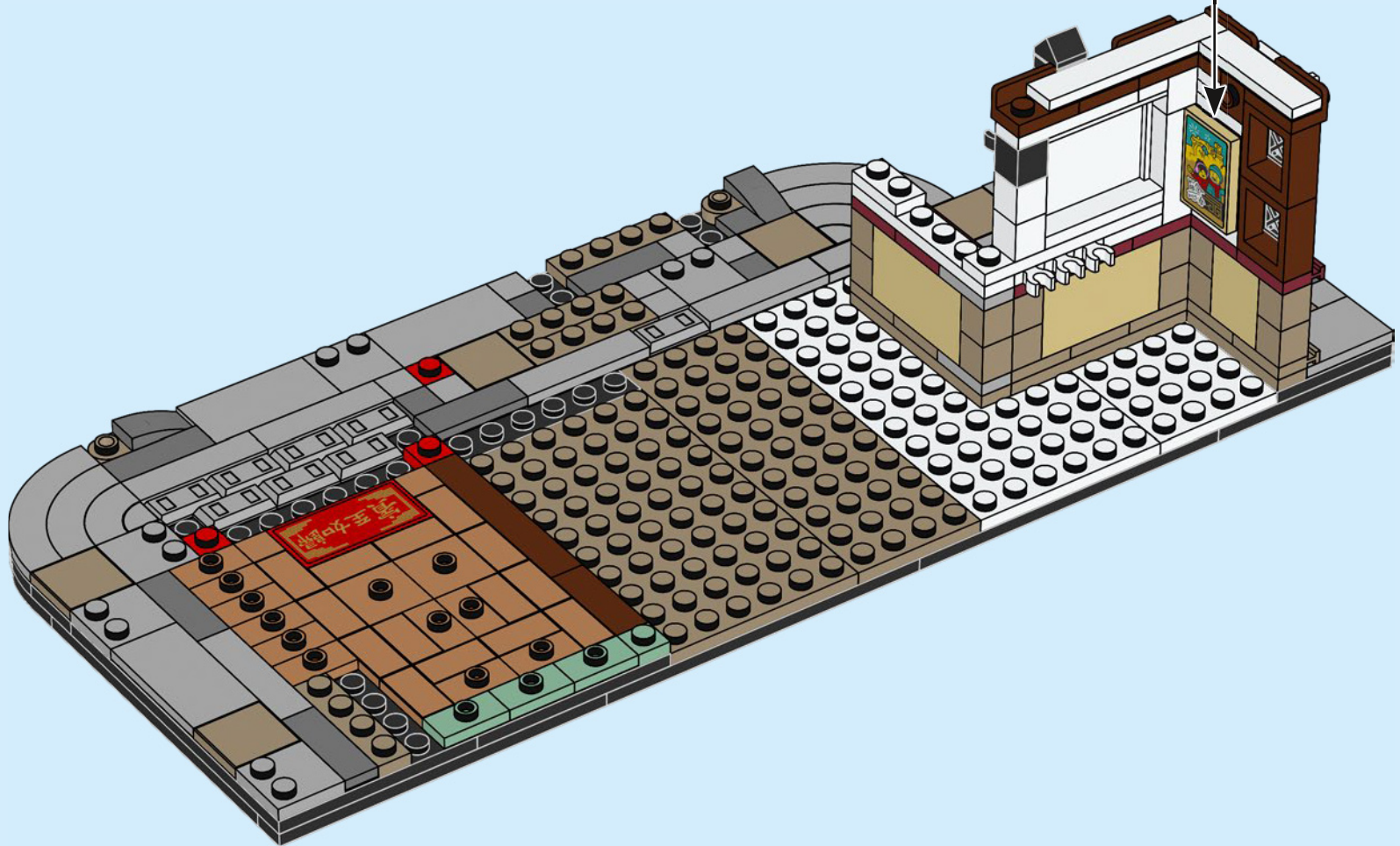
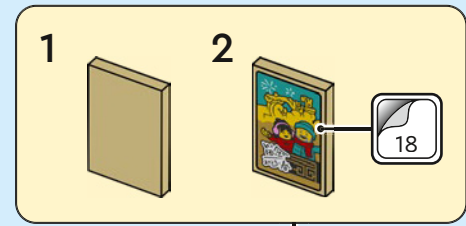

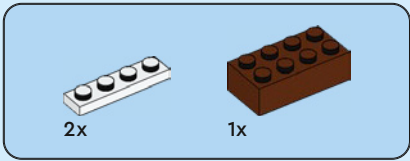

64

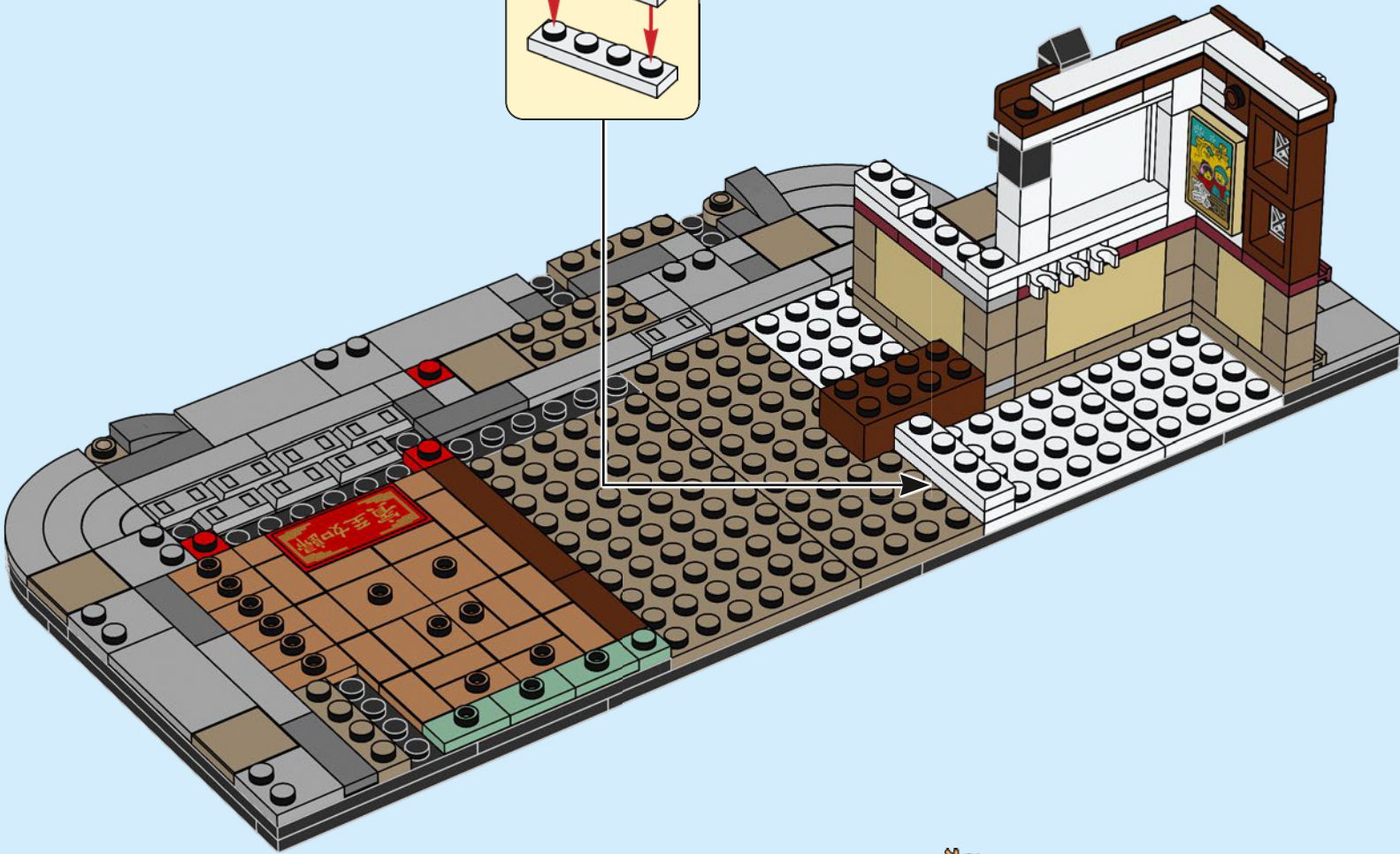
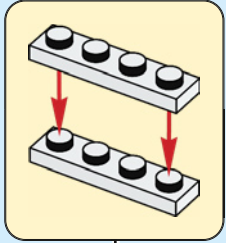

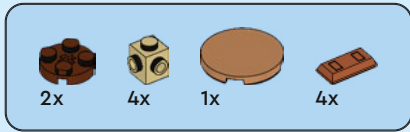

65

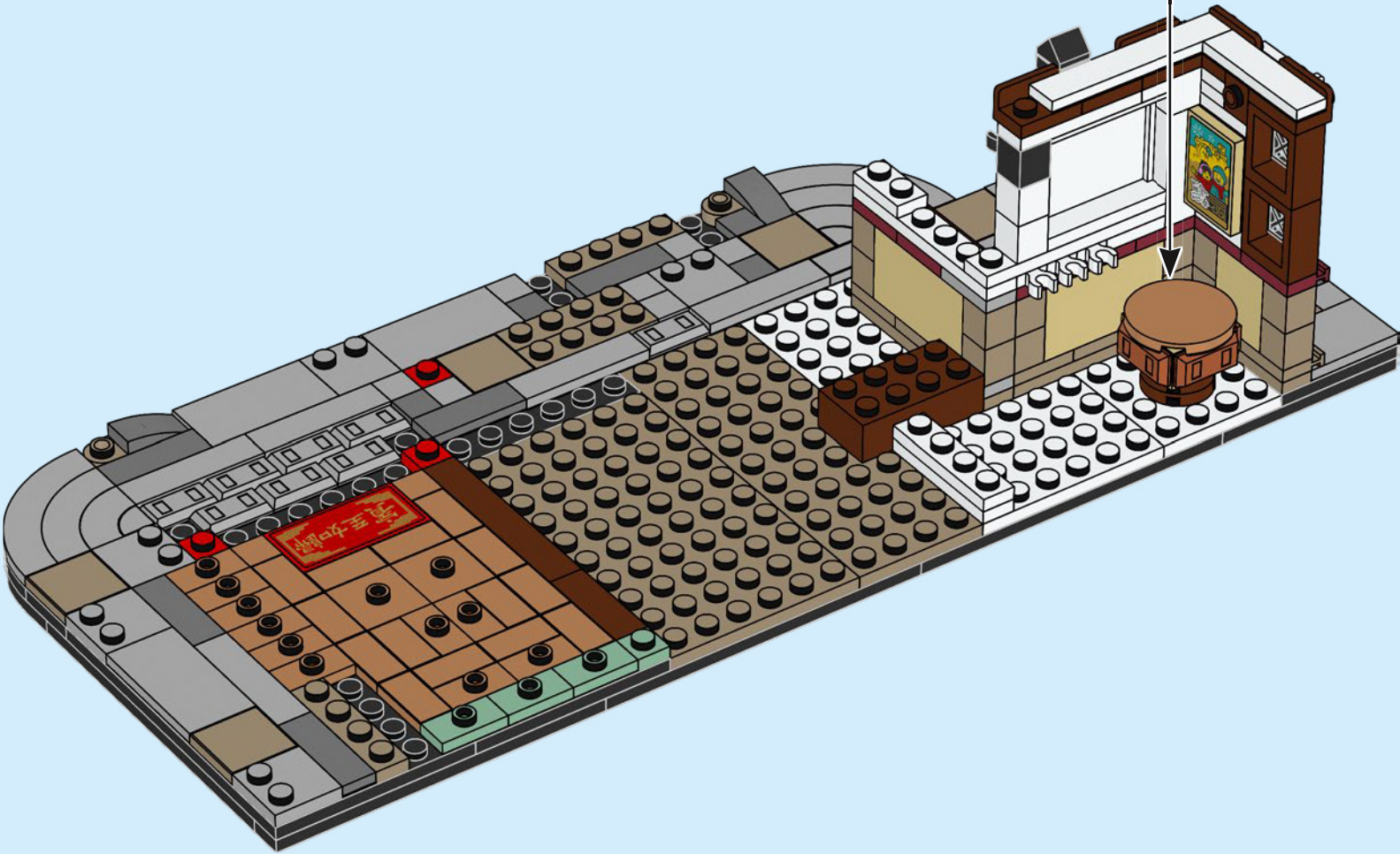
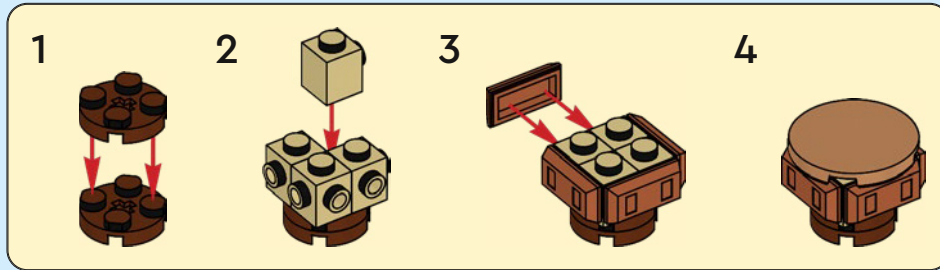

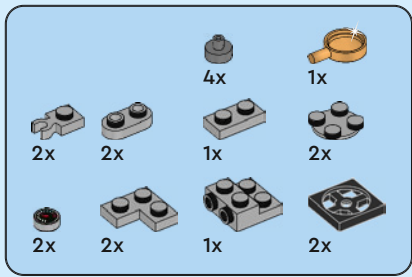

66

1

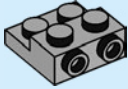

2

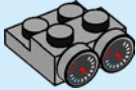

3

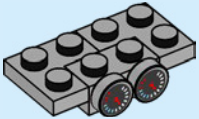

4

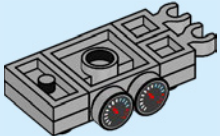

5

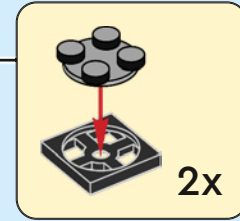
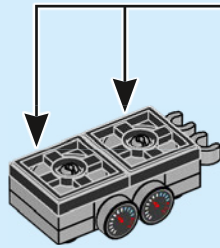

6

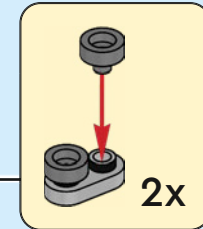
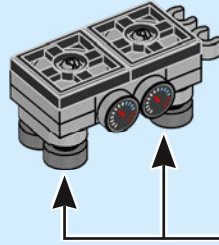

7

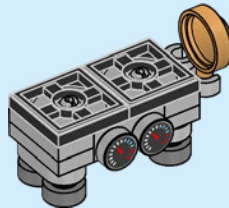

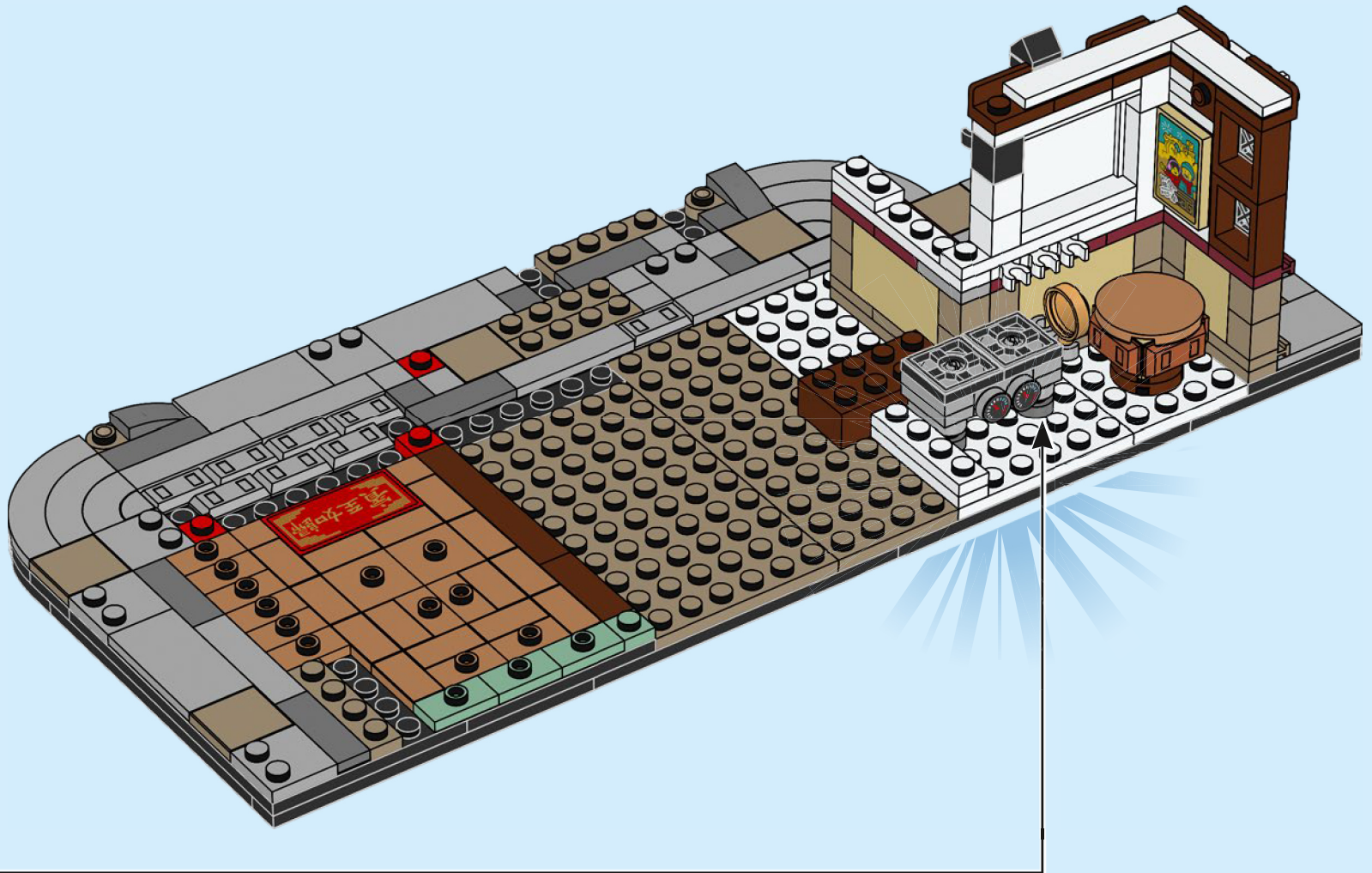



1x



1x

67

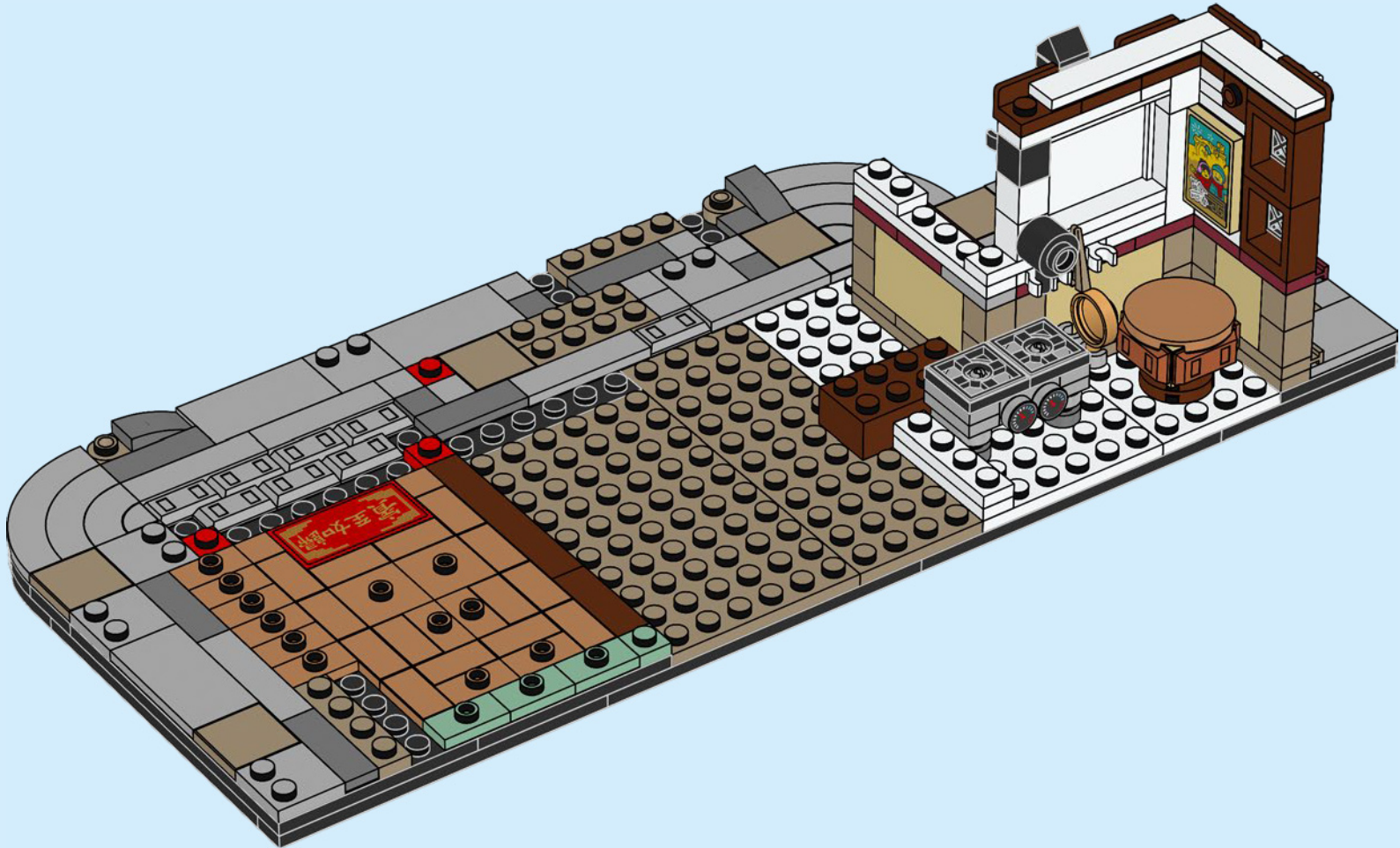

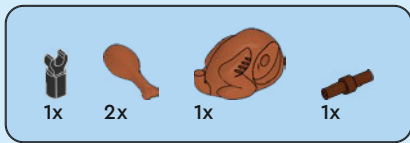

68

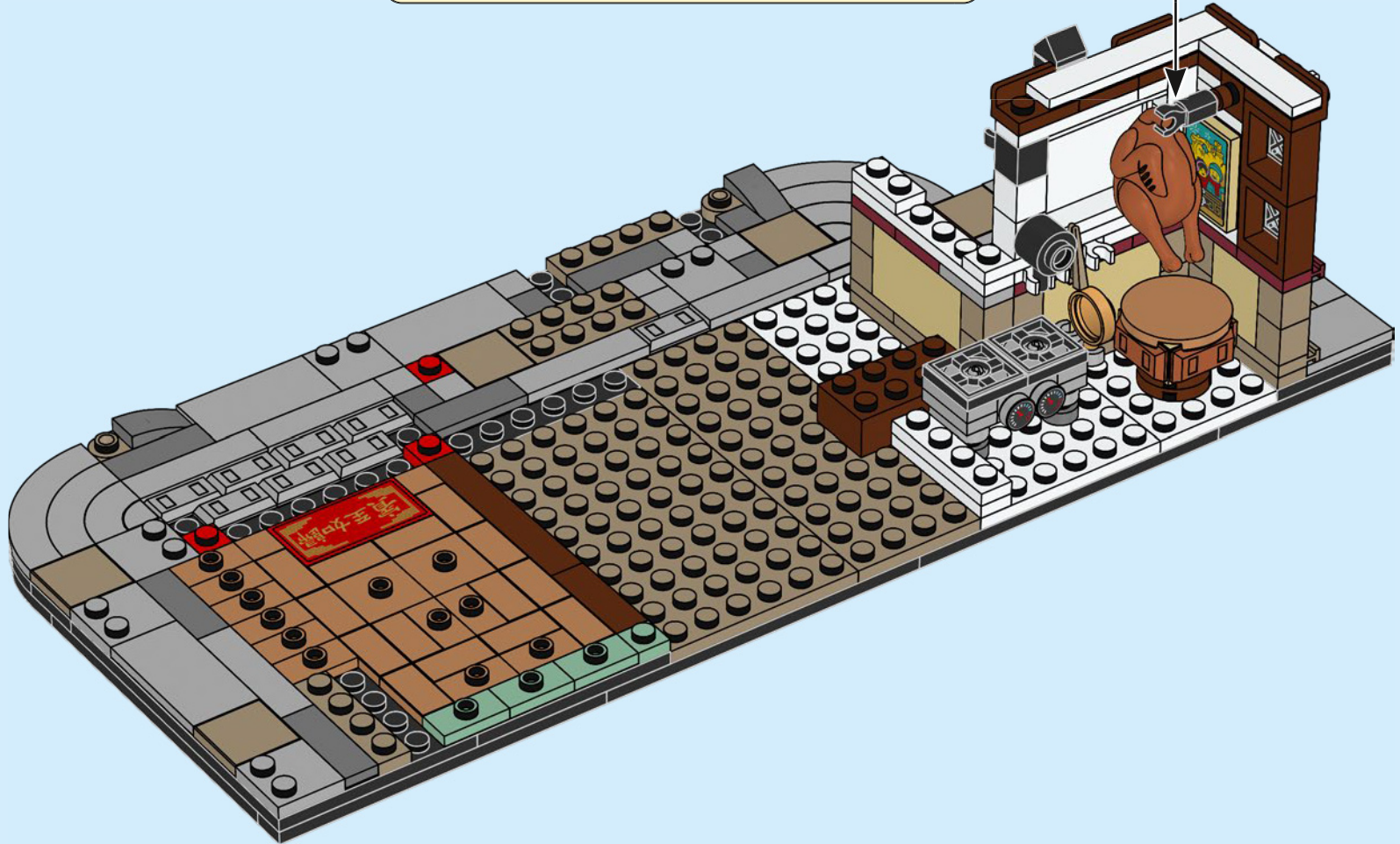
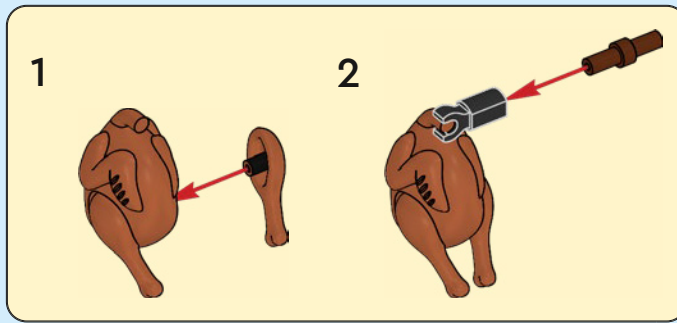

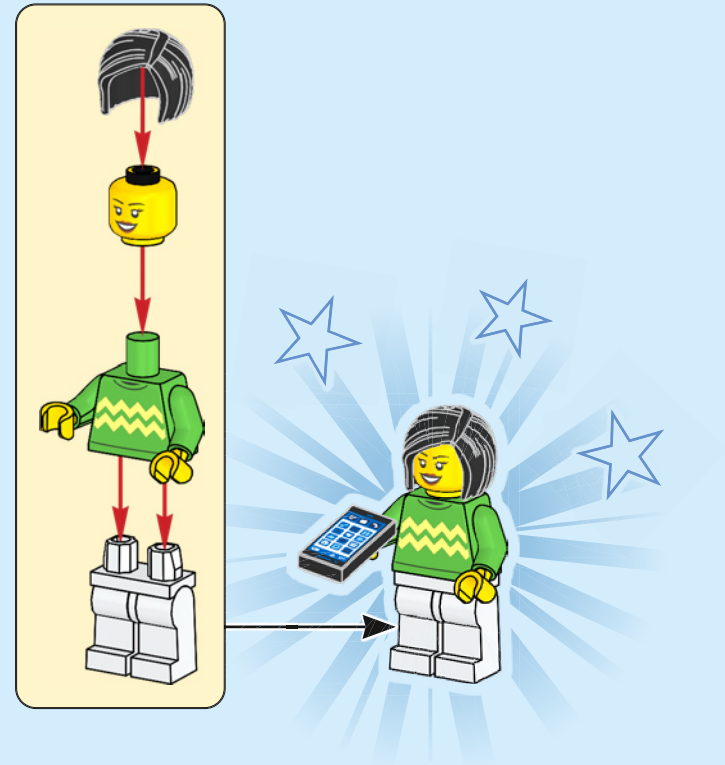

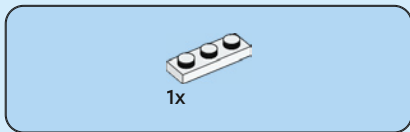

69

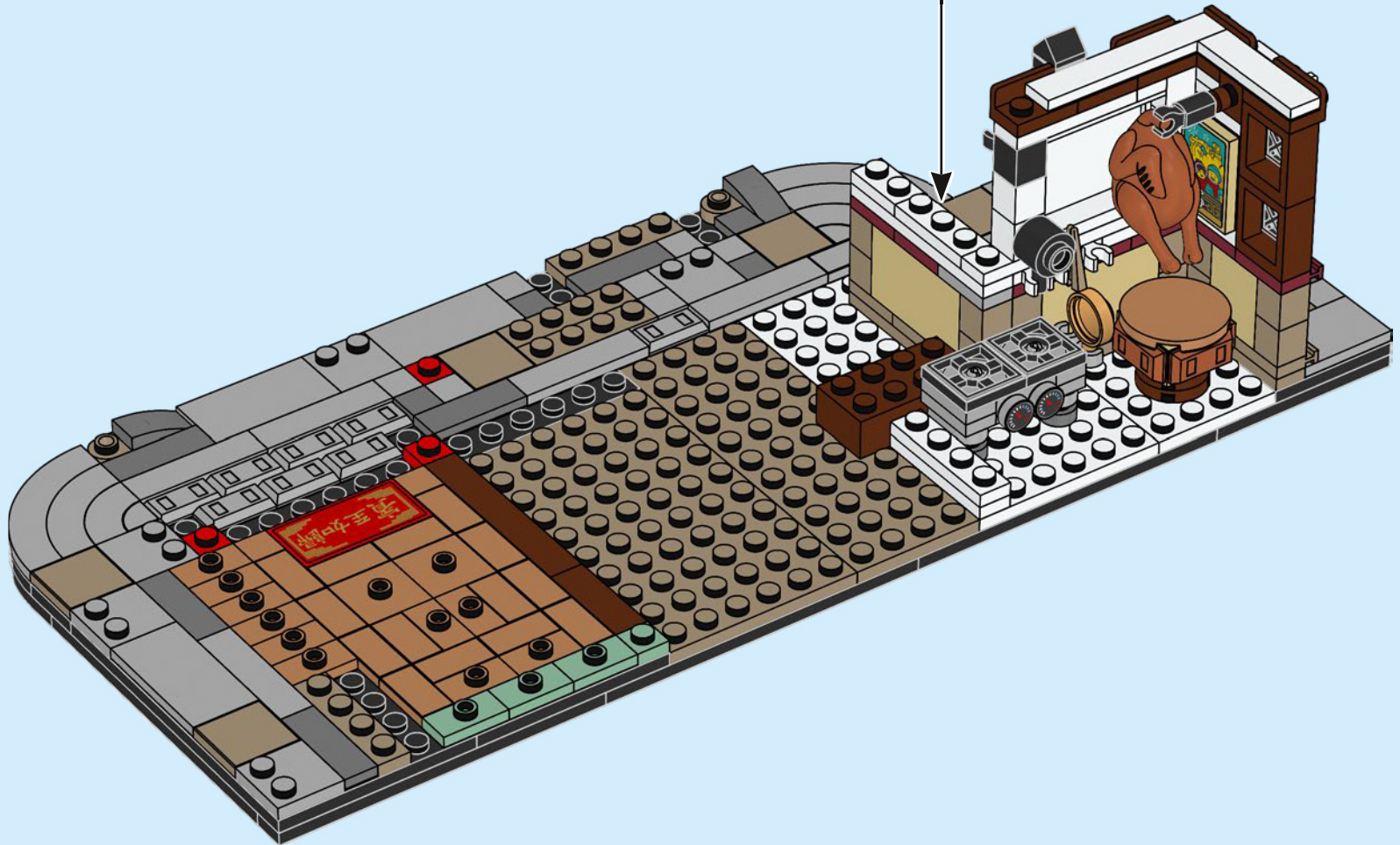
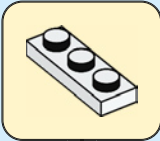

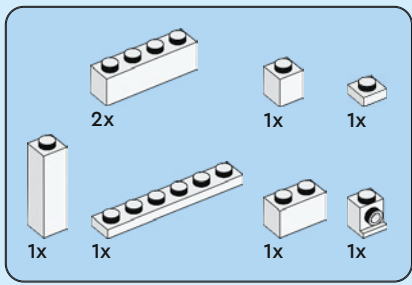

70

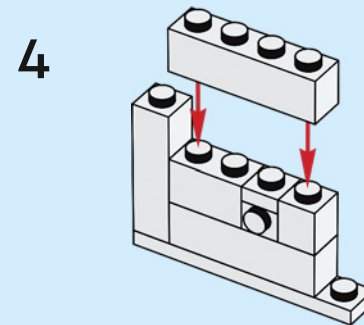
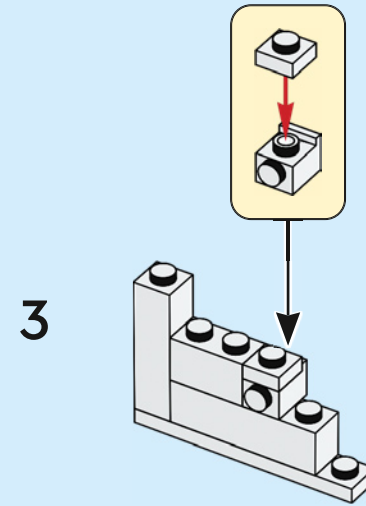
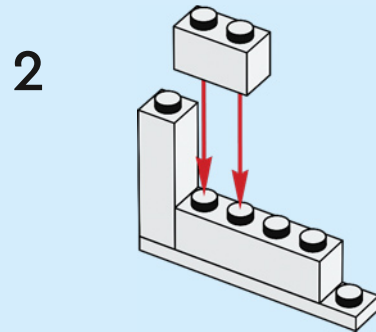
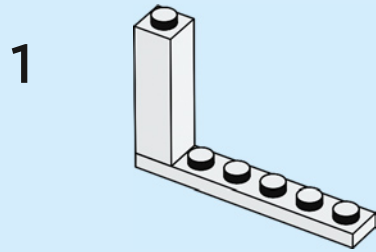

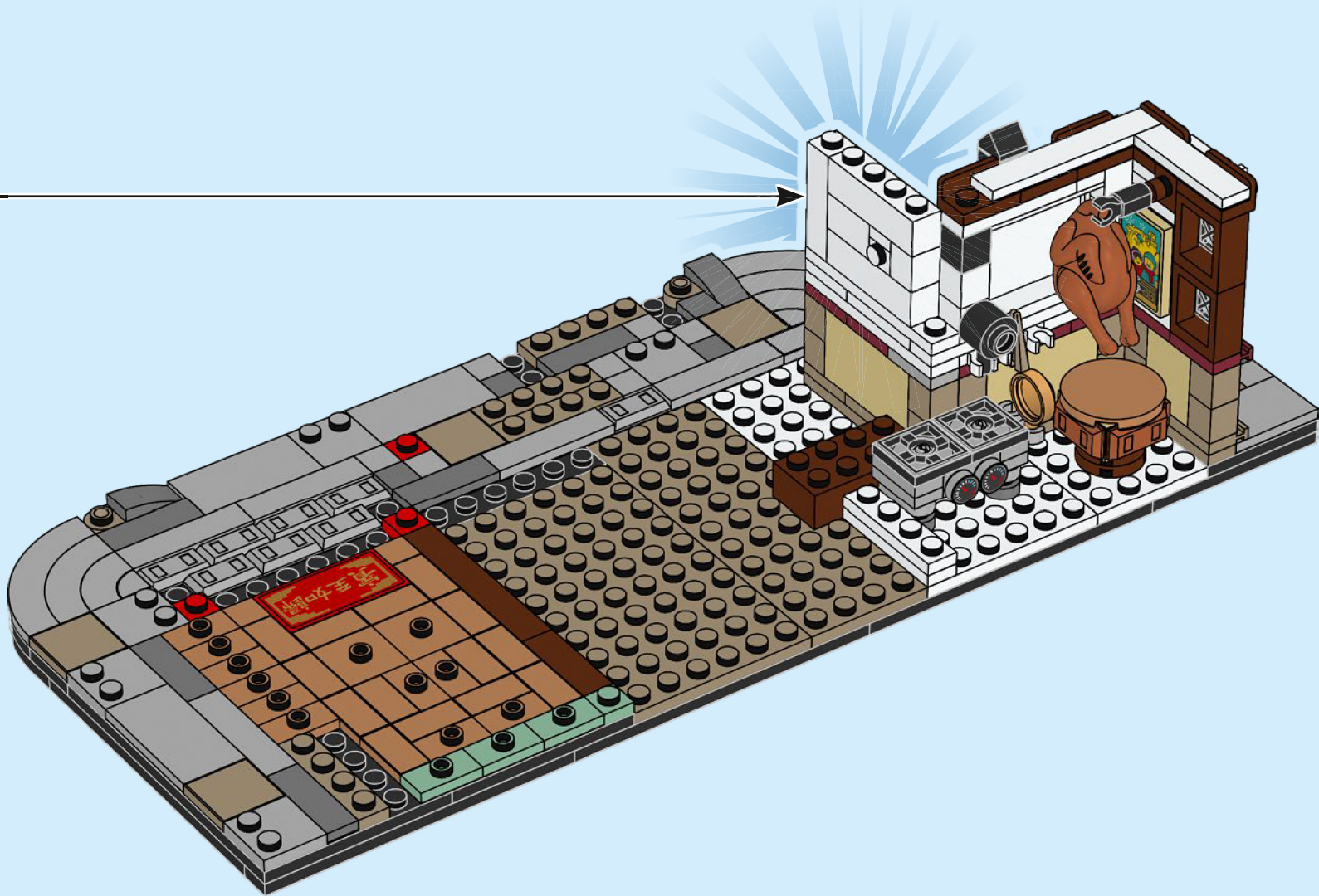

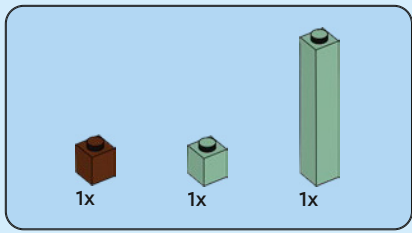

71

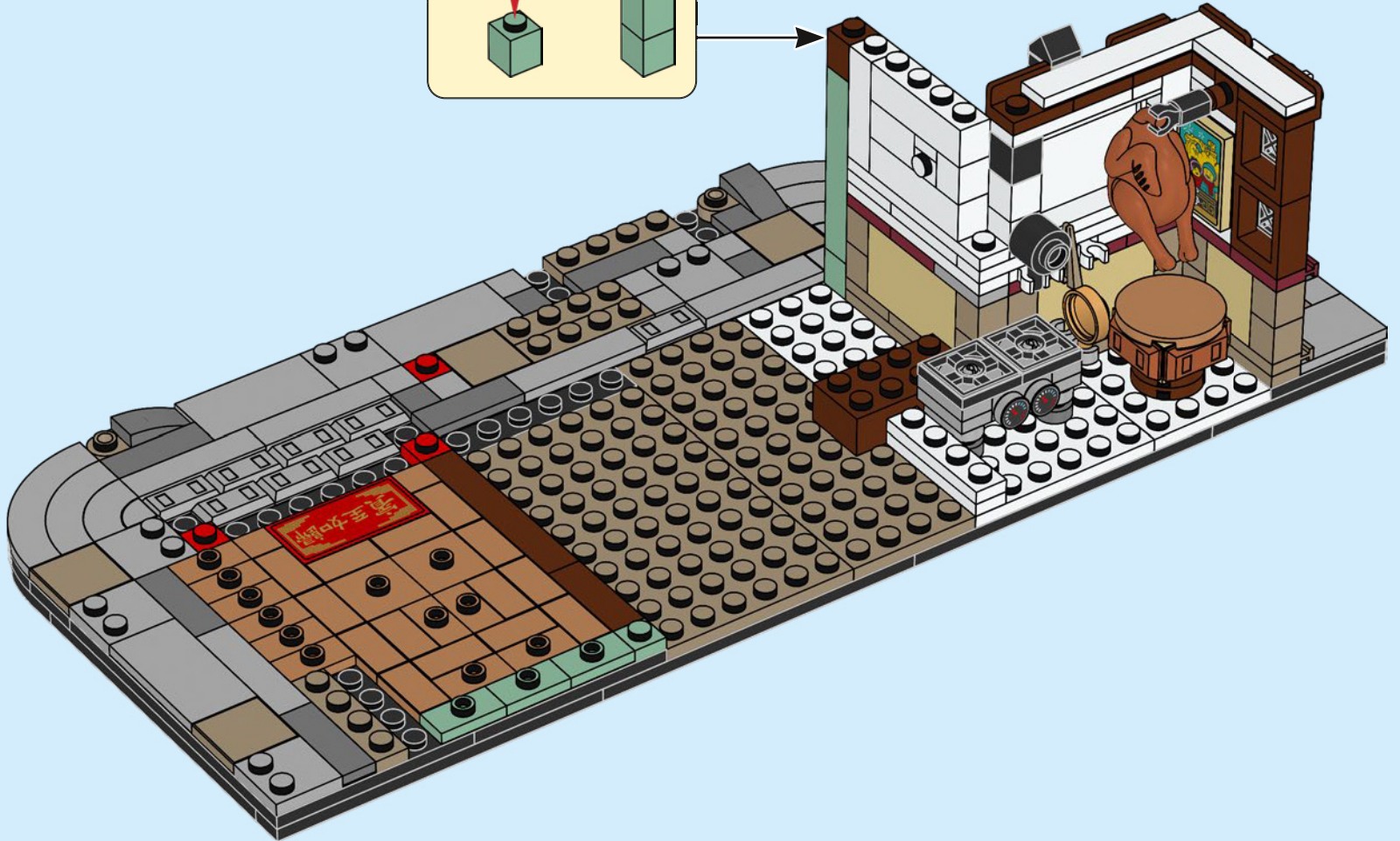
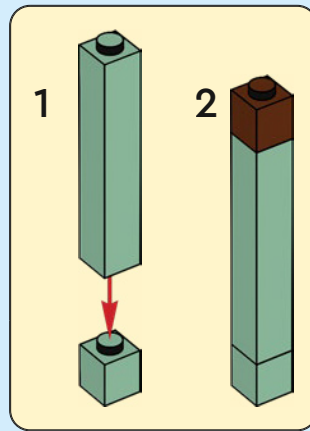

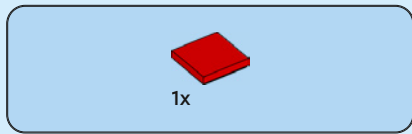

72

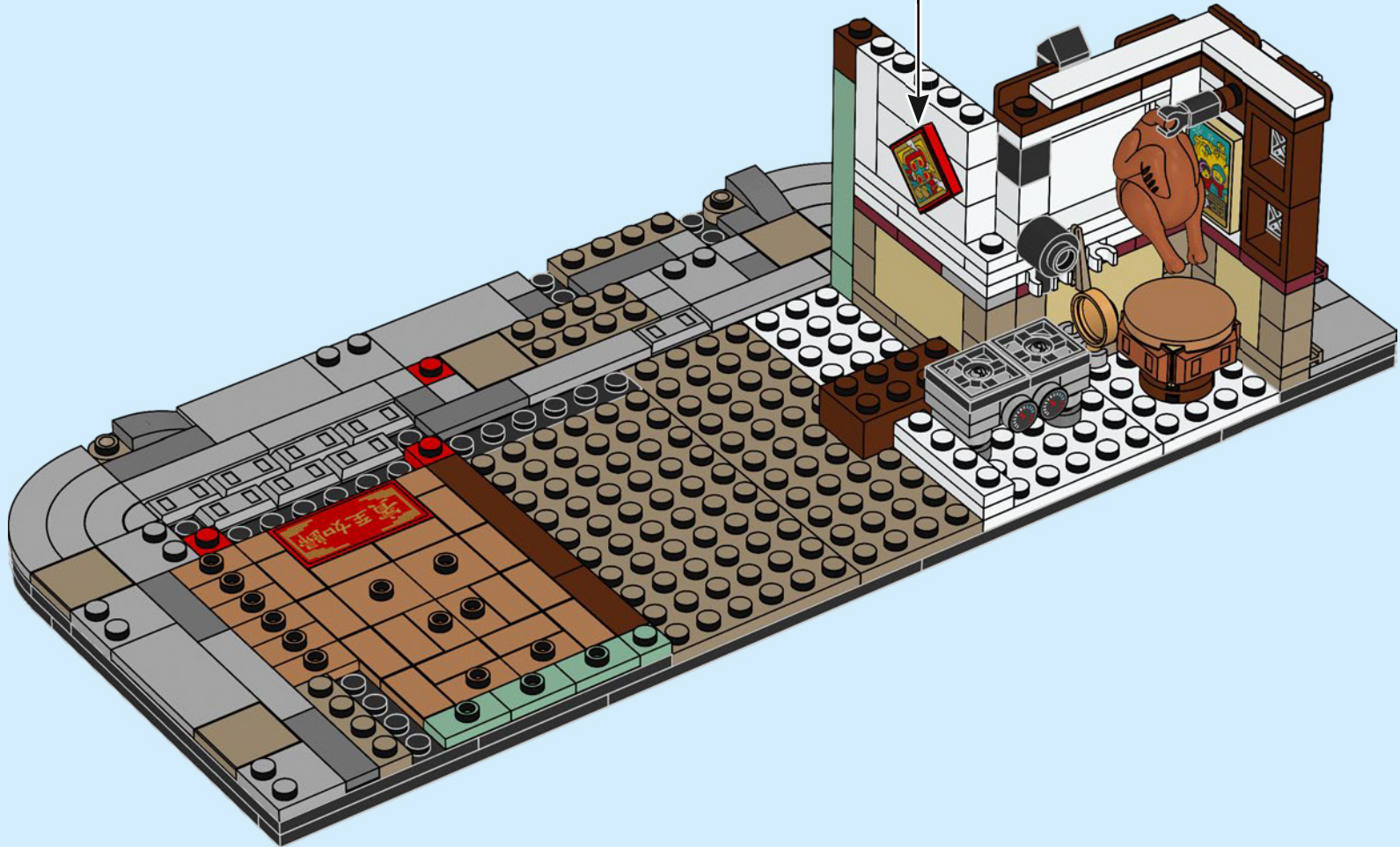

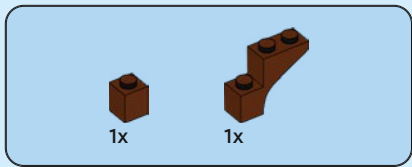

73

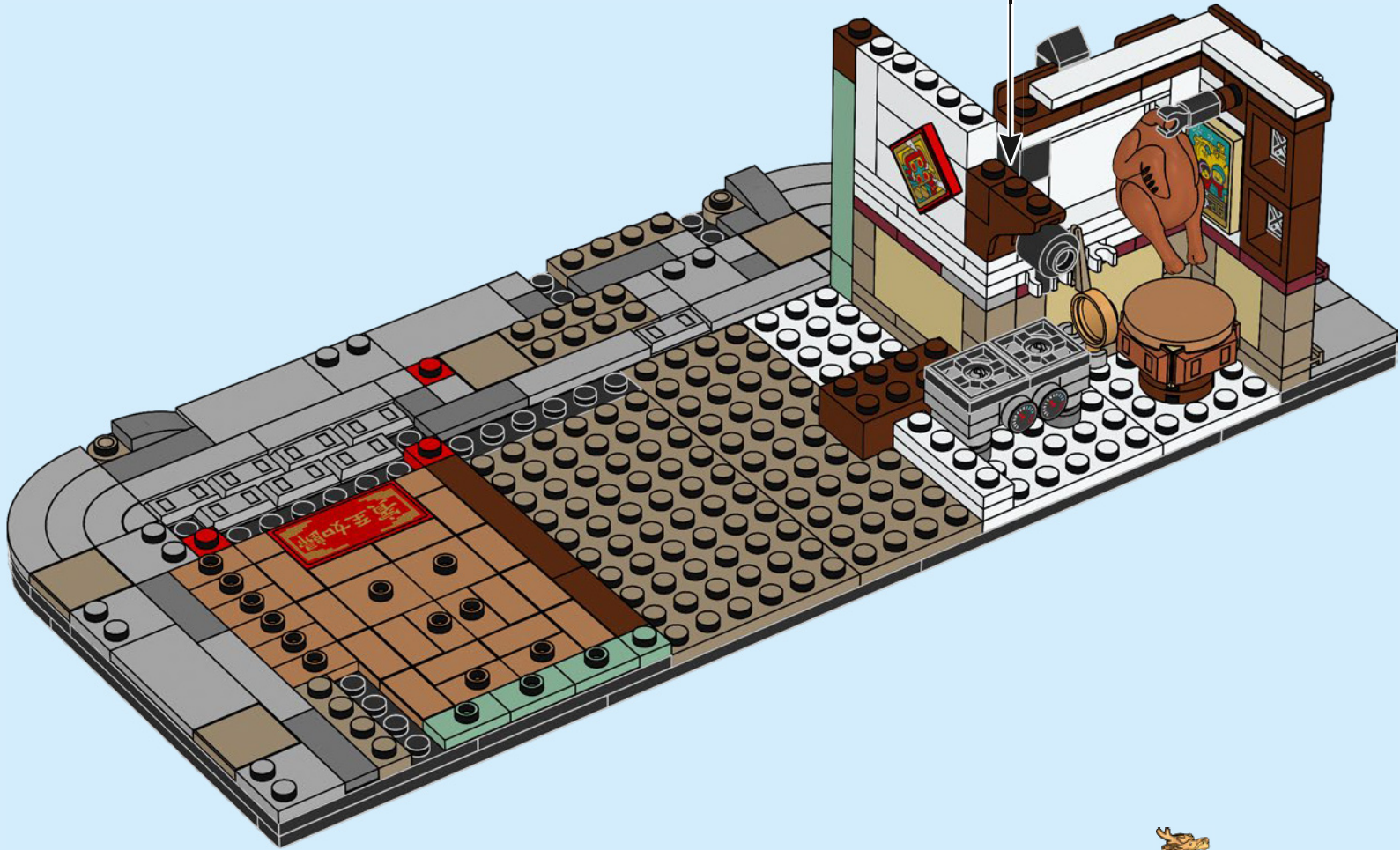
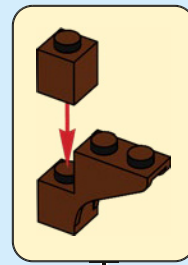

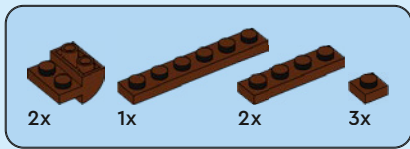

74

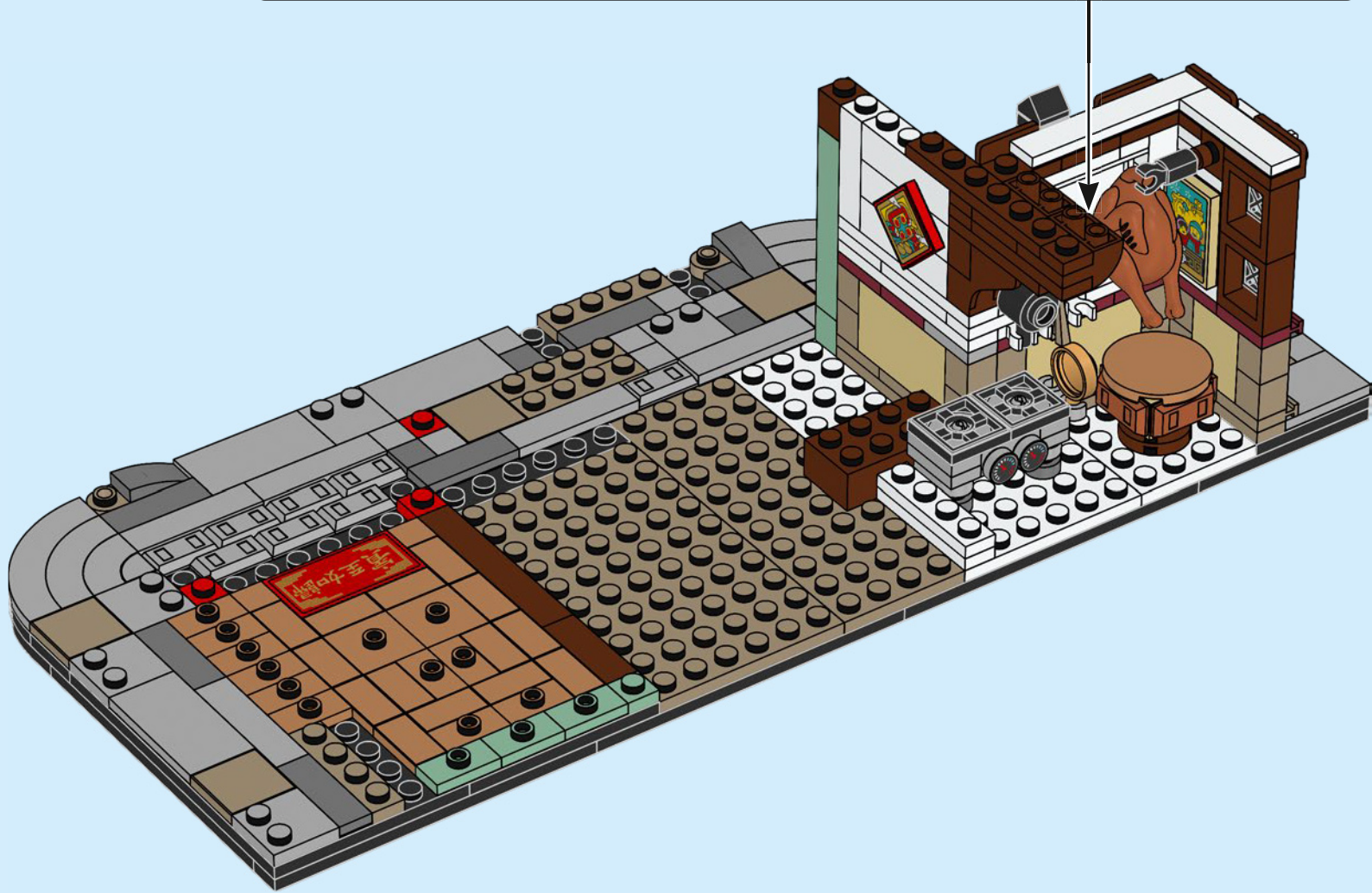
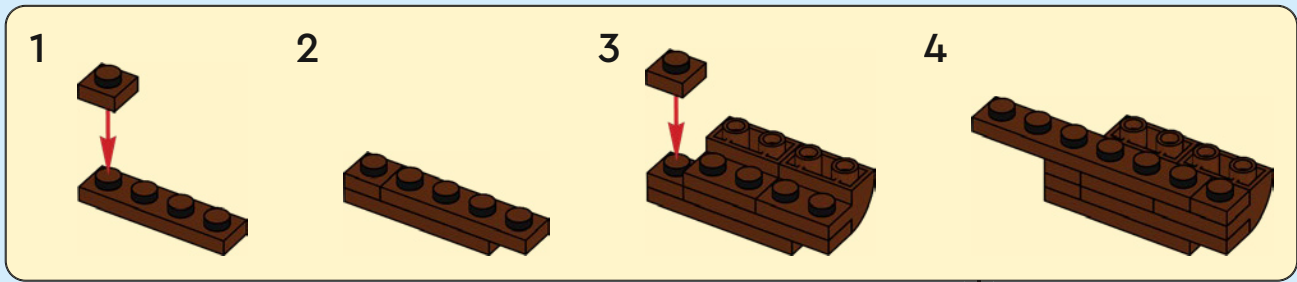

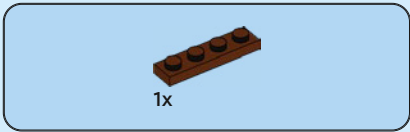

75

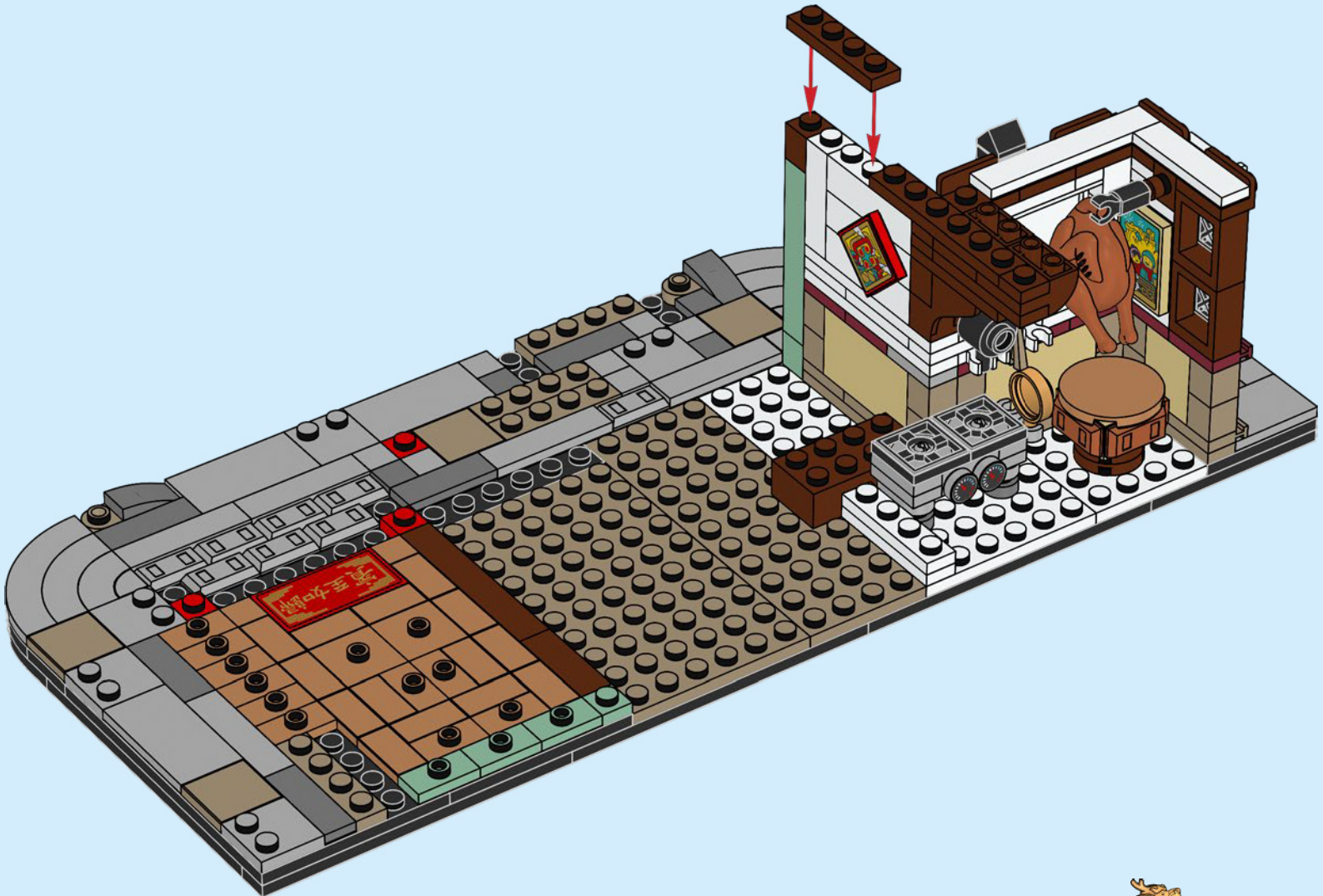

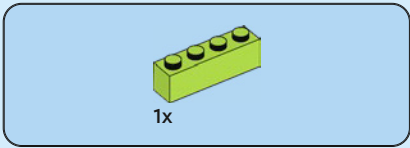

76

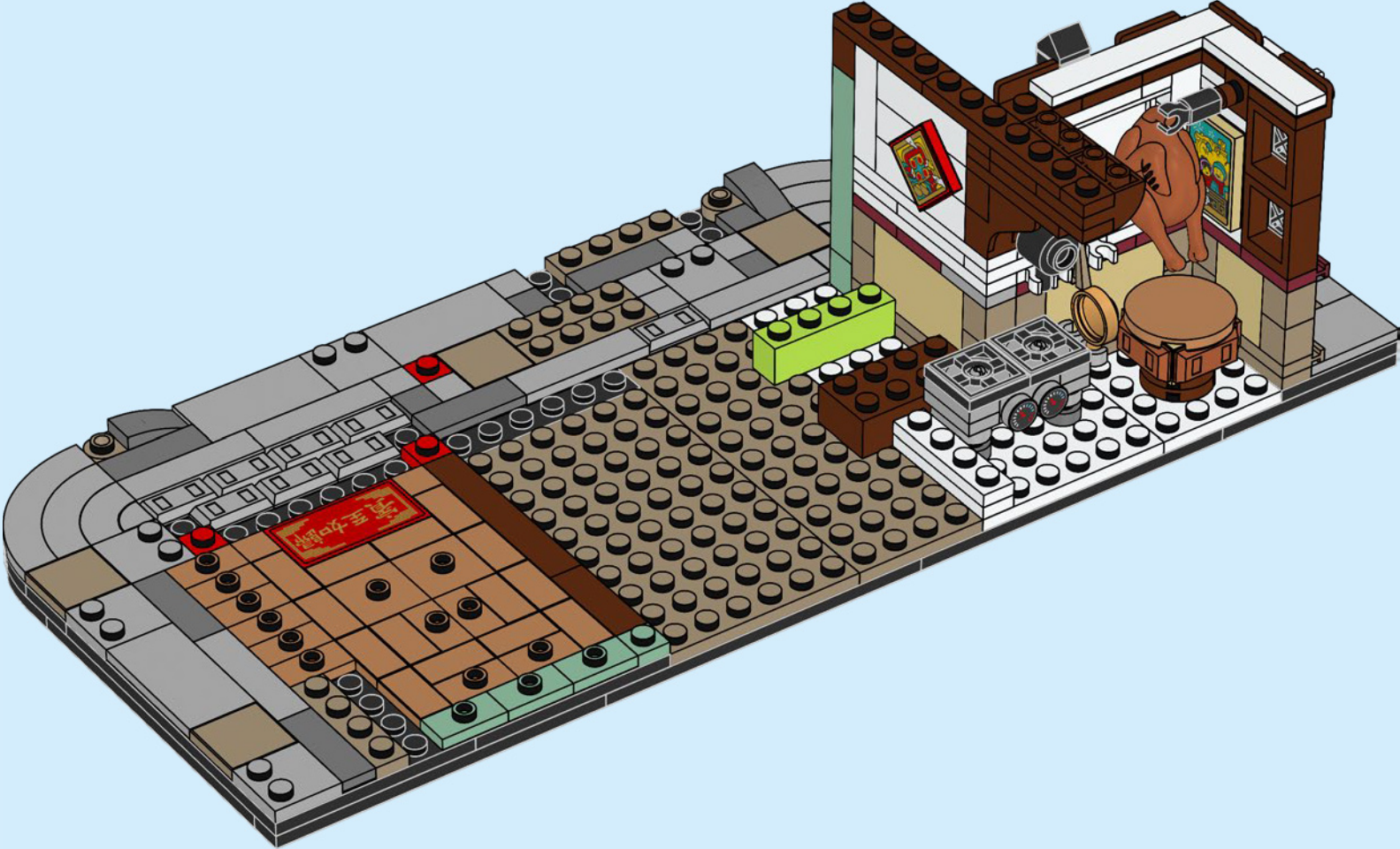

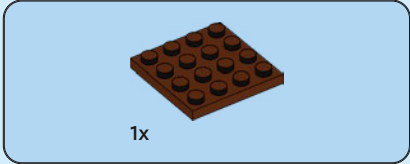
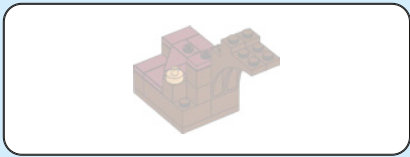

77

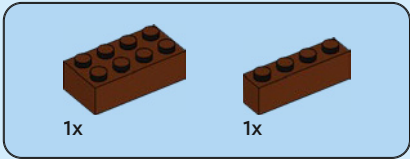
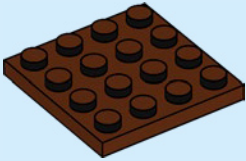

78

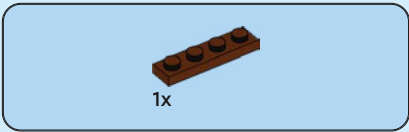
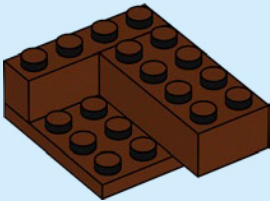

79

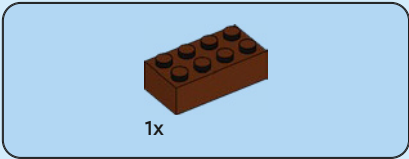
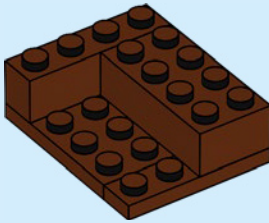

80

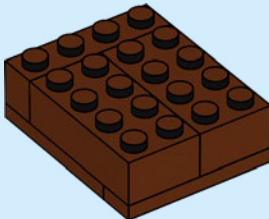

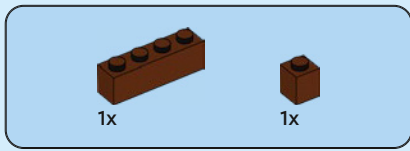

81

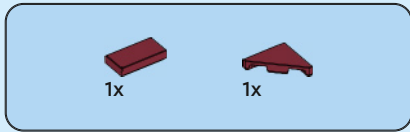
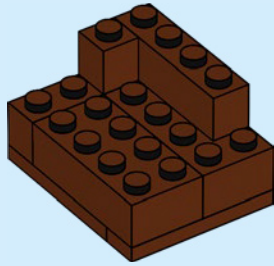

82

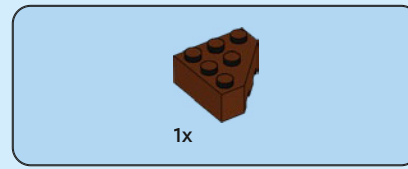
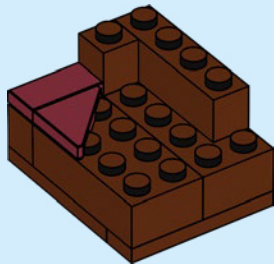

83

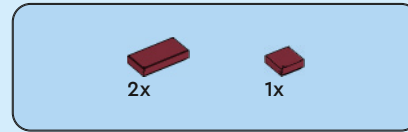
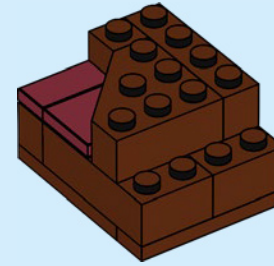

84

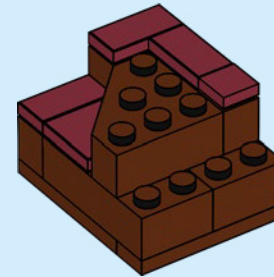

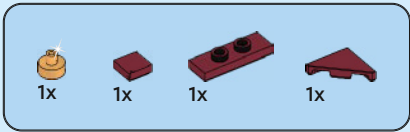

85

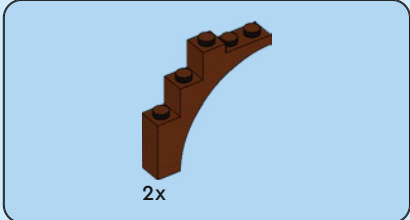
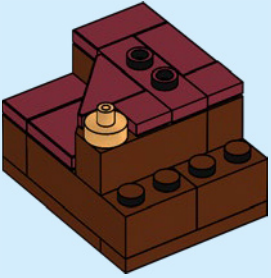

86

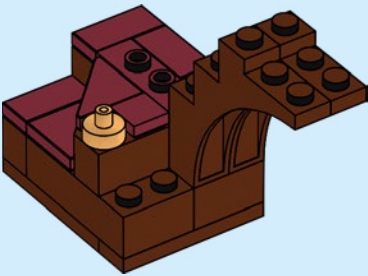

87

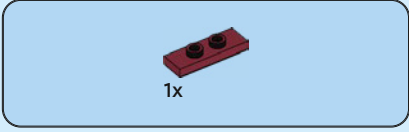
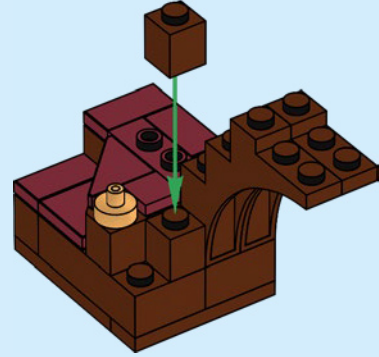

88



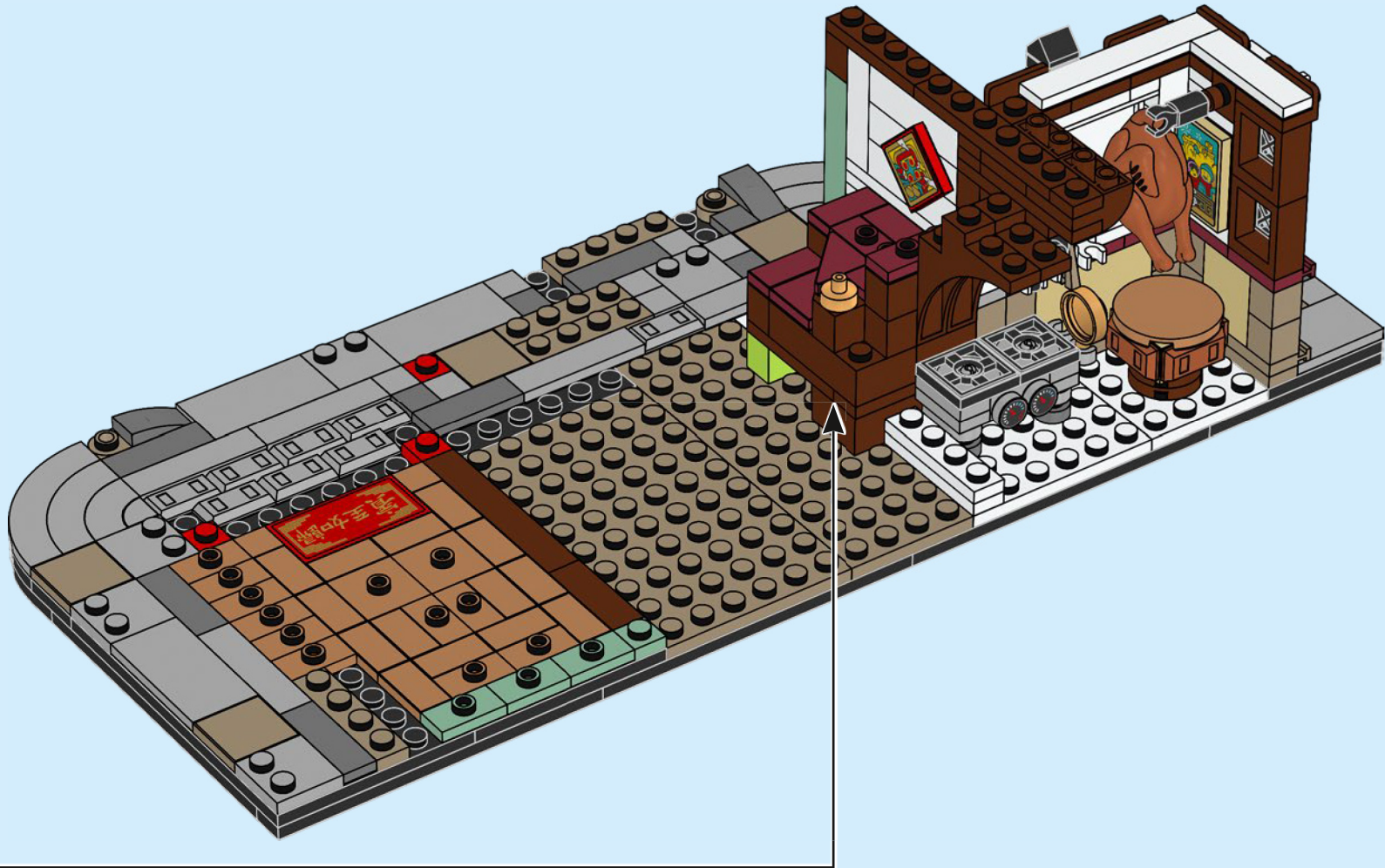

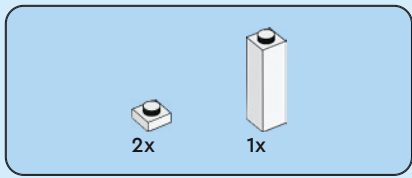

90

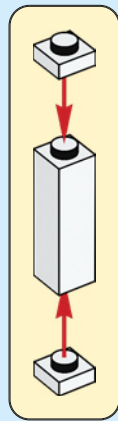

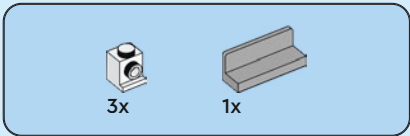

91

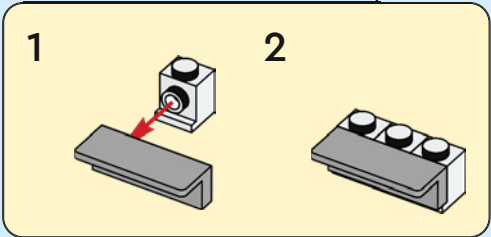
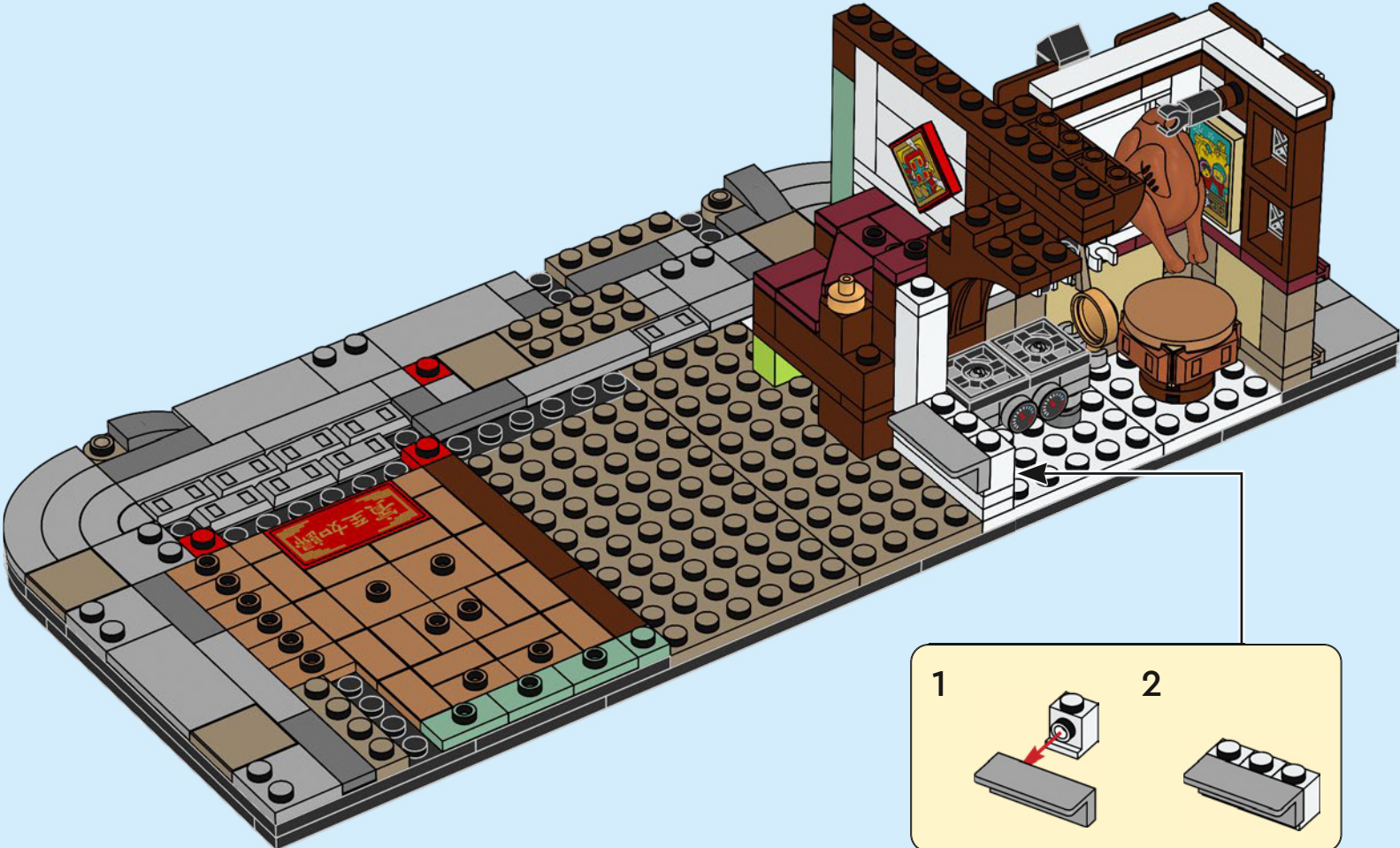

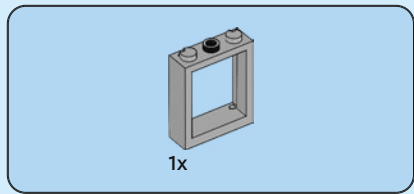

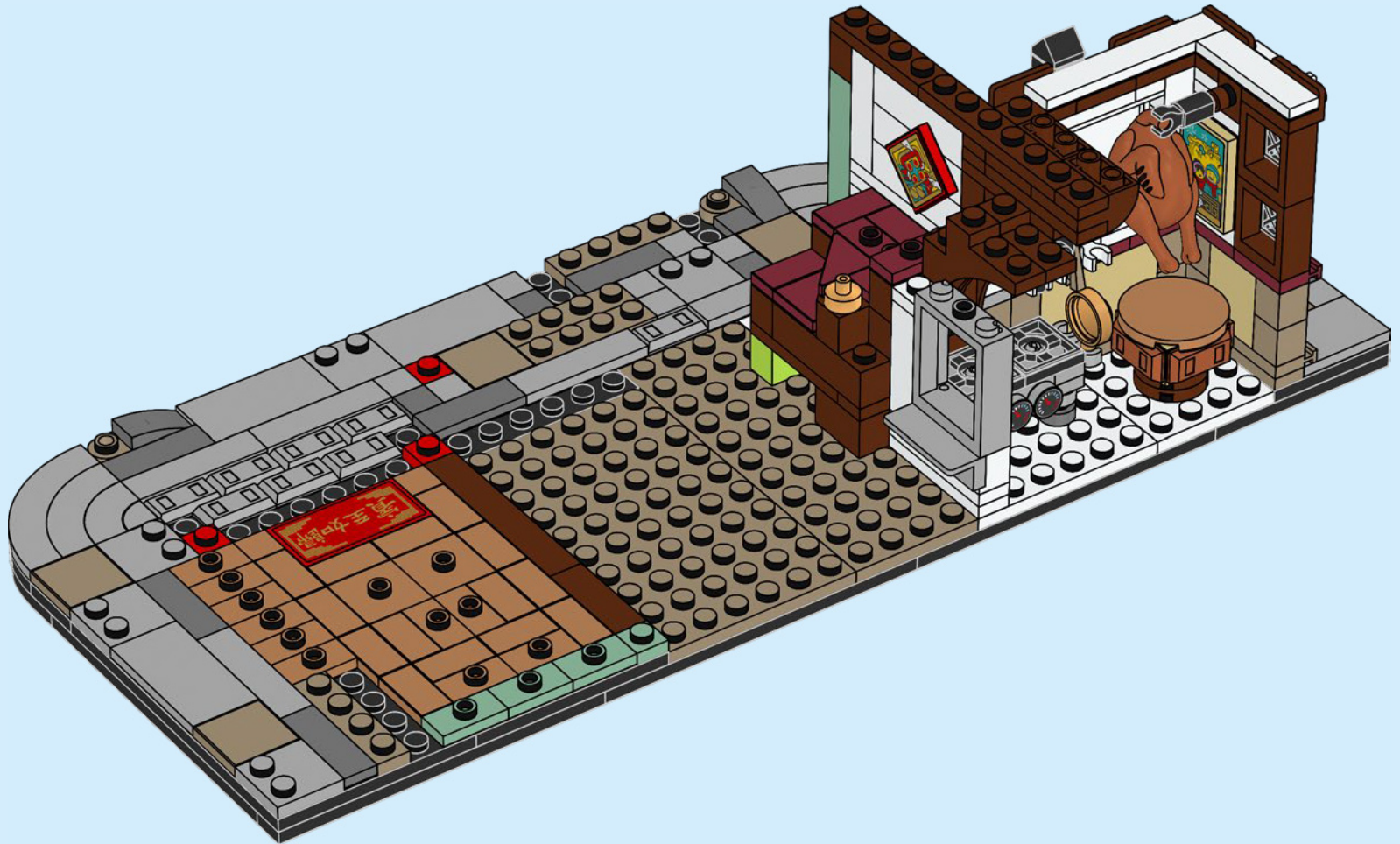

92

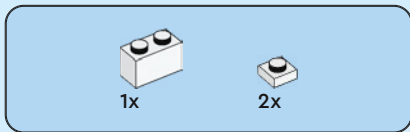

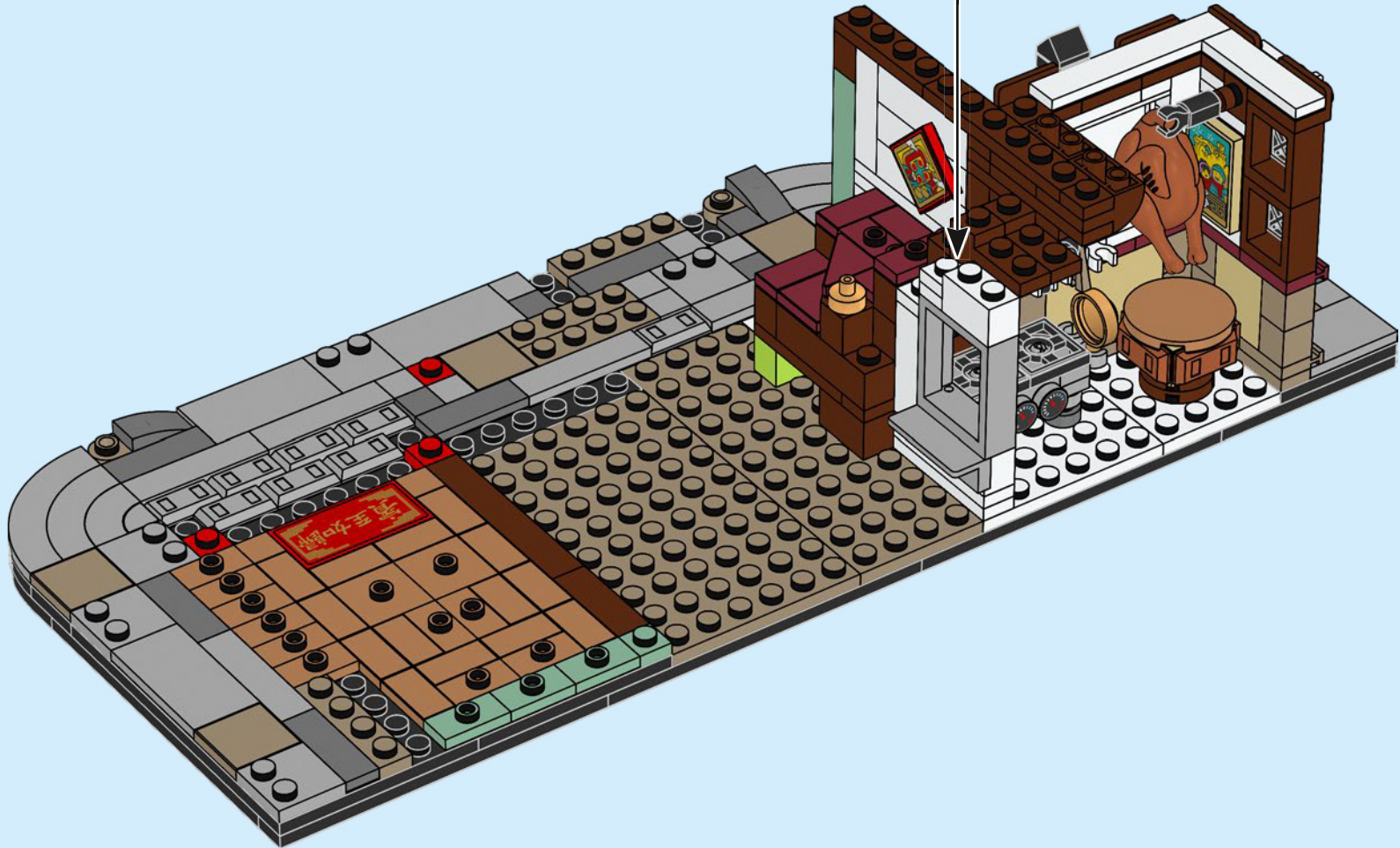
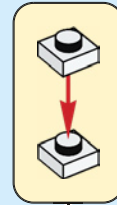

93



1x  2x 

94

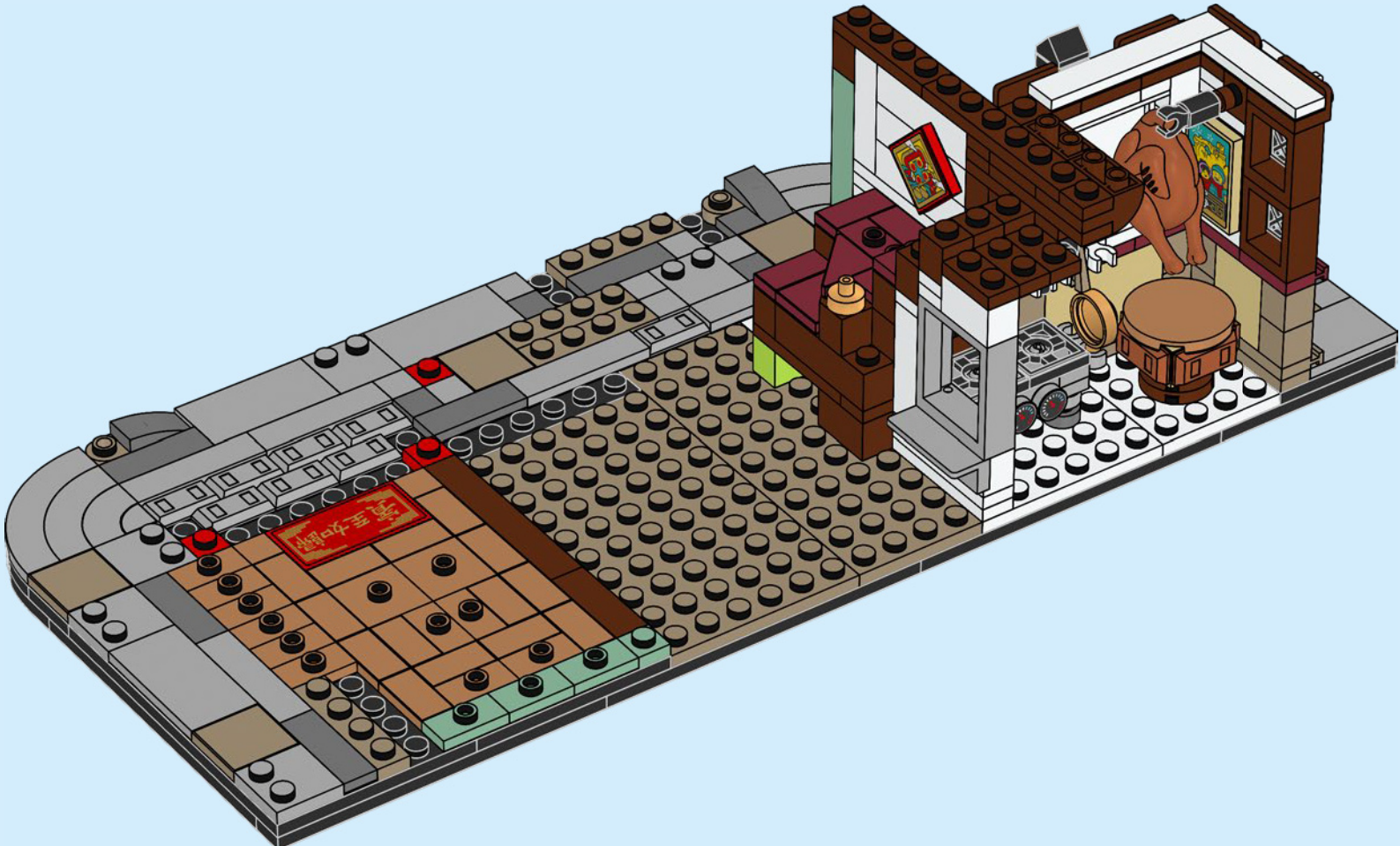

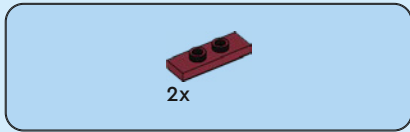

95

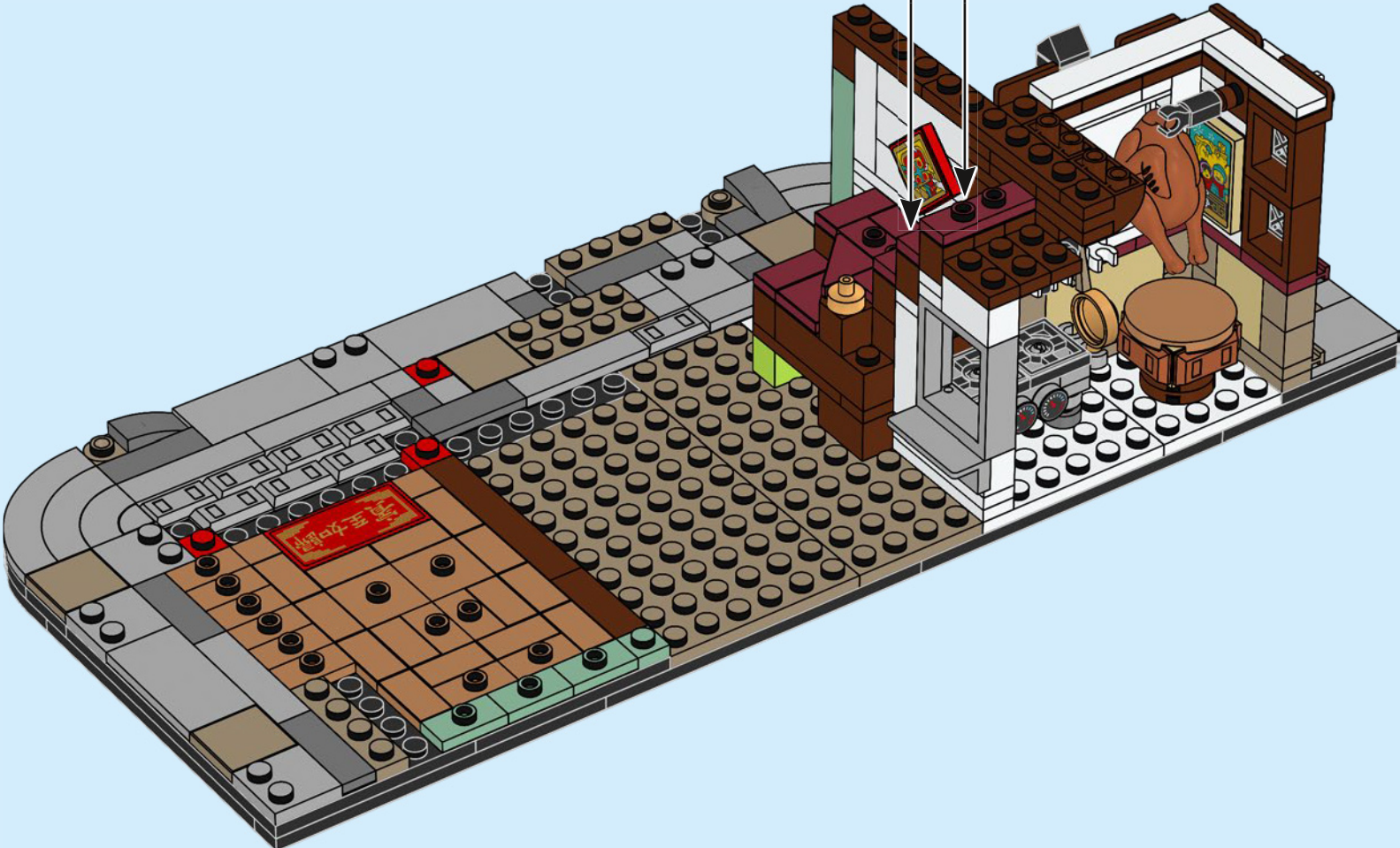
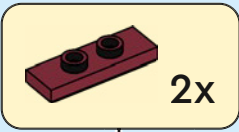

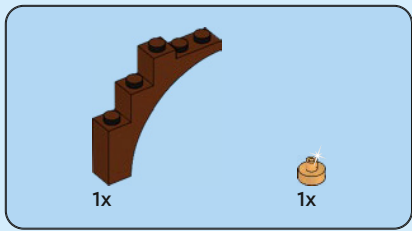

96

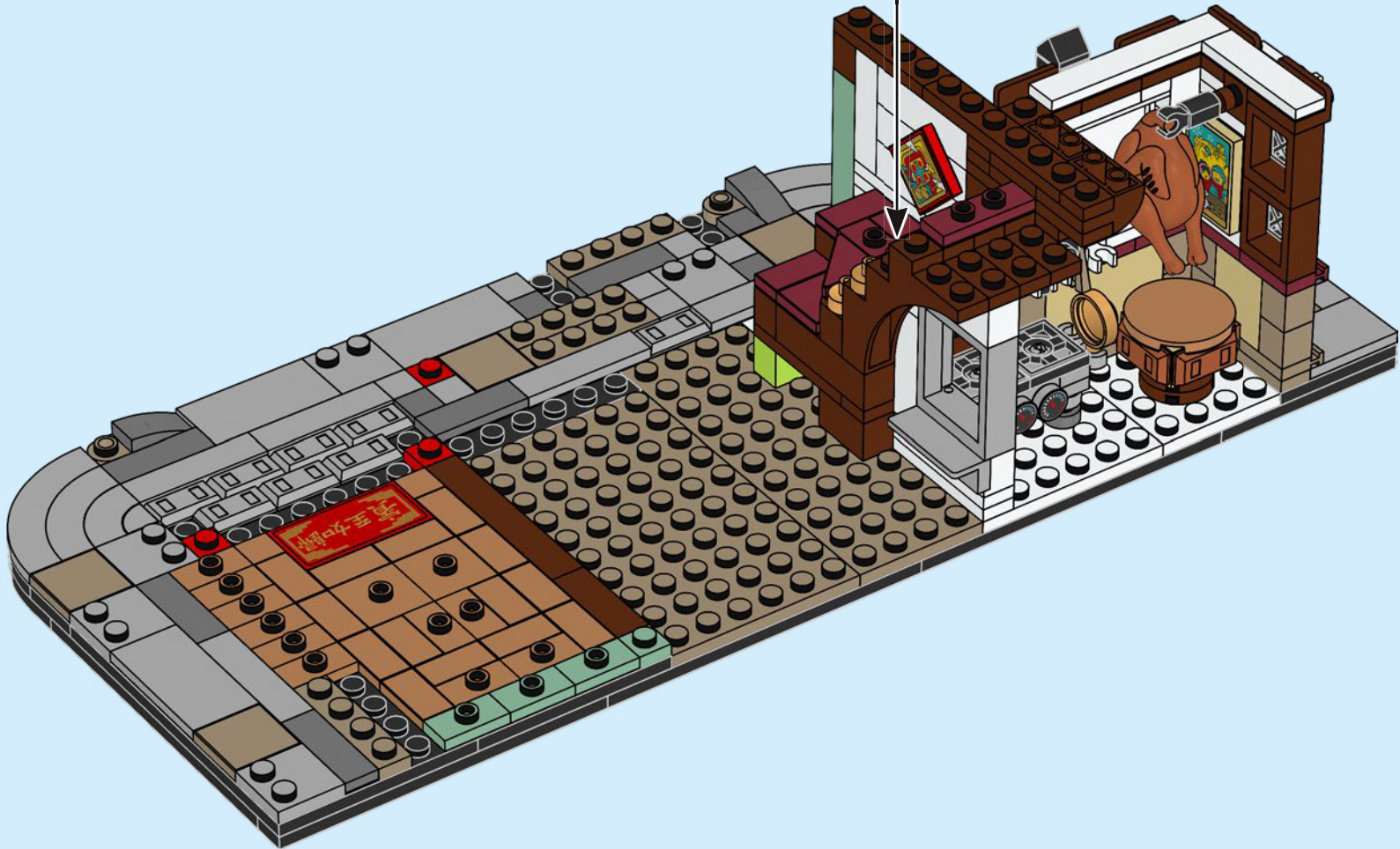
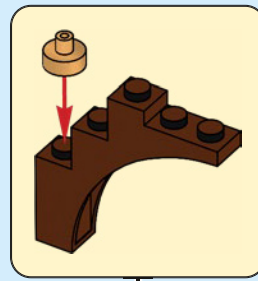

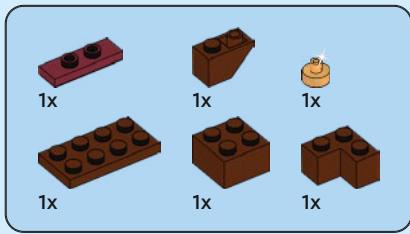

97

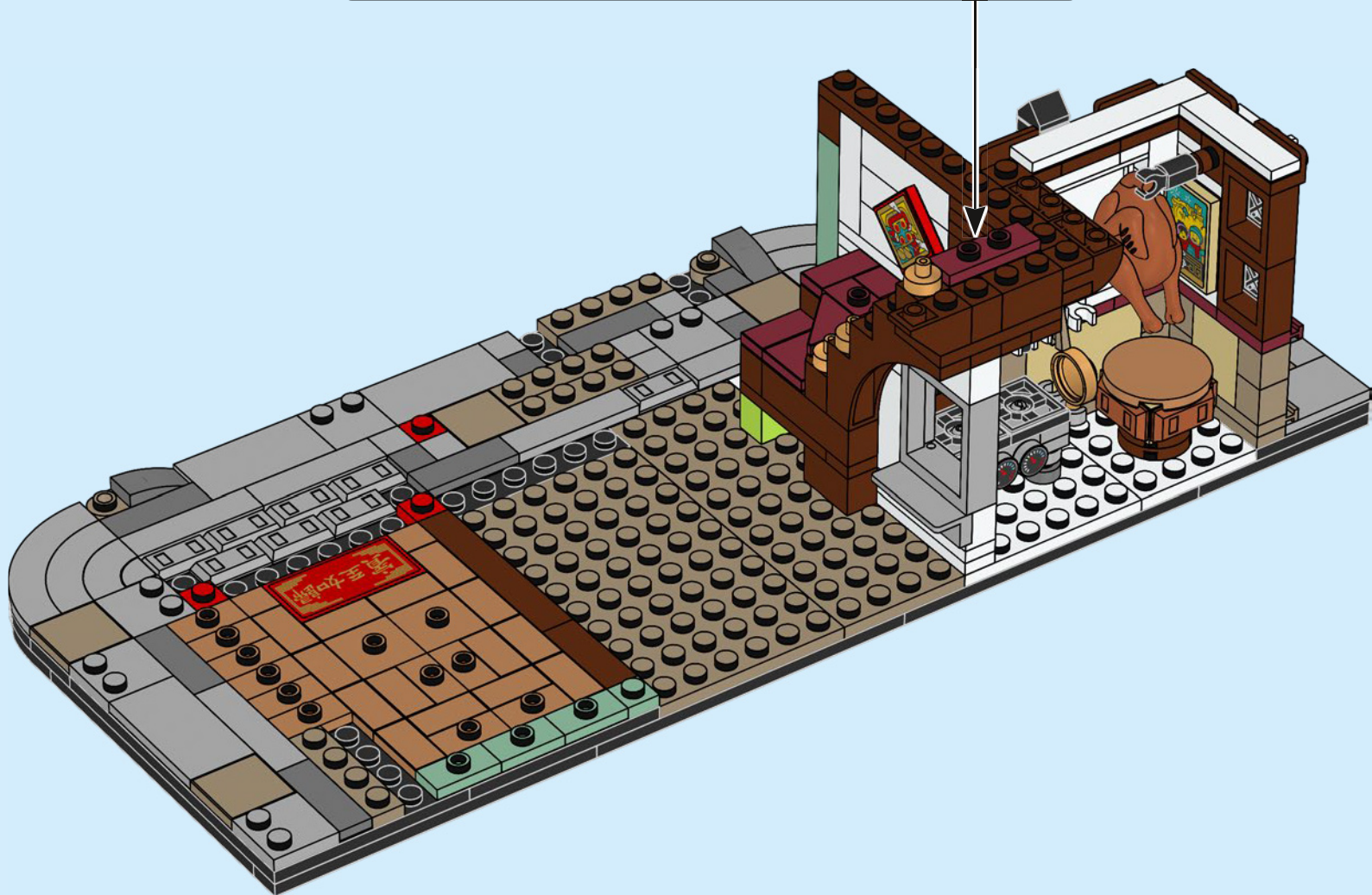
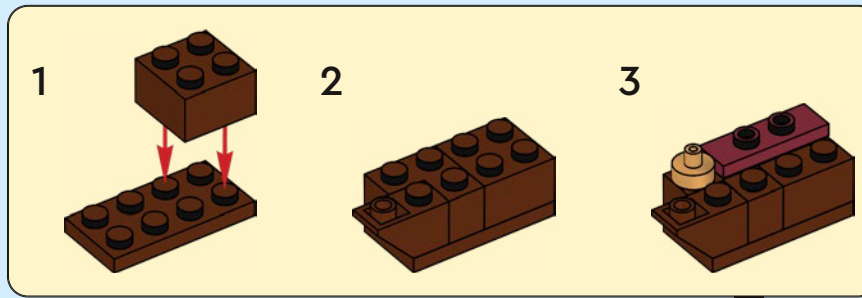

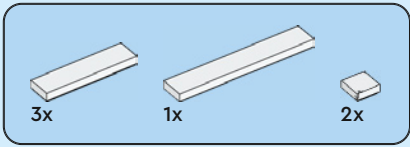

98

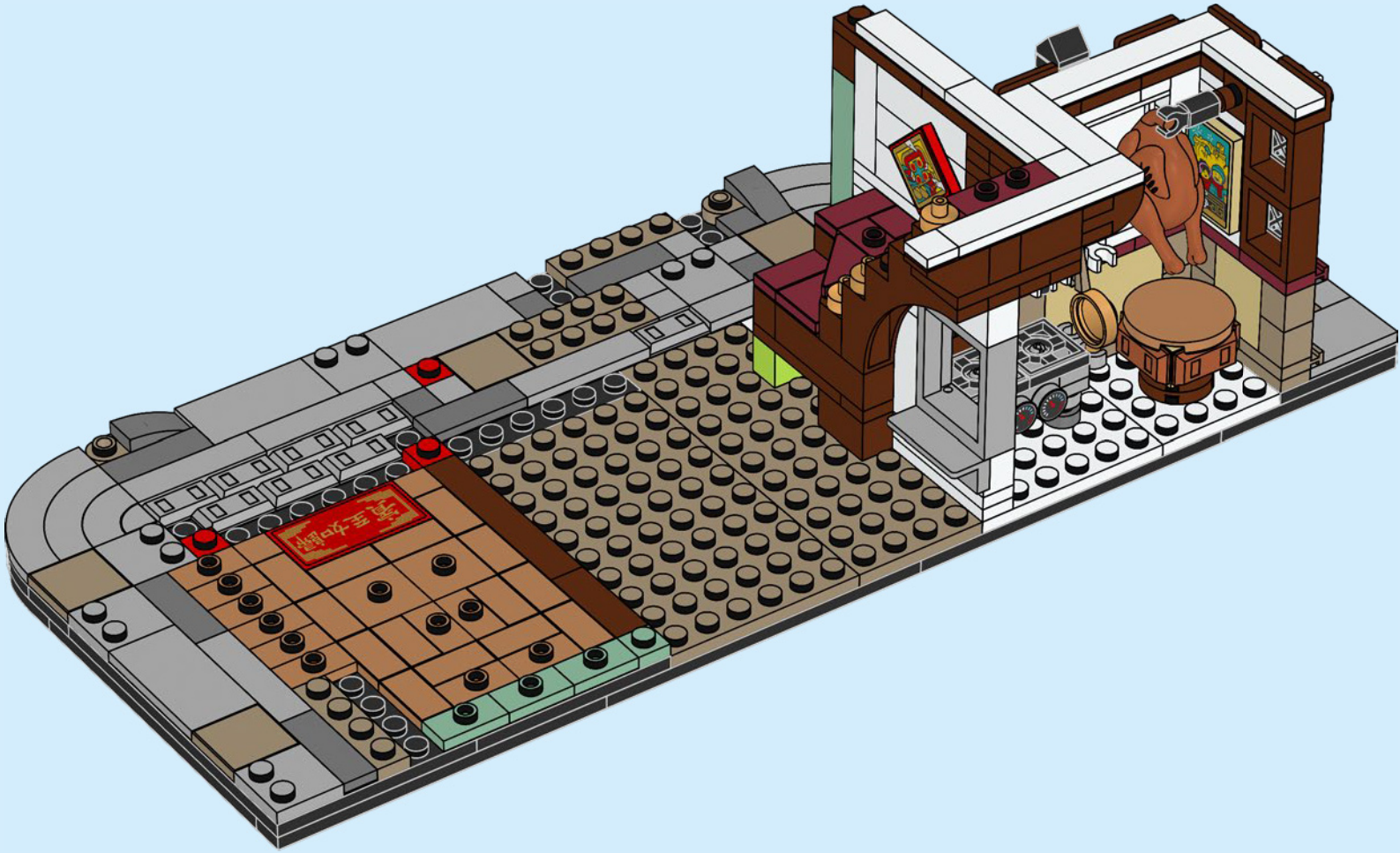

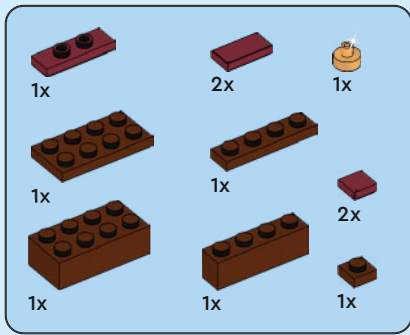

99

1

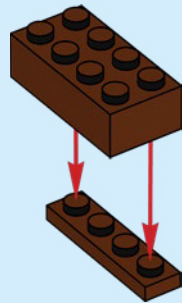

2

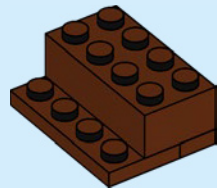

3

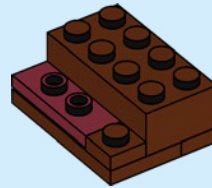

4

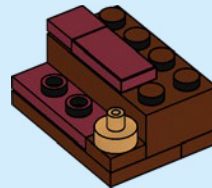

5

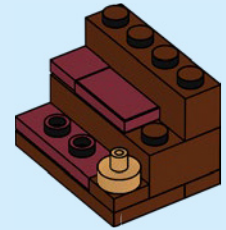

6

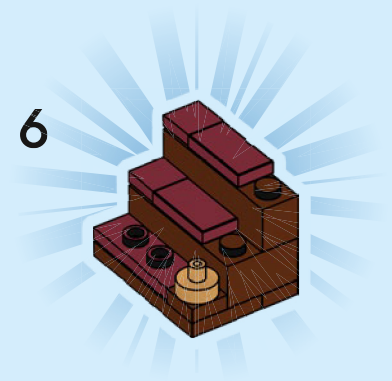

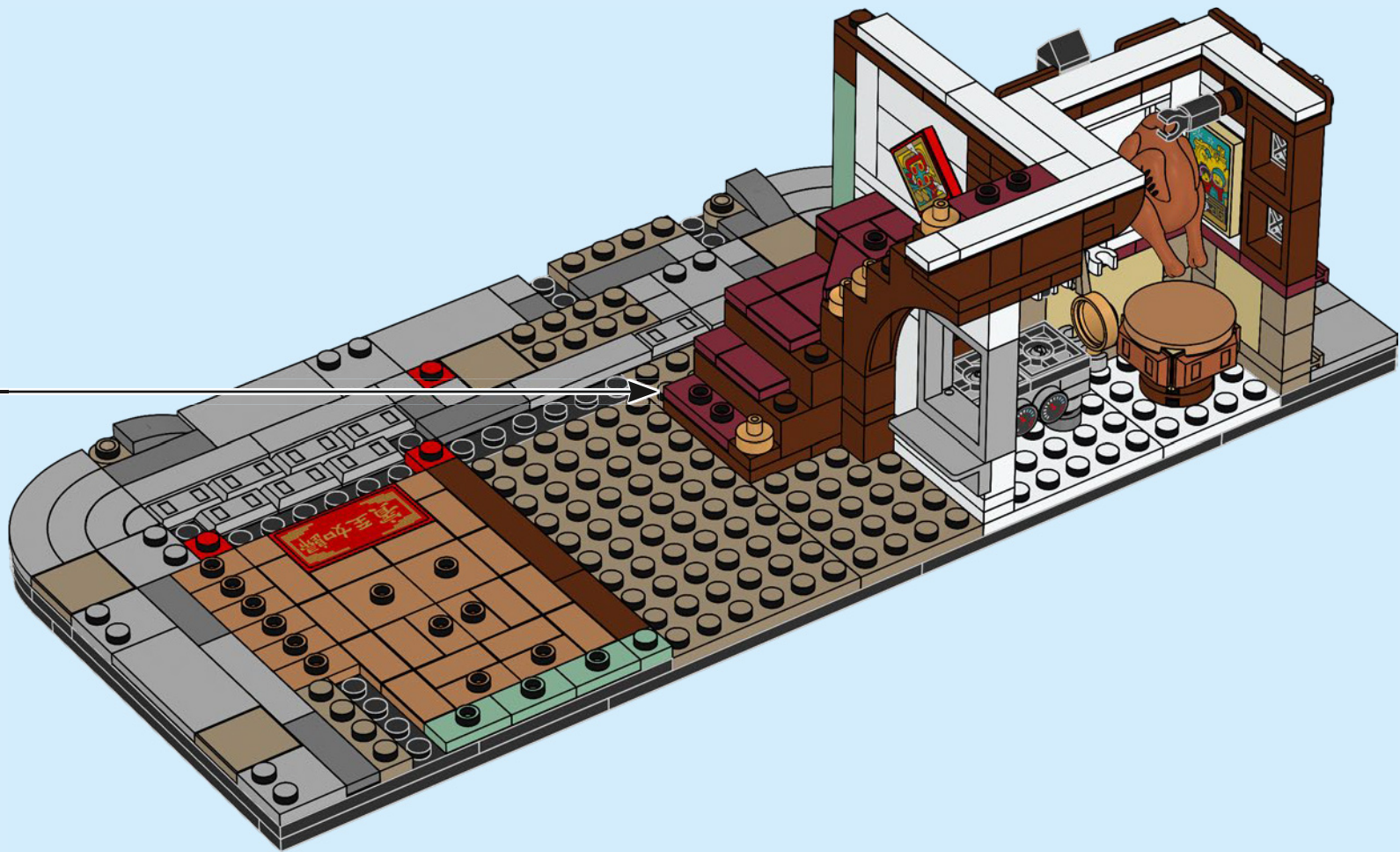

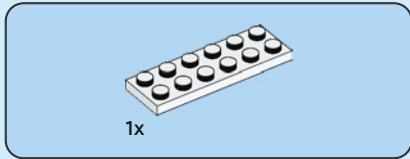
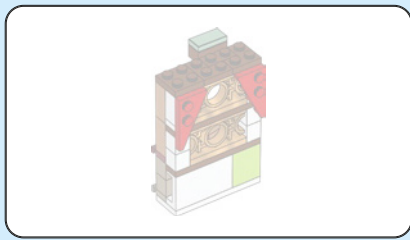

100

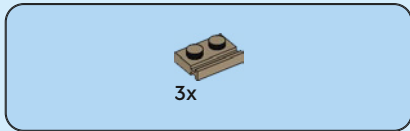

101

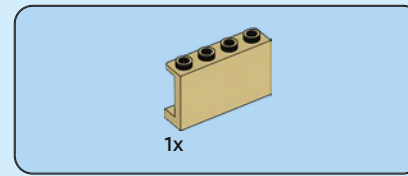
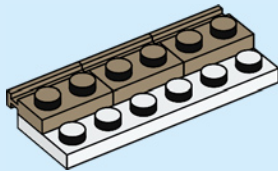

102

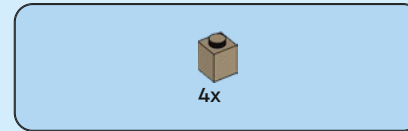
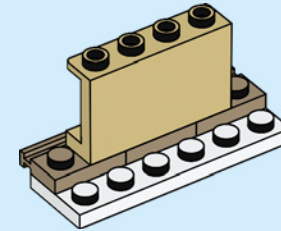

103

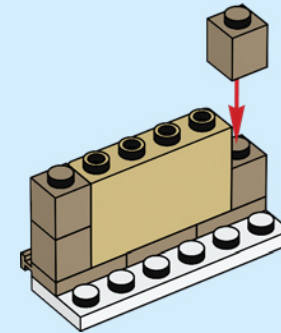

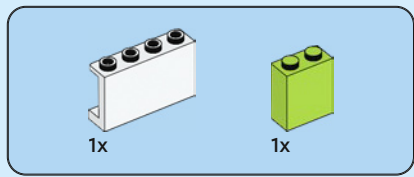

104

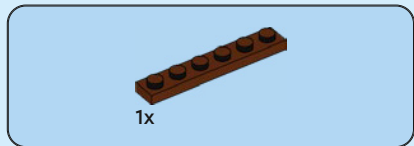
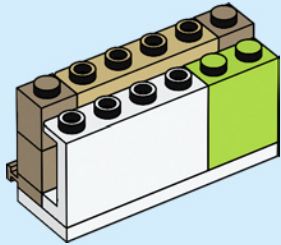

105

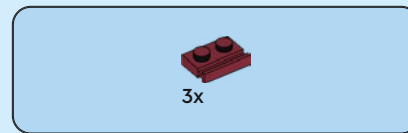
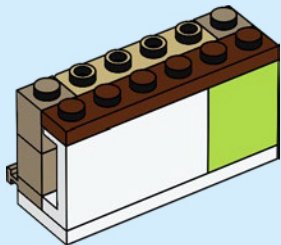

106

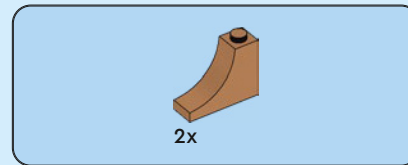
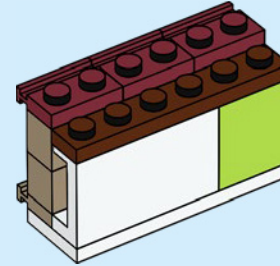

107

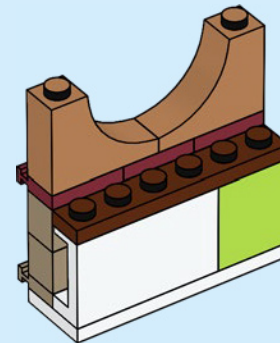

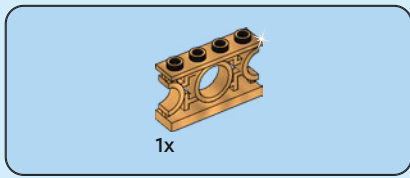

108

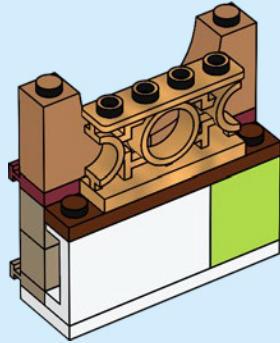

109

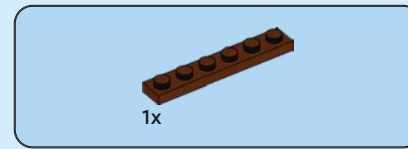
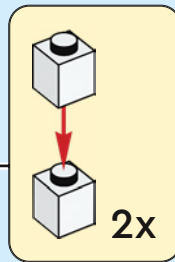
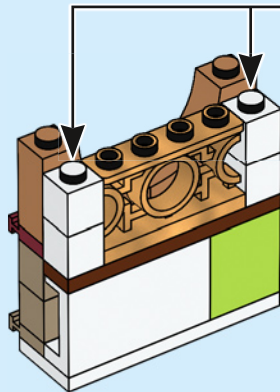

110

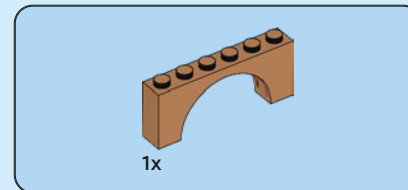
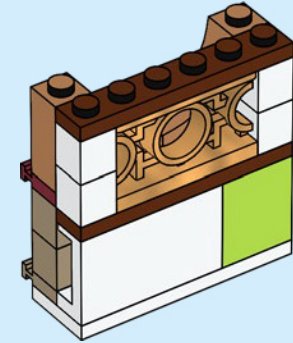

111

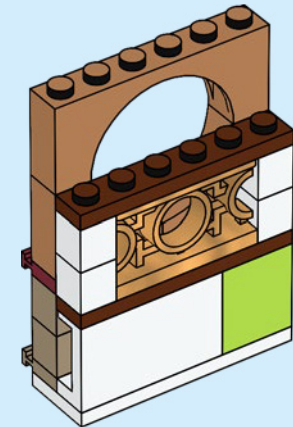

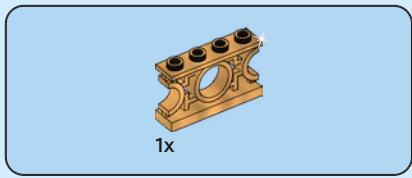

112

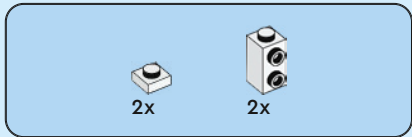
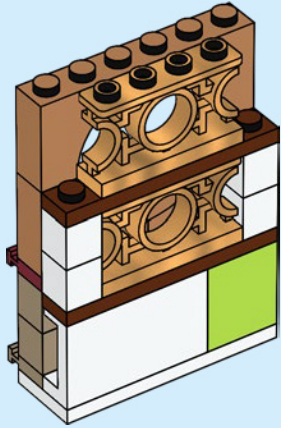

113

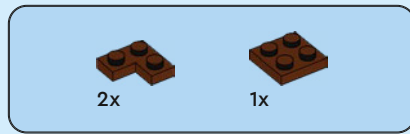
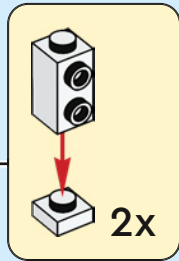
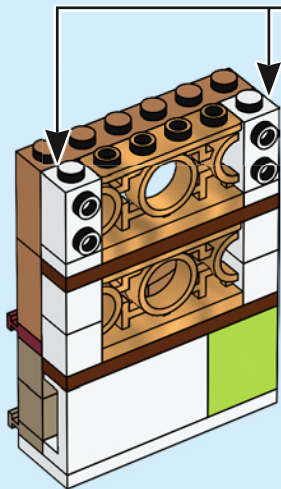

114

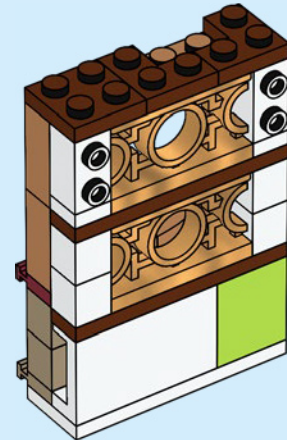

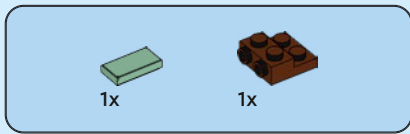

115

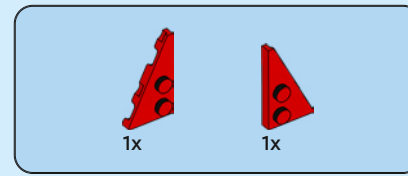
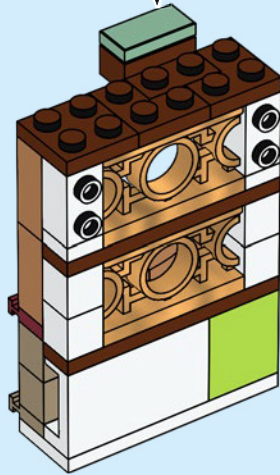
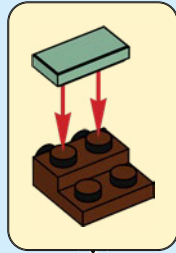

116

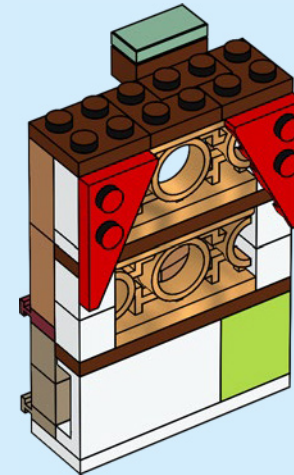

117

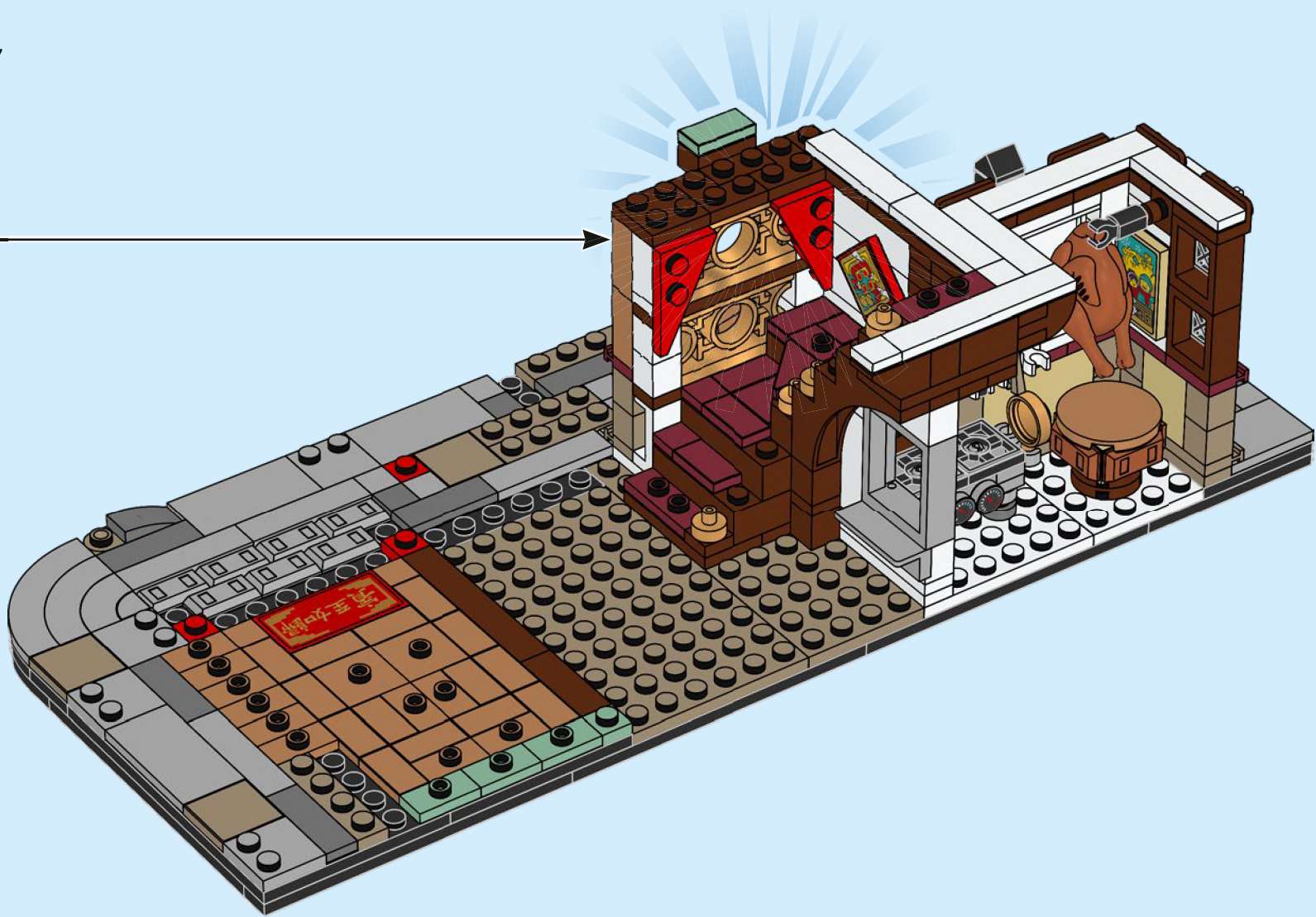

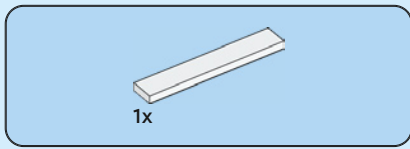

118

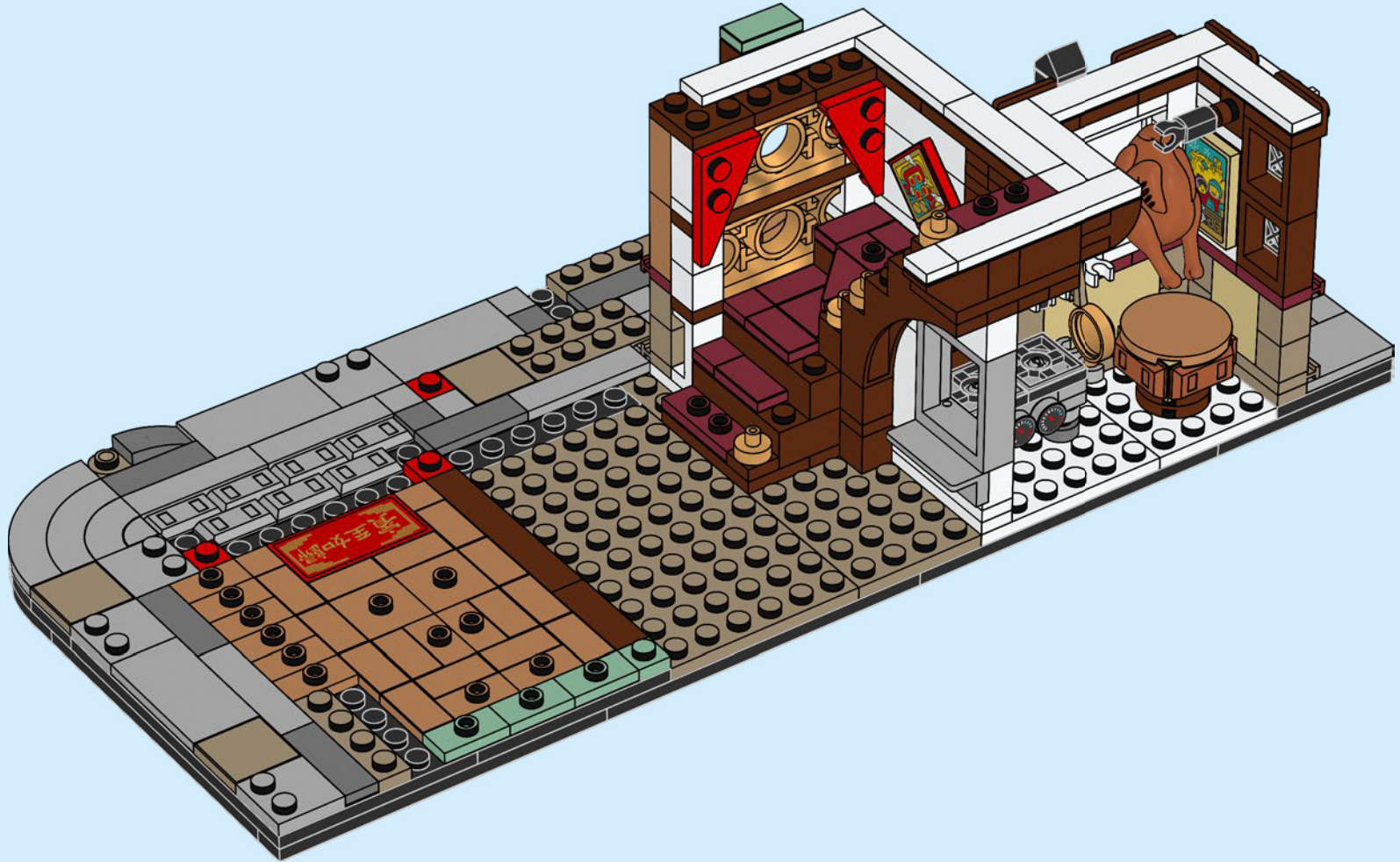

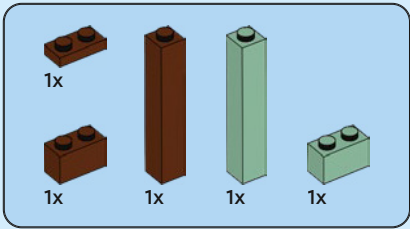

119

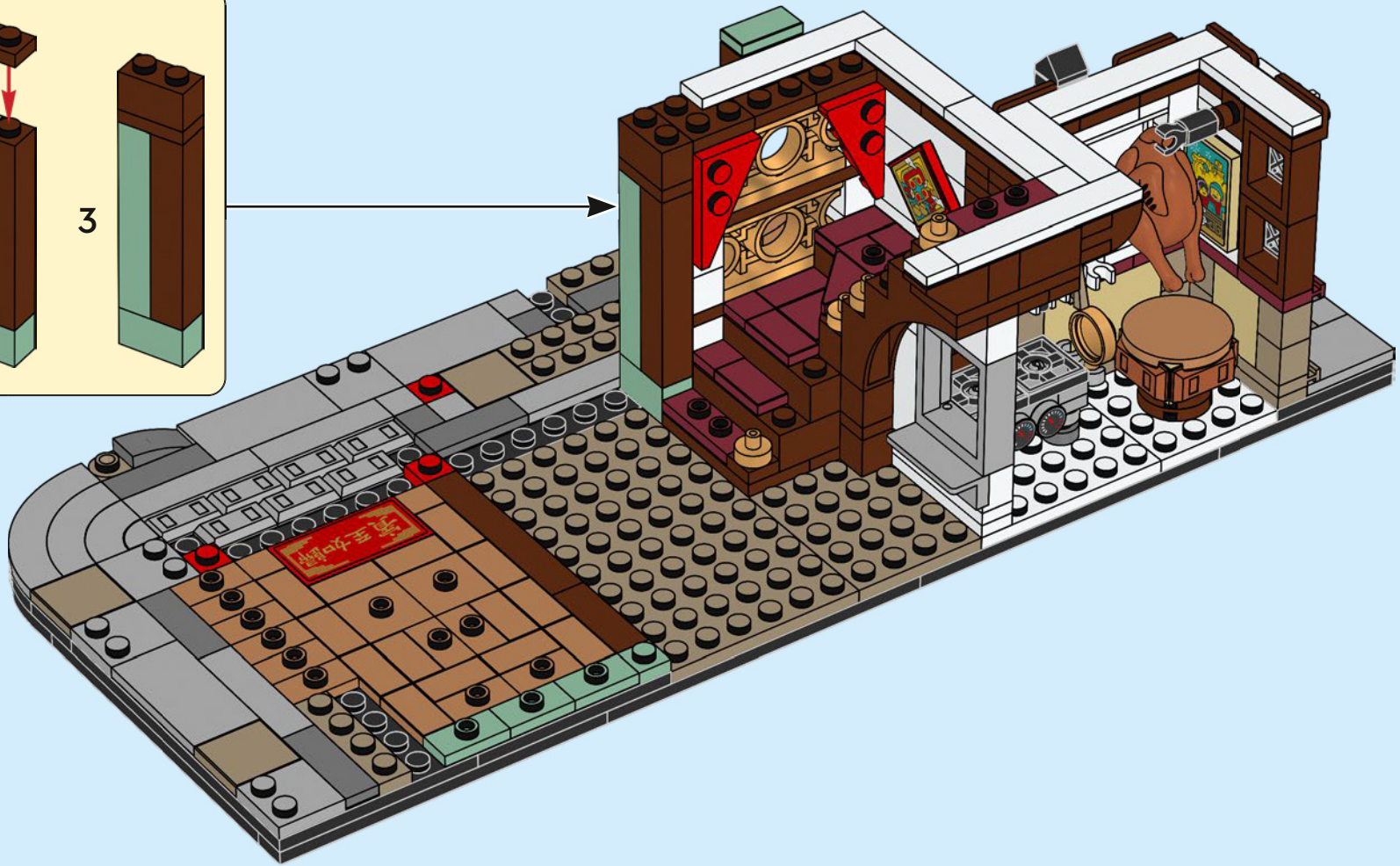
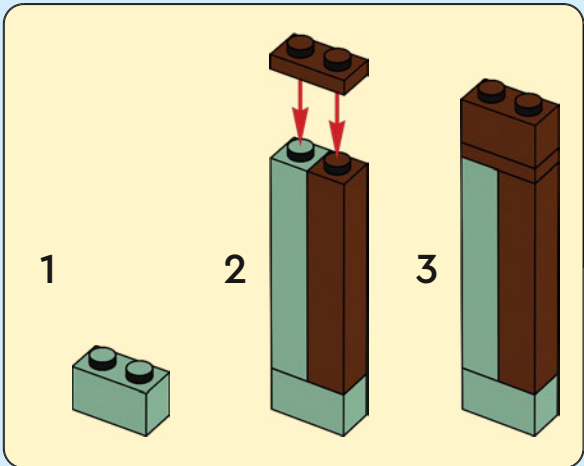



4x

120

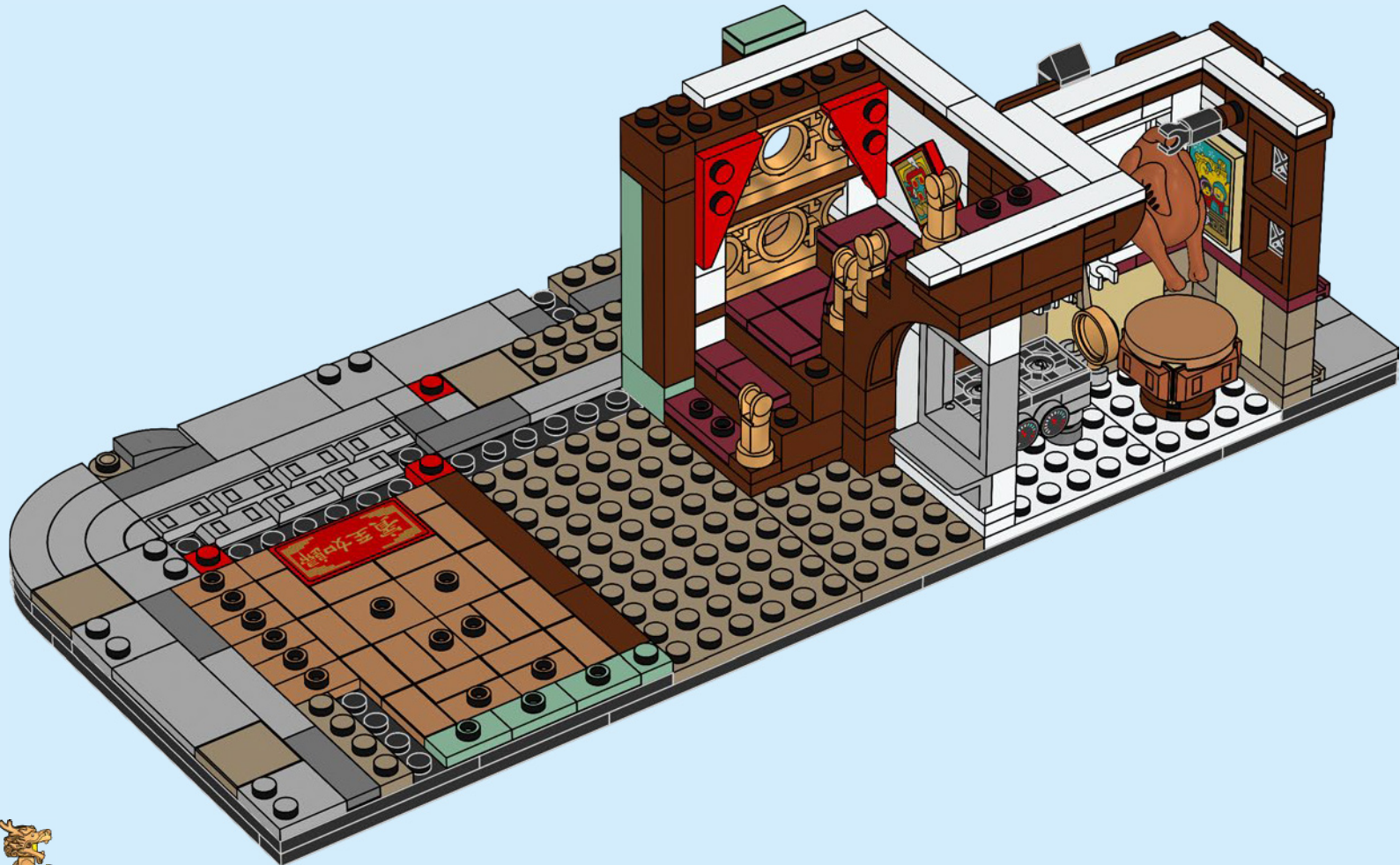



121

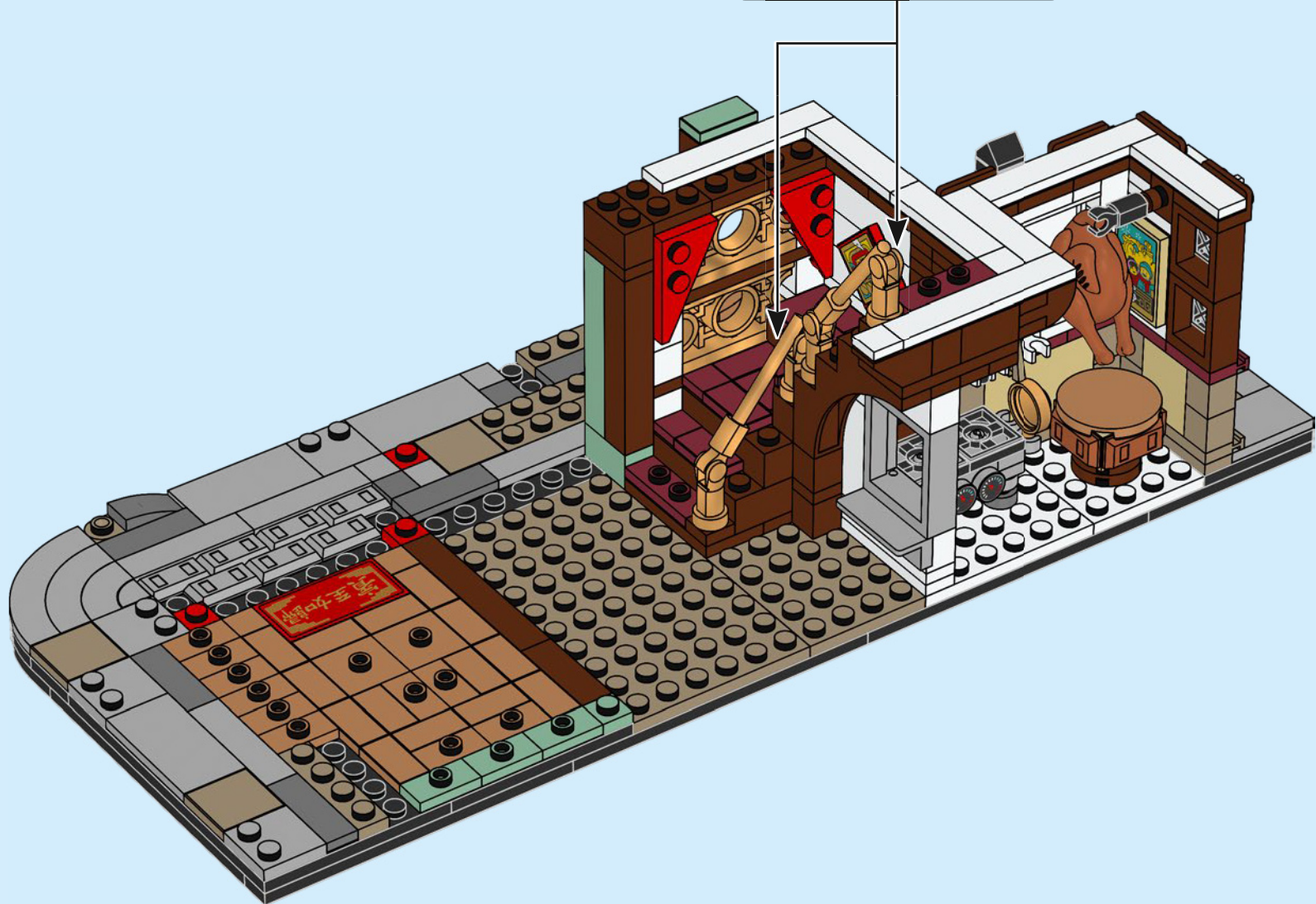
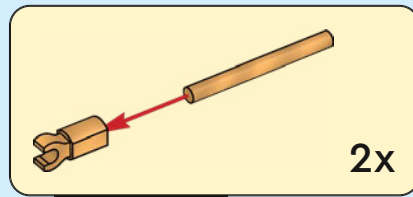

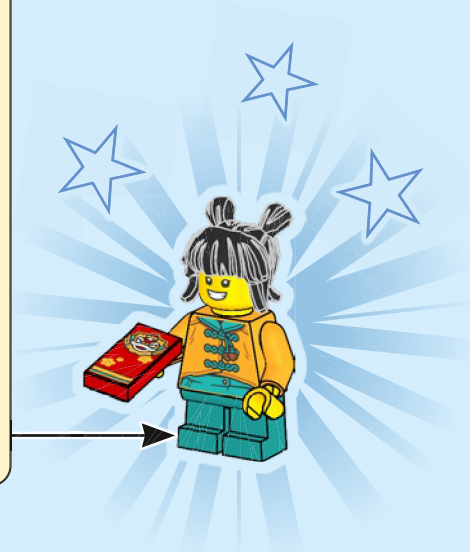
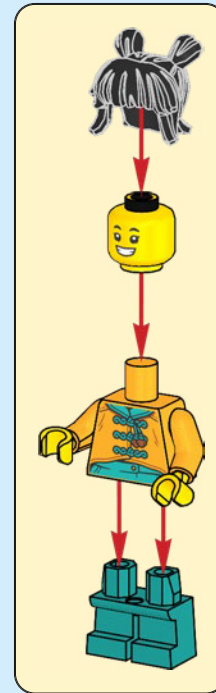

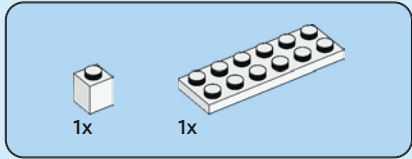
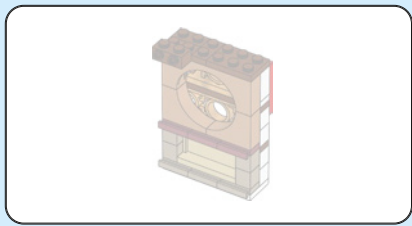

122

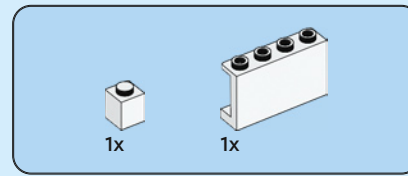
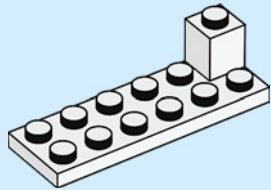

123

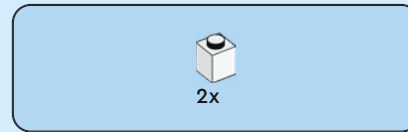
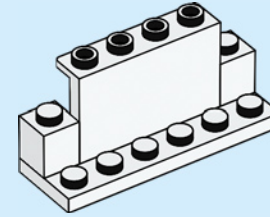

124

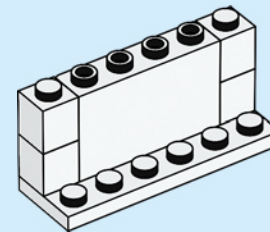



3x

125

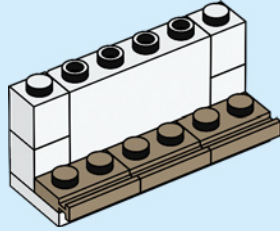

2x

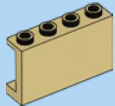

1x

126

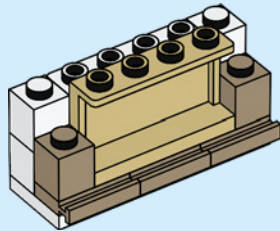

2x

127

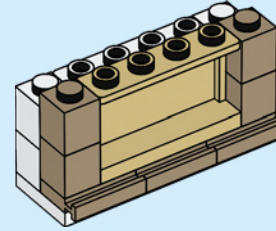

4x



1x

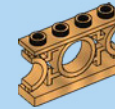

1x

128

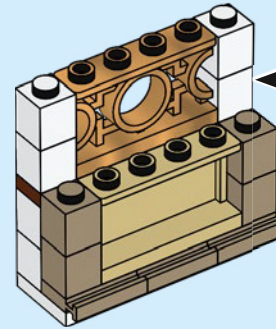

1

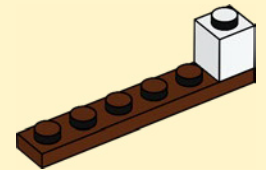

2

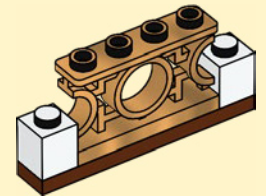

3

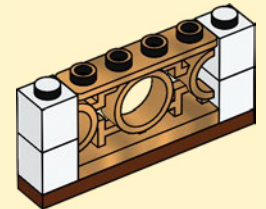

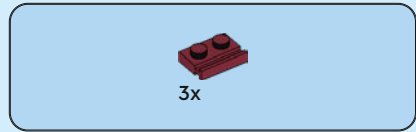

129

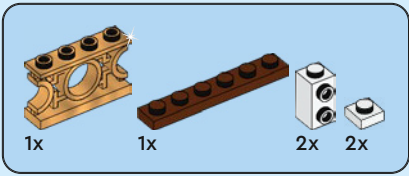
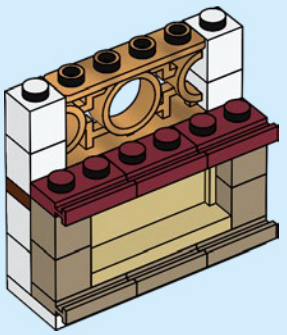

130

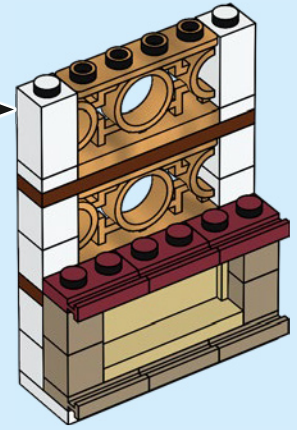
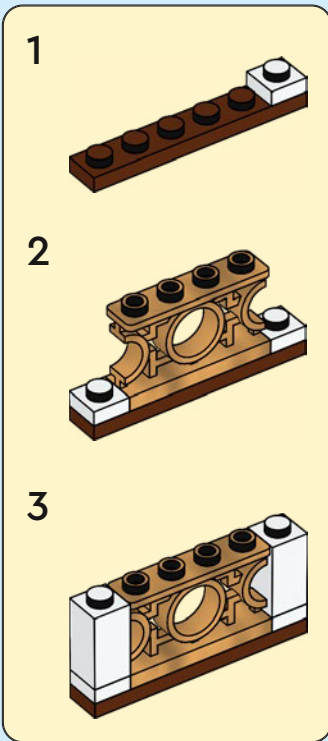

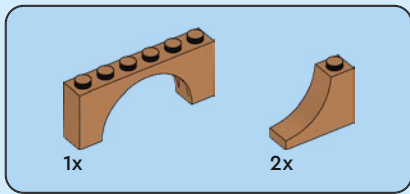

131

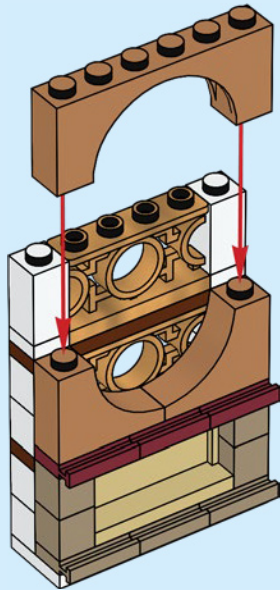

132

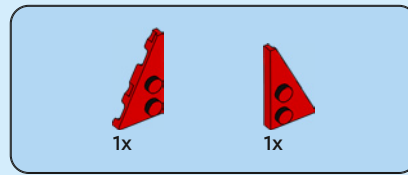
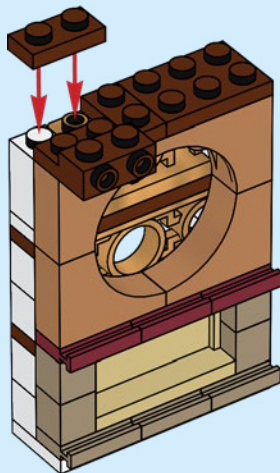

133

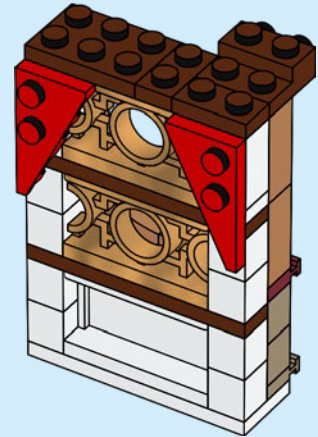

134

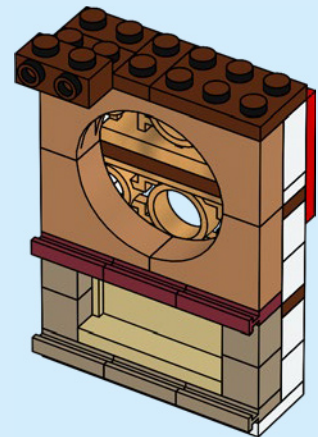
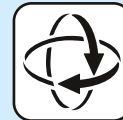

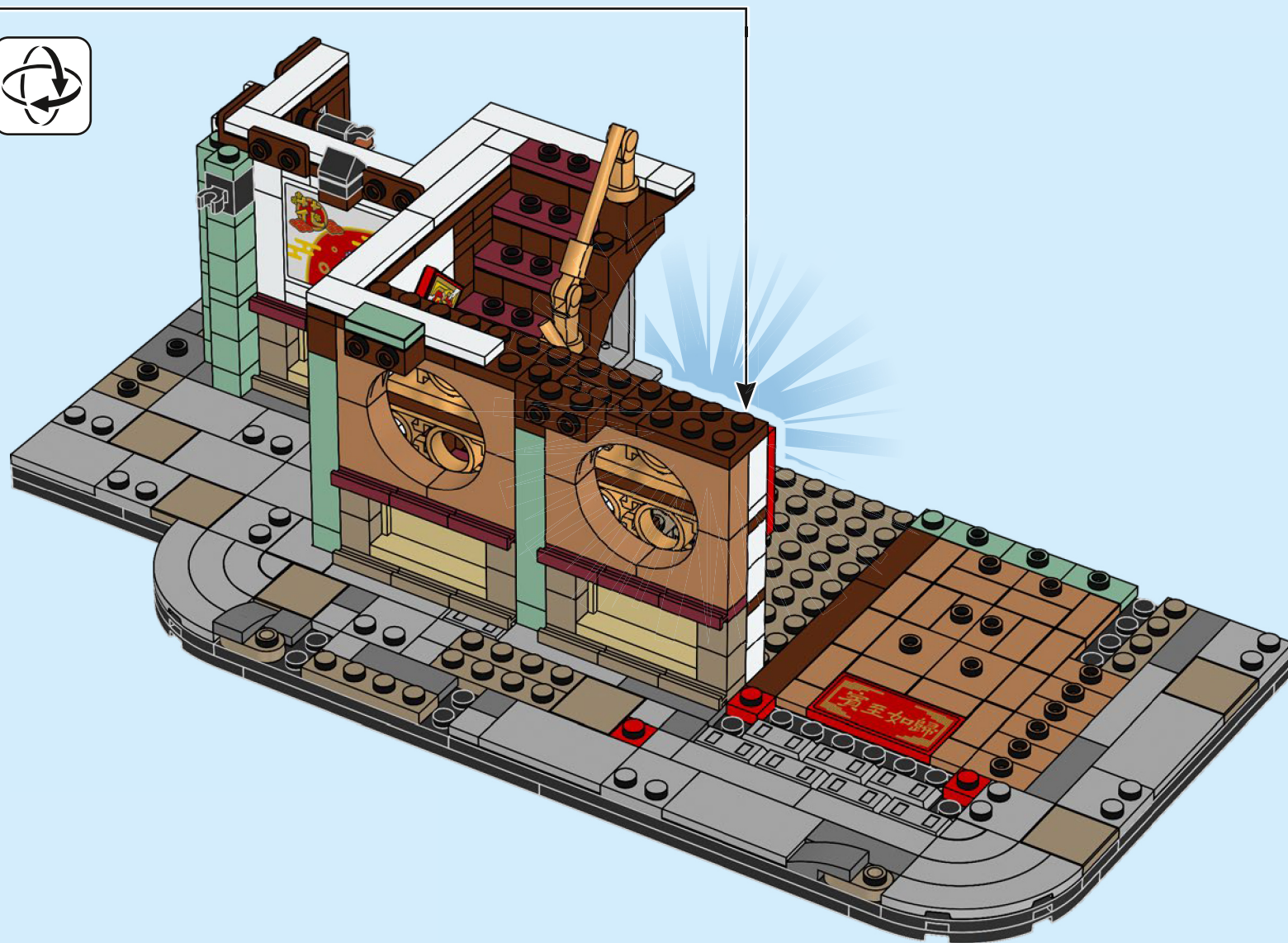

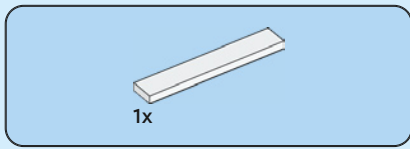

136

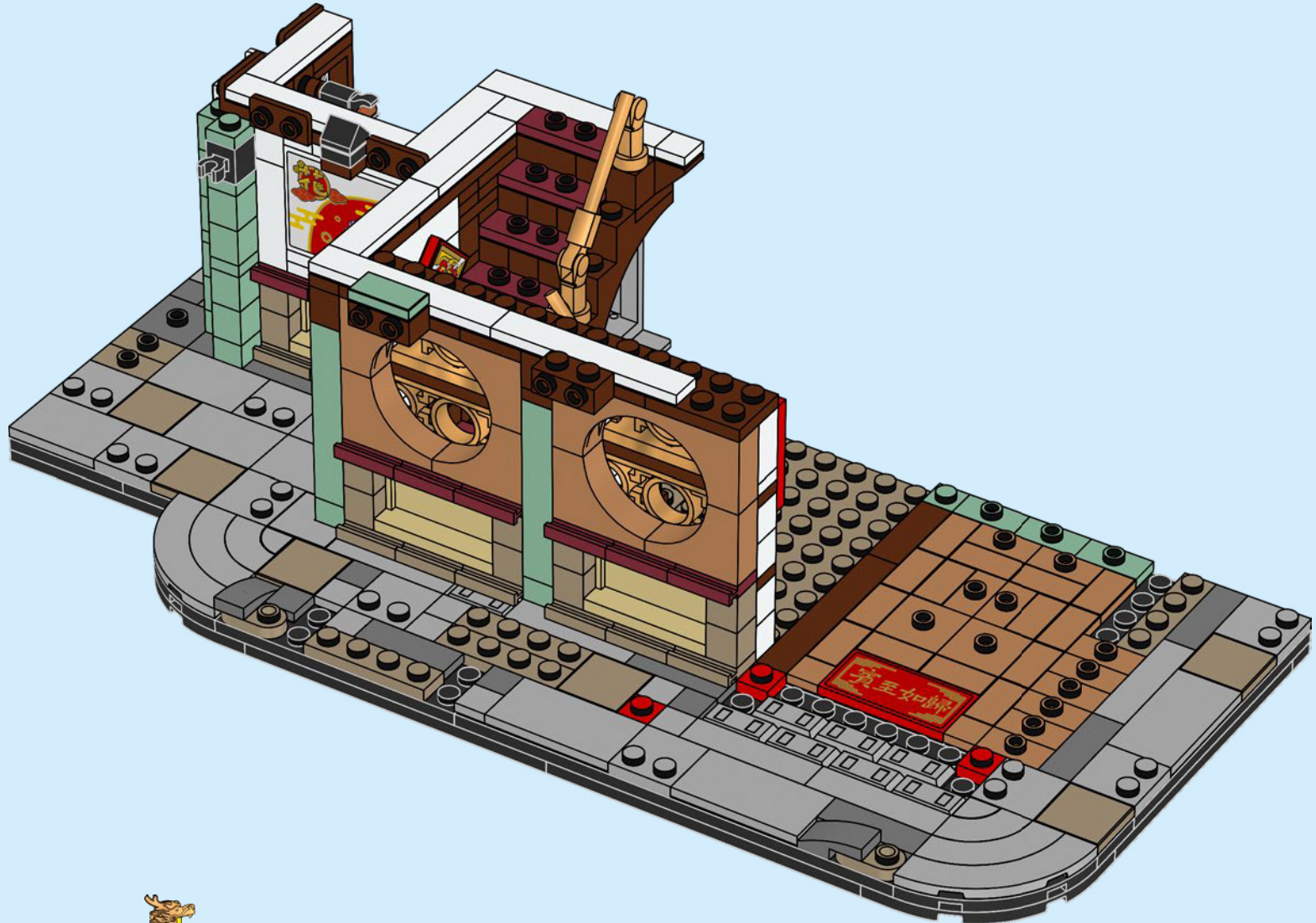

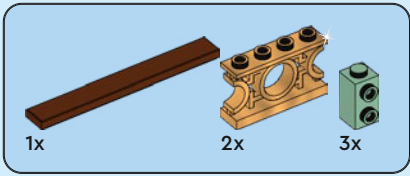

137

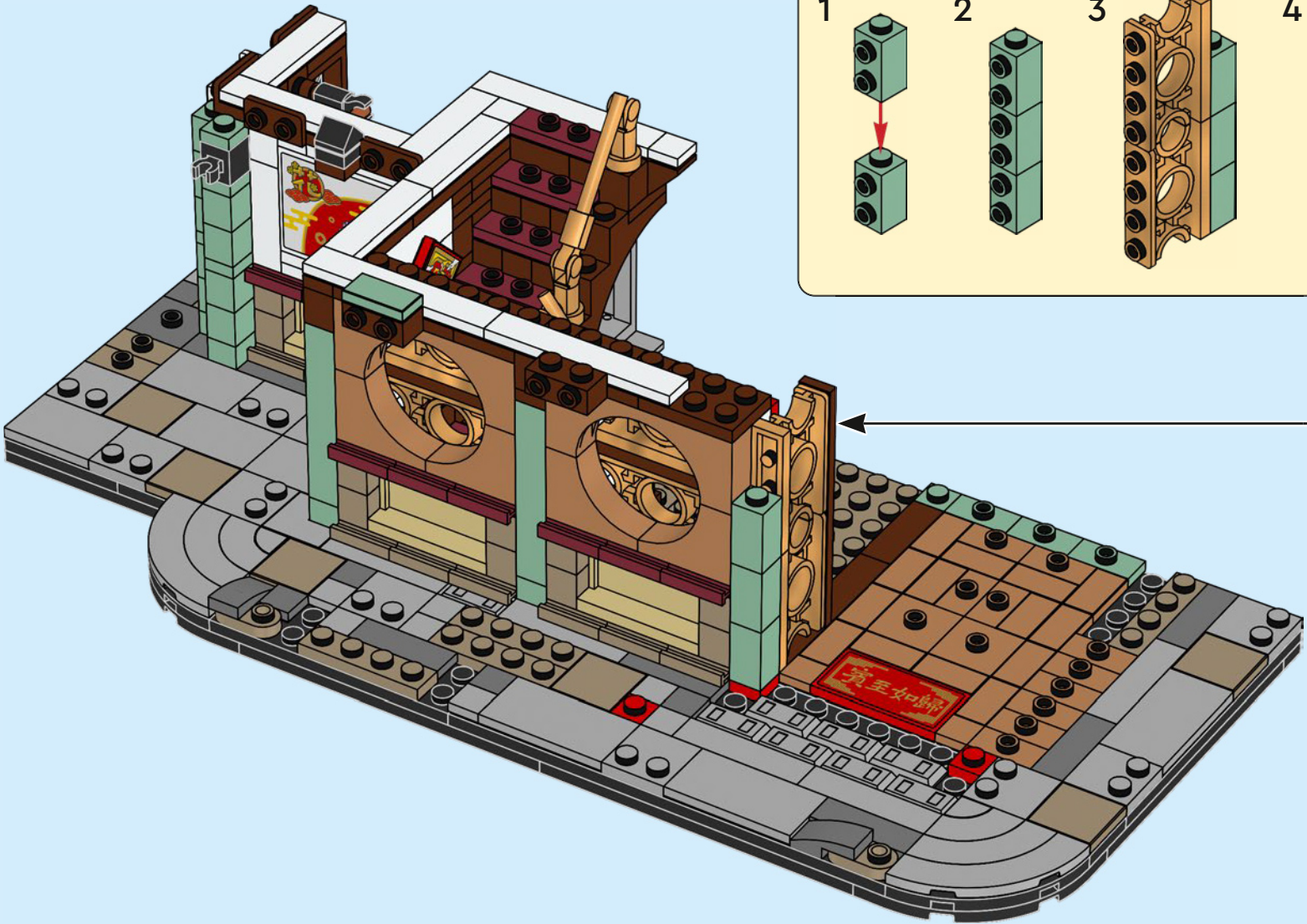
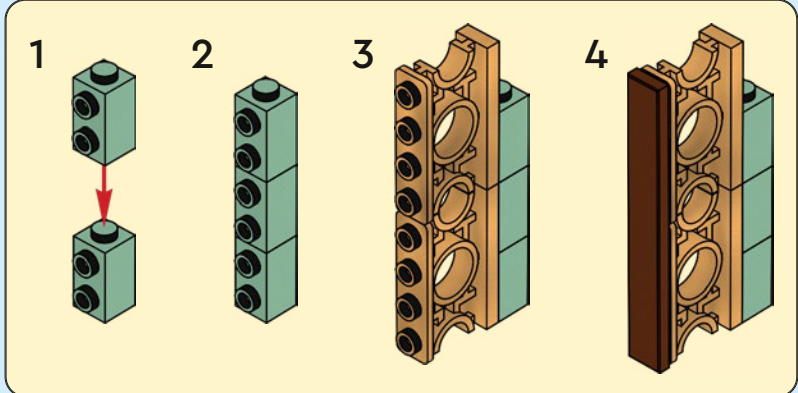

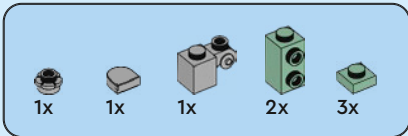

138

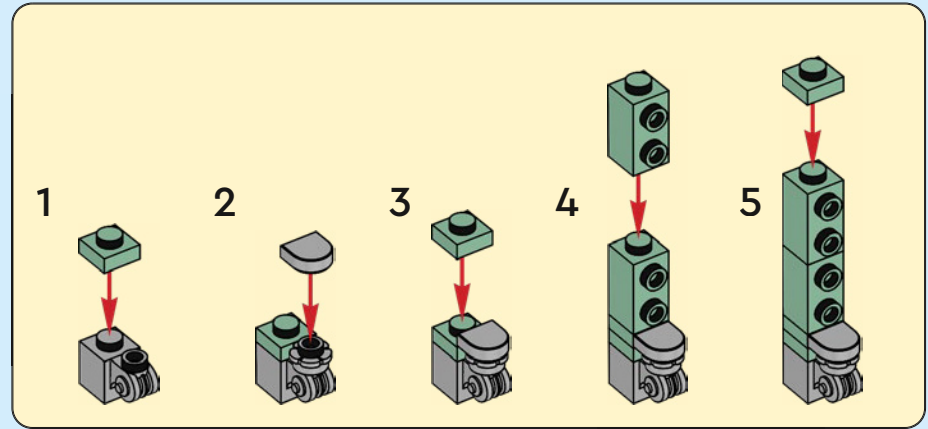
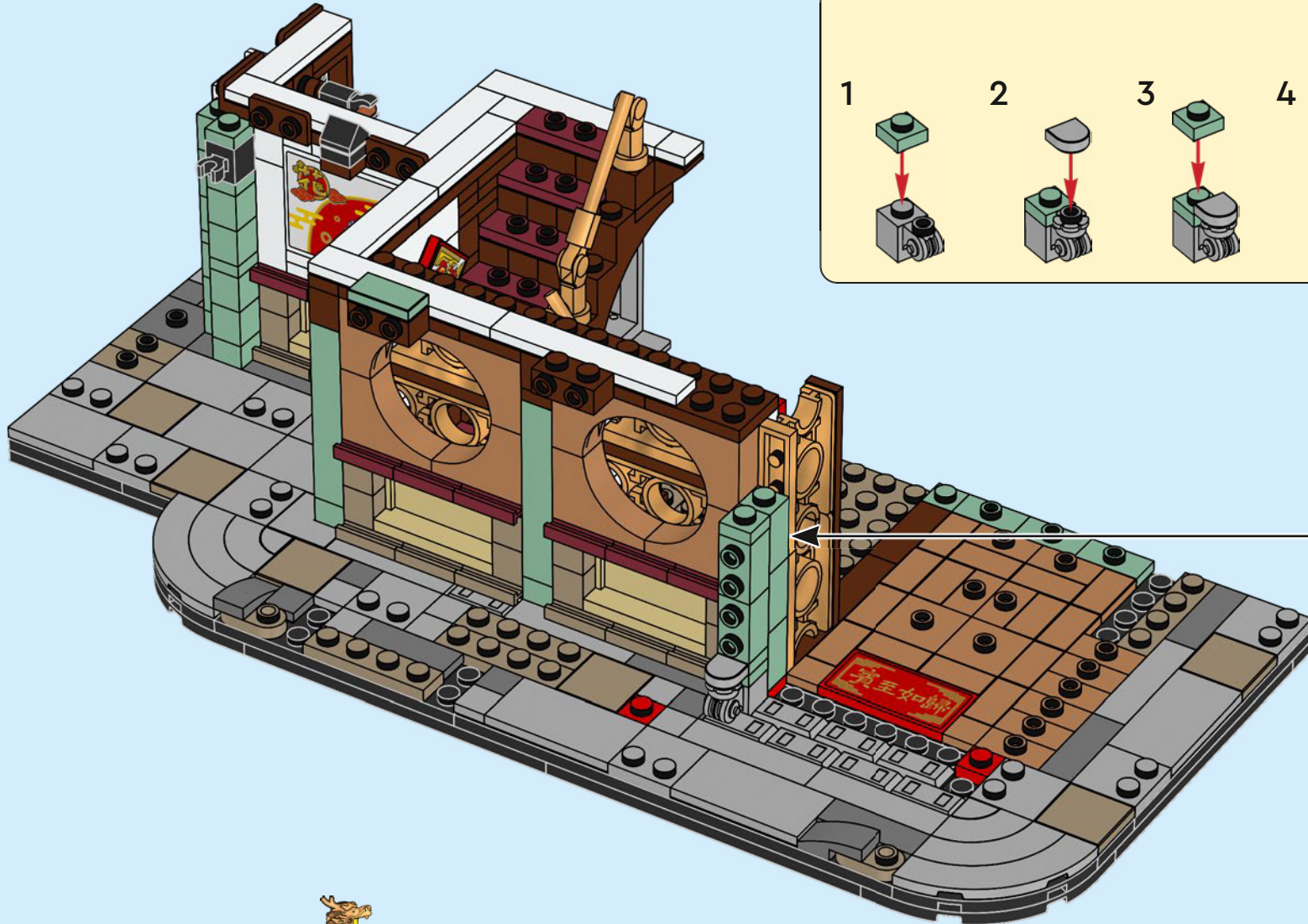

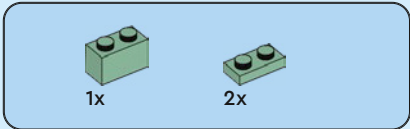

139

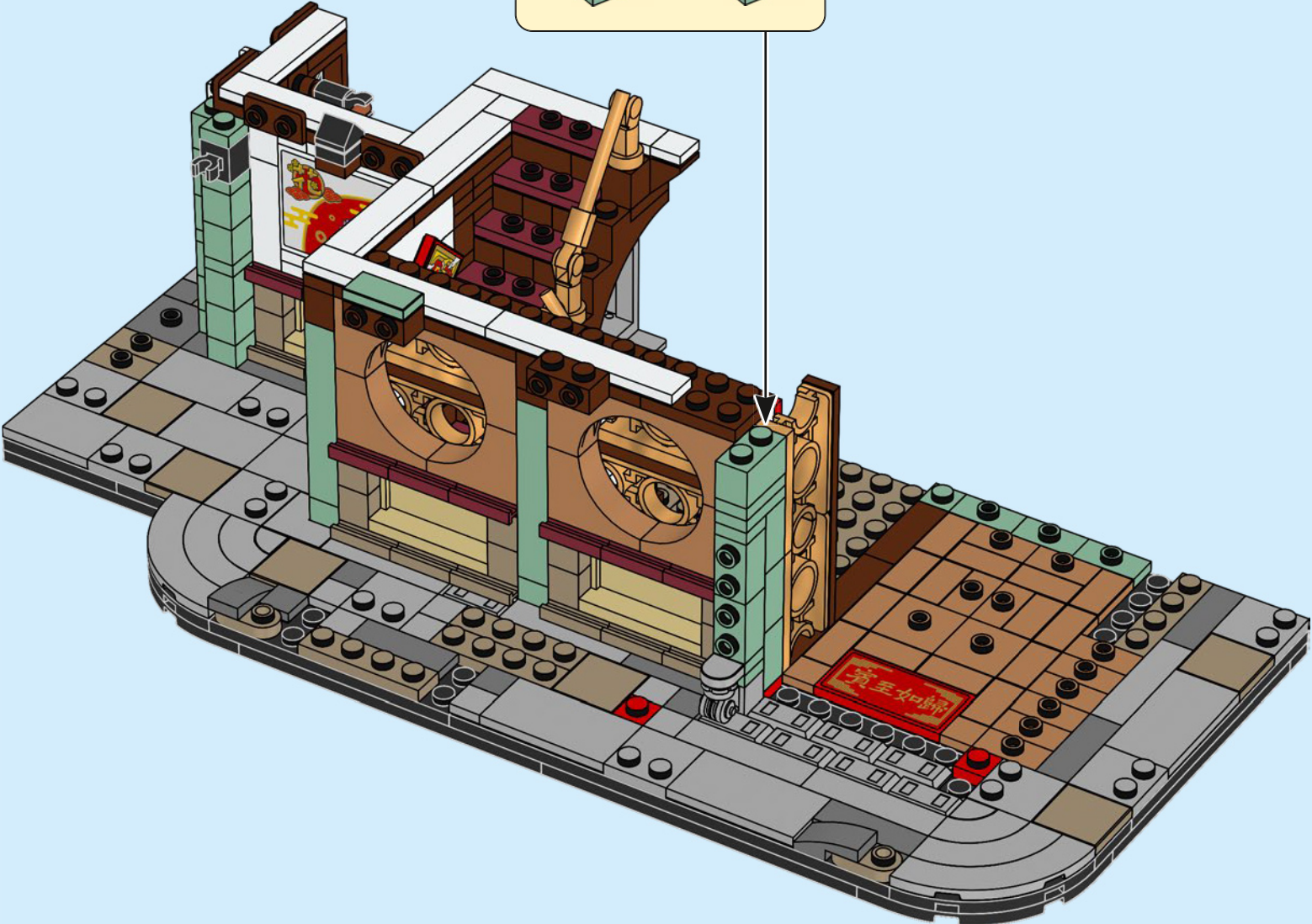
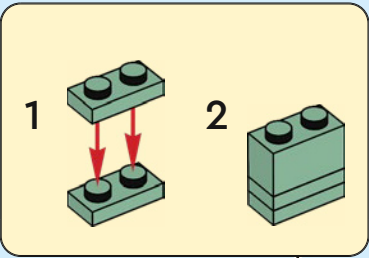

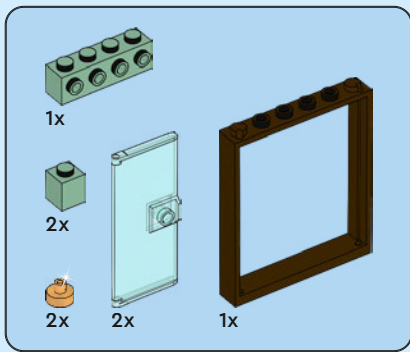

140

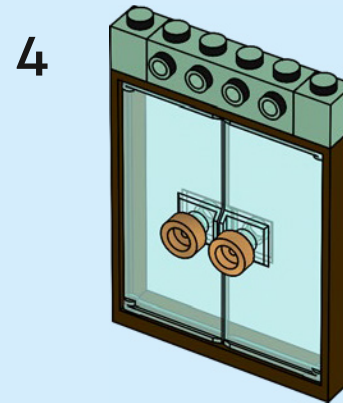
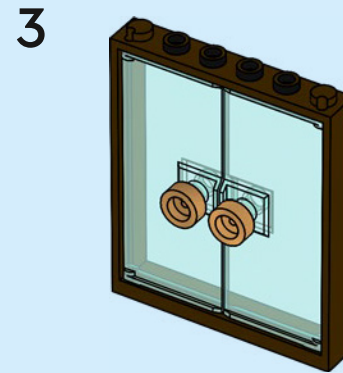
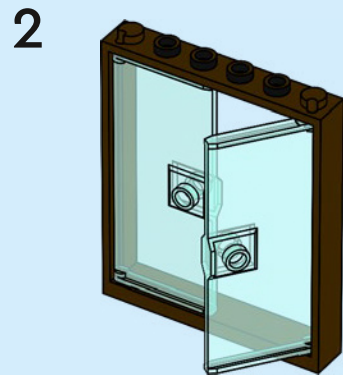
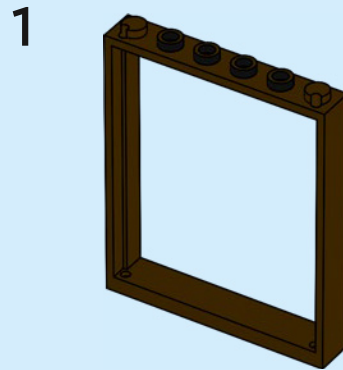

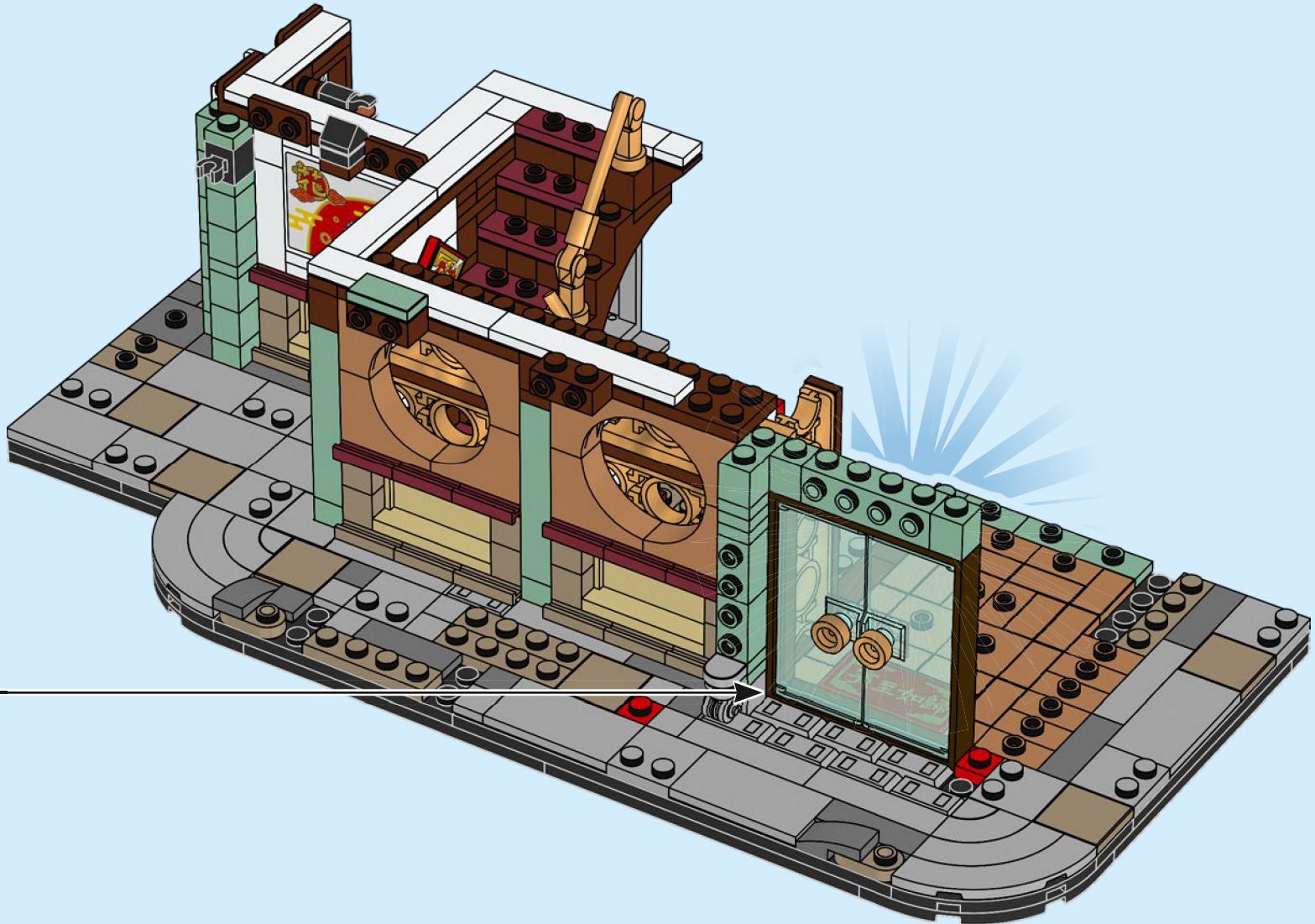

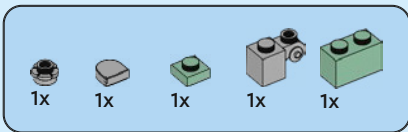

141

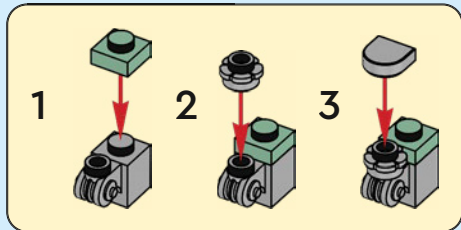
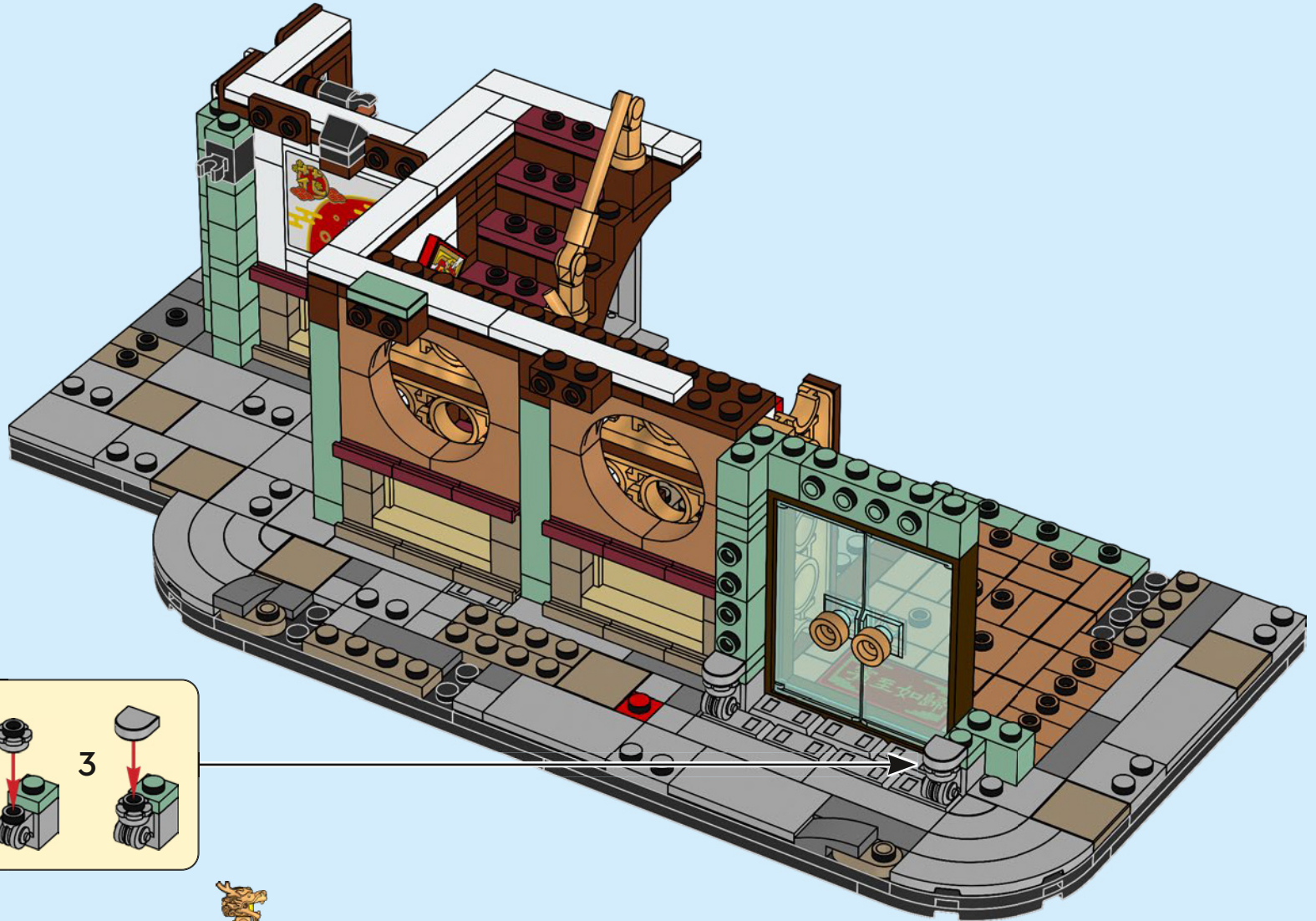

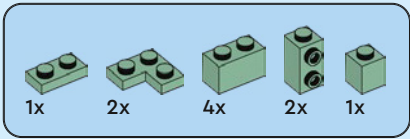

142

1

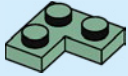

2

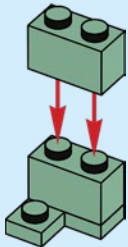

3

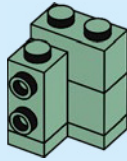

4

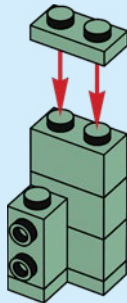

5

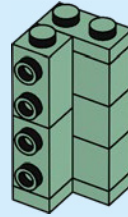

6

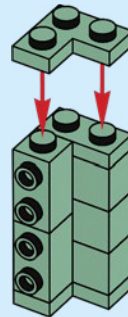

7

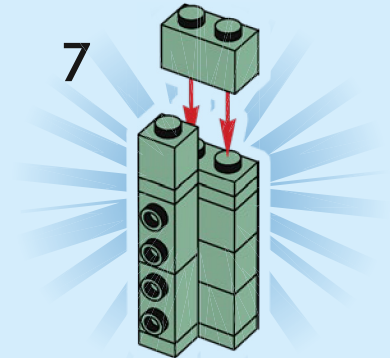

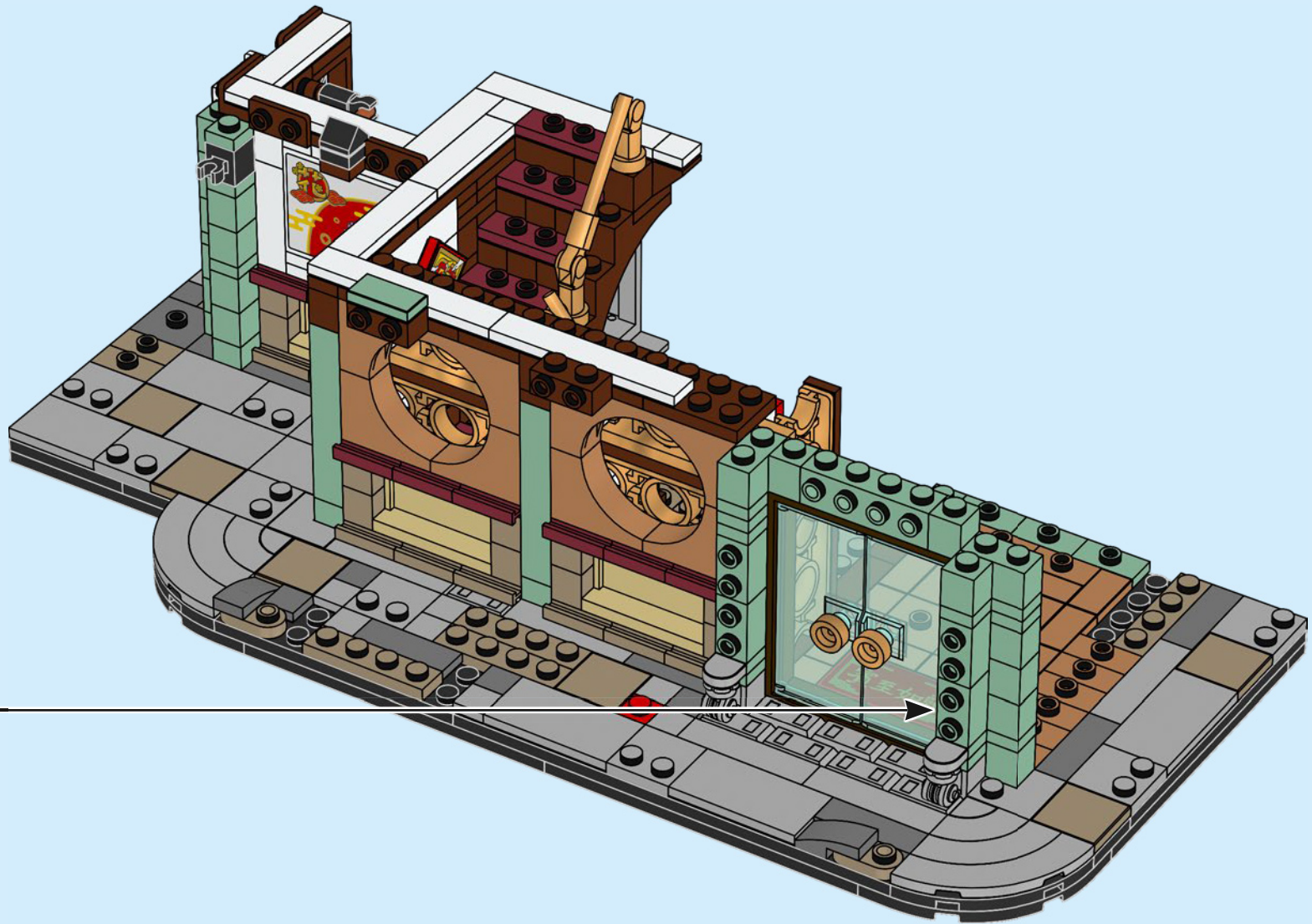

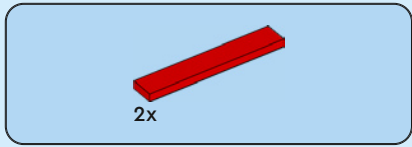

143

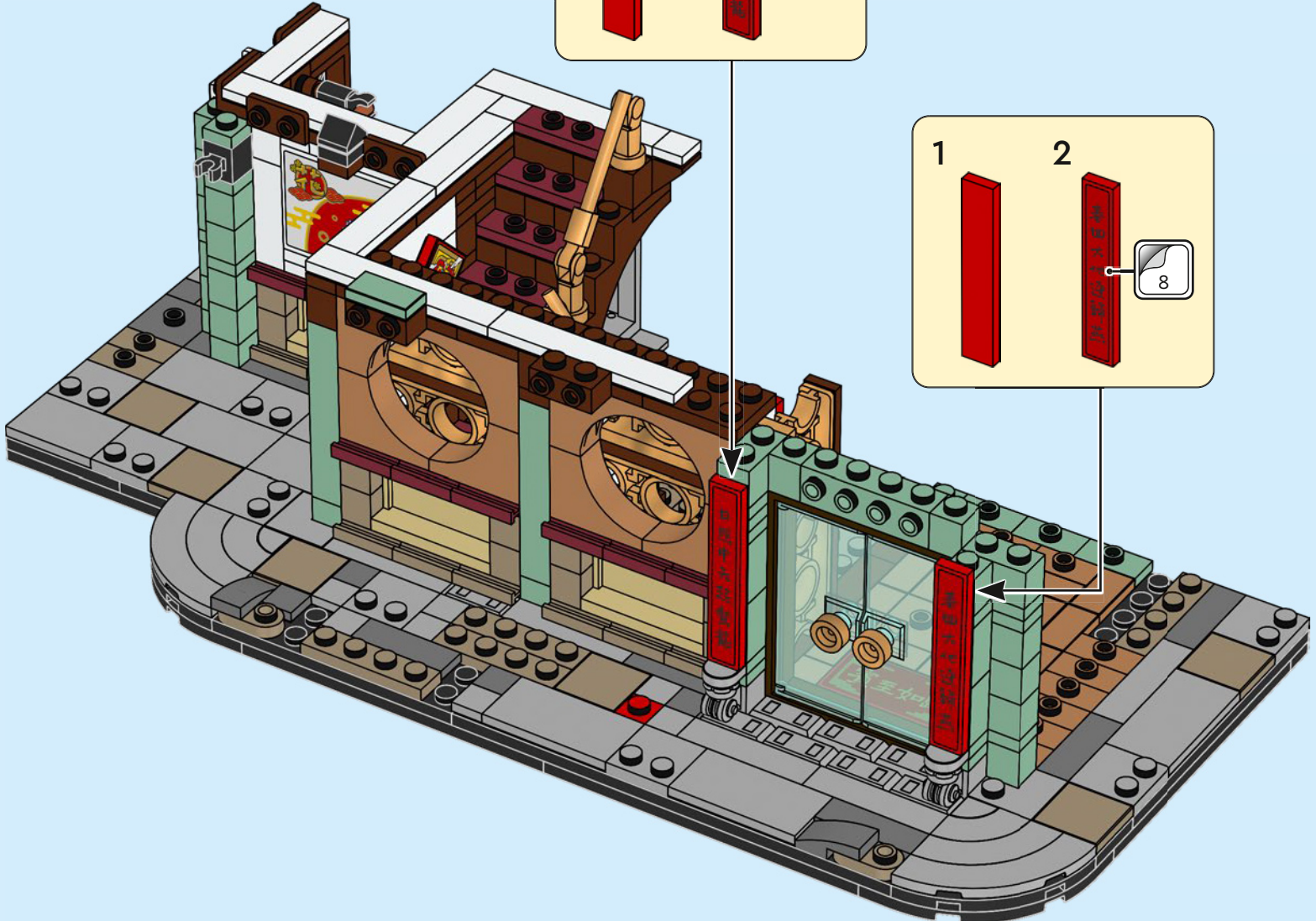
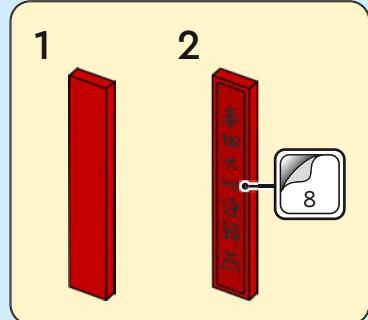
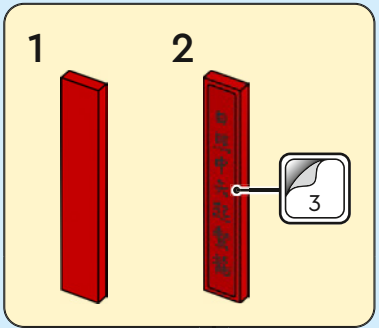



144

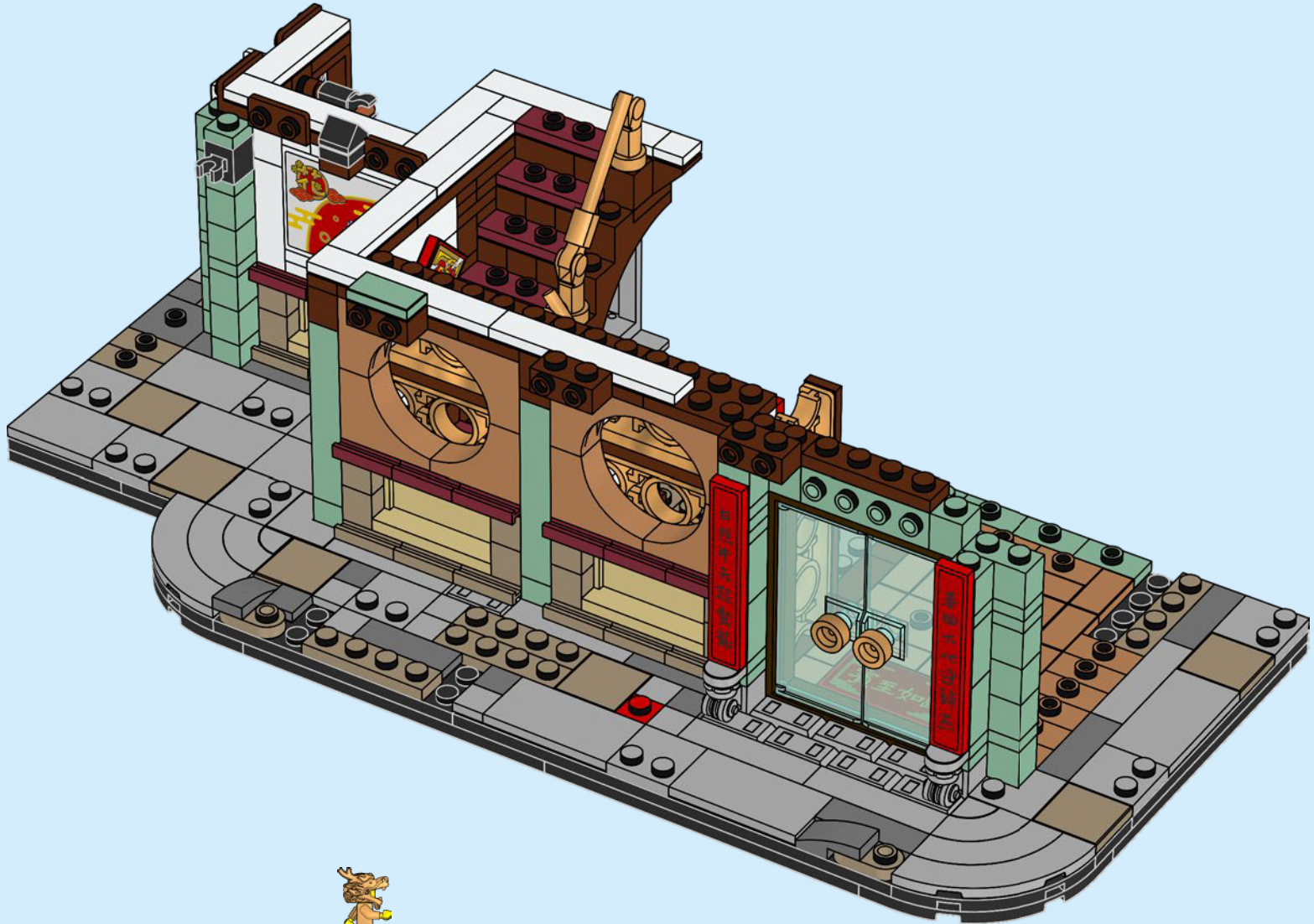

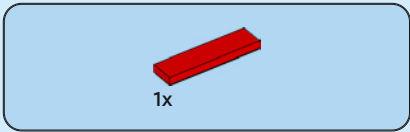

145

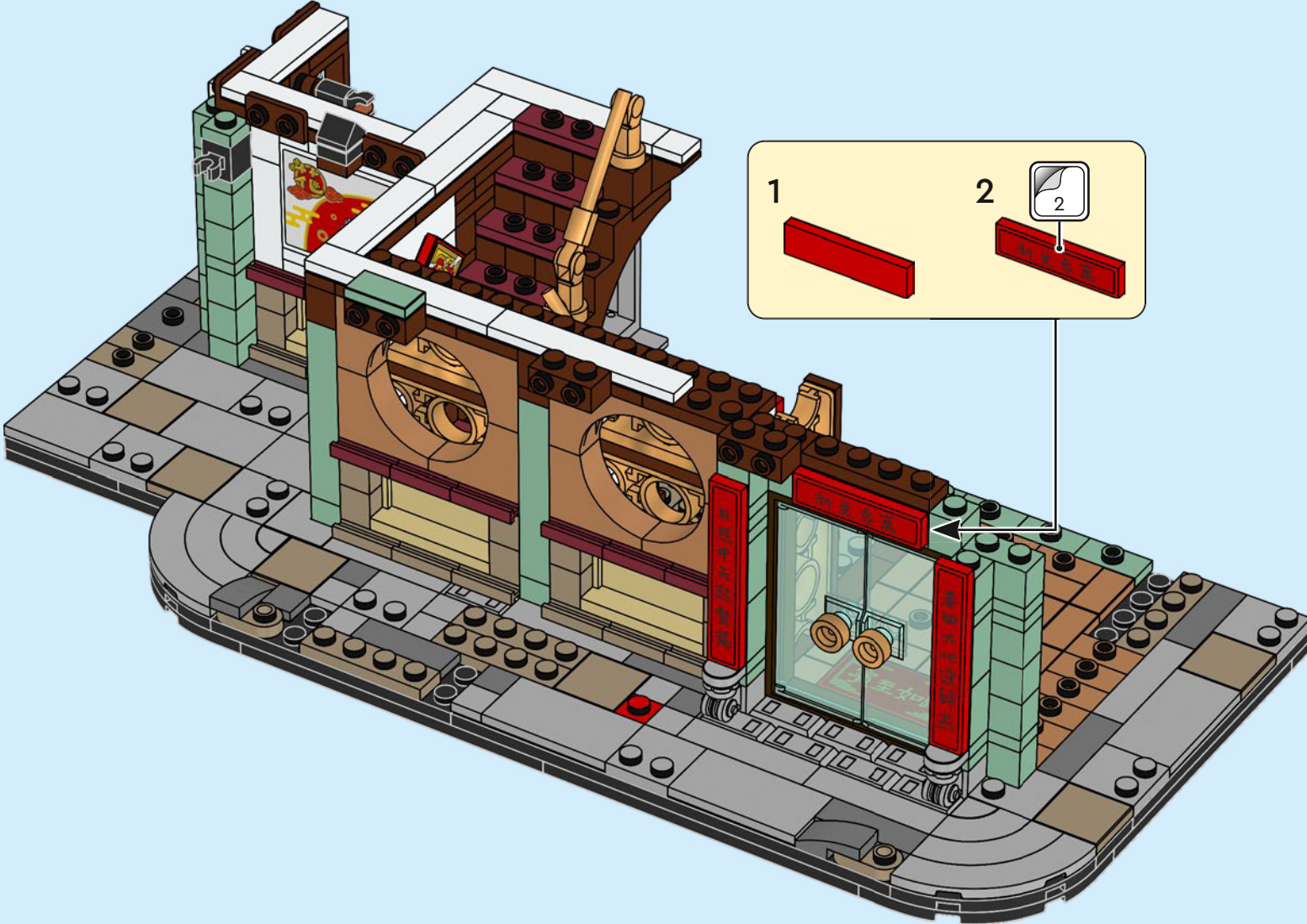



3x

146



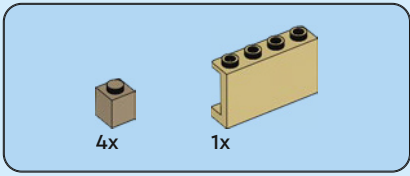

147

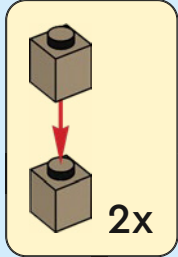

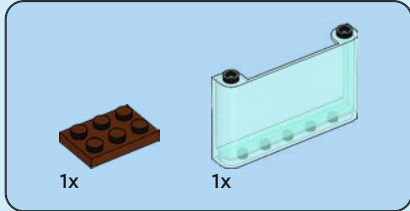

148

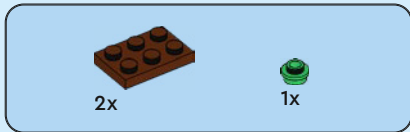
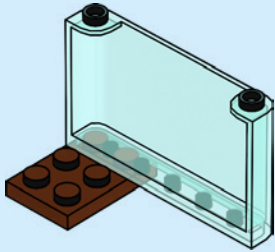

149

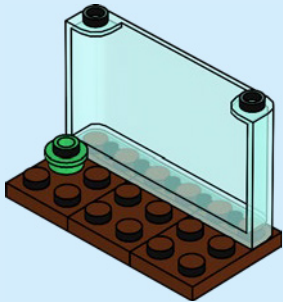

150

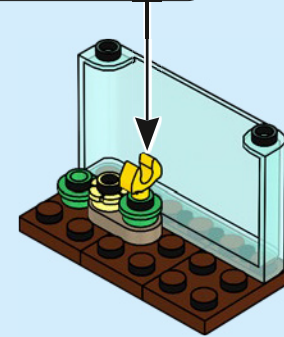
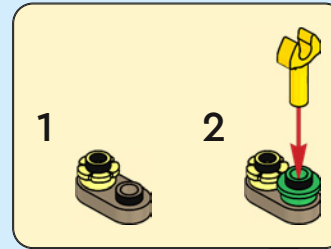

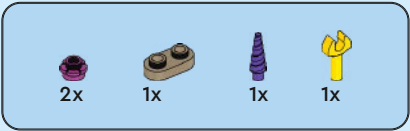

151

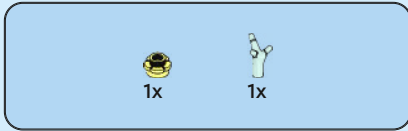
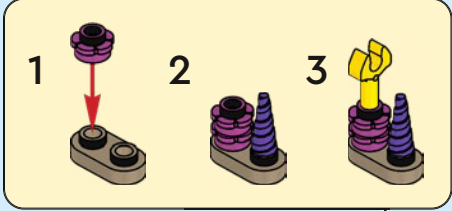

152

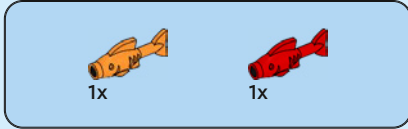
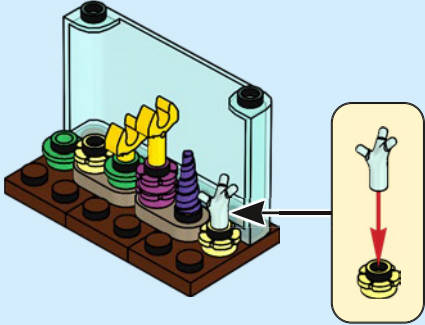

153



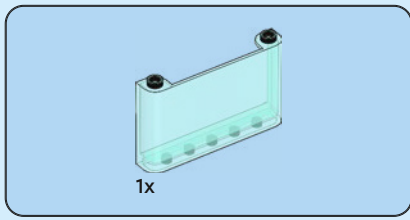

154

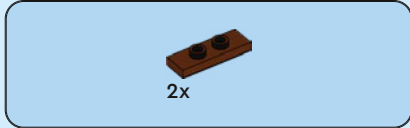
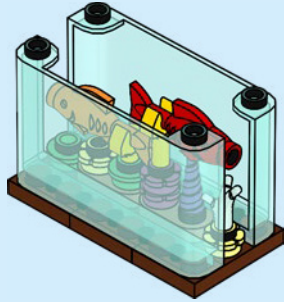

155

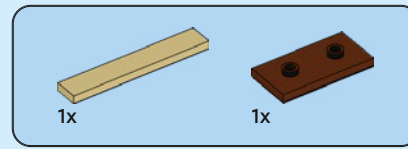

156

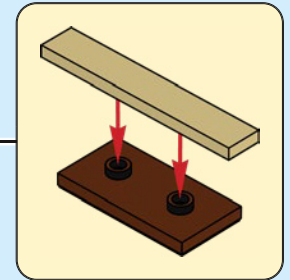

157



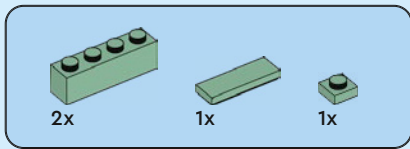

158

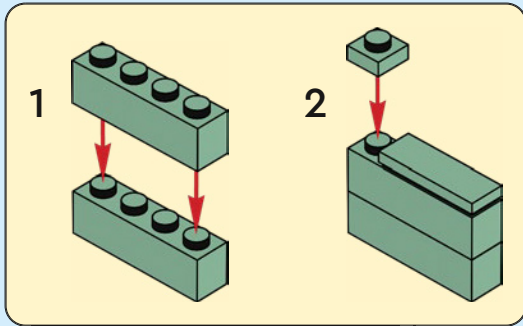

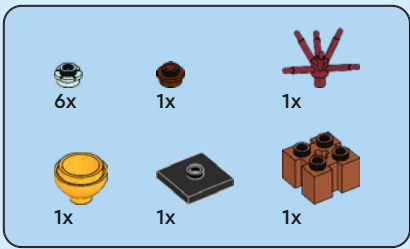

159

1

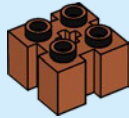

2

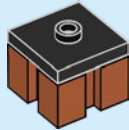

3



4

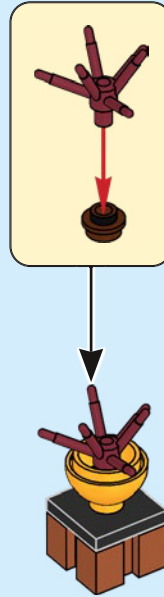

5





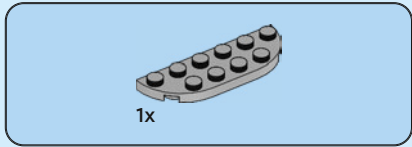

160

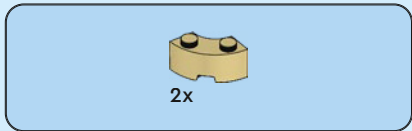
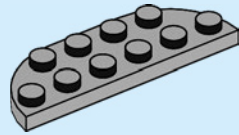

161

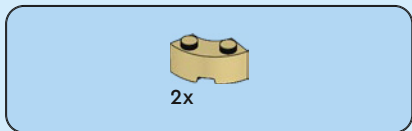
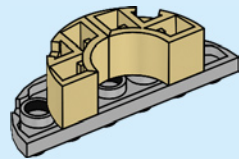

162

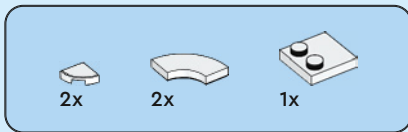
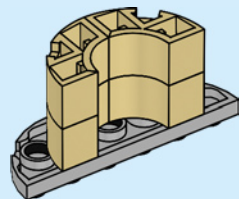

163

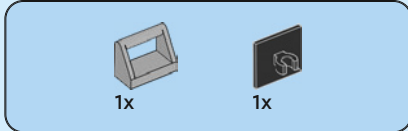
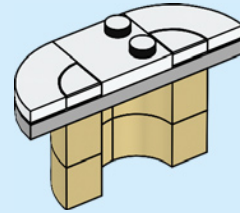

164

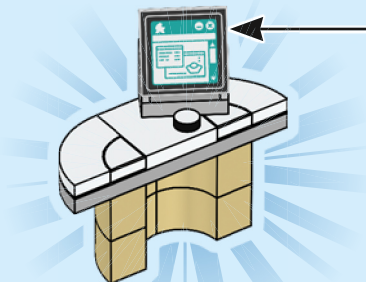
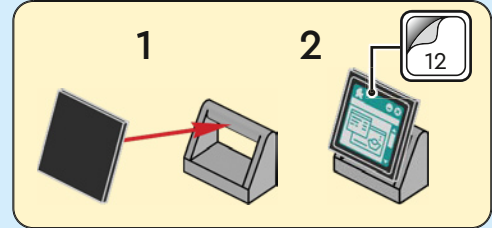

165



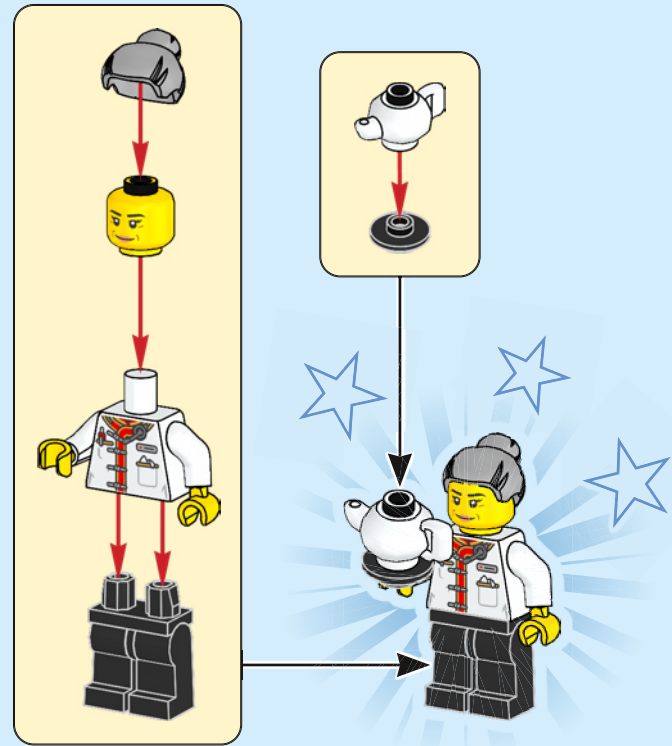

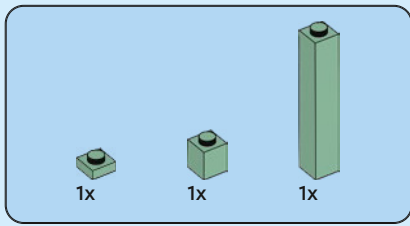

166

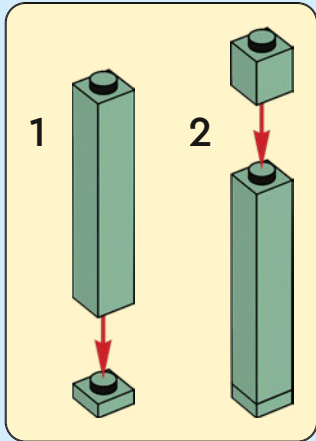

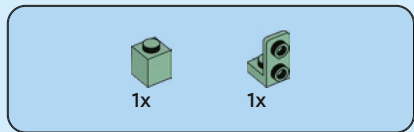
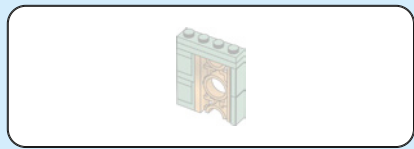

167

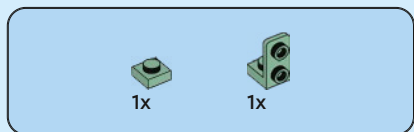
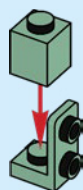

168

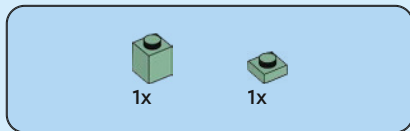
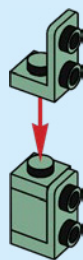

169

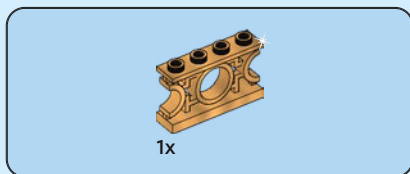

170

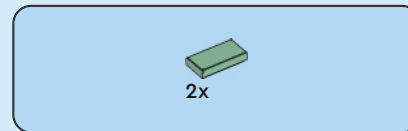
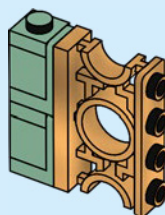

171

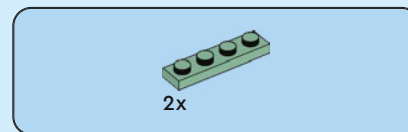
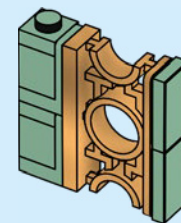

172

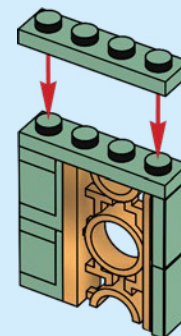



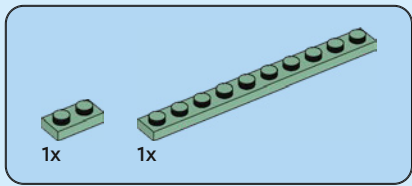

174



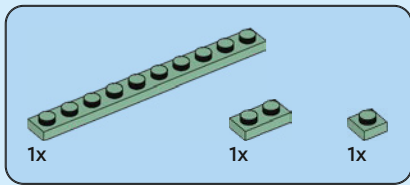

175



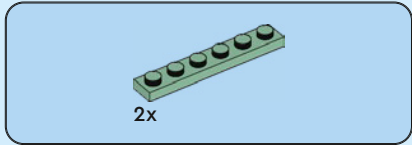

176

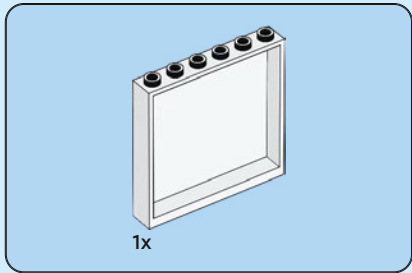
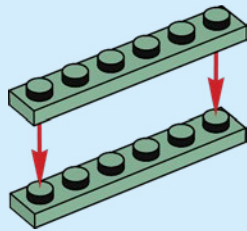

177

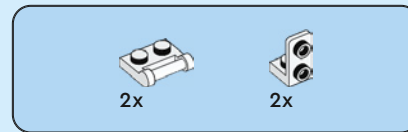
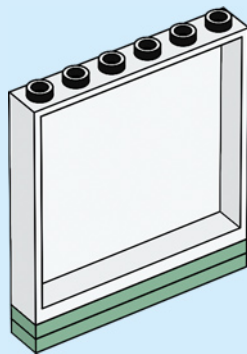

178

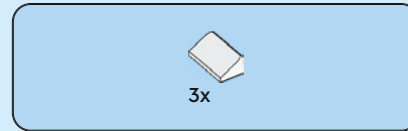
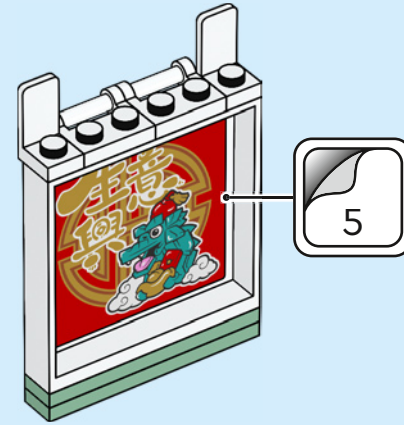

179



180



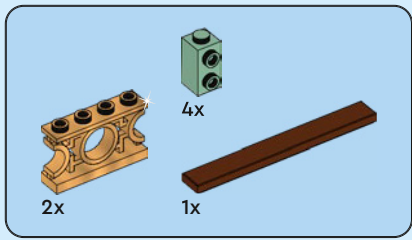

181

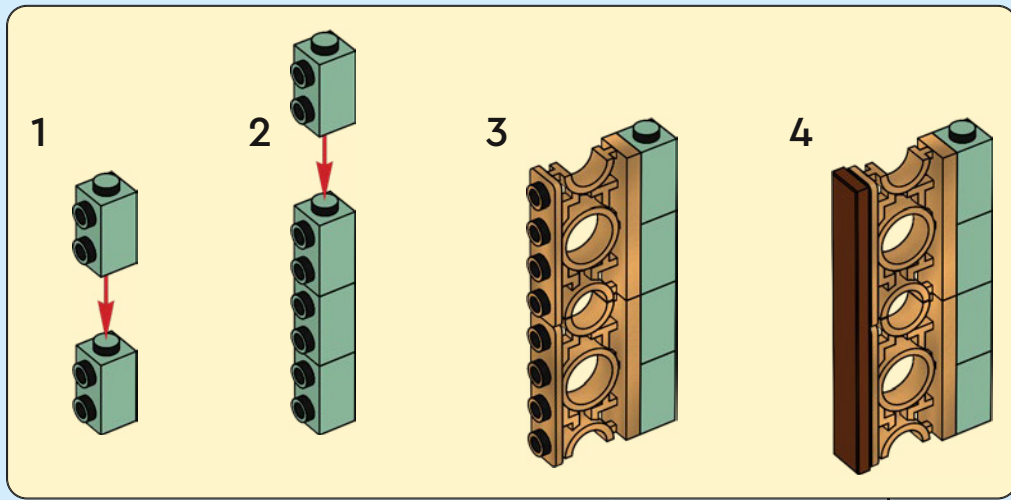

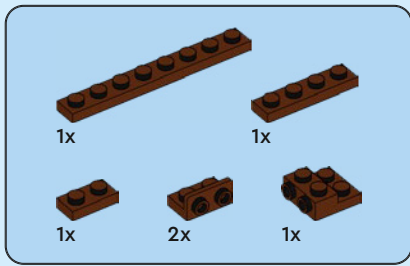

182



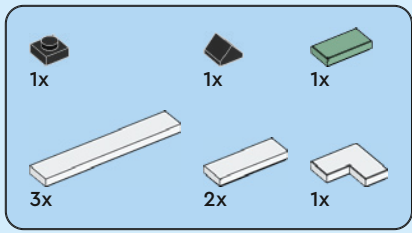

183





184

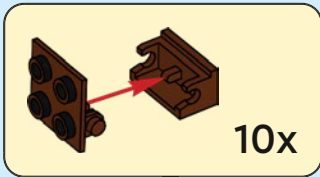

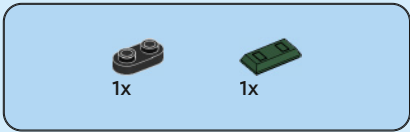

185

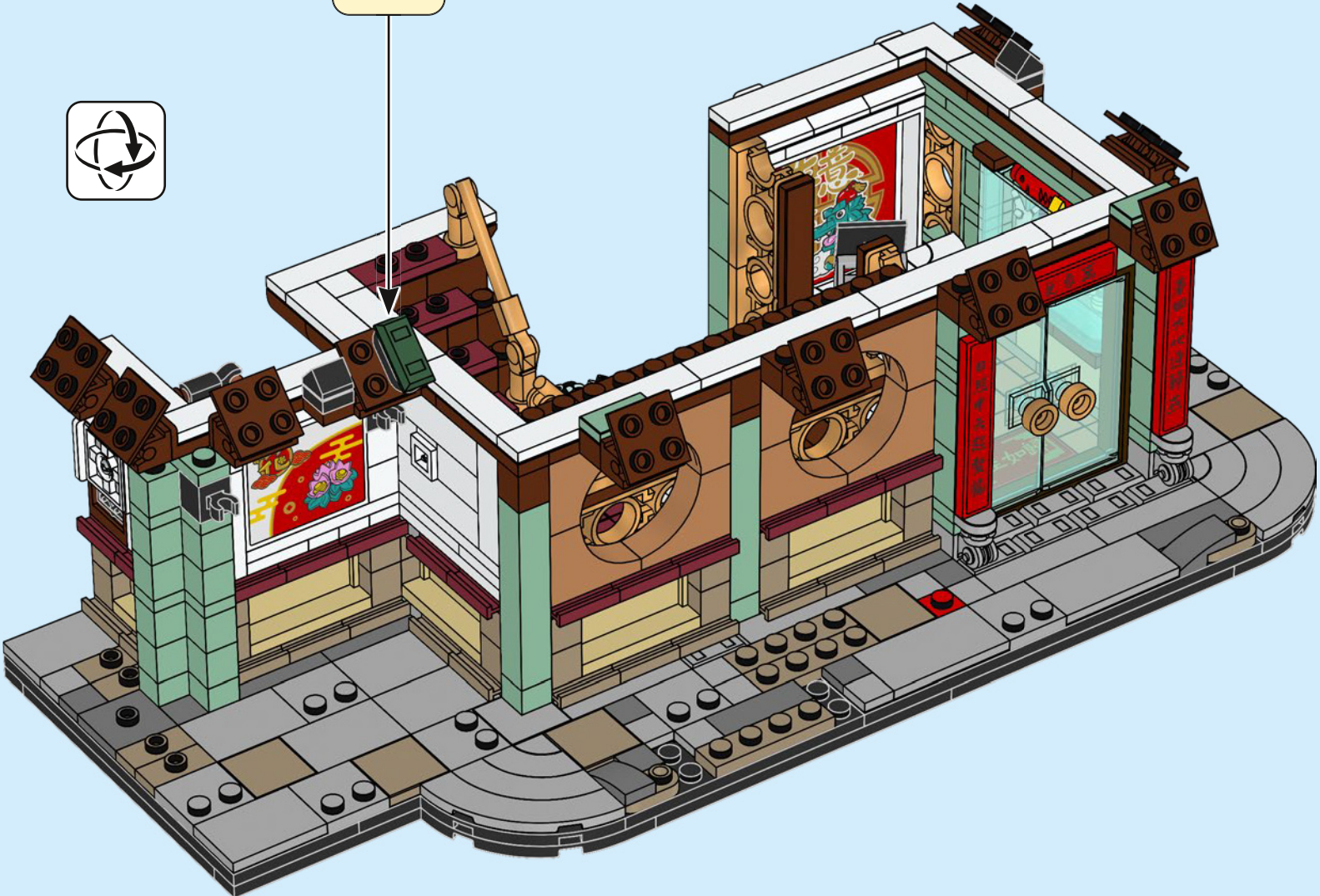
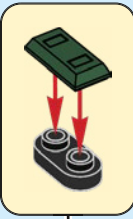

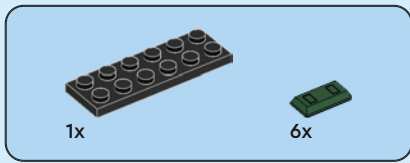

186

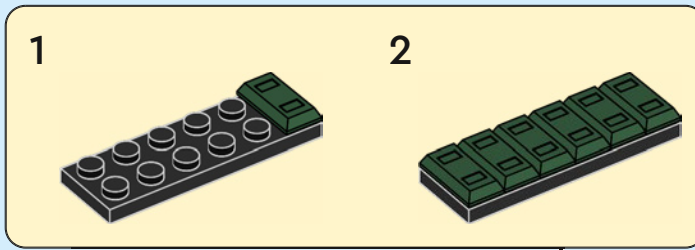

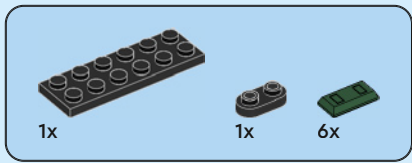

187

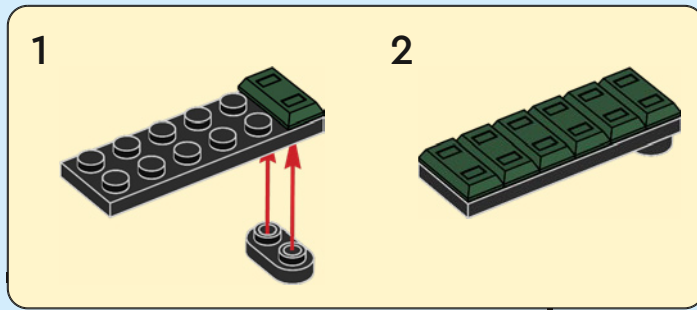

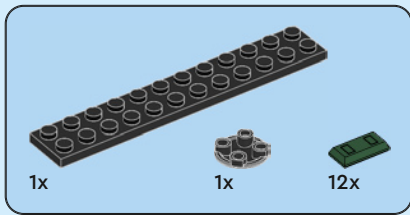

188

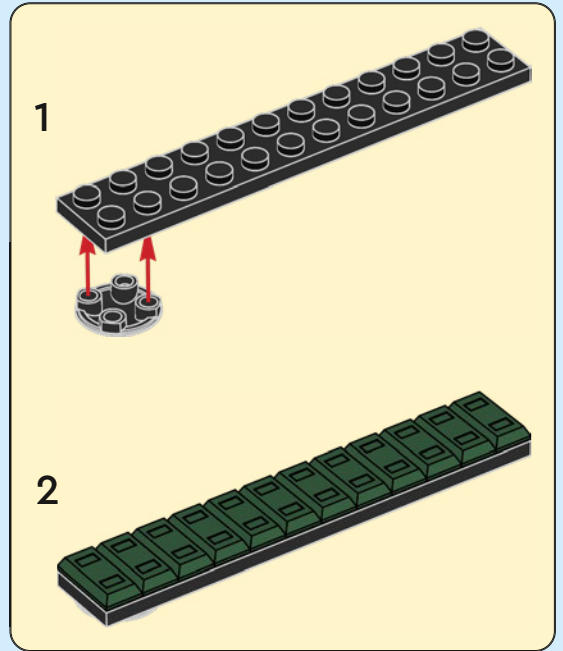
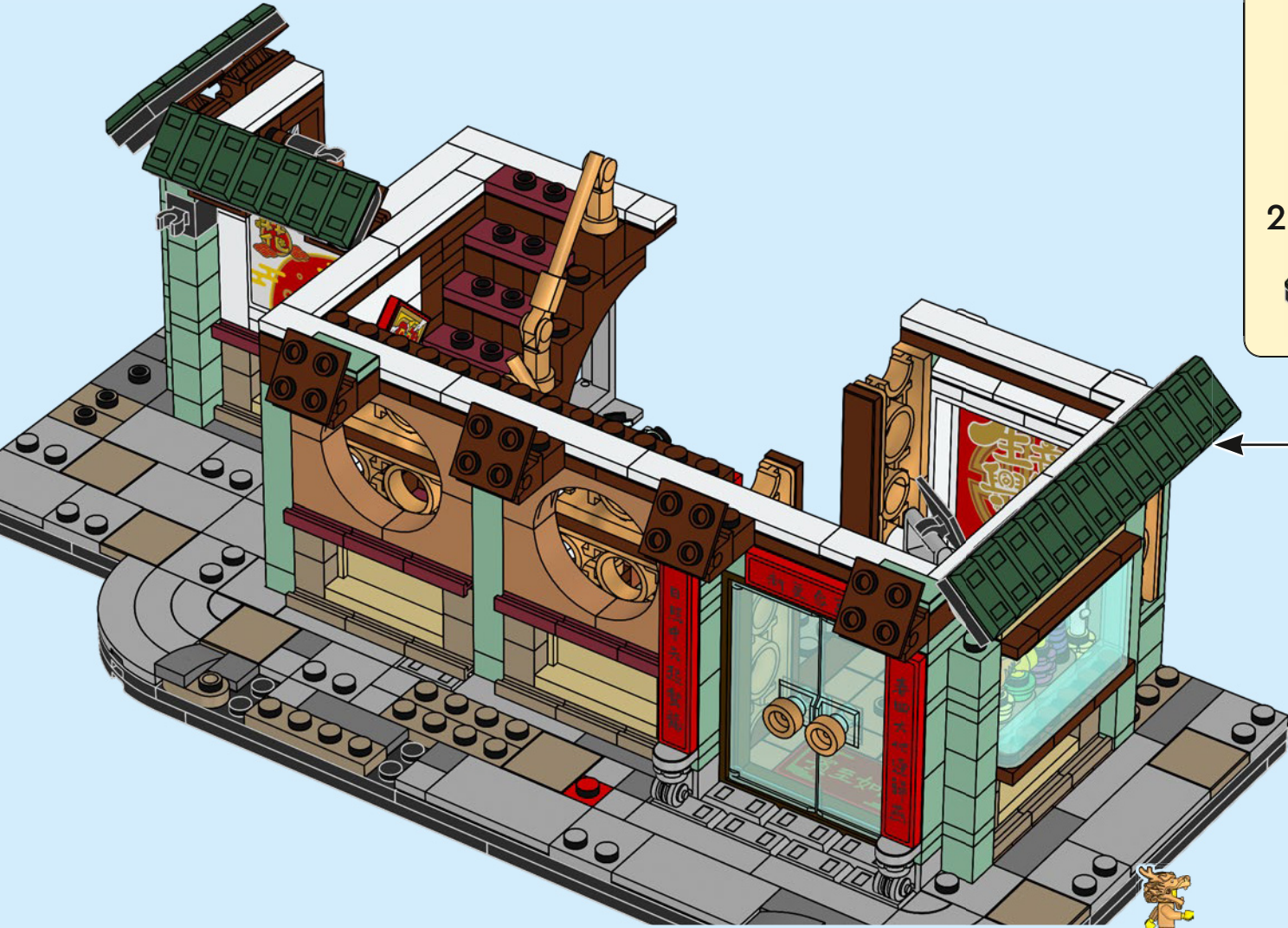

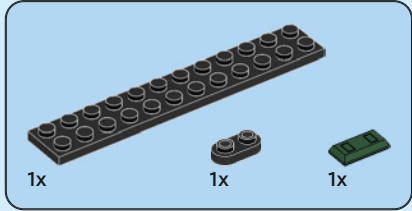
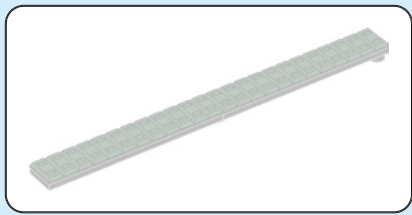

189

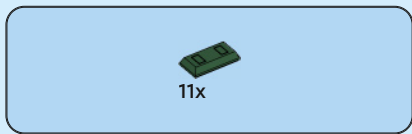
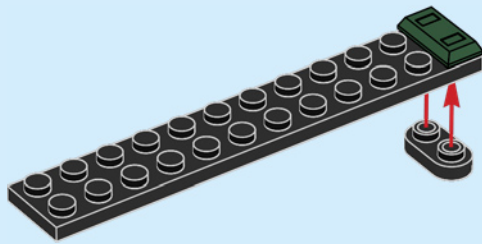

190

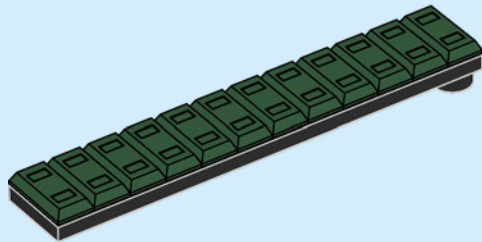

191

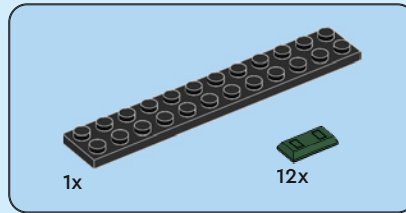
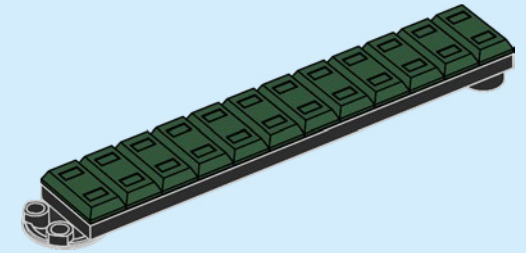

192

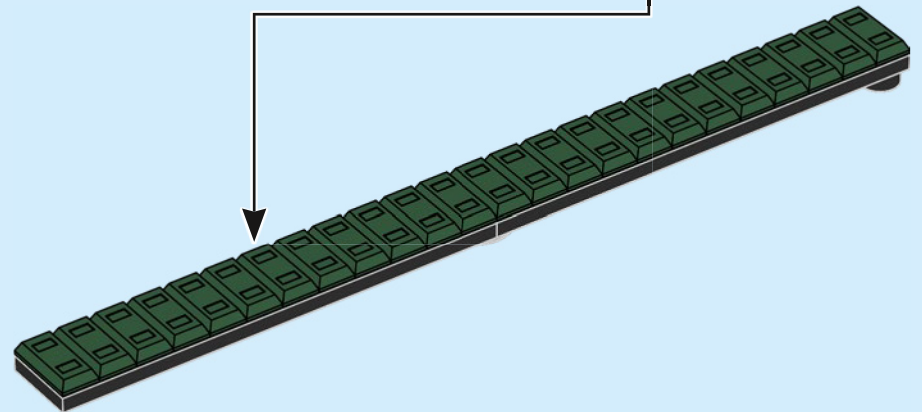
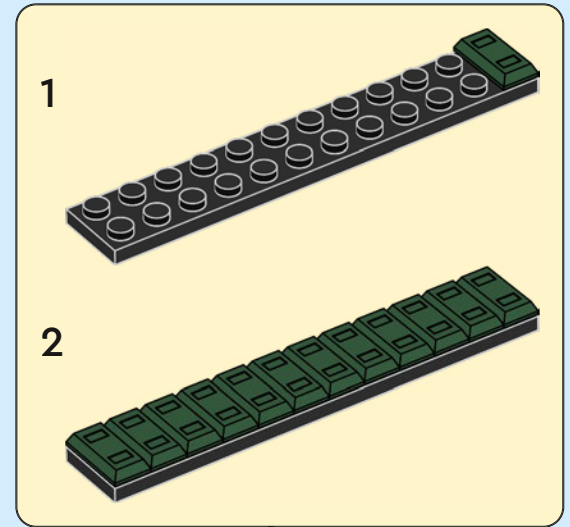

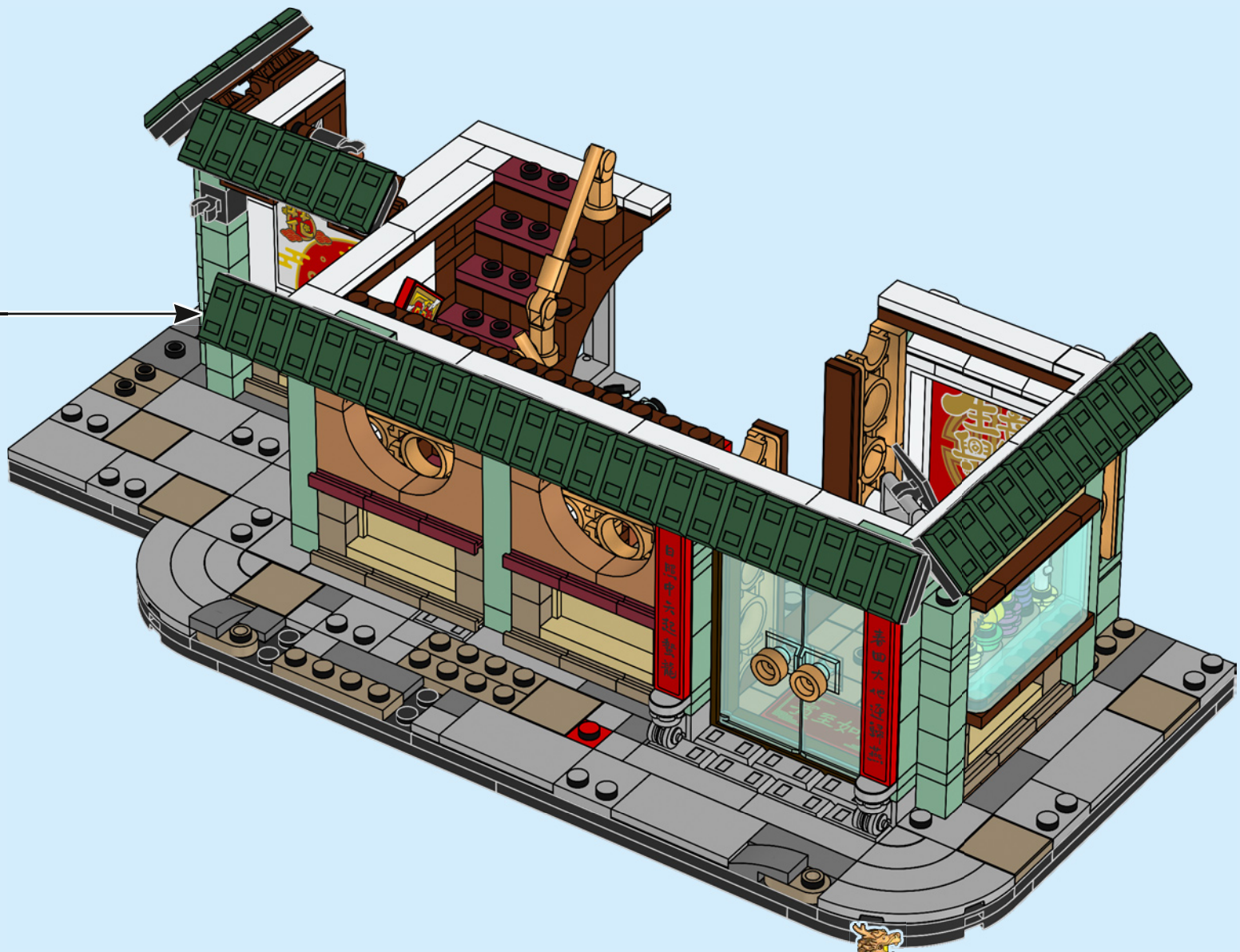

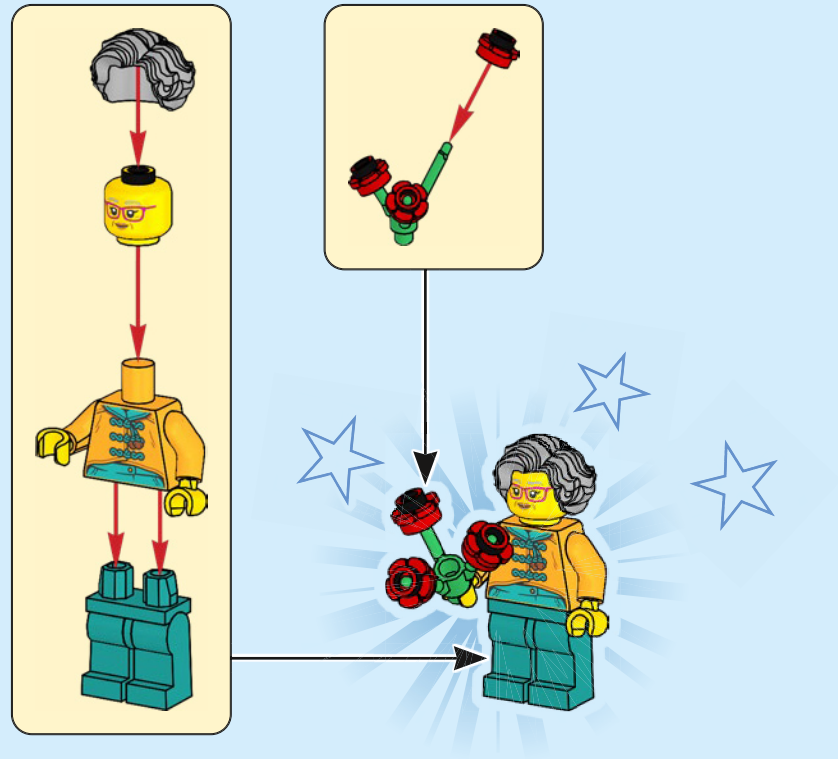

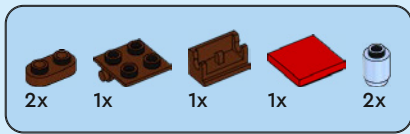

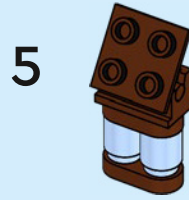

194

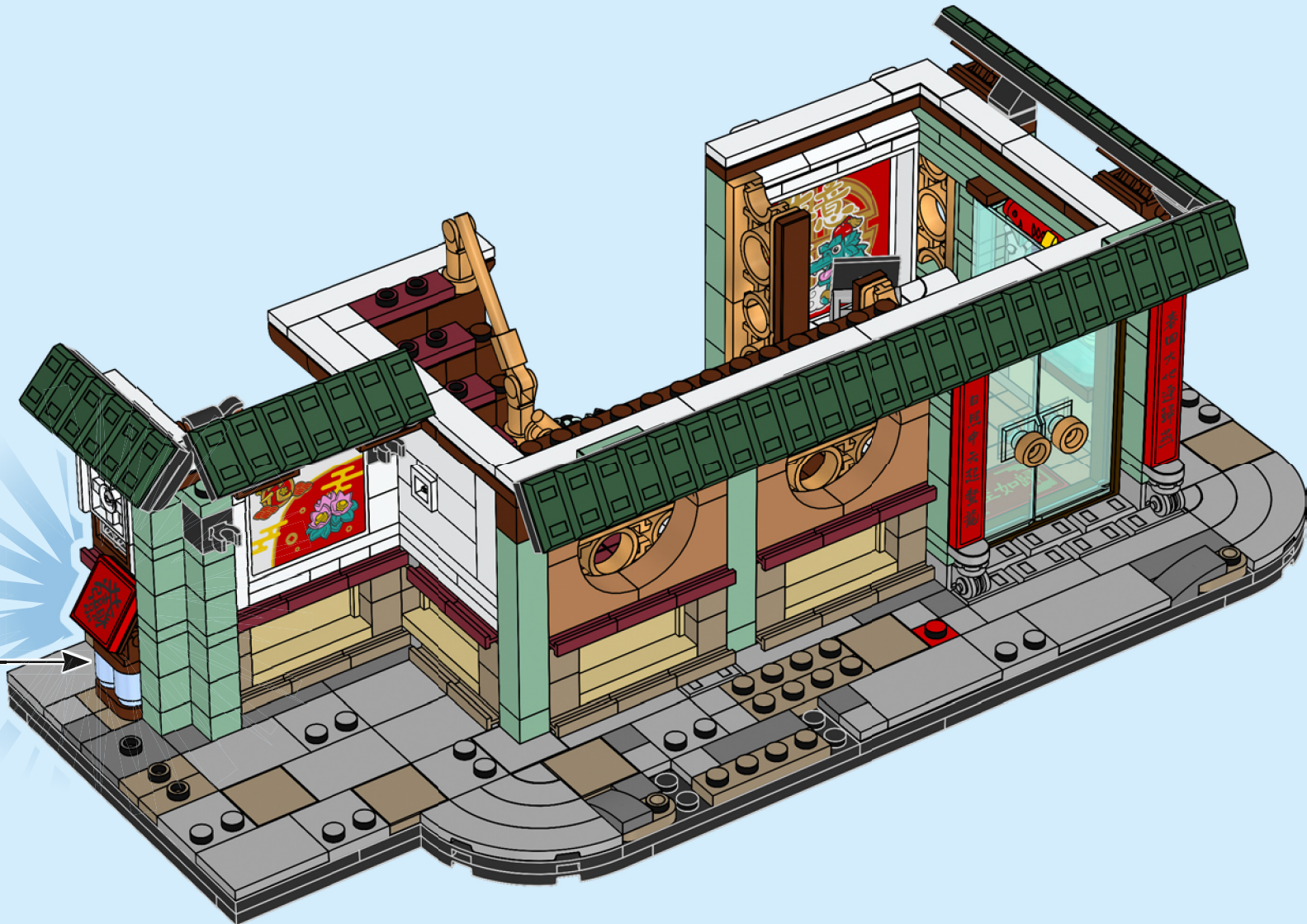



1x  1x 

195

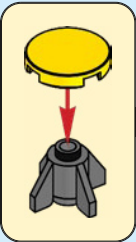
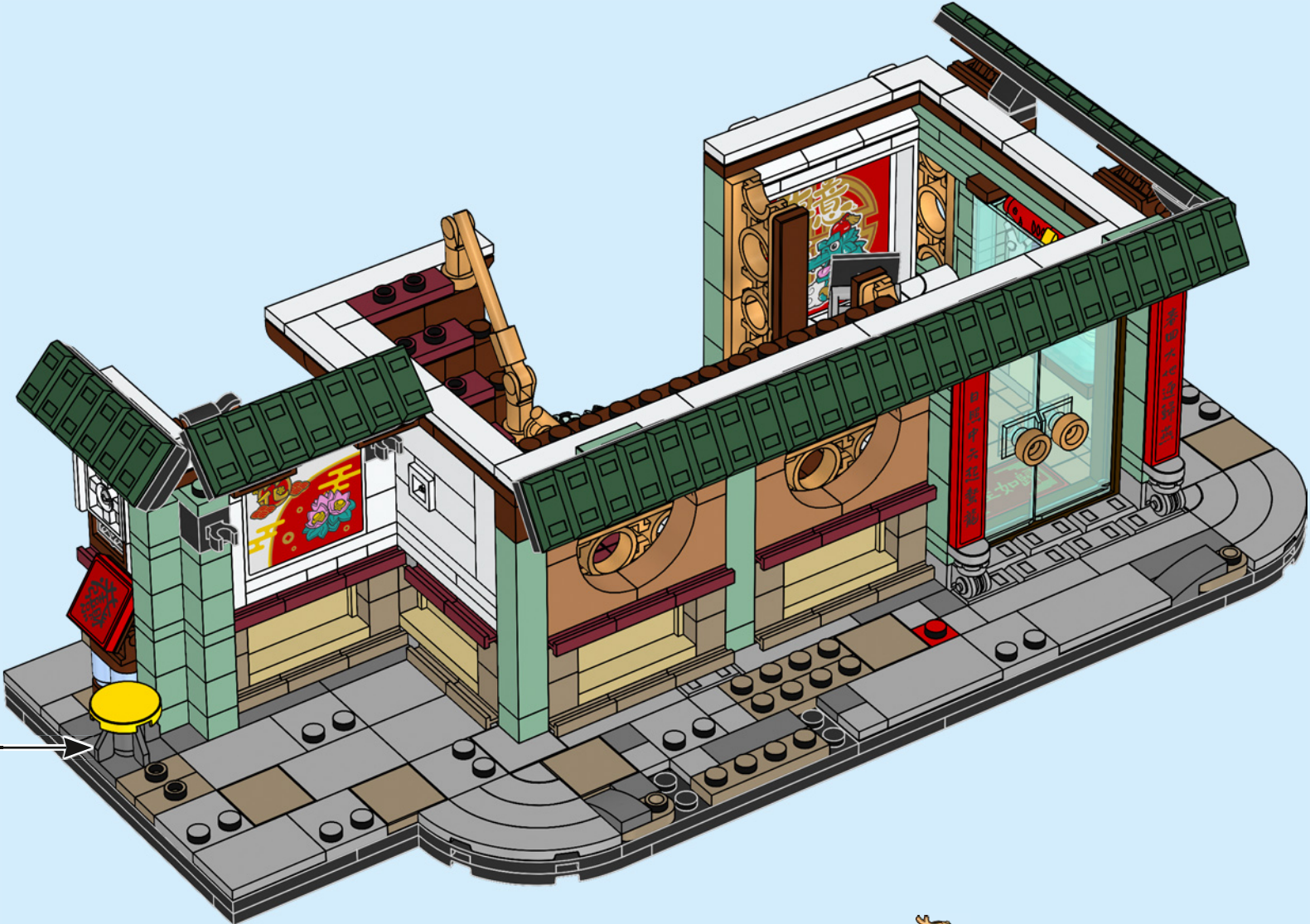

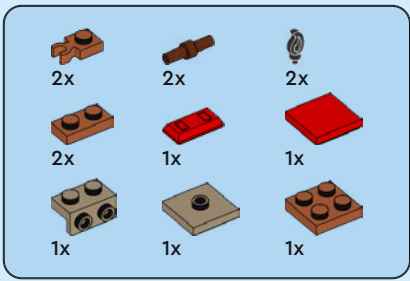

196

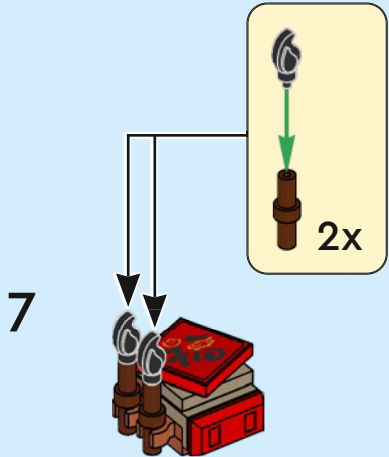
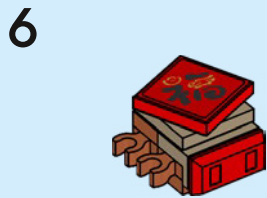
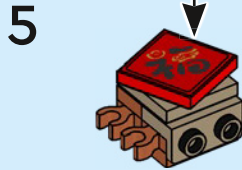
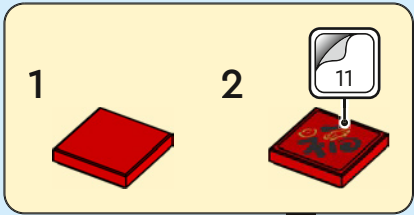
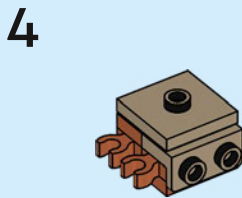
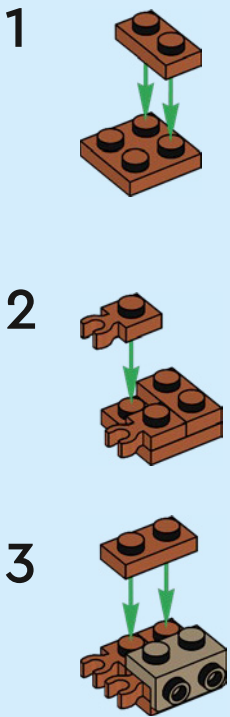



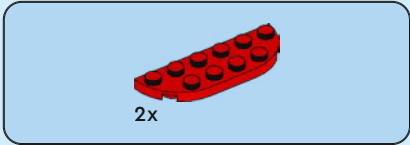
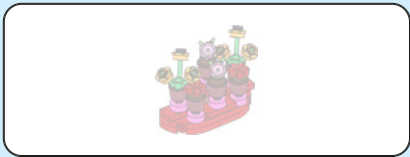

197

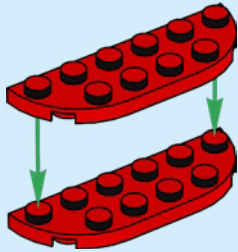

198

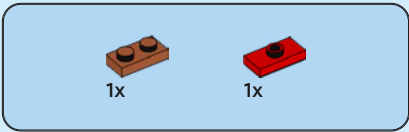
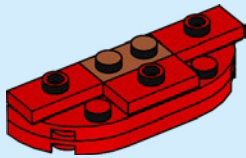

199

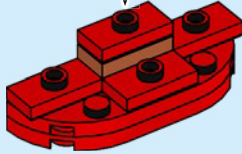
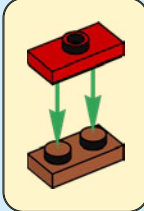

200

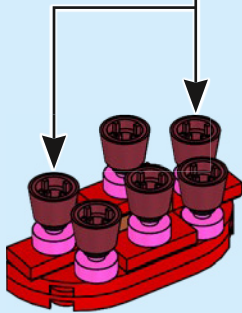
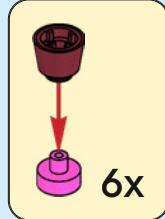



4x

201

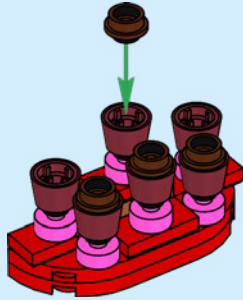

2x



2x

202

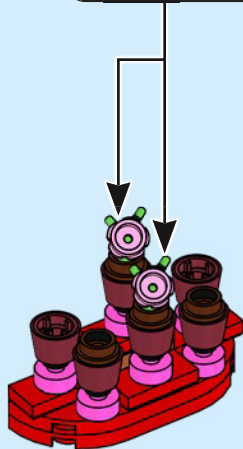
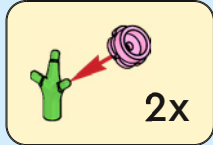

2x

203

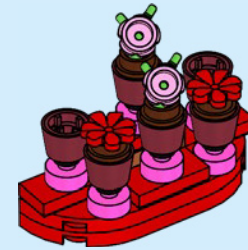

6x



2x

204

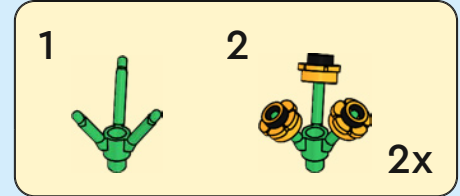

205



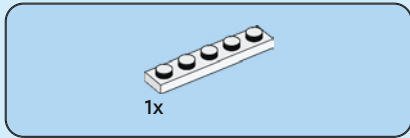
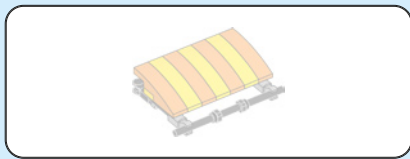

206

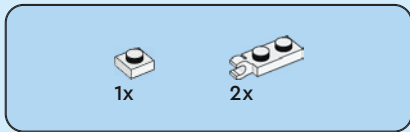
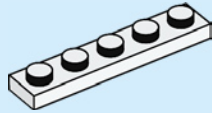

207

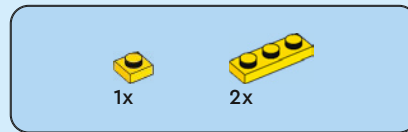
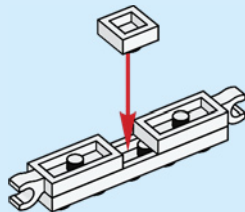

208

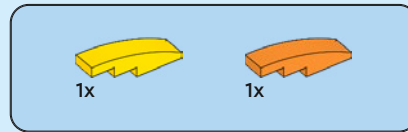
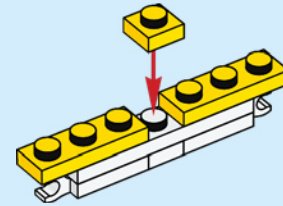

209

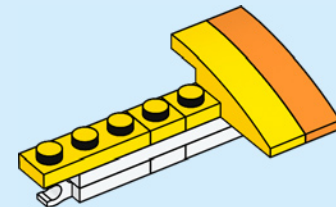

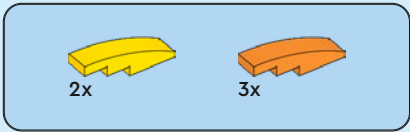

210

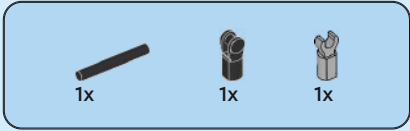
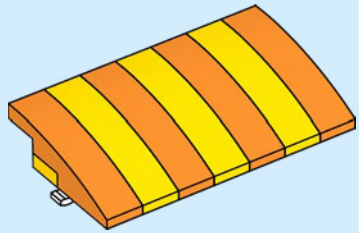

211

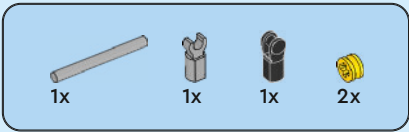
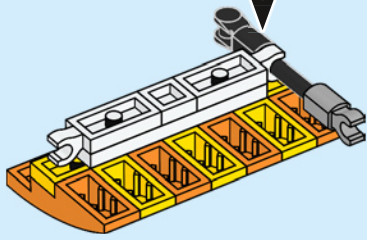
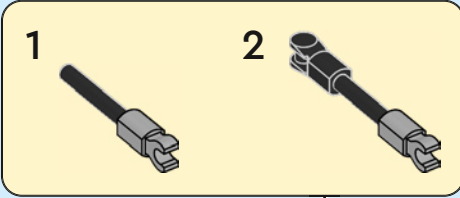

212

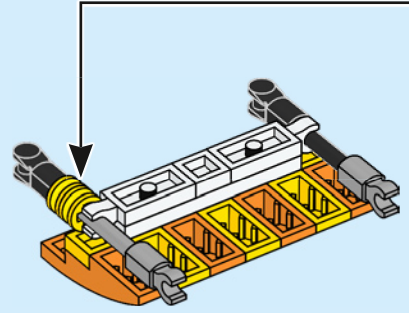
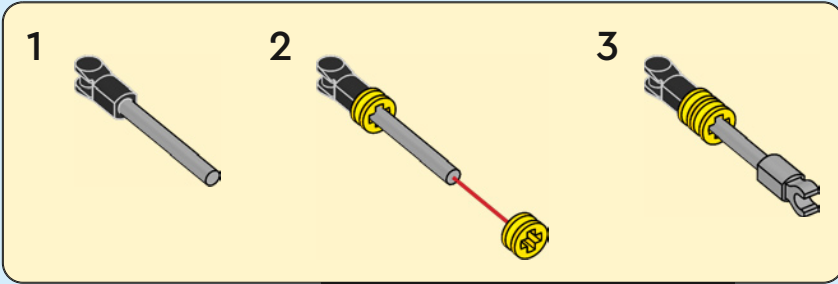
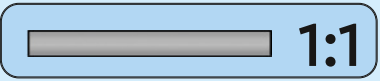

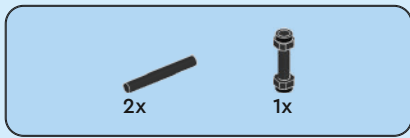

213

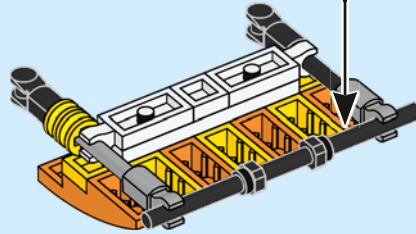
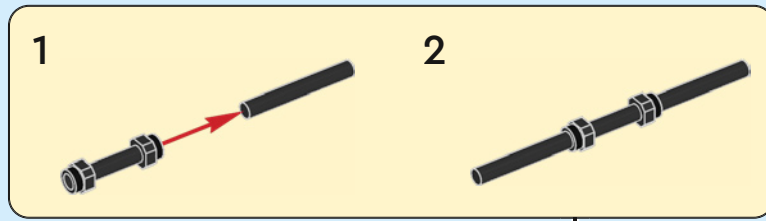

214

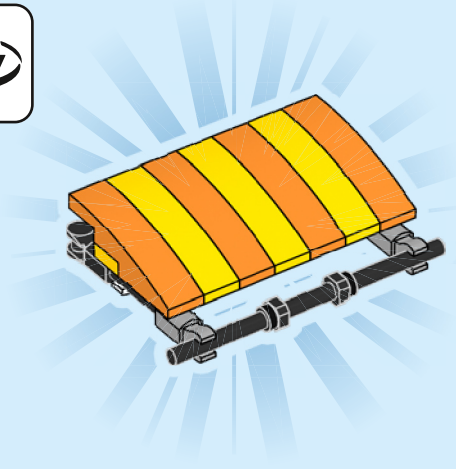

215



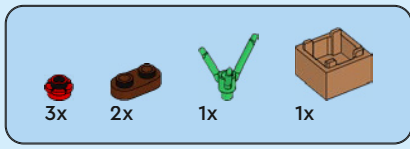

216

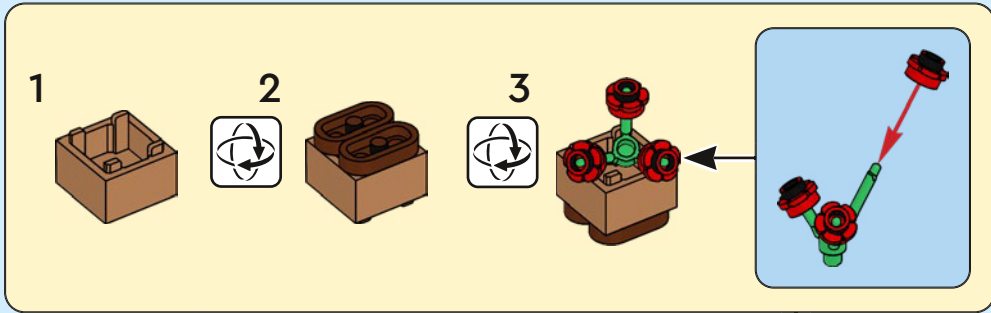

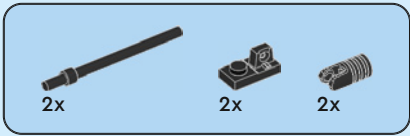

217

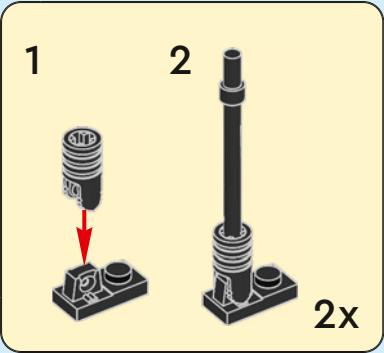

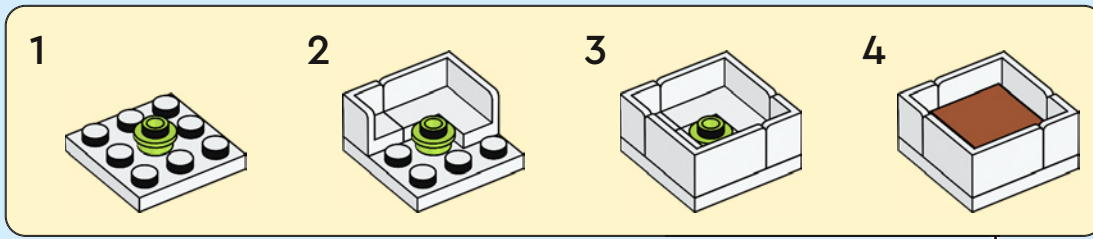
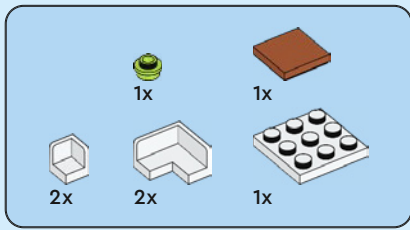

218



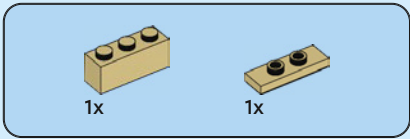

219

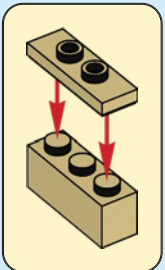

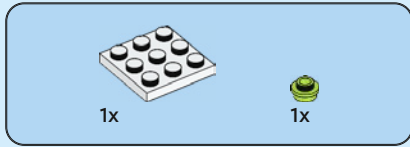

220

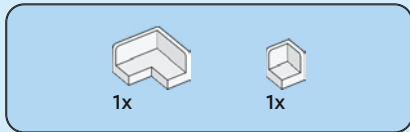

221

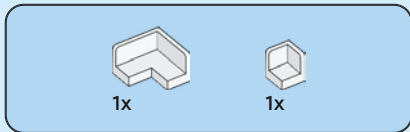
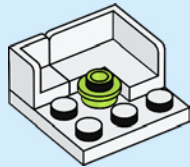

222

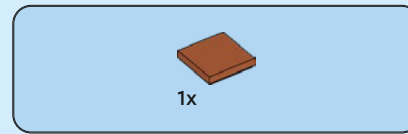
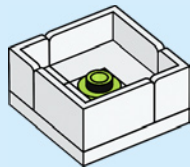

223

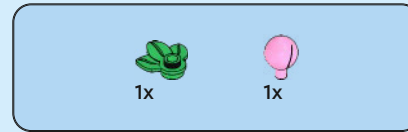
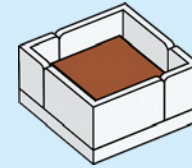

224

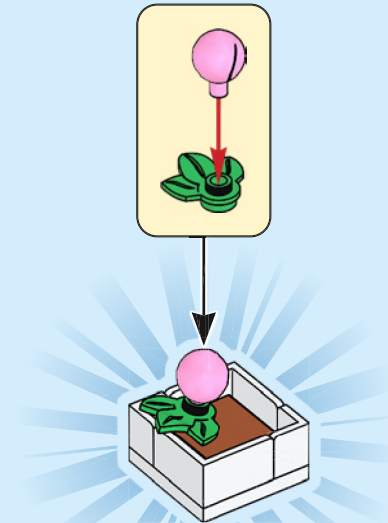

225



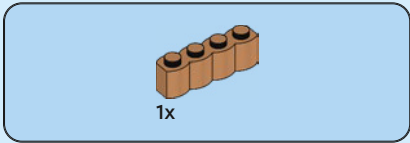

226

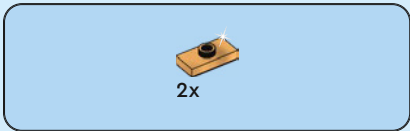
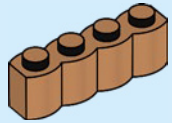

227

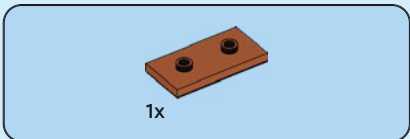
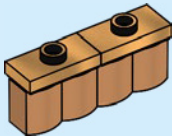

228

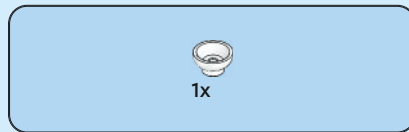
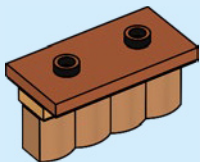

229

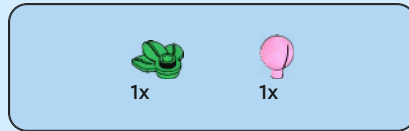

230

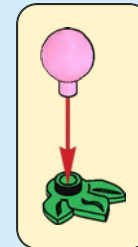

231



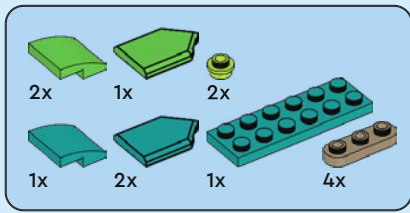

232

1

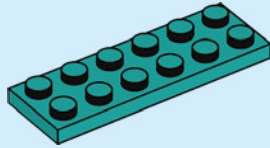

2

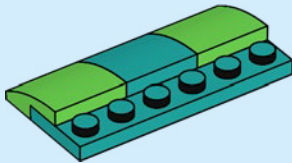

3

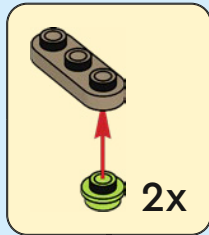
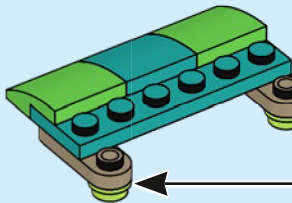

4

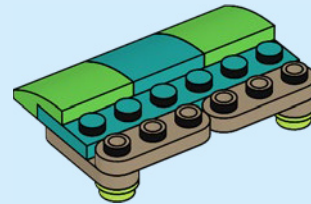

5

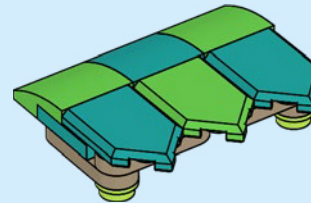



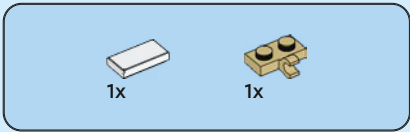

233

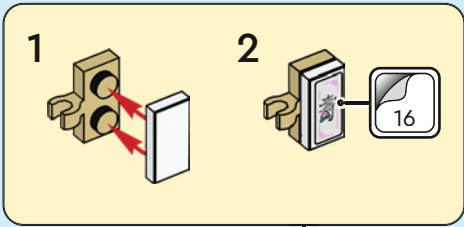

YOU COULD

WIN



Scan this QR code or go to **LEGO.COM/PRODUCTFEEDBACK** and give us your short feedback about this LEGO® set for a chance to win a cool LEGO prize.

Terms and Conditions apply*

EN: YOU COULD WIN. Terms and Conditions apply* **DE: Du könntest GEWINNEN.** Es gelten die Teilnahmebedingungen* **FR: Tu pourrais GAGNER.** Des conditions s'appliquent* **IT: Potresti VINCERE tu.** Termini e condizioni sono applicabili* **ES: Puedes GANAR.** Aplican términos y condiciones* **PT: Poderá GANHAR.** Aplicam-se termos e condições* **ZH: 轻松获奖. 条款和条件适用*** **PL: Szansa na WYGRANĄ.** Obowiązują warunki korzystania* **CS: Máte šanci VYHRÁT.** Platí všeobecné smluvní podmínky* **SK: Máte šancu VYHRAŤ.** Platia všeobecné zmluvné podmienky* **HU: TE IS NYERHETSZ.** Felhasználási feltételek érvényesek* **RO: Ai putea CÂȘTIGA.** Se aplică termenii și condițiile* **BG: Можете да СПЕЧЕЛИТЕ.** Има определени правила и условия* **LV: Tu vari LAIMĒT.** Ir spēkā noteikumi un nosacījumi.* **ET: Sul on võimalus VÕITA.** Kehtivad tingimused* **LT: Jūs galite LAIMĖTI.** Taikomos sąlygos*

*[LEGO.com/productfeedback-terms](https://www.lego.com/productfeedback-terms)