

**LEGO**

**RACERS** 

7970



1

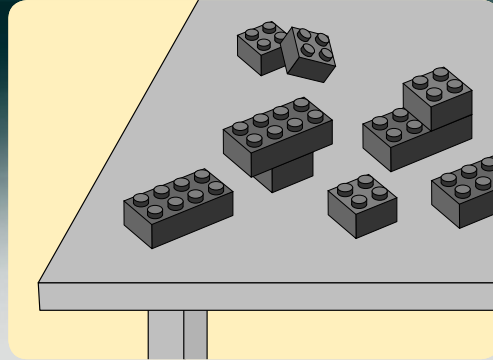
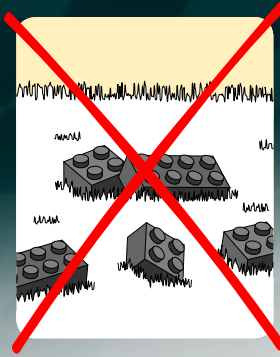

2





1

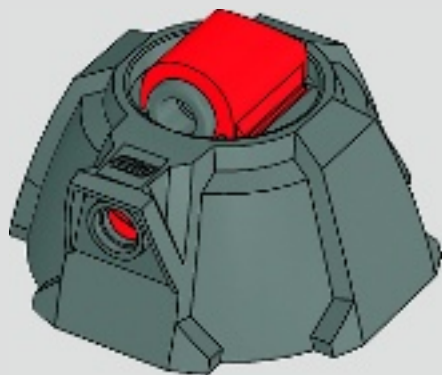

2

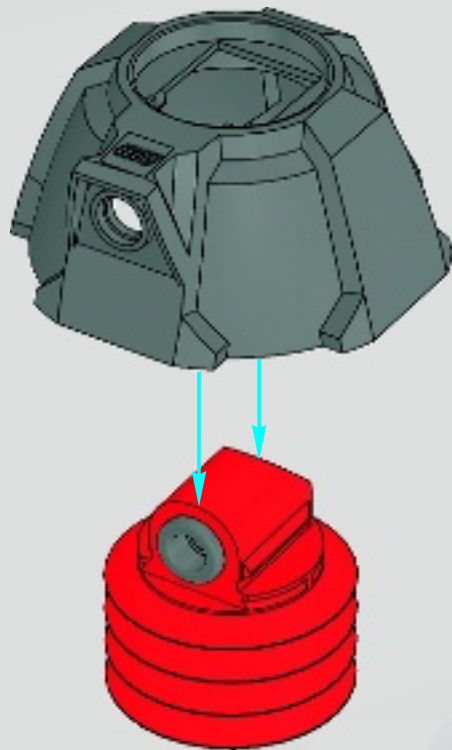

3

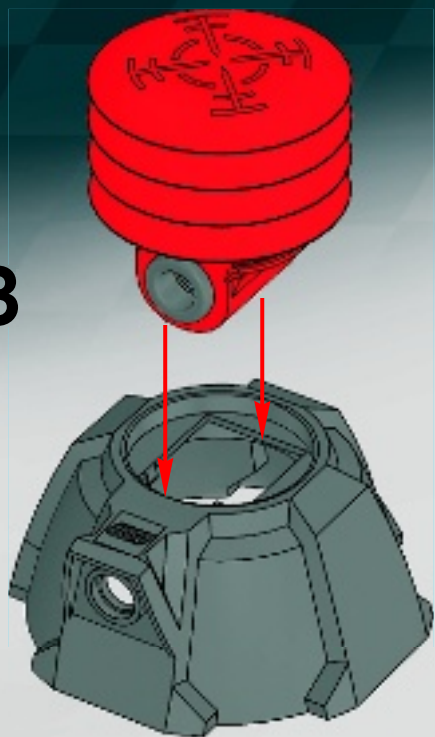

4

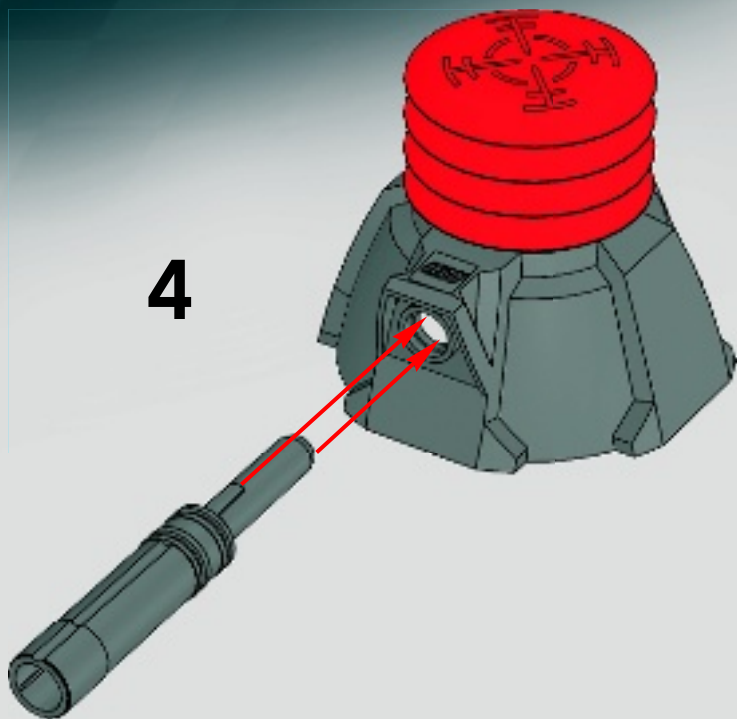



5





1



2

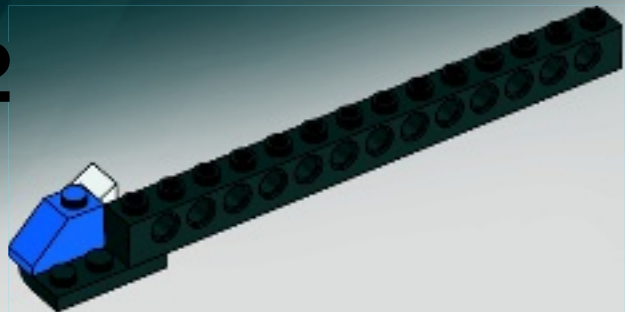

3

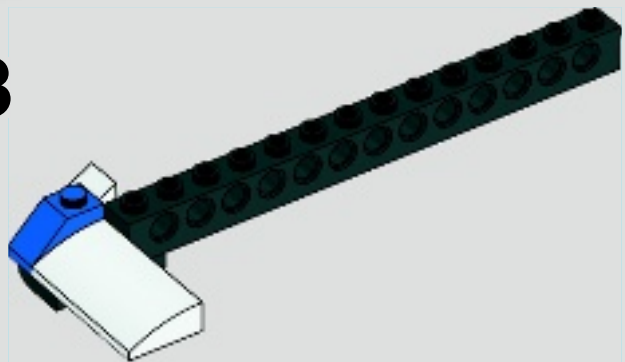



4

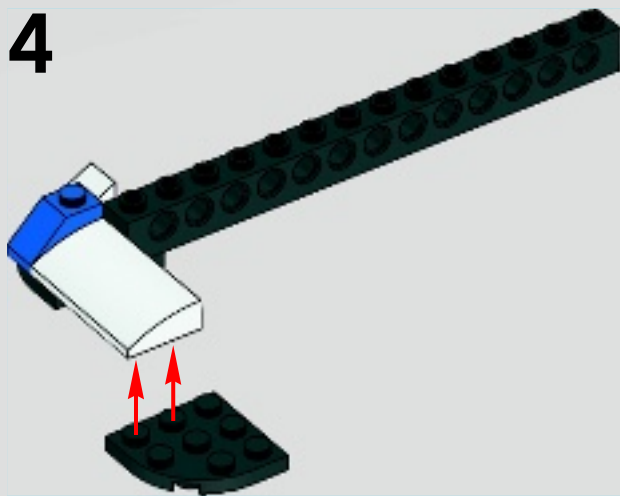

5

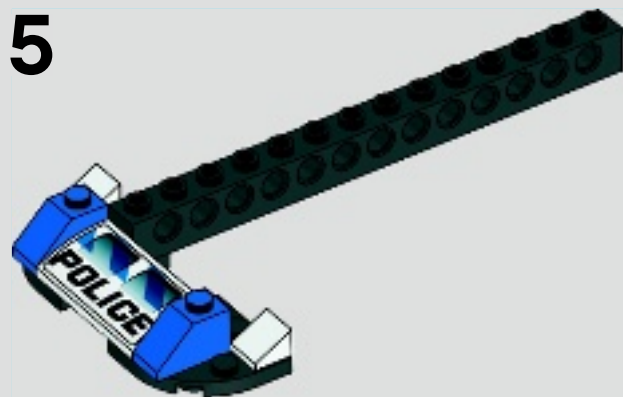

6

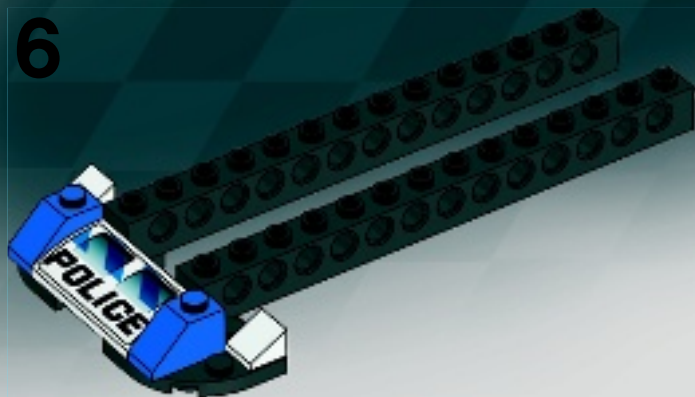

7

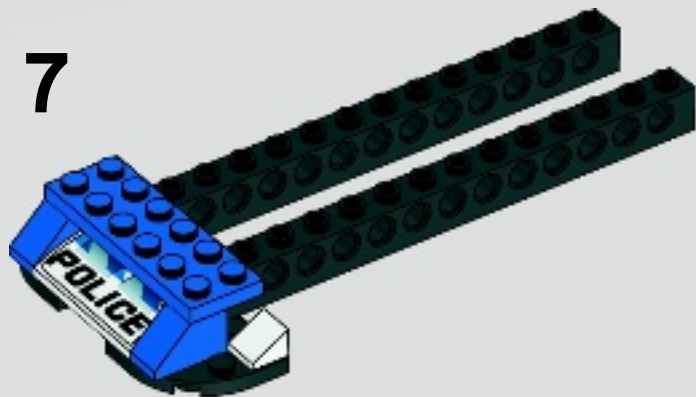

8





8

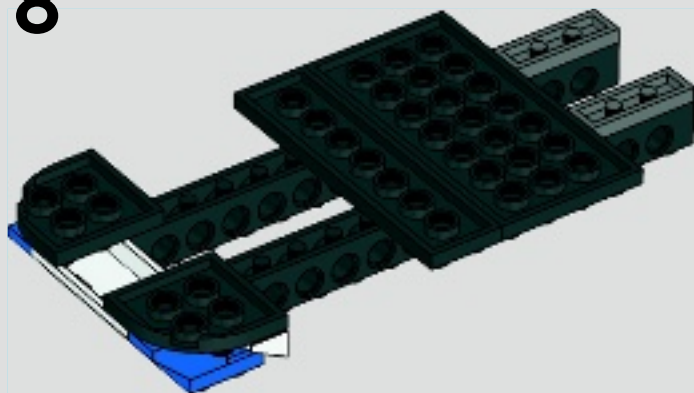



9

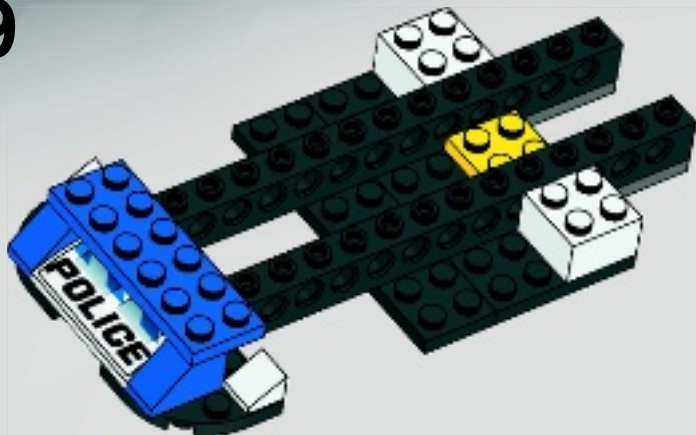

10

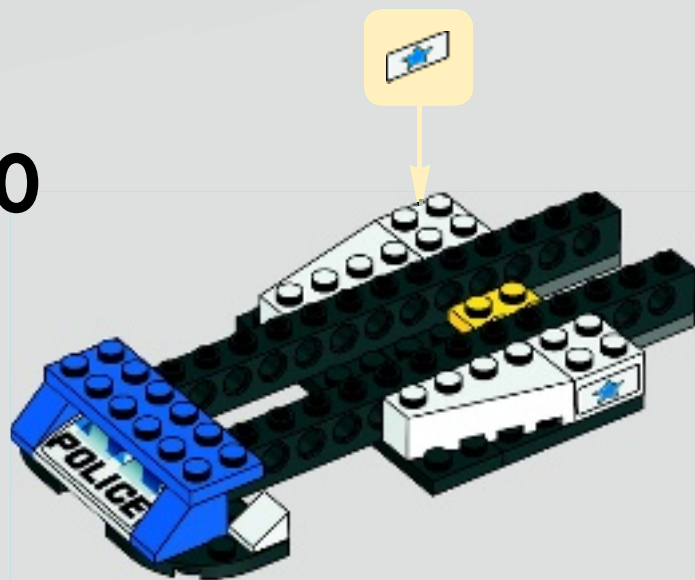

11

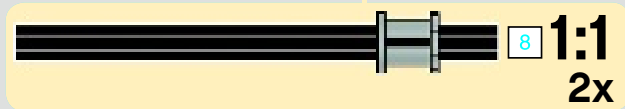
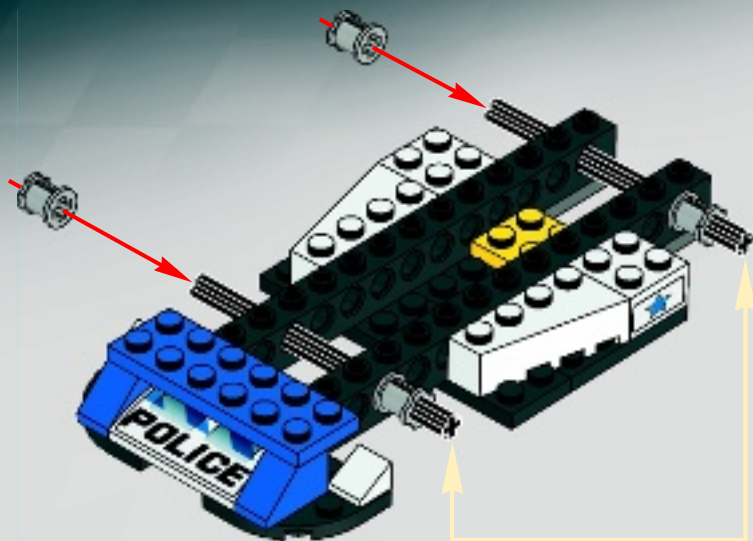

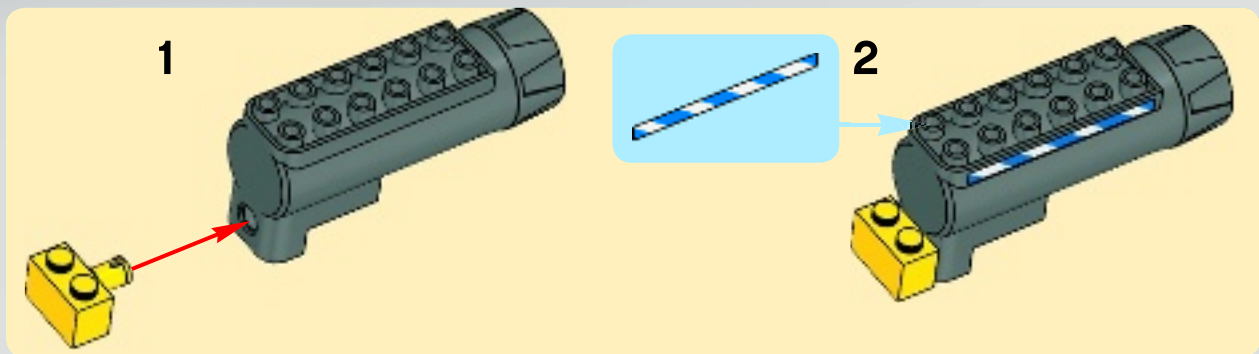

12

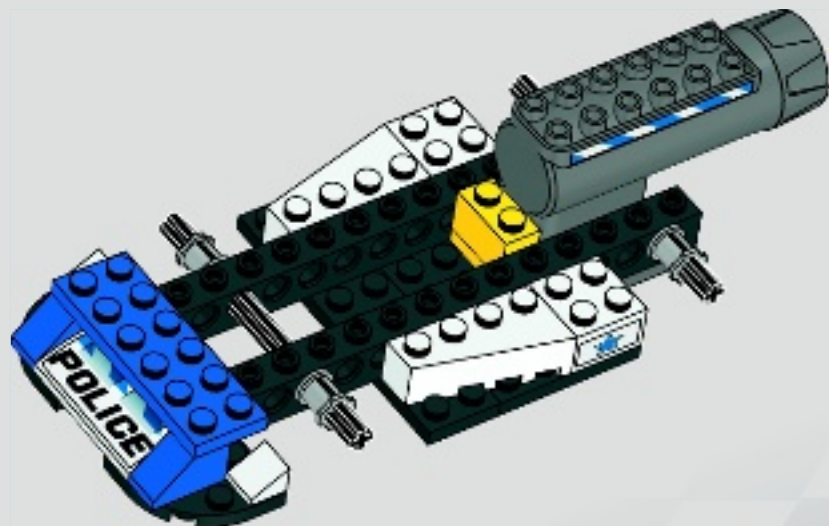

1

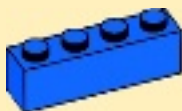

2



13

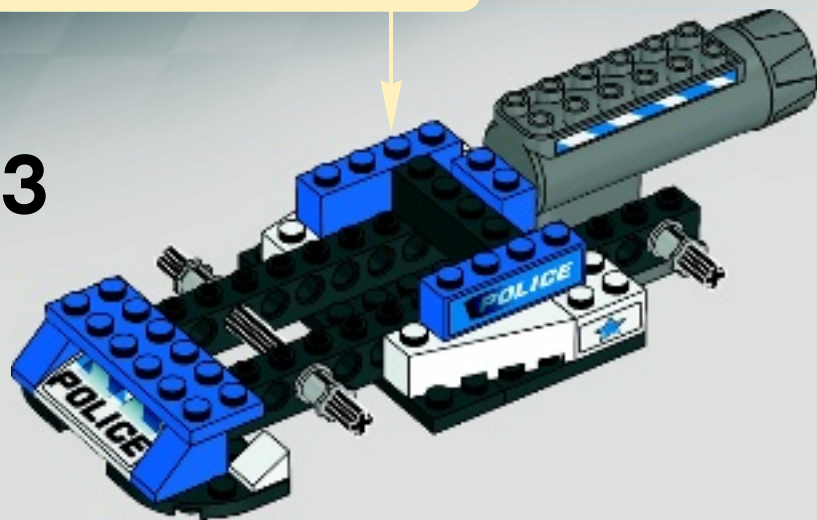



14

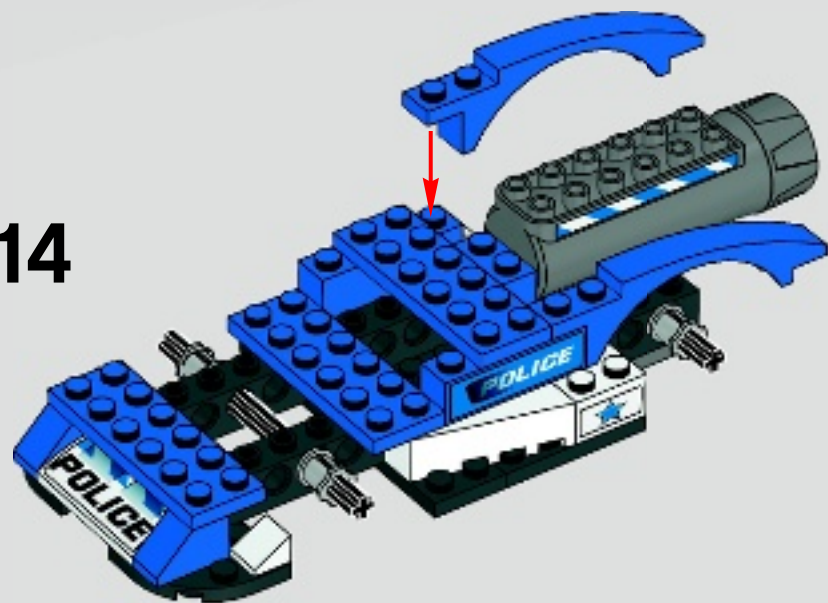

15

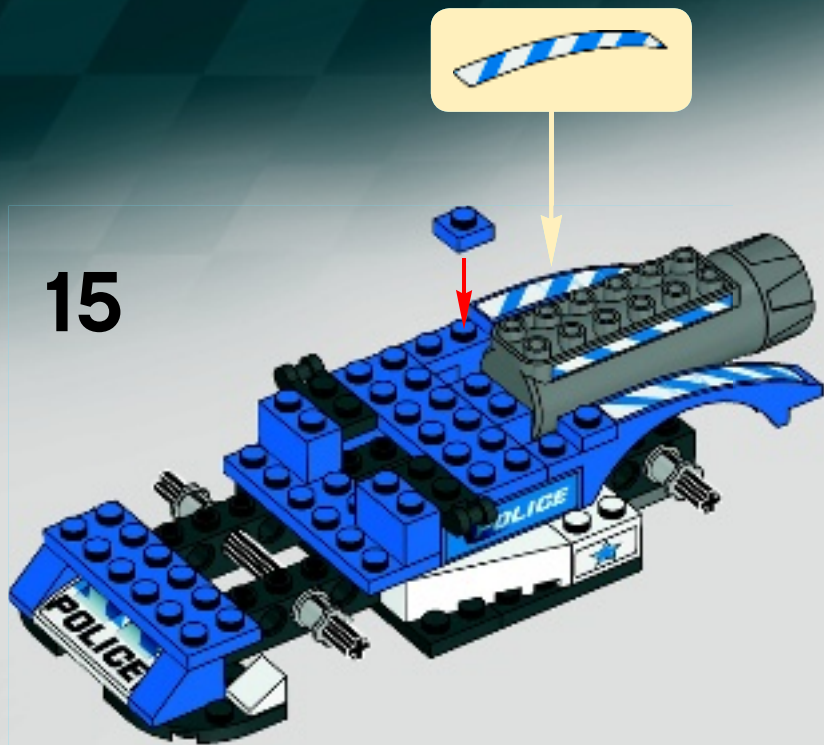

16

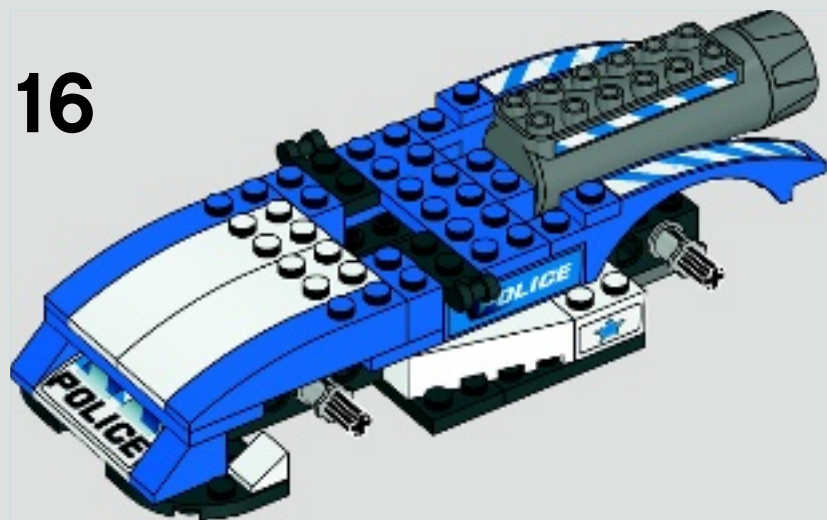

17

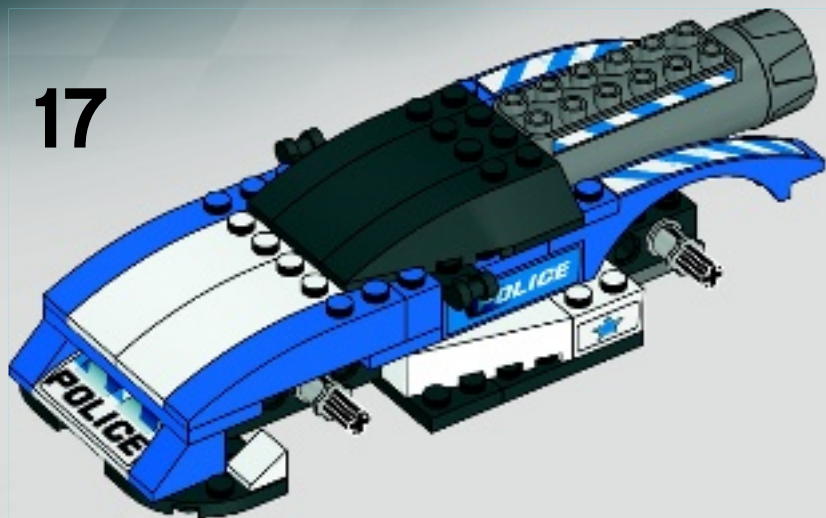

18

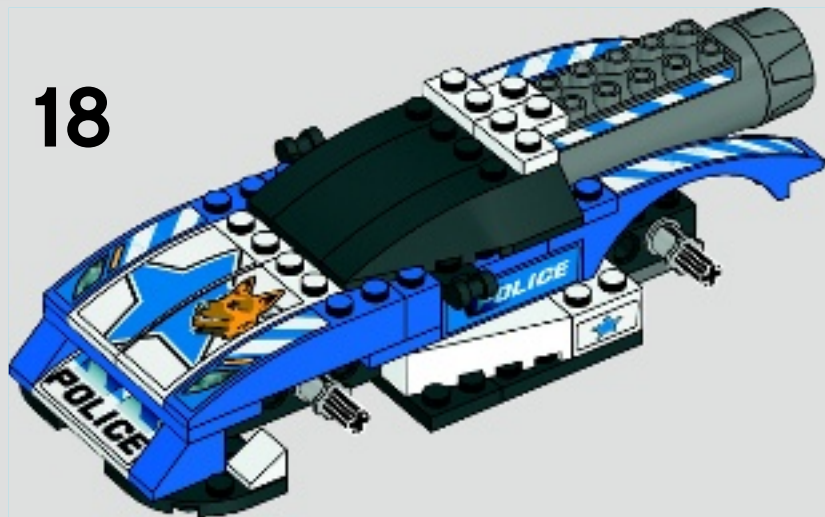

19

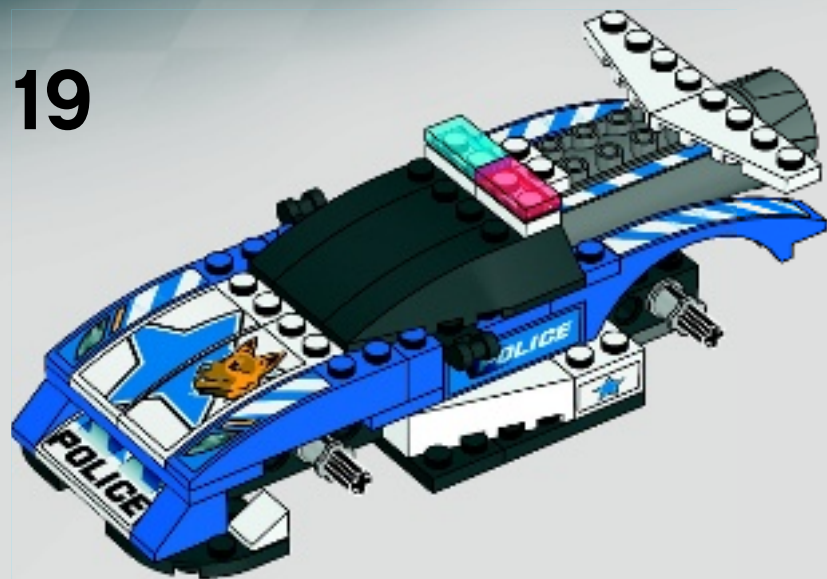



20

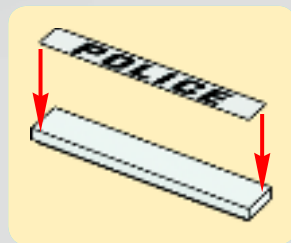
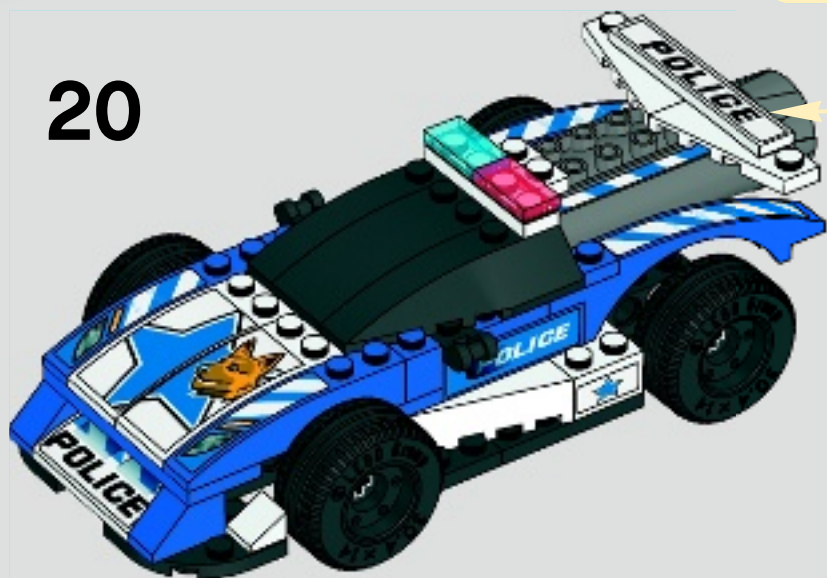

21

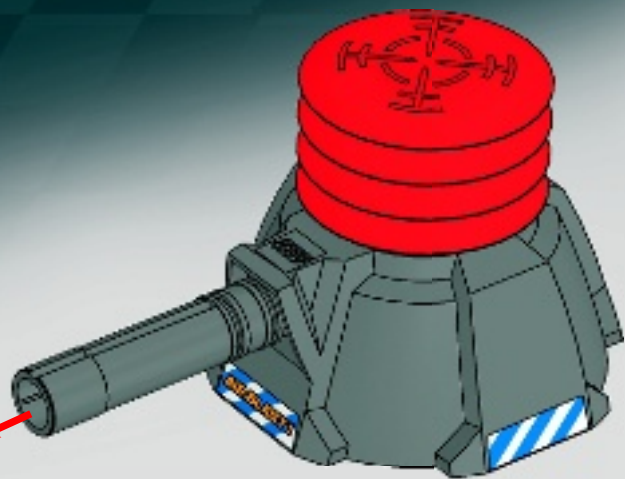
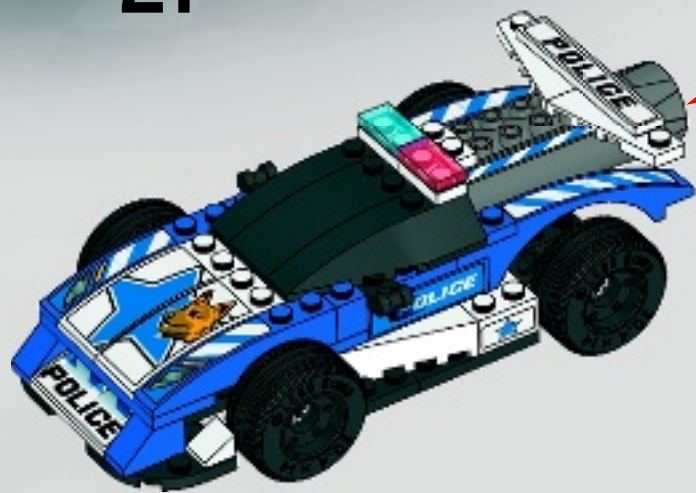



2x  
300301



1x  
4160325

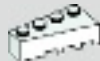

1x  
4160343



2x  
4504369



2x  
4179870



2x  
242001



1x  
663601



1x  
4161326



1x  
4160857



1x  
4583297



1x  
4568690



3x  
300423



2x  
301023



2x  
4121936

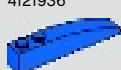

2x  
4160391



2x  
4569286



2x  
302423



3x  
379523



1x  
302224



1x  
245824



1x  
301026



2x  
4107558



1x  
4180548



1x  
4160108



1x  
4160130



1x  
303426



1x  
303526



2x  
4515368



2x  
4227392



4x  
4517737



4x  
4550937



2x  
370726



1x  
4189801



1x  
4113854



4x  
4211622



2x  
4211133



1x  
4563226



1x  
4568692



1x  
4563215

8



Customer Service  
Kundenservice  
Service Consommateurs  
Servicio Al Consumidor

[www.lego.com/service](http://www.lego.com/service) or dial



: 00800 5346 5555

: 1-800-422-5346



# WIN!

Go to [www.nielsen.com/LEGO](http://www.nielsen.com/LEGO)  
to fill out a survey for a chance  
to win a cool LEGO® Product.

No purchase necessary.

Open to all residents where not prohibited.



[www.LEGO.com](http://www.LEGO.com)

## [www.nielsen.com/LEGO](http://www.nielsen.com/LEGO)

### GEWINNE!

Nimm an der Umfrage auf  
[www.nielsen.com/LEGO](http://www.nielsen.com/LEGO)  
teil und hab die Chance ein cooles  
LEGO® Produkt zu gewinnen!

Die Teilnahme am Gewinnspiel führt zu keinerlei  
Kaufverpflichtungen. Teilnahme in allen nicht  
ausgeschlossenen Ländern möglich.

### WIN!

Ga naar [www.nielsen.com/LEGO](http://www.nielsen.com/LEGO),  
vul een enquêteformulier in en  
maak kans op een  
cool LEGO® product.

Geen aankoopverplichting.  
Iedereen mag deelnemen, uitgezonderd  
ingezetenden  
van landen waar een enquêteverbod geldt.

### GAGNE!

Visite [www.nielsen.com/LEGO](http://www.nielsen.com/LEGO)  
pour répondre à un questionnaire  
et avoir une chance de gagner  
un produit LEGO® très cool!

Aucune obligation d'achat.  
Ouvert à tous les résidents des pays  
autorisés.

### 当てよう!

[www.nielsen.com/LEGO](http://www.nielsen.com/LEGO)  
にアクセスして、  
アンケートにご記入ください。  
当選者にはレゴ®製品を  
差し上げます。

お買い上げの必要はありません。  
禁止されていない限り、すべての皆様にご利用いただけます。