



SONIC™

THE HEDGEHOG

76990





Get excited about our new packaging!

We're switching from plastic to paper-based packaging. That's why you might find a mix of paper and plastic in our boxes!

Nos nouveaux emballages vous emballeront !

Nous passons des emballages en plastique aux emballages à base de papier. C'est pourquoi vous pourriez trouver un mélange de papier et de plastique dans nos boîtes !

¡Te presentamos nuestros nuevos empaques!

Estamos sustituyendo las bolsas de plástico por bolsas con base de papel. ¡Por eso, puedes encontrar una mezcla de papel y de plástico en nuestras cajas!

[LEGO.com/sustainable-packaging](https://www.lego.com/sustainable-packaging)



BUILDER



Apple and the Apple logo are trademarks of Apple Inc., registered in the U.S. and other countries and regions. App Store is a service mark of Apple Inc. Google Play and the Google Play logo are trademarks of Google LLC. Tencent and the Tencent logo are trademarks of Tencent Inc.

Q [LEGO.com/devicecheck](https://www.lego.com/devicecheck)

EN Ask parents' permission before going online | **DE** Eltern um Erlaubnis bitten, bevor du online gehst | **FR** Demande l'autorisation d'un parent avant d'aller en ligne | **IT** Chiedi il permesso ai tuoi genitori prima di andare online | **ES** Pídeles permiso a tus papás antes de conectarte a Internet | **PT** Pede autorização aos pais antes de acederes online | **ZH** 上网前应先征得父母的同意 | **PL** Poproś rodziców o zgodę, zanim wejdiesz do Internetu | **CS** Než půjdeš na internet, požádej rodiče o svolení | **SK** Skôr než pôjdeš na internet, vypýtaj si povolenie od rodičov | **HU** Kérj szülői engedélyt, mielőtt online csatlakoznál! | **RO** Cere permisiunea părinților înainte de a te conecta online | **BG** Поискайте разрешение от родител, преди да влезете онлайн | **LV** Pirms došanās tiešsaistē palūdz atļauju vecākiem | **ET** Enne Interneti kasutamist küsi vanematelt luba | **LT** Prieš prisijungdami prie interneto, atsilkauskite tėvų

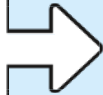
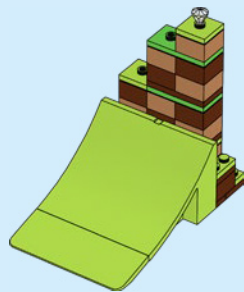
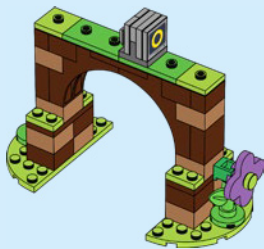
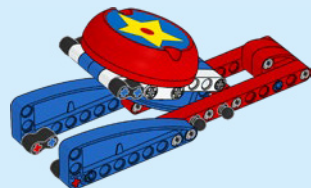

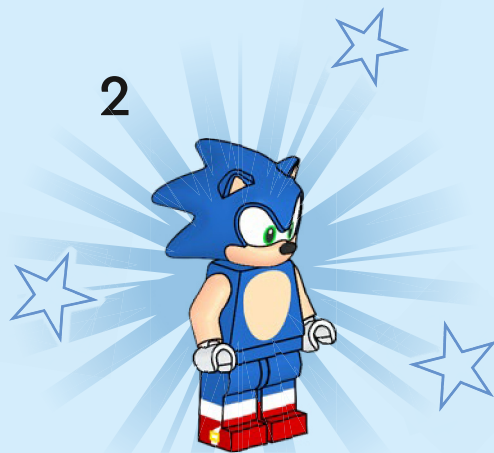
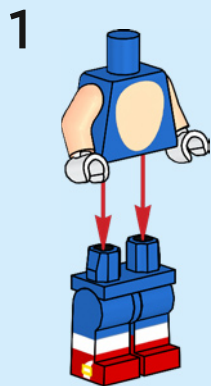

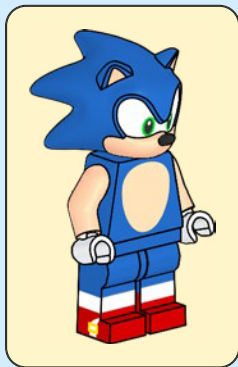
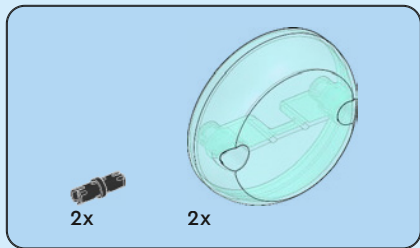

1

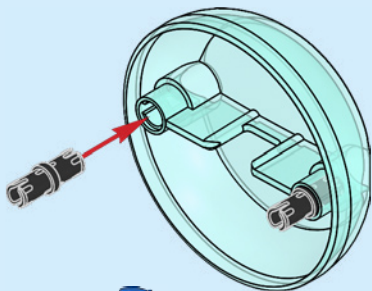

2



3

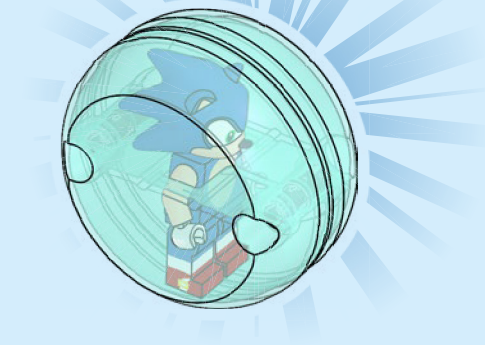

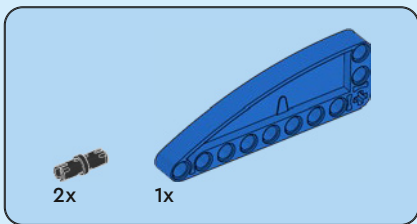
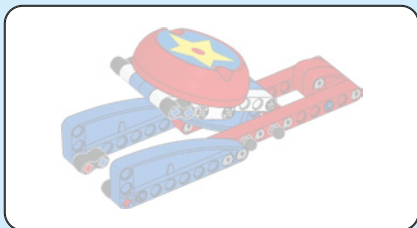

1

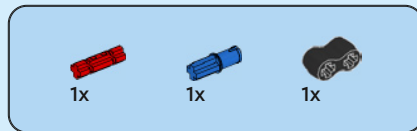
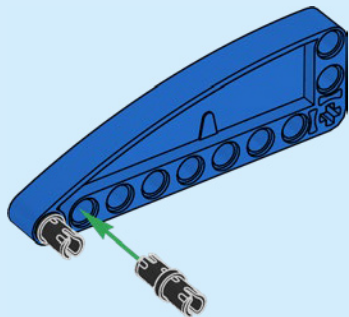

2

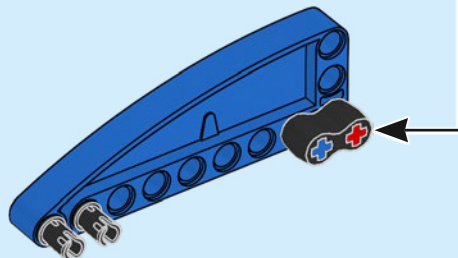
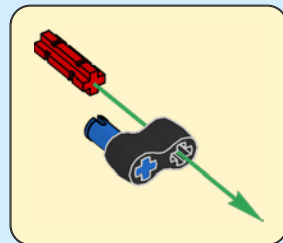

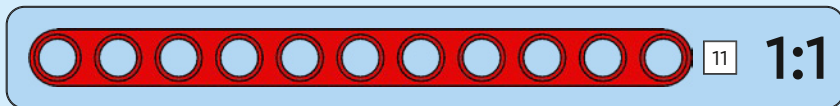
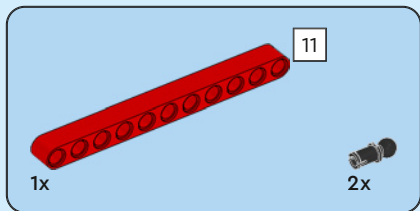

3

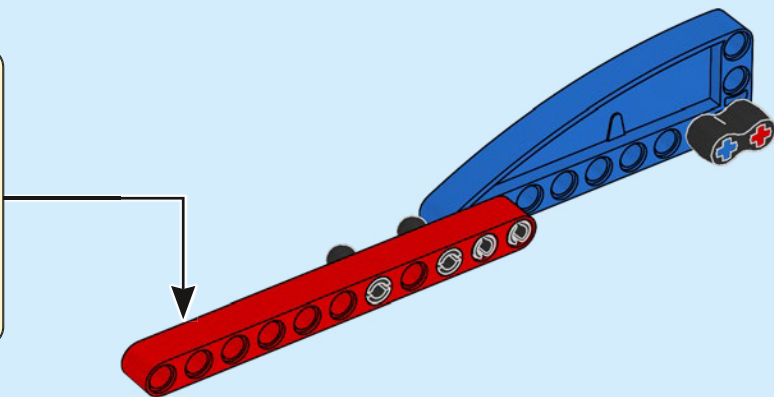
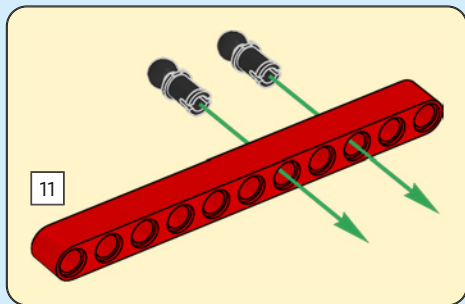



4

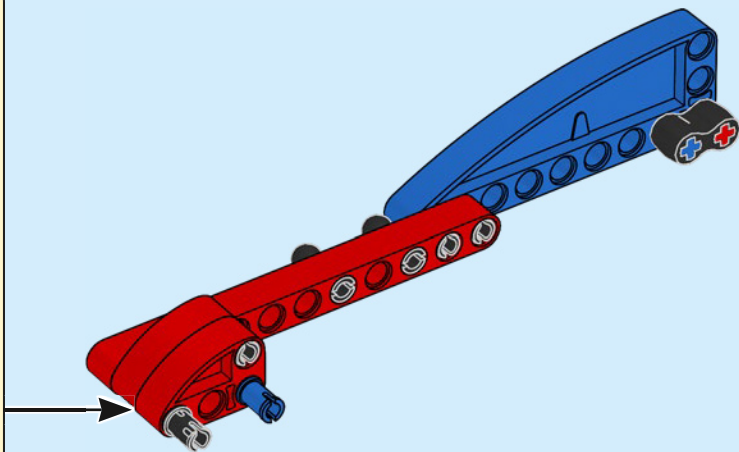
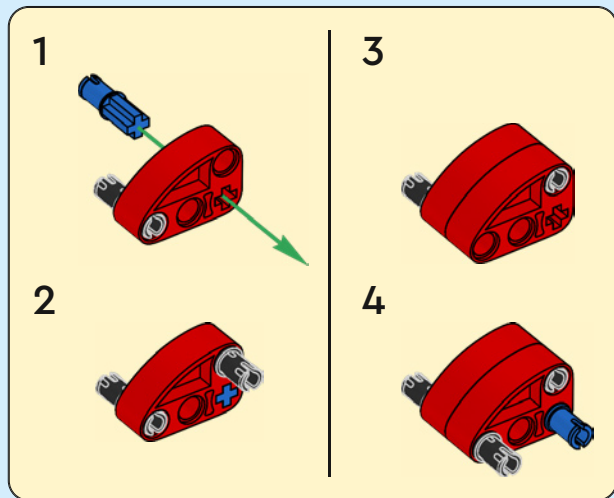

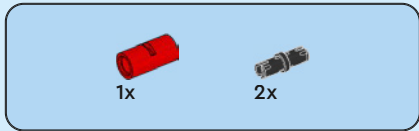

5

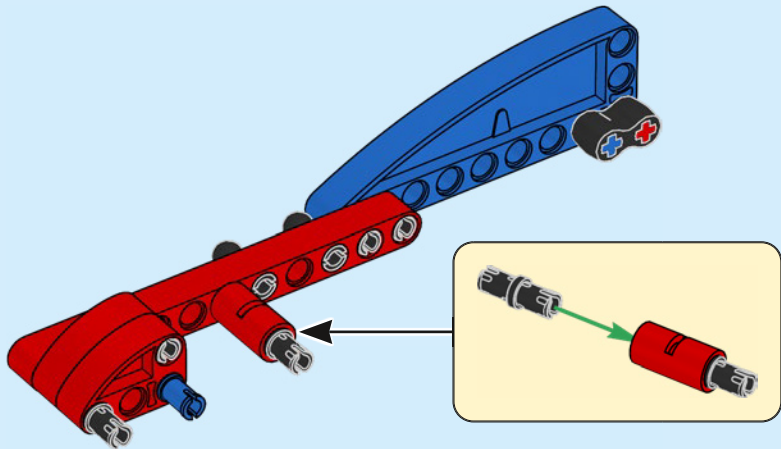

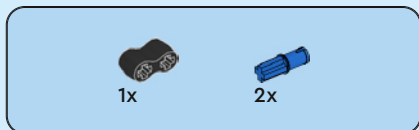
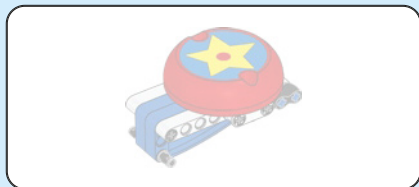

6

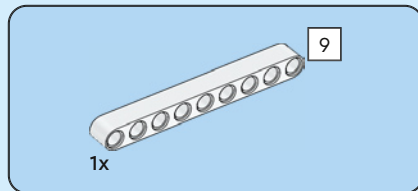
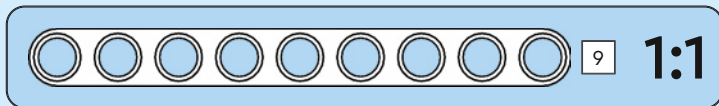
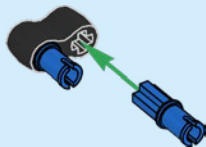

7

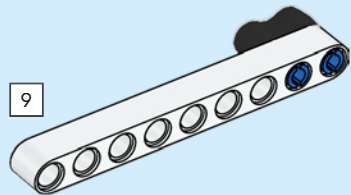

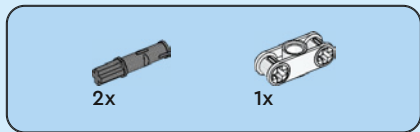

8

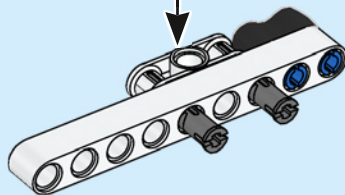
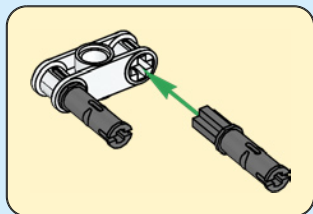

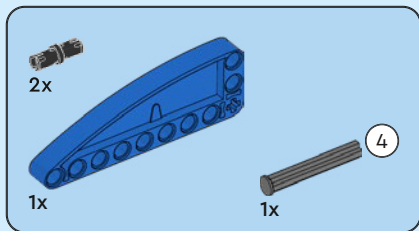

9

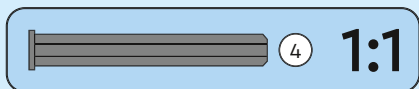
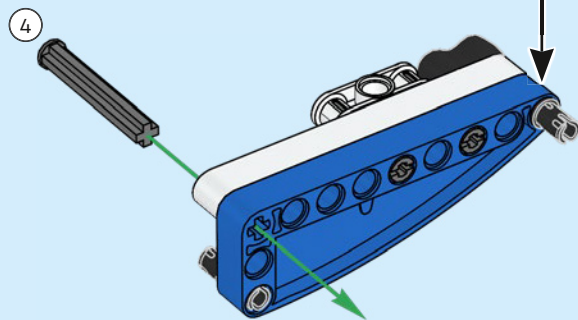
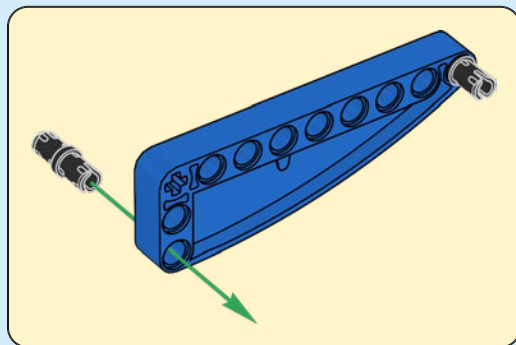

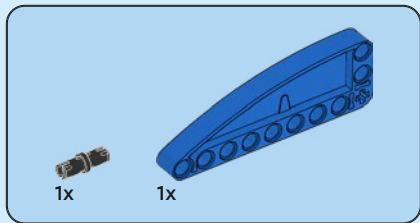

10

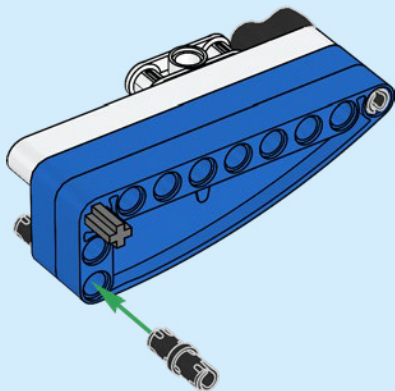

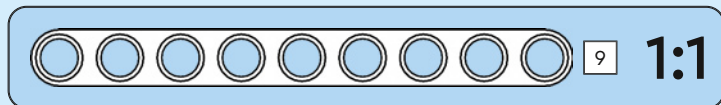
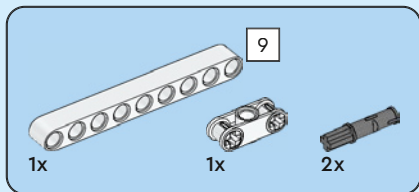

11

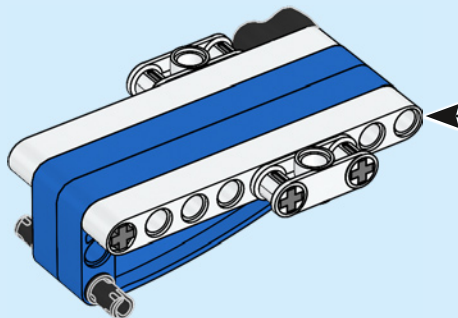
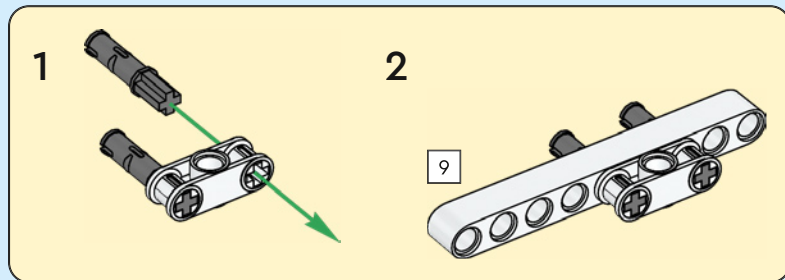



1x



2x

12

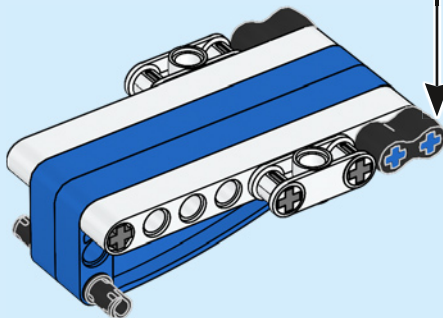
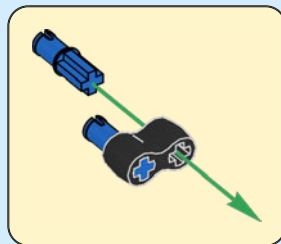



13

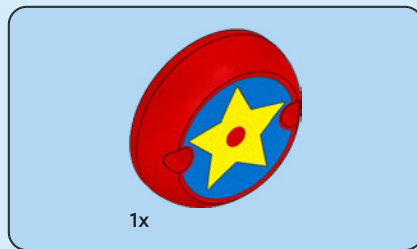
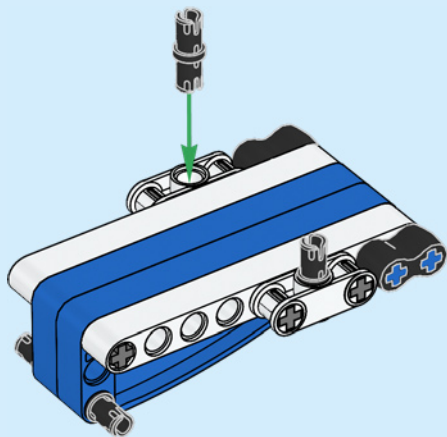

14

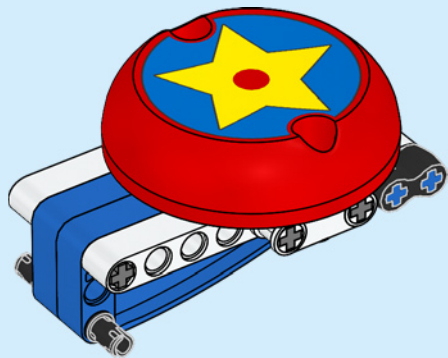

15

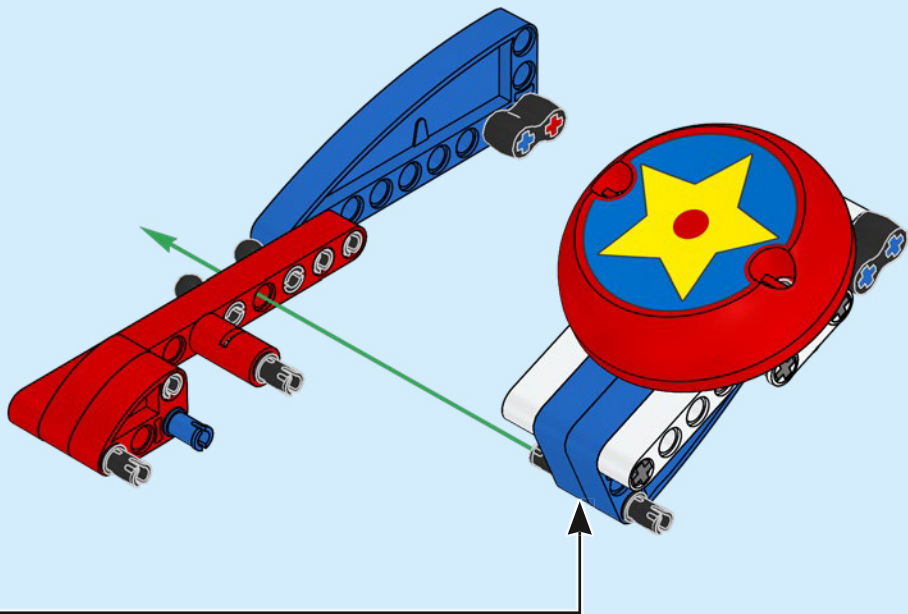

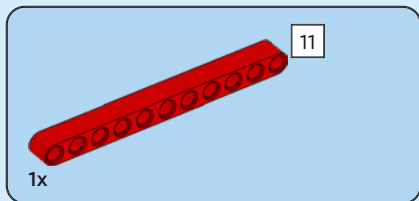

16

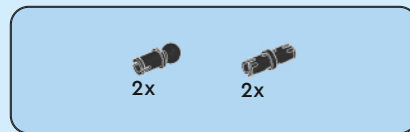
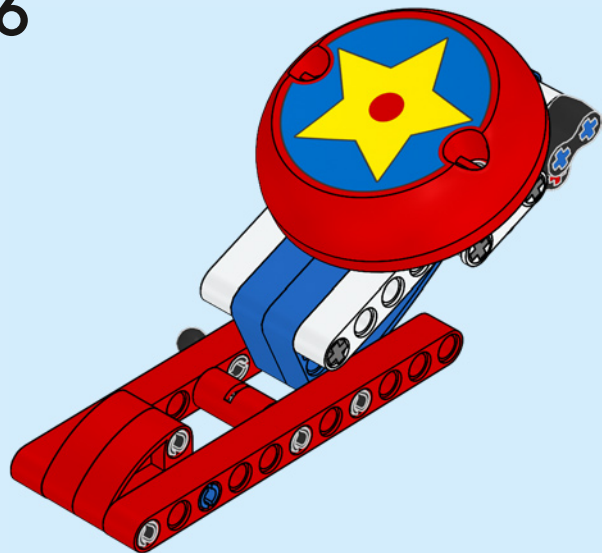

17

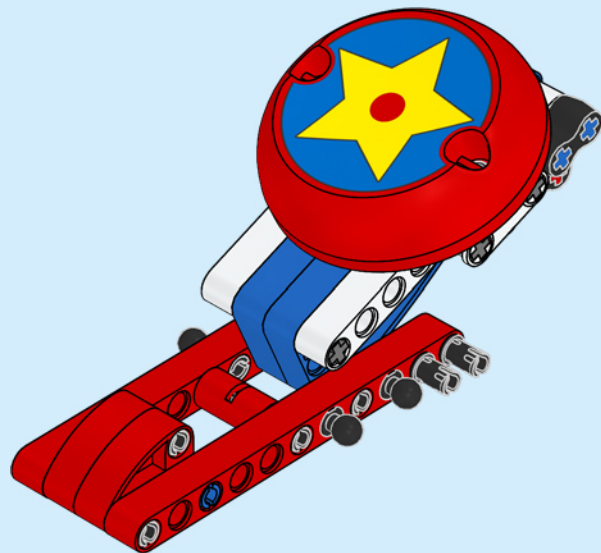

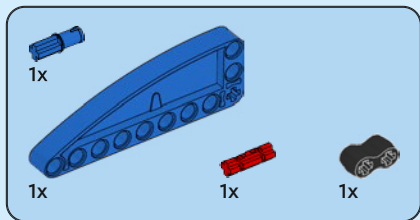

18

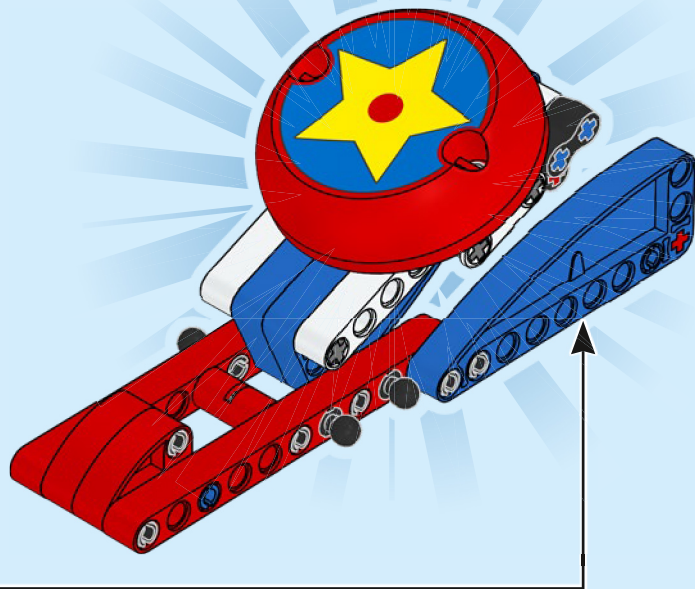
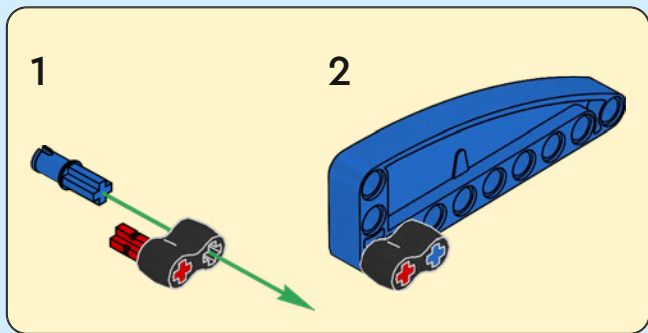

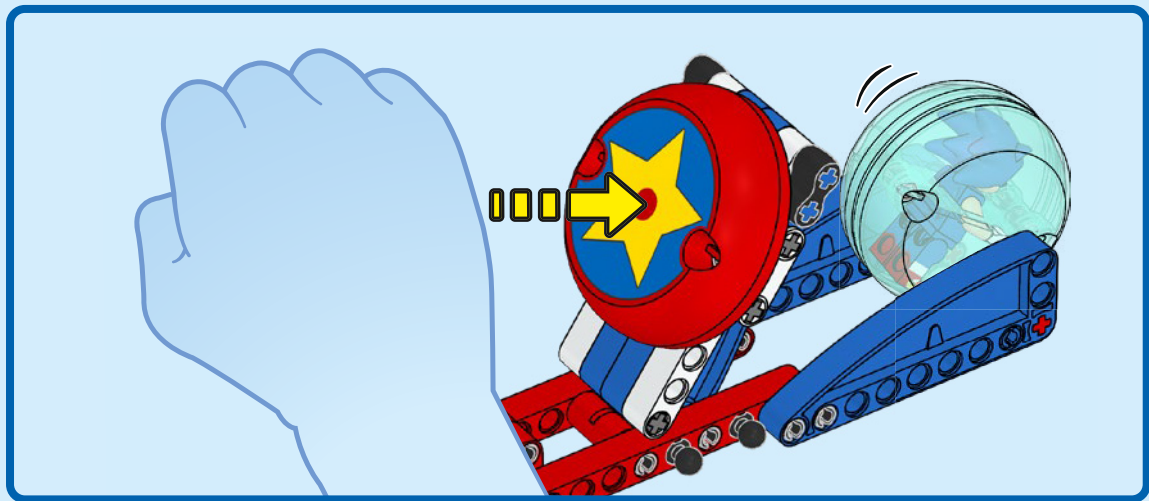

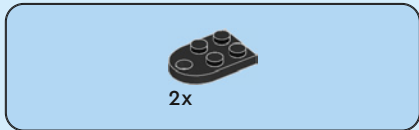
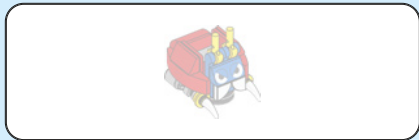

1

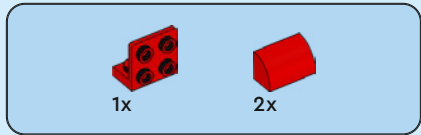
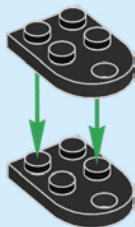

2

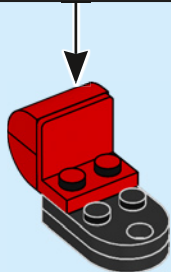
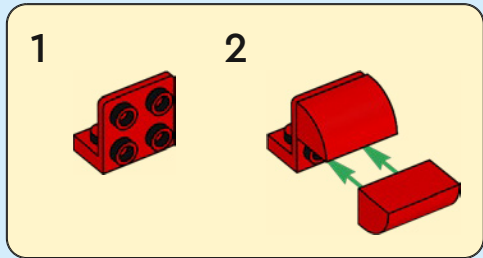

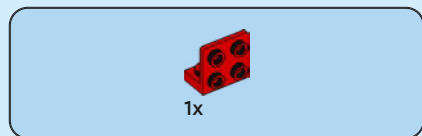

3

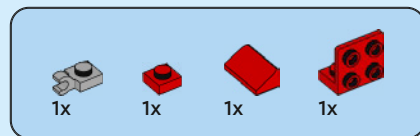
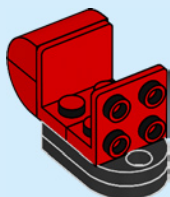

4

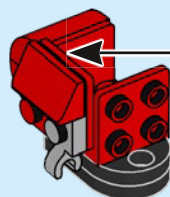
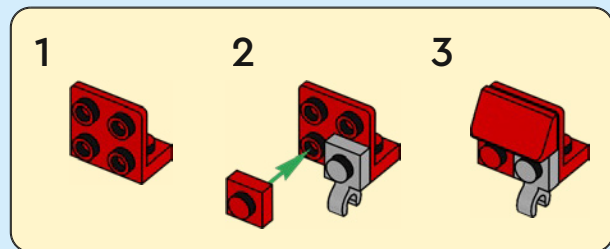

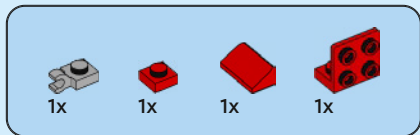

5

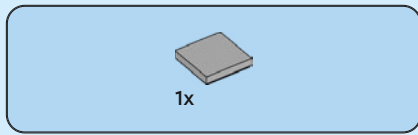
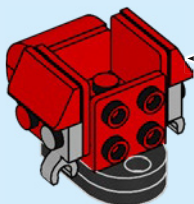
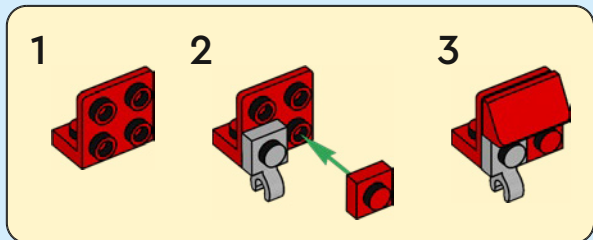

6

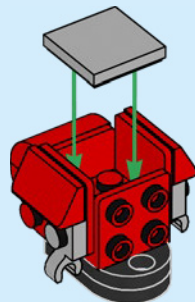

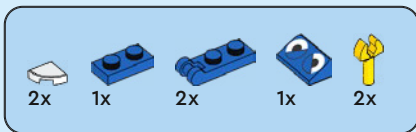

7

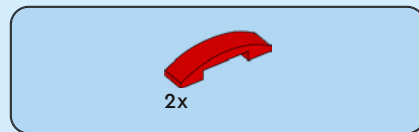
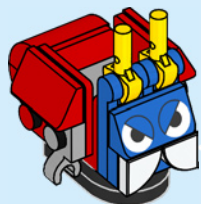
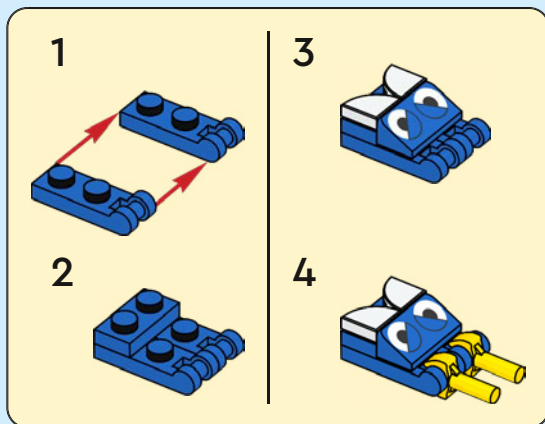

8

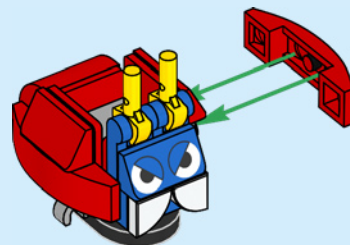



2x



2x



2x



2x

9

1

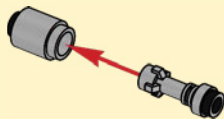

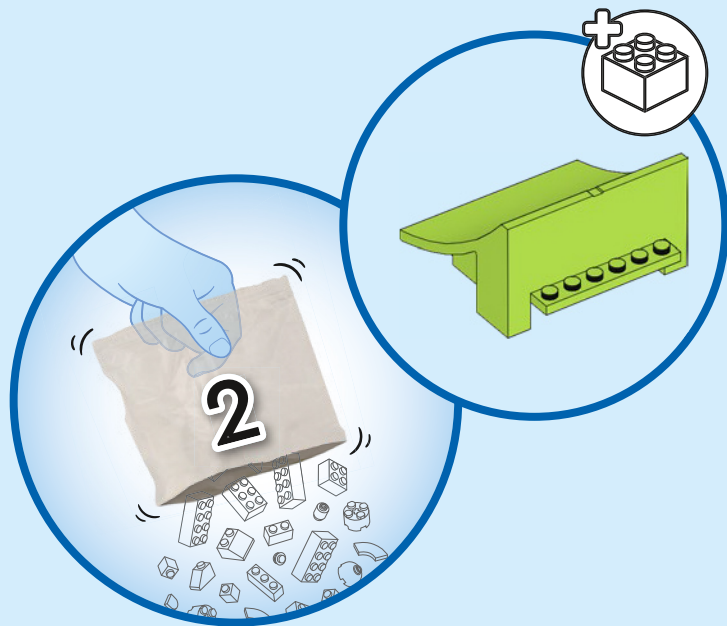

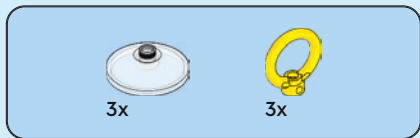

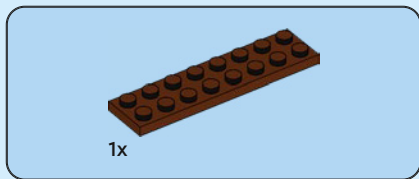
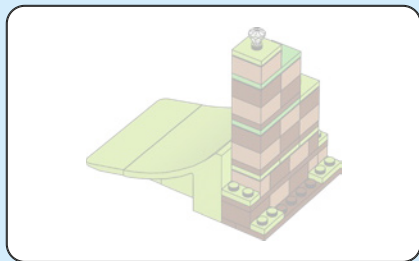

1

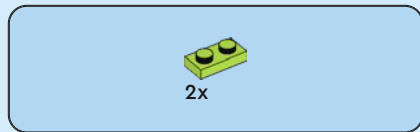
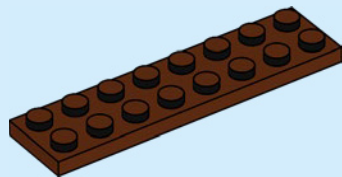

2

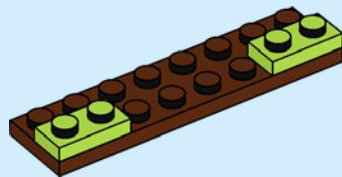



1x



1x

3

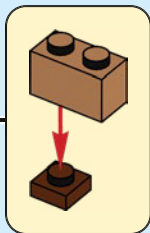
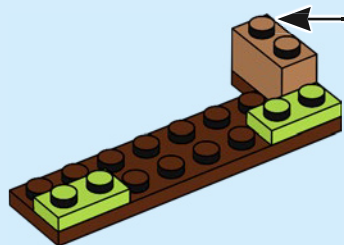

1x



1x



1x

4

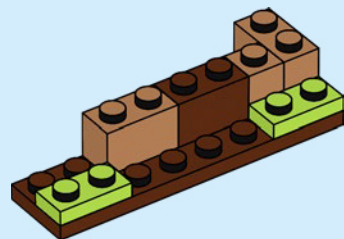



5

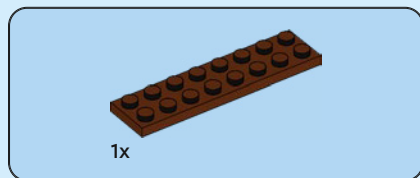
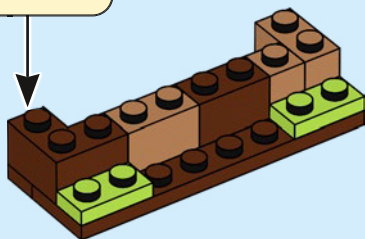
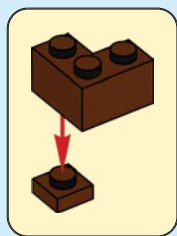

6

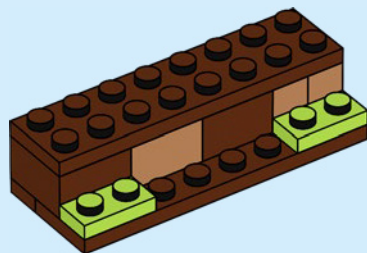



2x

7

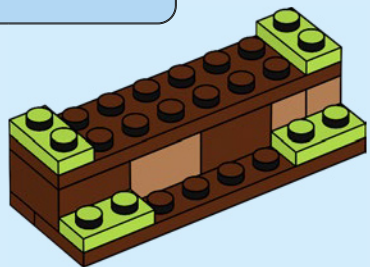

1x



1x



1x



1x

8

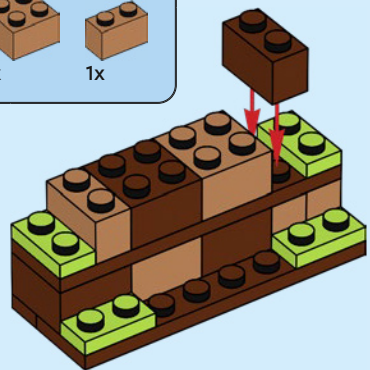

3x

9

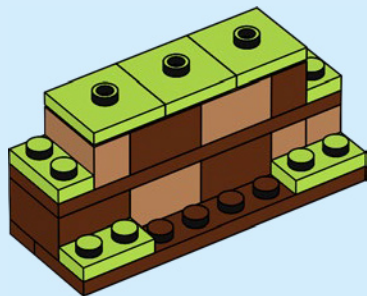

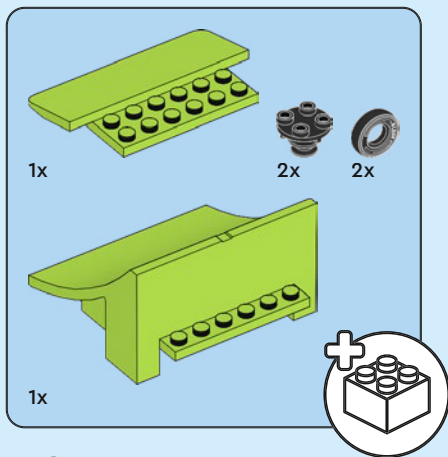

10

1

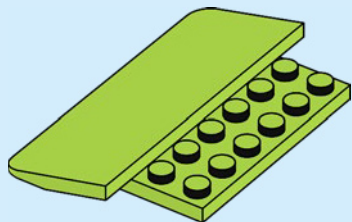

2

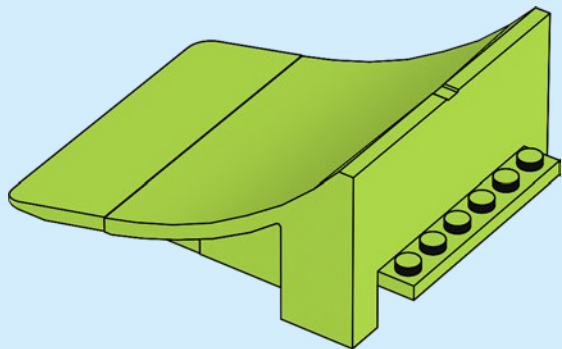



3

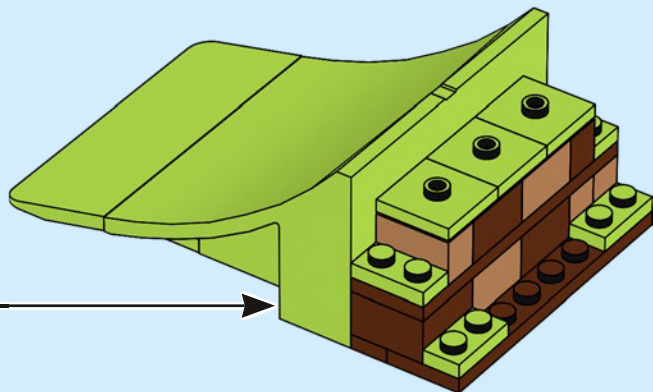
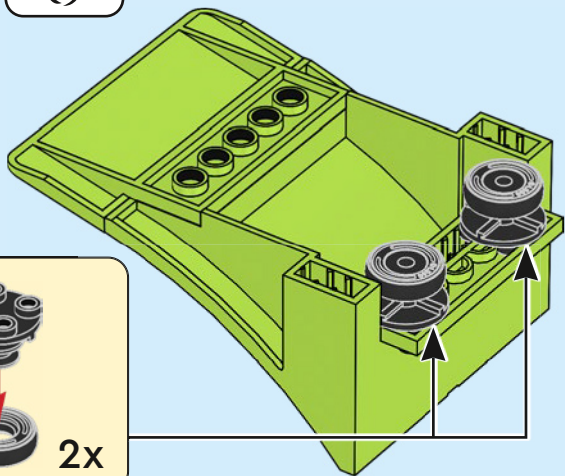
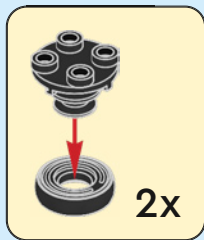

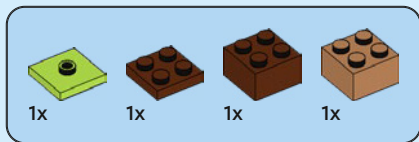

11

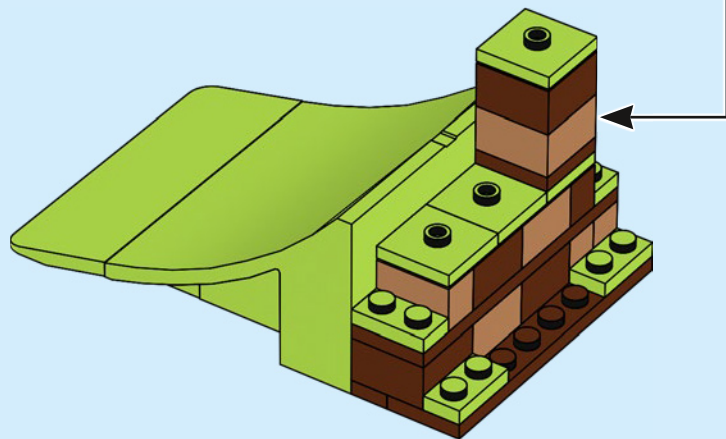
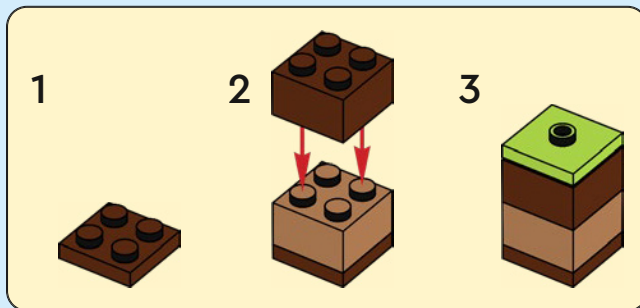



2x



4x



4x



2x



2x

12

1

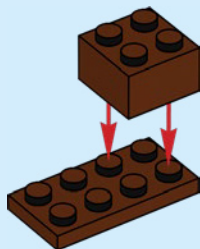

2

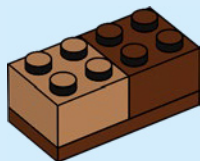

3

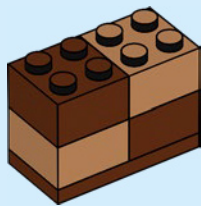

4

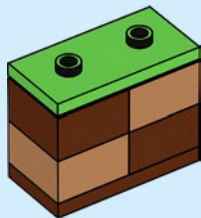

2x

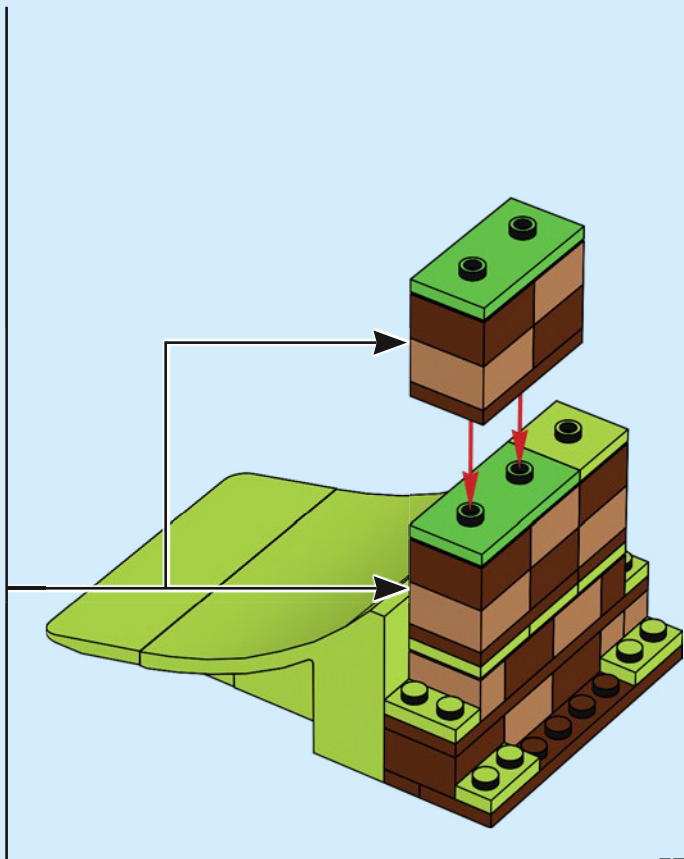

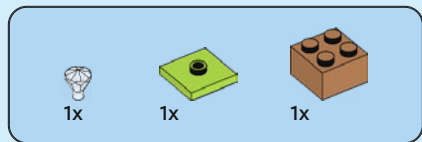

13

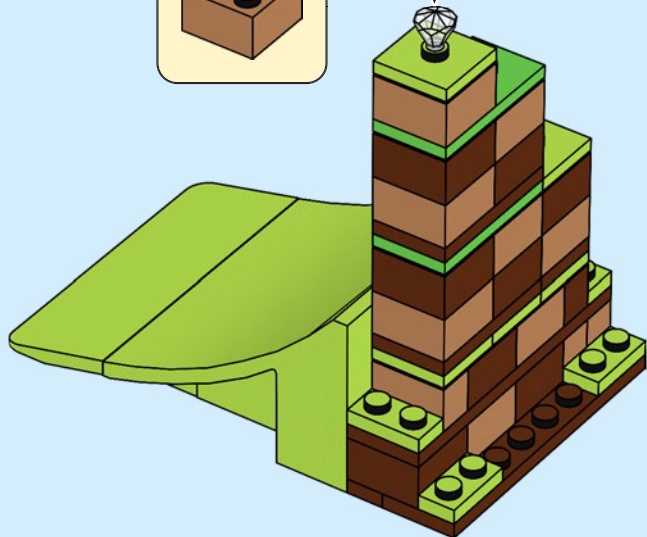
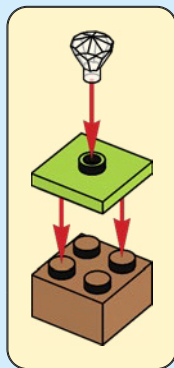

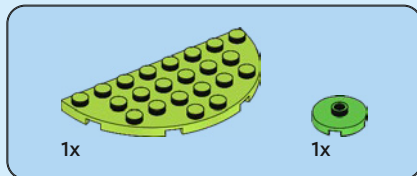
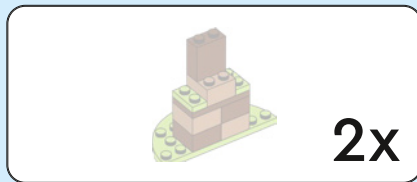
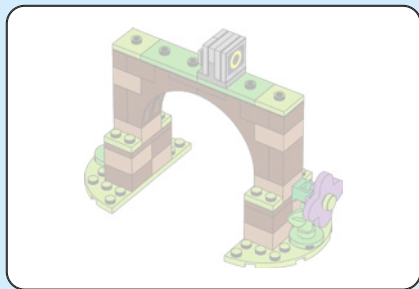

1

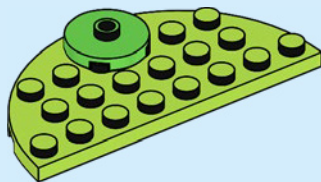



1x



1x

2

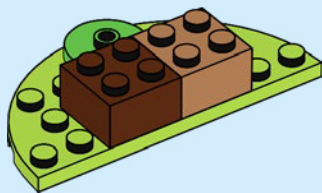

1x



1x

3

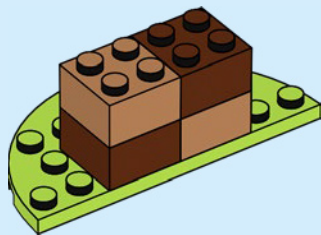



1x

4

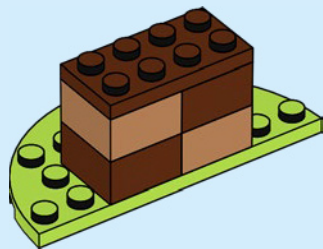

2x



1x

5

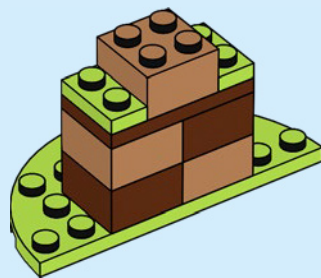



1x

6

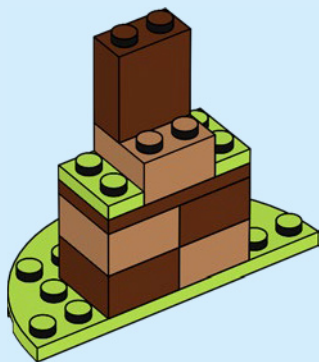

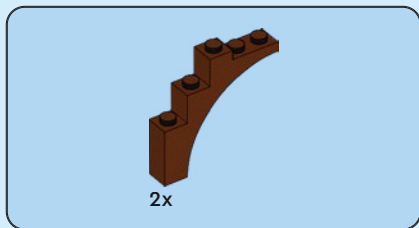

7

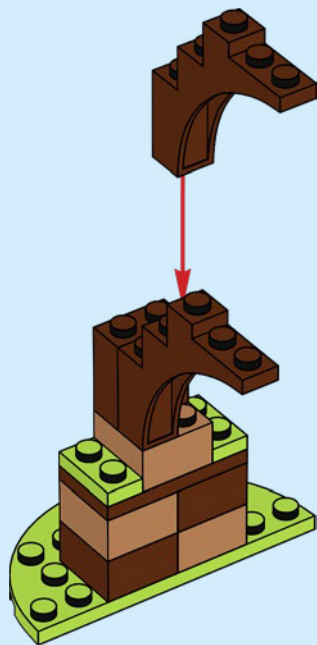

2x





1x

8

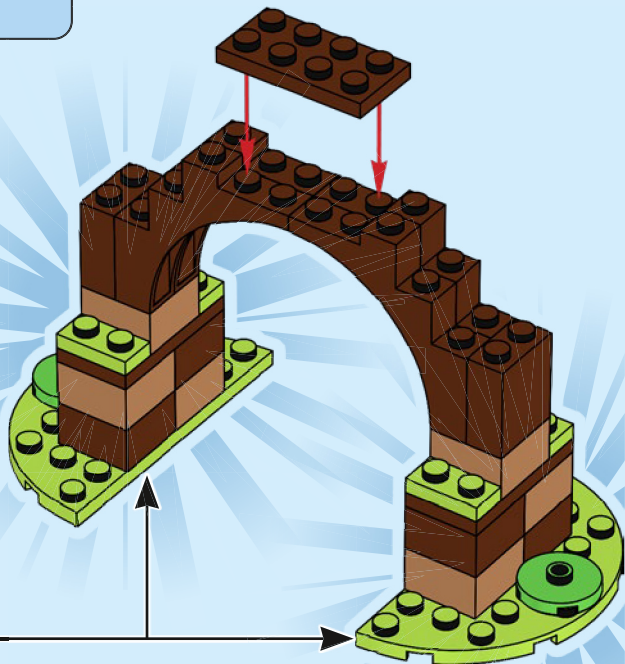



2x

9

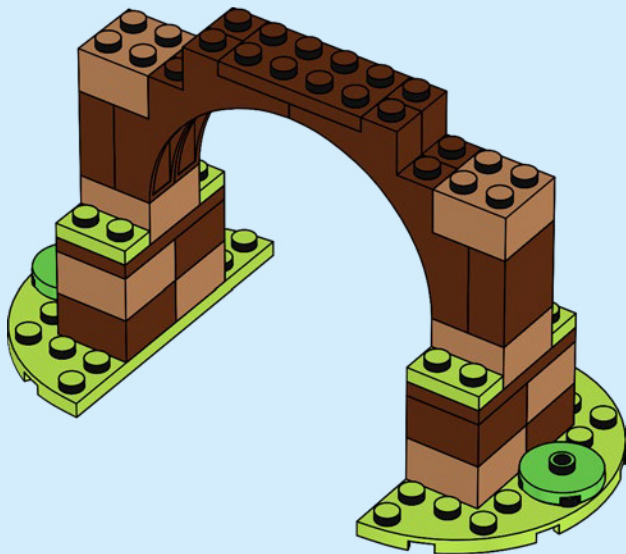

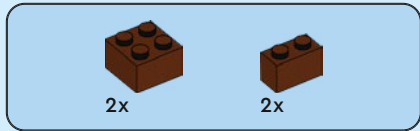

10

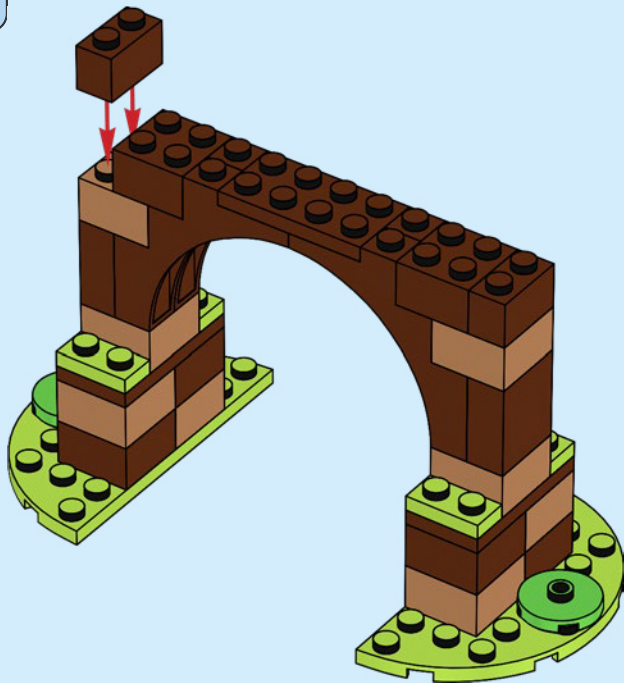



2x



2x

11

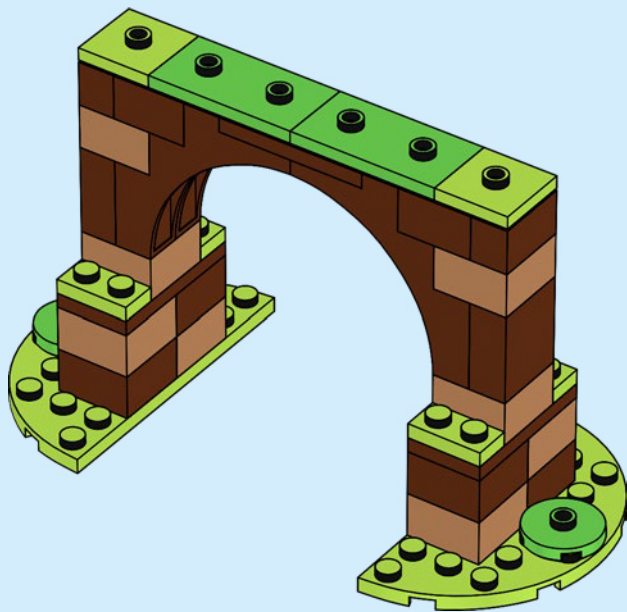

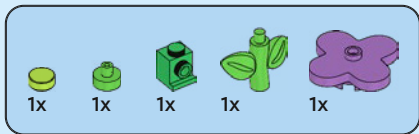

12

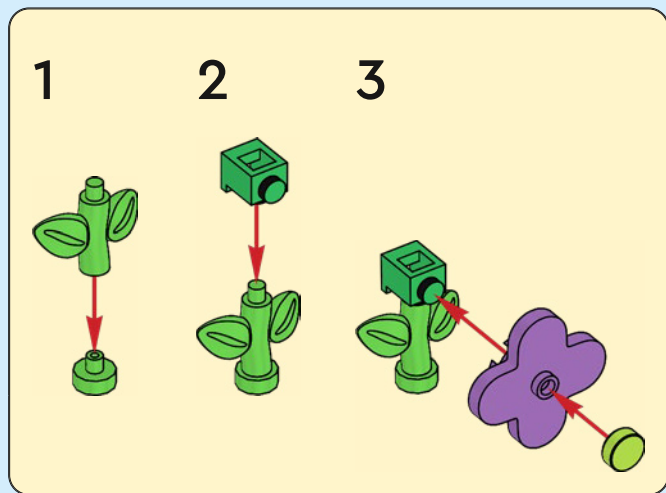
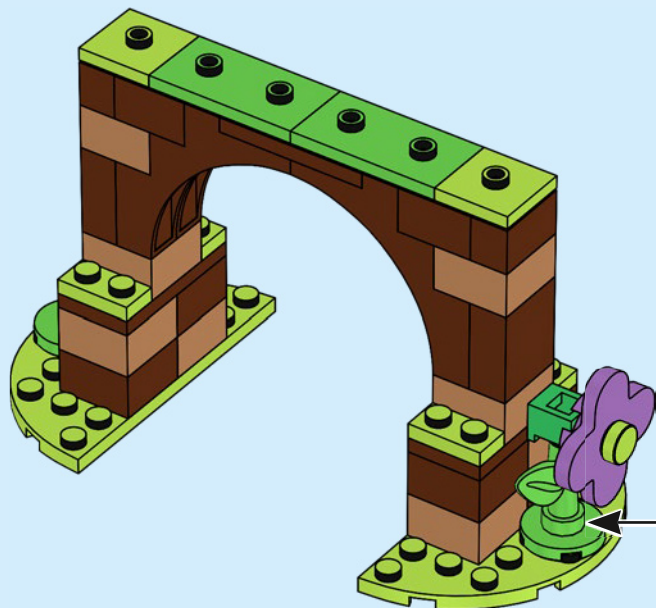

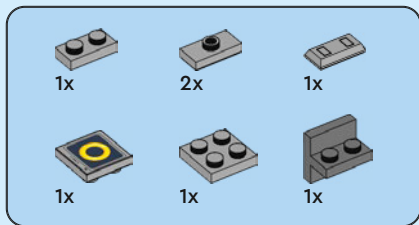

13

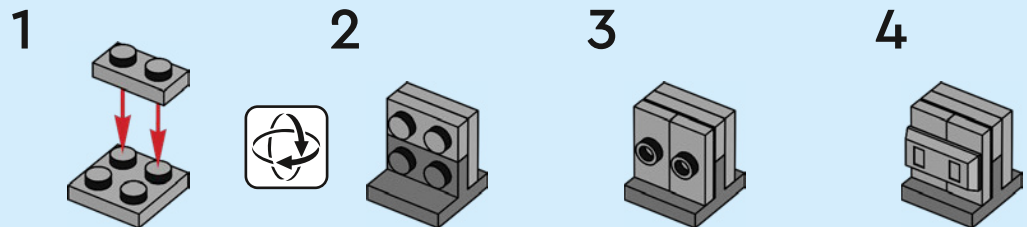

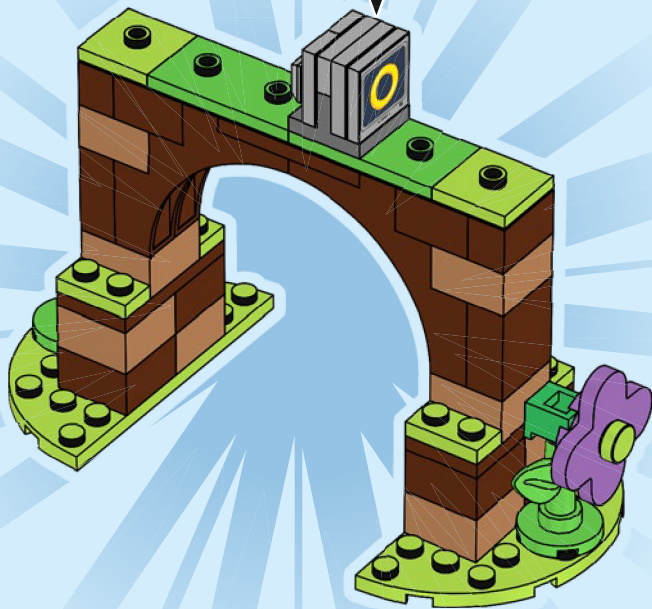

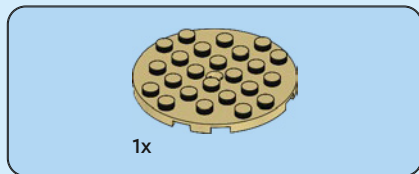

1

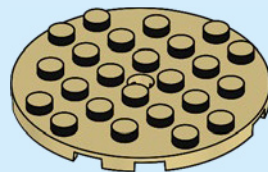

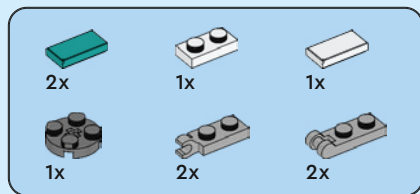

2

1



2

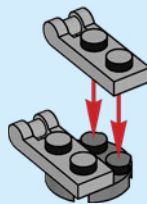

3



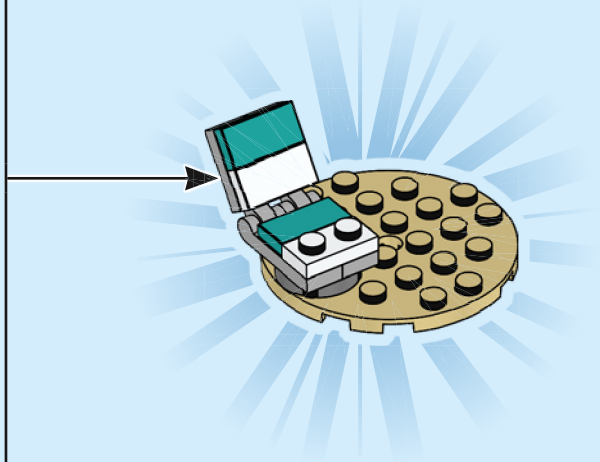
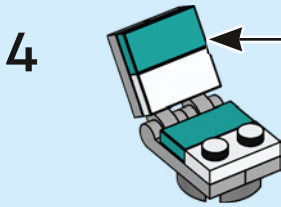
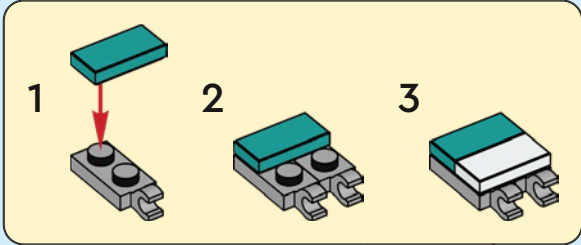

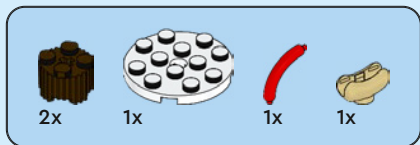

3

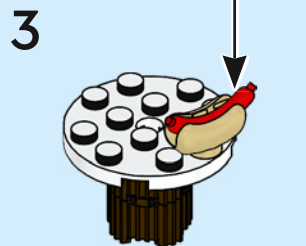
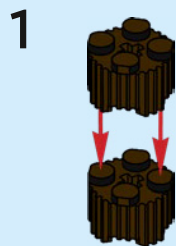

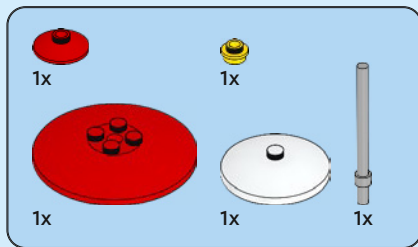
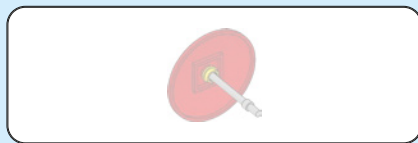
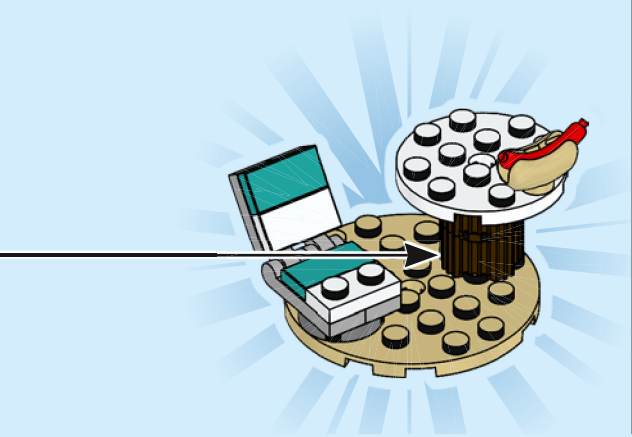

4

1

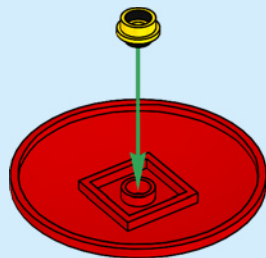



2

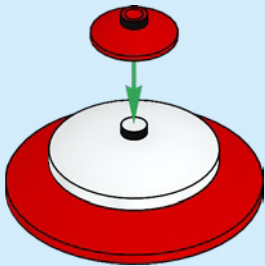

3

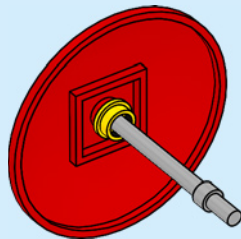

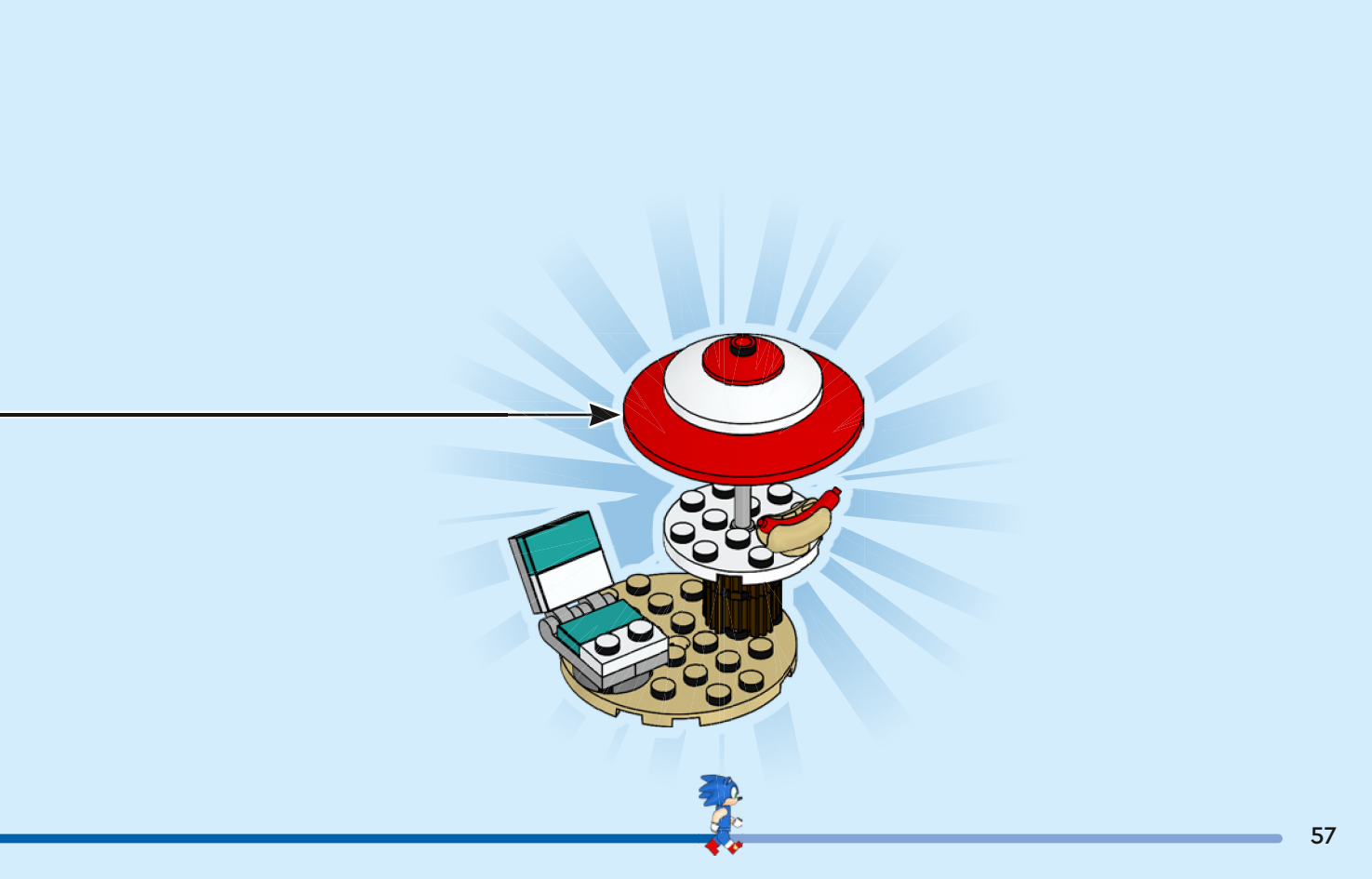

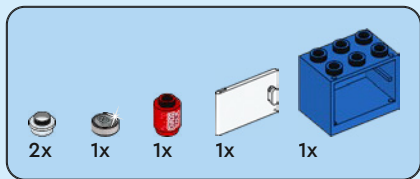

1

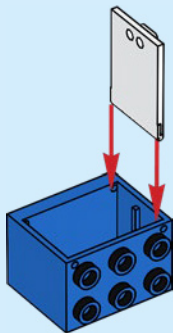

2

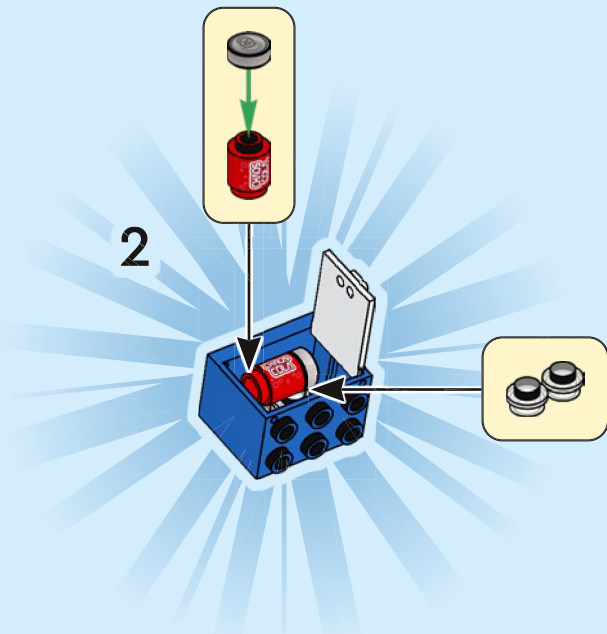

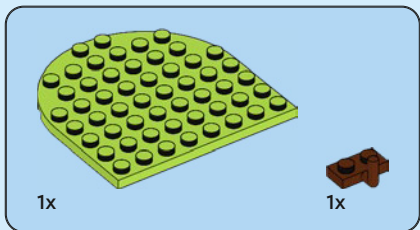
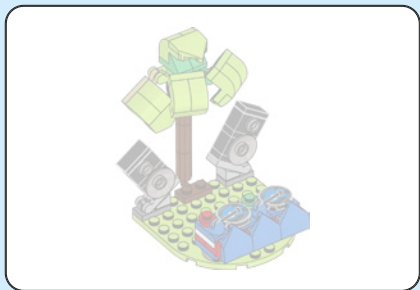

1

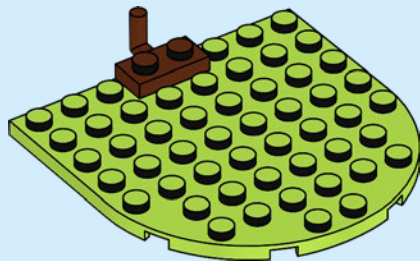



2x



2x

2

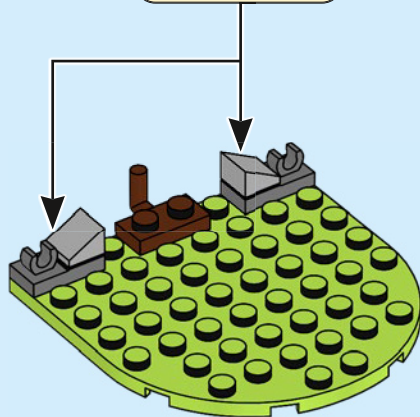
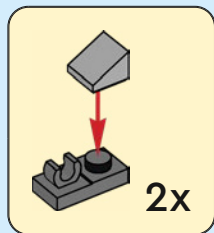

2x

3

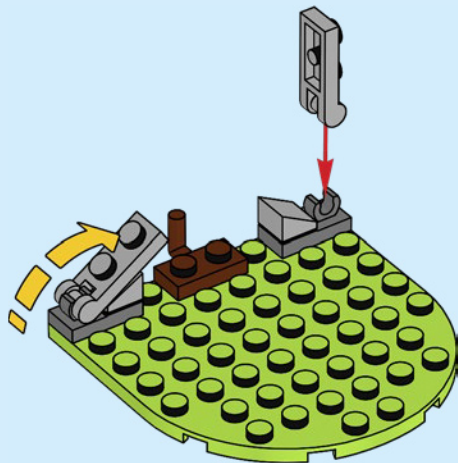



4

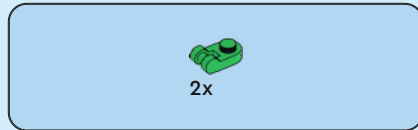
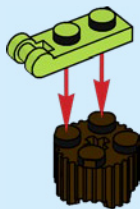

5





1x

6



2x

7

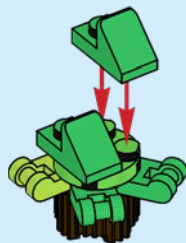



2x

8

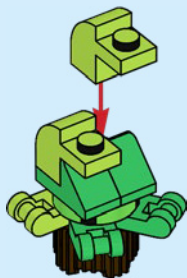

1x

9

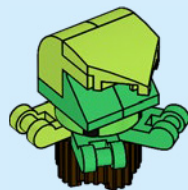

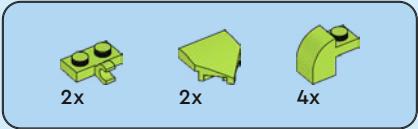

10

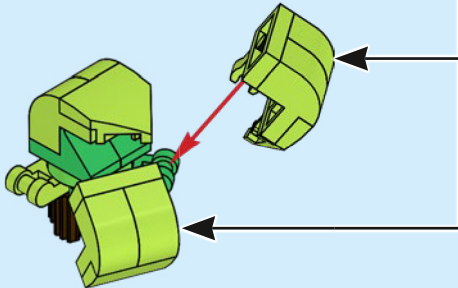
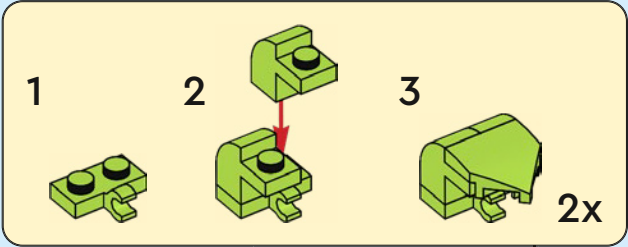

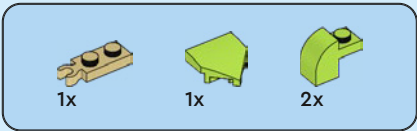

11

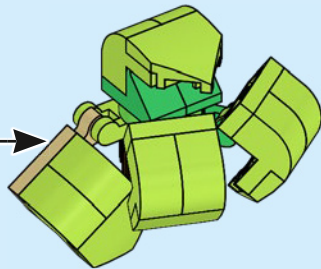
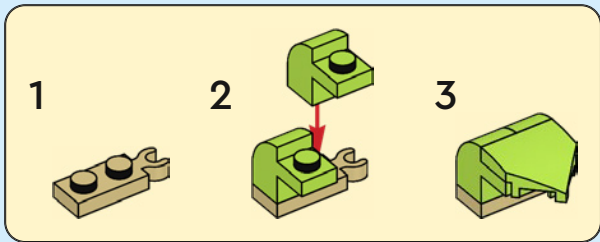



12

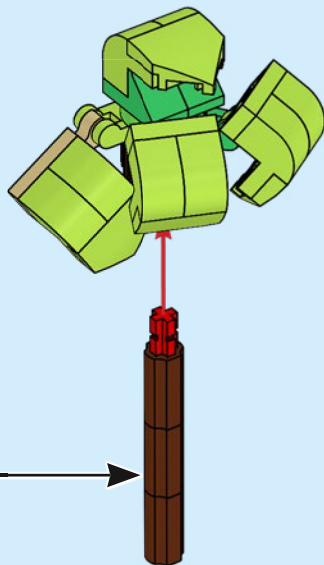
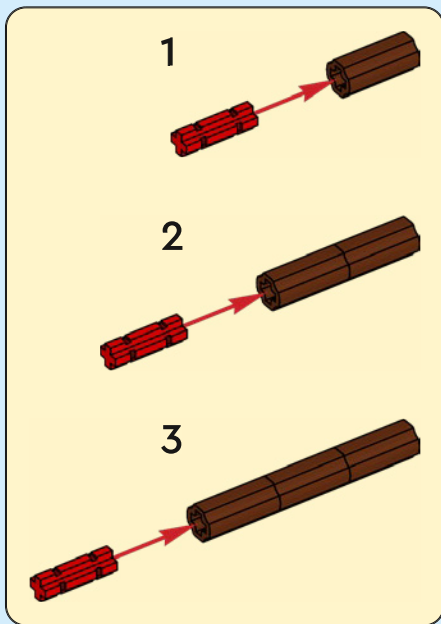

13

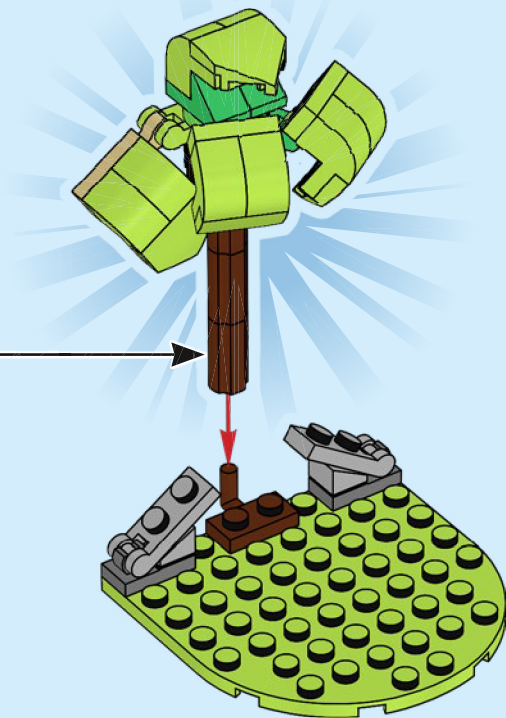



2x



2x



2x



4x



2x



4x

14

1

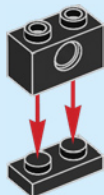

2

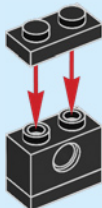

3



4



2x

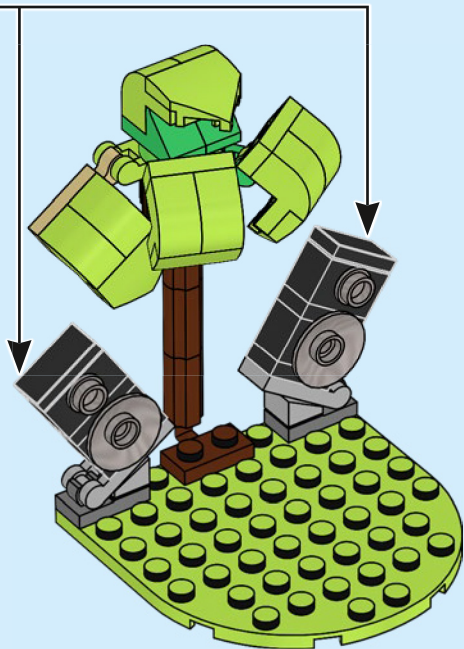

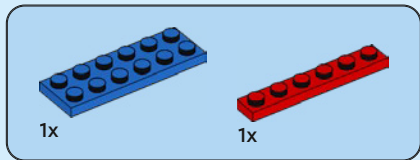
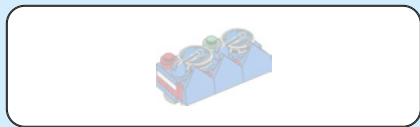

15

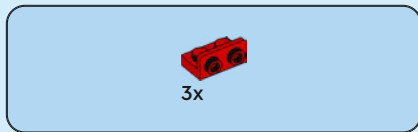
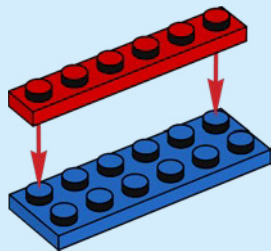

16

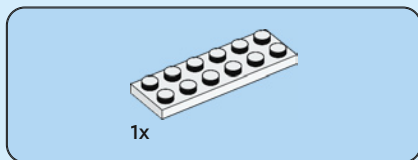
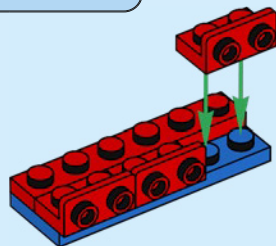

17

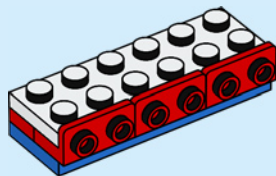

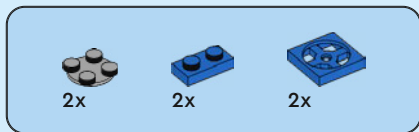

18

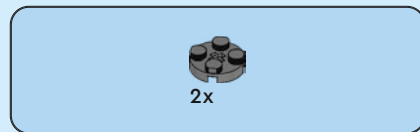
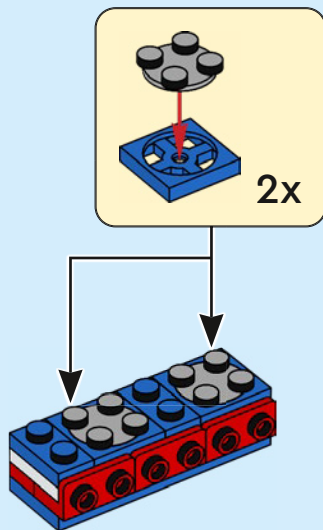

19

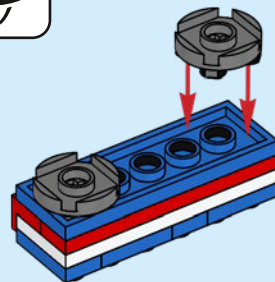



2x

20

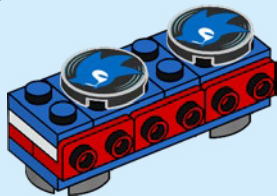

2x



1x



1x

21

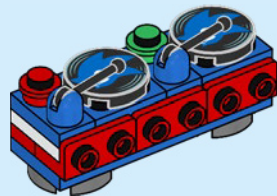

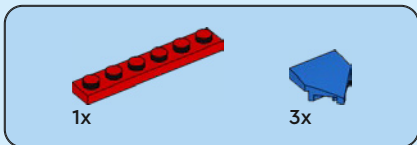

22

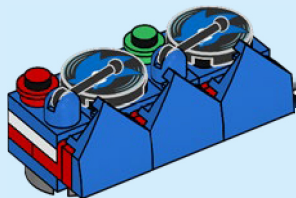
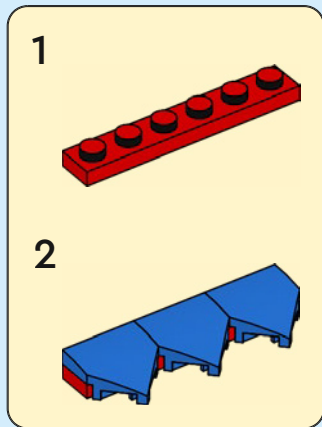

23

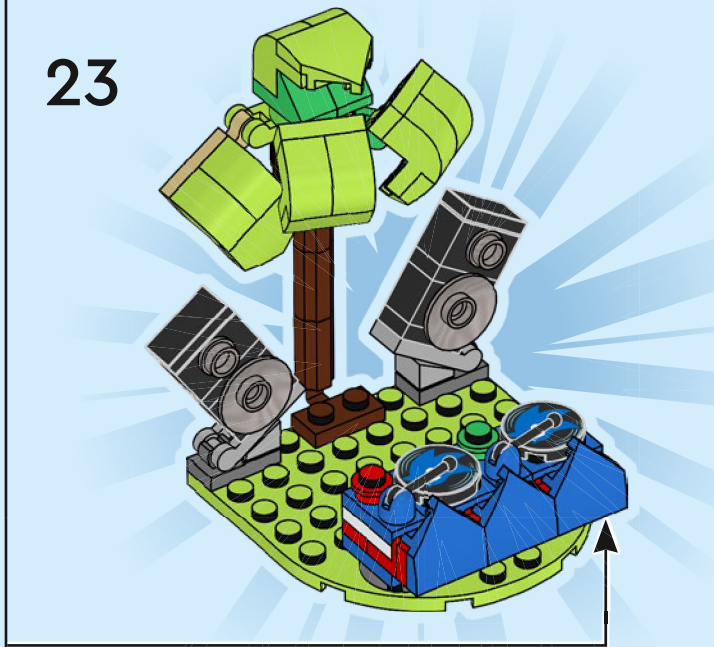







SONIC™

THE HEDGEHOG



76990

Combine sets to
expand your play!

Combiner les
ensembles pour
encore plus de jeu !

¡Combina sets para
jugar mucho más!





2x
6270106

2x
6172366

1x
302301

1x
306901

1x
4261470

2x
6276981

1x
396001

1x
4515347

1x
379501

2x
6001831

78

1x
6147214

1x
6372047

1x
6093862

1x
614121

1x
6452585

2x
302421

1x
6144805

2x
6451524

5x
4142865

1x
4585146

2x
6381444

1x
6173126

2x
6252037

3x
6089698

4x
6001806

2x
4633914

2x
366621

1x
6156534

1x
6443200

2x
4562805

2x
4296152

1x
6443151

8x
4206482

1x
6372164

3x
6378794

3x
302323

2x
368023

2x
6073890

1x
6452519

1x
6313992

1x
379523

4x
6441687

3x
6168644

2x
6439051

3x
6441692

2x
4516843

4x
6344752

2x
6443153

16x
6279875

2x
6252373

4x
4198367

4x
302326

4x
370026

2x
306926

2x
317626

1x
4569058

1x
6400649

1x
4187334

2x
6253140

2x
6226931

1x
6138624

2x
6380676

9

11



 [LEGO.com/service](https://www.LEGO.com/service)

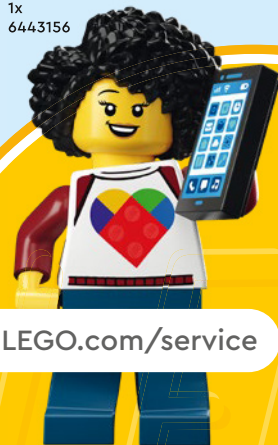

YOU COULD
WIN



Scan this QR code or go to
LEGO.COM/PRODUCTFEEDBACK and give
us your short feedback about this LEGO® set
for a chance to win a cool LEGO prize.

Terms and Conditions apply*



EN: YOU COULD WIN. Terms and Conditions apply* **DE: Du könntest GEWINNEN.** Es gelten die Teilnahmebedingungen* **FR: Tu pourrais GAGNER.** Des conditions s'appliquent* **IT: Potresti VINCERE tu.** Termini e condizioni sono applicabili* **ES: Puedes GANAR.** Aplican términos y condiciones* **PT: Poderá GANHAR.** Aplicam-se termos e condições* **ZH: 轻松获奖. 条款和条件适用*** **PL: Szansa na WYGRANĄ.** Obowiązują warunki korzystania* **CS: Máte šanci VYHRÁT.** Platí všeobecné smluvní podmínky* **SK: Máte šancu VYHRAŤ.** Platia všeobecné zmluvné podmienky* **HU: TE IS NYERHETSZ.** Felhasználási feltételek érvényesek* **RO: Ai putea CÂȘTIGA.** Se aplică termenii și condiții* **BG: Можете да СПЕЧЕЛИТЕ.** Има определени правила и условия* **LV: Tu vari LAIMĒT.** Ir spēkā noteikumi un nosacījumi.* **ET: Sul on võimalus VÕITA.** Kehtivad tingimused* **LT: Jūs galite LAIMĖTI.** Taikomos sąlygos*

*[LEGO.com/productfeedback-terms](https://www.lego.com/productfeedback-terms)

LEGO and the LEGO logo are trademarks of the/son des marques de commerce du/son marcas registradas de LEGO Group. ©2023 The LEGO Group.
©SEGA. All rights reserved. SEGA is registered in the U.S. Patent and Trademark Office. SEGA and SONIC THE HEDGEHOG are either registered trademarks or trademarks of SEGA CORPORATION.

6474438