

Harry Potter

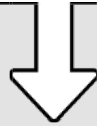

WIZARDING  
WORLD

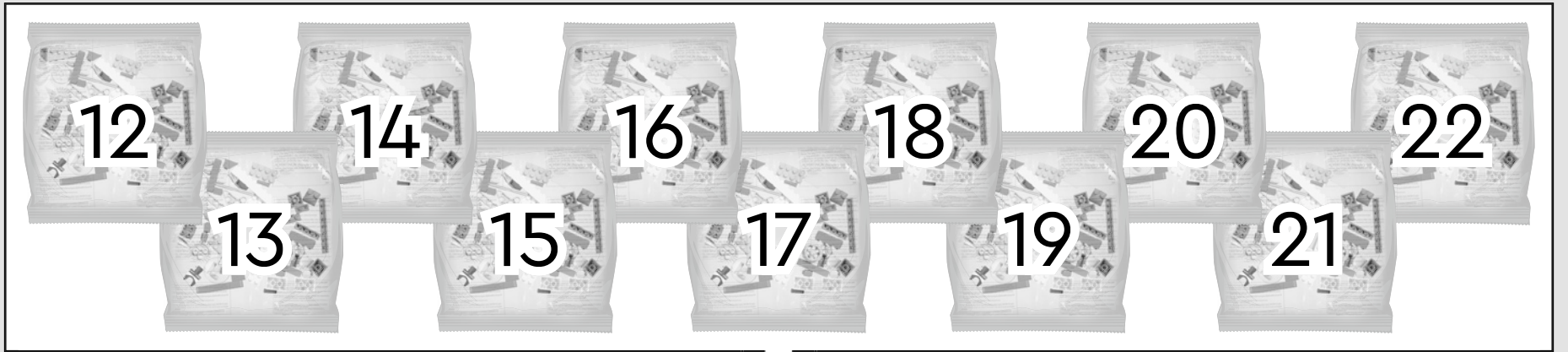



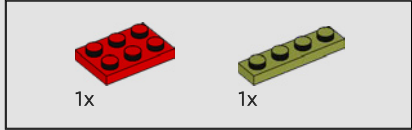
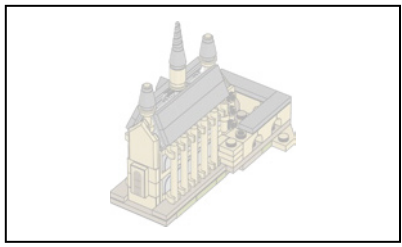

309

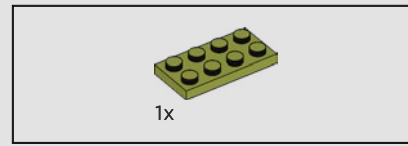
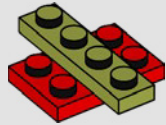

310

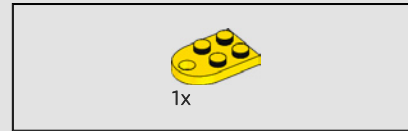
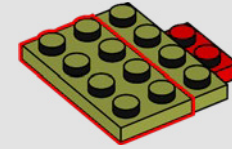

311

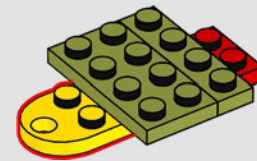

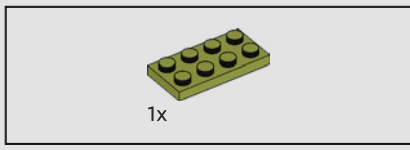

312

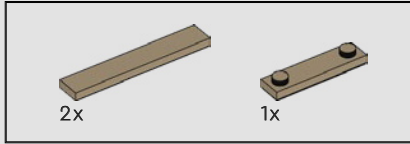
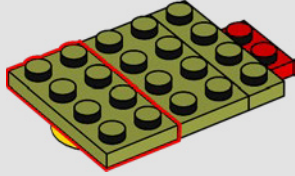

313

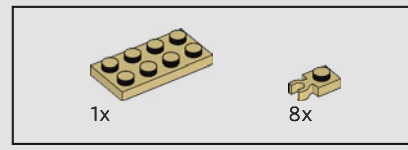
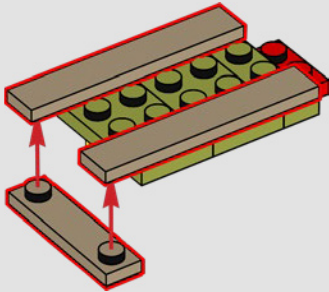

314

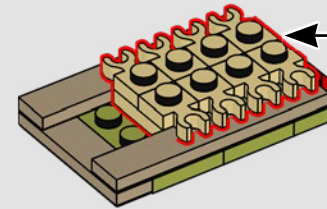
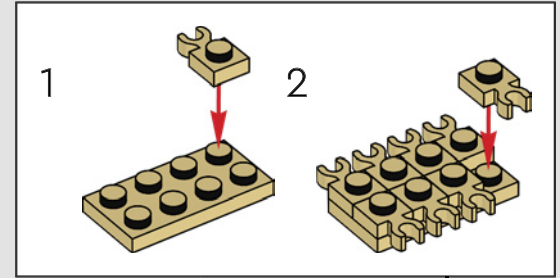

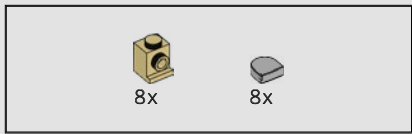

315

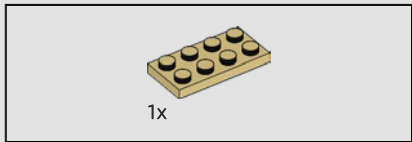
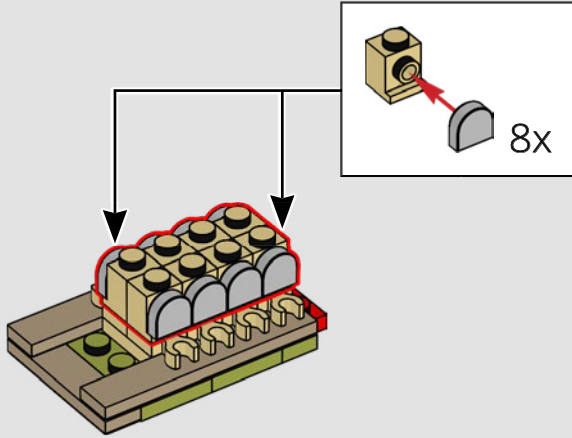

316

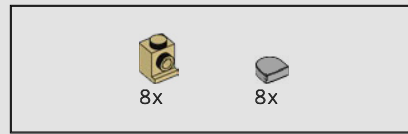
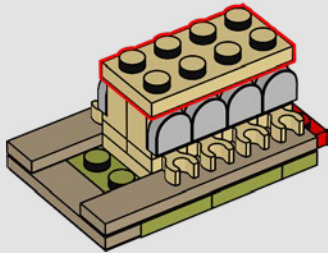

317

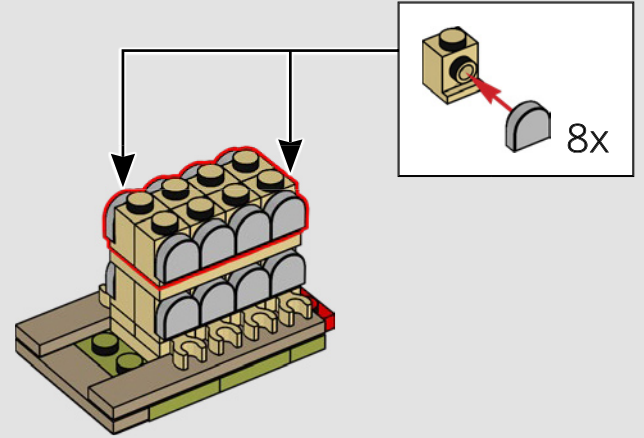

318

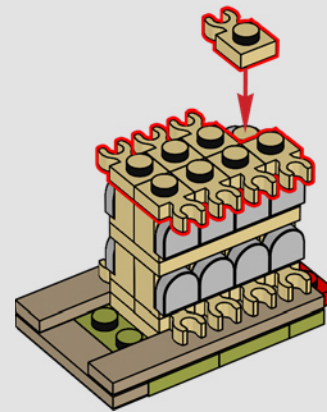

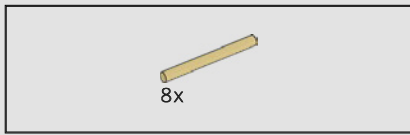

319

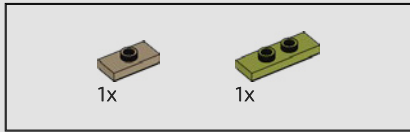
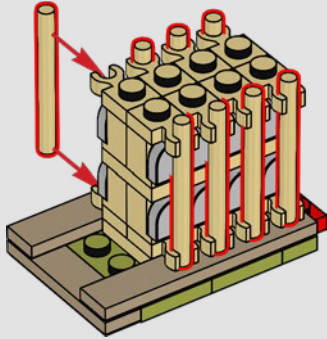

320

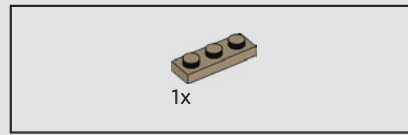
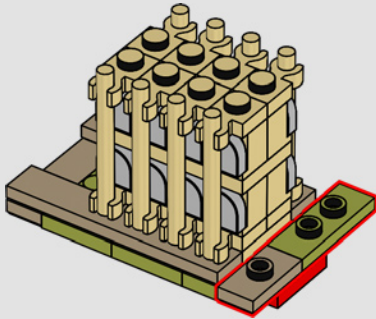

321

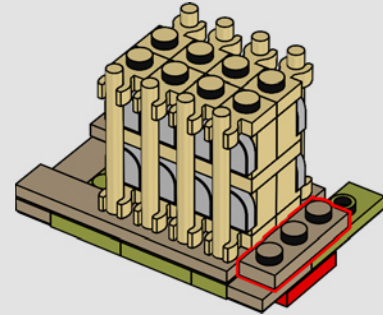

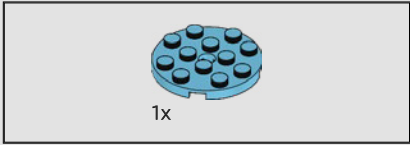
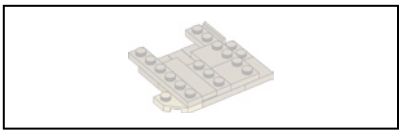

322

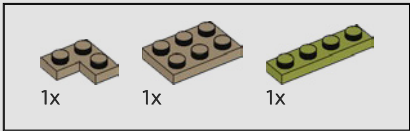
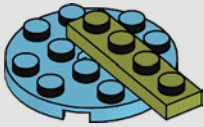

323

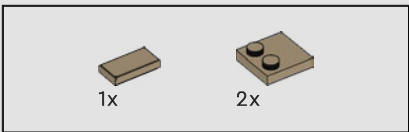
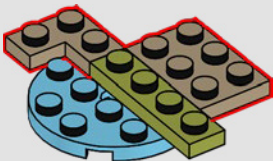

324

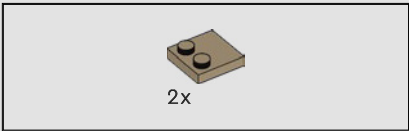
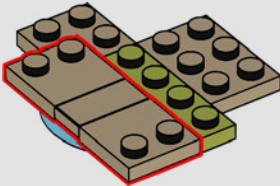

325

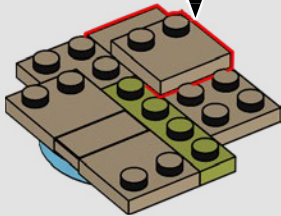
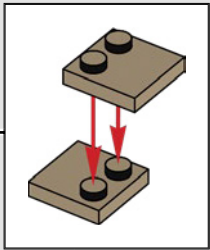



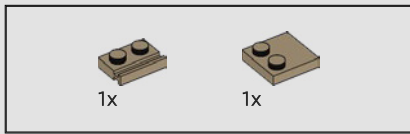

326

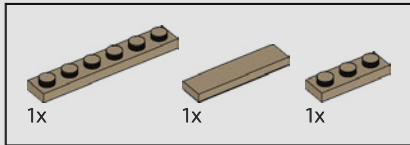
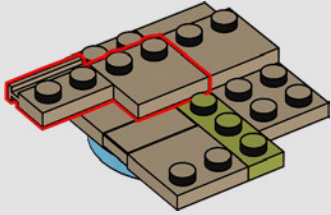

327

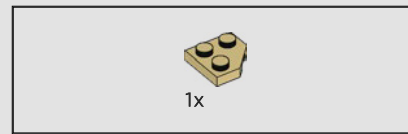
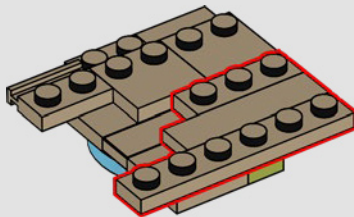

328

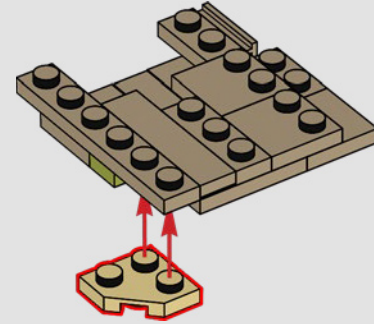
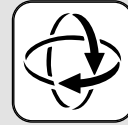

329

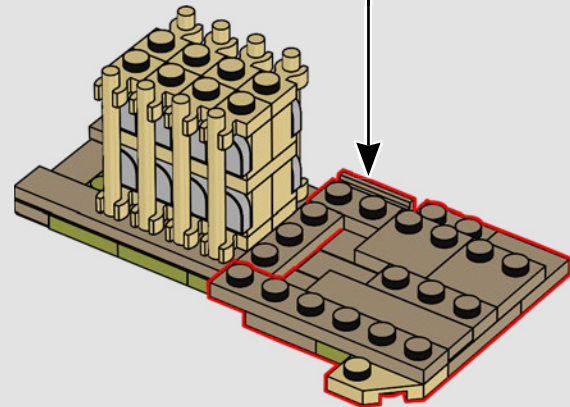

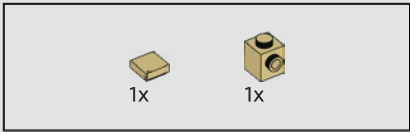

330

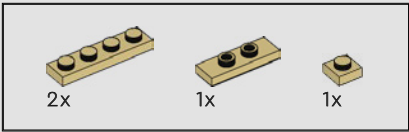
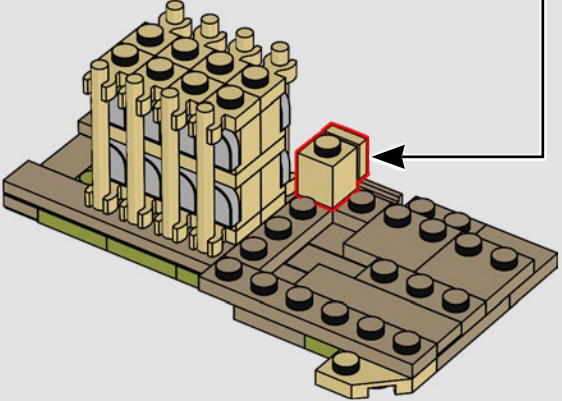
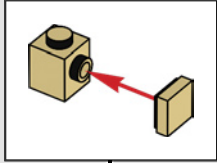

331

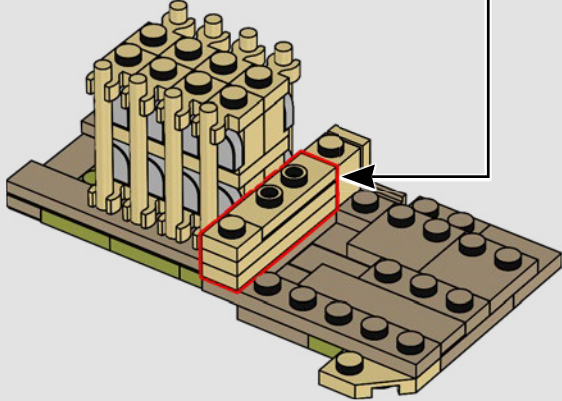
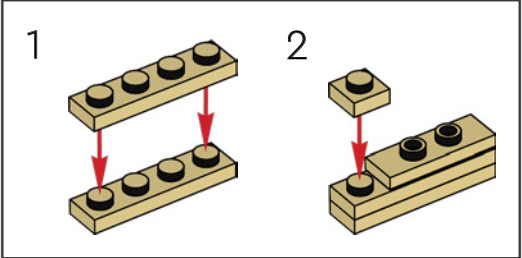

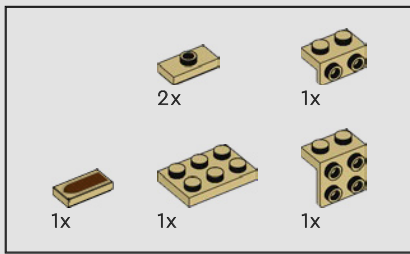

332

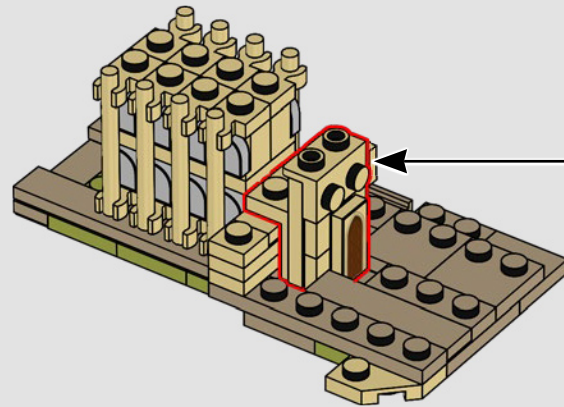
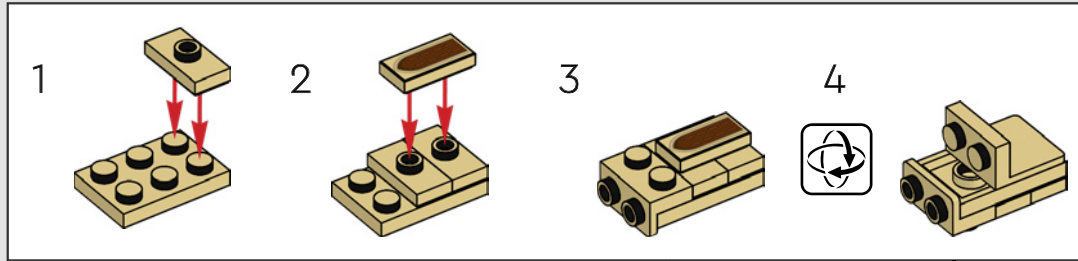

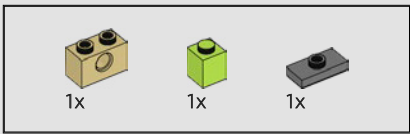

333

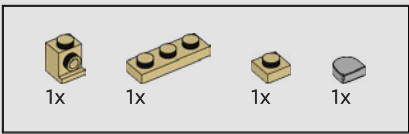
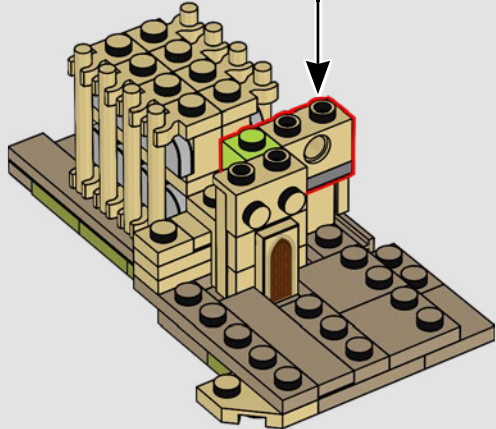
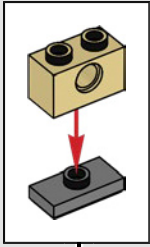

334

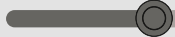
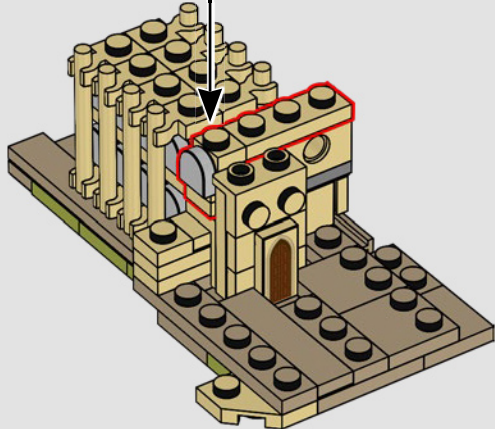
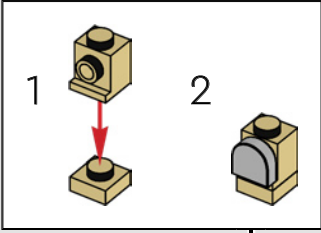



335

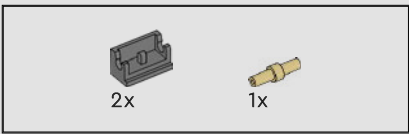
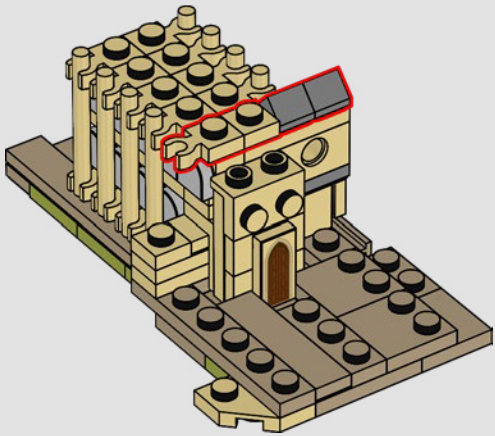

336

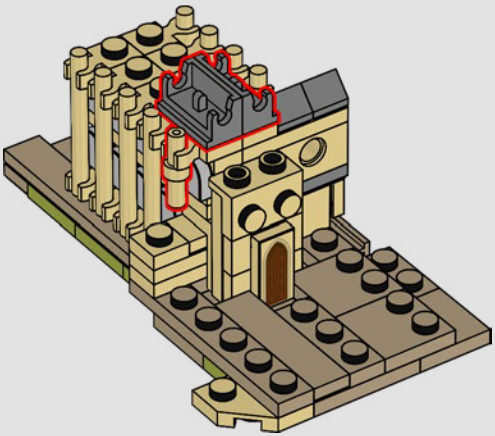

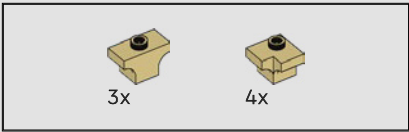

337

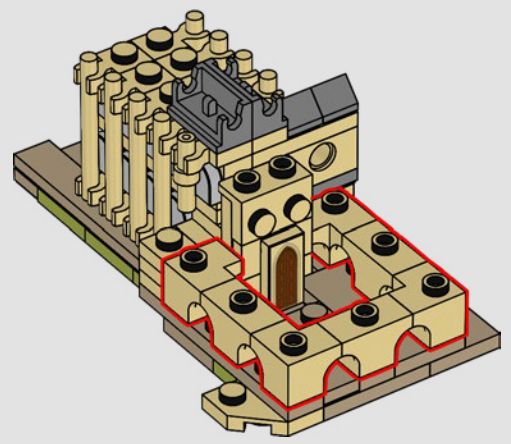

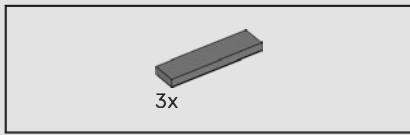

338

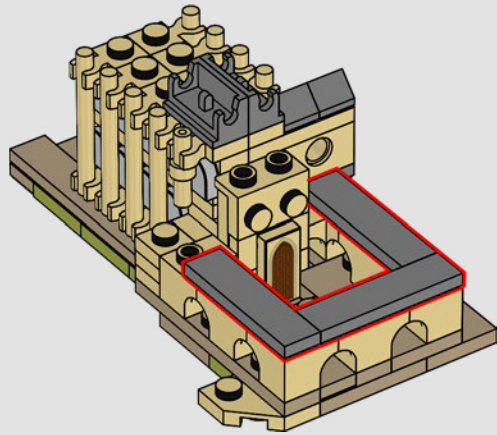

339

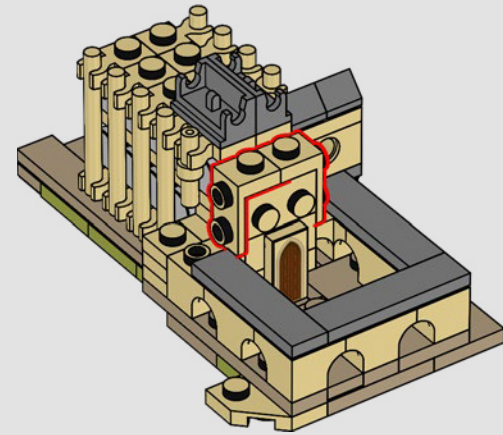



340

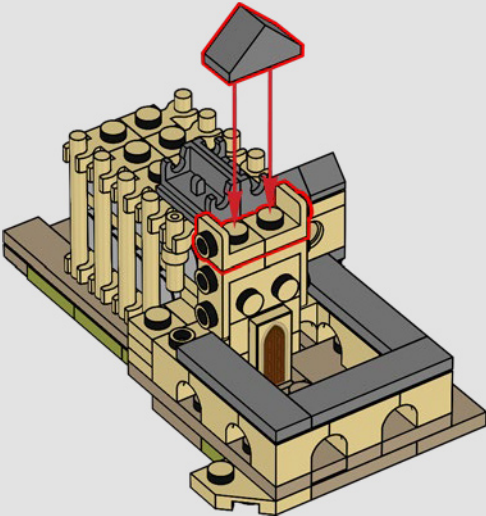

341

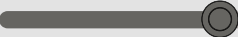
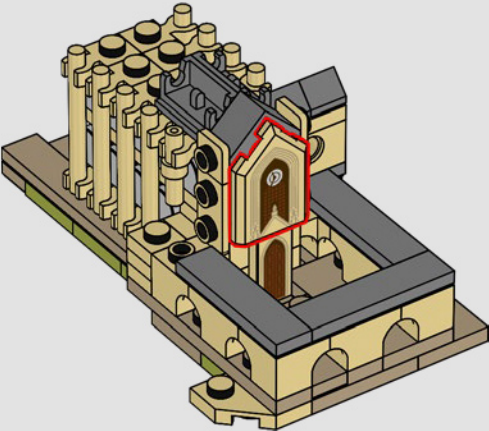



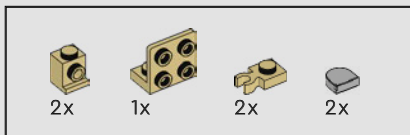

342

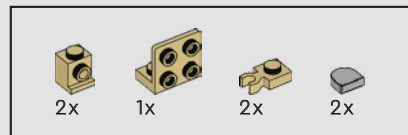
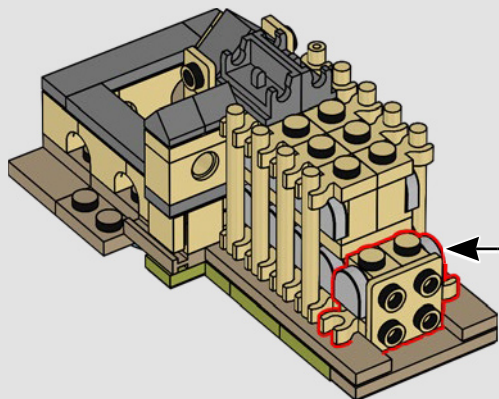
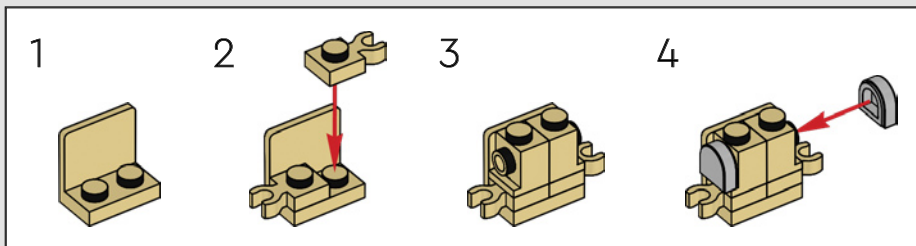

343

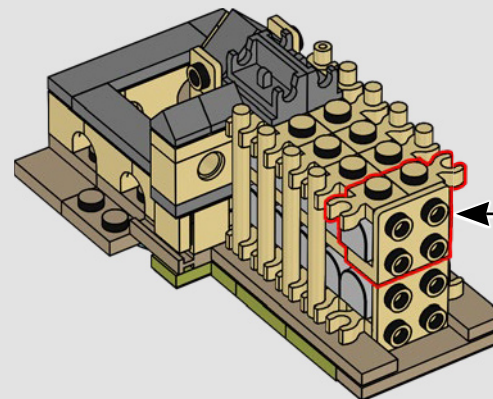
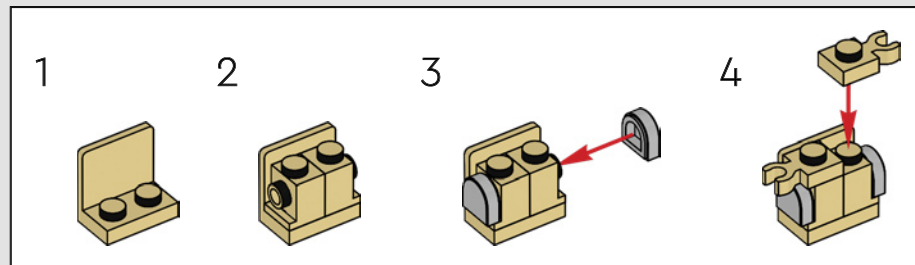

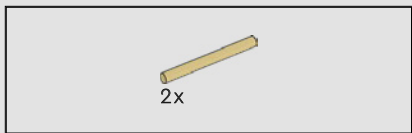

344

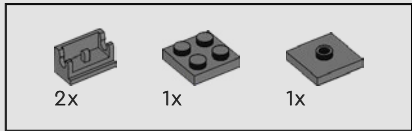
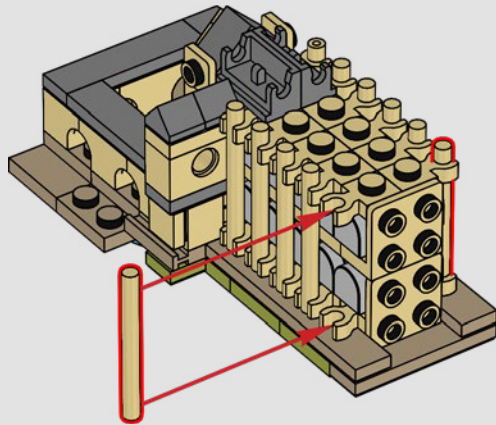

345

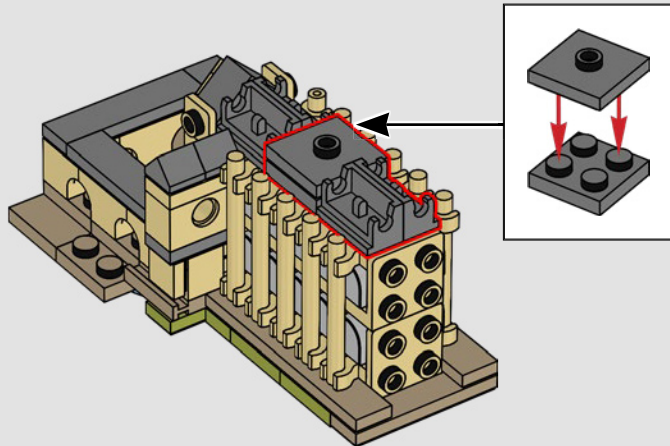

346

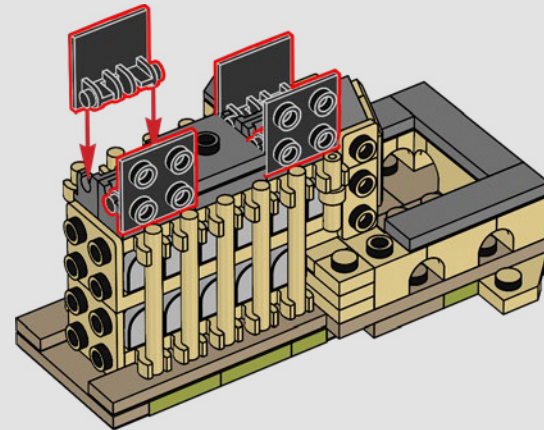

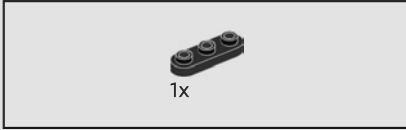
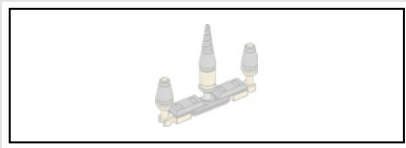

347

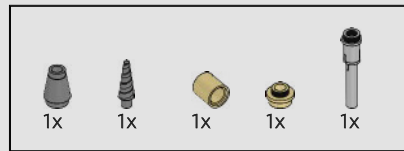

348

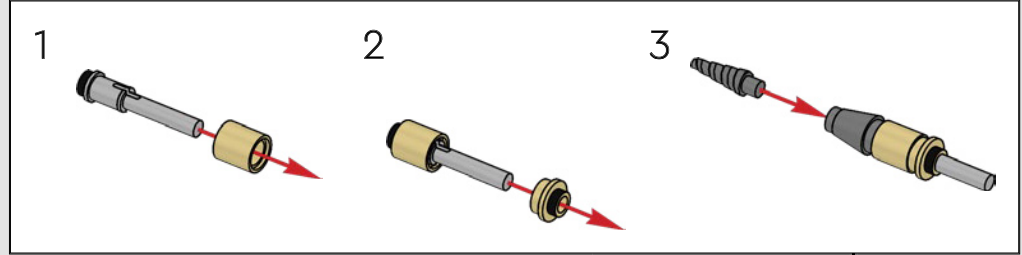



349

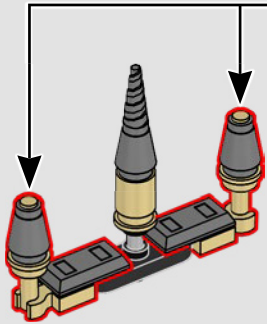
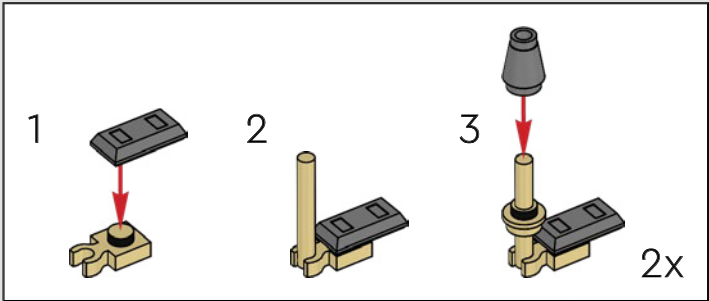

350

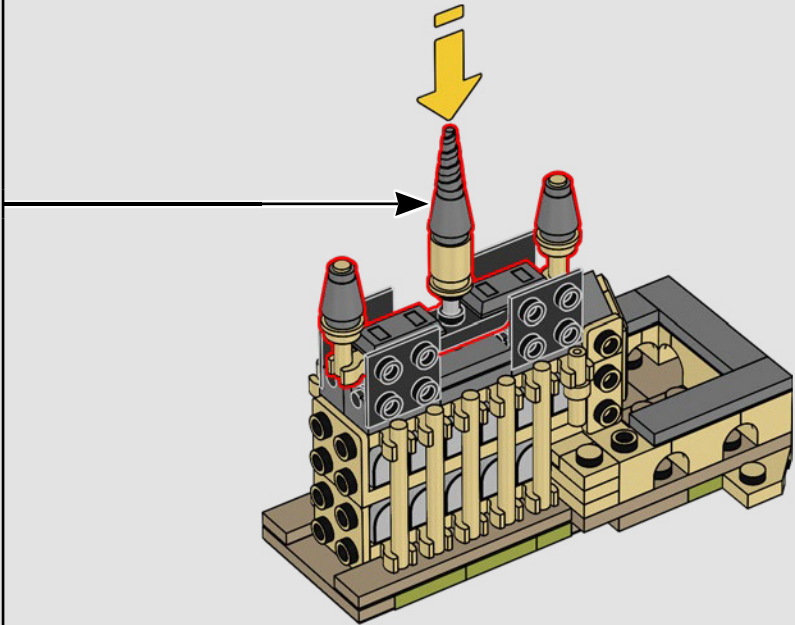

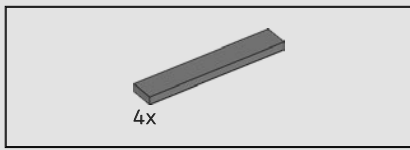

351

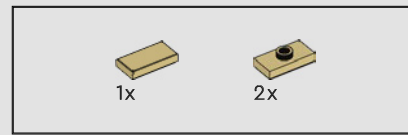
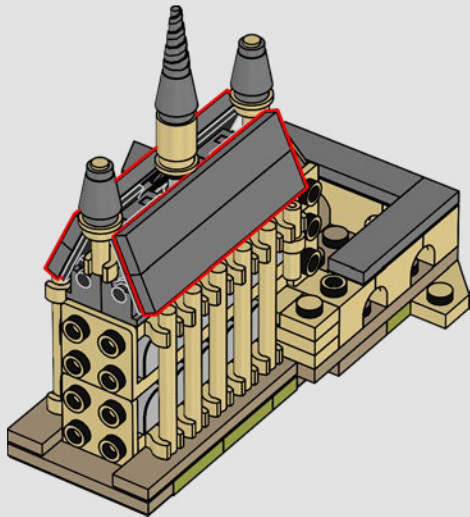

352

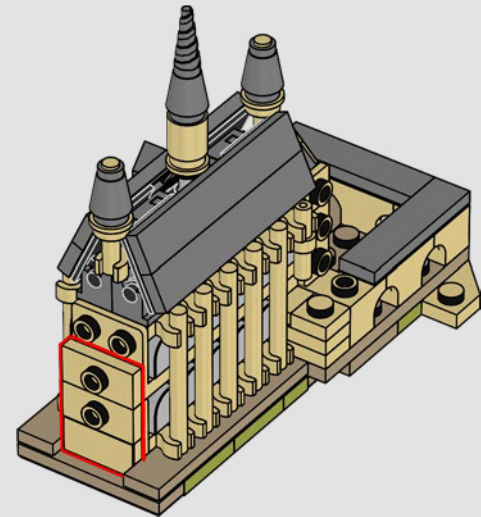

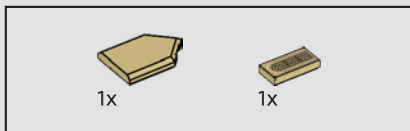

353

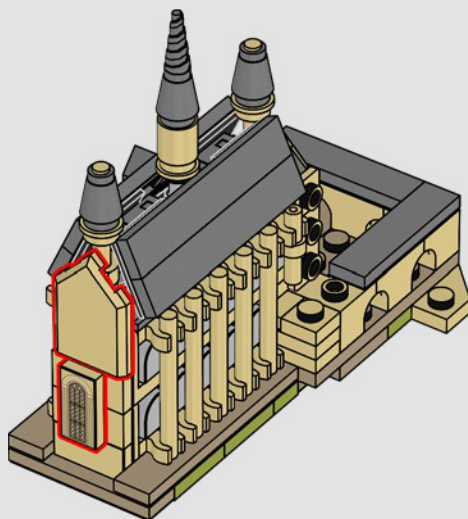

Il soffitto della Sala Grande può essere incantato per imitare il cielo notturno.

354

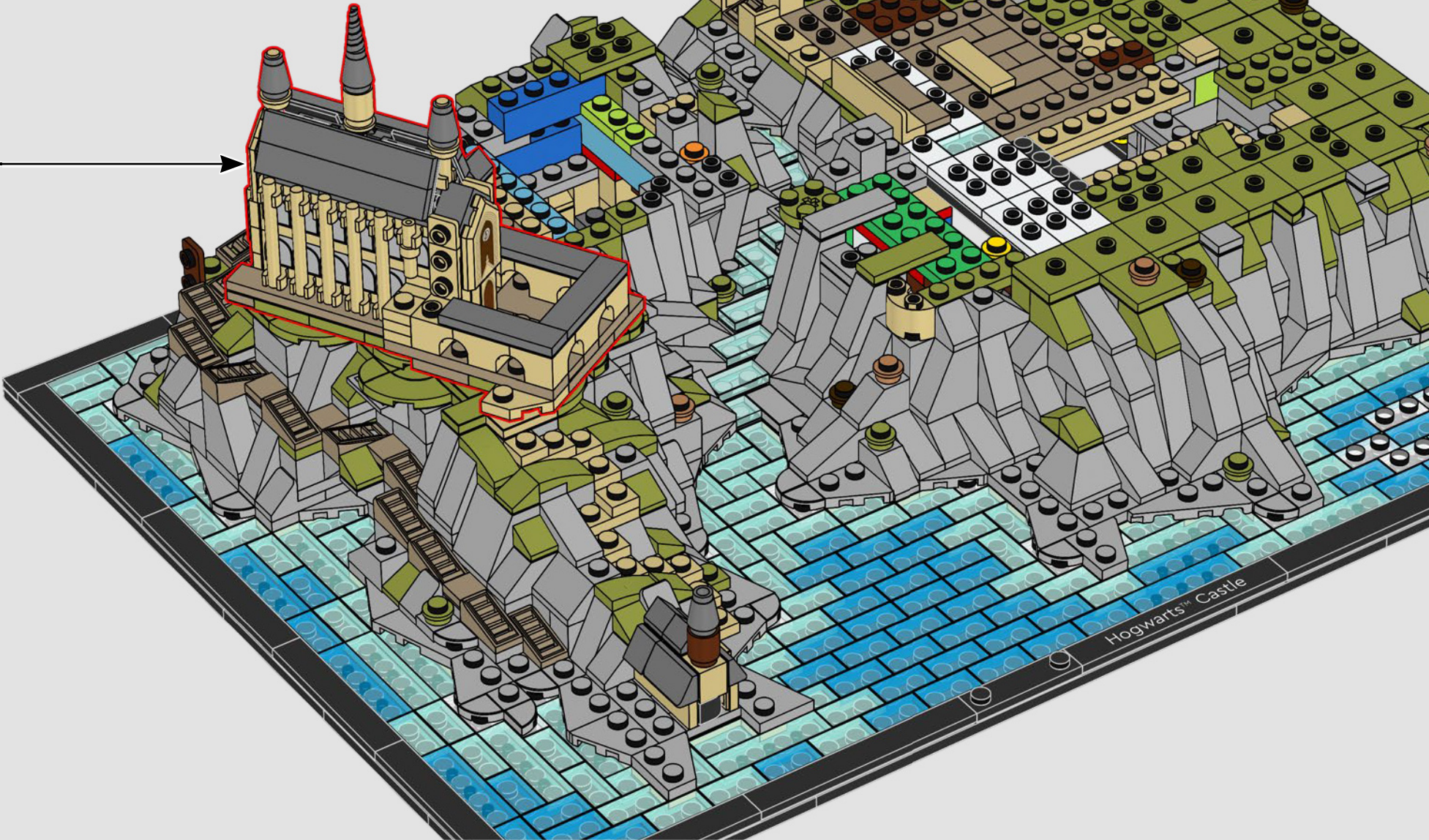

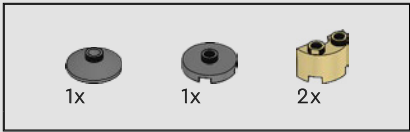

355

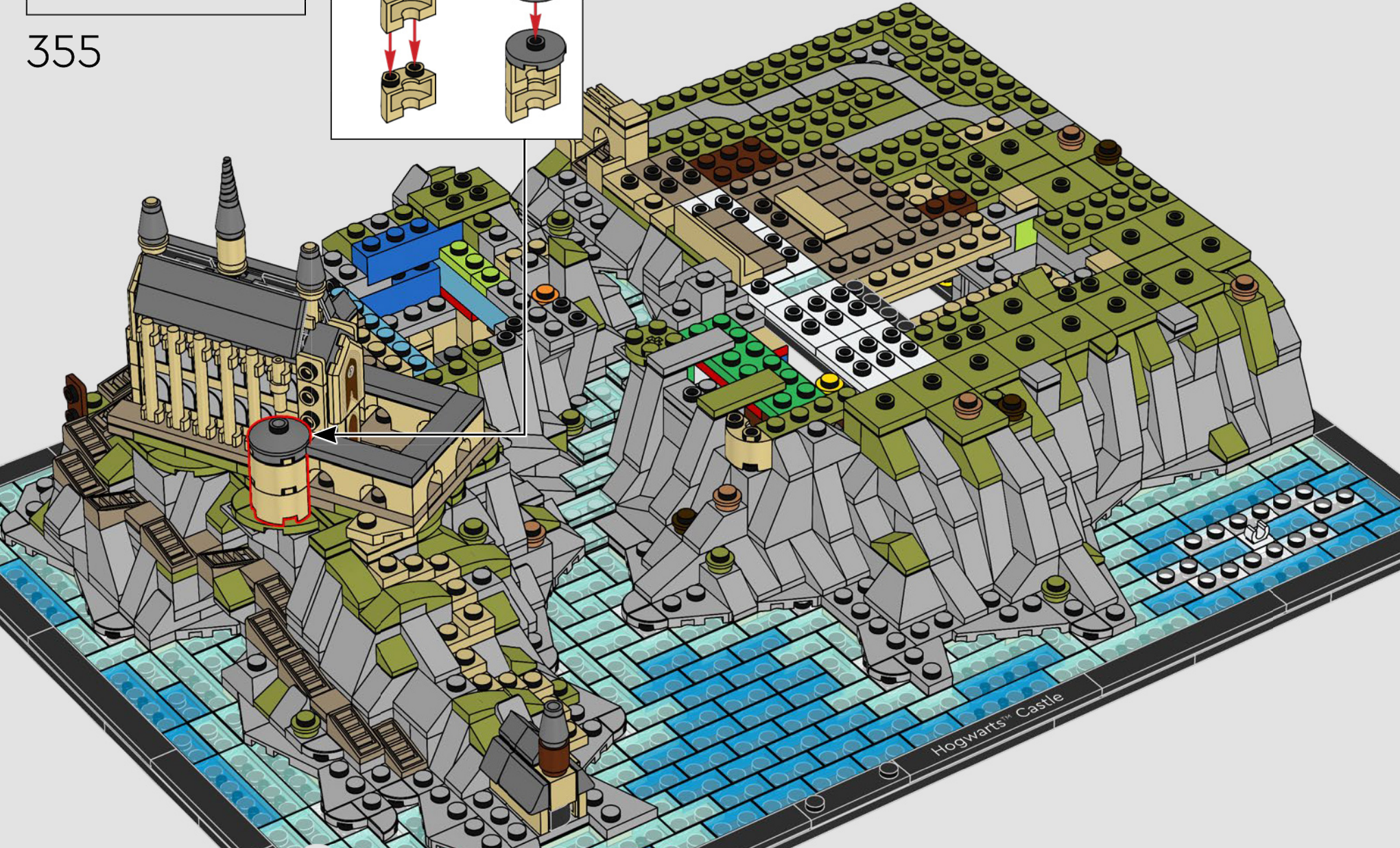
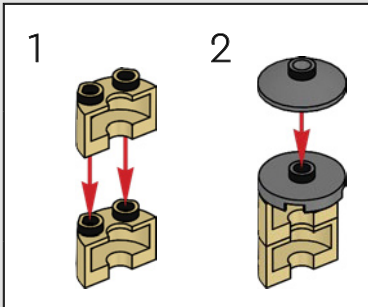



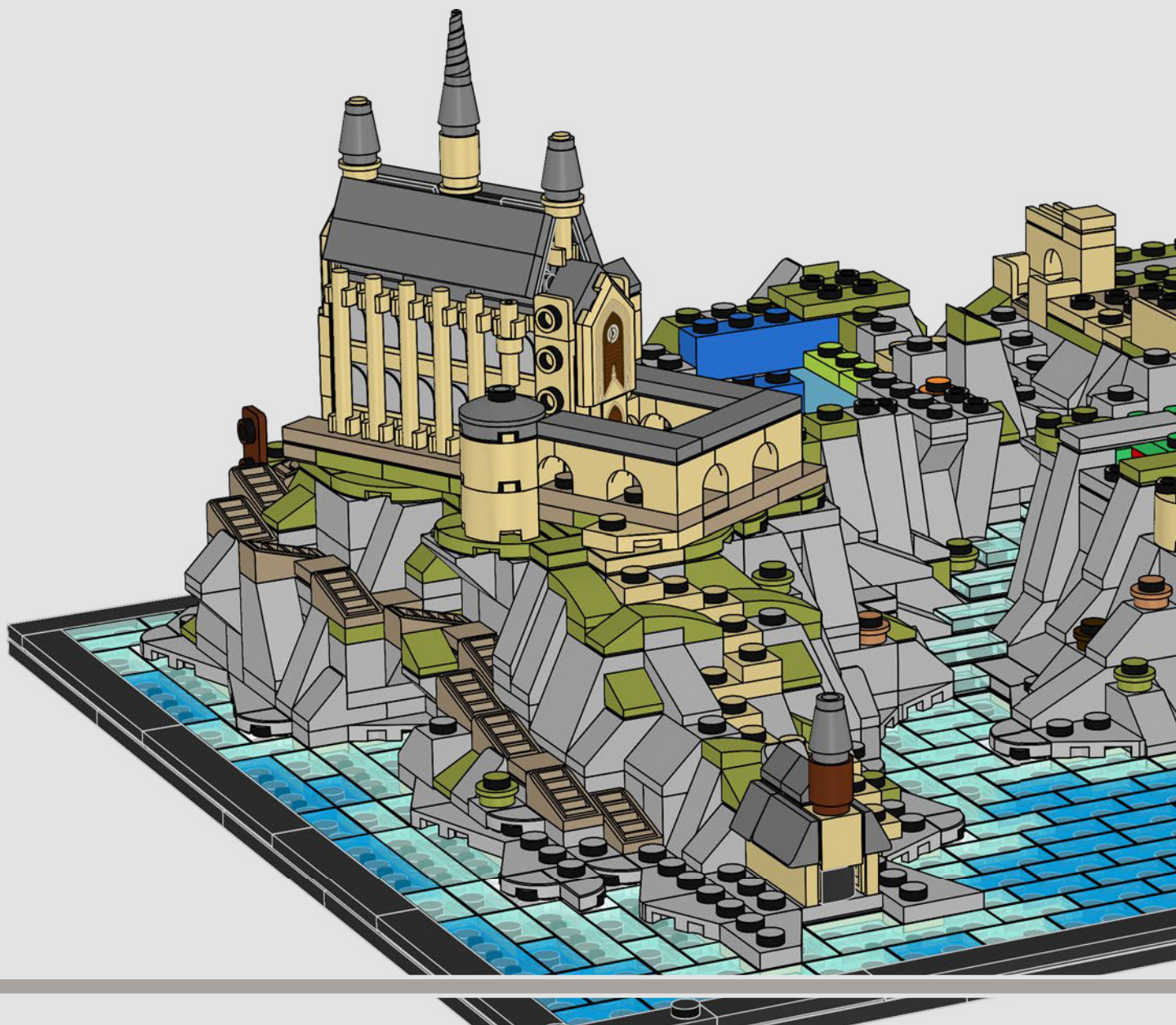

Subito dopo l'arrivo a Hogwarts™, gli studenti del primo anno vengono accompagnati nella Sala Grande dove il Cappello Parlante stabilisce quale sarà la loro casa.



356



Gli alberi sono costruiti con elementi di cristallo e gelato LEGO® (e un po' di magia).

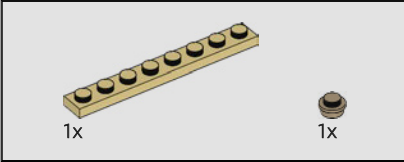
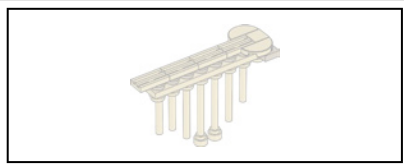

357

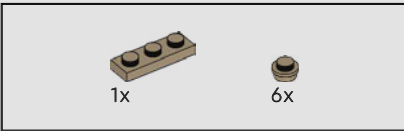
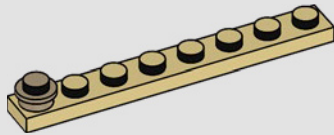

358

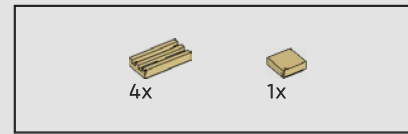
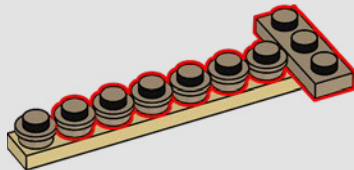

359

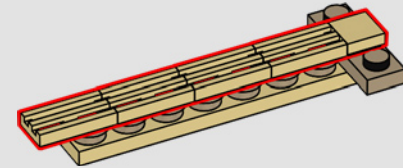

360

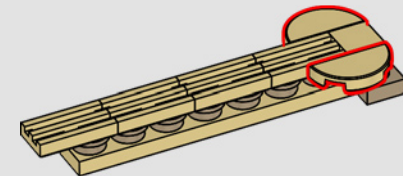

8x

361

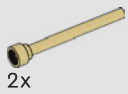
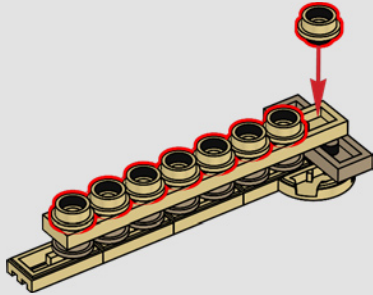

2x

362

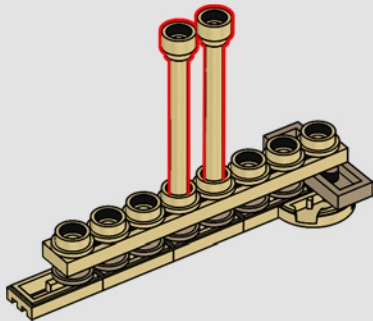

2x

3x

363

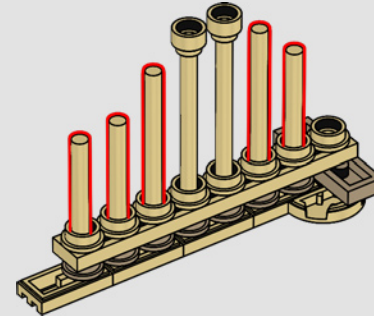

364



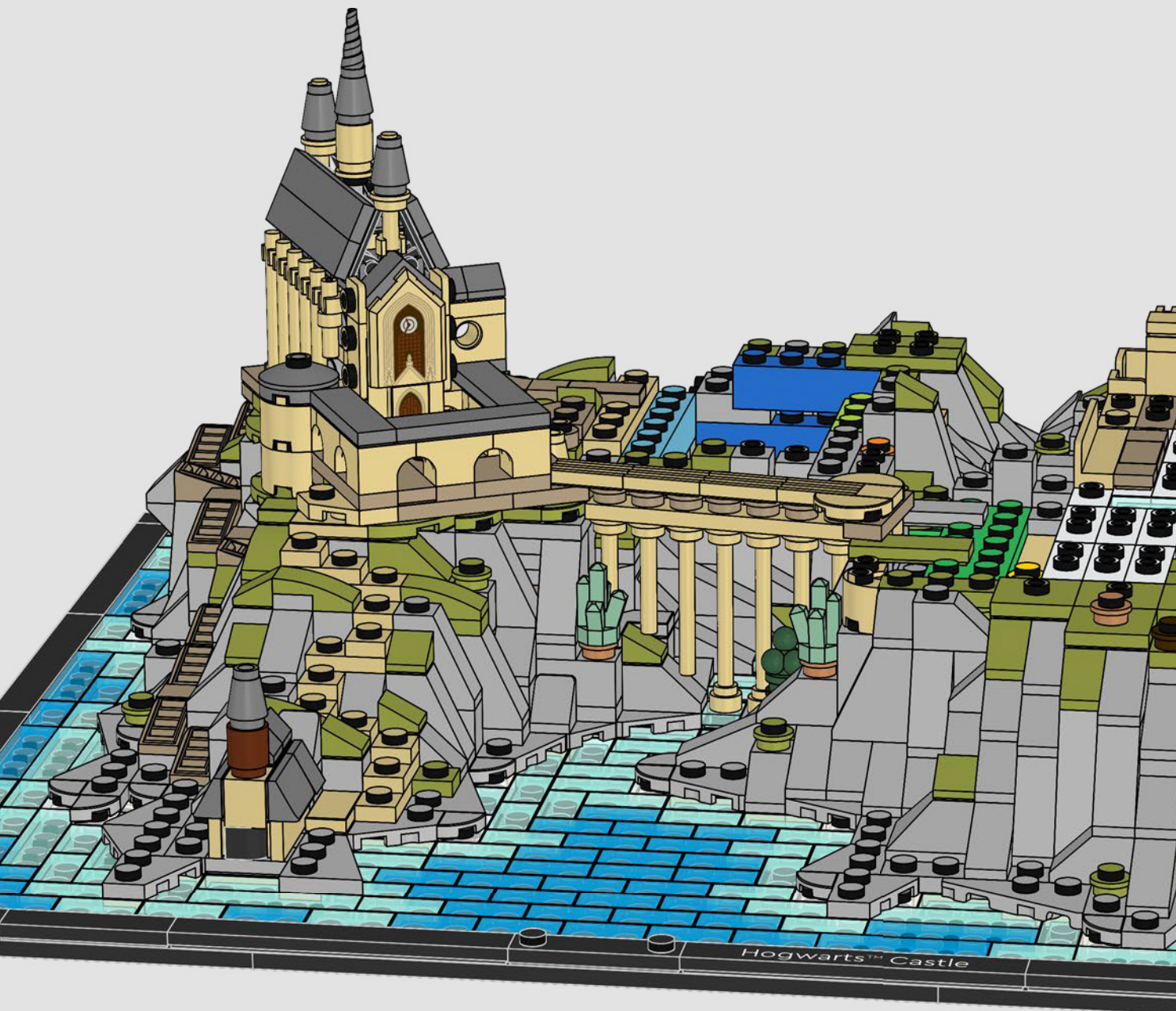

Il Viadotto non è solo una parte riconoscibilissima della silhouette di Hogwarts™, ma è anche una delle ambientazioni più importanti della Battaglia di Hogwarts: per esempio, quando la Professoressa McGonagall utilizza un incantesimo per animare le armature vuote perché facciano il loro dovere per la scuola, esse si dirigono immediatamente verso il Viadotto. Riveste anche un ruolo chiave durante la prima prova del Torneo Tremaghi, quando l'Ungaro Spinato vola sotto di esso all'inseguimento di Harry.





365







2x

366

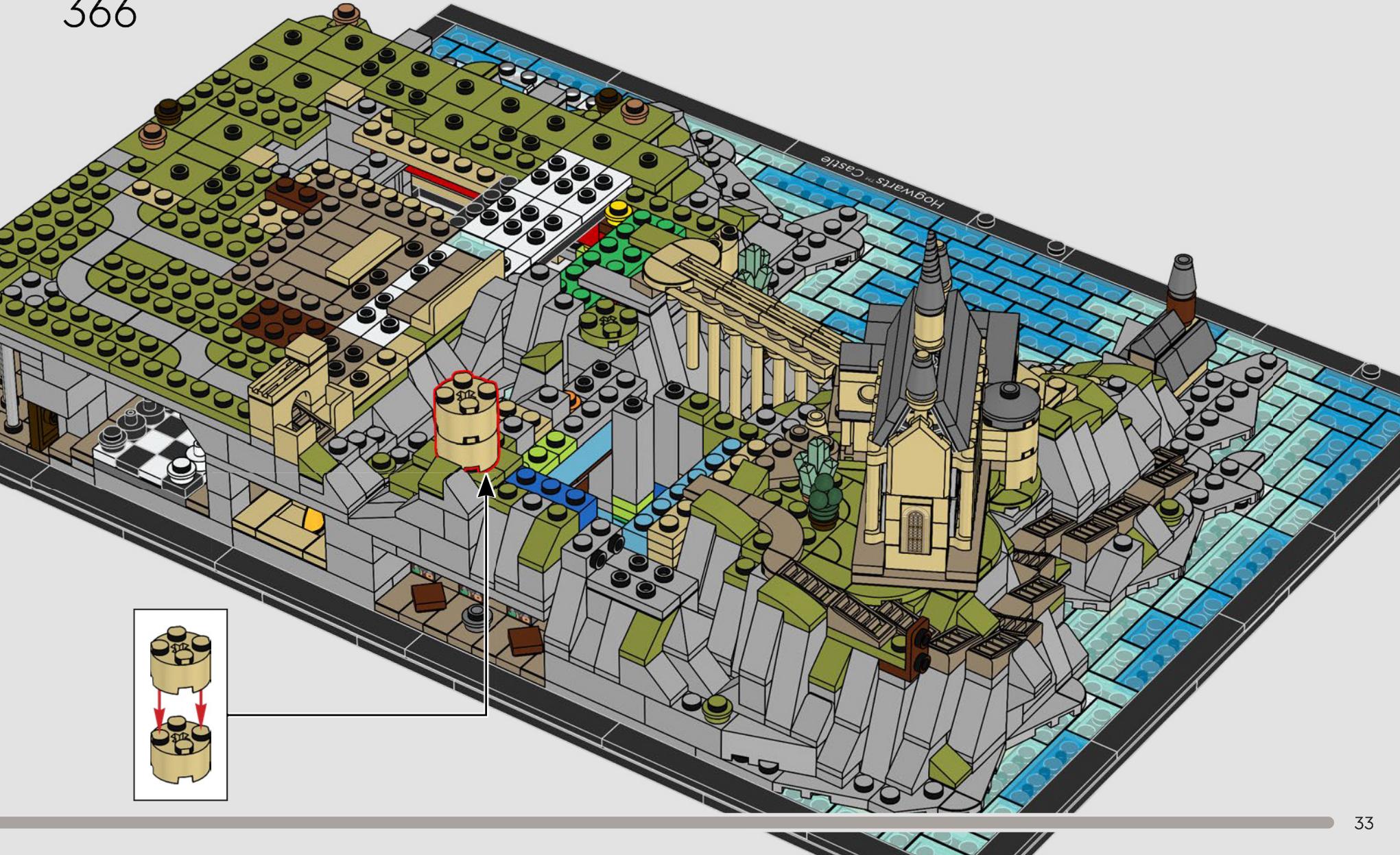

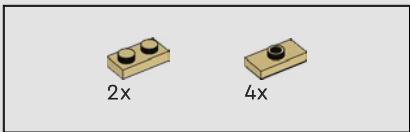

367

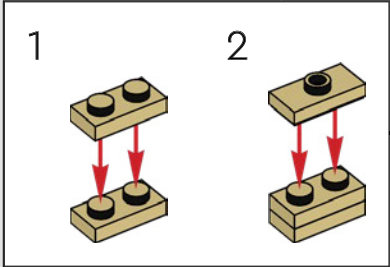
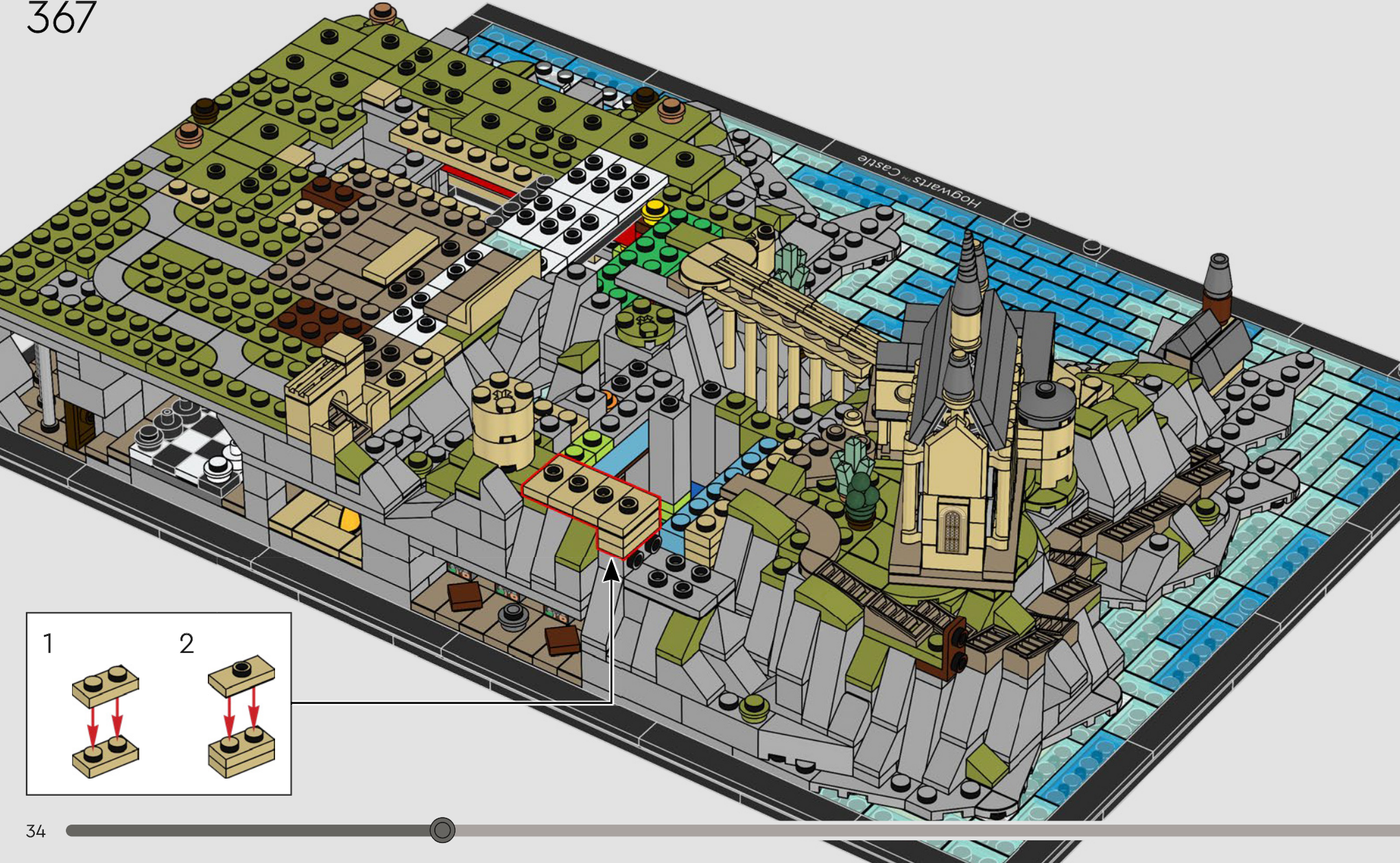

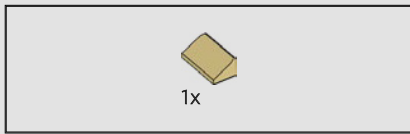

368

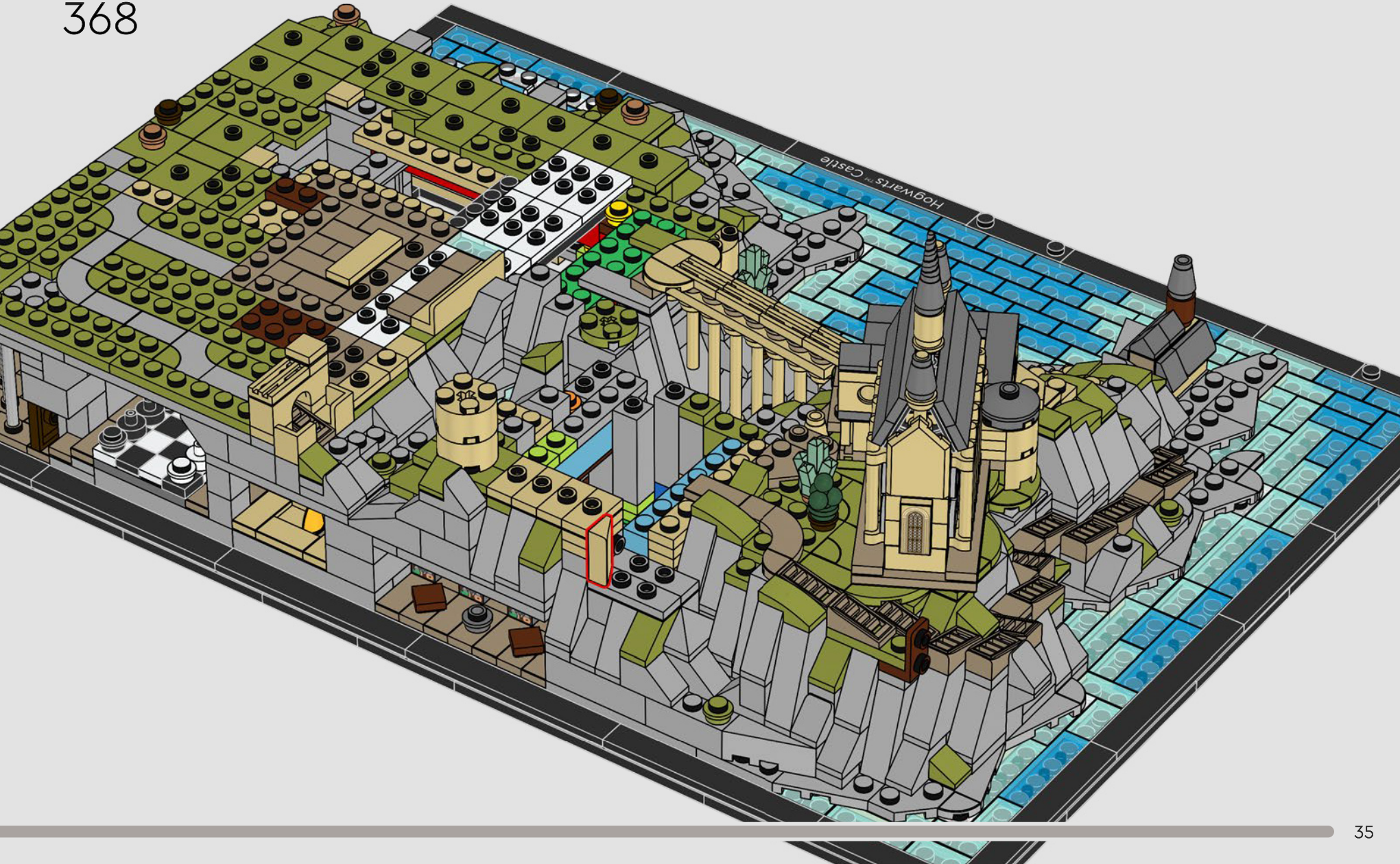

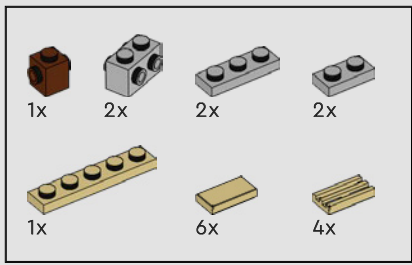

369

1

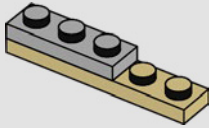

2

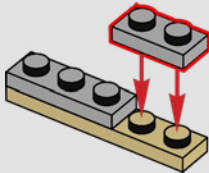

3

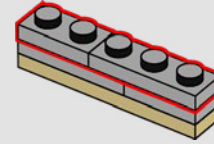

4

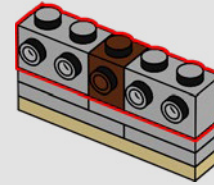

5

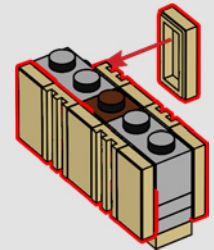

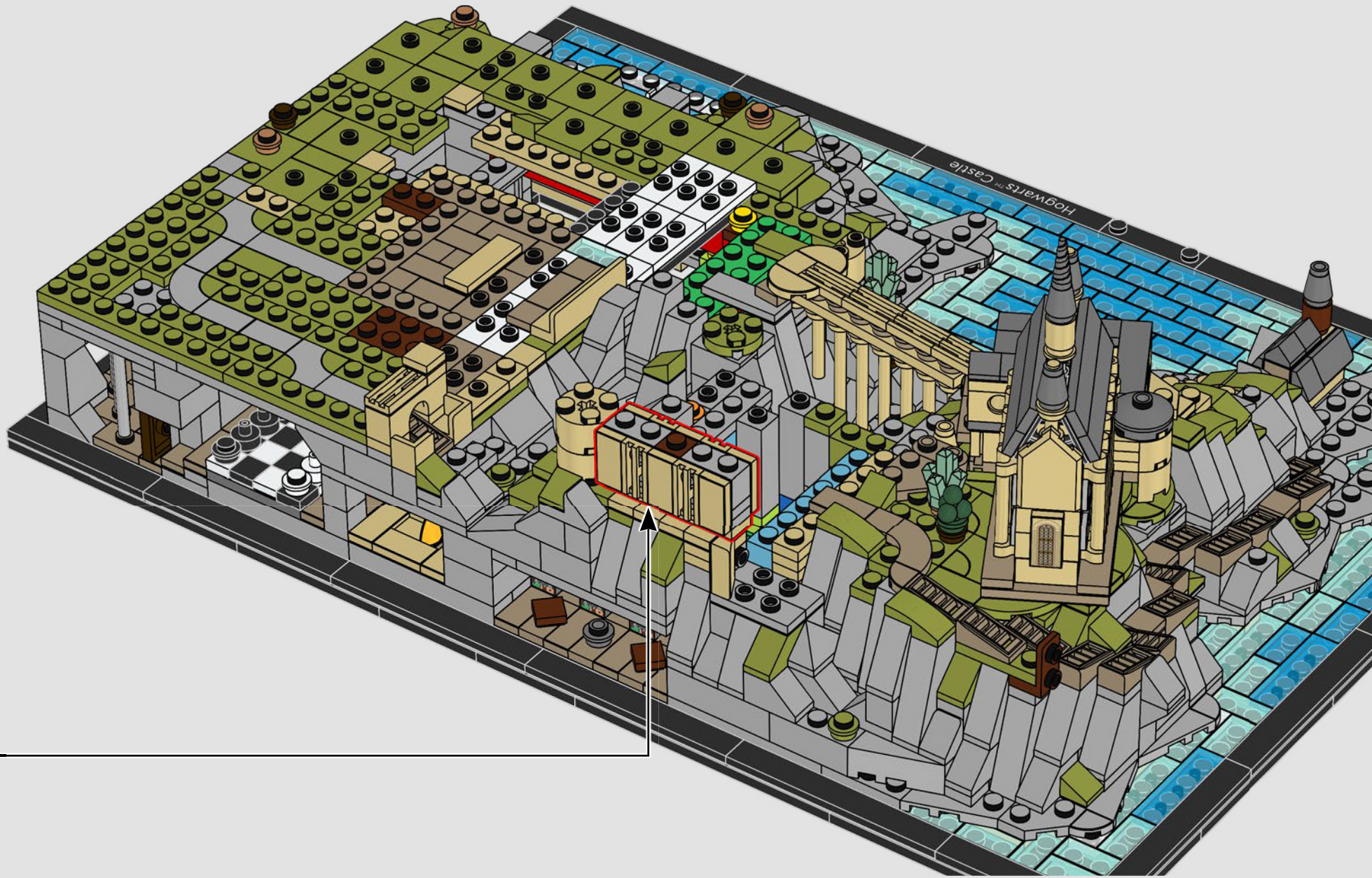

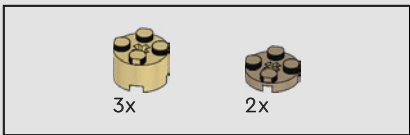

370

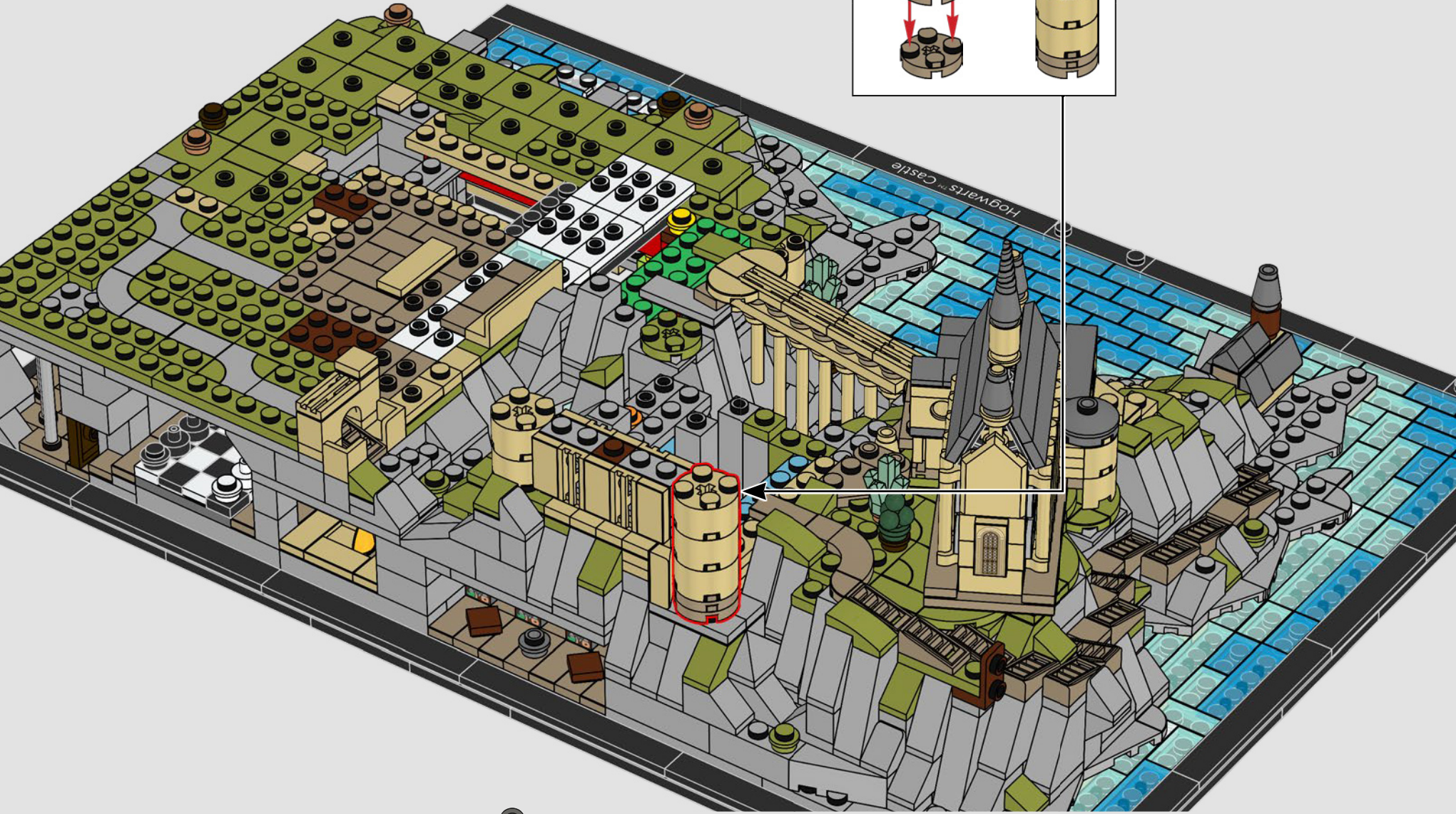
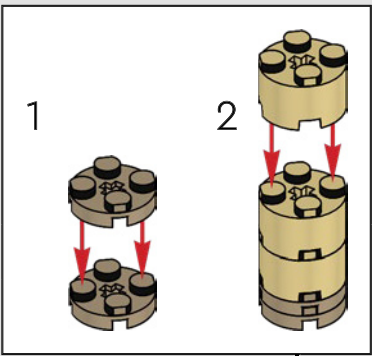

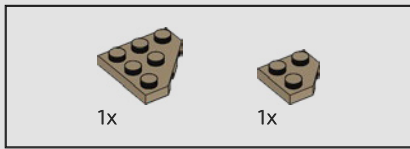

371

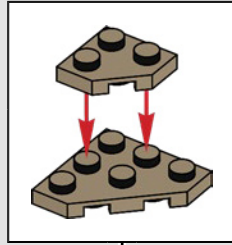

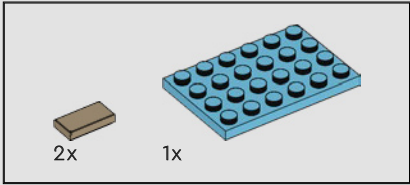
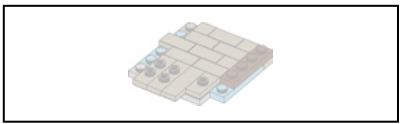

372

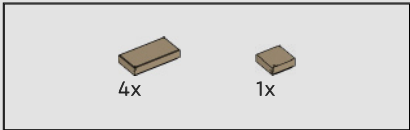
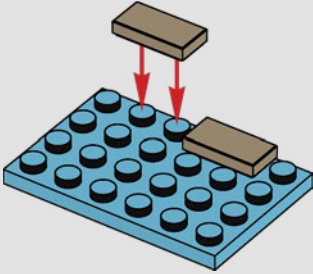

373

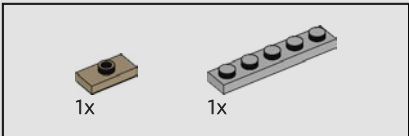
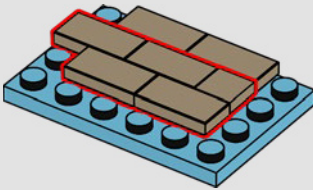

374

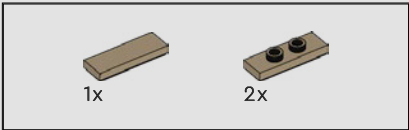
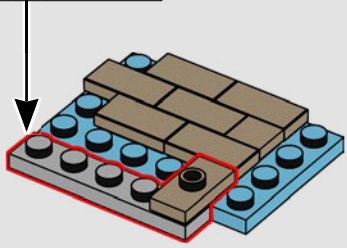
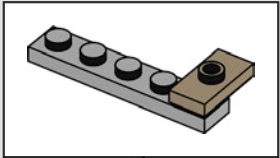

375

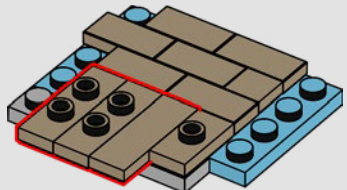



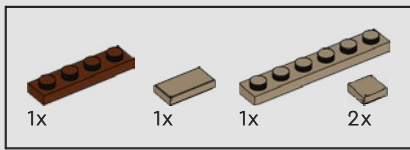

376

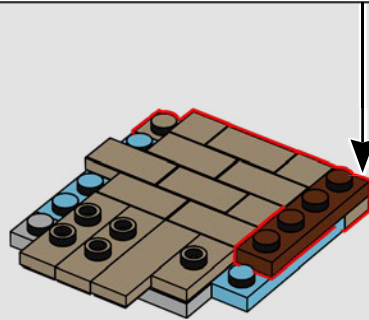
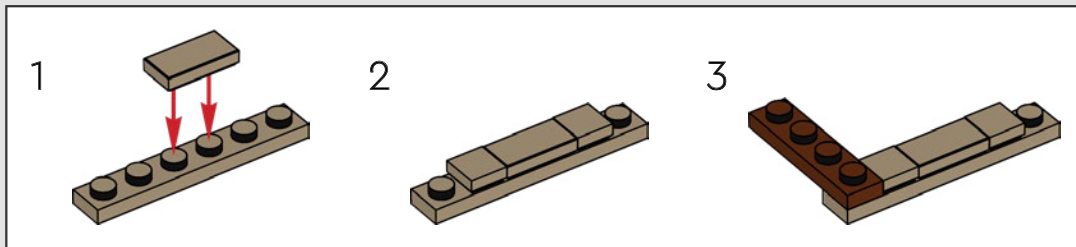

377



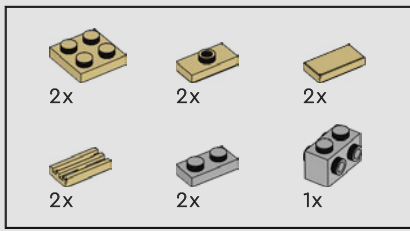

378

1

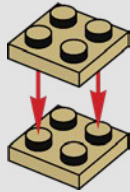

2

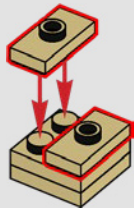

3

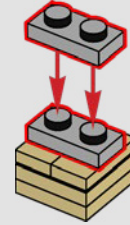

4

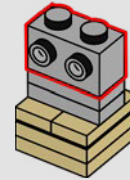

5

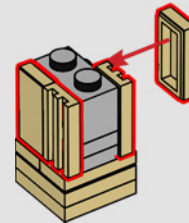



Hogwarts™ Castle

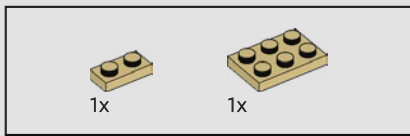

379

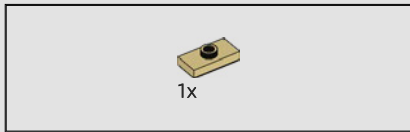
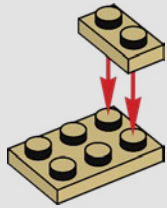

380

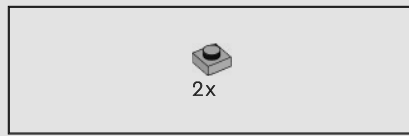
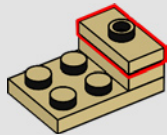

381

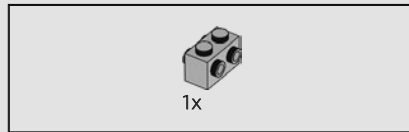
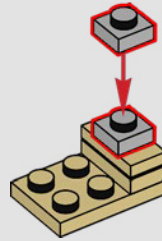

382

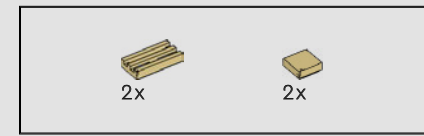
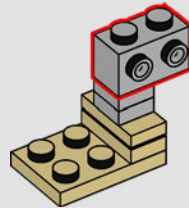

383

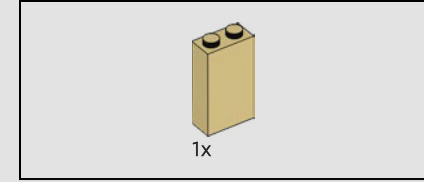
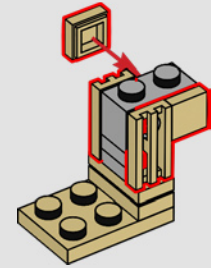

384

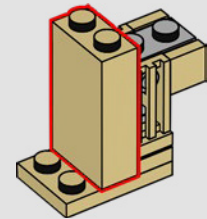

385

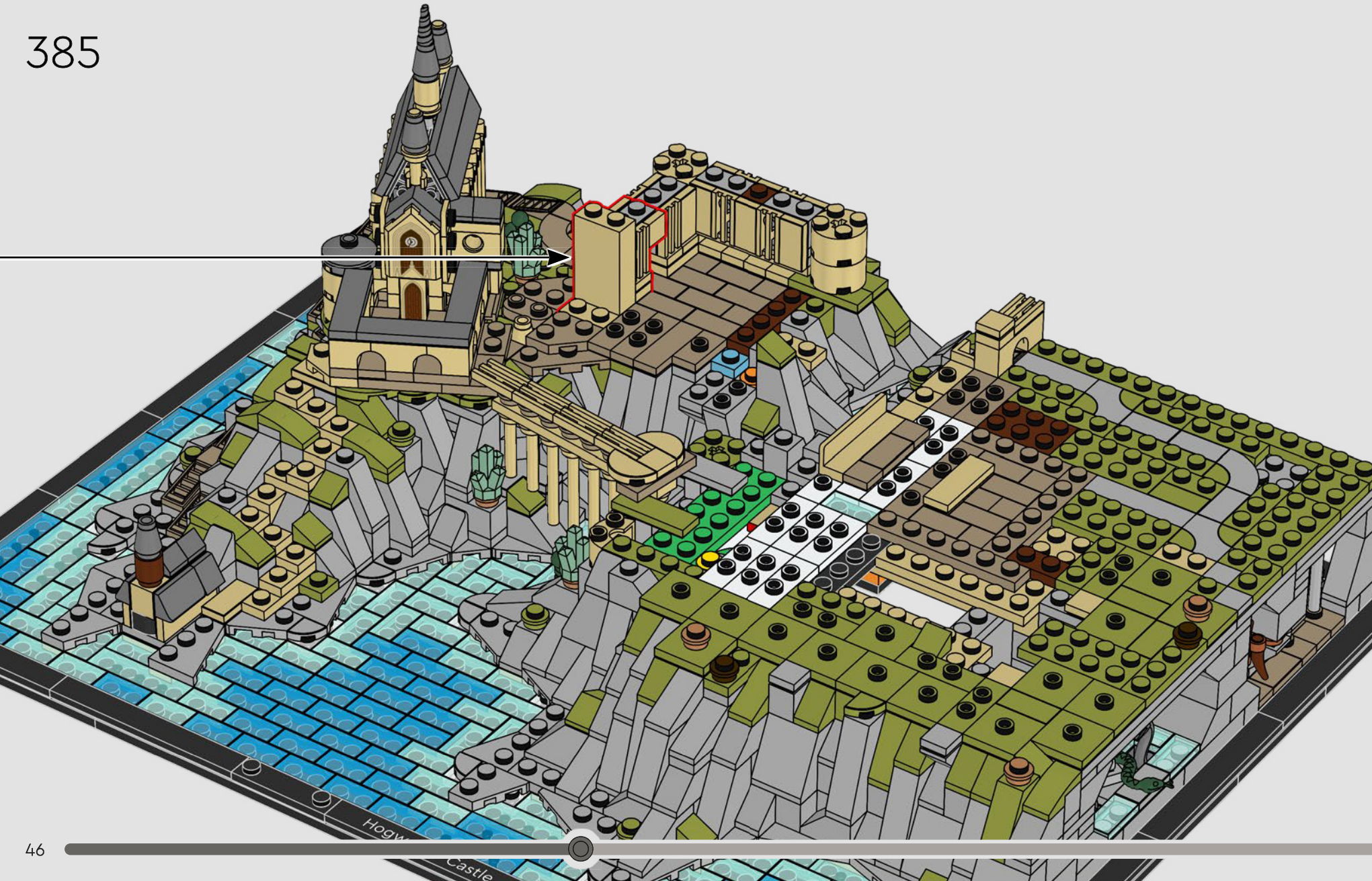

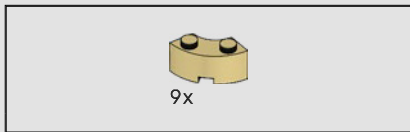

386

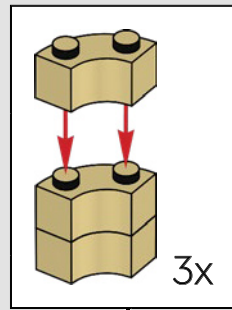

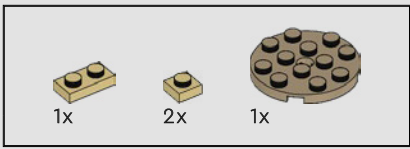

387

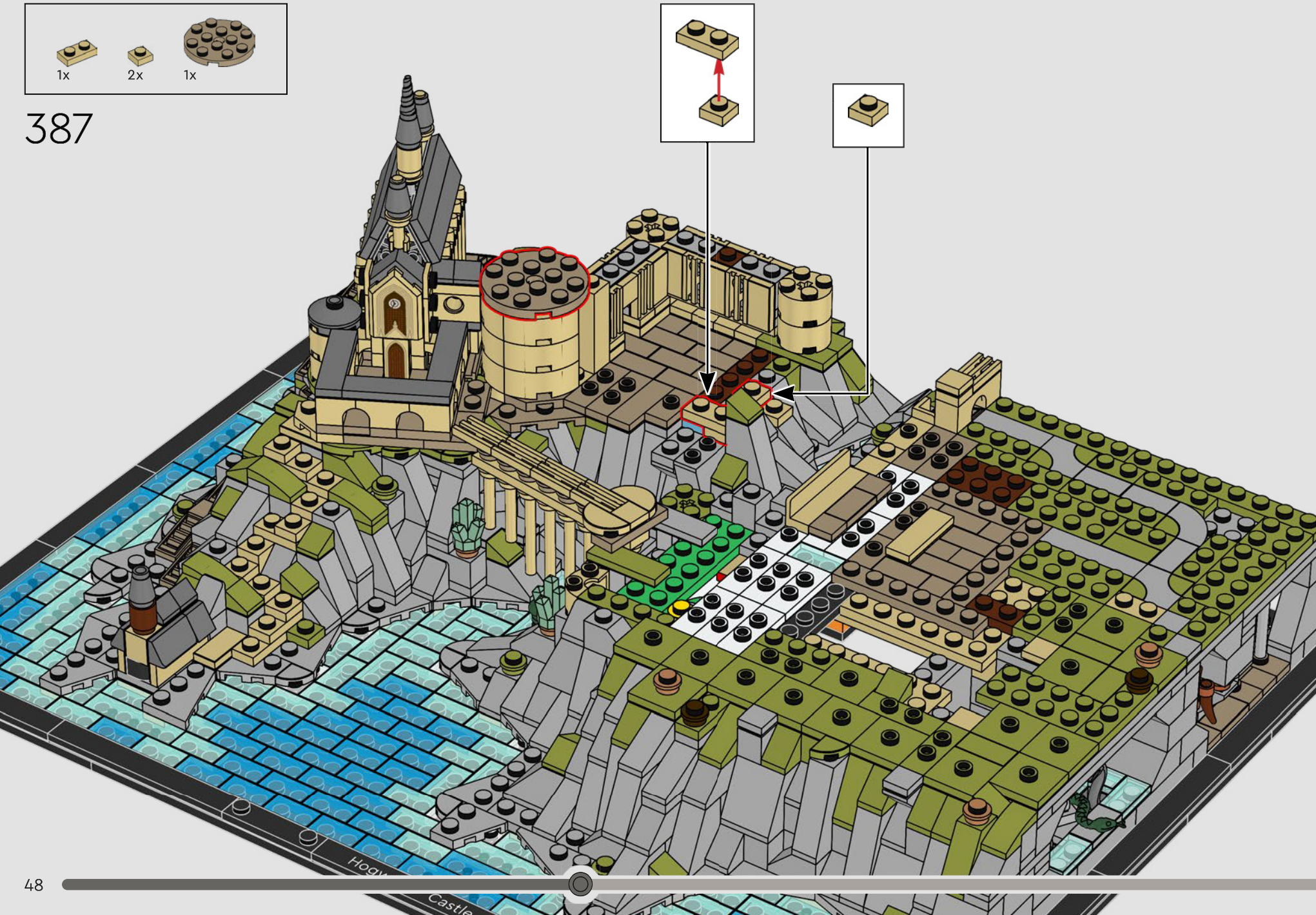
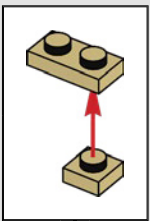



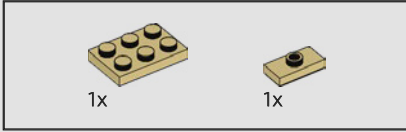
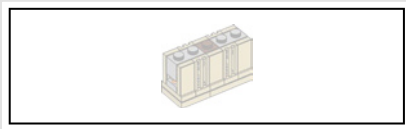

388

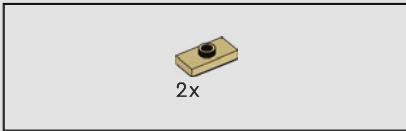
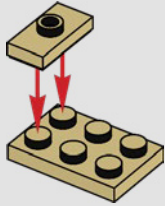

389

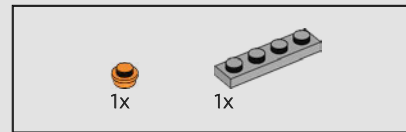
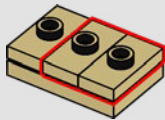

390

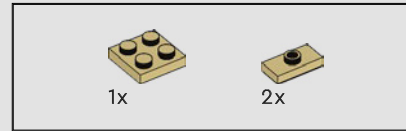
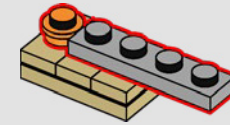

391

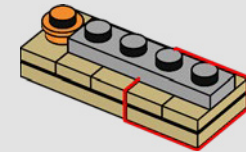
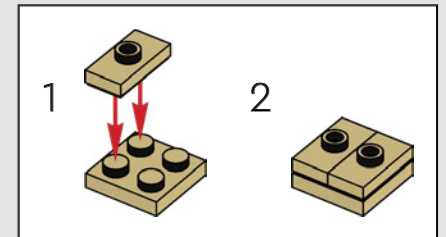

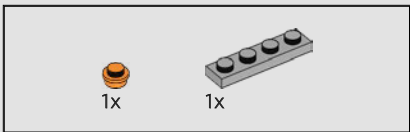

392

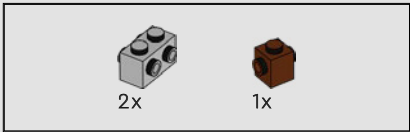
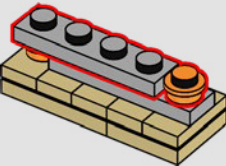

393

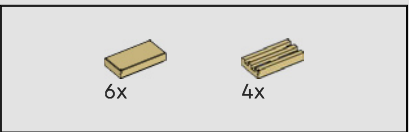
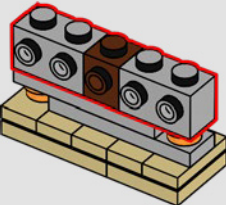

394

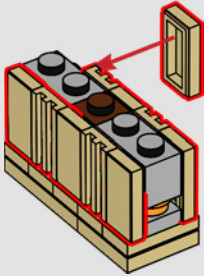

395

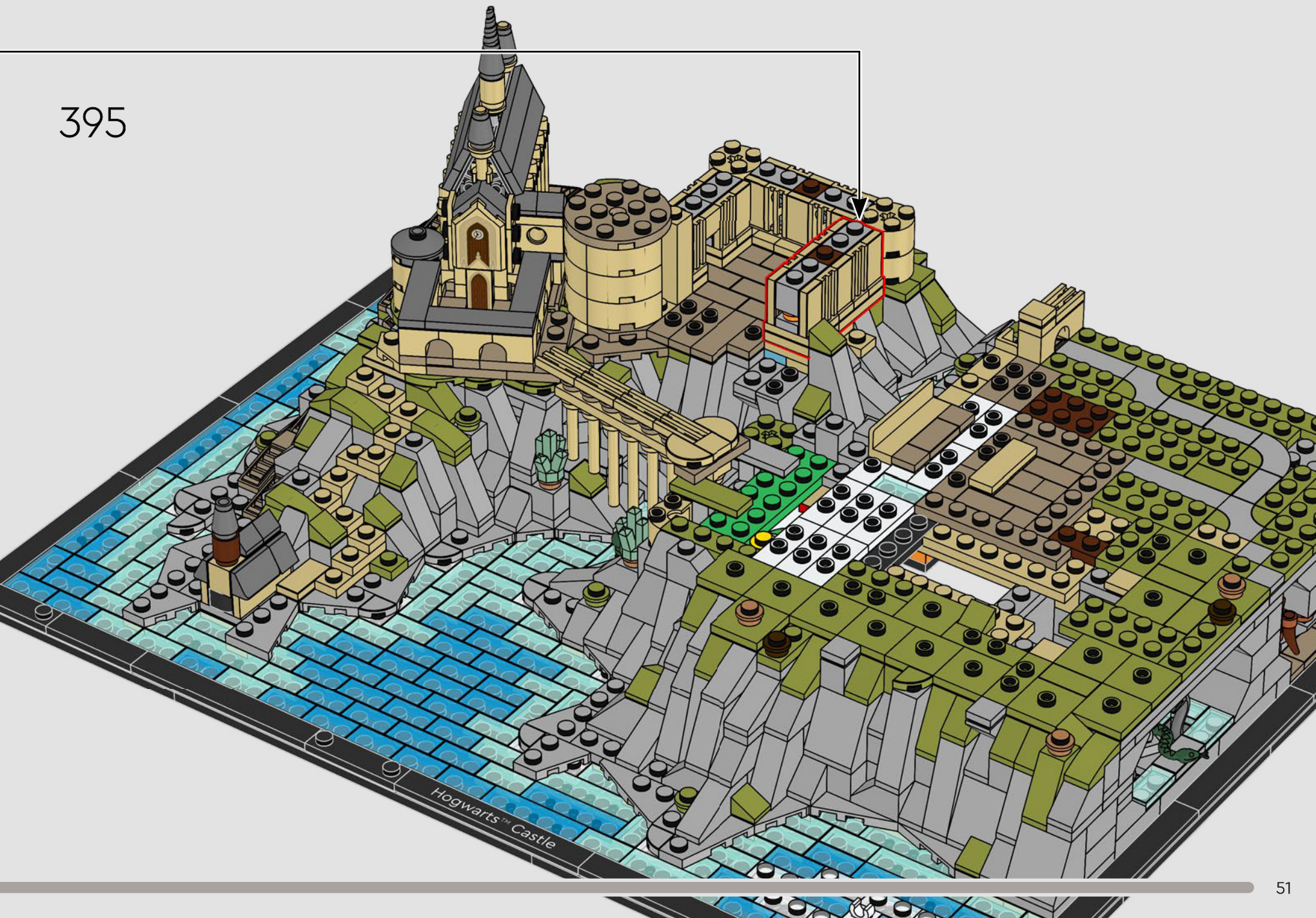

Hogwarts™ Castle

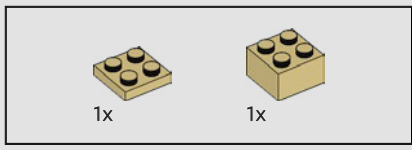

396

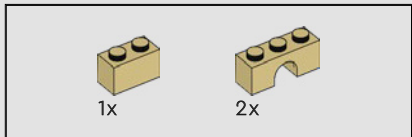
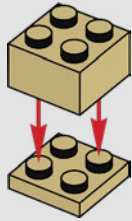

397

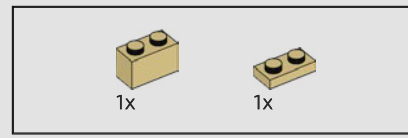
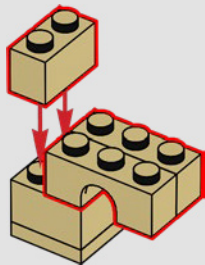

398

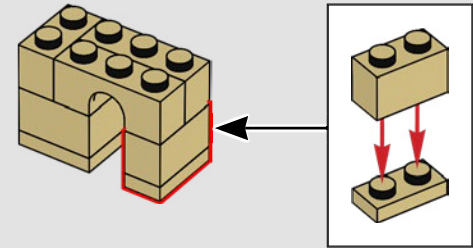

399

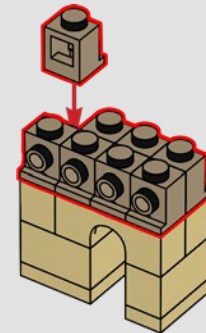

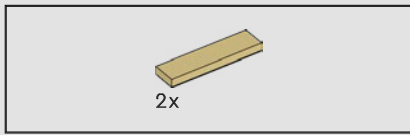

400

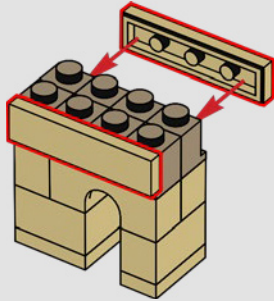

401

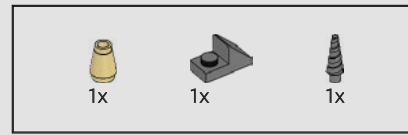
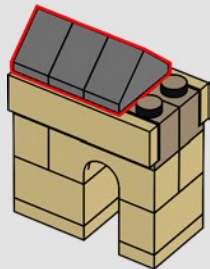

402

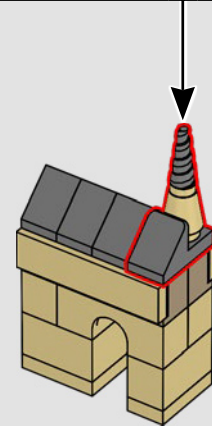
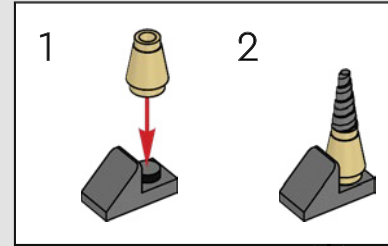

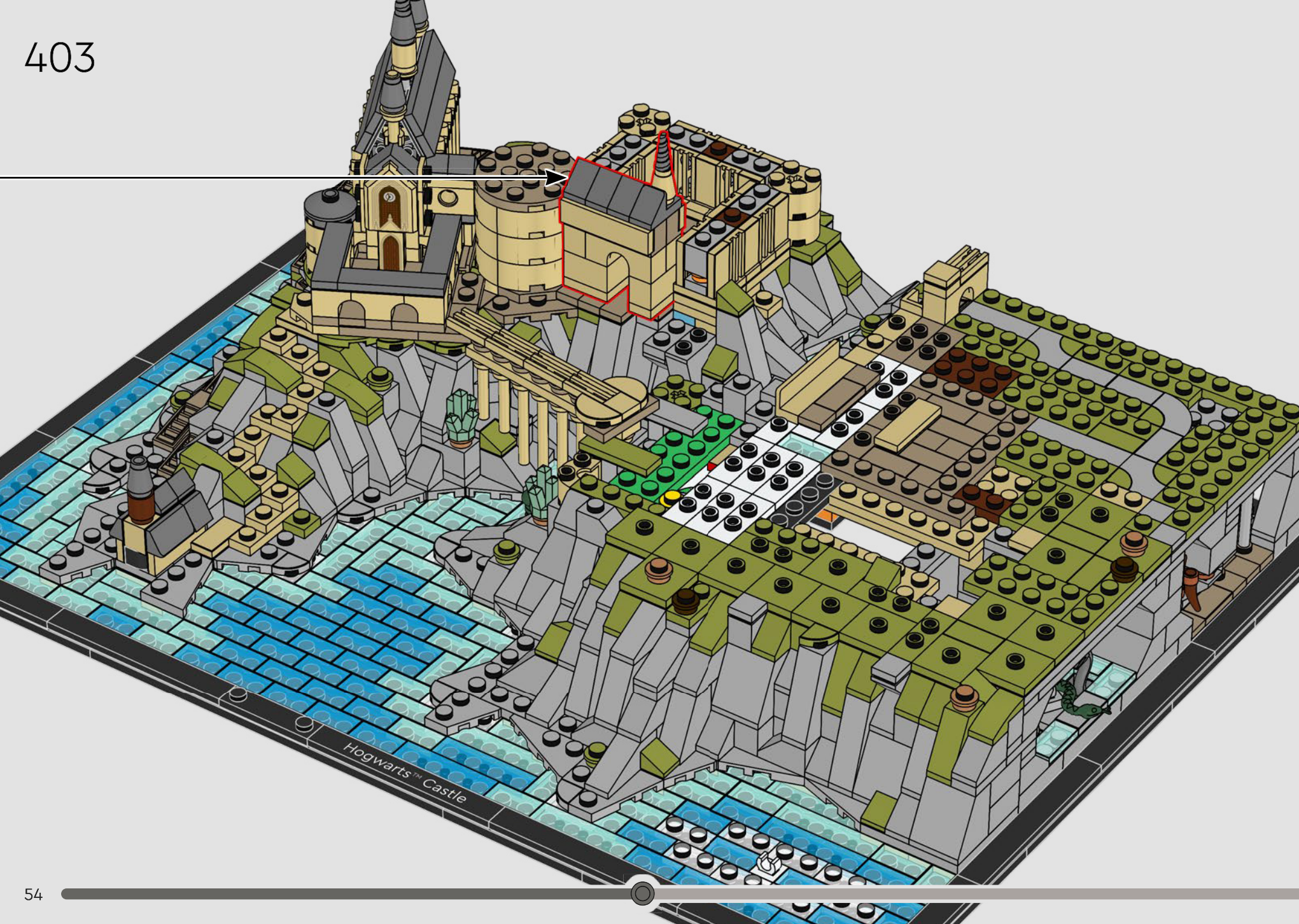

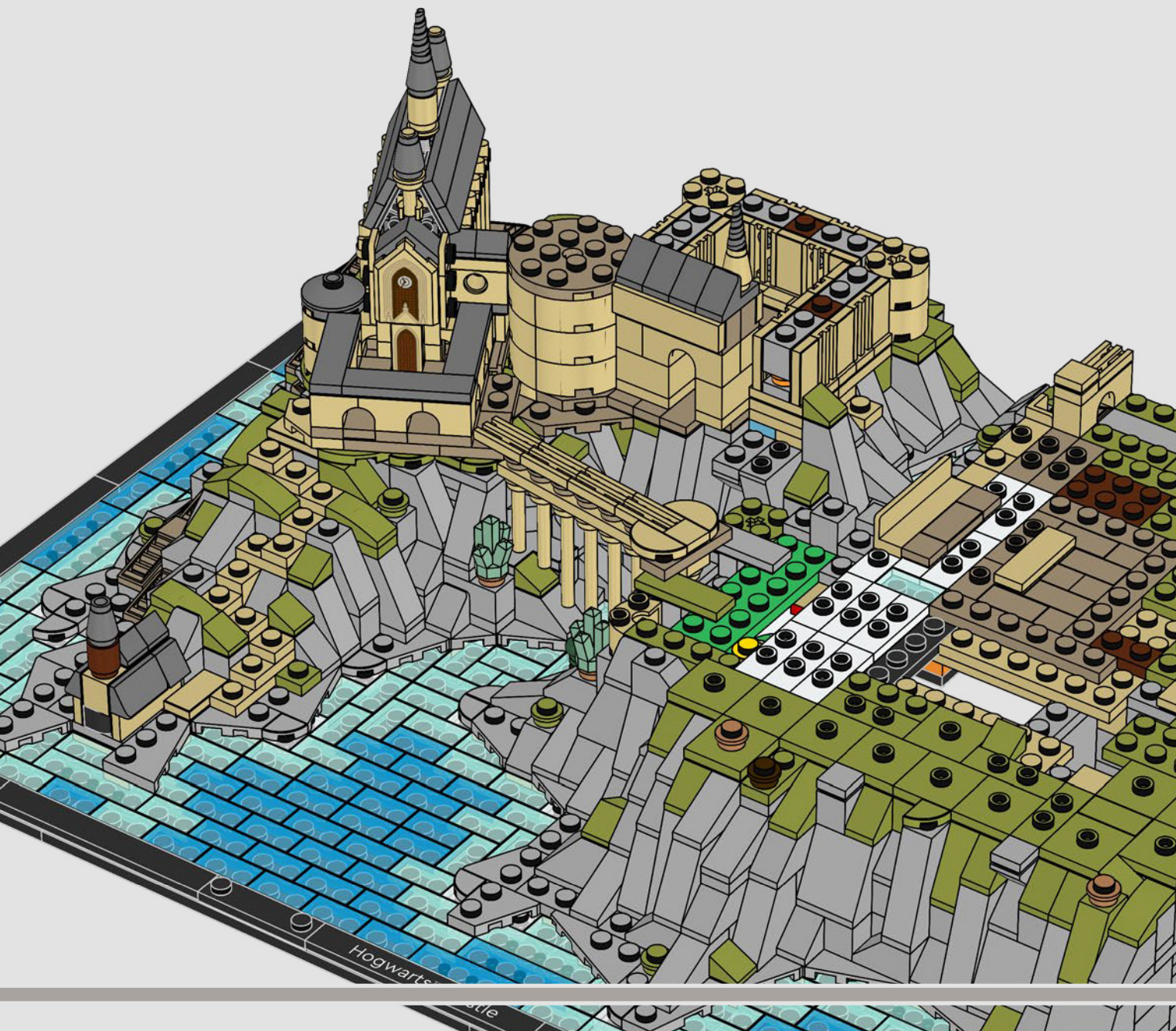

Il Cortile Lastricato è uno spazio di incontro all'aperto per gli studenti situato vicino alla Torre dell'Orologio.

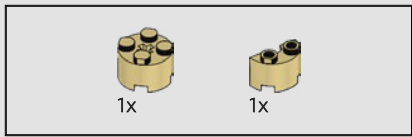

404

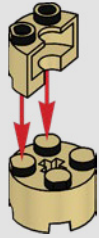

405

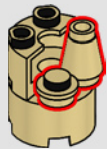

406

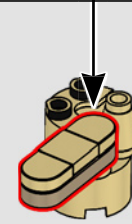
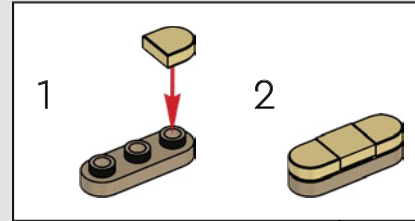

407

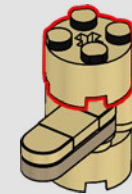



408







409

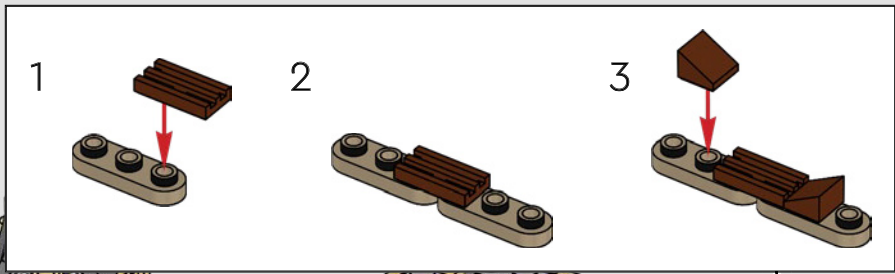

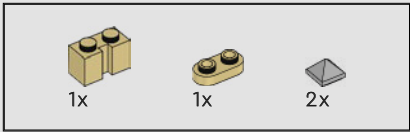

410

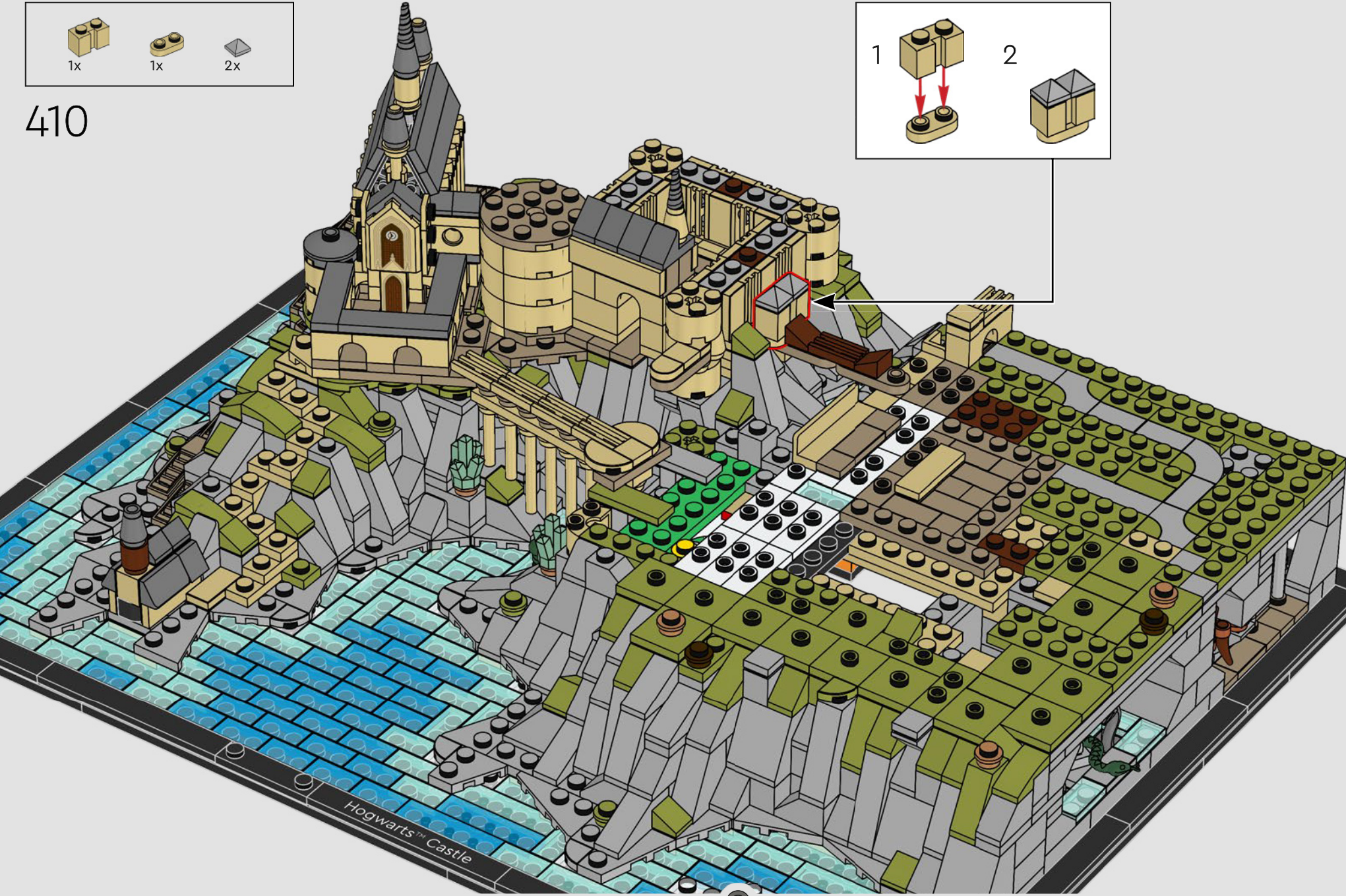
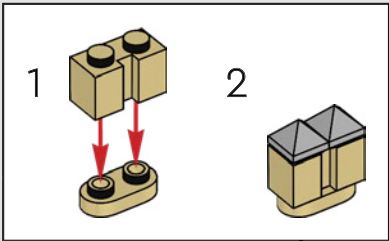

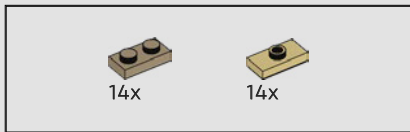

411

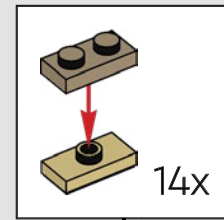

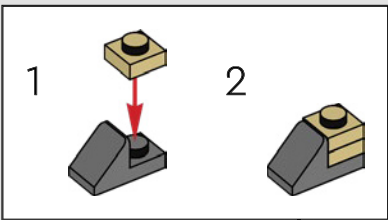
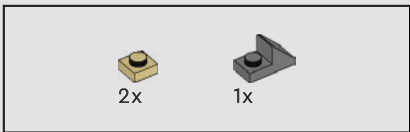

412

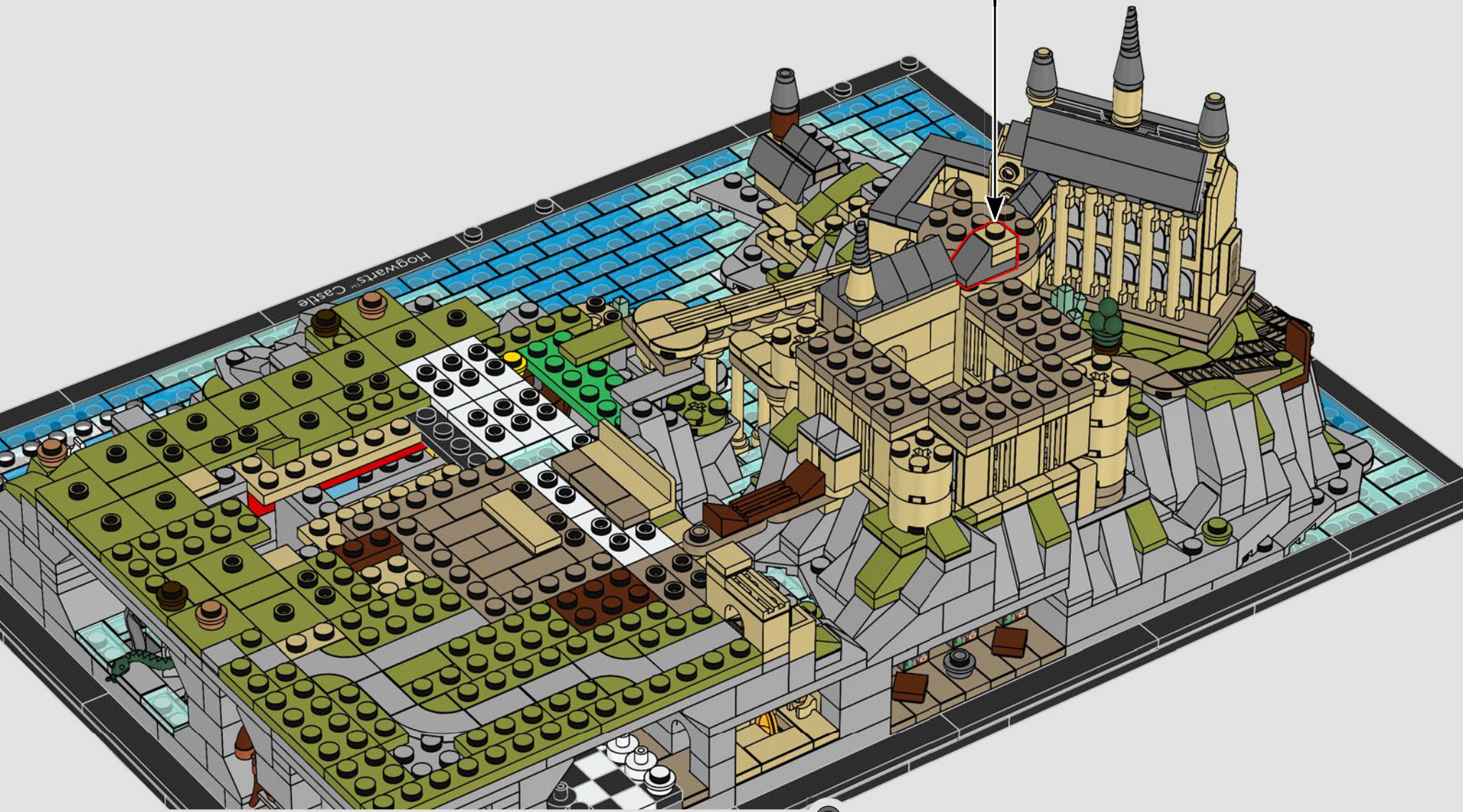

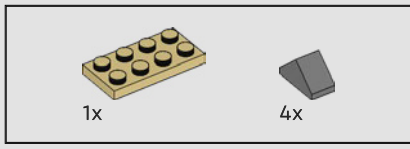

413

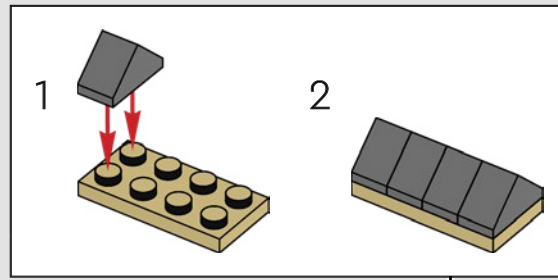

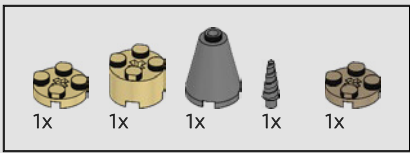

414

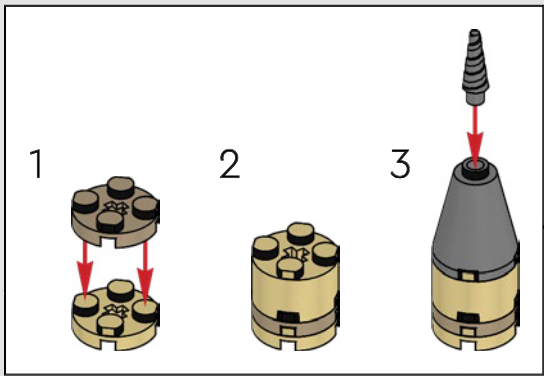



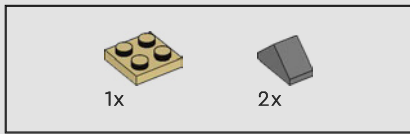

415

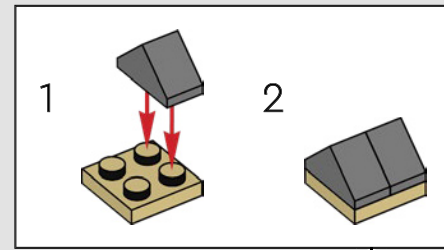

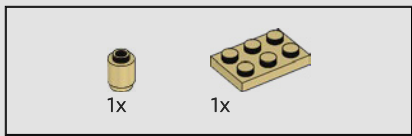

416

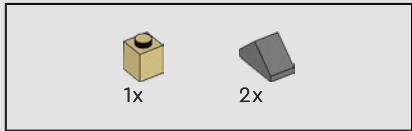
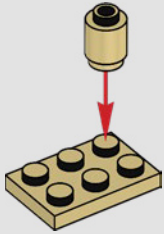

417

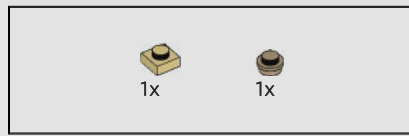
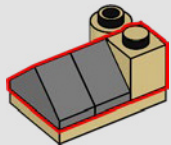

418

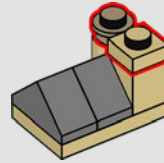

419

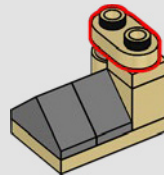

420

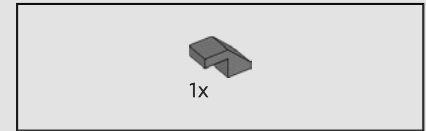
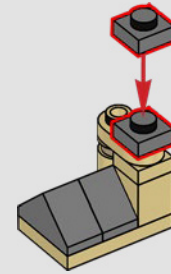

421

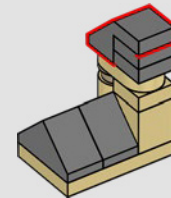

422

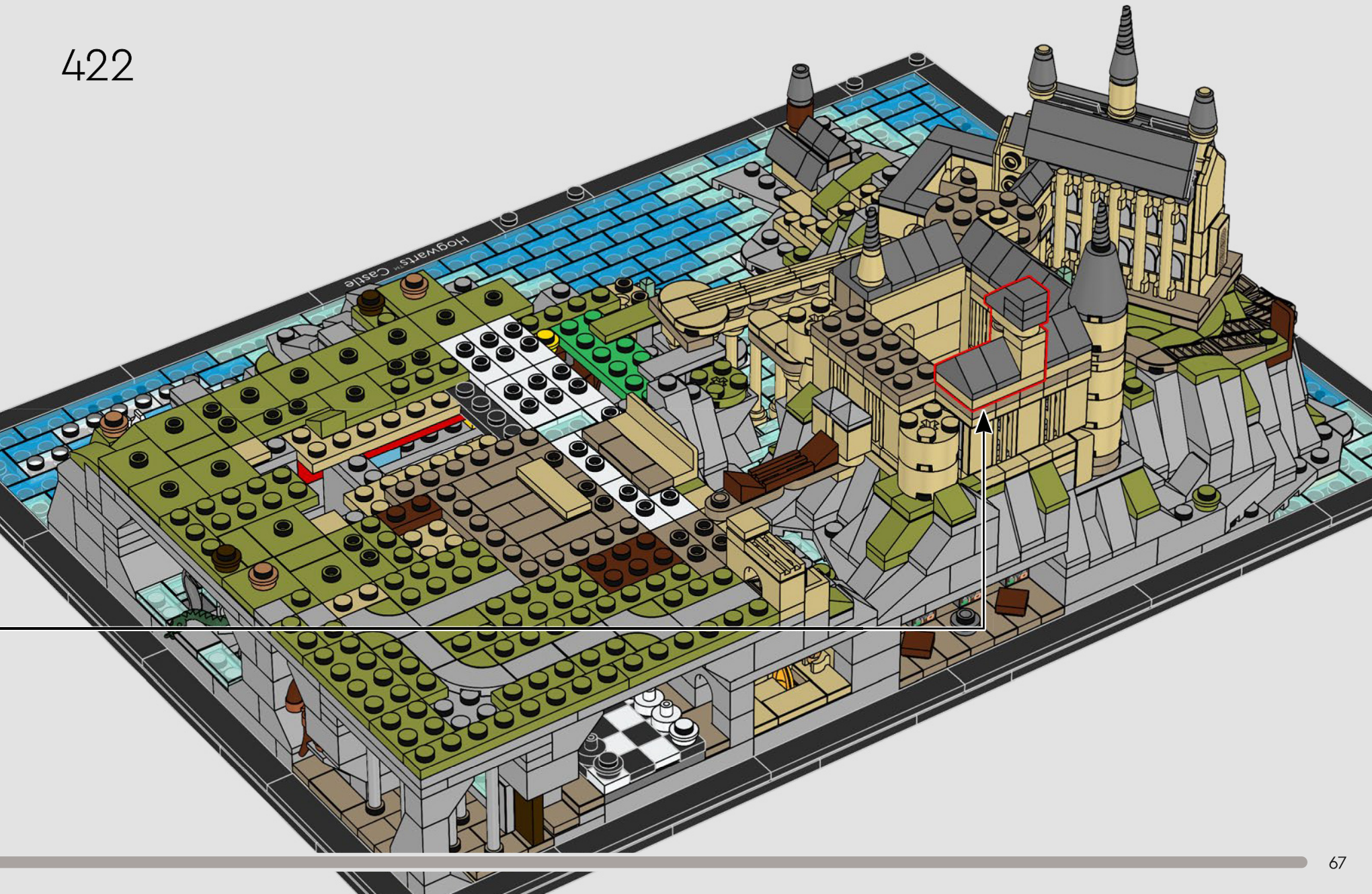

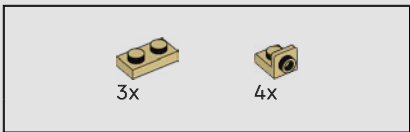

423



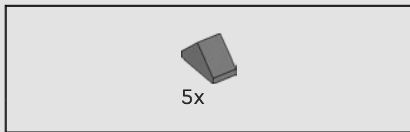

424



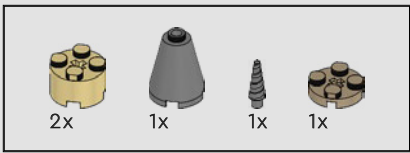

425

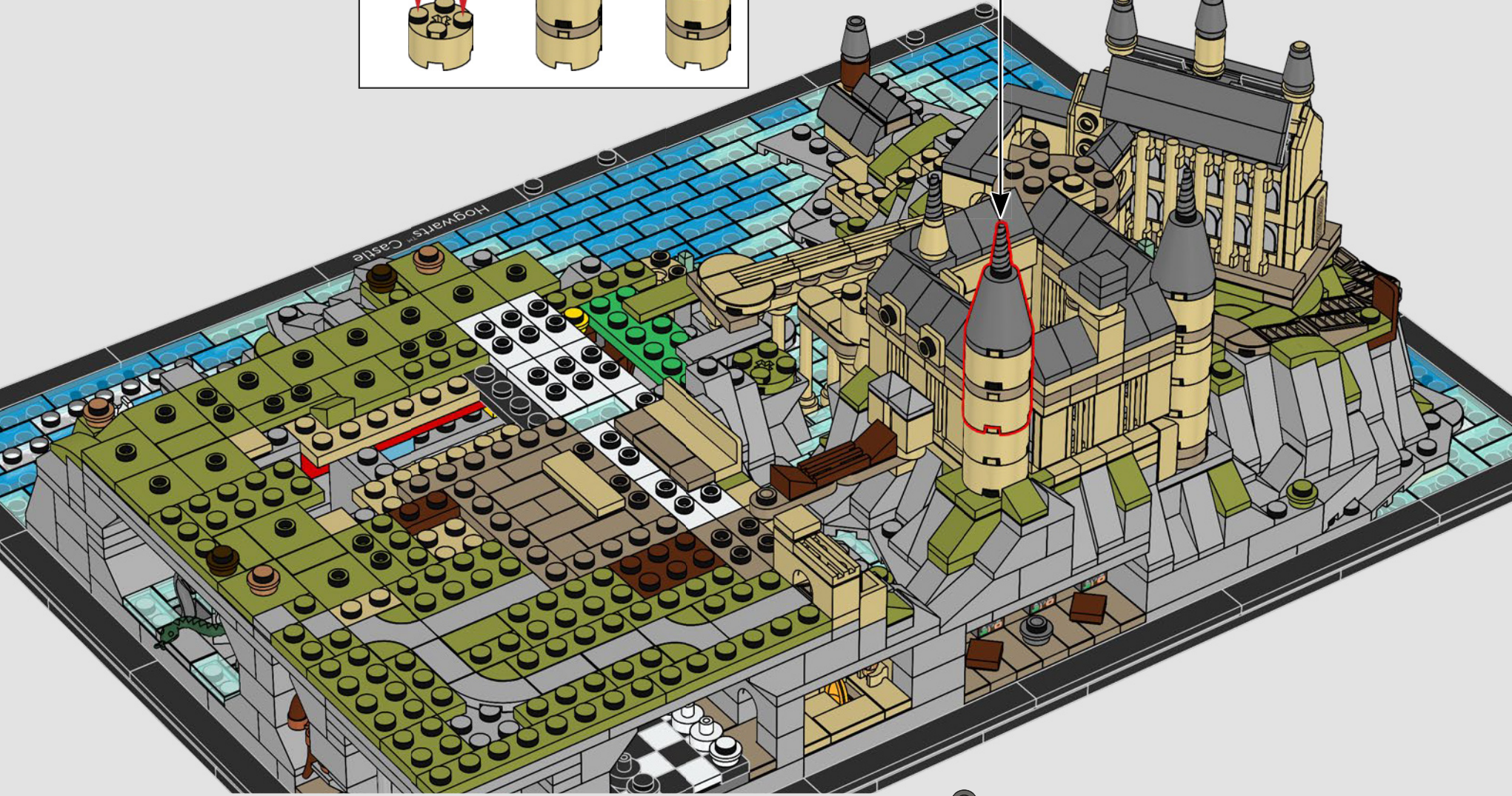
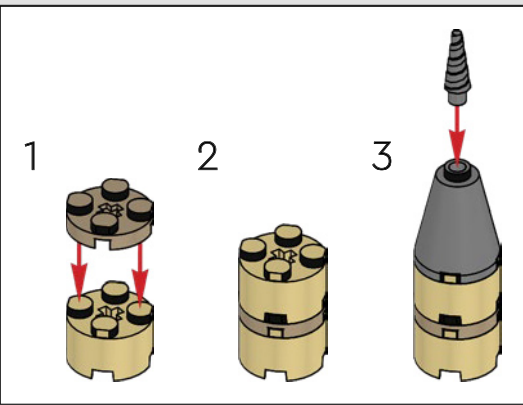

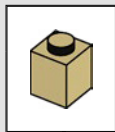
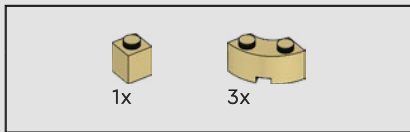

426

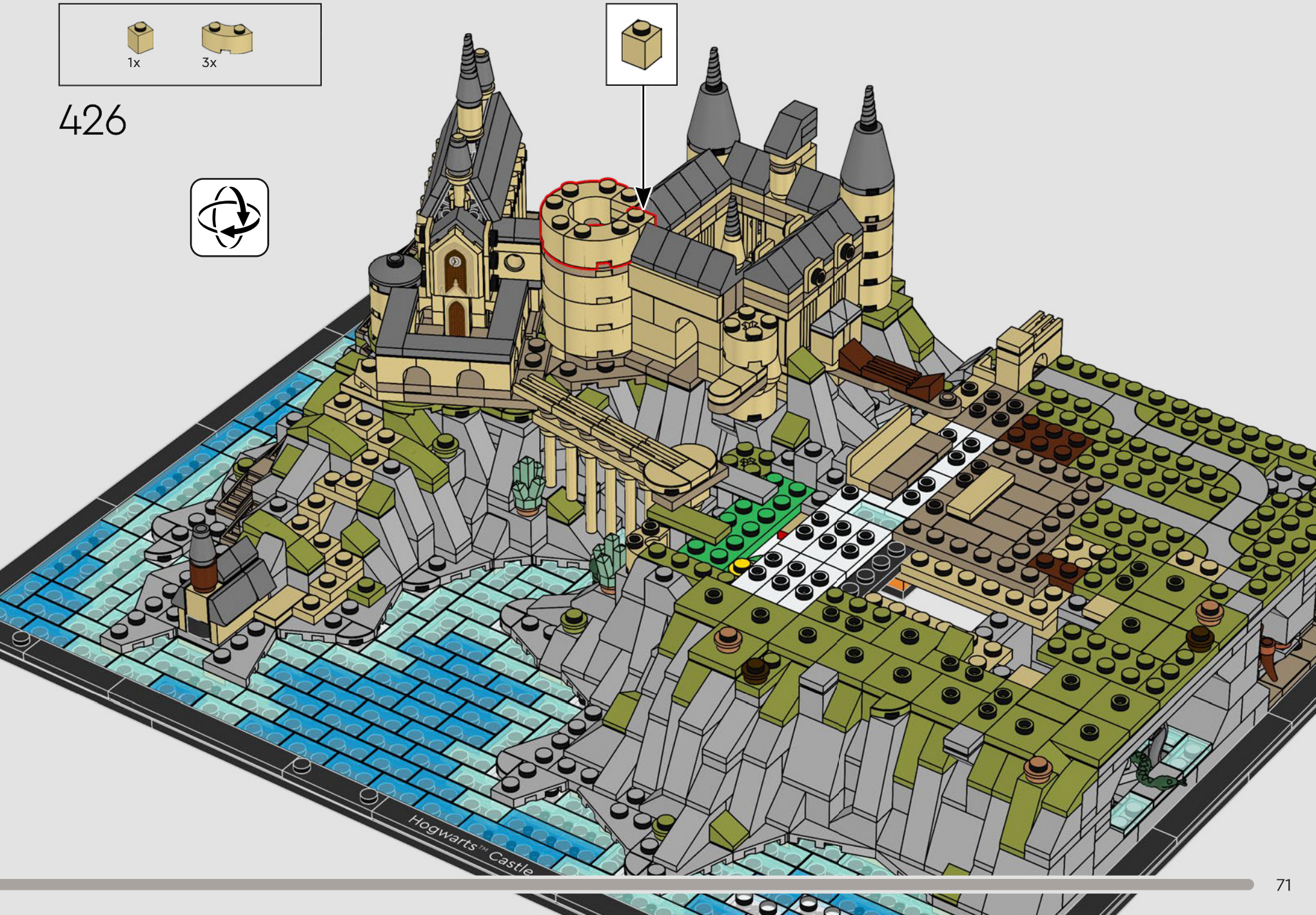

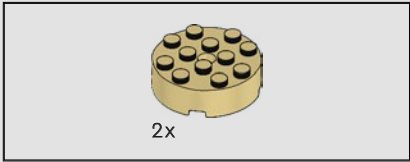
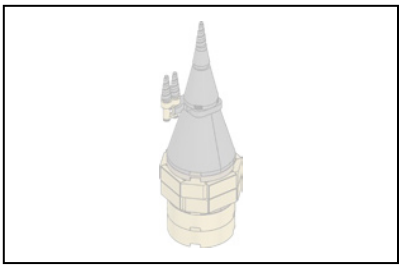

427

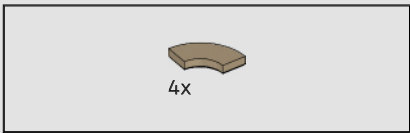
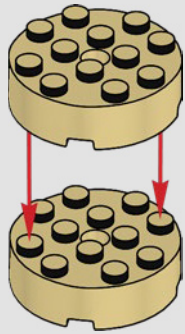

428

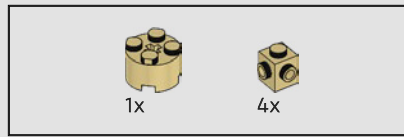
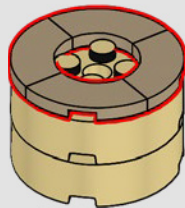

429

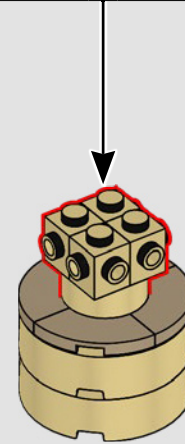
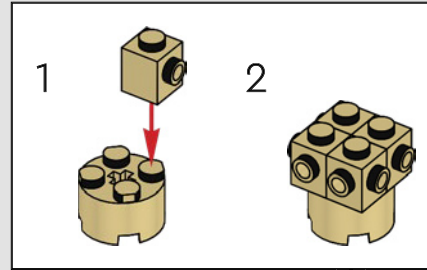



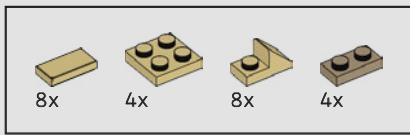

430

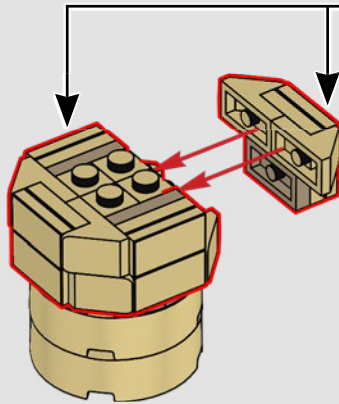
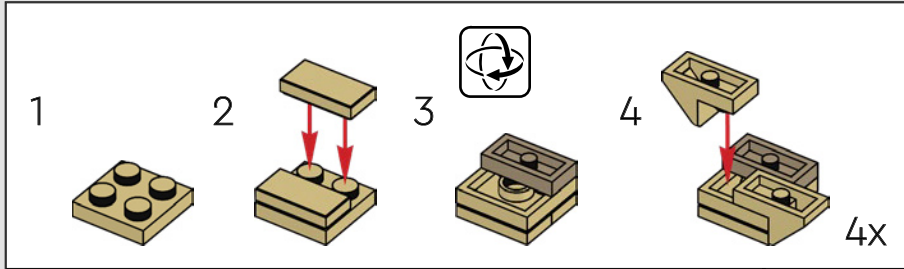

431

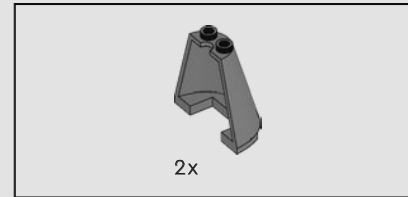
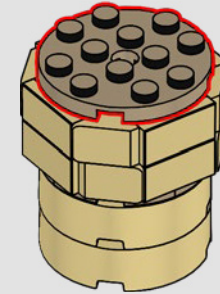

432

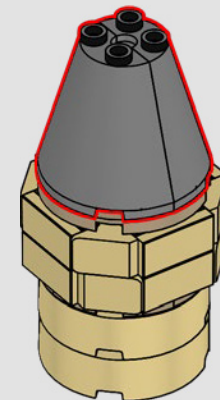

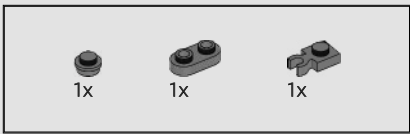

433

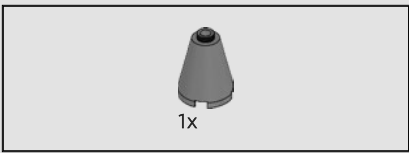
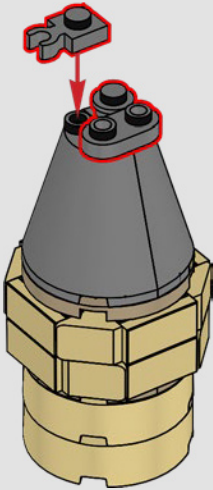

434

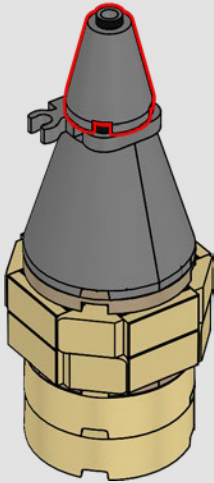

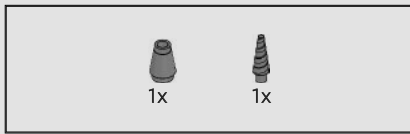

435

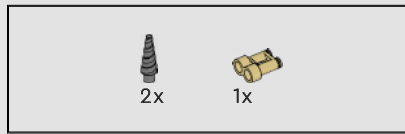
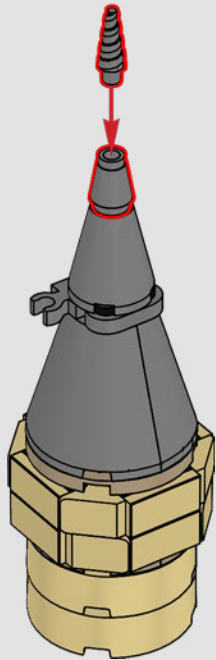

436

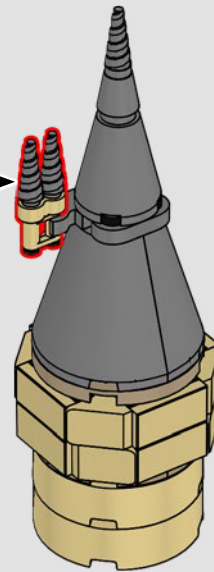
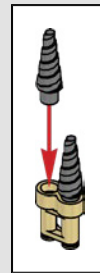

L'ufficio di Albus Silente, le torrette sulla Torre principale, è stato realizzato con un elemento telescopio LEGO®.



437



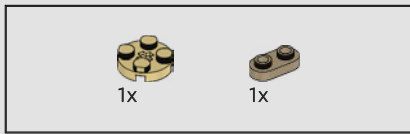

438

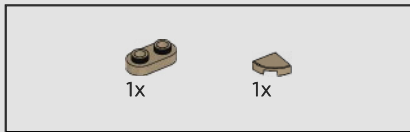
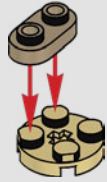

439

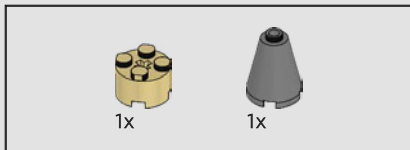

440

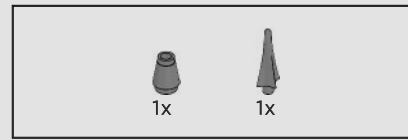
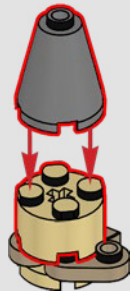

441

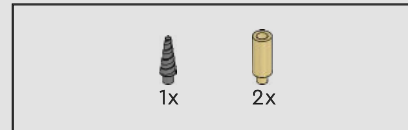
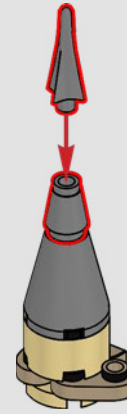

442

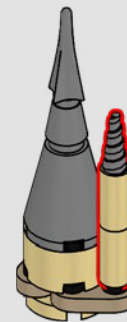
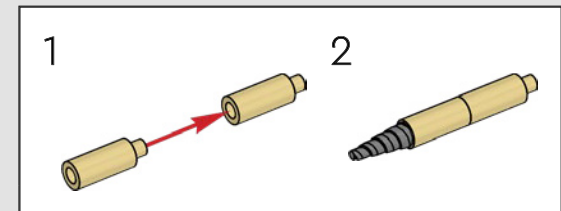

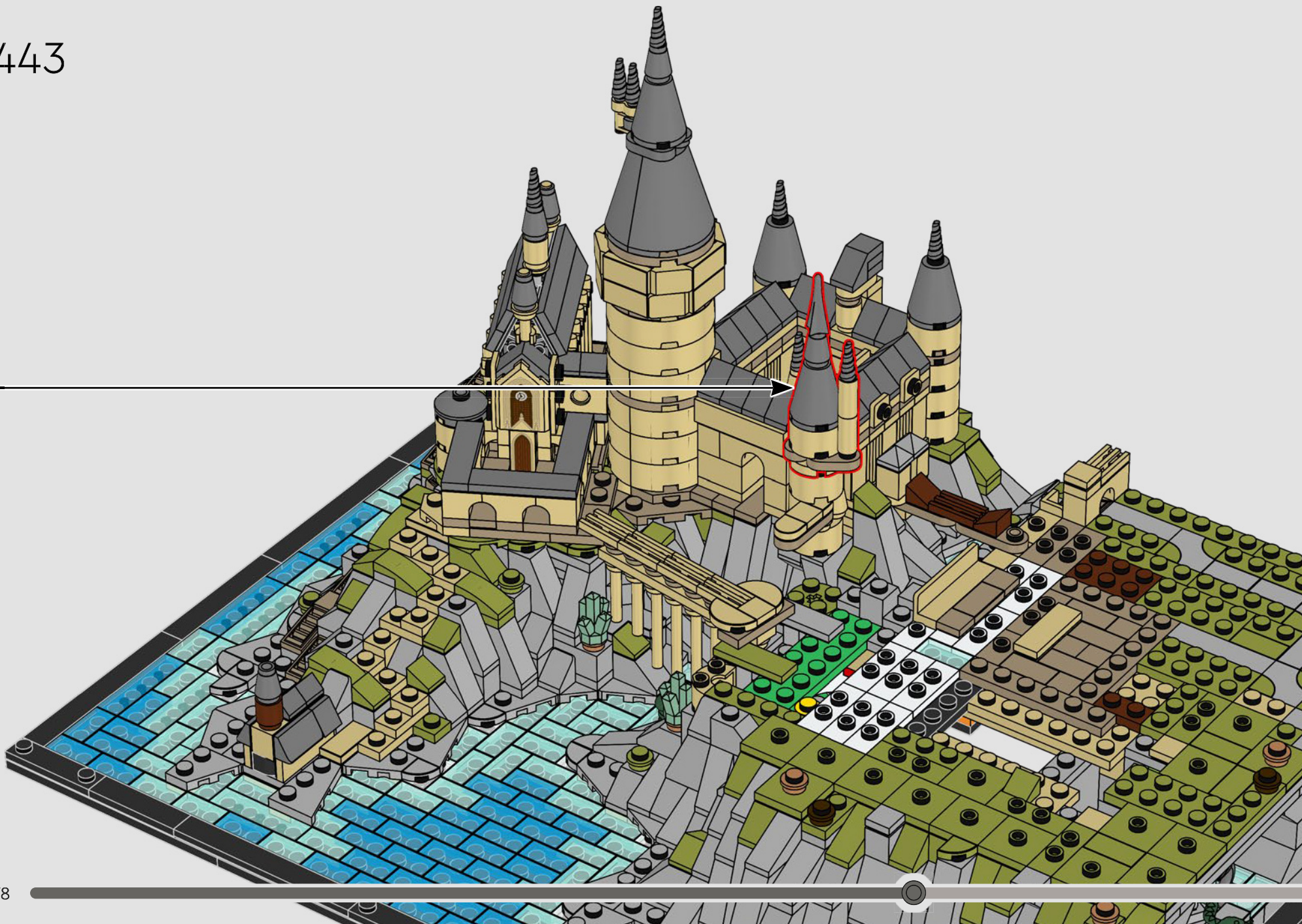



Queste torrette non sembrano proprio una struttura architettonicamente sostenibile, ma ovviamente a Hogwarts™ tutto è possibile!





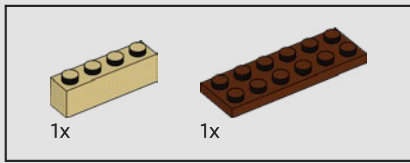

444

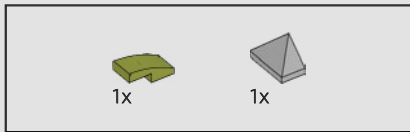
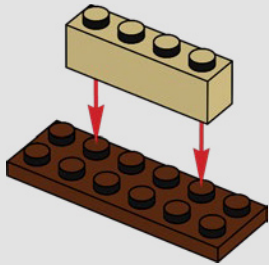

445

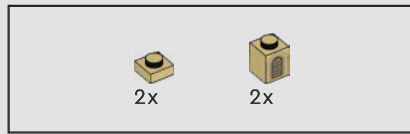
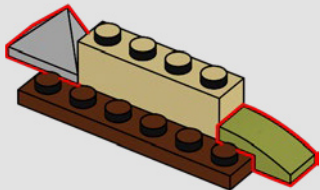

446

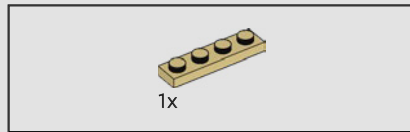
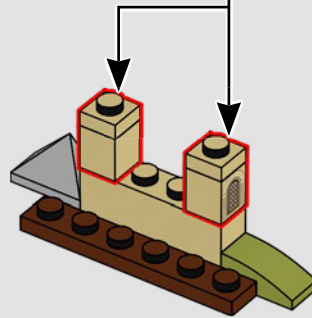
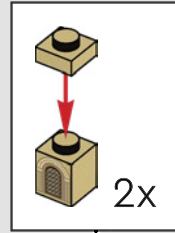

447

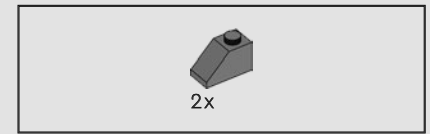
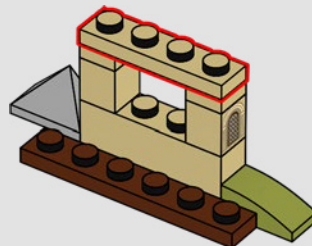

448

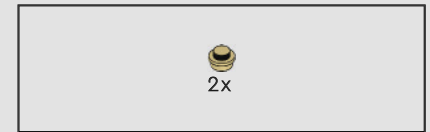
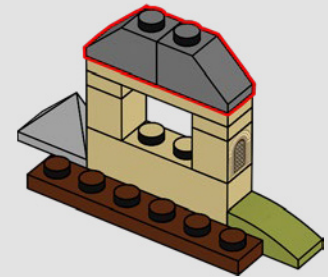

449

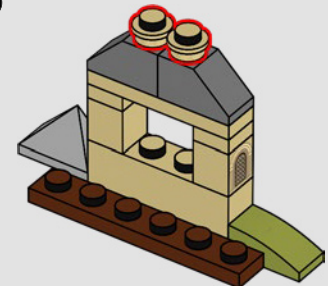

450

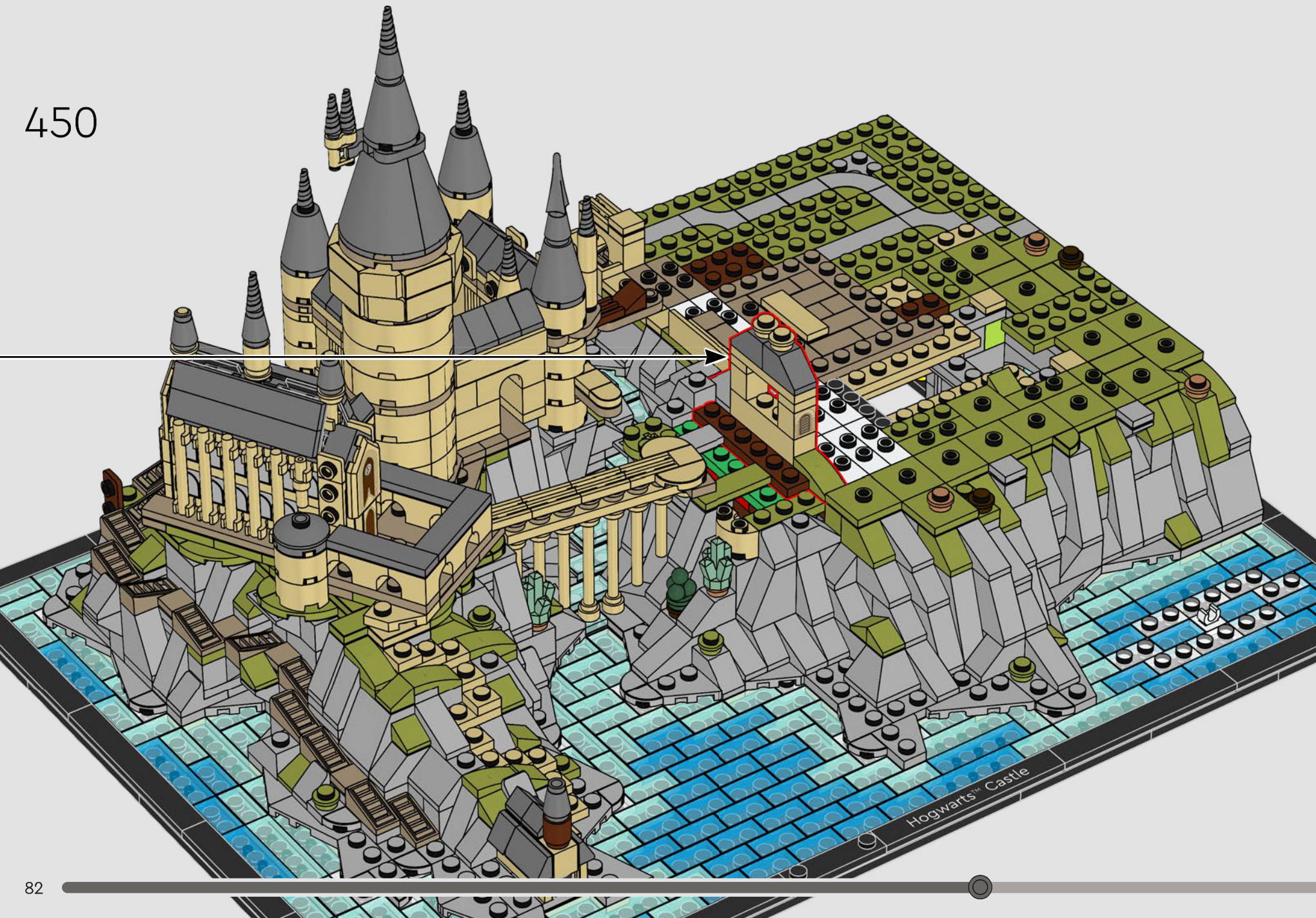

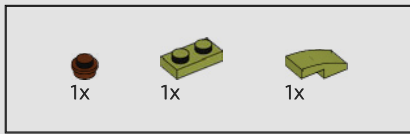

451

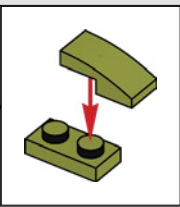
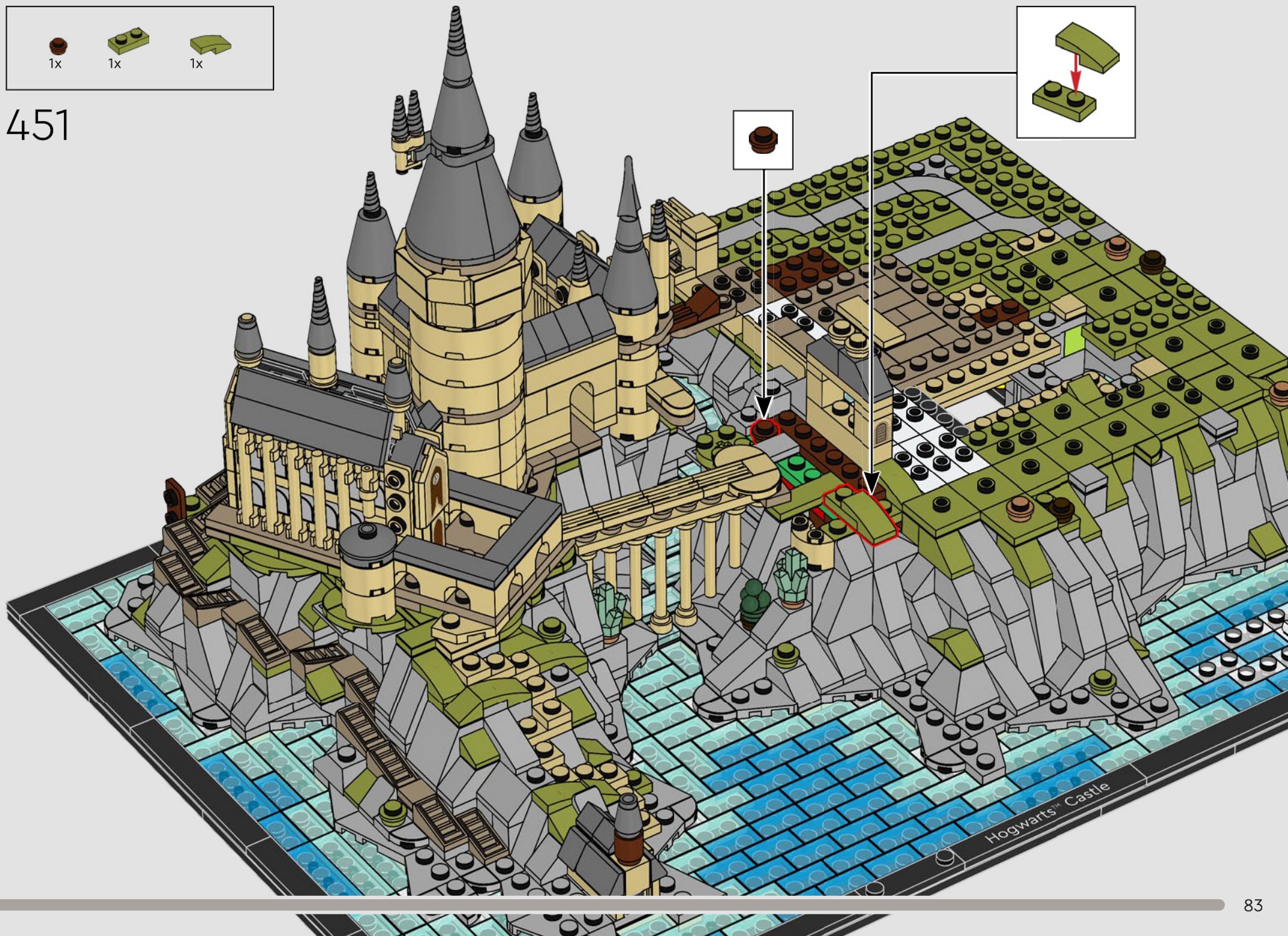

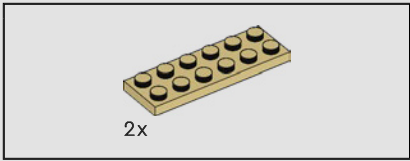

452

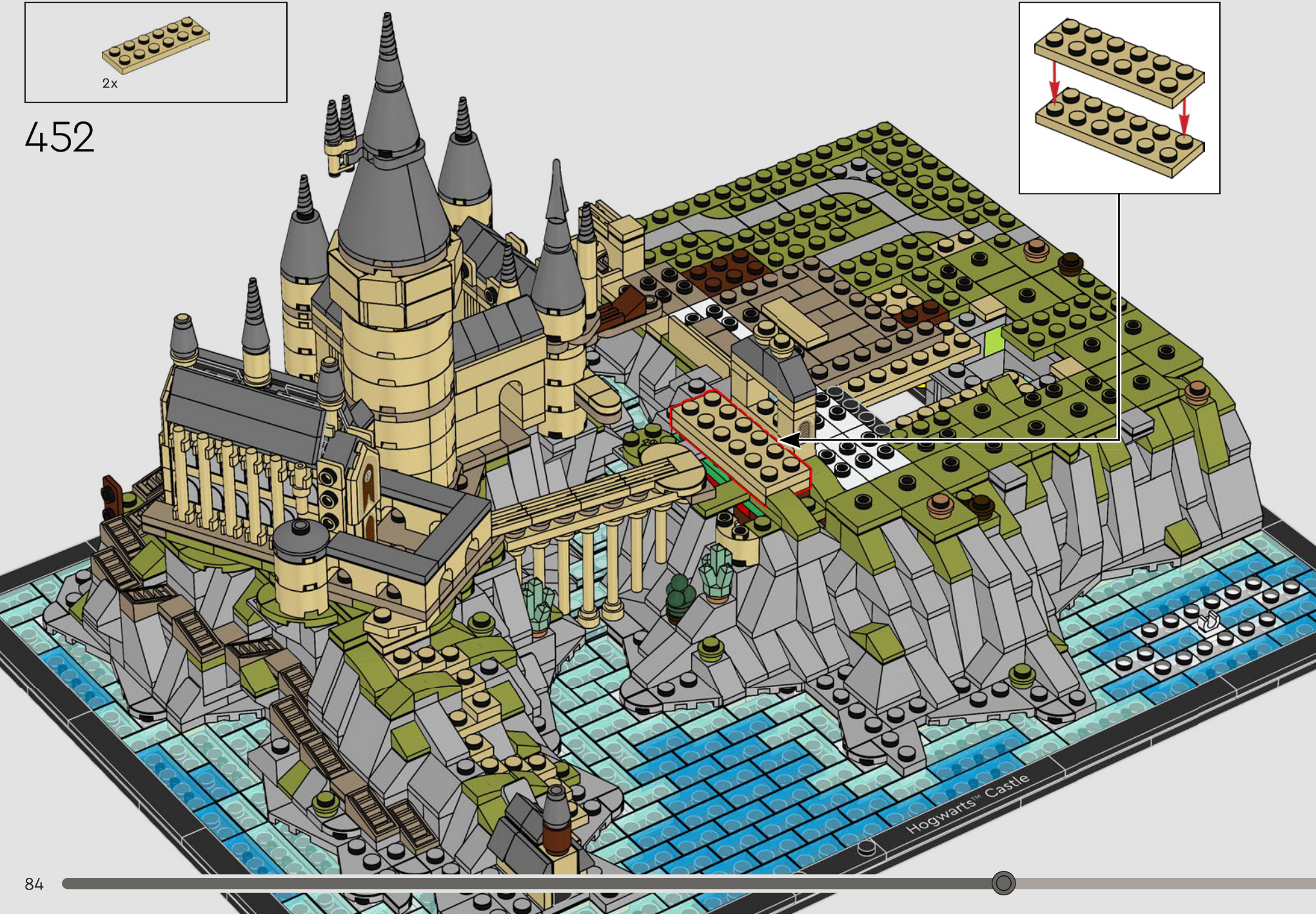
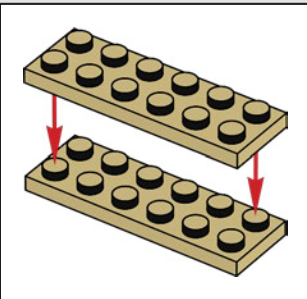

Hogwarts™ Castle



453

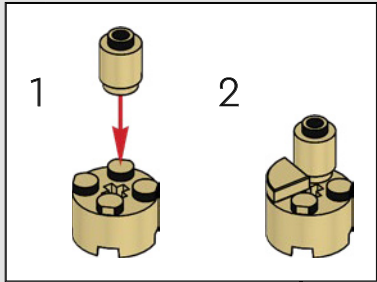



3x

454

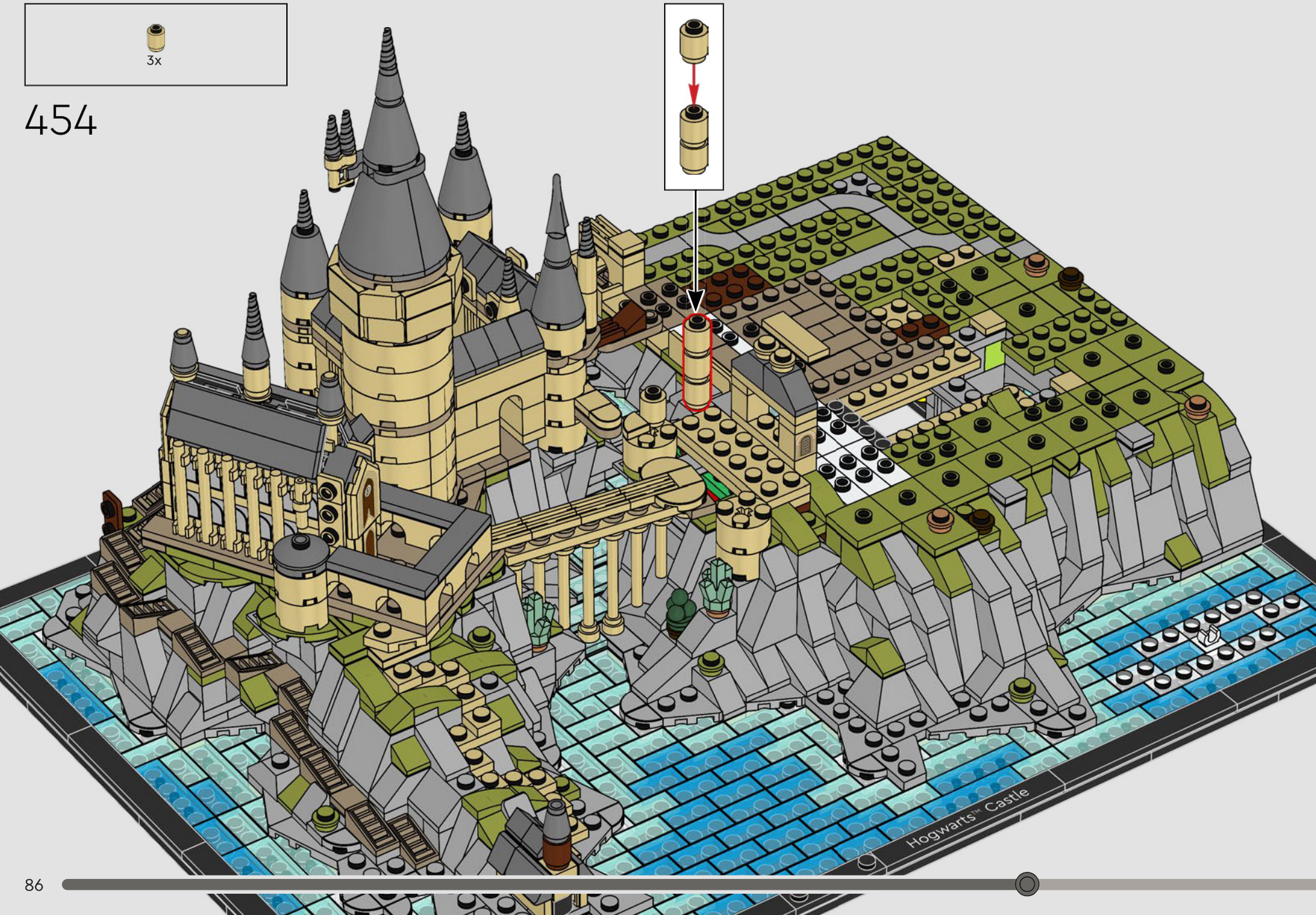
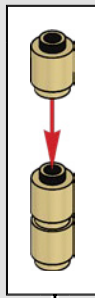

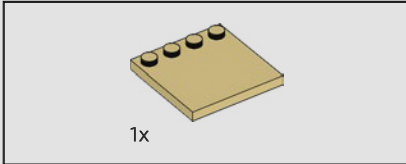
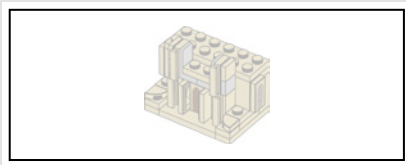

455

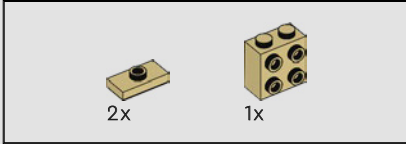
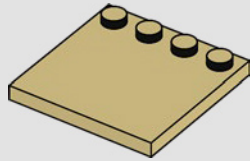

456

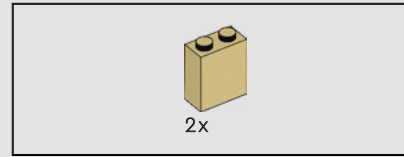
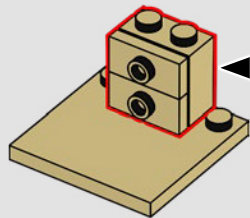
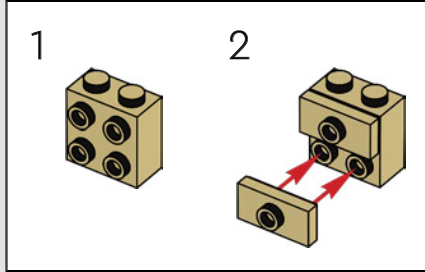

457

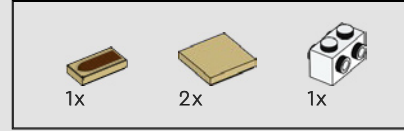
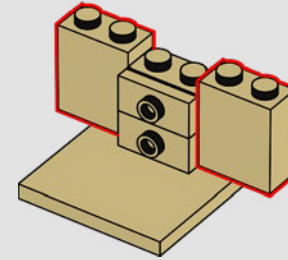

458

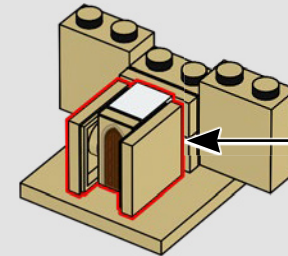
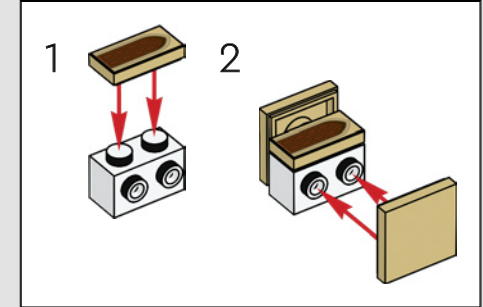

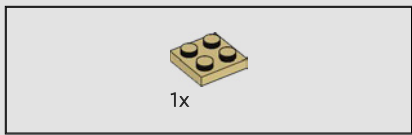

459

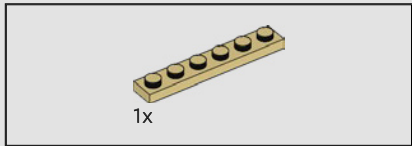
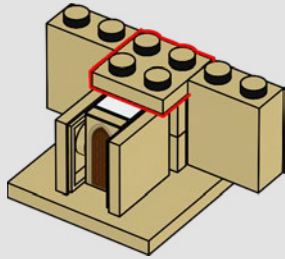

460

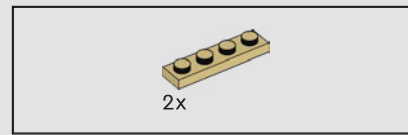
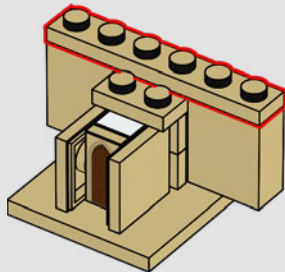

461

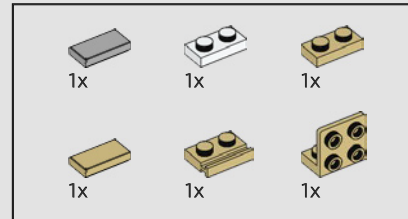
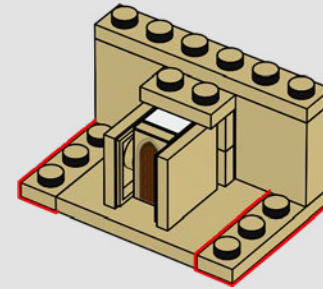

462

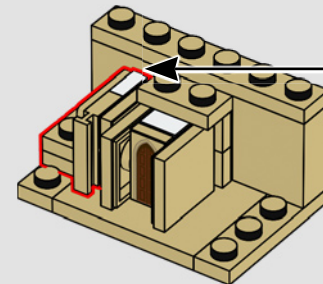
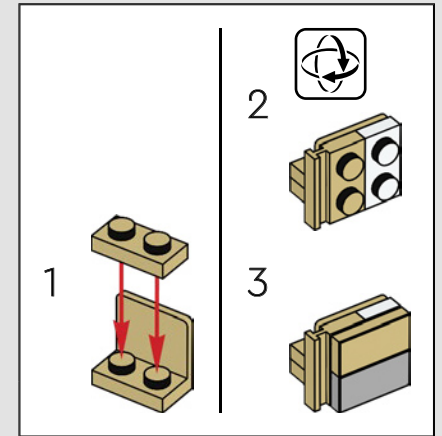



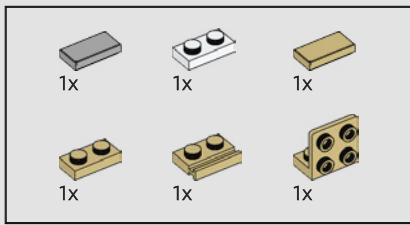

463

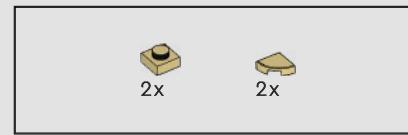
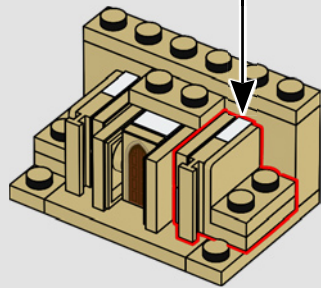
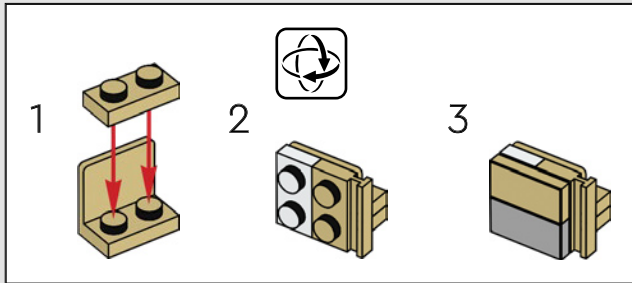

464

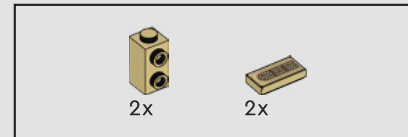
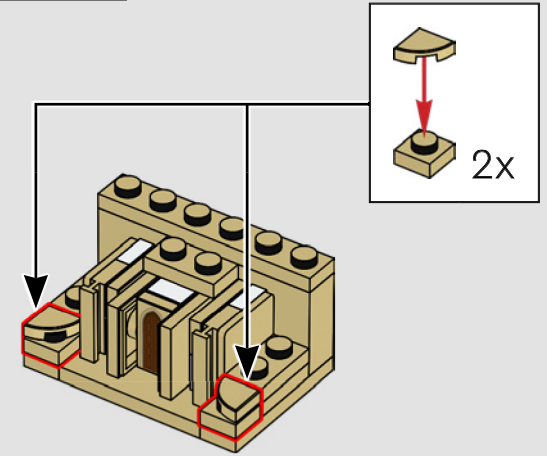

465

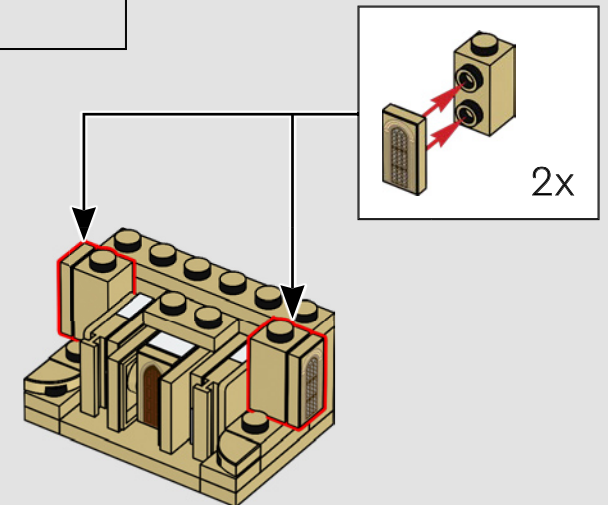

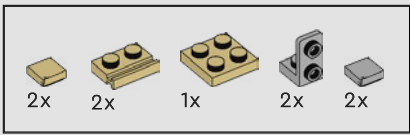

466

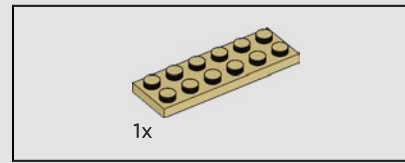
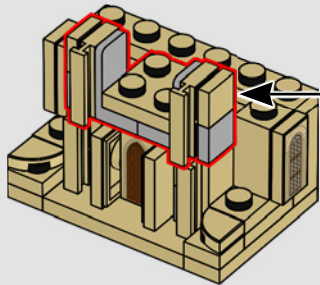
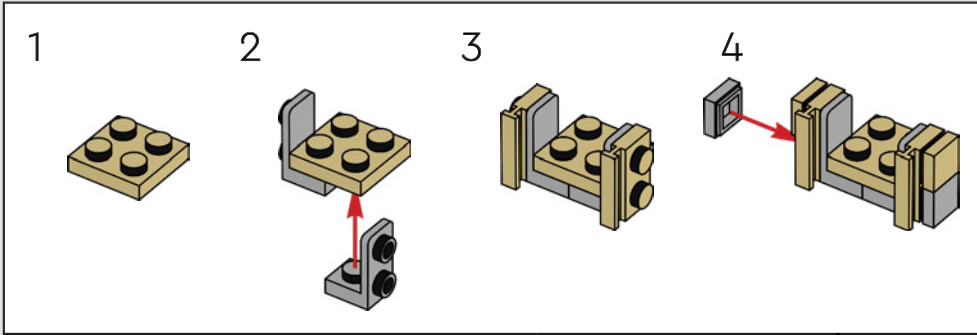

467

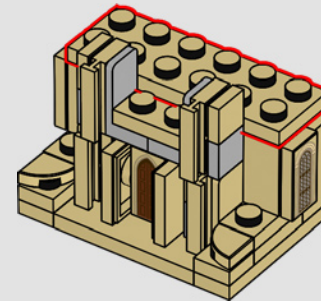

468

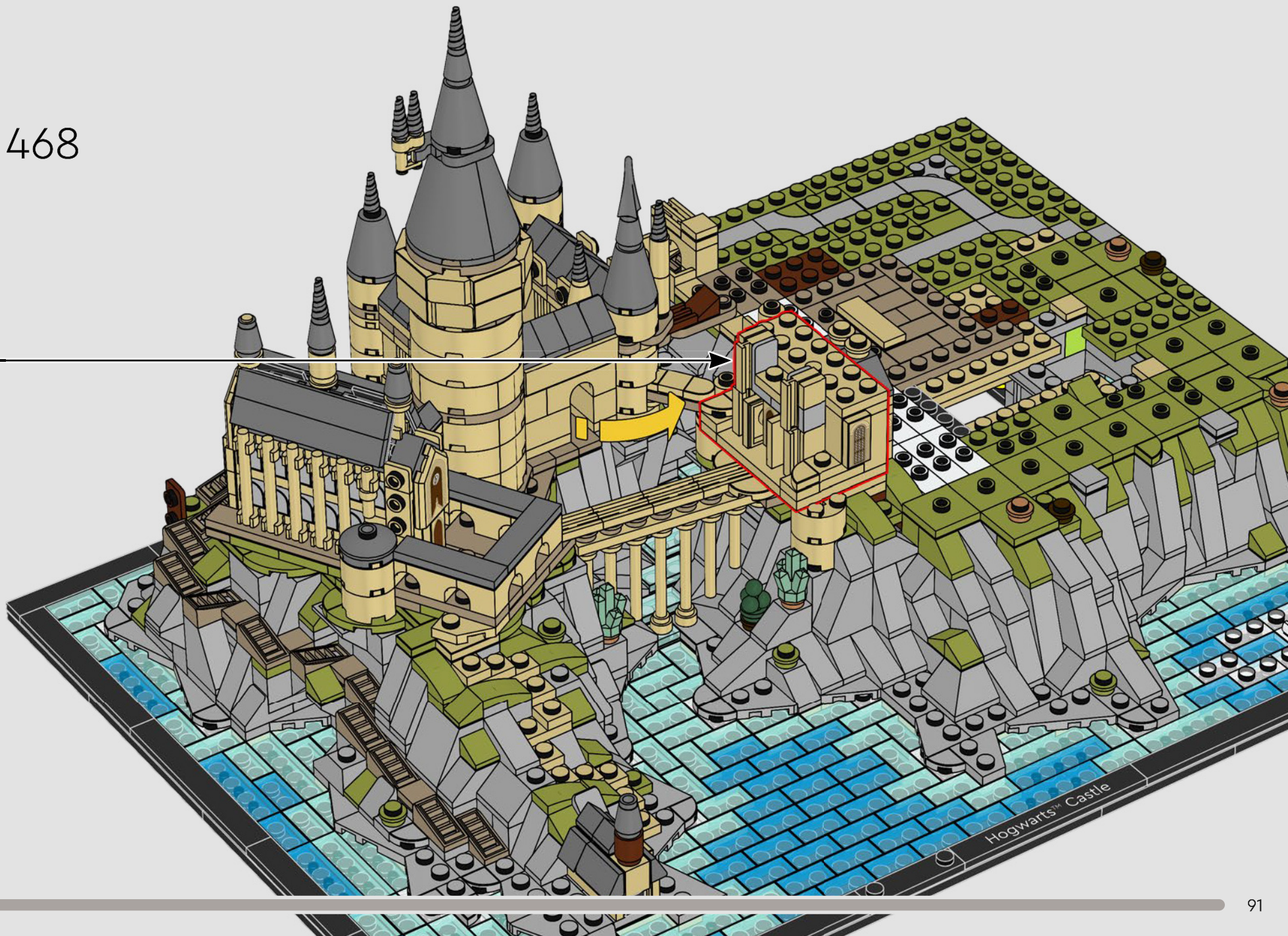

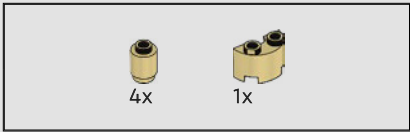

469

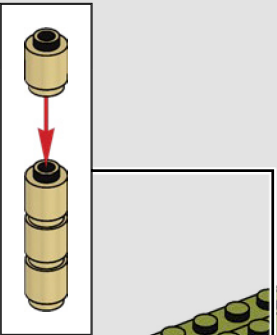

Hogwarts™ Castle



470

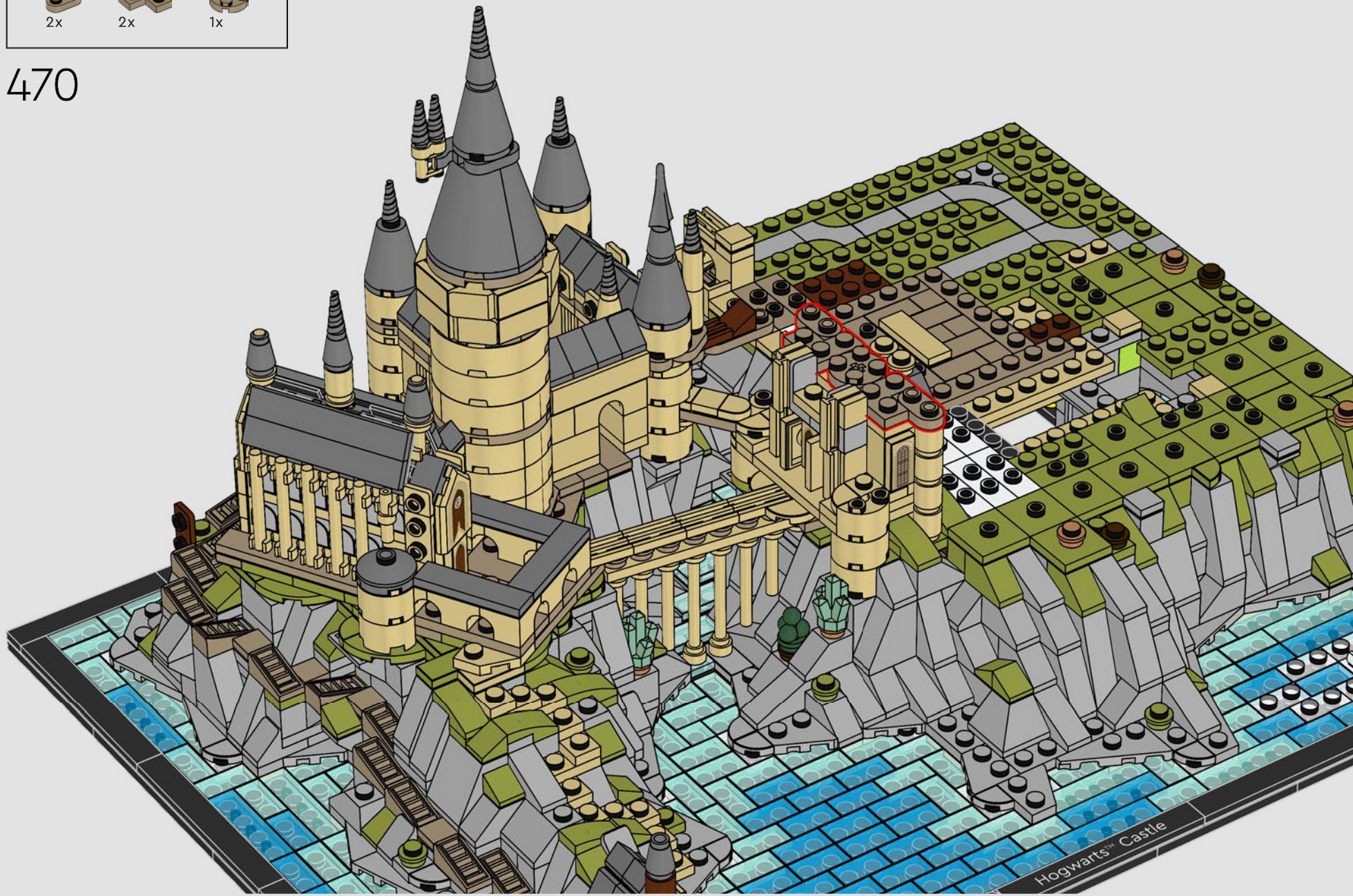

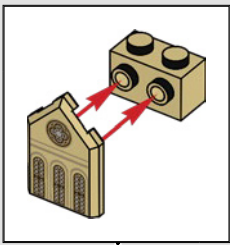
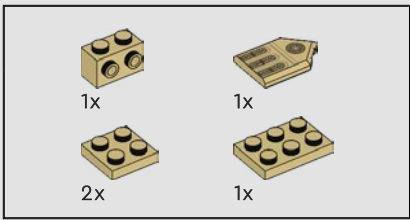

471

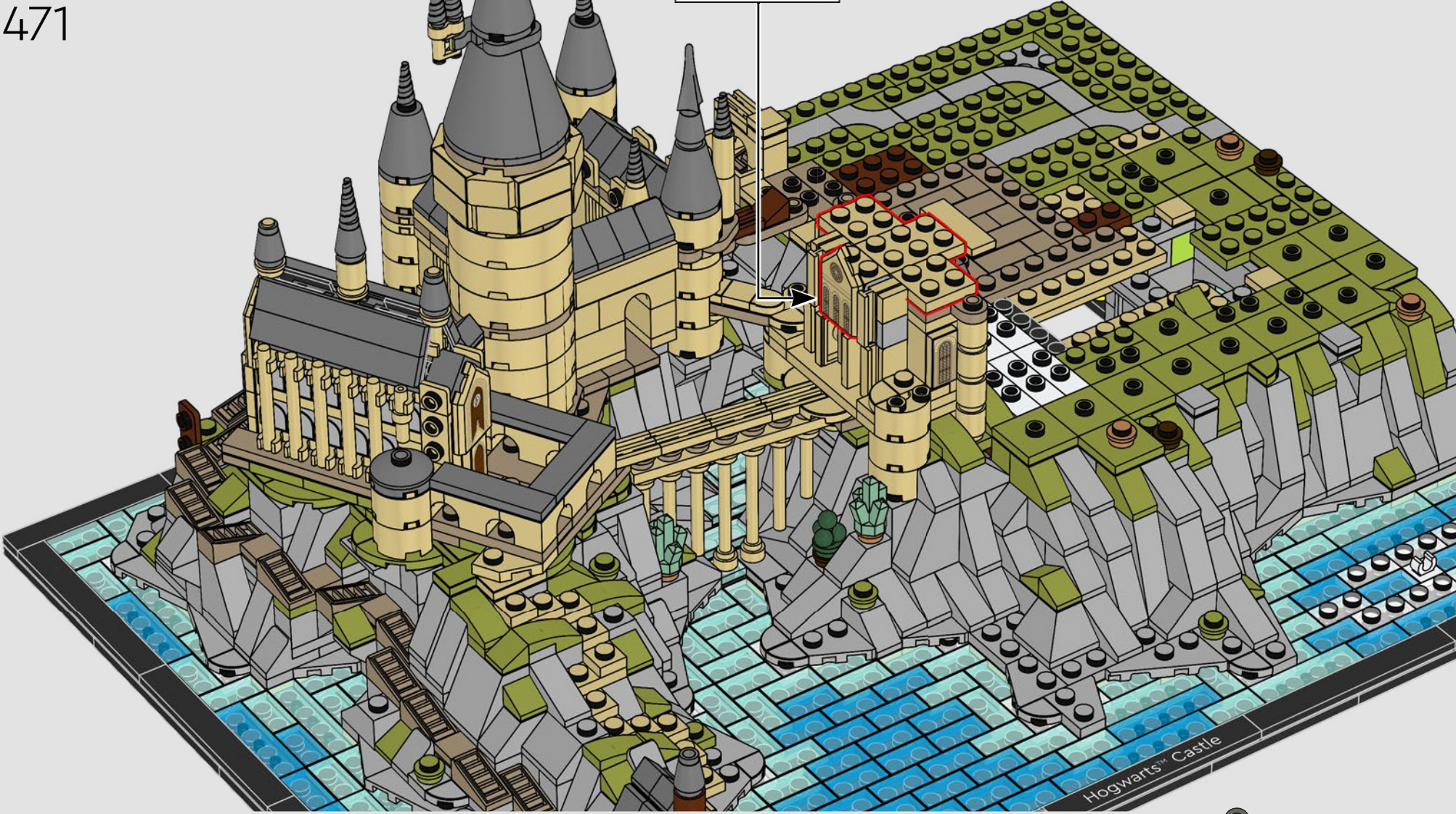



472

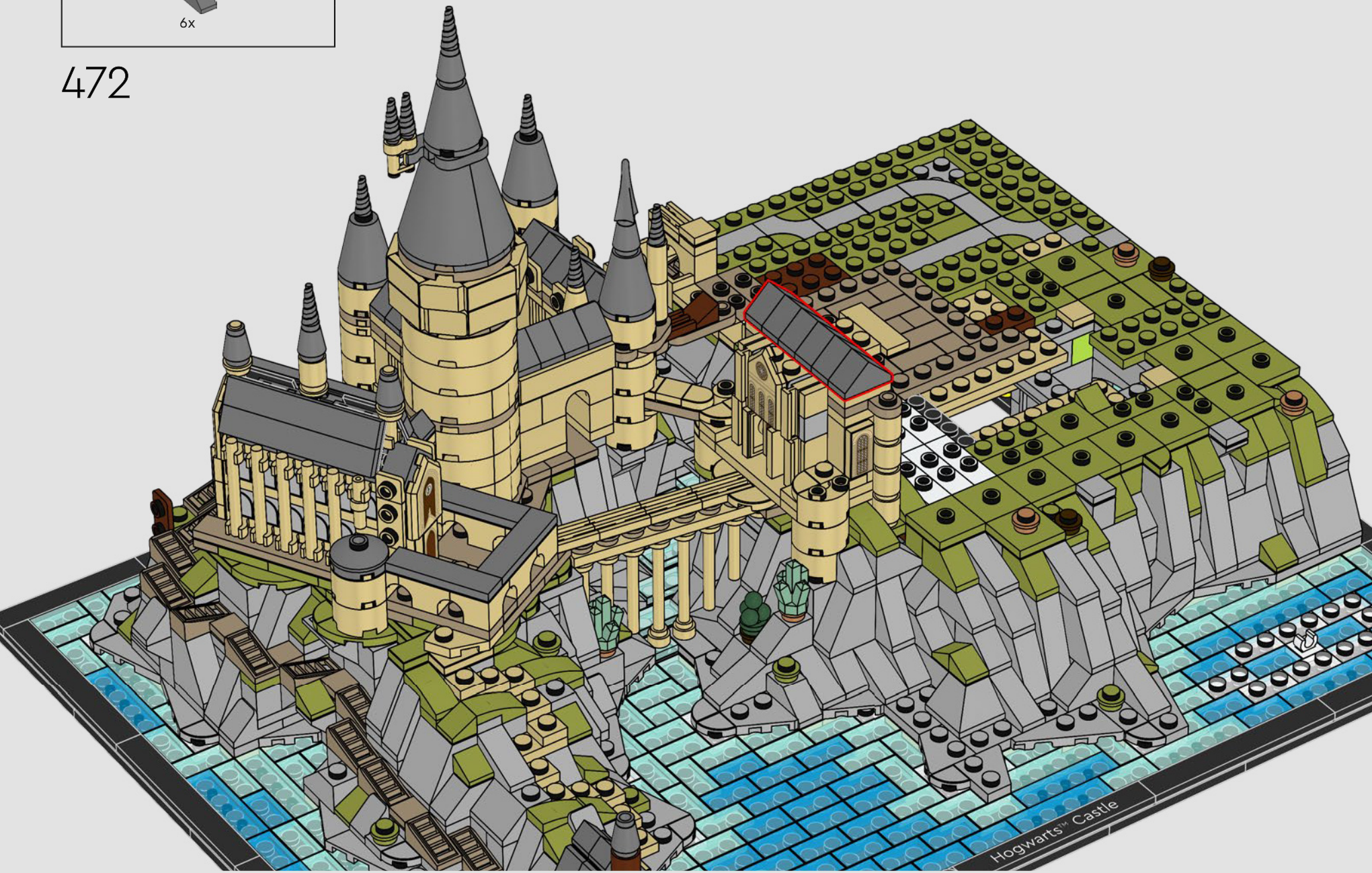

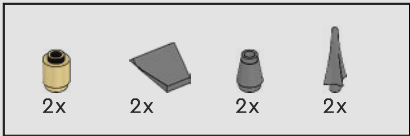

473

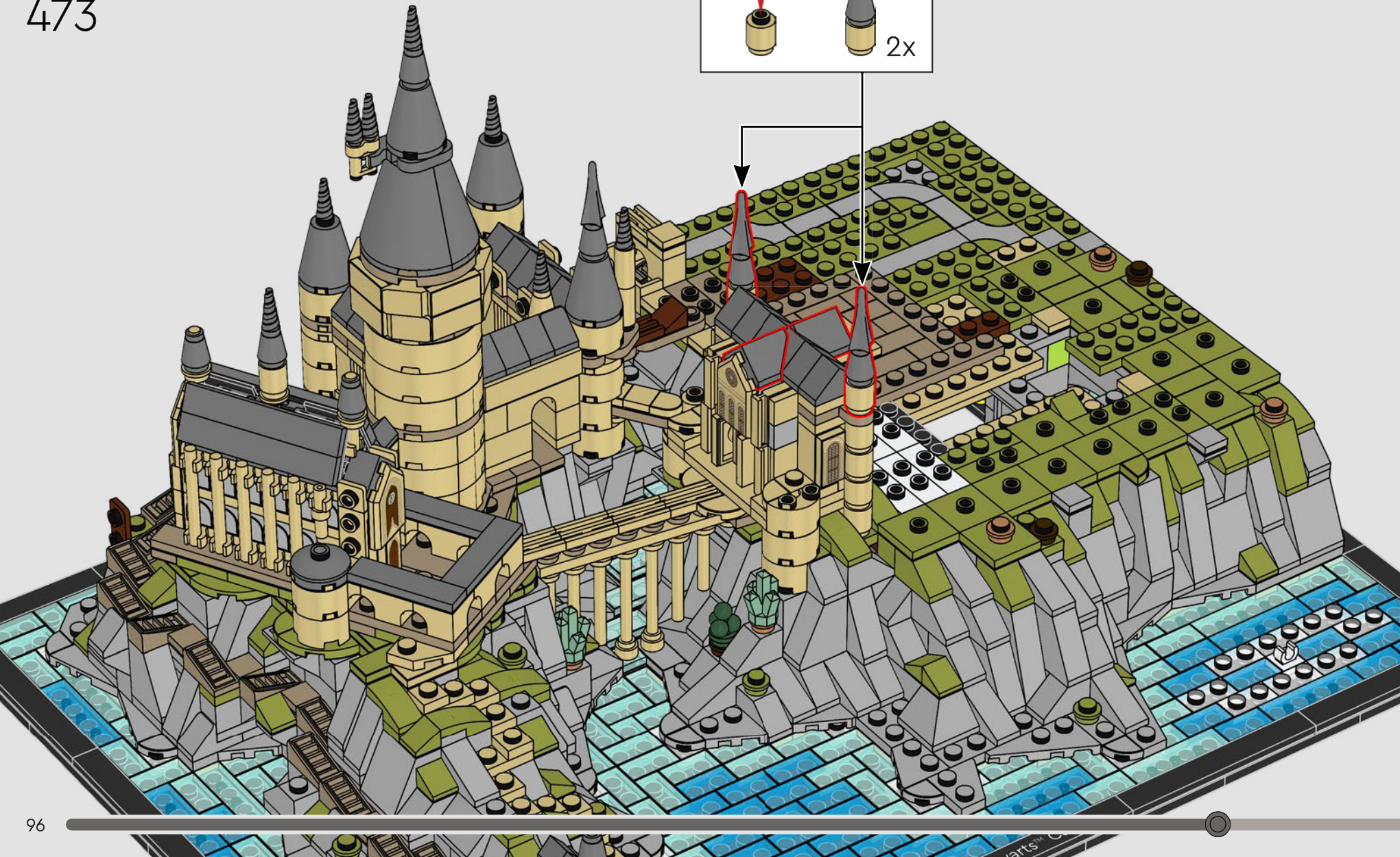
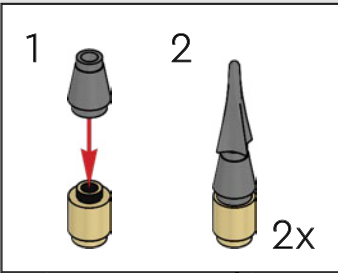



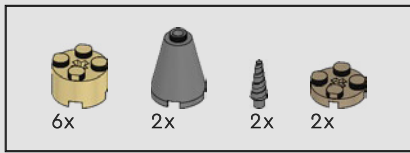

474

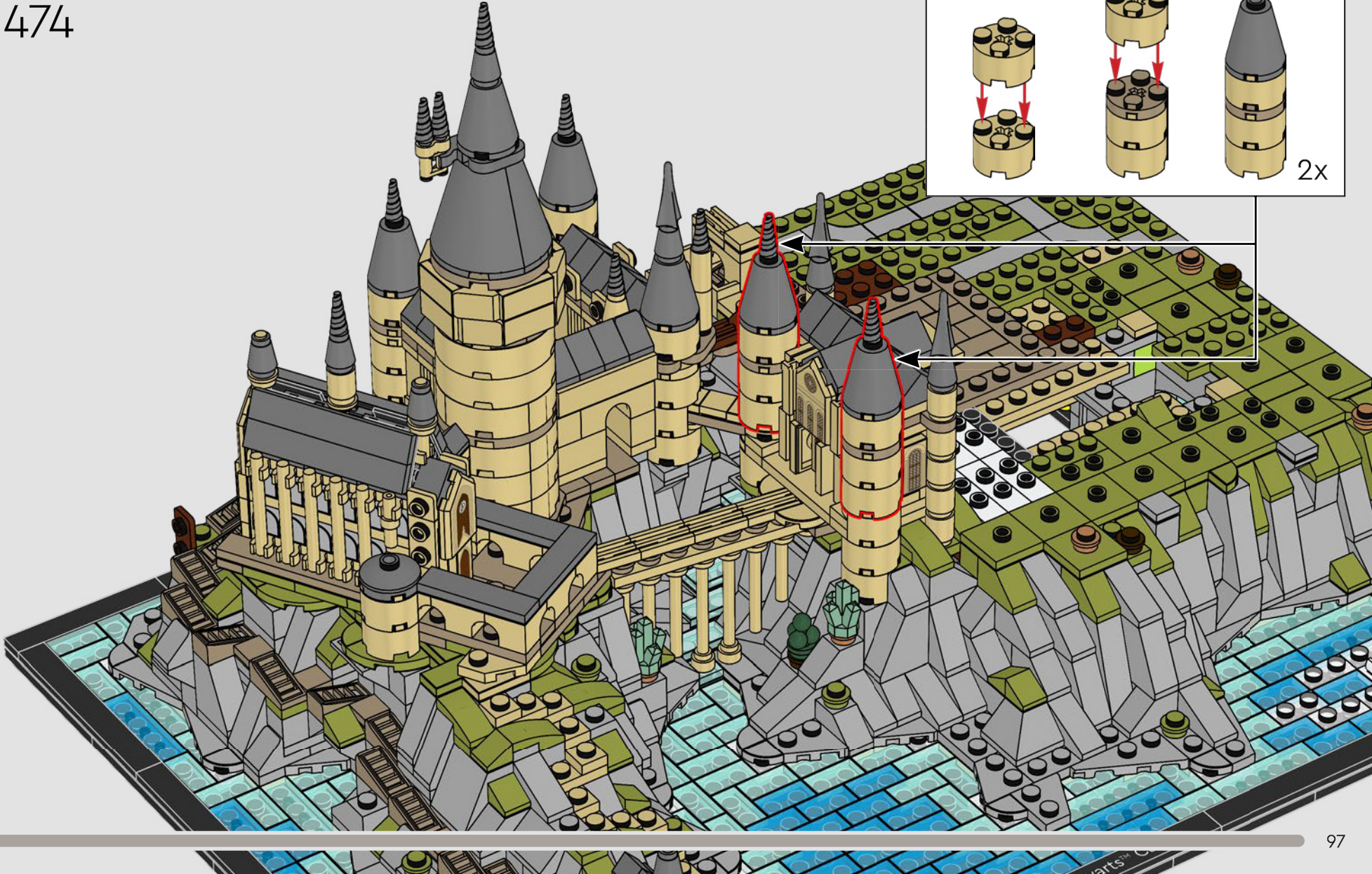
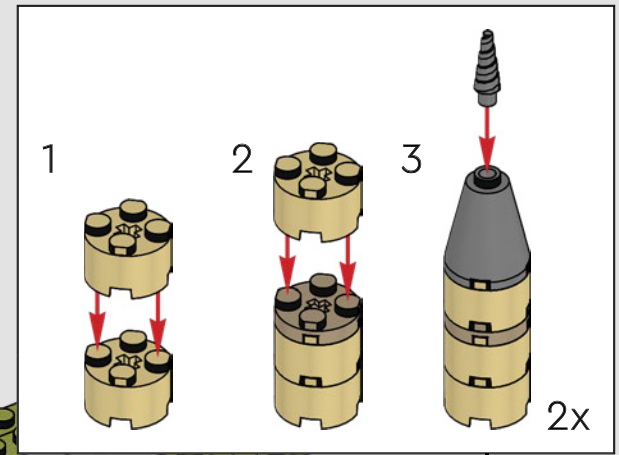

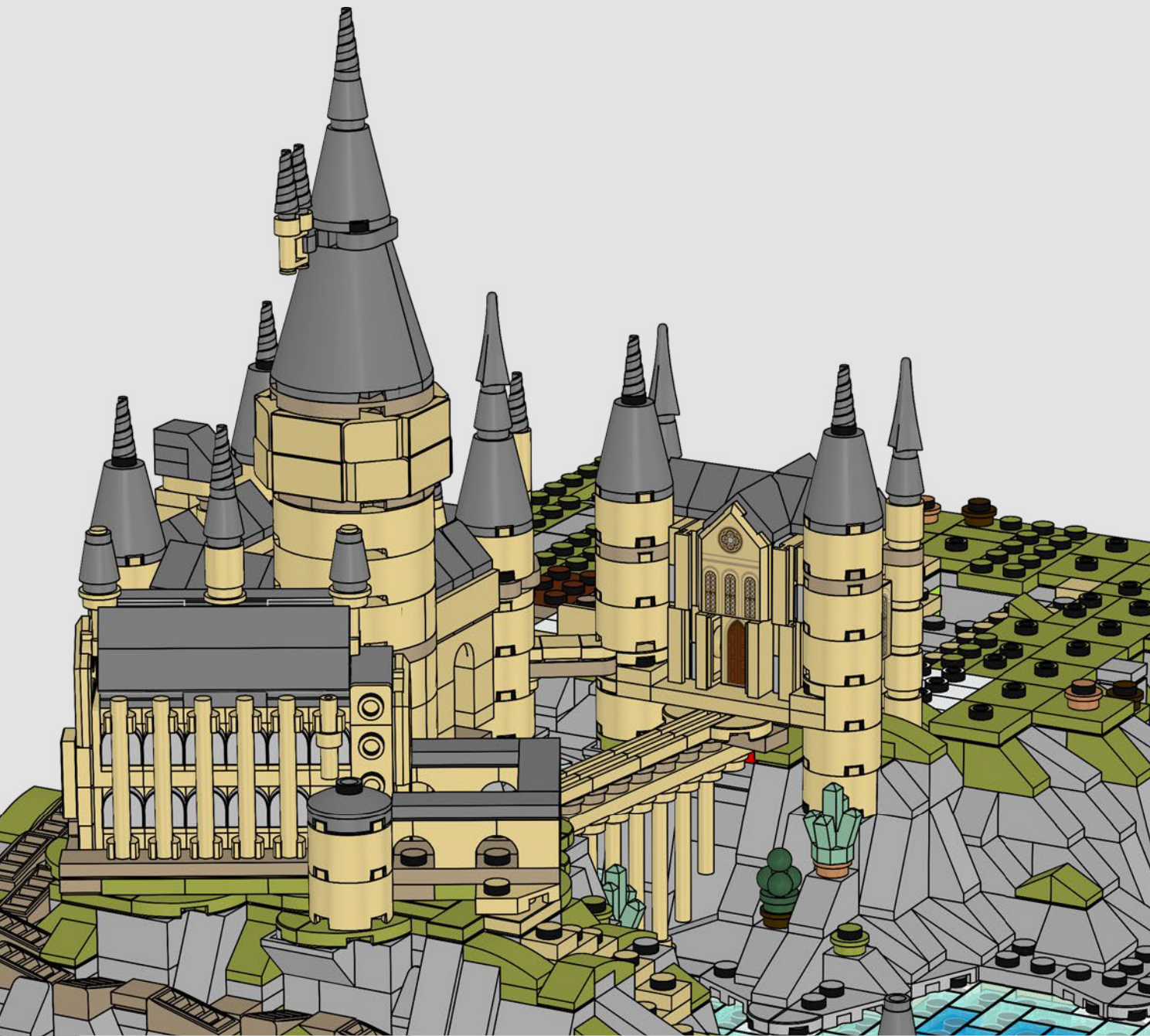

In questa parte del castello si trovano i gabinetti delle ragazze. Forse Mirtilla Malcontenta ti verrà a trovare durante la costruzione. Fai attenzione ai troll.





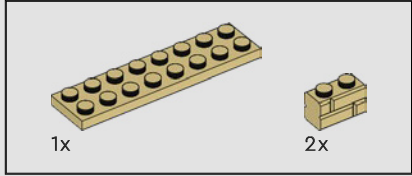
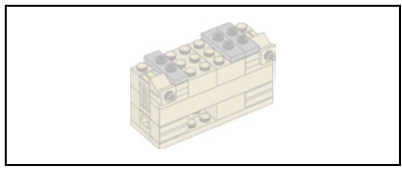

475

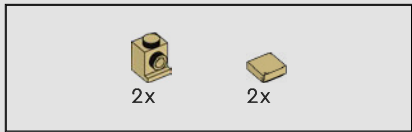
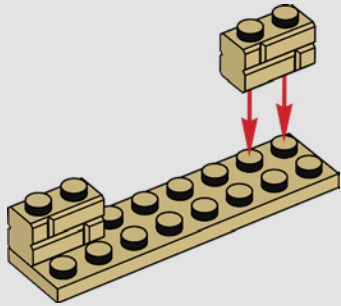

476

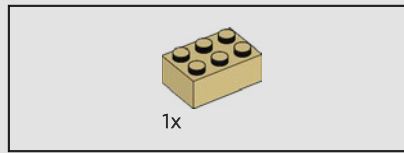
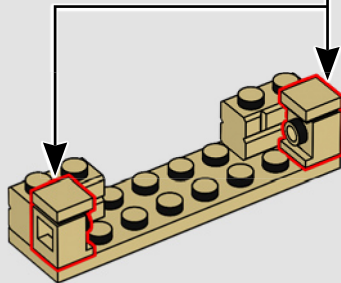
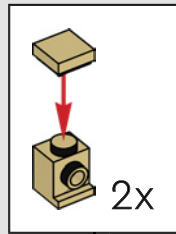

477

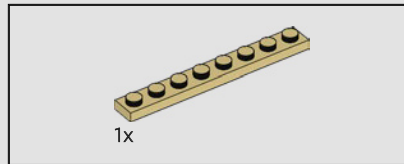
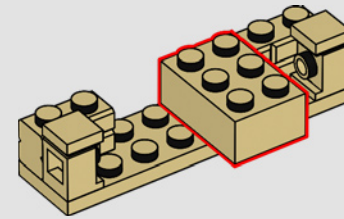

478

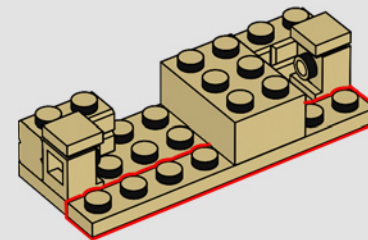

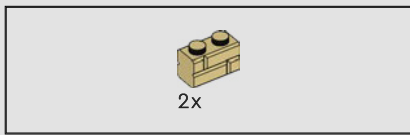

479

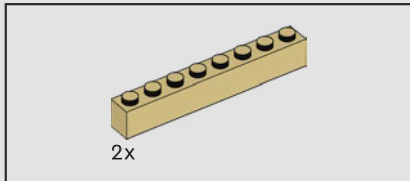
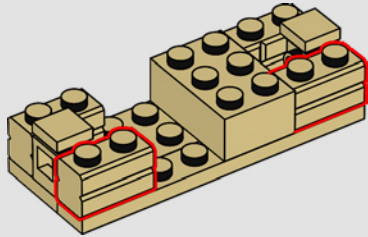

480

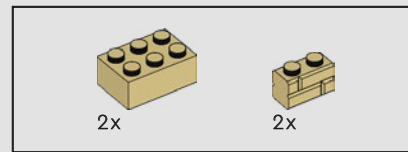
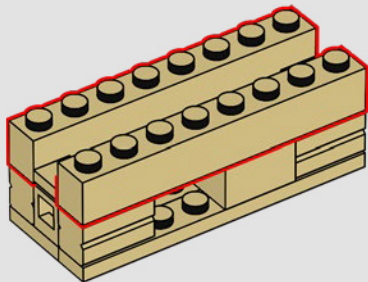

481

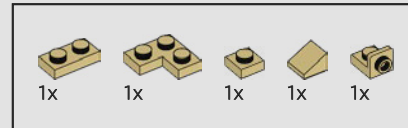
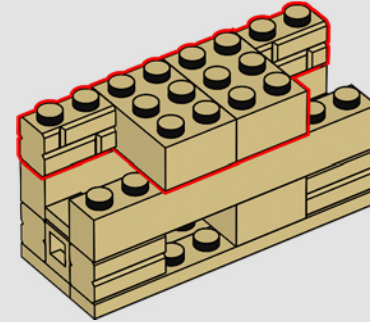

482

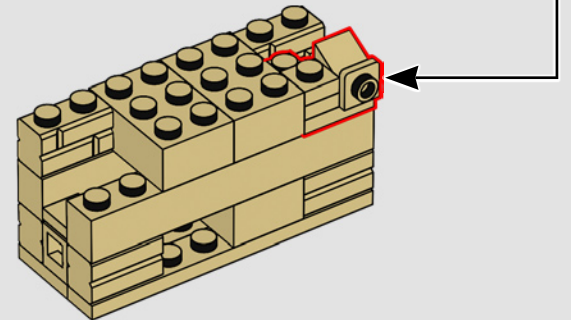
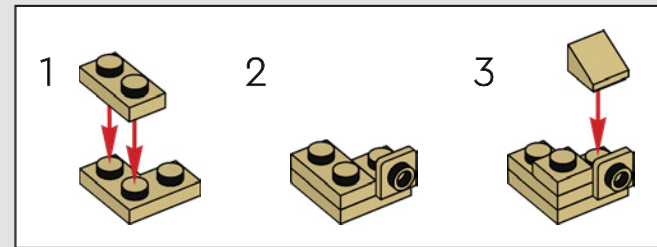

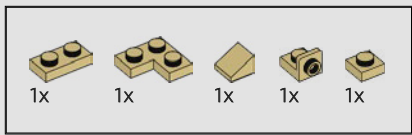

483

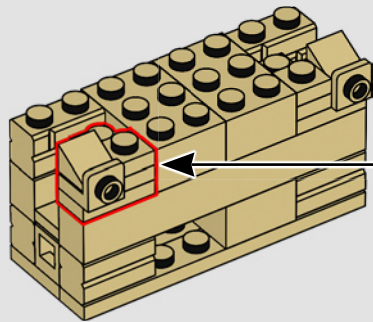
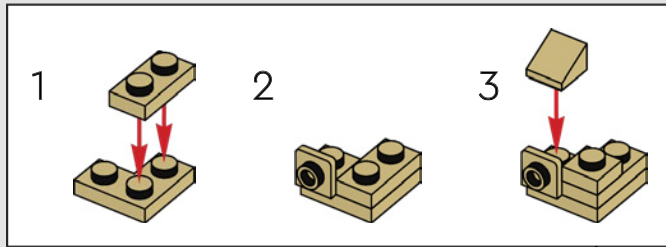

484

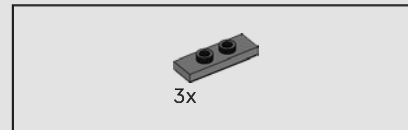
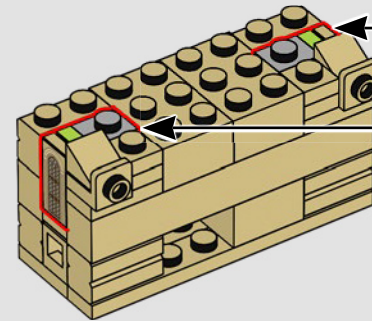
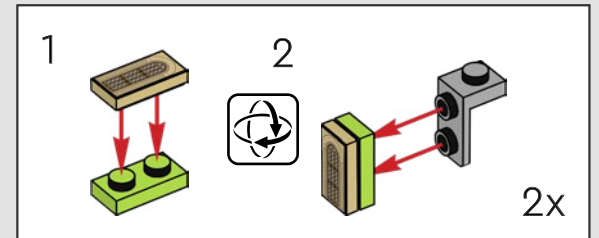

485

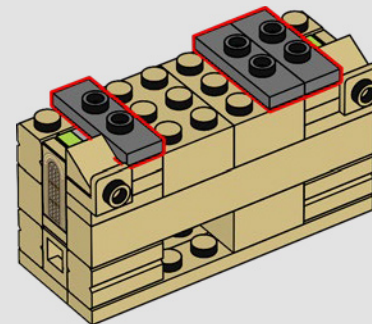

486



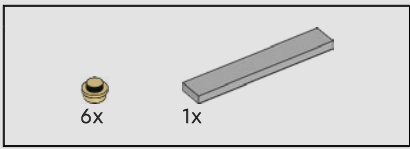

487

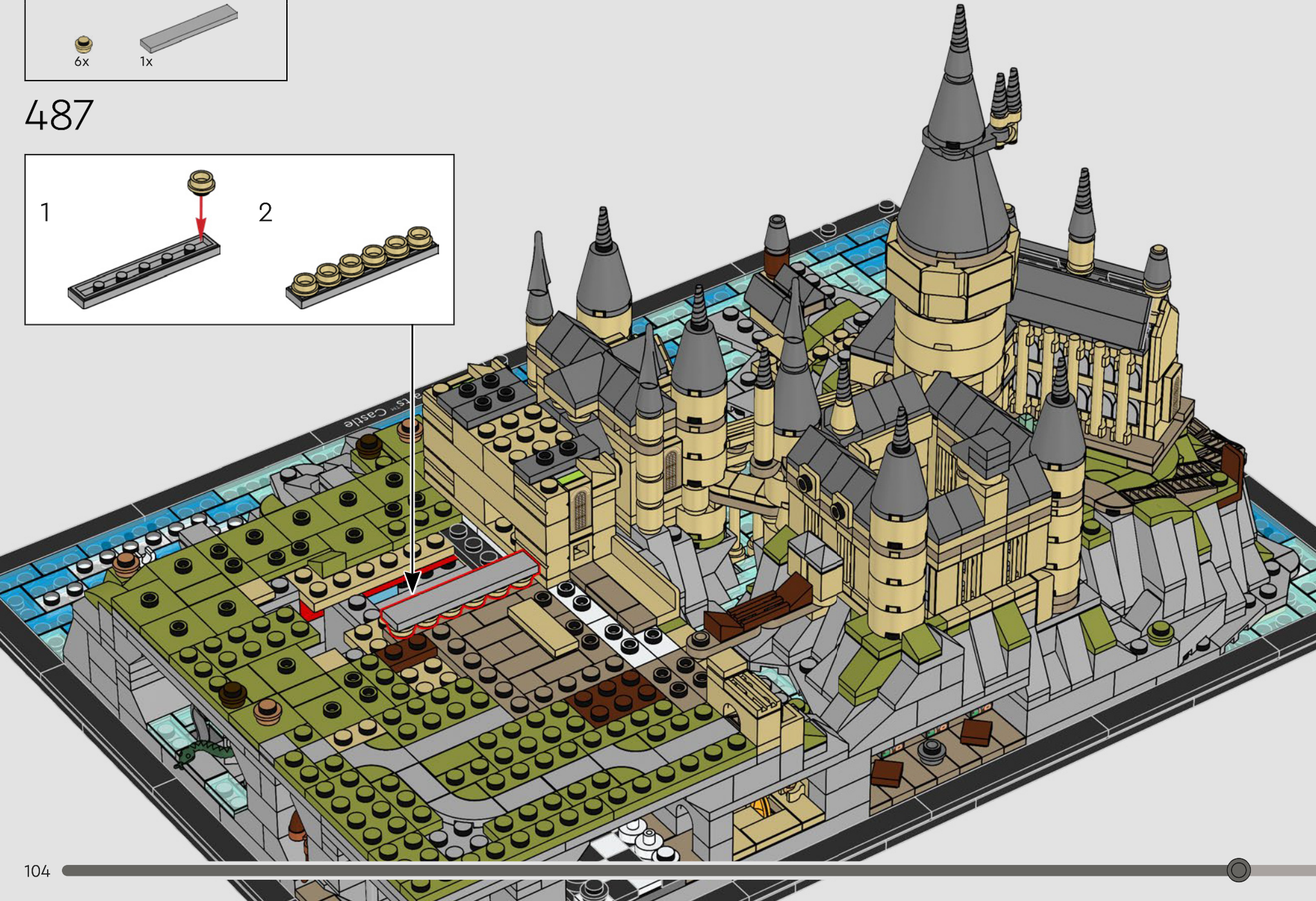
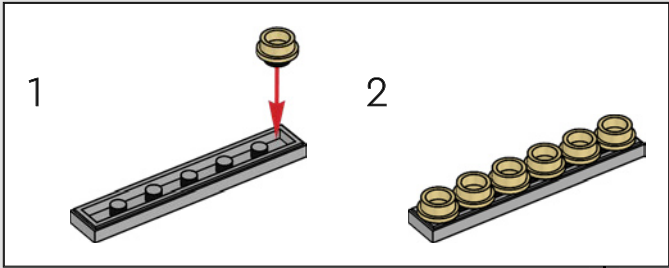



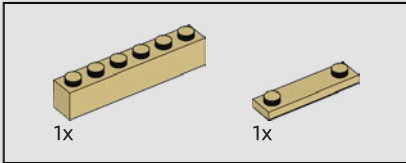
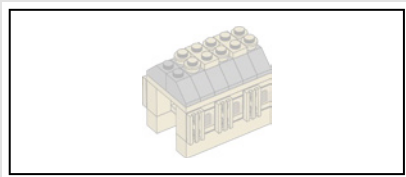

488

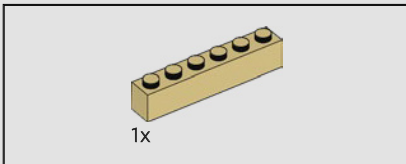
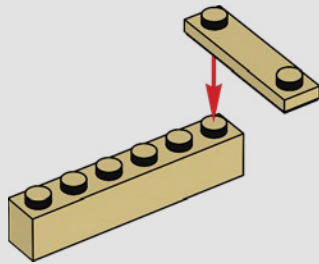

489

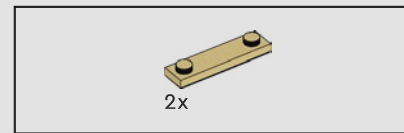
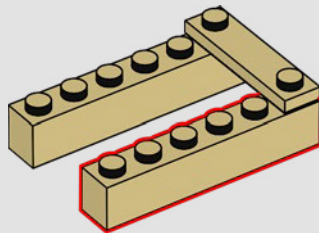

490

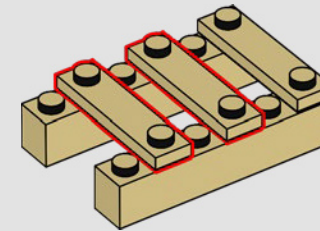

491

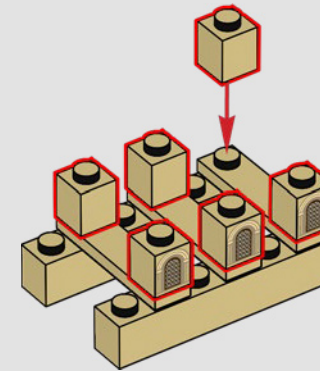

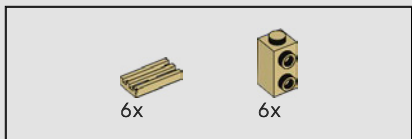

492

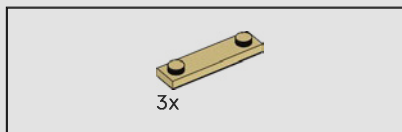
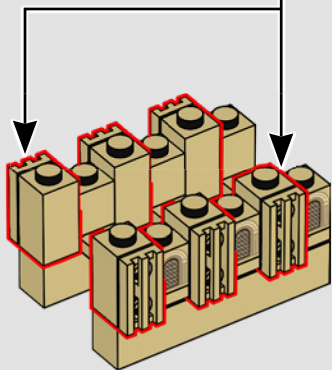
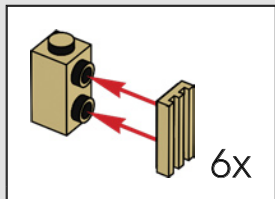

493

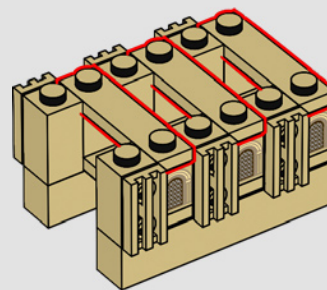

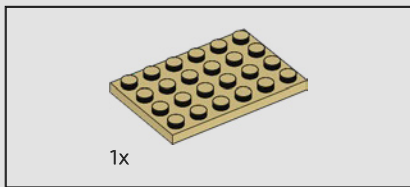

494

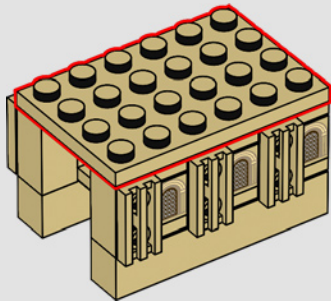

495

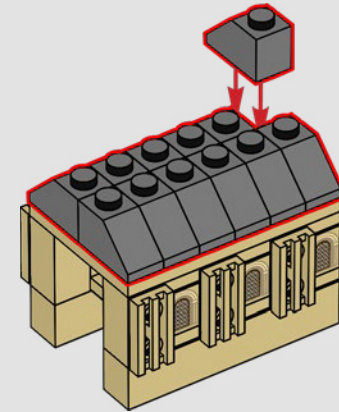

496

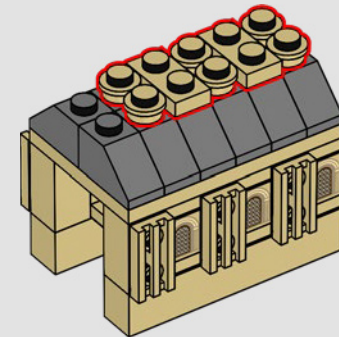

497

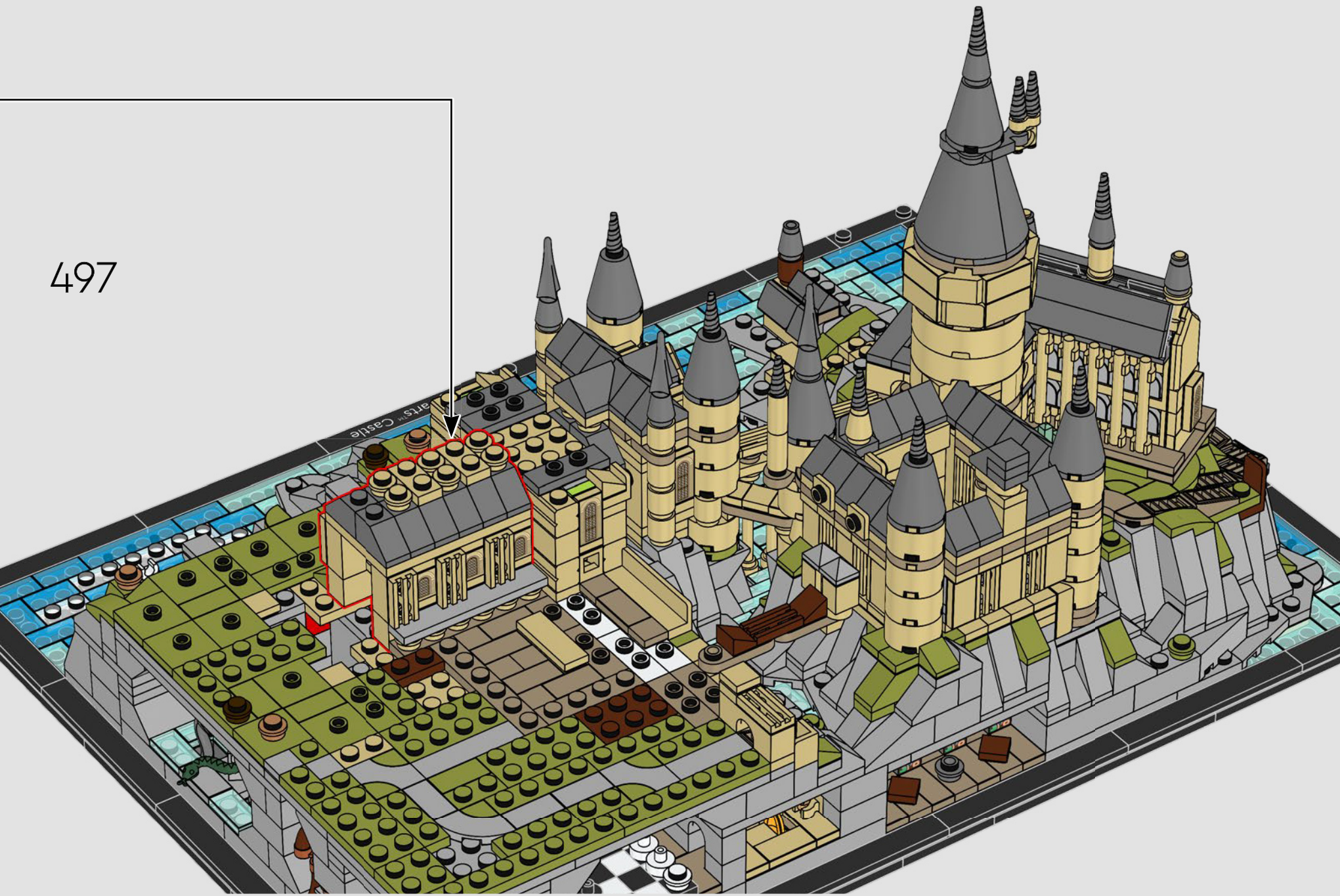

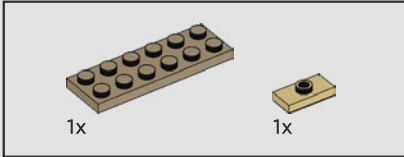
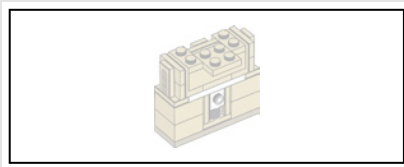

498

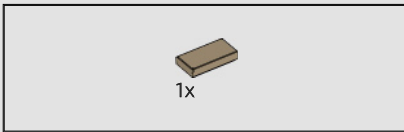
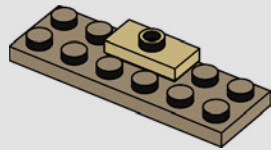

499

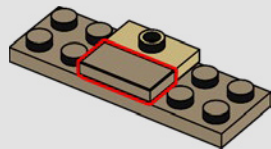

500

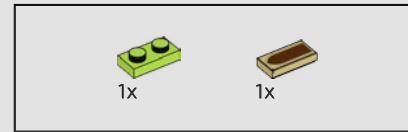
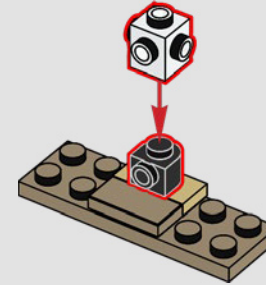

501

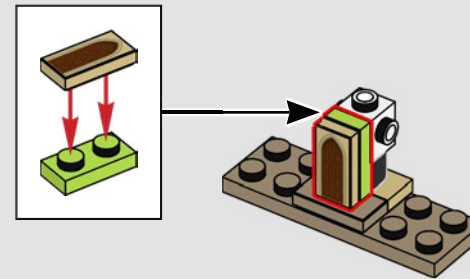

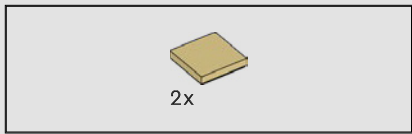

502

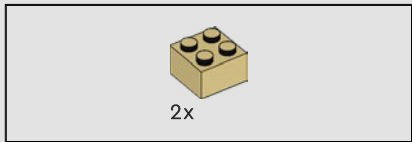
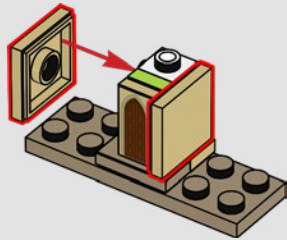

503

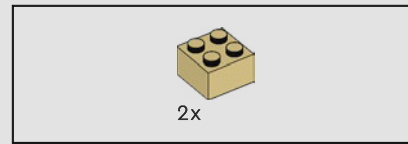
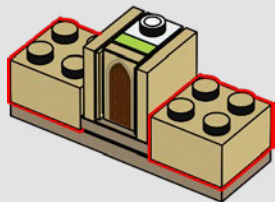

504

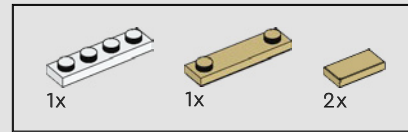
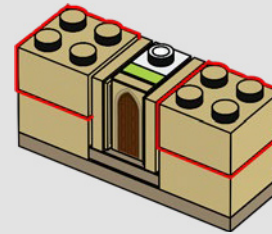

505

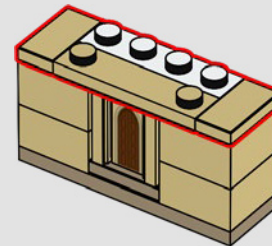

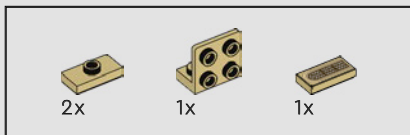

506

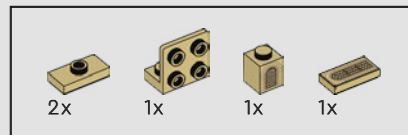
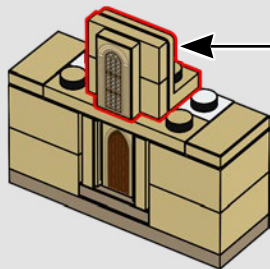
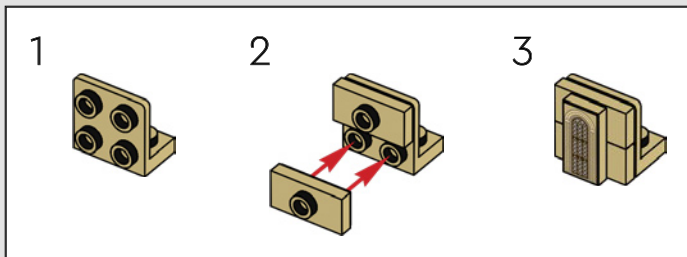

507

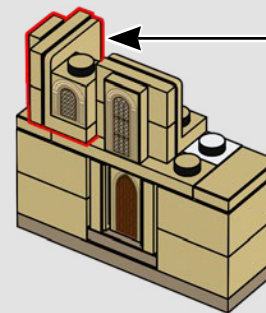
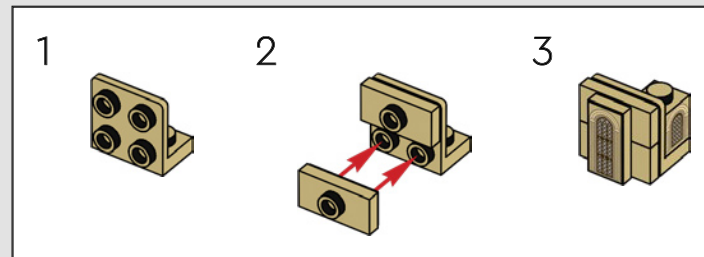

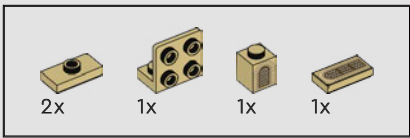

508

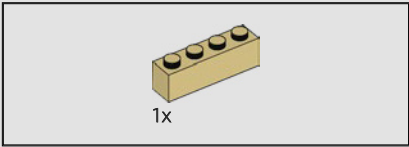
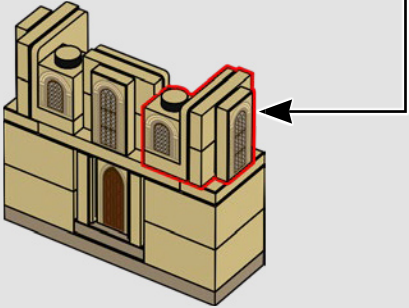
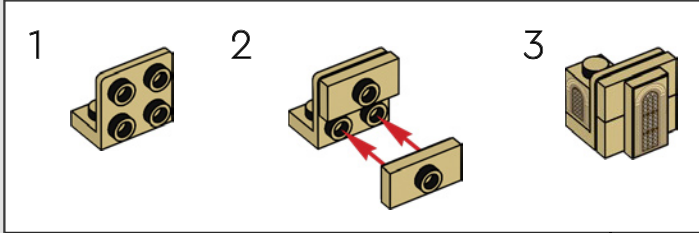

509

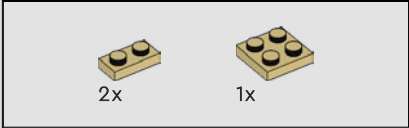
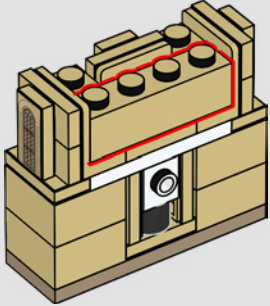

510

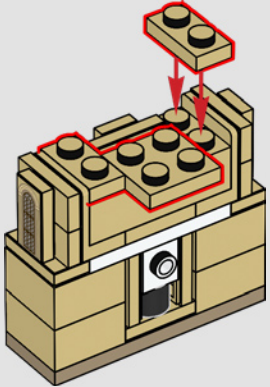



511





2x



2x



2x



2x



2x



2x



2x



2x



2x

512

1

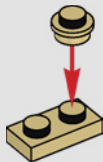

2

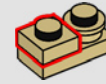

3

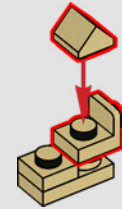

4

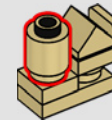

5

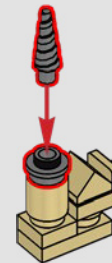

2x



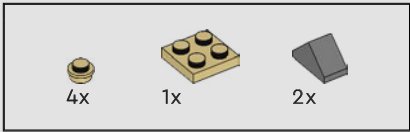

513

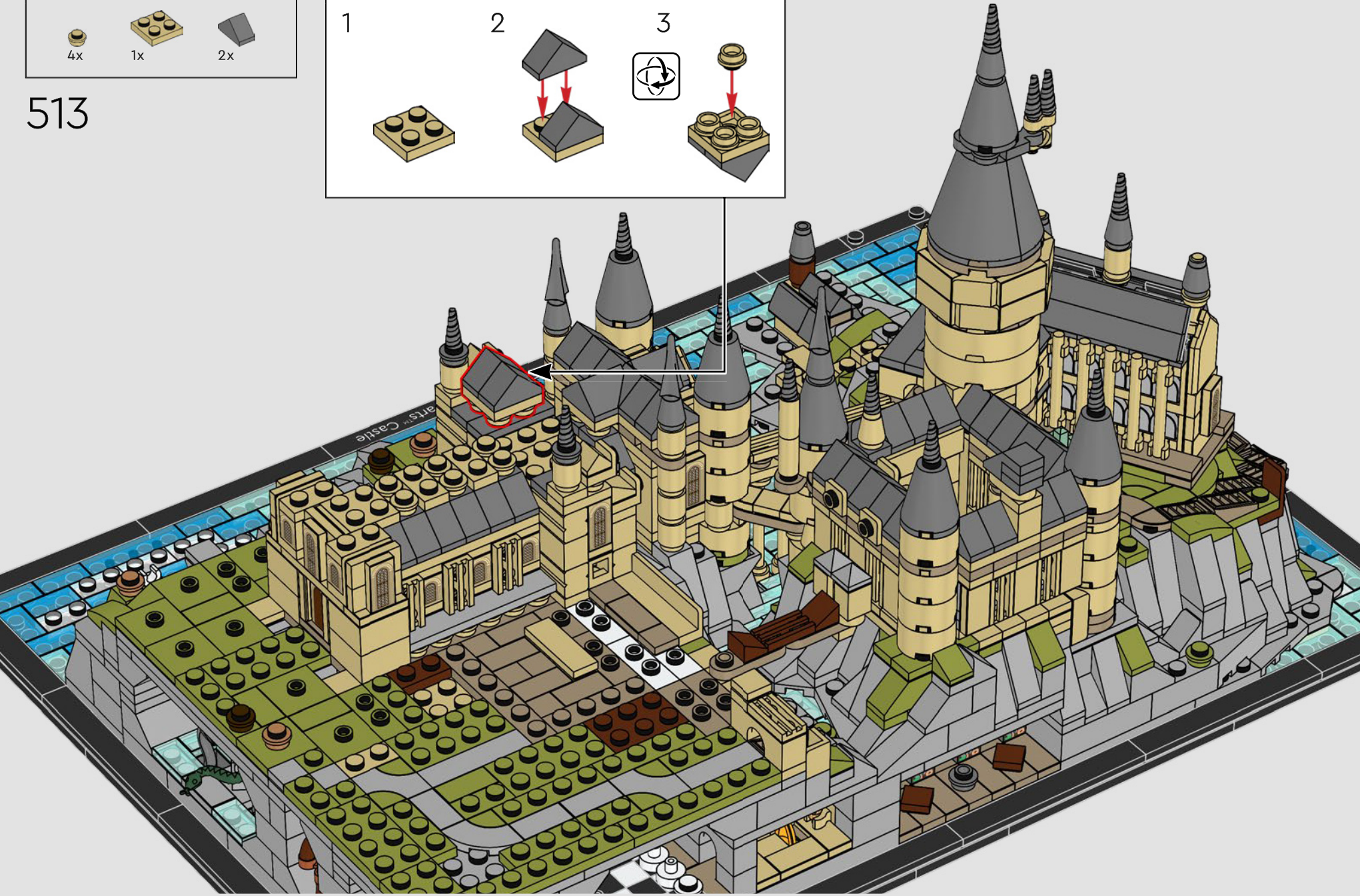
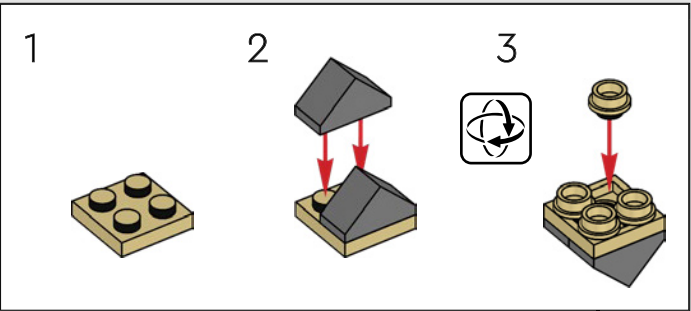

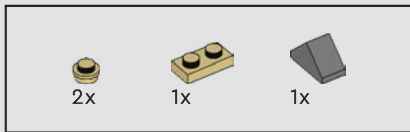

514

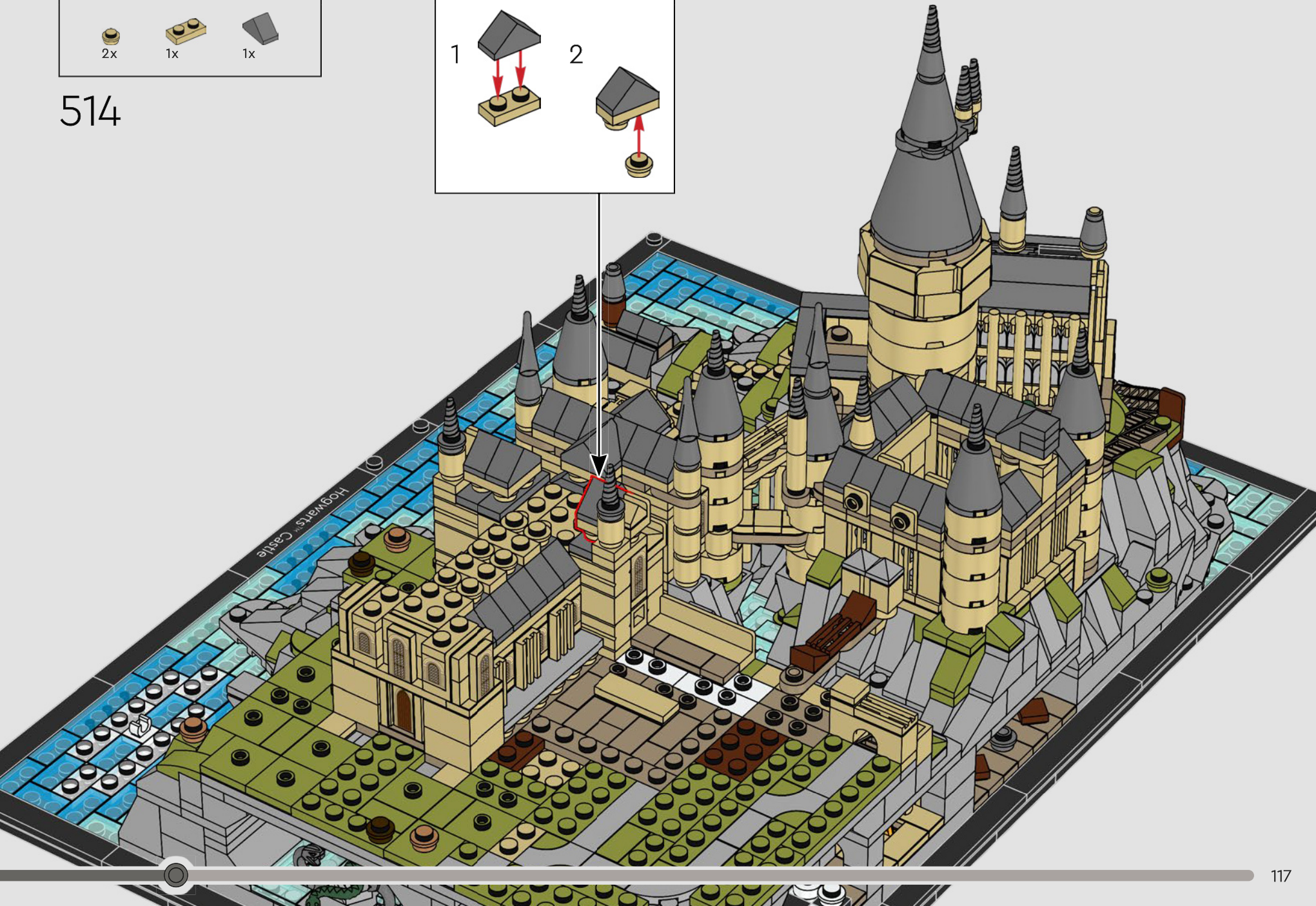
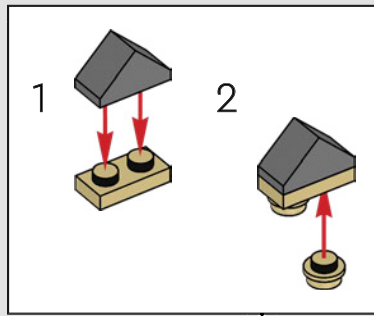

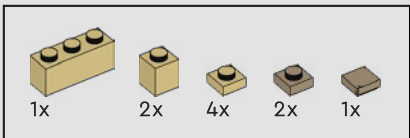

515

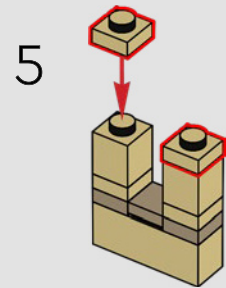
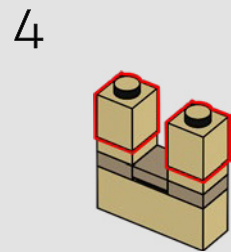
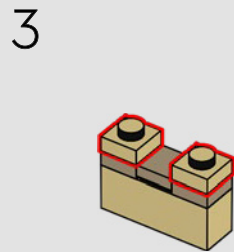
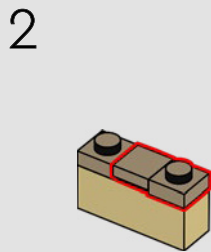
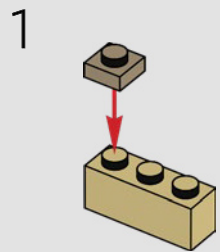

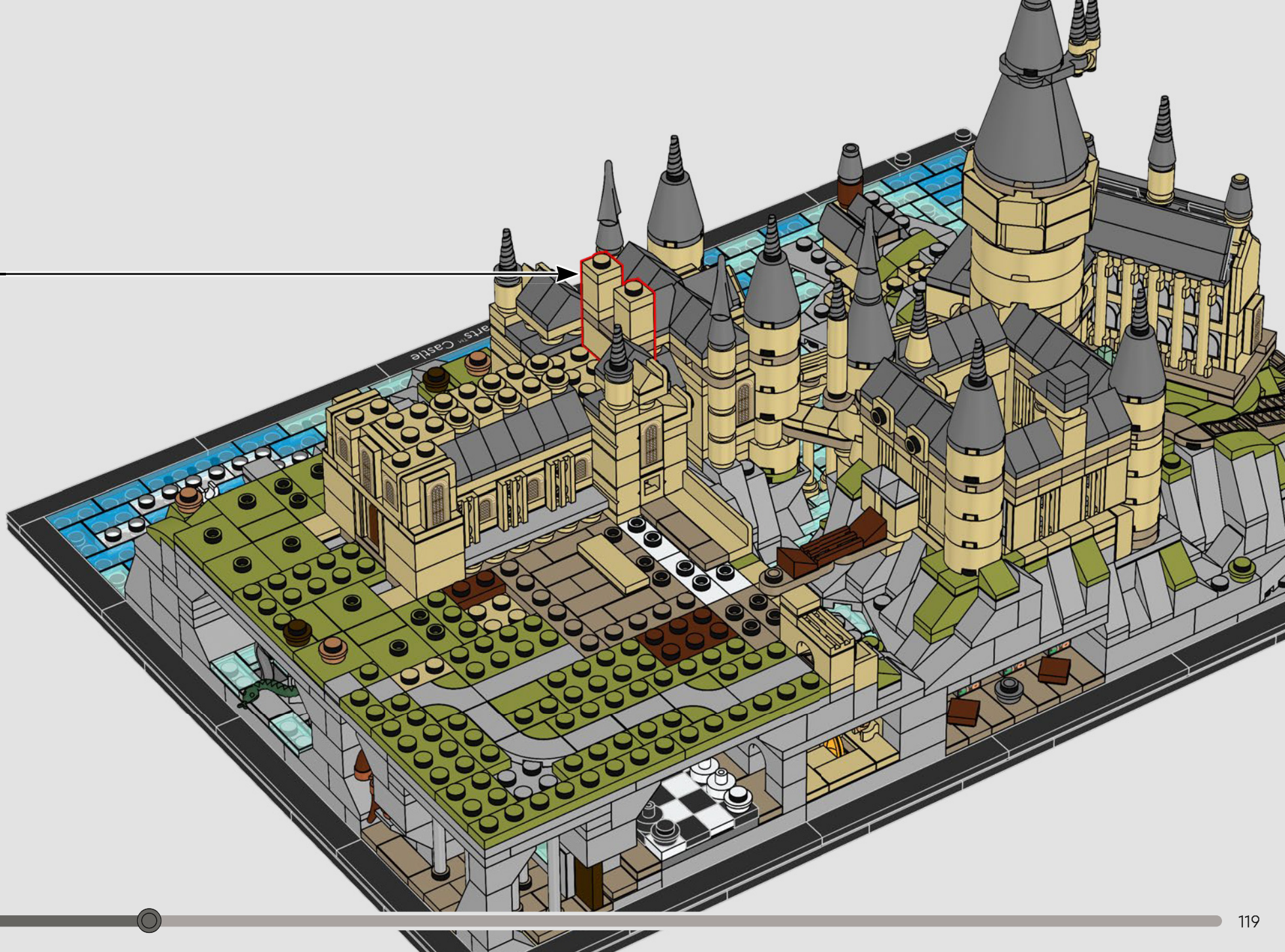

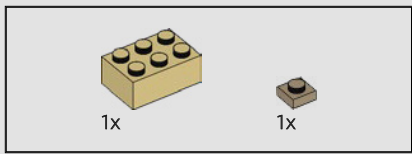

516

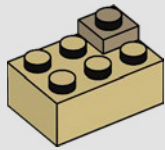

517

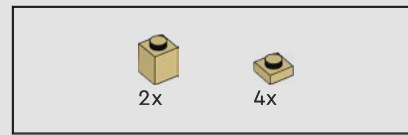
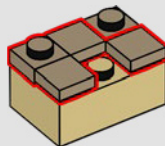

518

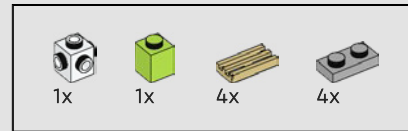
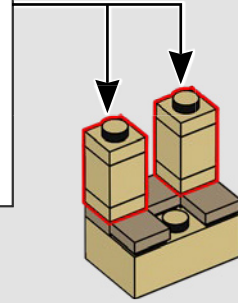
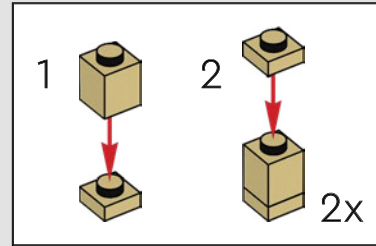

519

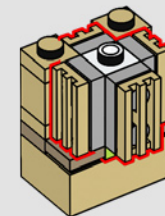
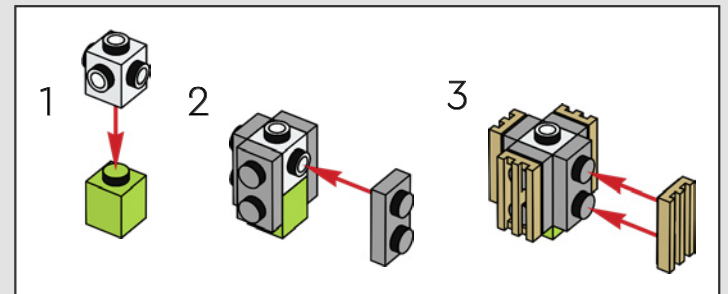



520

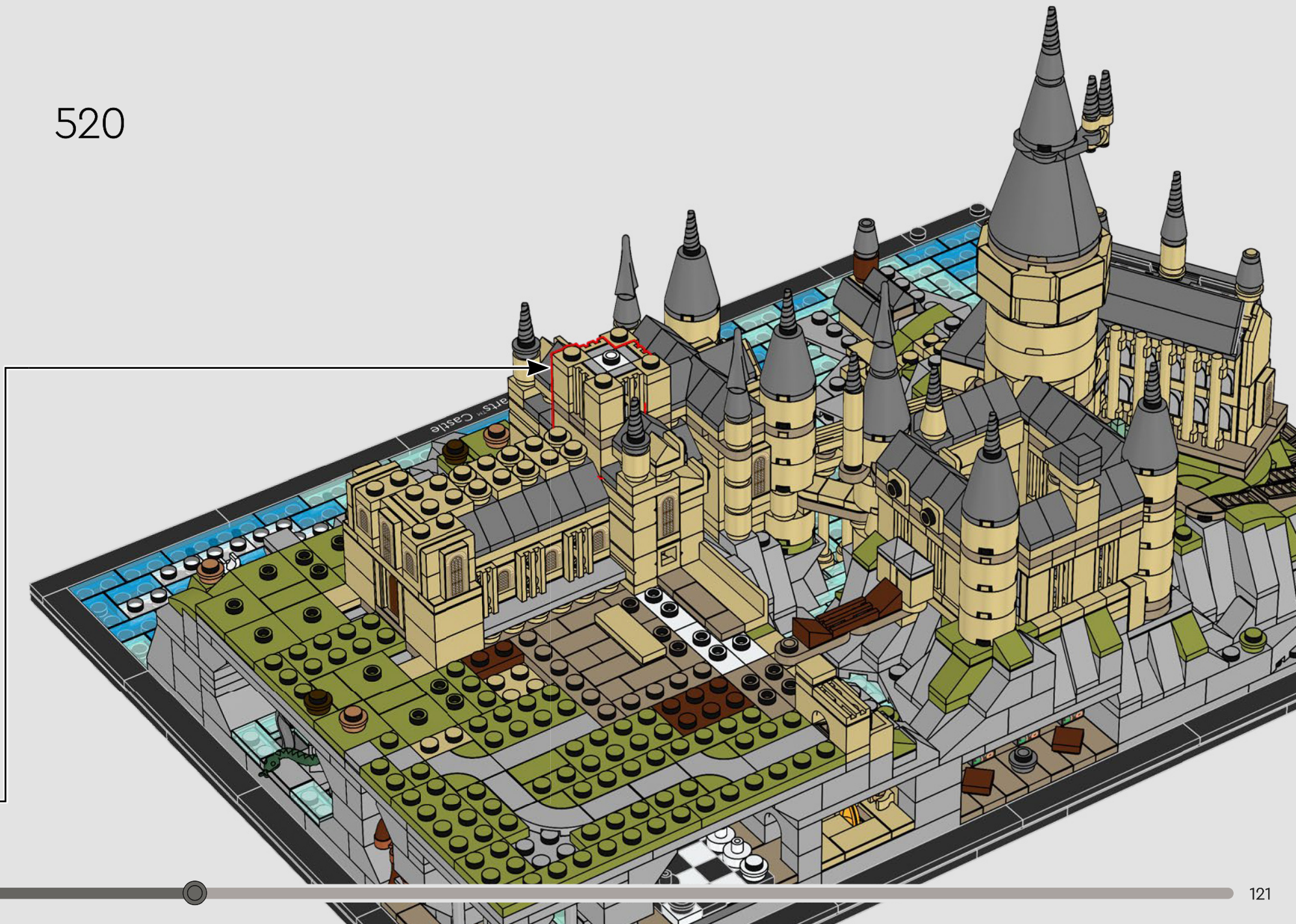

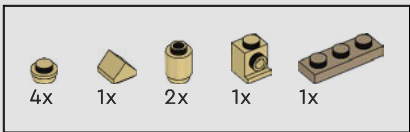

521

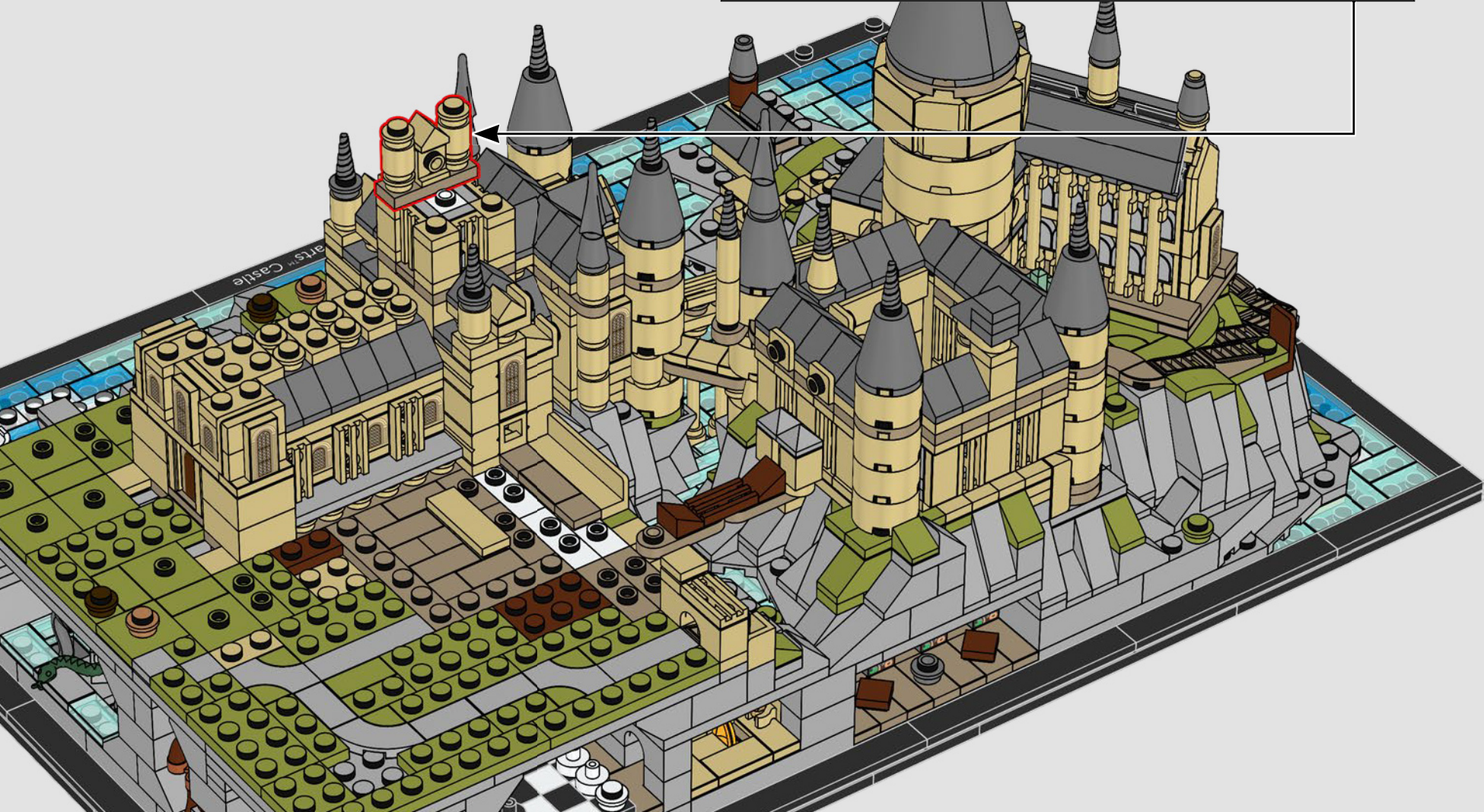
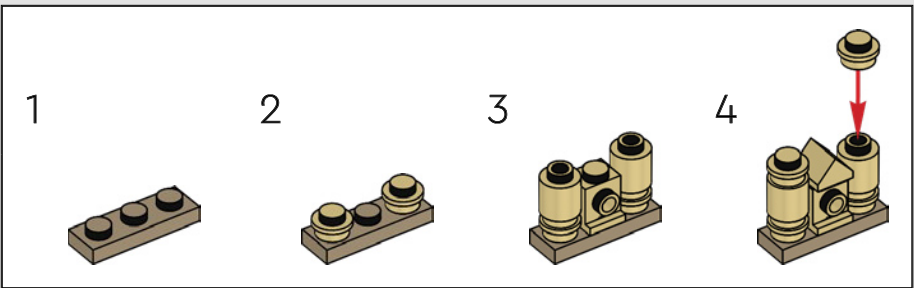

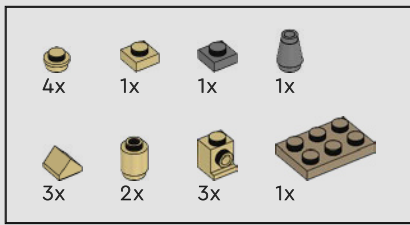

522

1

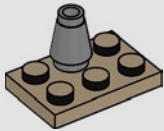

2

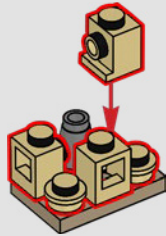

3

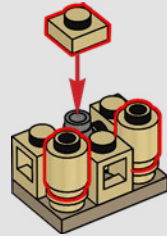

4

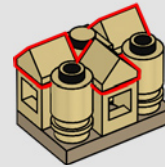

5

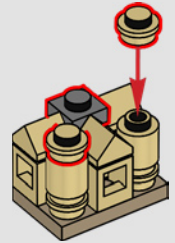

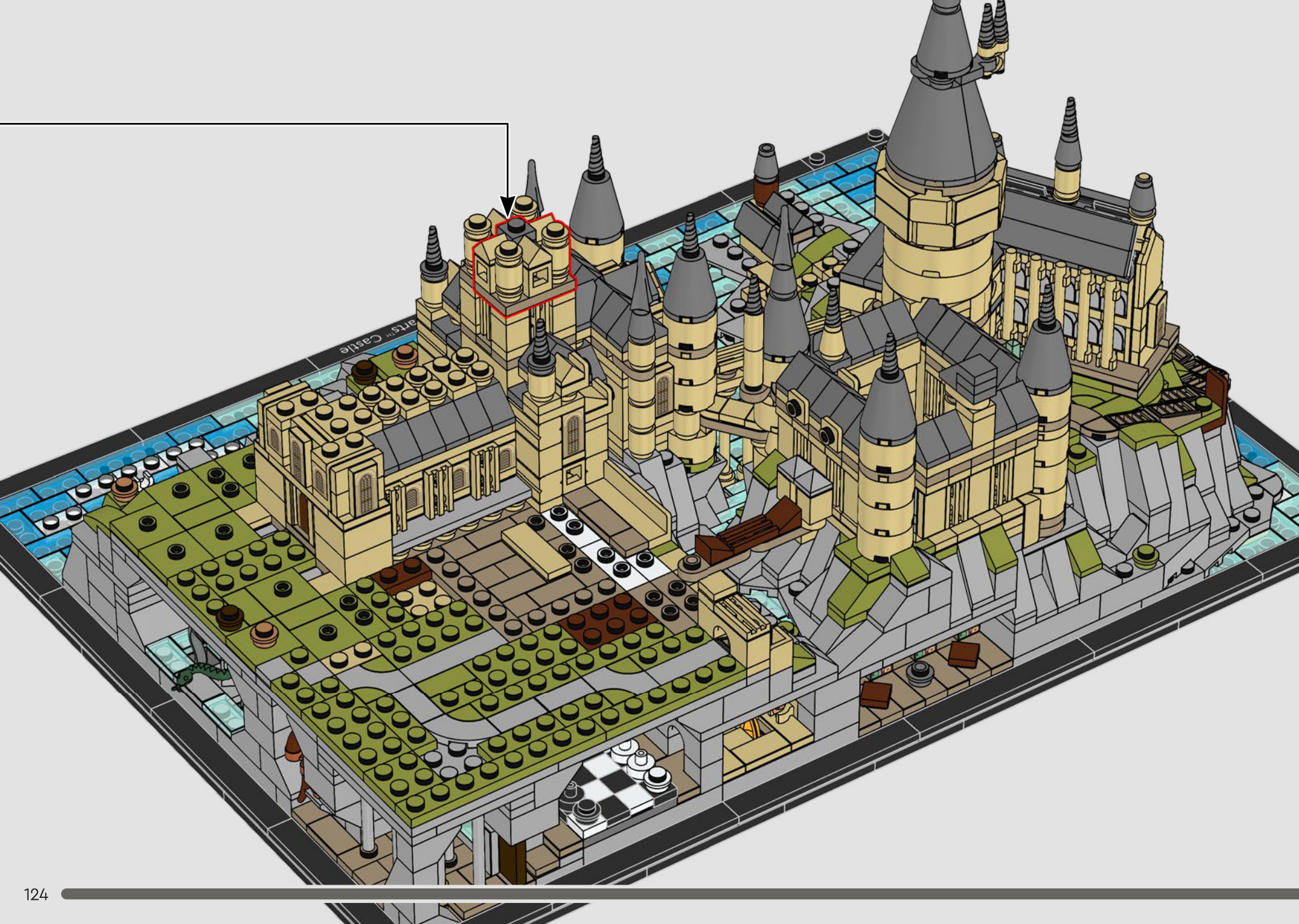

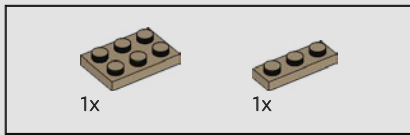

523



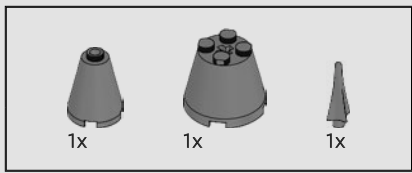

524

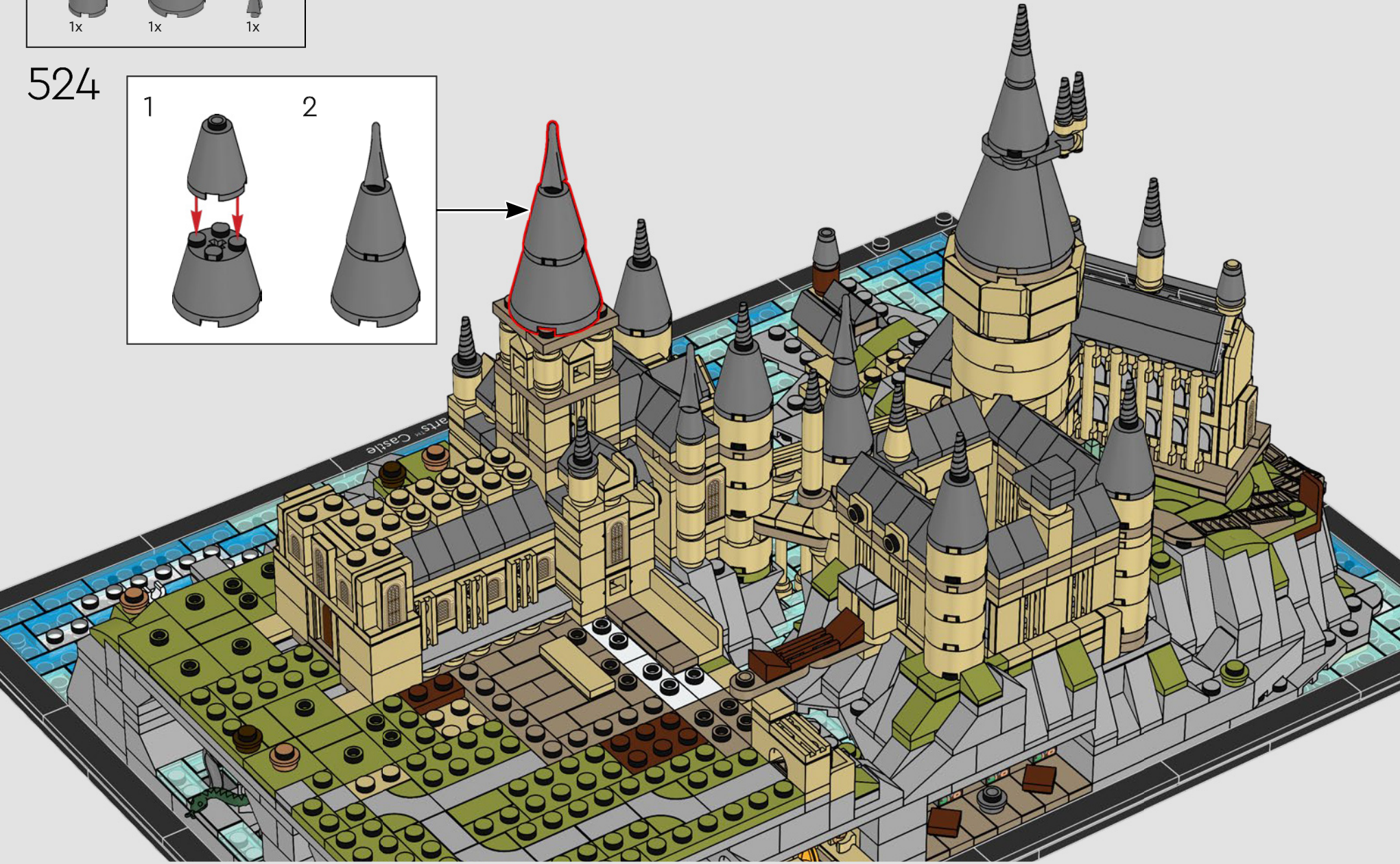
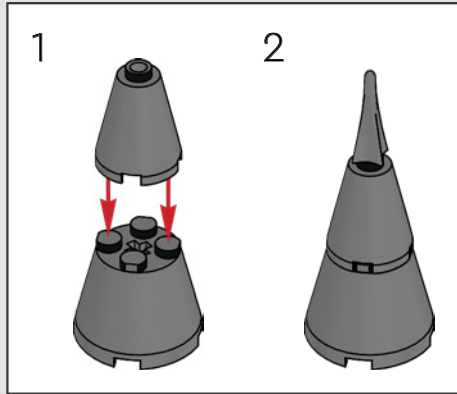

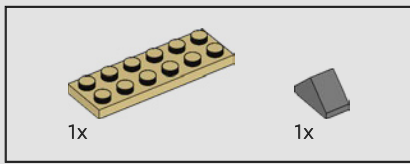

525

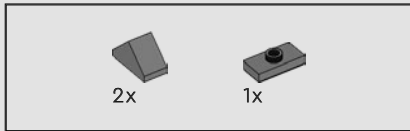
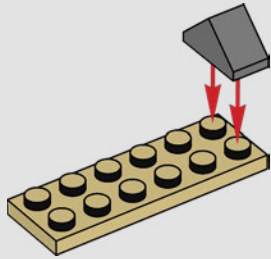

526

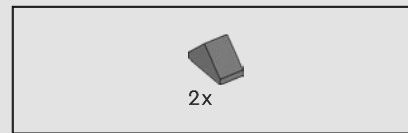
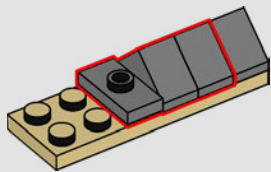

527

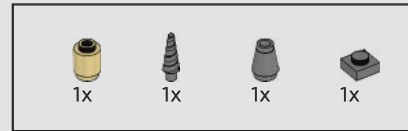
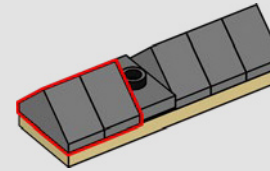

528

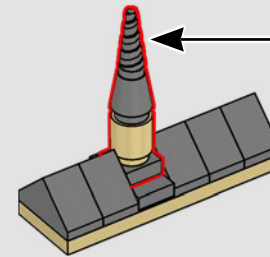
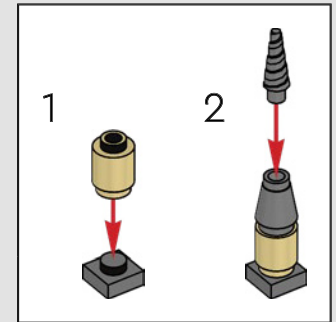

529

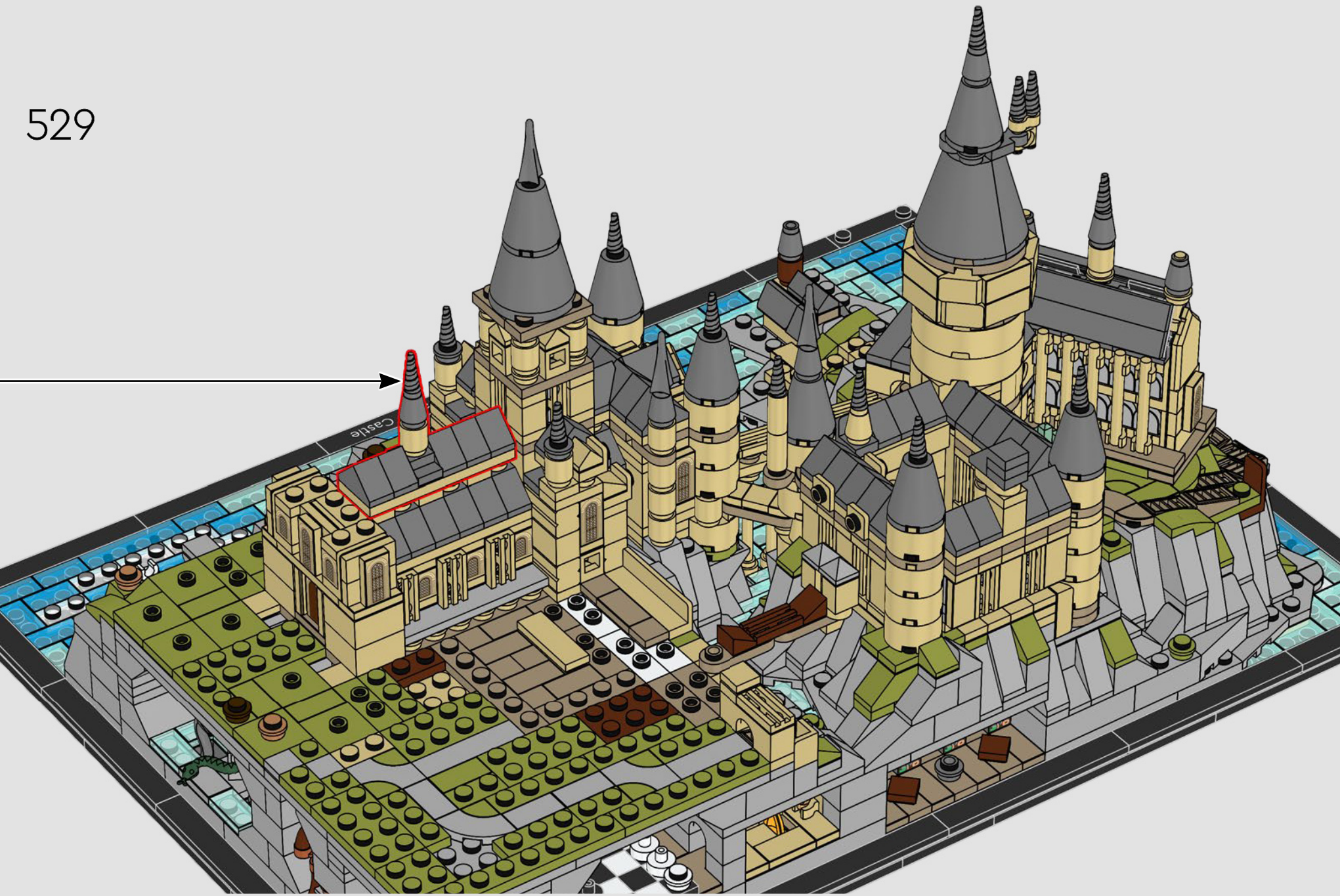



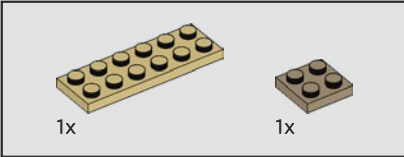
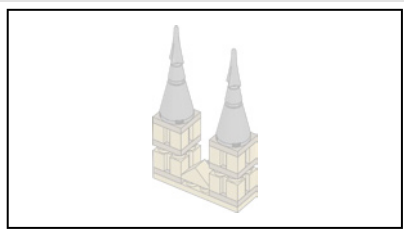

530

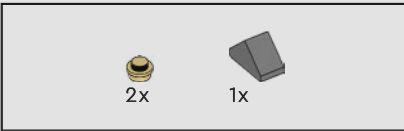
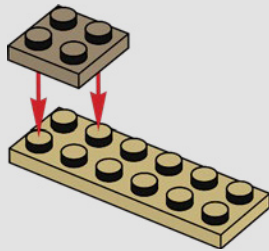

531

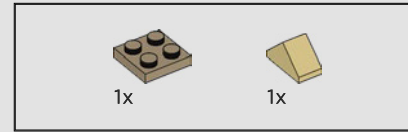
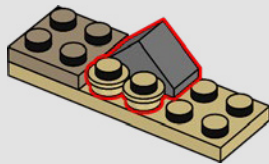

532

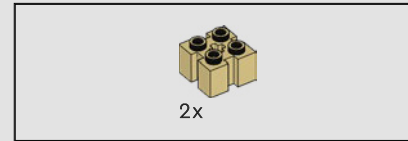
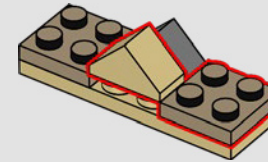

533

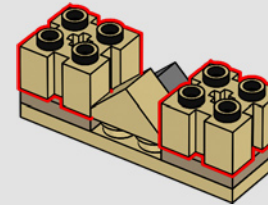



8x

534

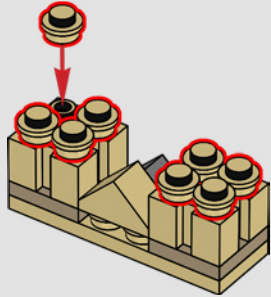

2x

535

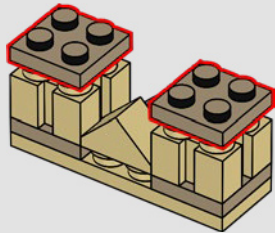

2x

536

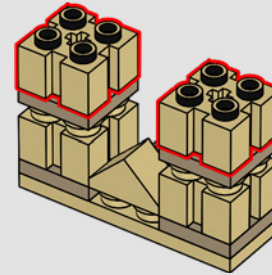

2x

537

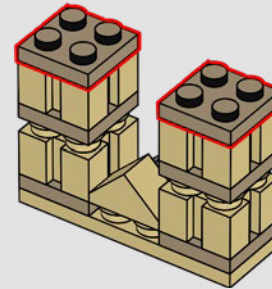

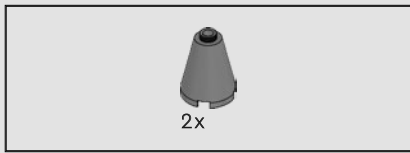

538

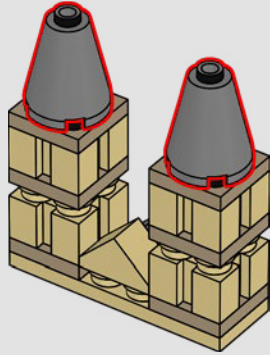

539

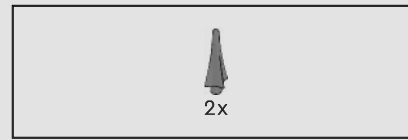
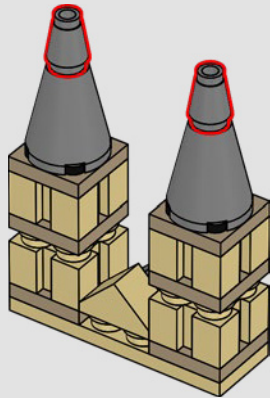

540

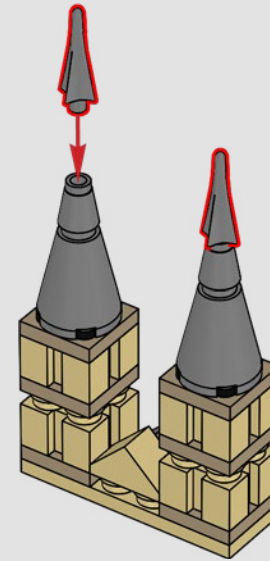

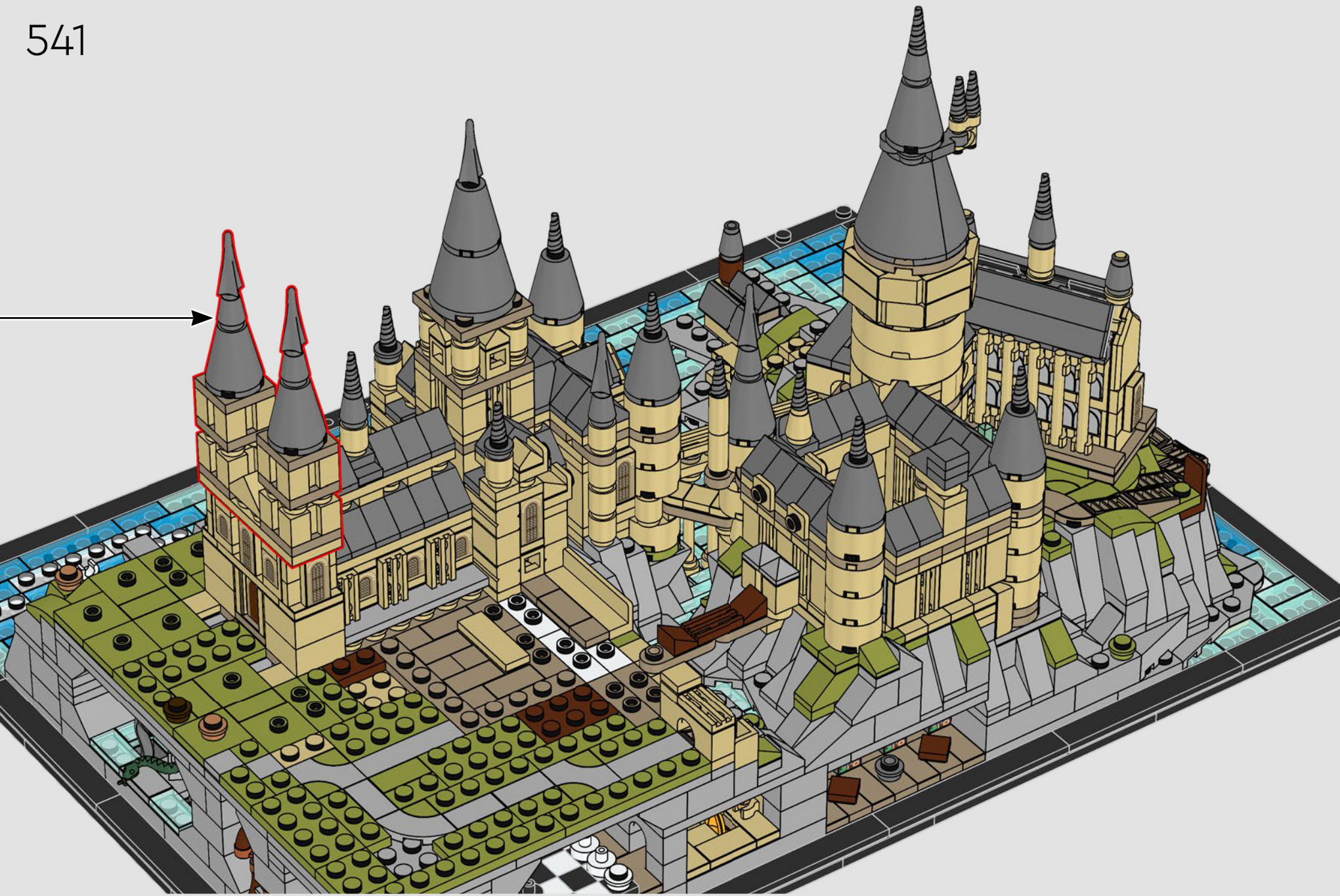

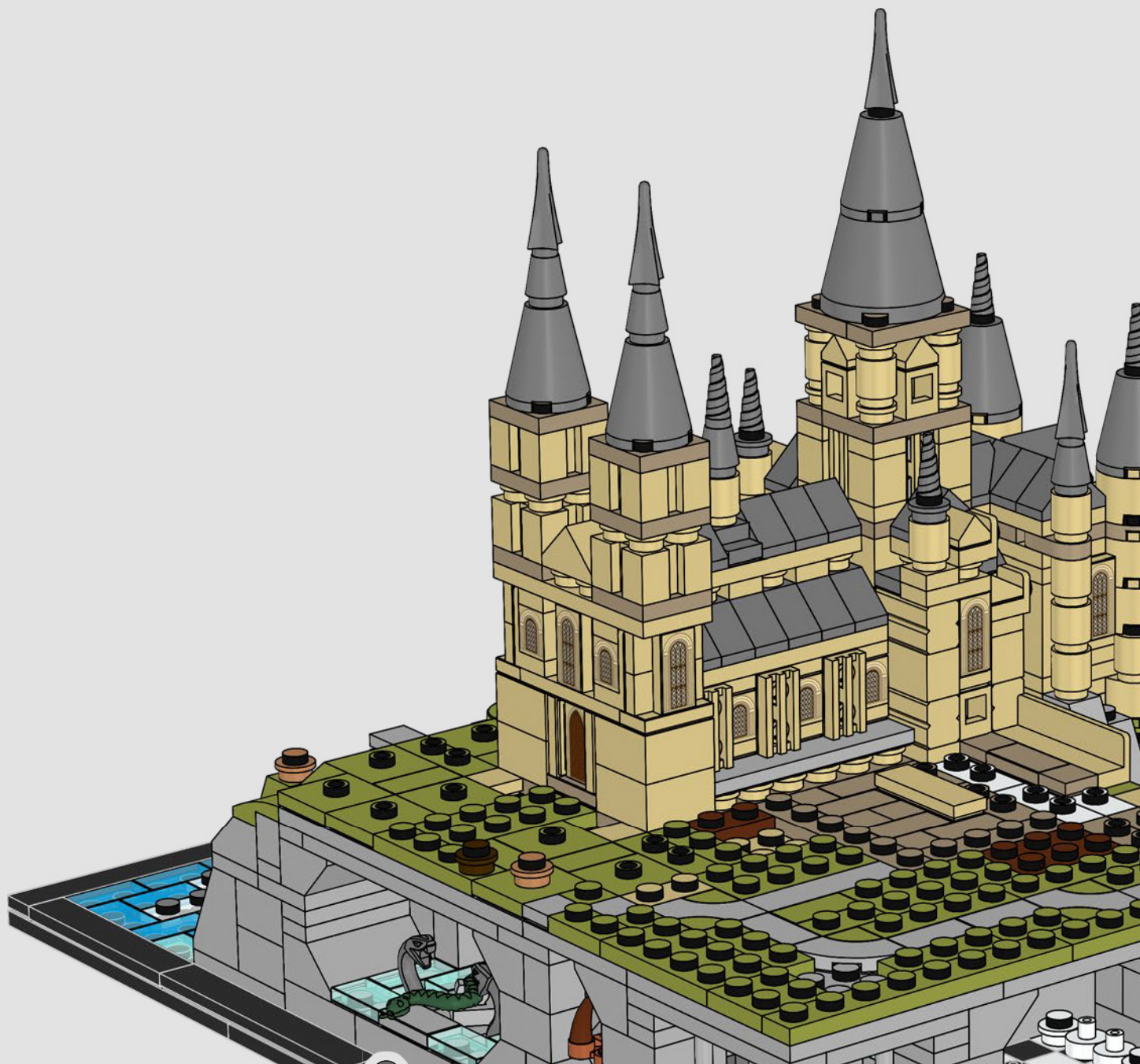

Indipendentemente dalle materie preferite dagli studenti di Hogwarts™, è probabile che essi trascorrono gran parte del loro tempo nell'Ala Est, dove si trovano molte delle aule.



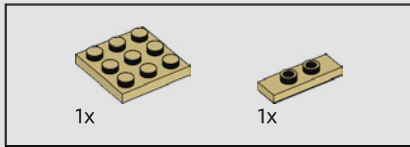
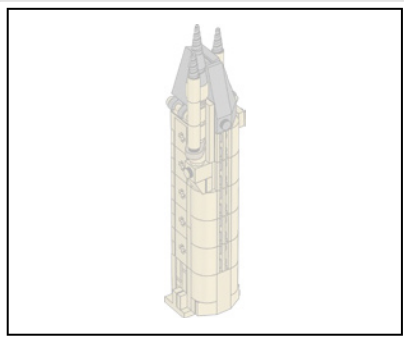

542

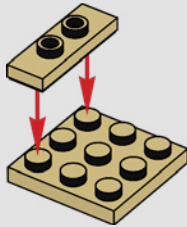

543

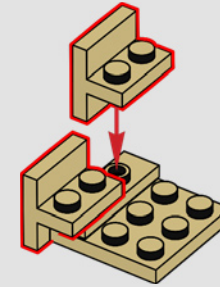

544

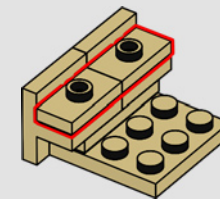



2x

545

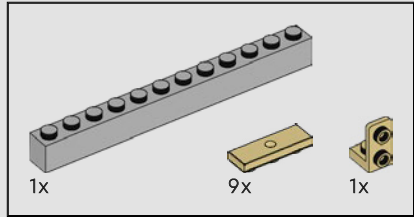
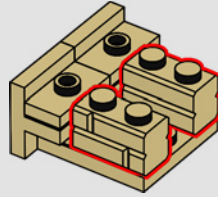

546

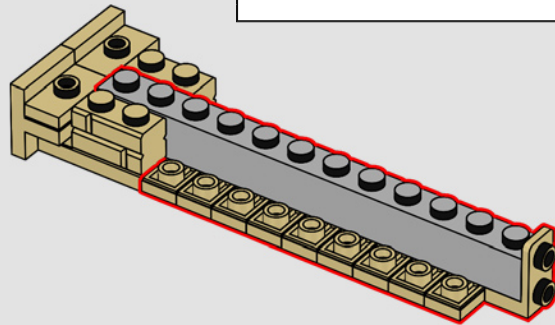
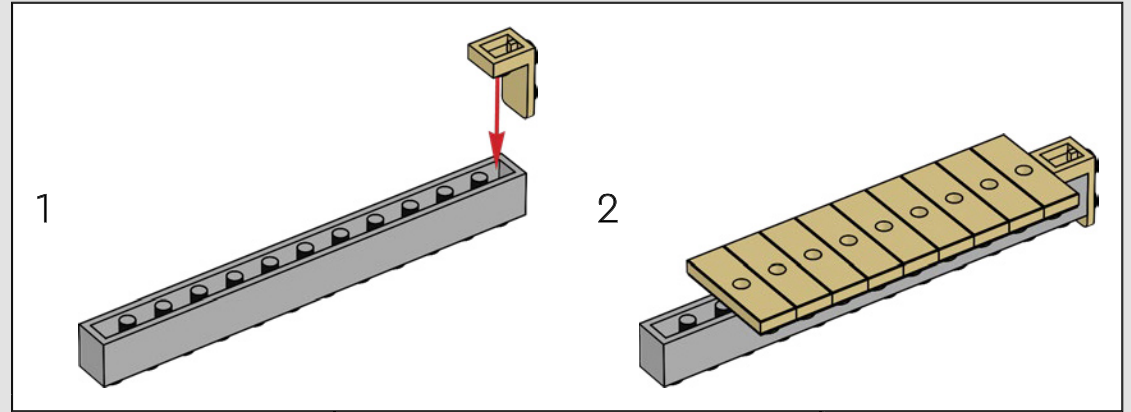



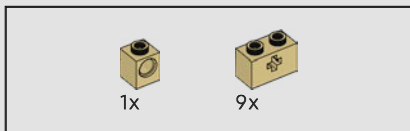

547

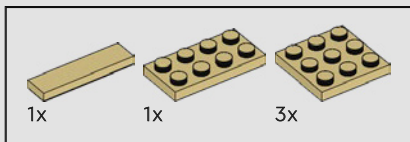
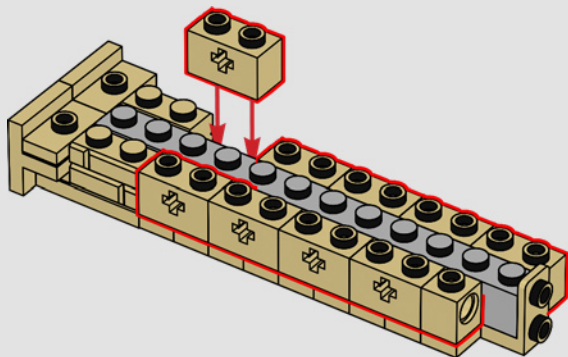

548

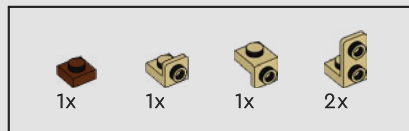
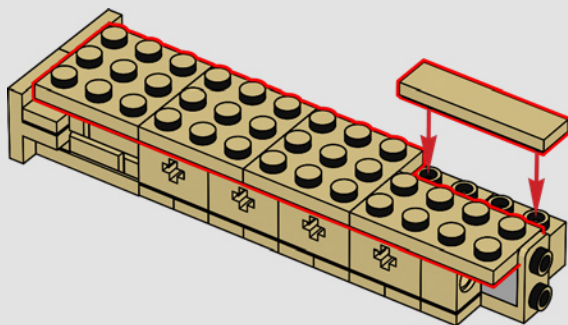

549

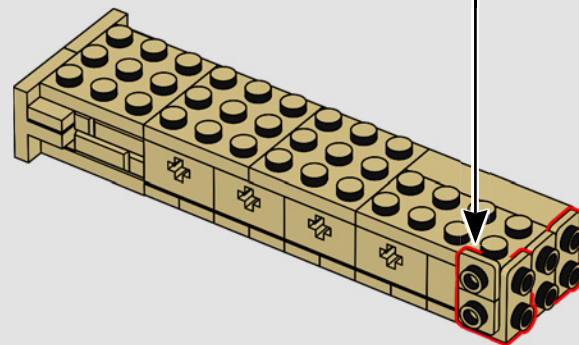
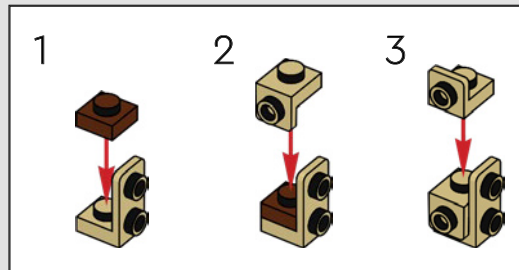

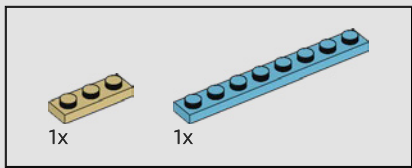

550

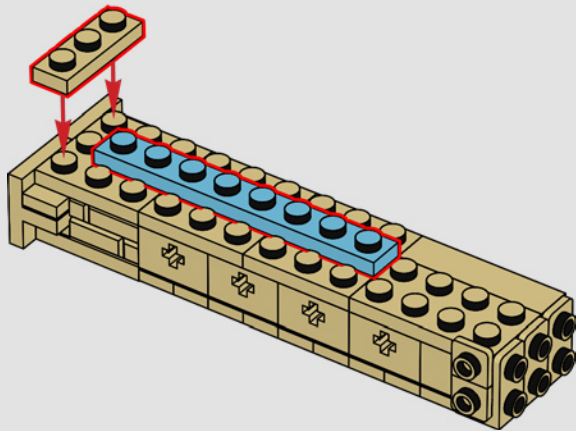

551

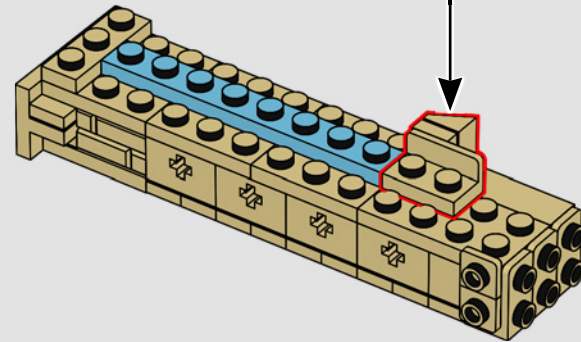
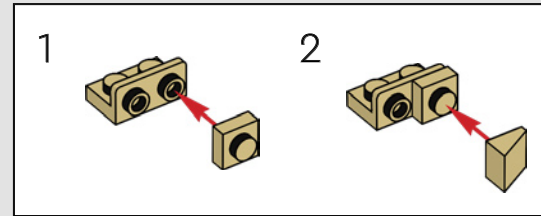

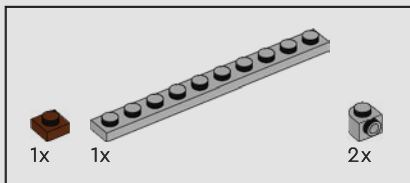

552

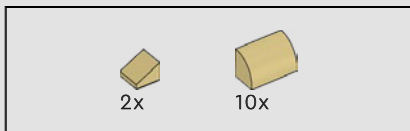
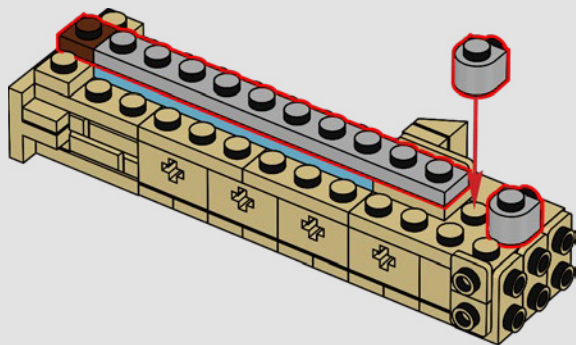

553

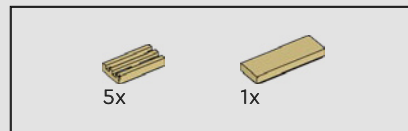
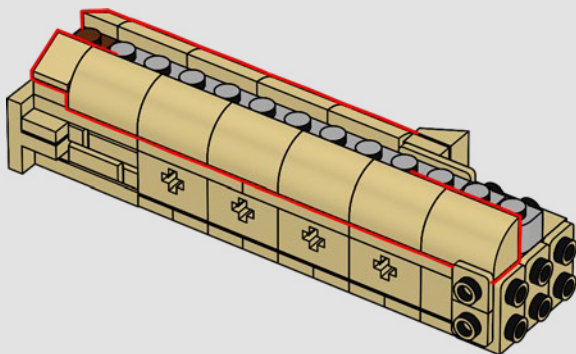

554

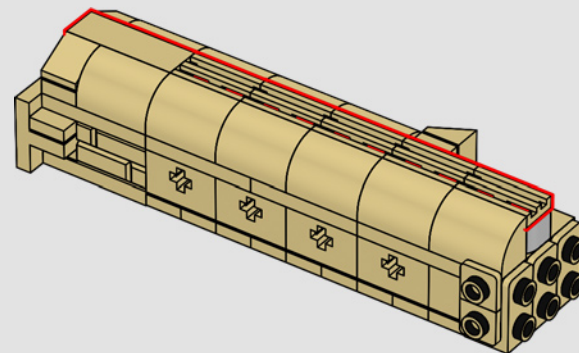



1x

555

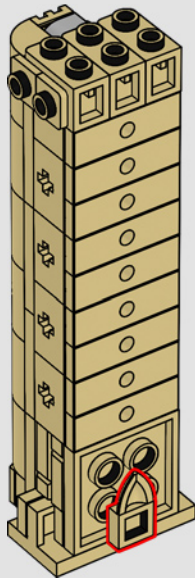

2x

556

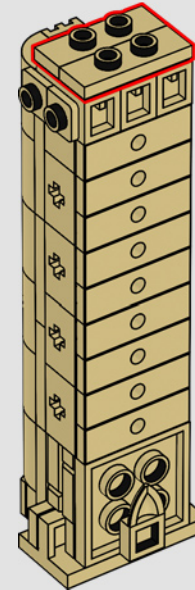

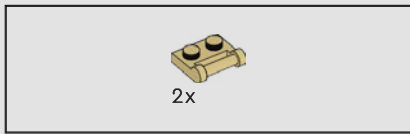

557

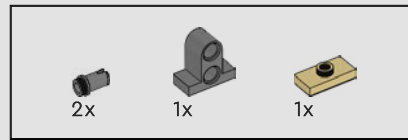
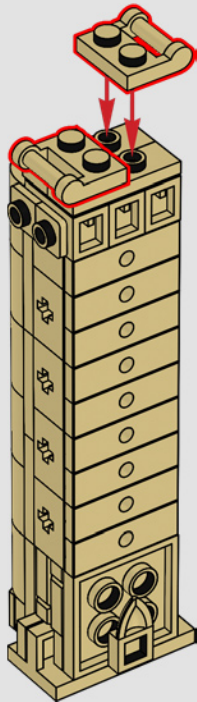

558

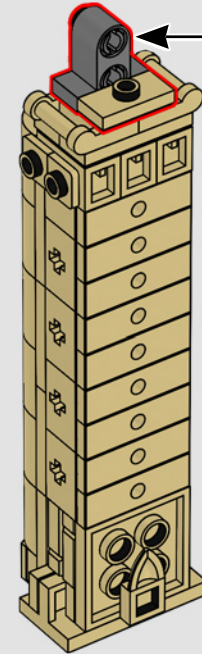
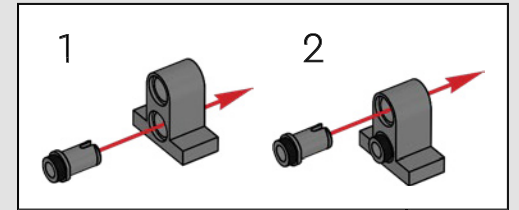



559

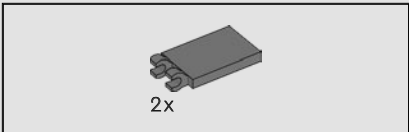

560

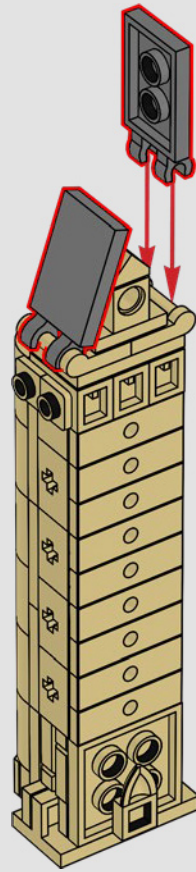



561

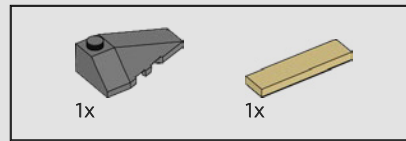
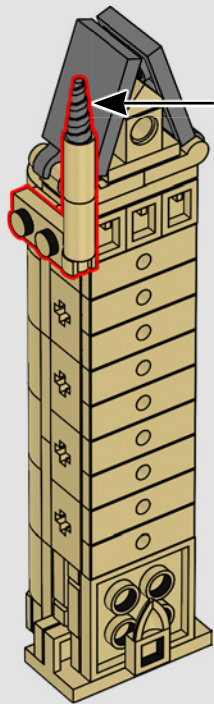
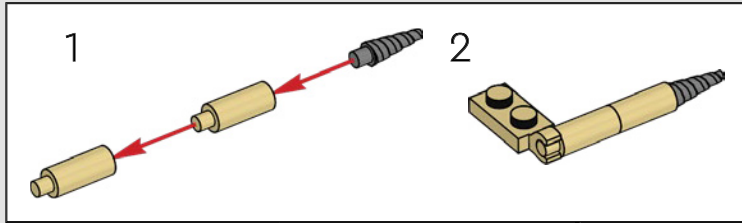

562

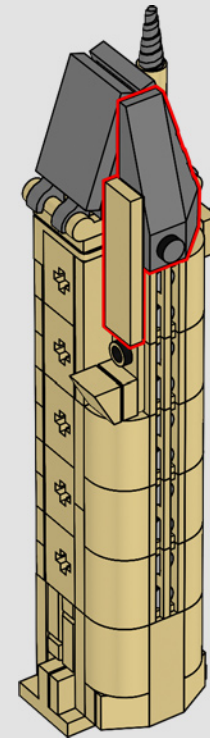
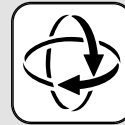

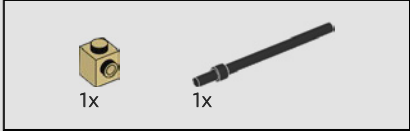
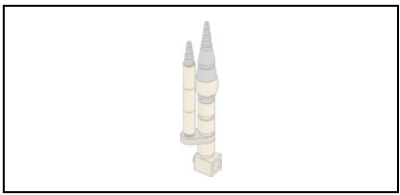

563

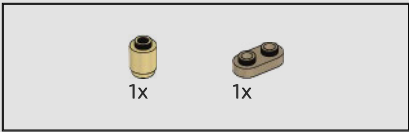

564



565







566

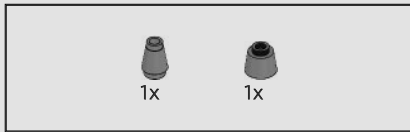

567

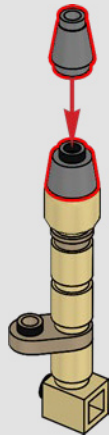

568

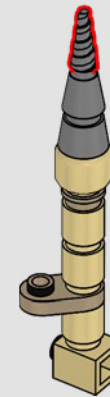

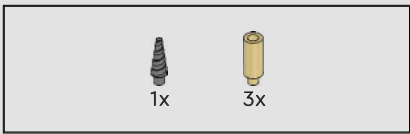

569

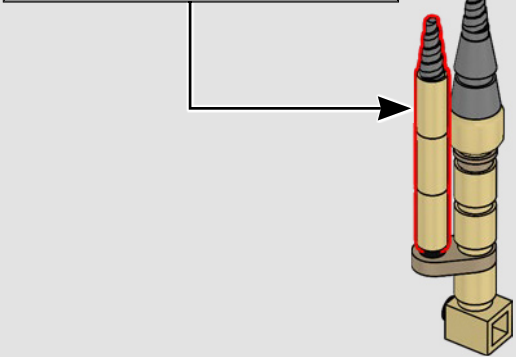
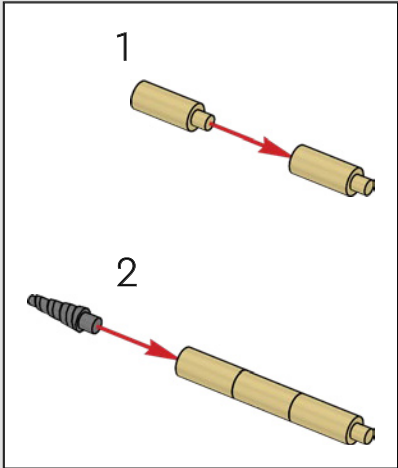

570

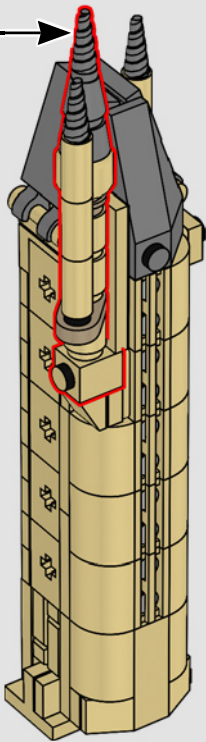

571

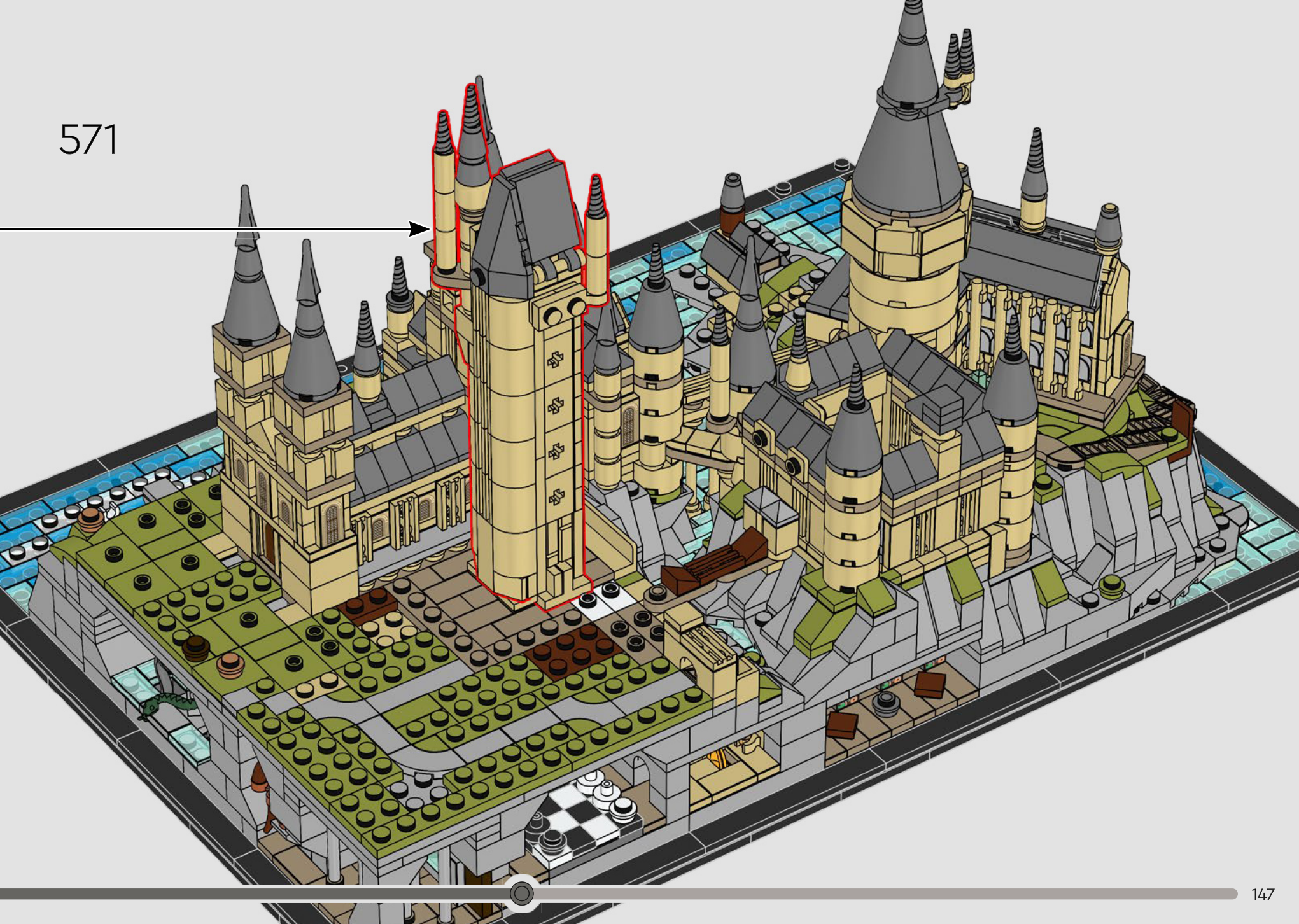

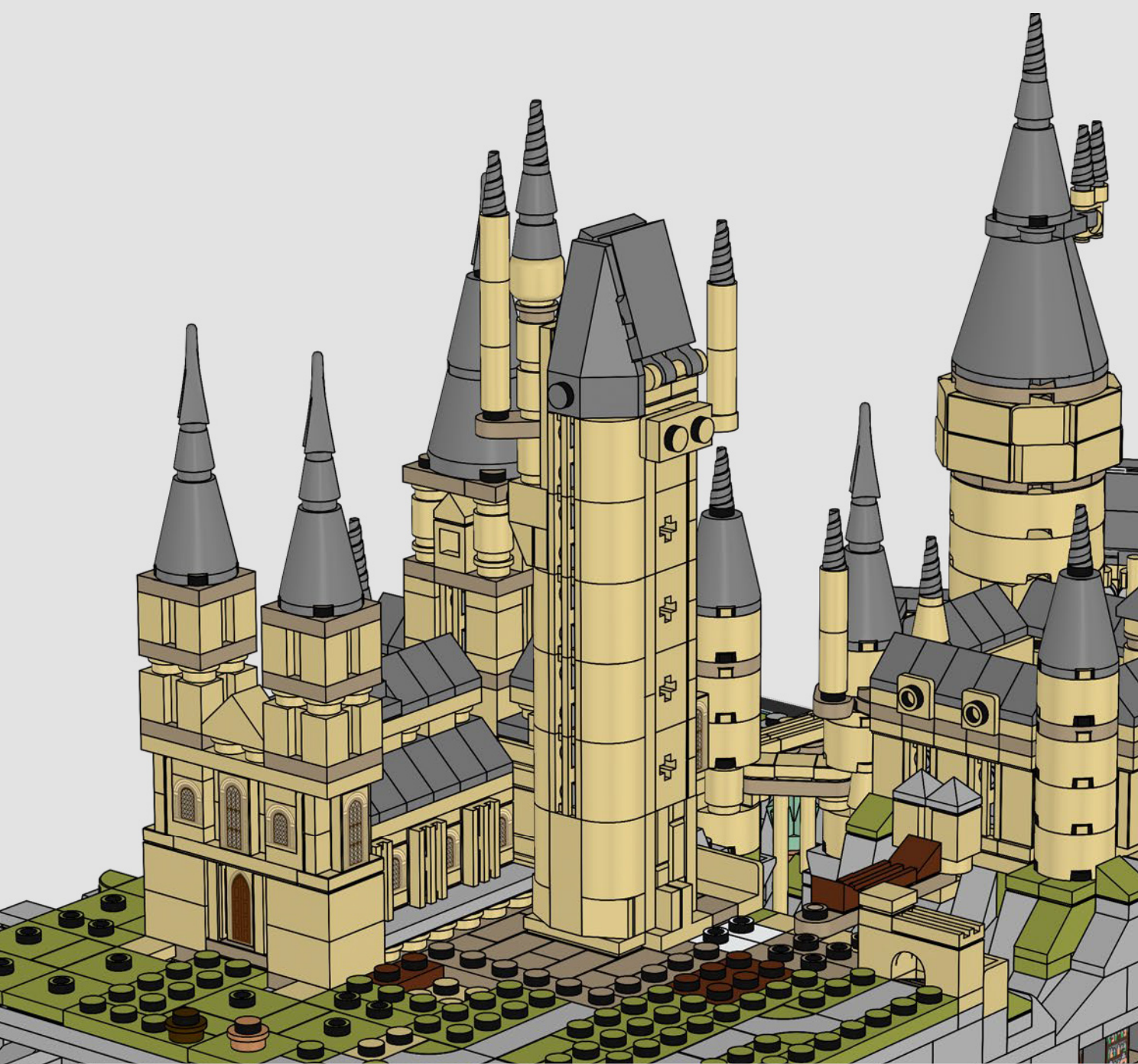

Si potrebbe pensare che la Torre principale sia il punto più alto del castello di Hogwarts™, ma in realtà è la Torre astronomica.





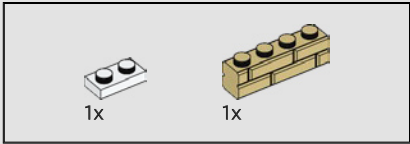
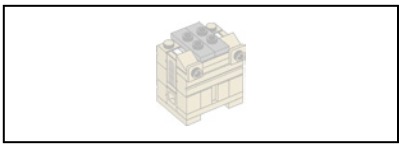

572

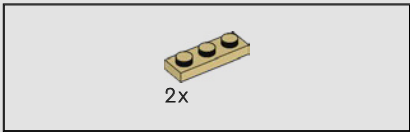
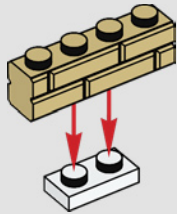

573

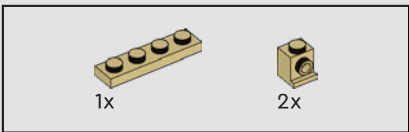
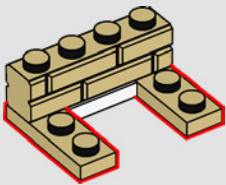

574

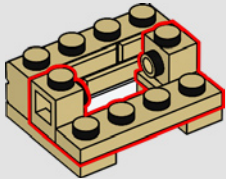

575

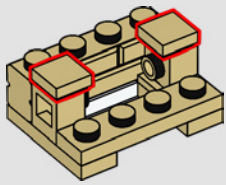

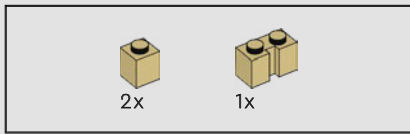

576

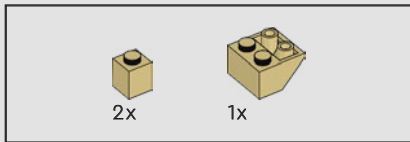
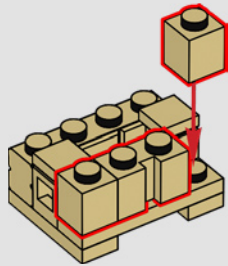

577

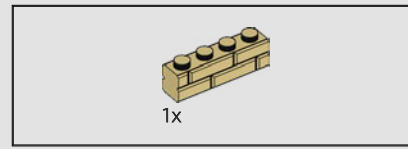
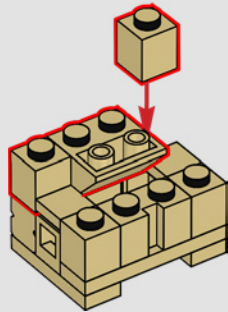

578

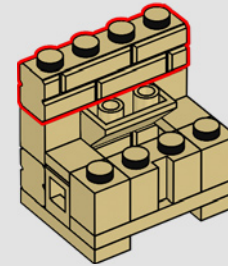

579

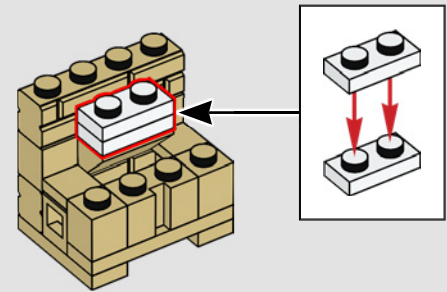

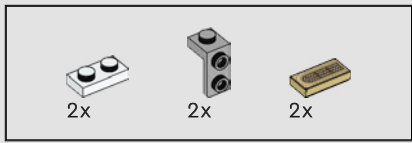

580

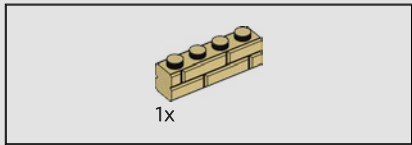
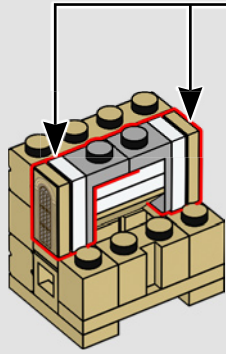
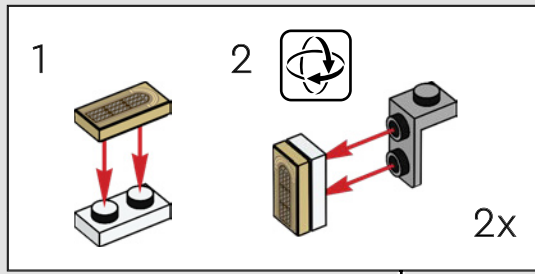

581

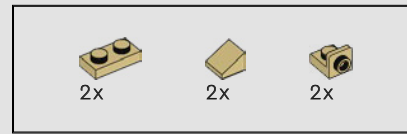
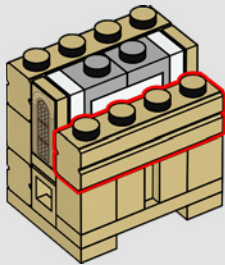

582

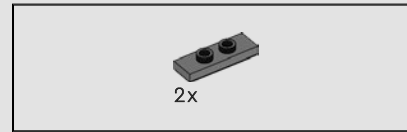
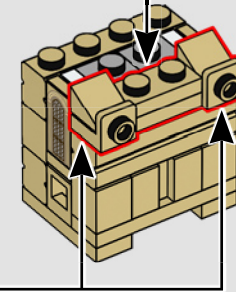
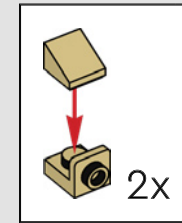
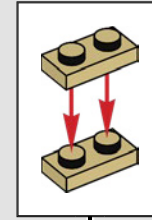

583

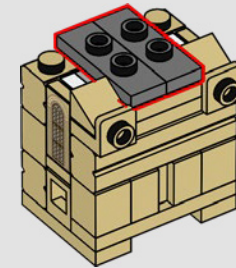



584

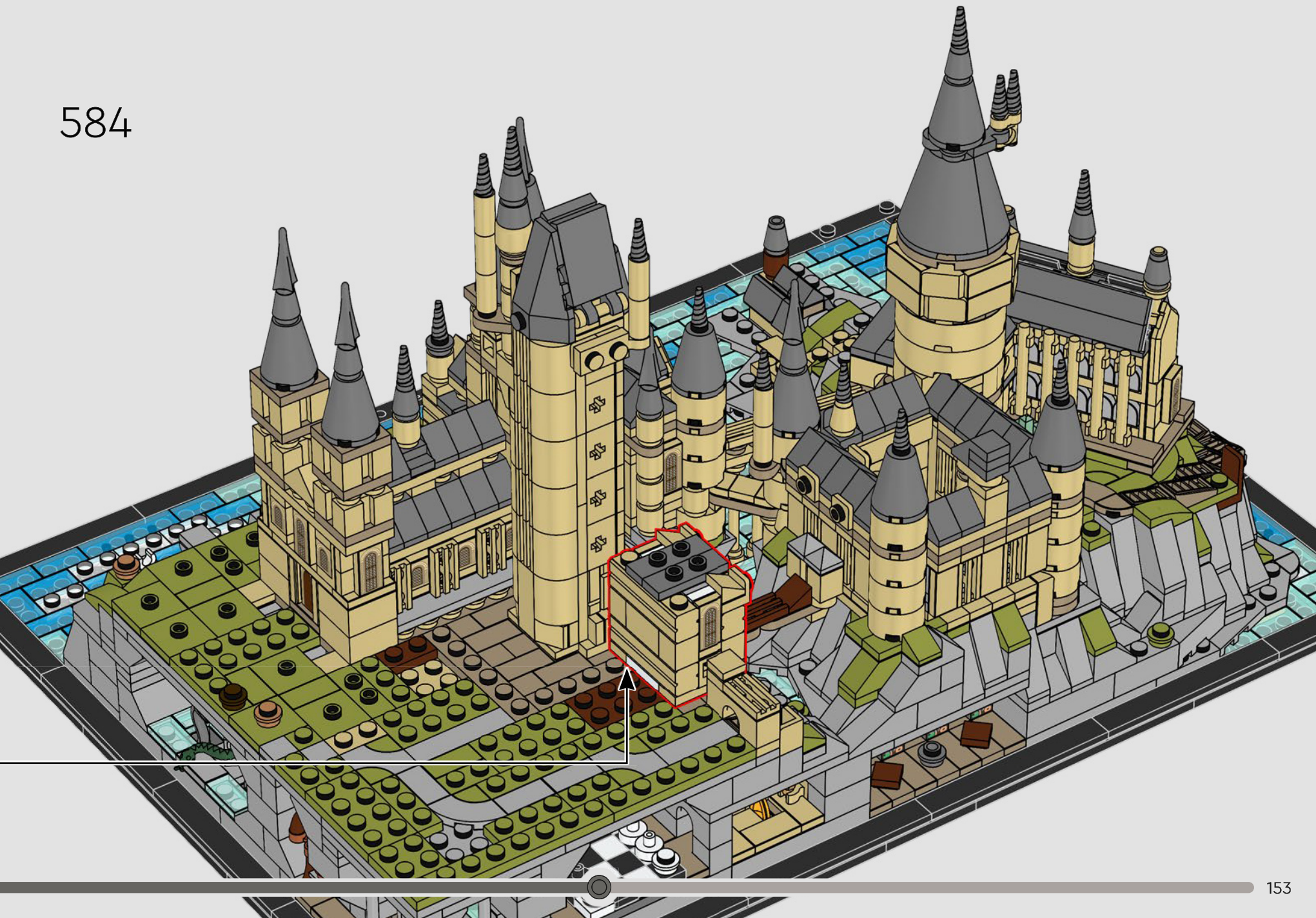

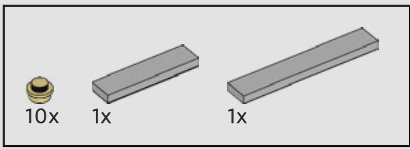

585

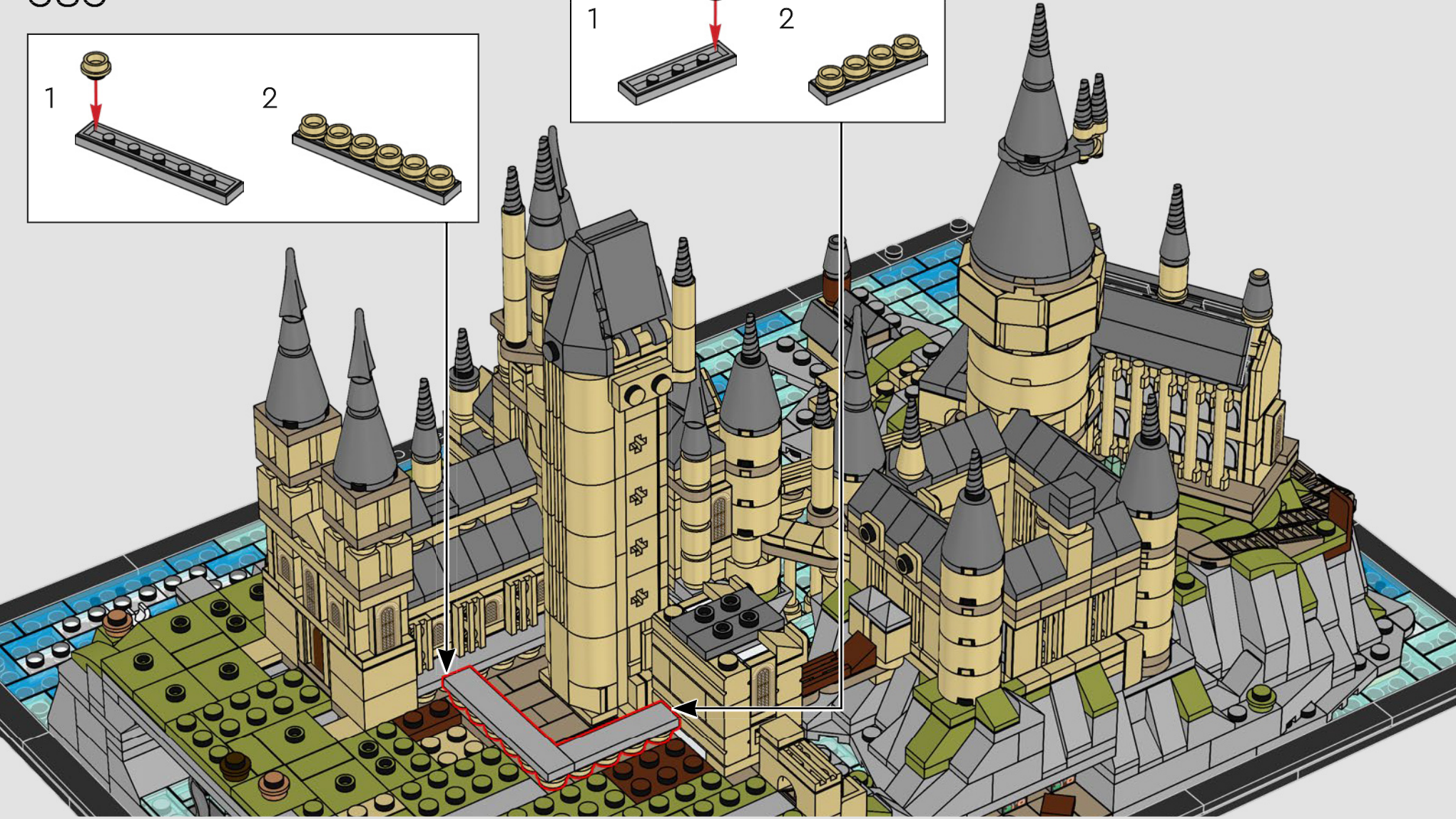
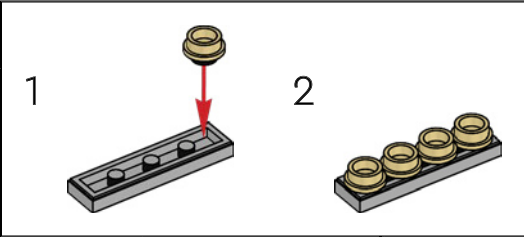
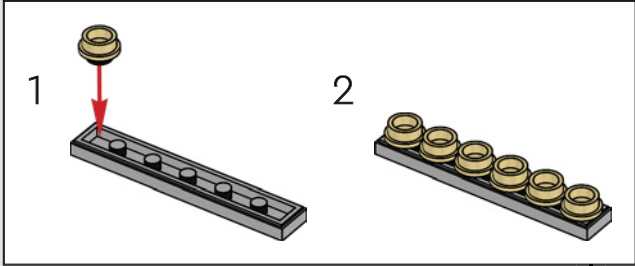

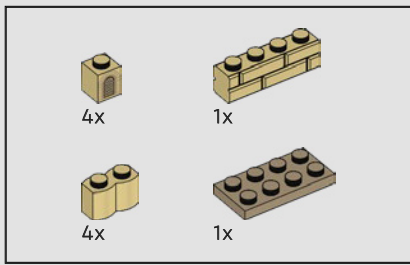

586

1

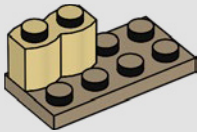

2

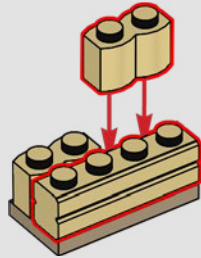

3

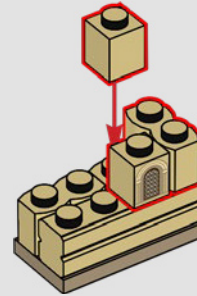

4

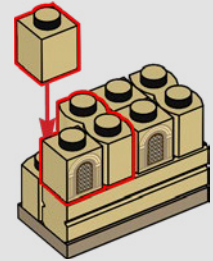





587



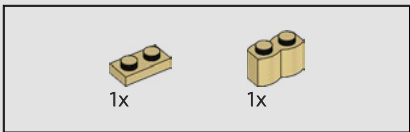

588

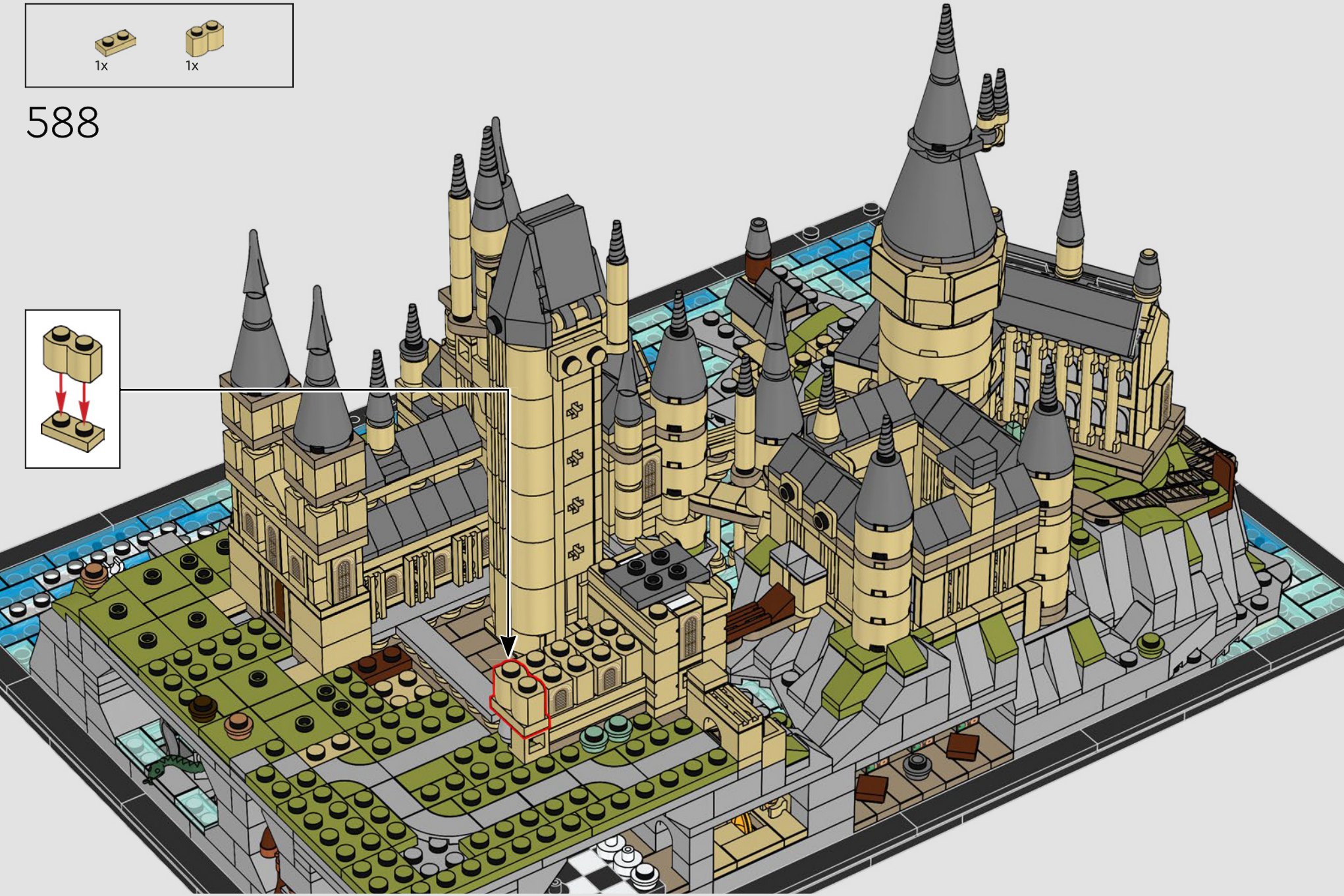
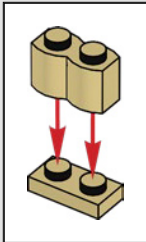

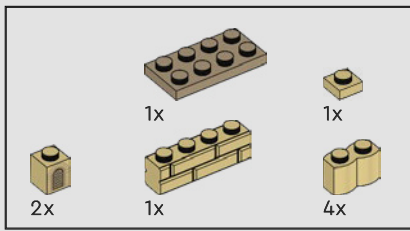

589

1

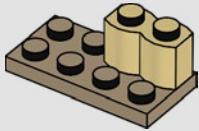

2

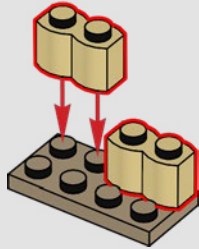

3

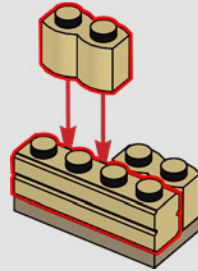

4

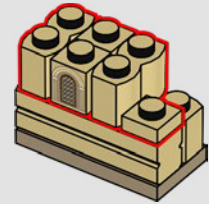

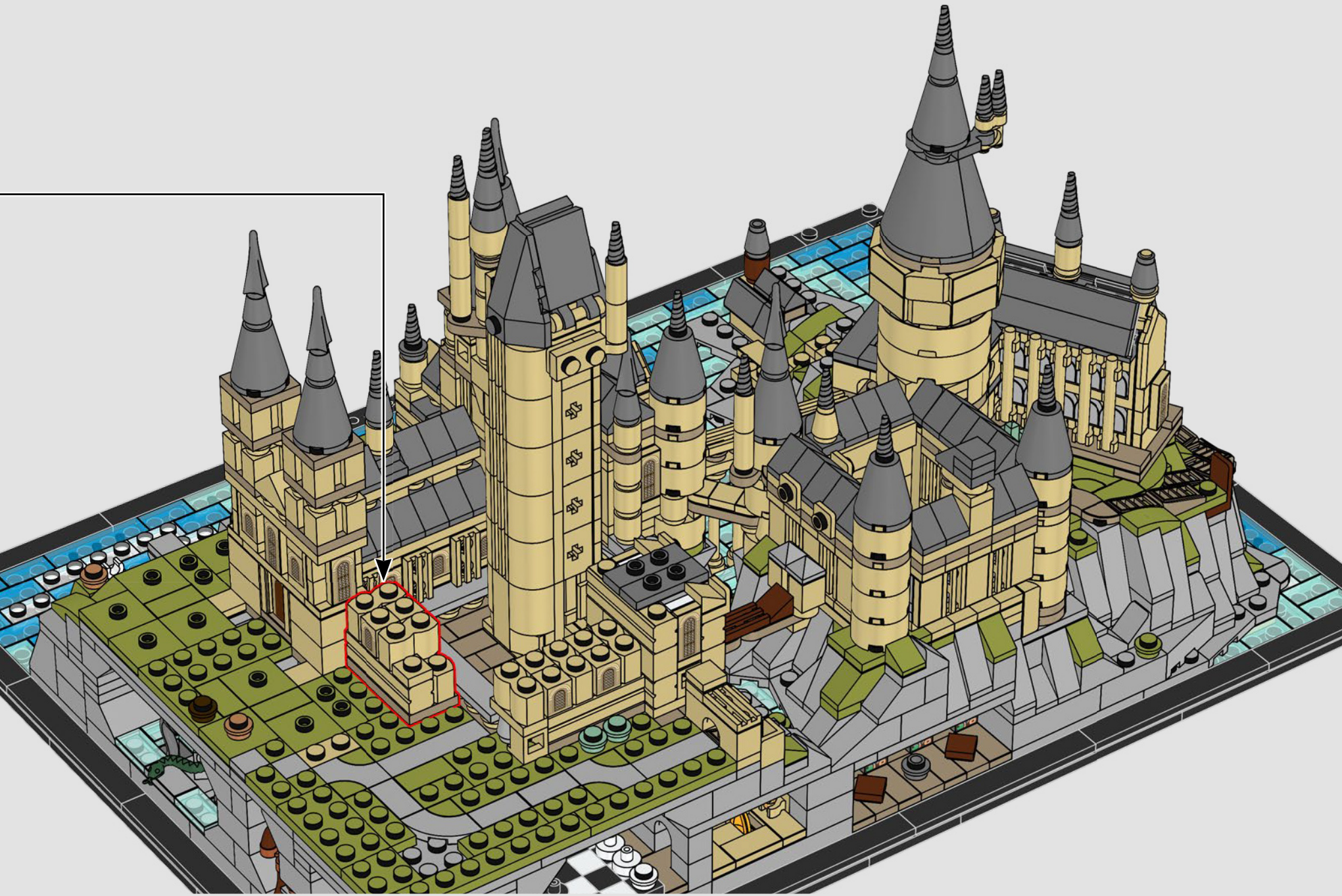



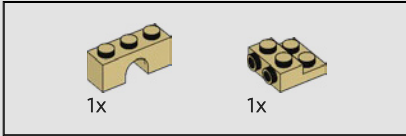
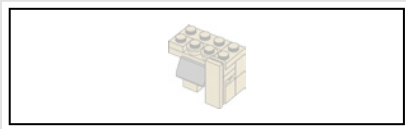

590

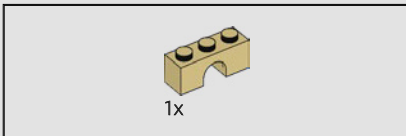
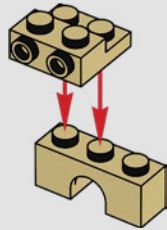

591

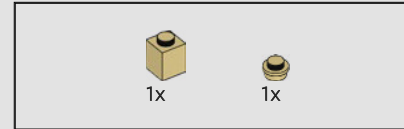
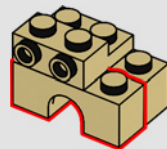

592

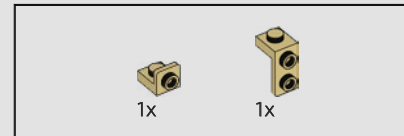
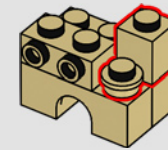

593

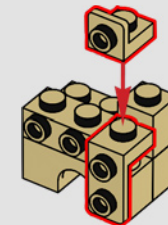

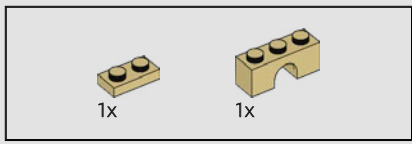

594

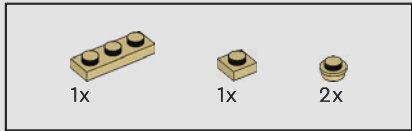
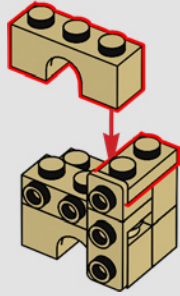

595

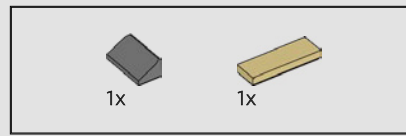
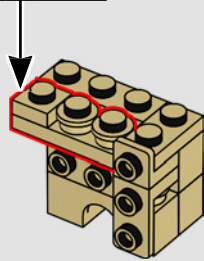
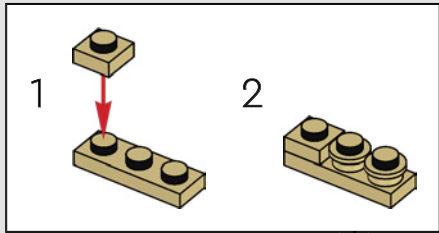

596

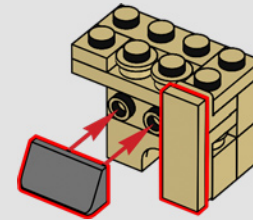

597



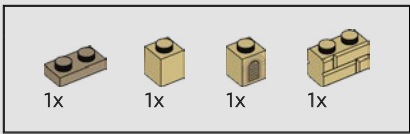

598

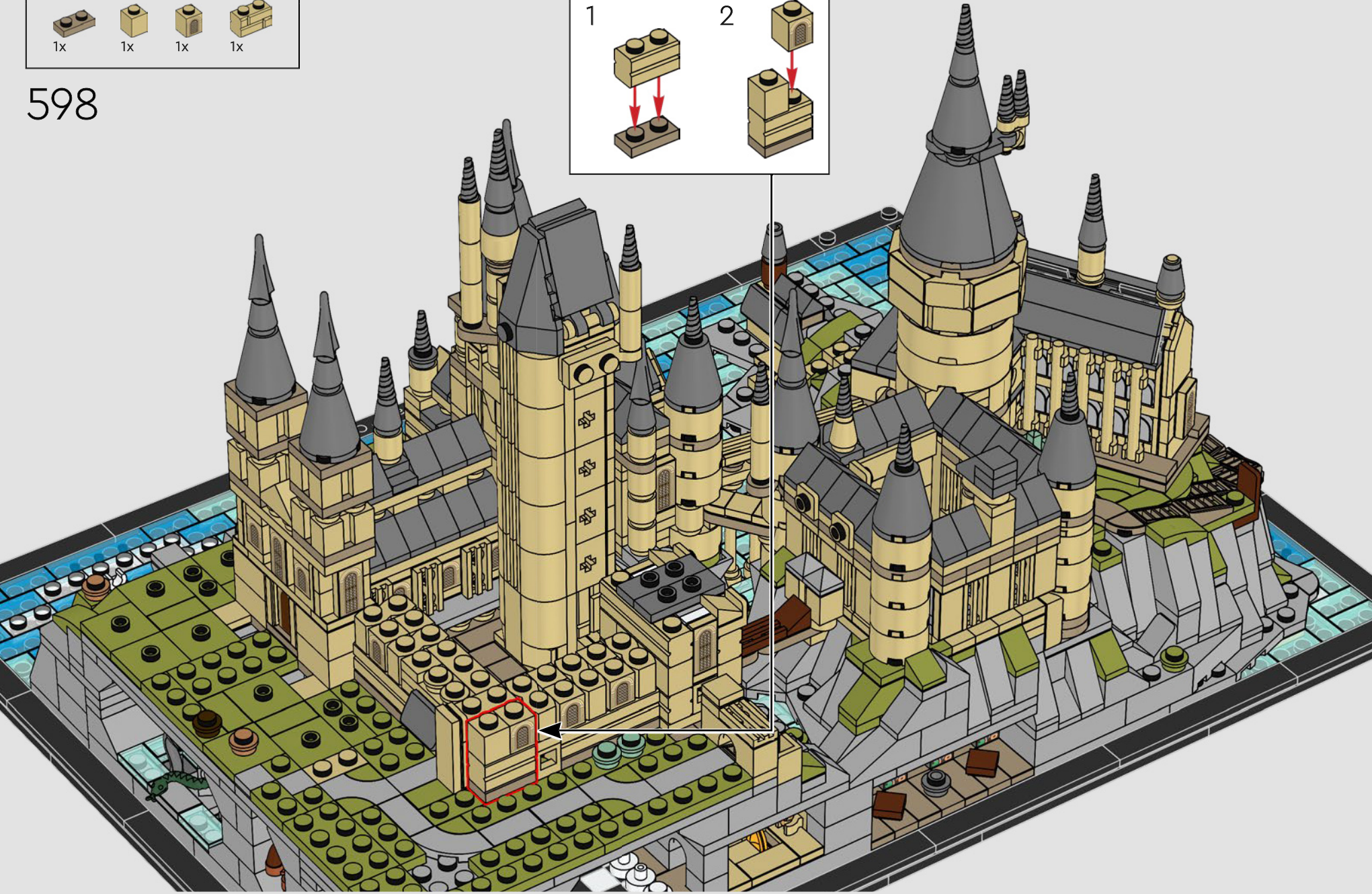
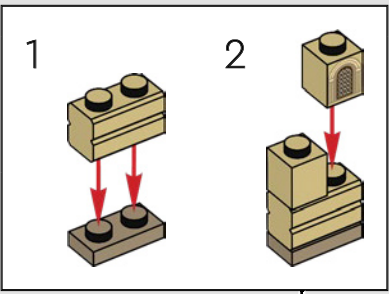

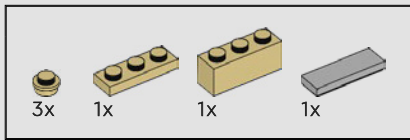

599

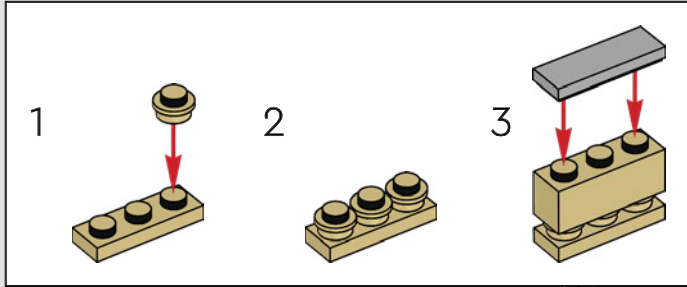

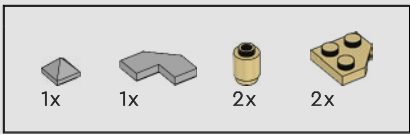

600

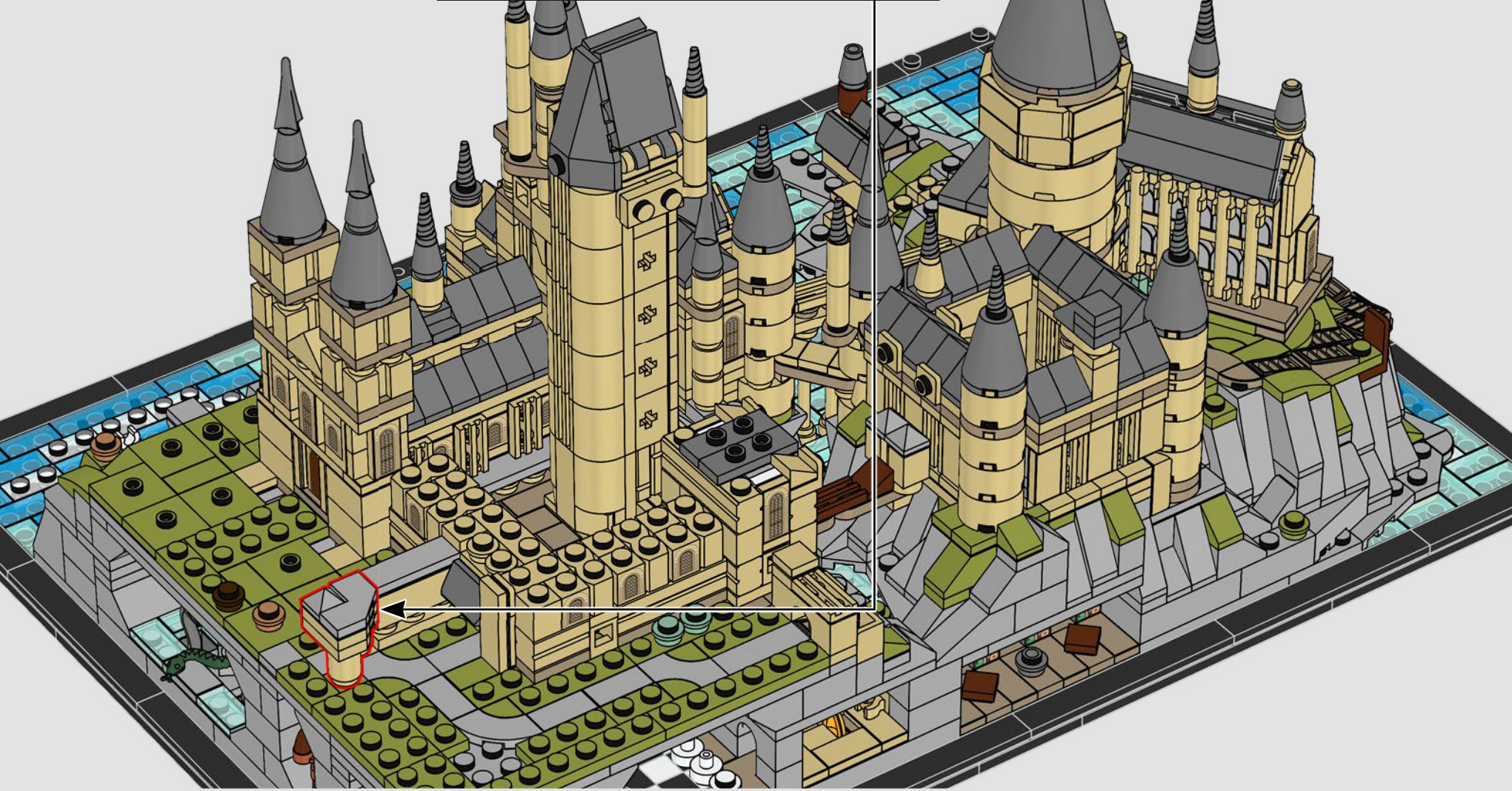
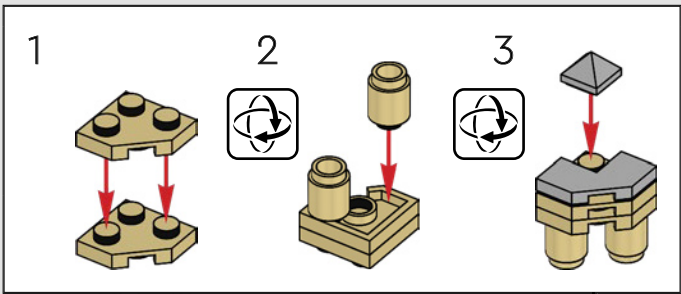

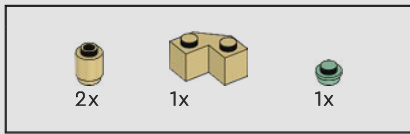

601

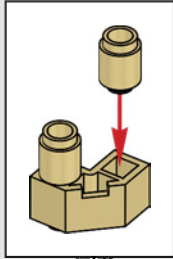





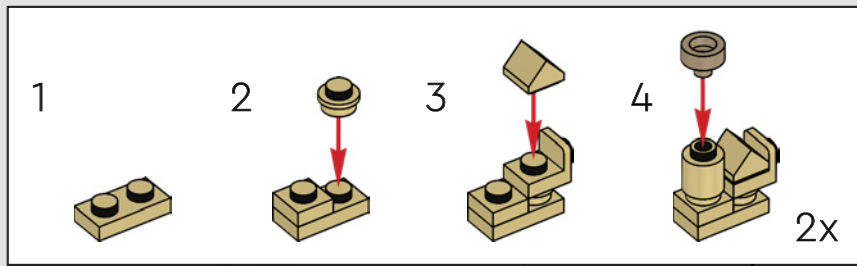
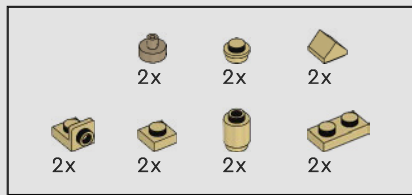

602

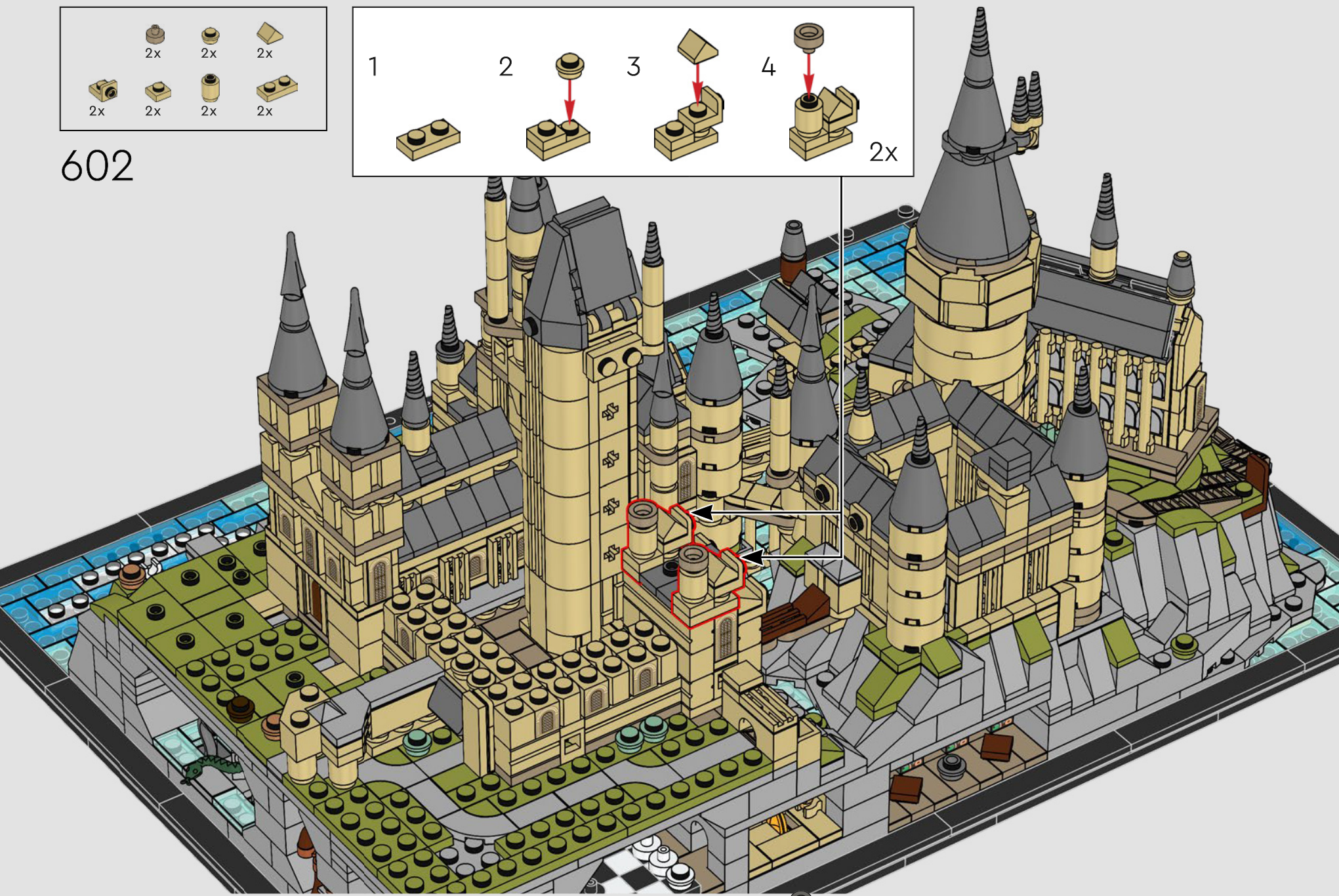

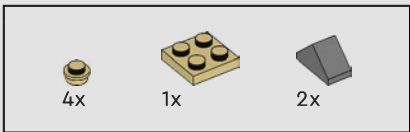

603

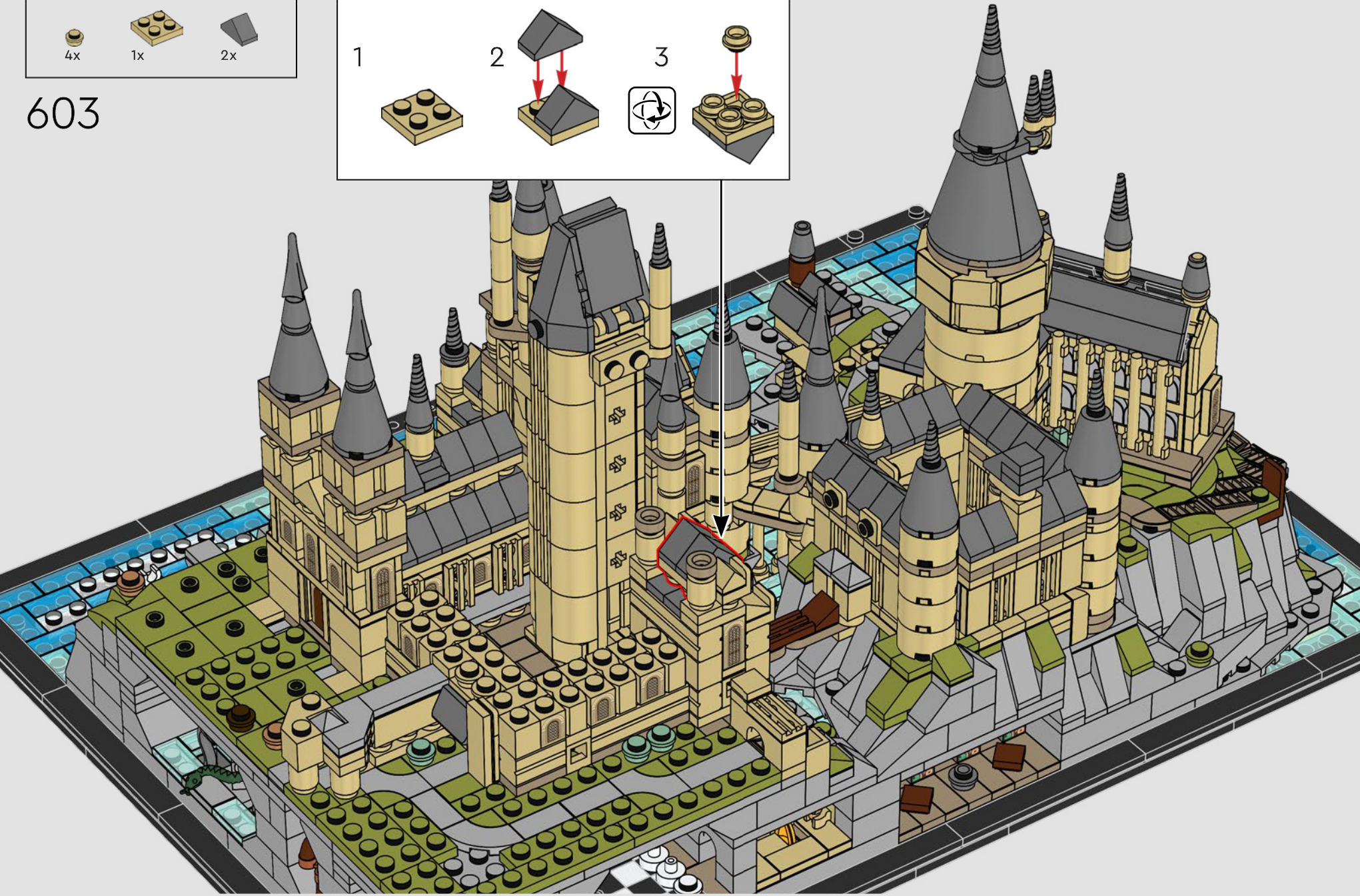
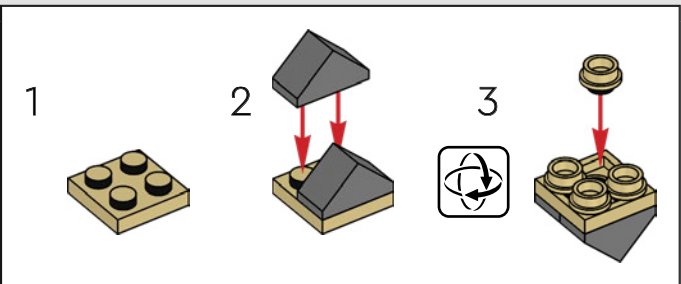

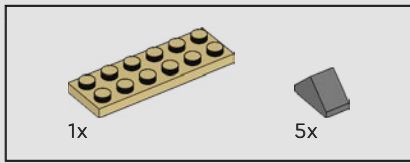

604

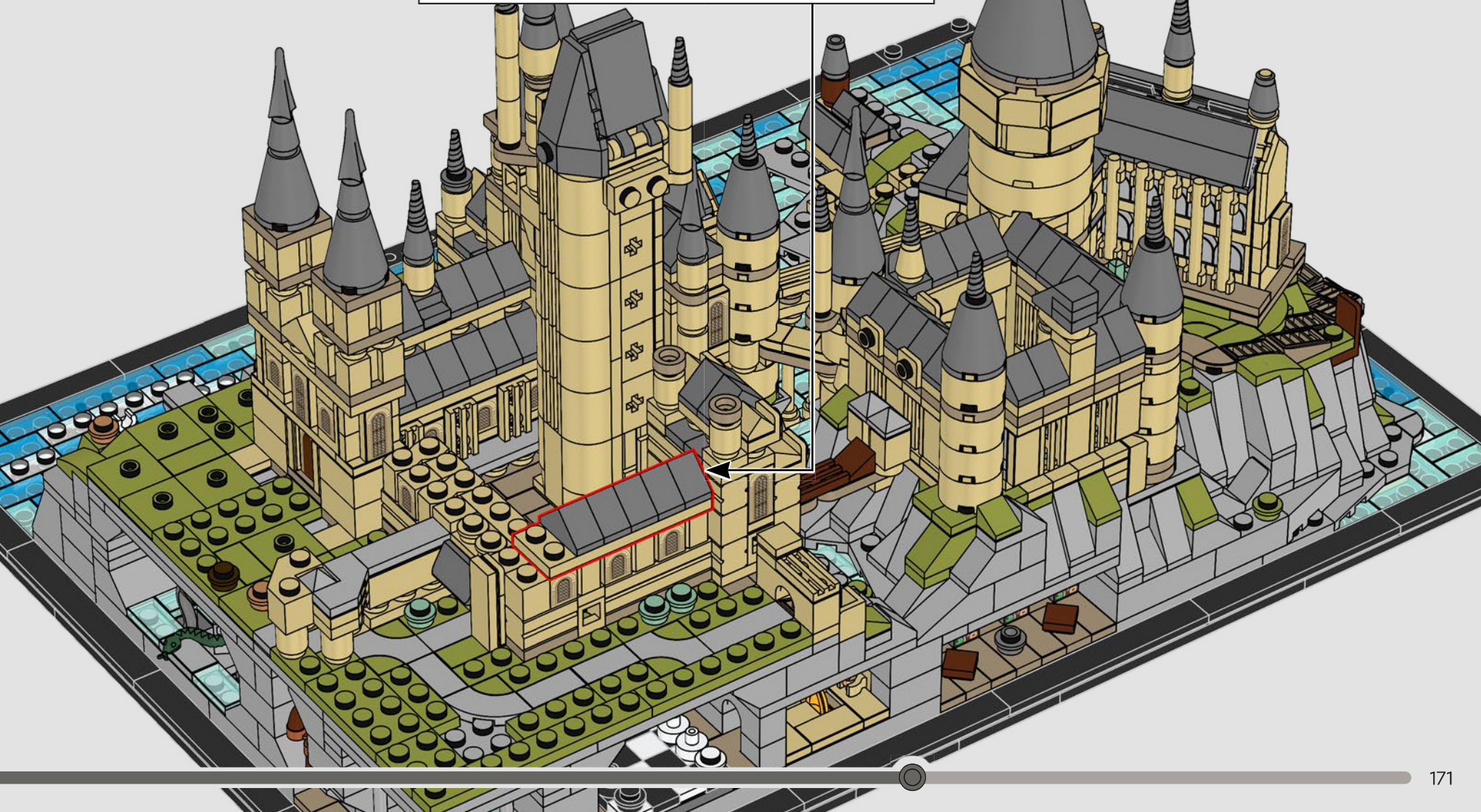
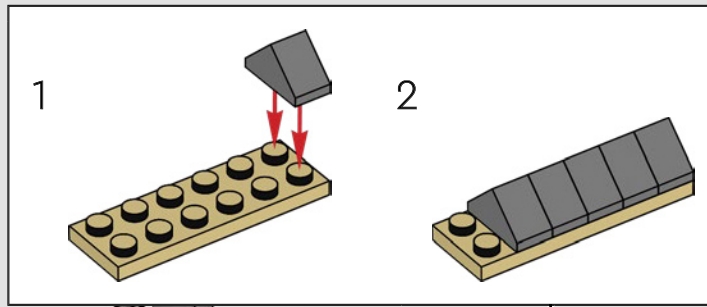

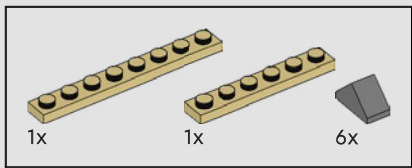

605

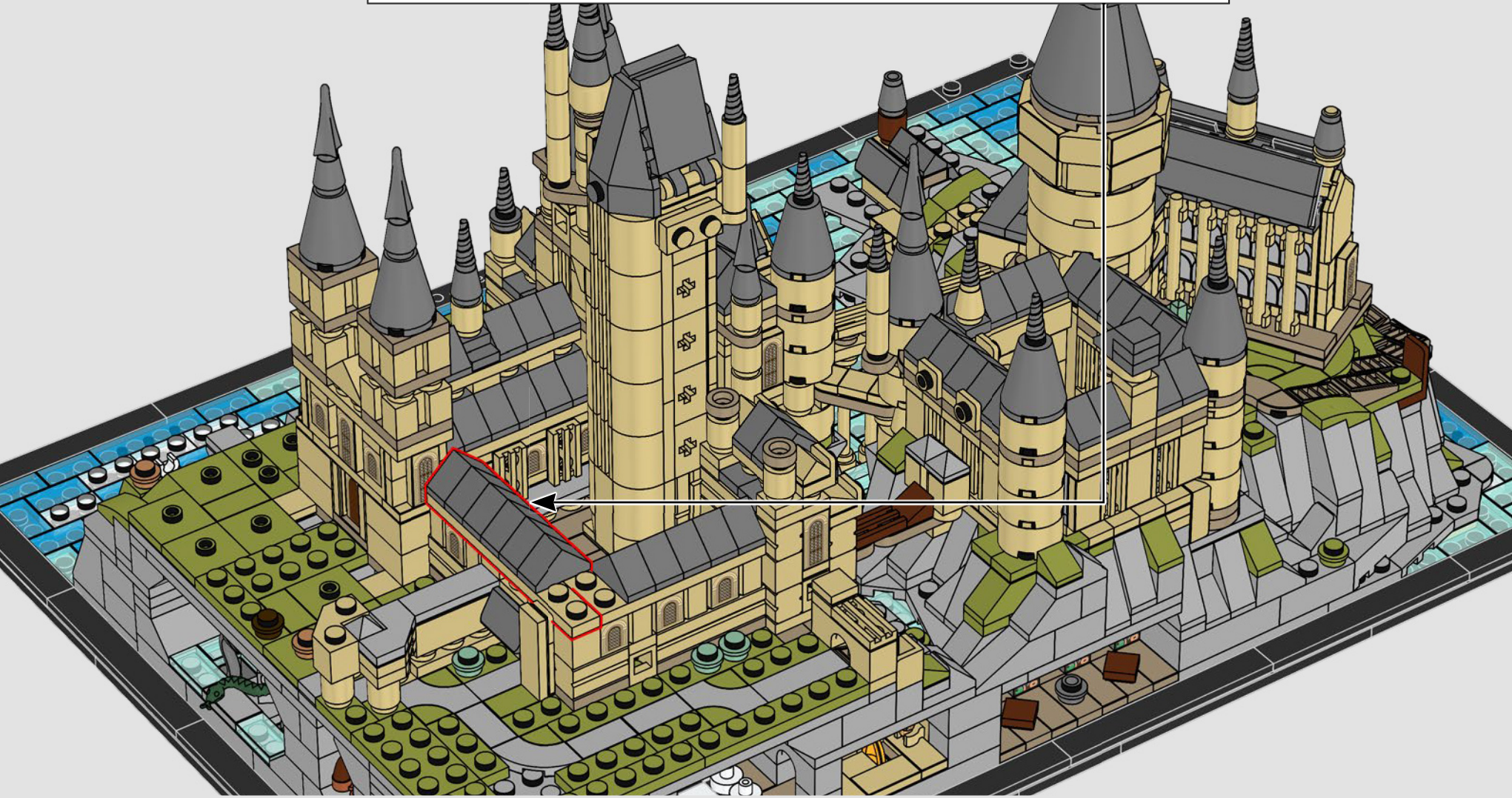
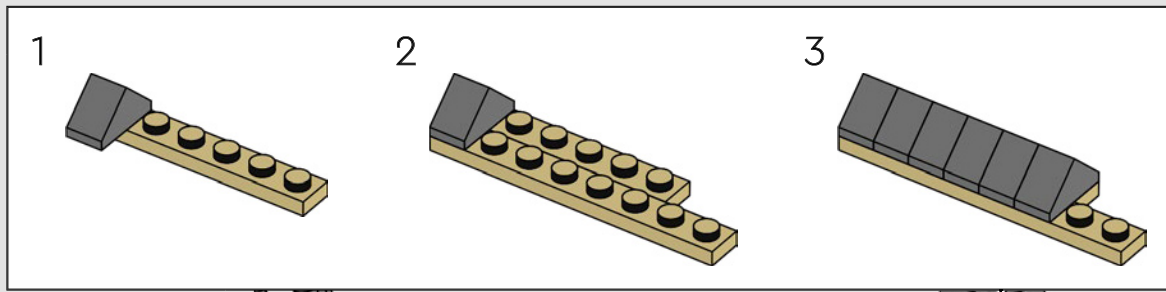

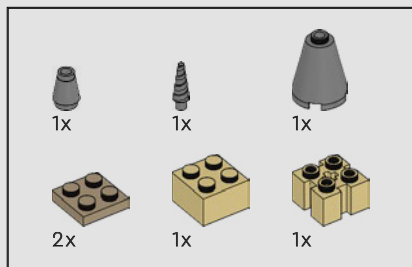

606

1

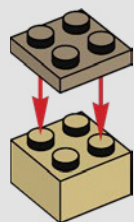

2

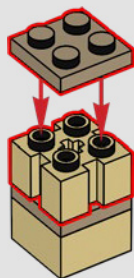

3

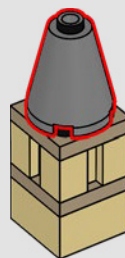

4

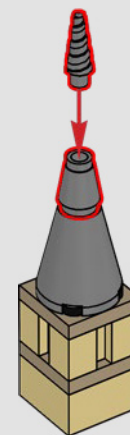





Hogwarts™ è un castello enorme, dove può essere difficile orientarsi. Ma sapevi che il castello ha 142 scalinate? Con le scale che cambiano continuamente, non è facile orientarsi.

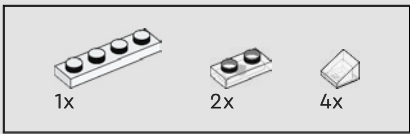

607

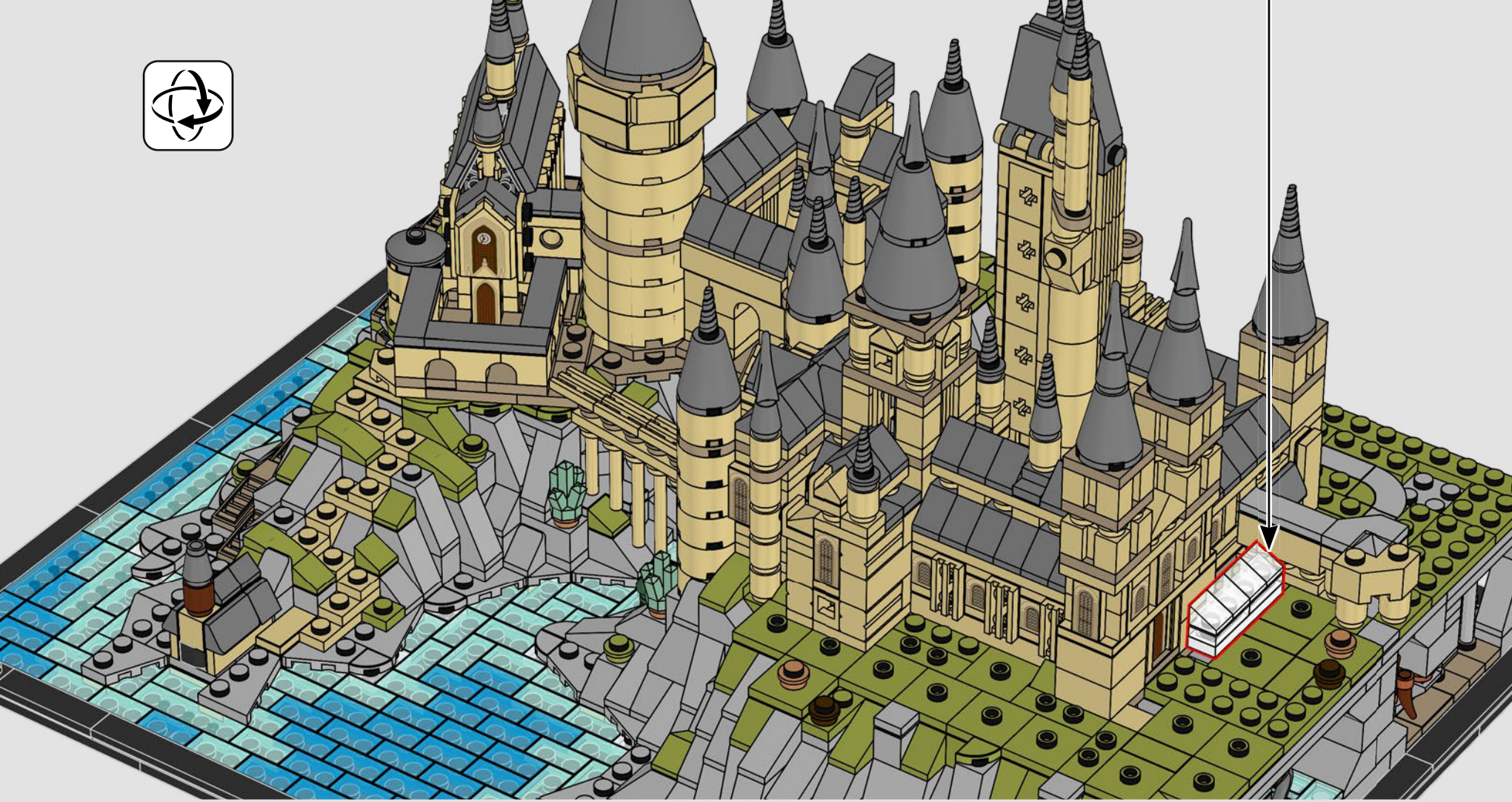
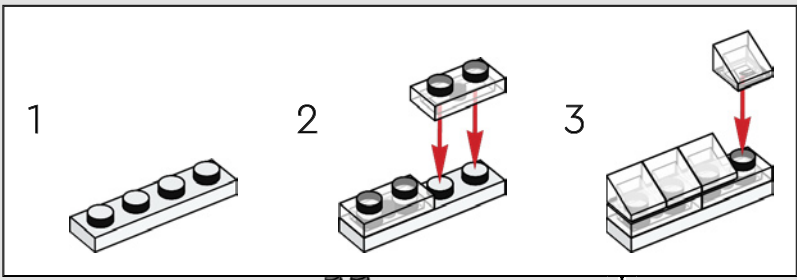



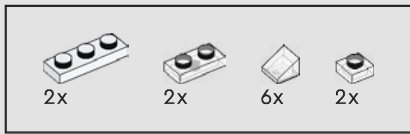

608

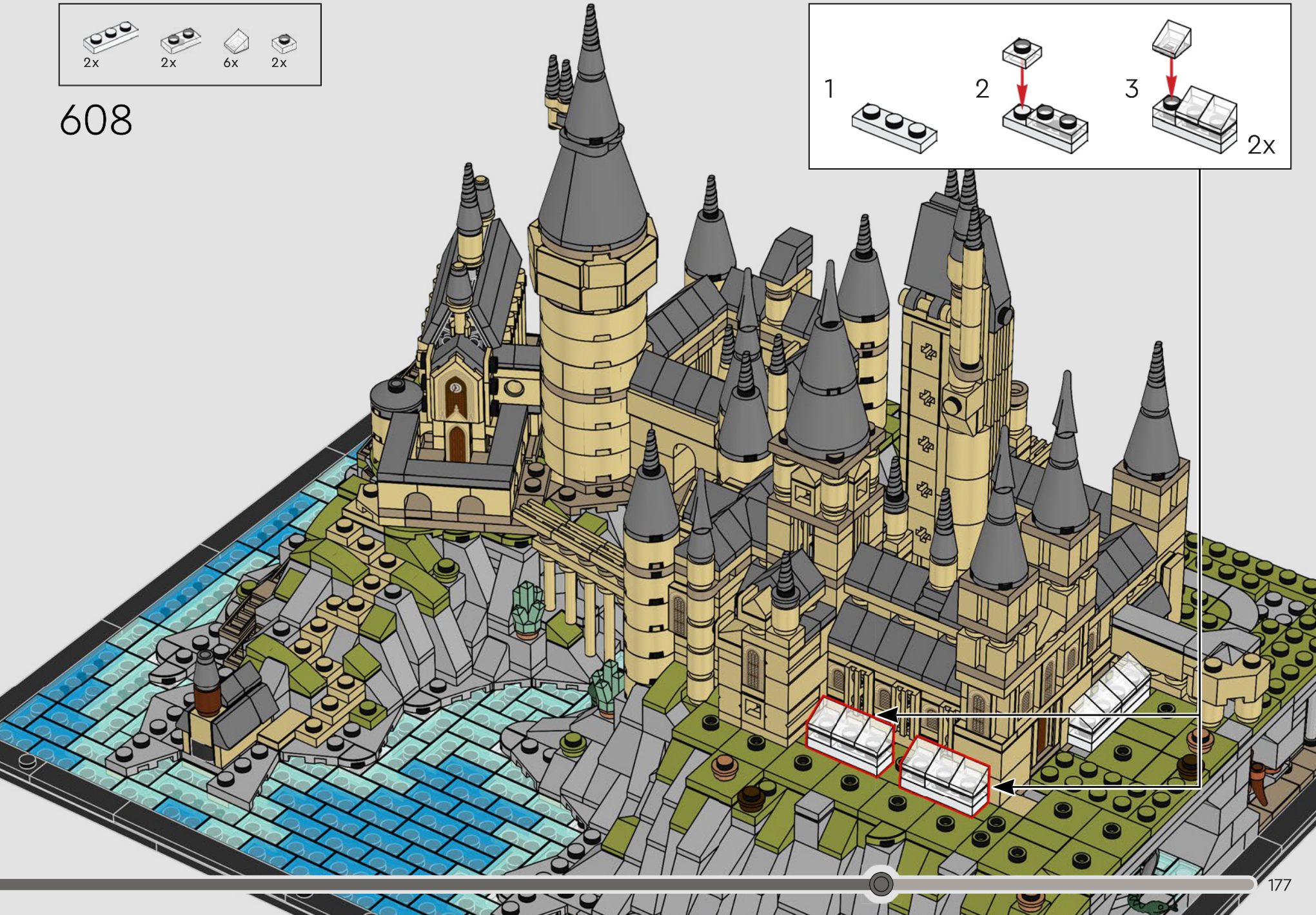
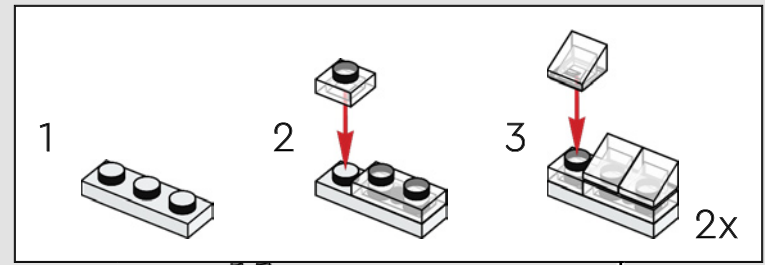



609

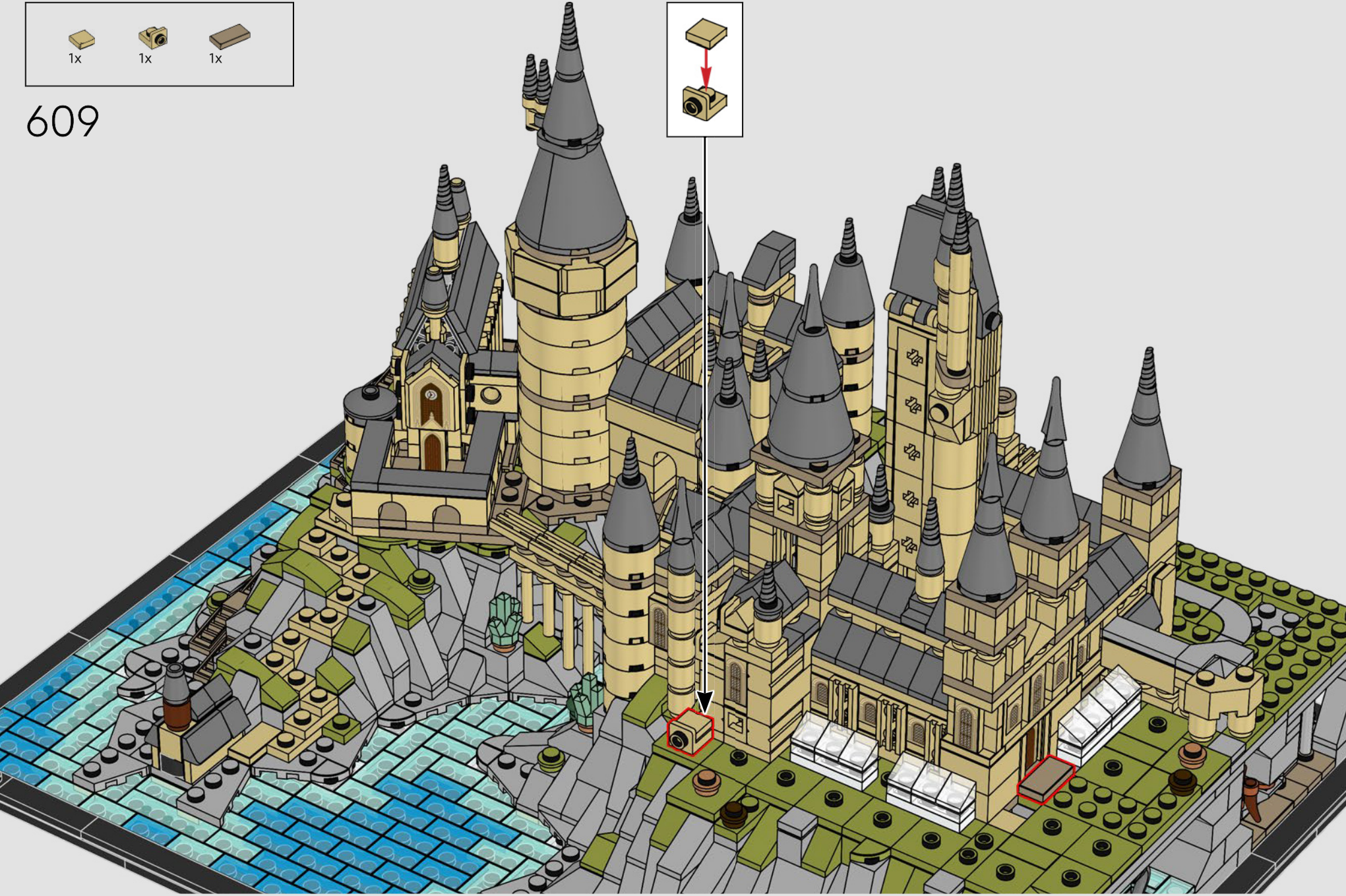
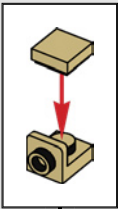



610

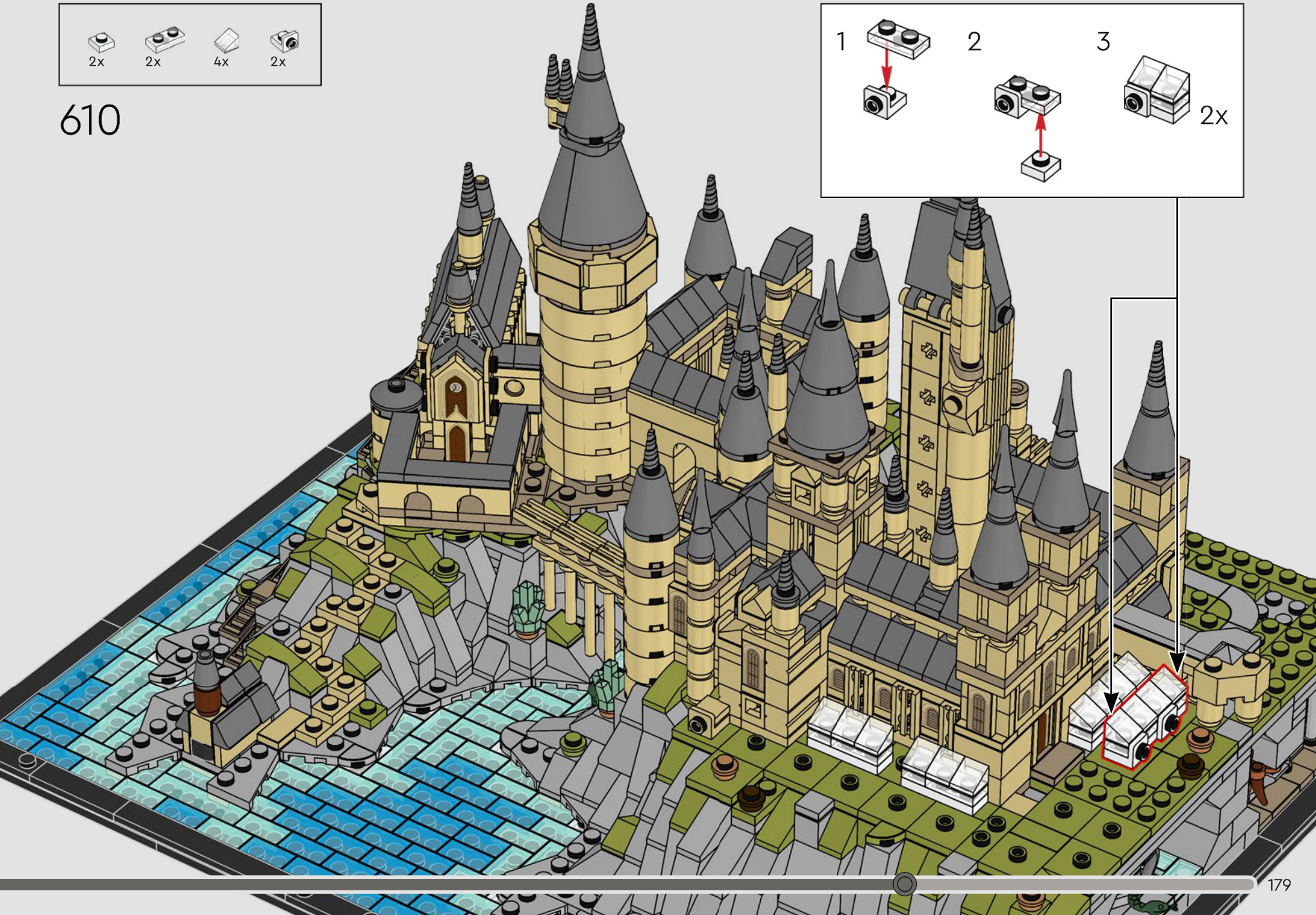
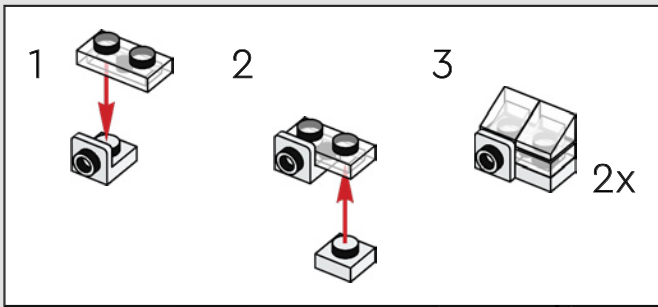

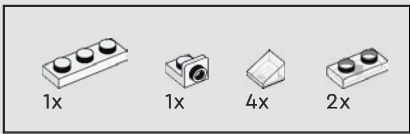

611

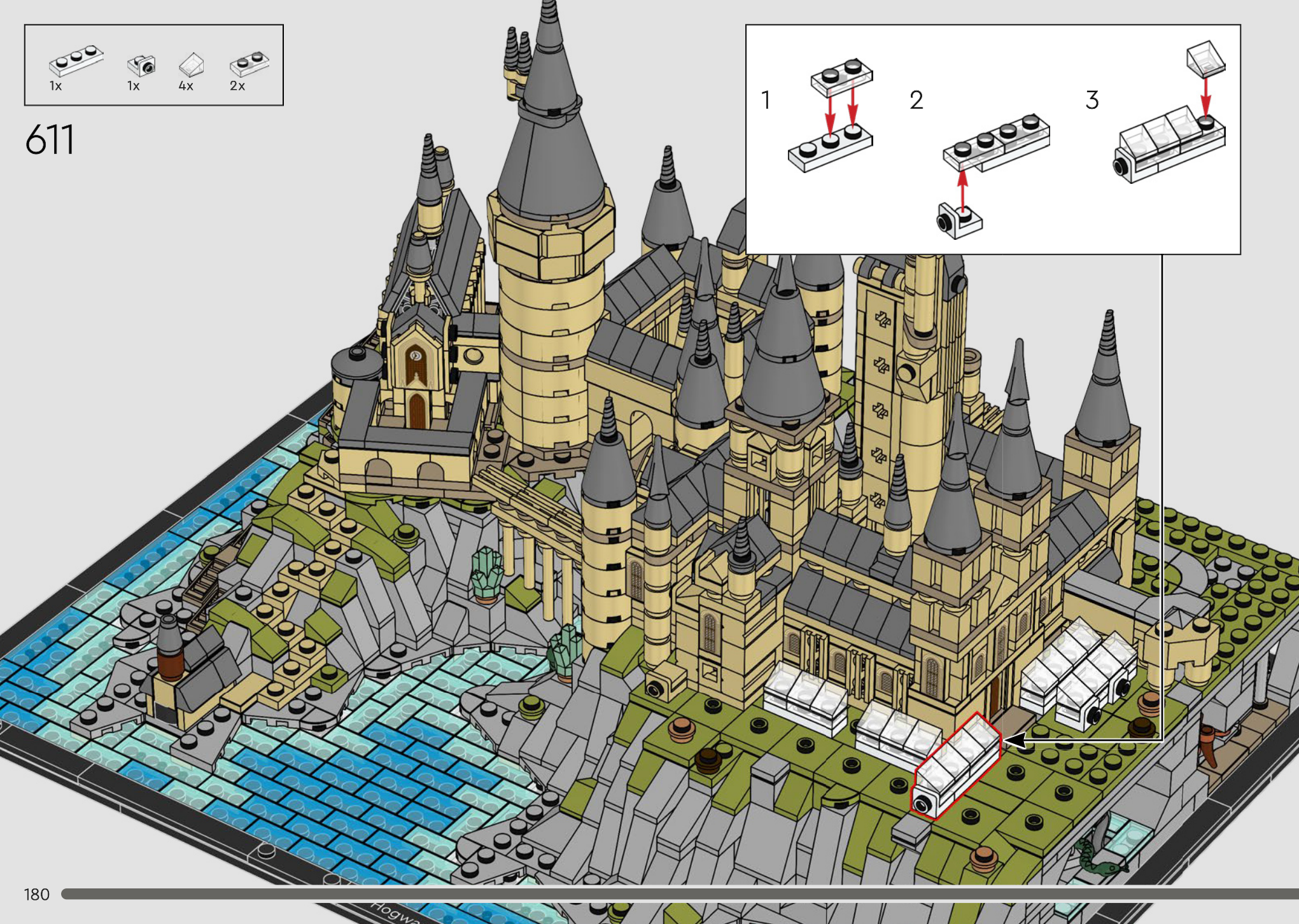
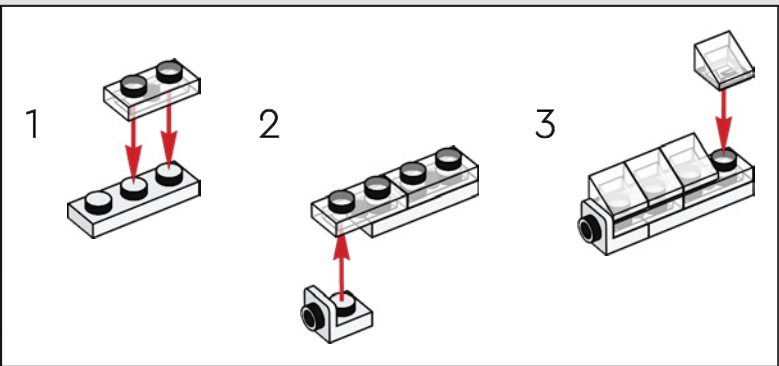

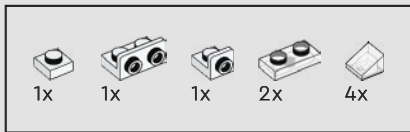

612

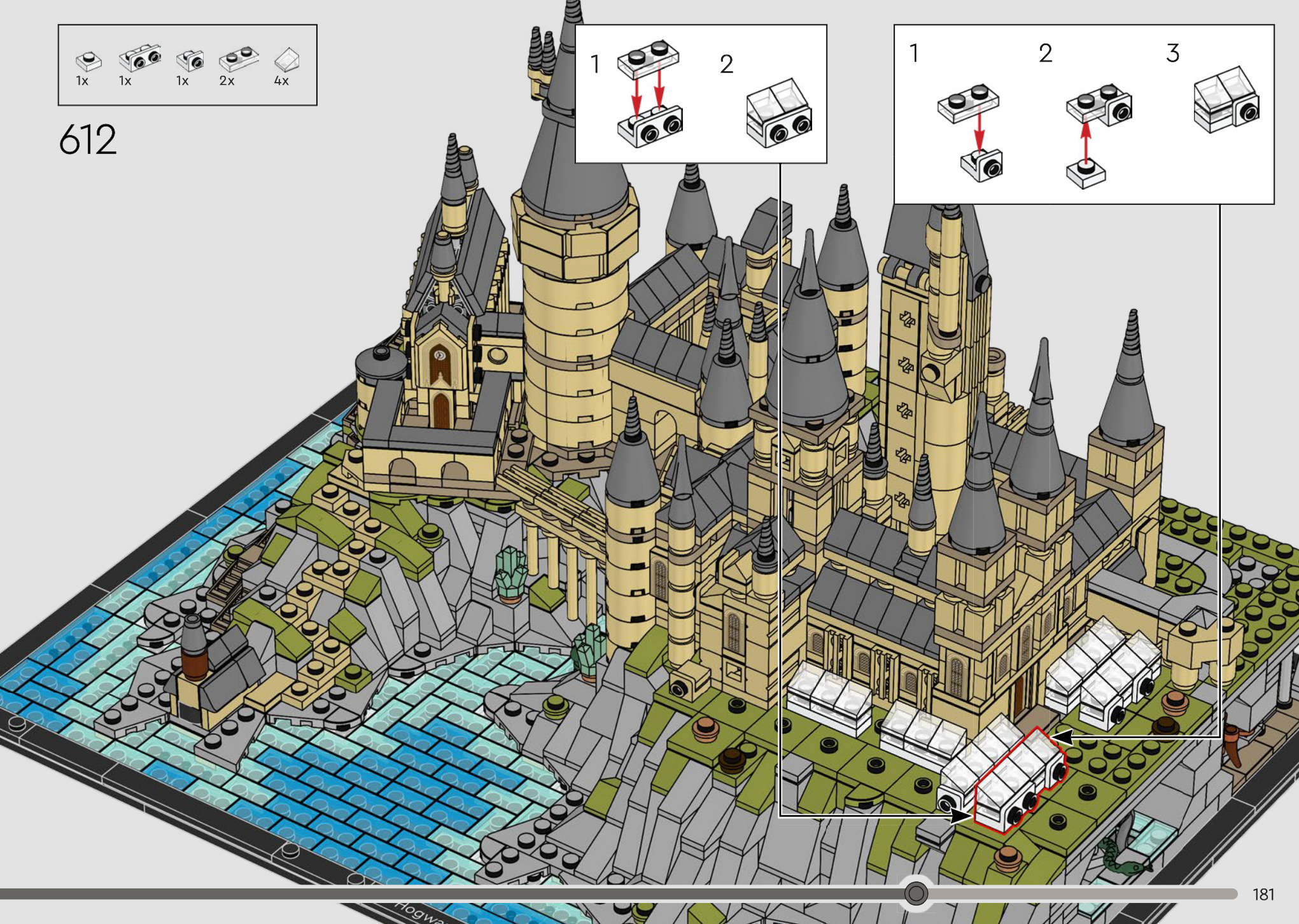
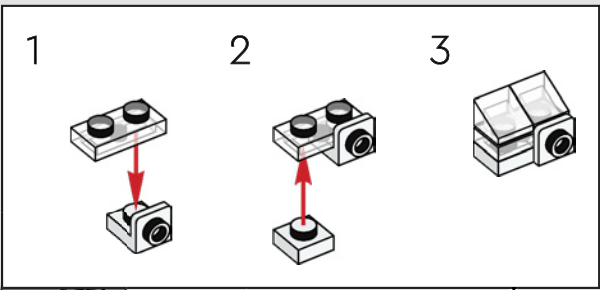
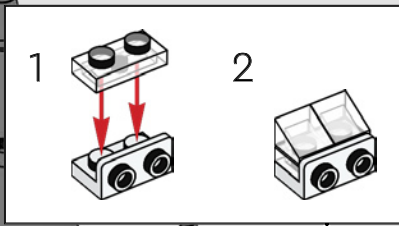

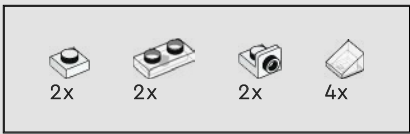

613

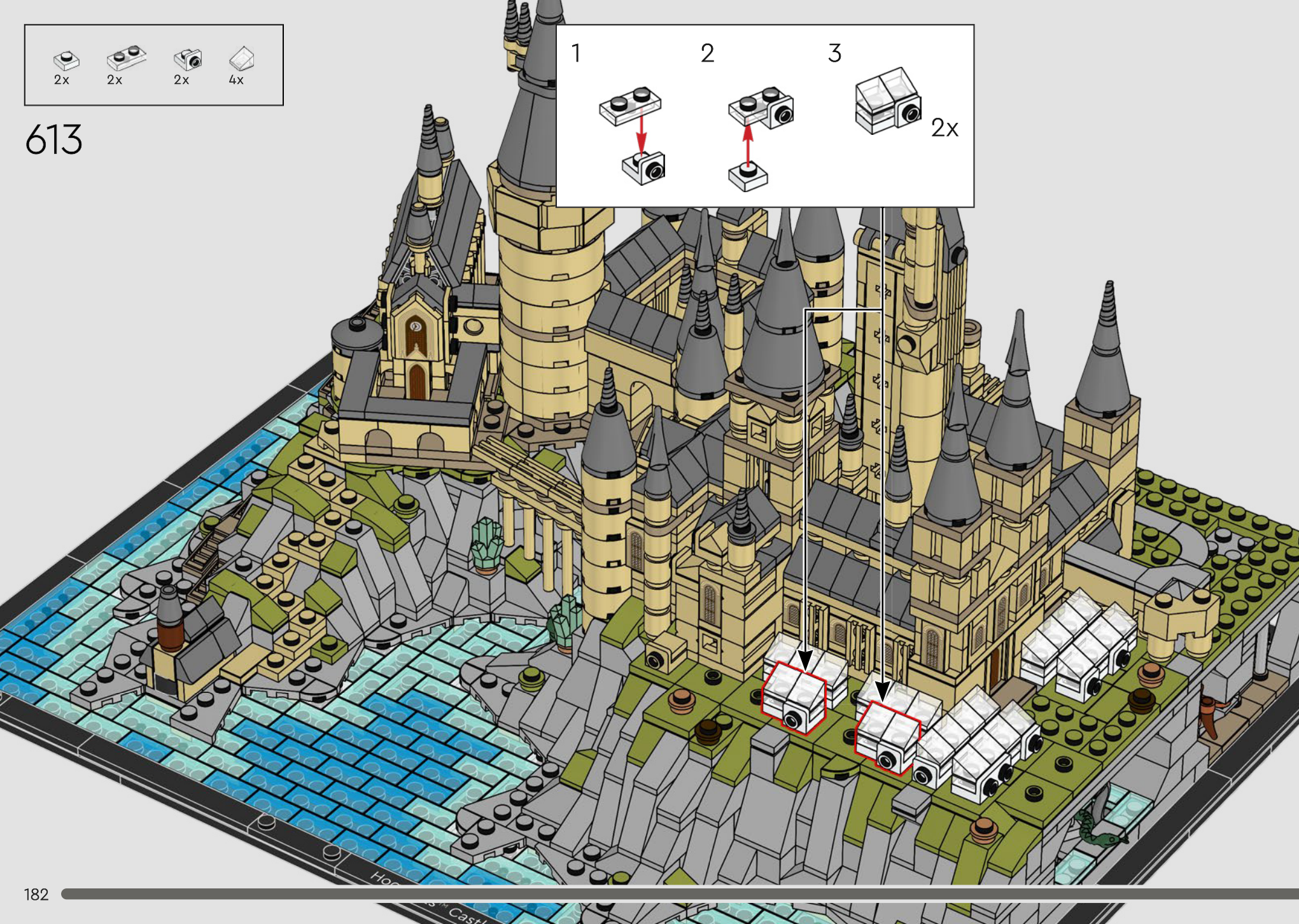
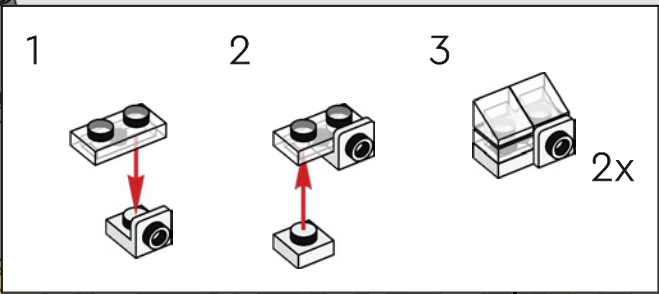



614

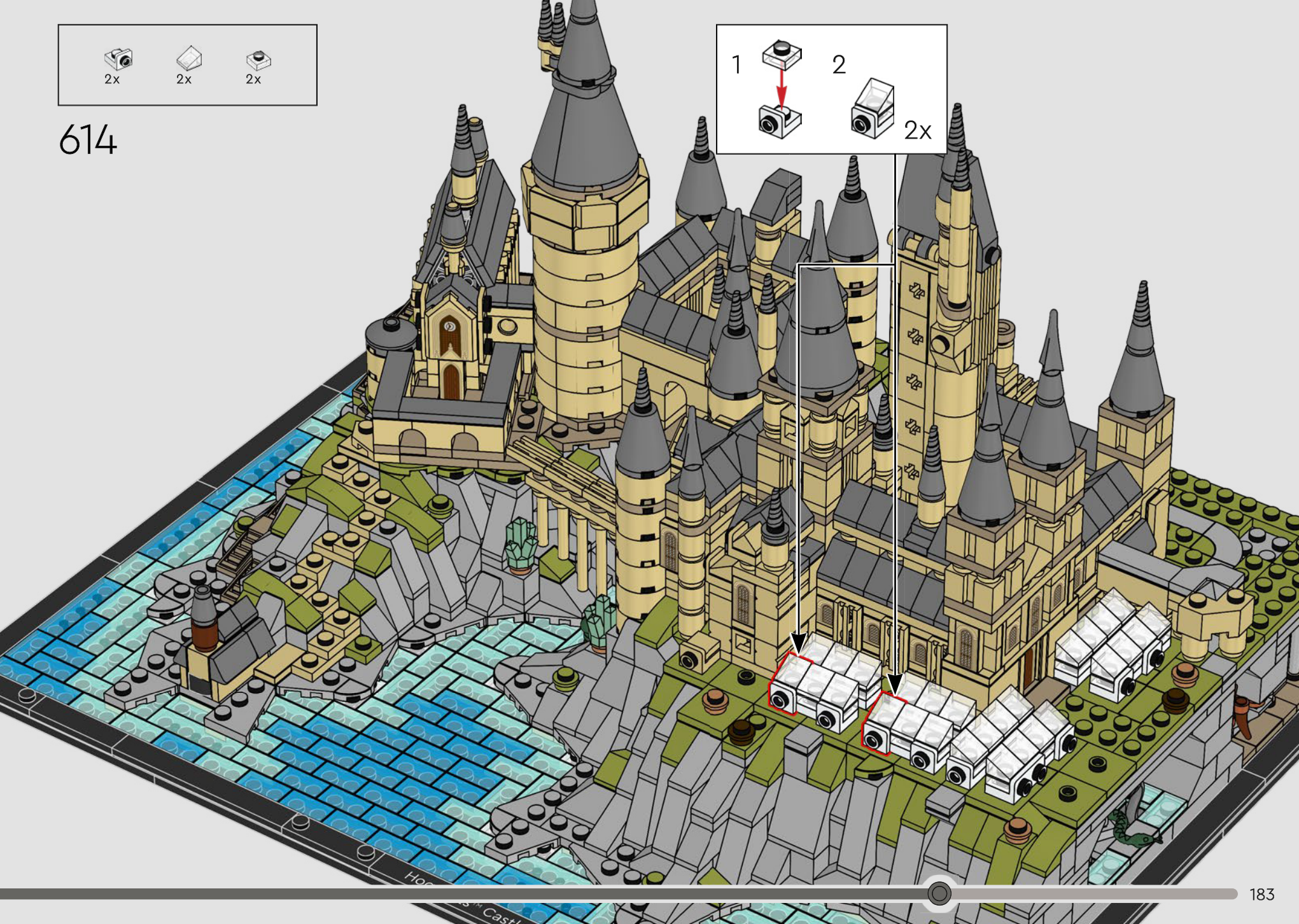
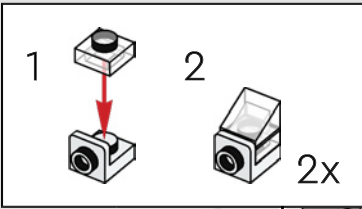

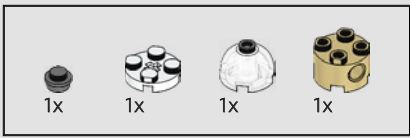

615

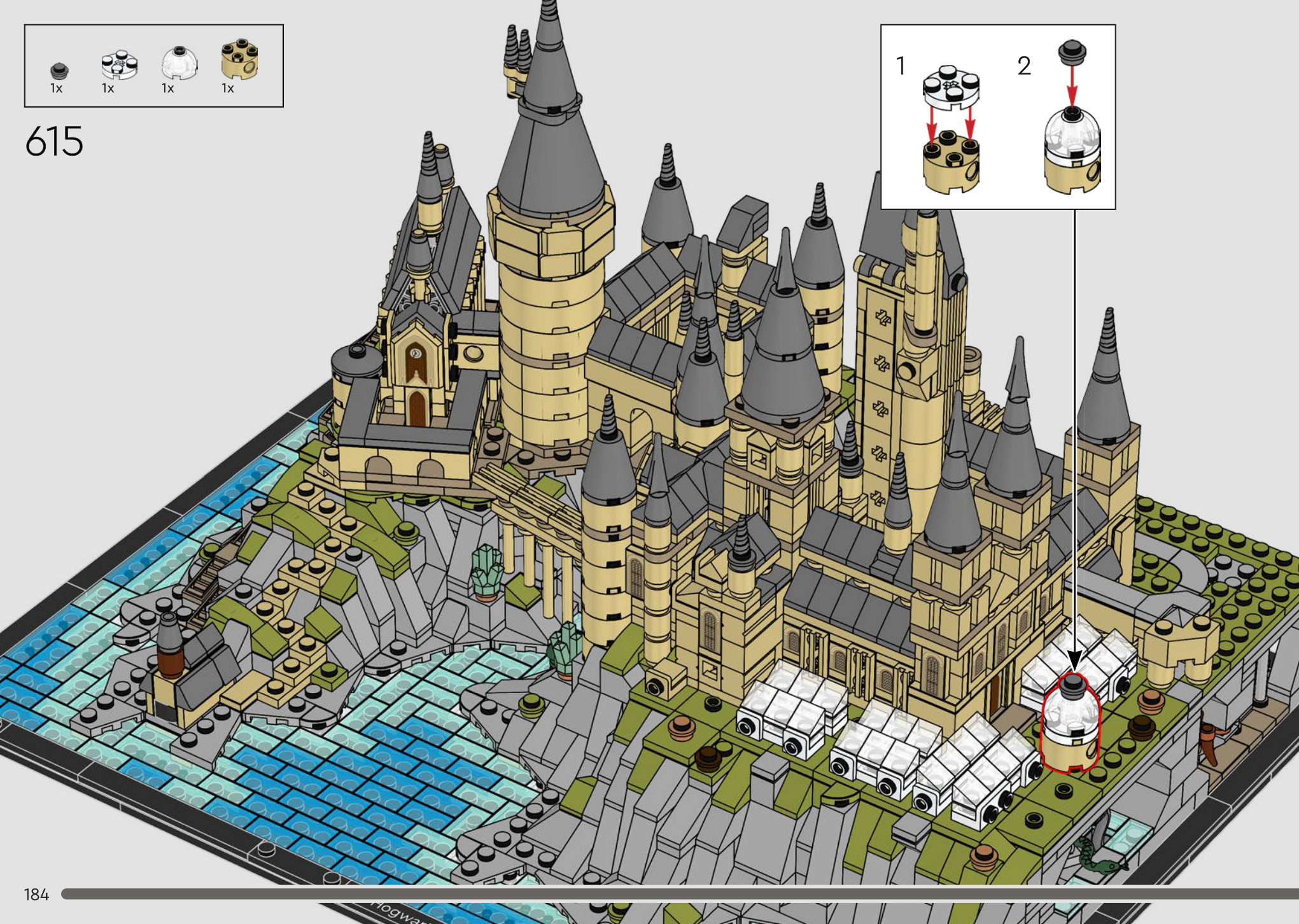
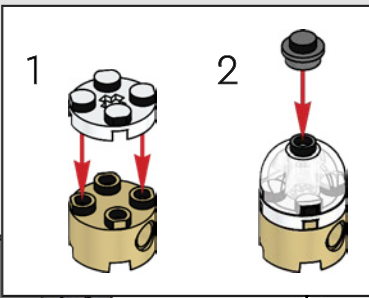



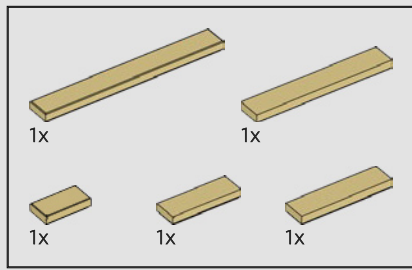

616

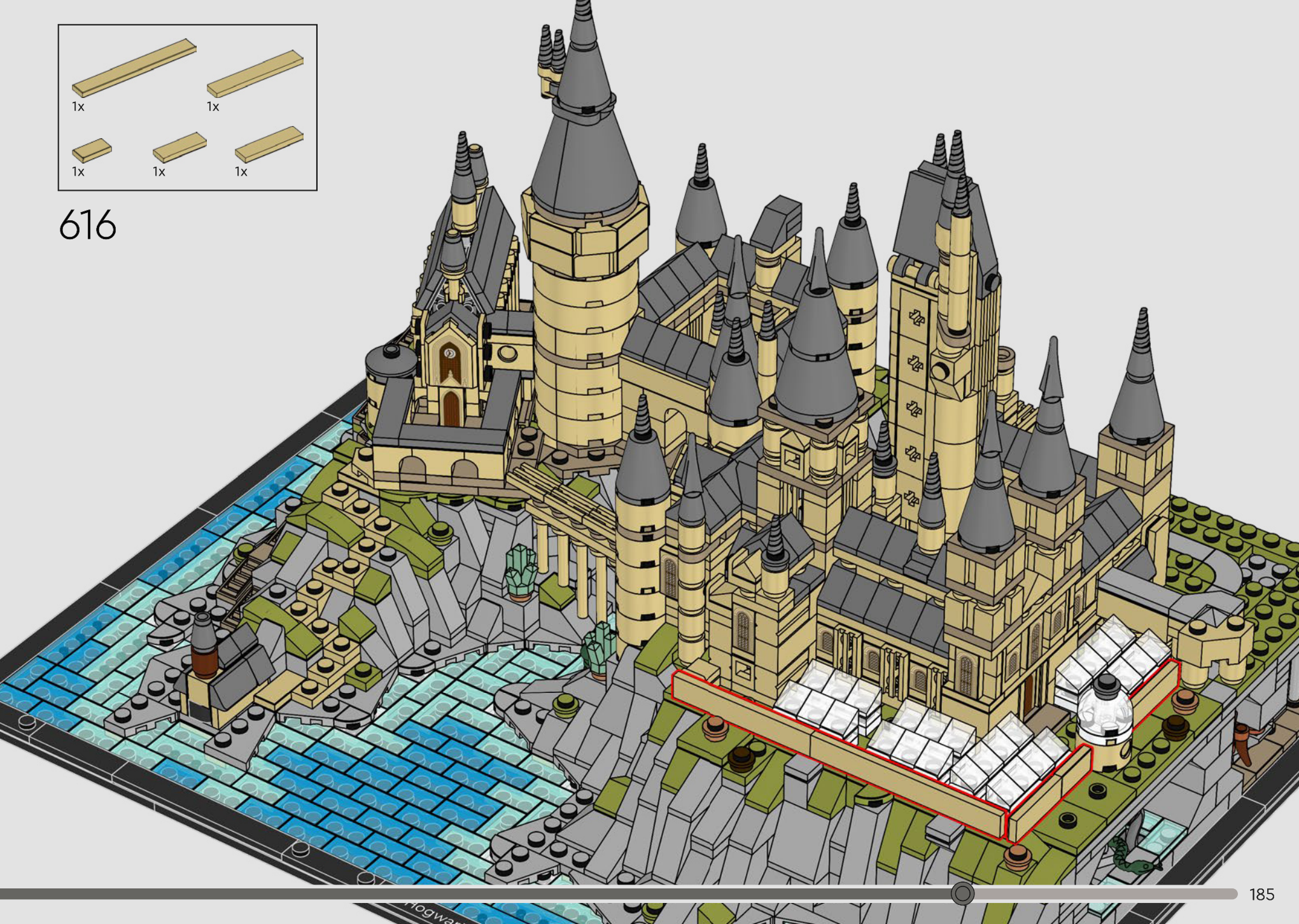

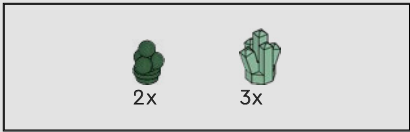

617

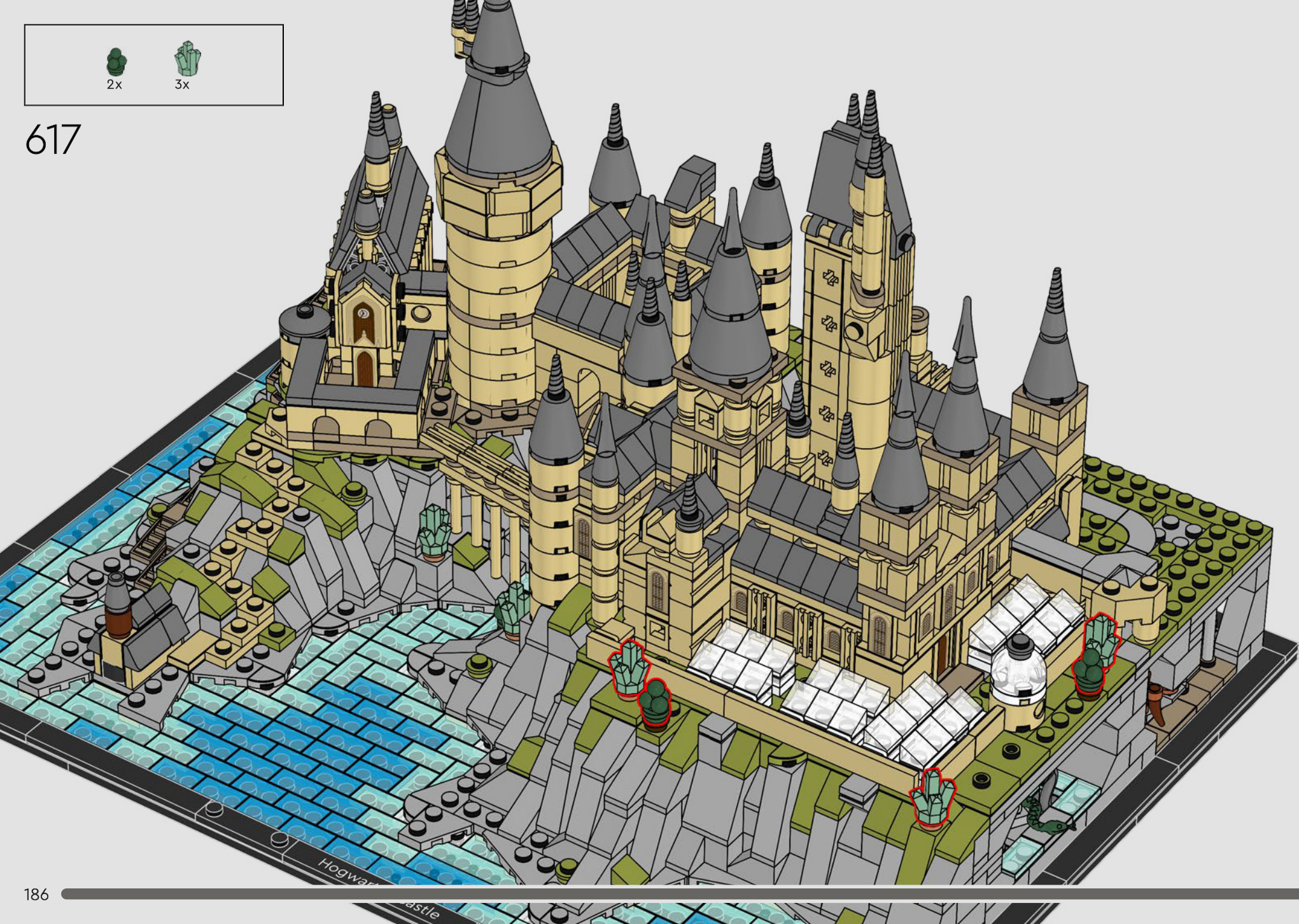

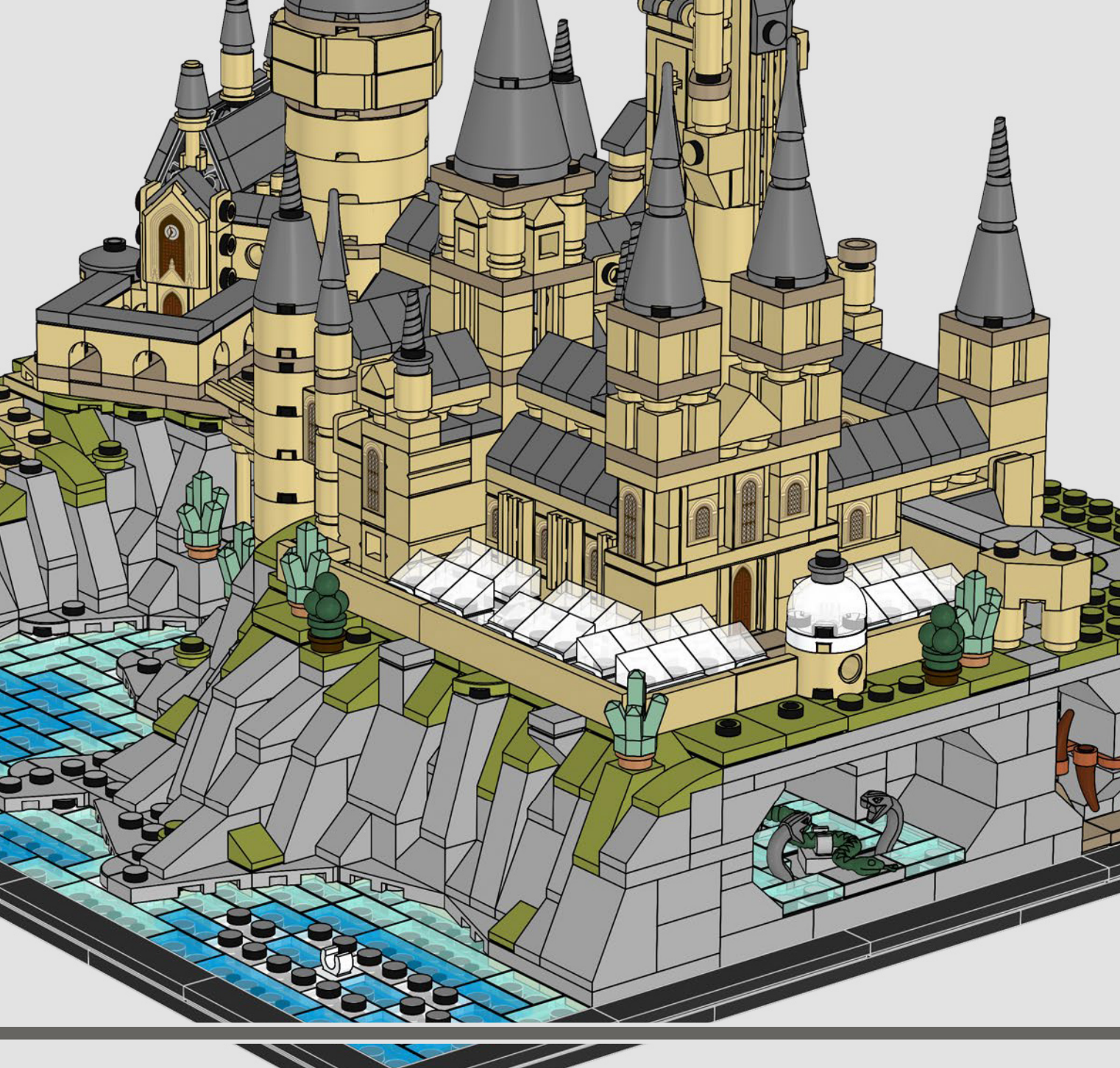

Nelle serre, la  
Professoressa Sprite,  
capo del dipartimento  
di Erborologia di  
Hogwarts™, guida  
gli studenti in modo  
sicuro nella cura e  
nell'uso delle piante  
magiche. Ora, se solo  
tutti usassero i loro  
paraorecchie...



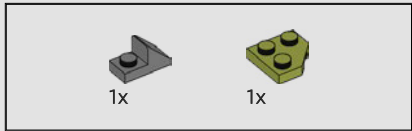

618

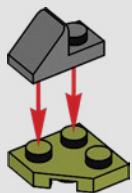

619

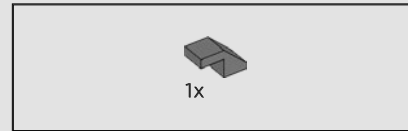
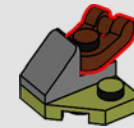

620

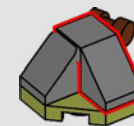

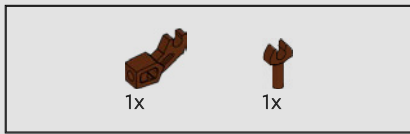

621

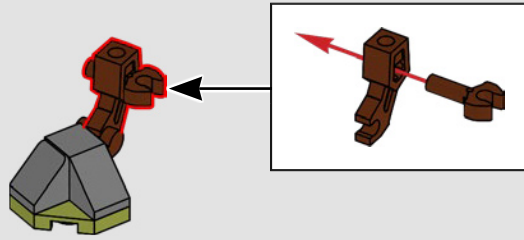

622



623

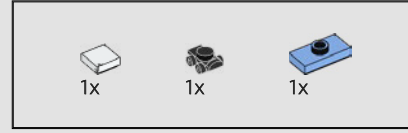
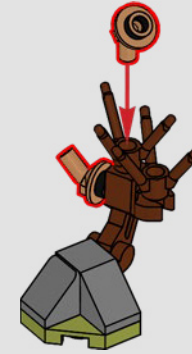

624

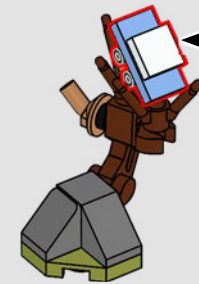
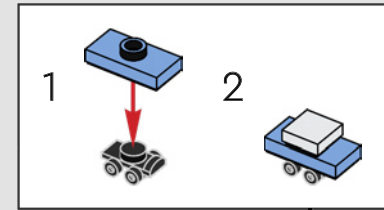



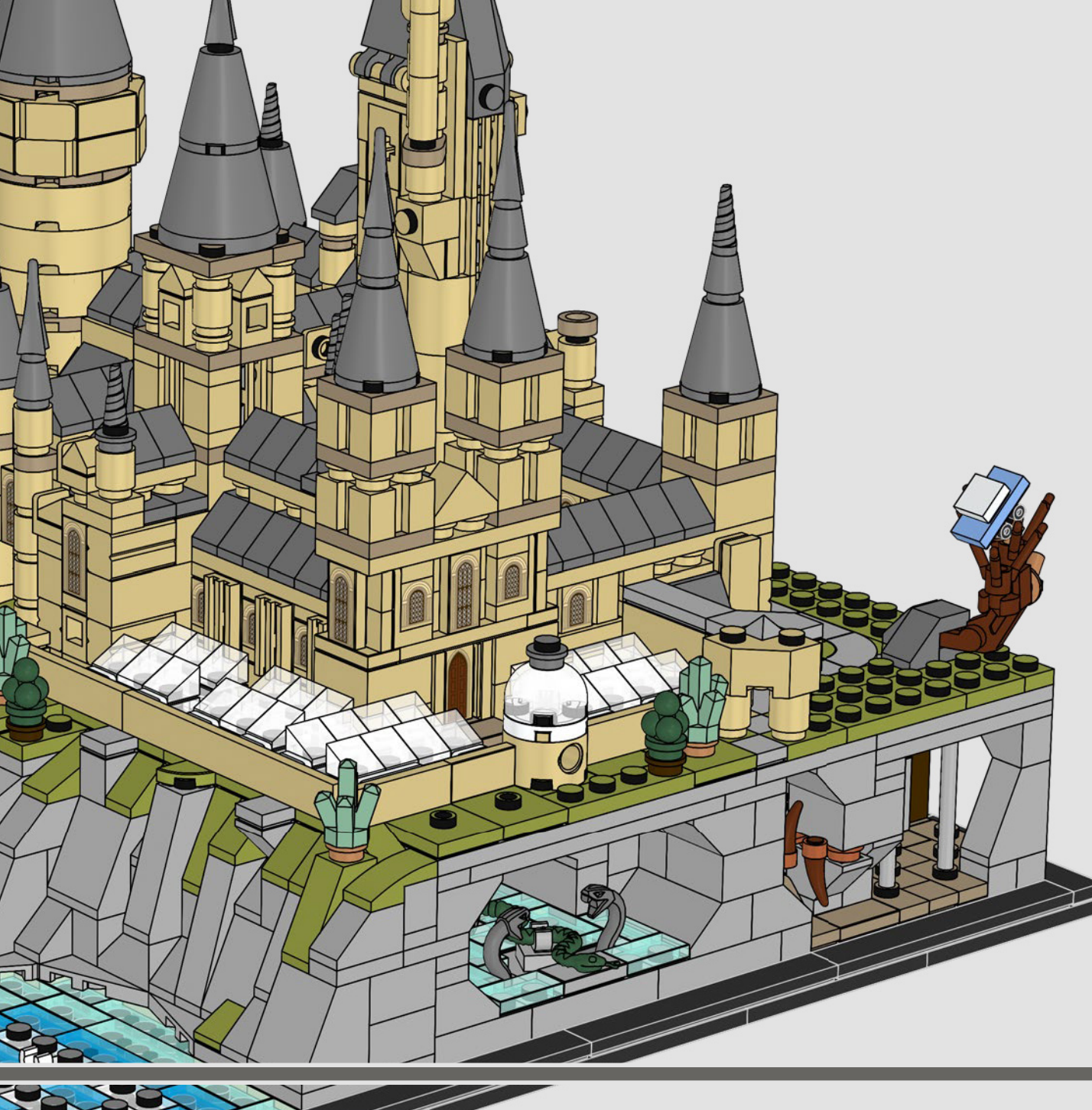

Il Platano Picchiatore è stato piantato per dare al Professor Lupin una via di fuga sicura durante i suoi episodi di licantropia con la luna piena. Nasconde un tunnel segreto che conduce alla Strimberga Strillante, dove Lupin rimaneva fino alla sua nuova trasformazione in forma umana.



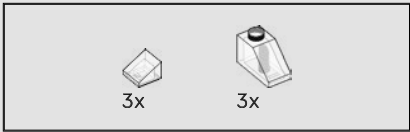

626

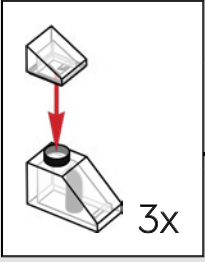
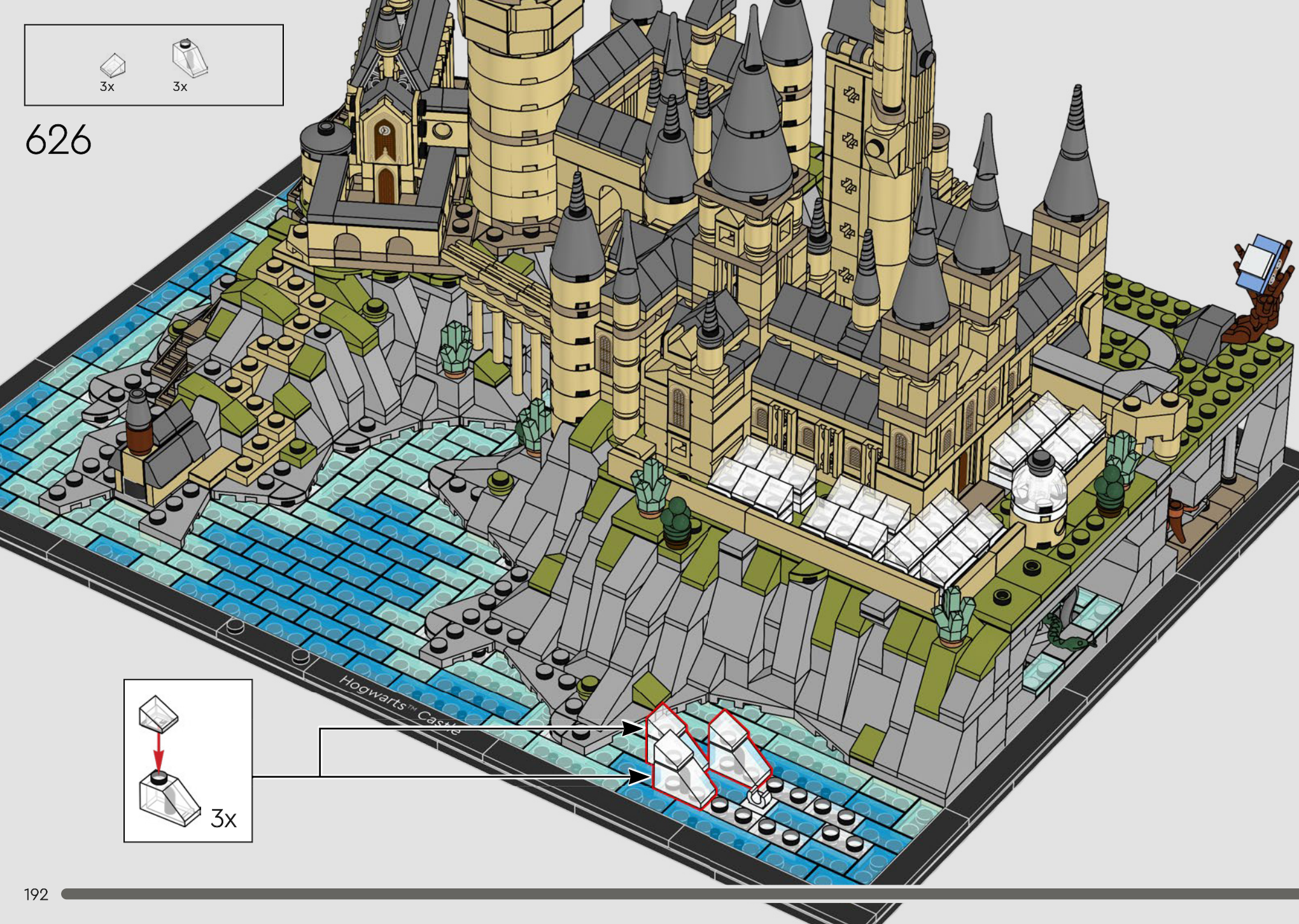





627

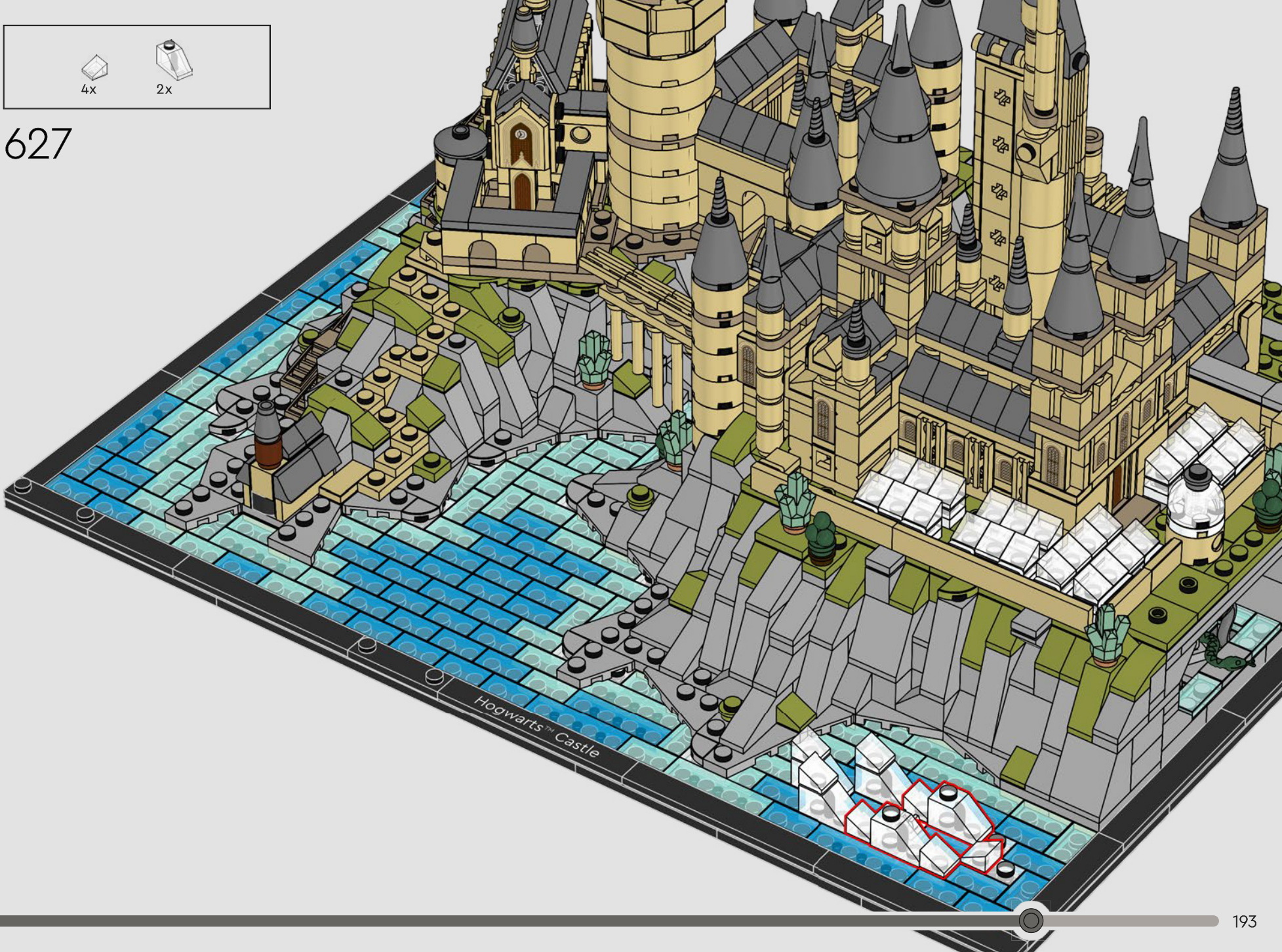

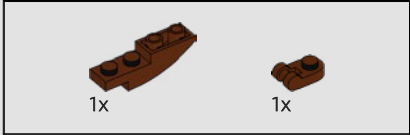
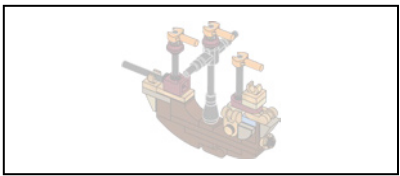

628

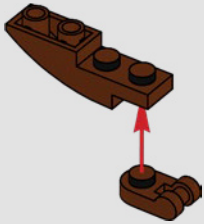

629

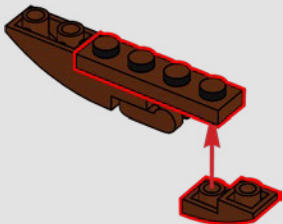

630

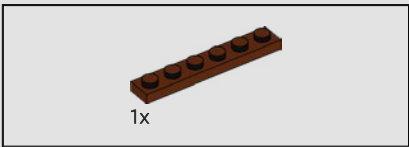
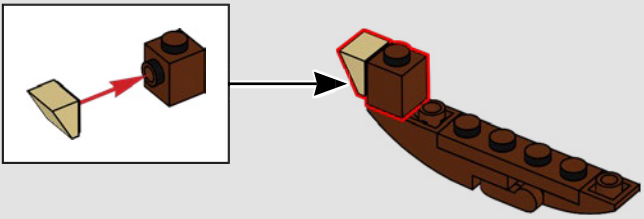

631

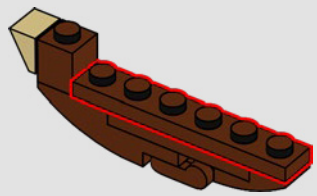

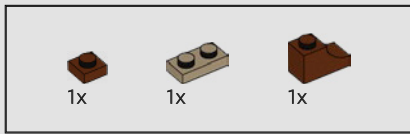

632

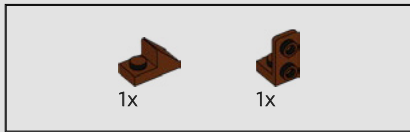
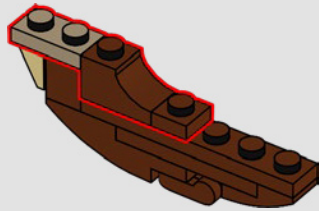

633

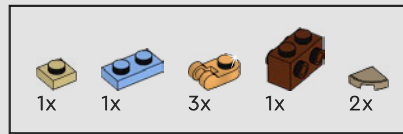
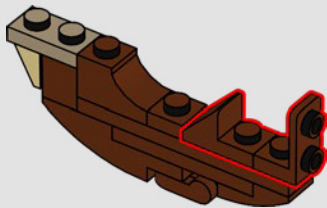

634

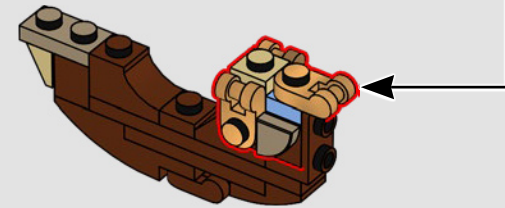
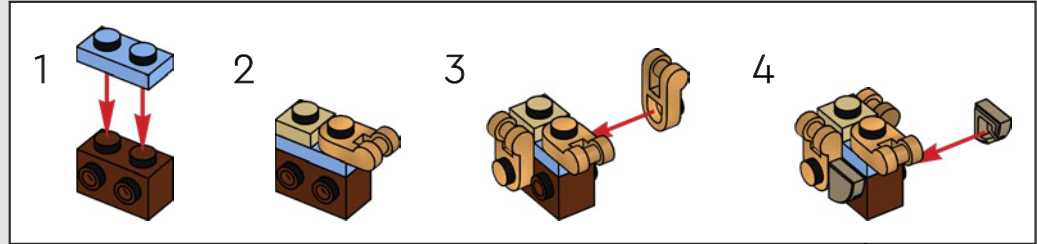



635

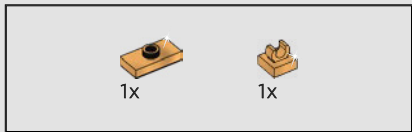
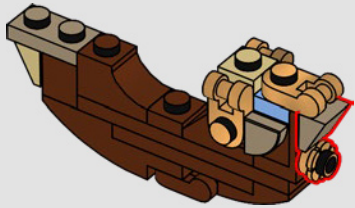

636

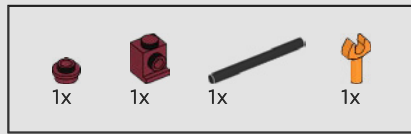
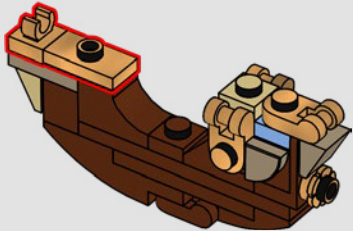

637

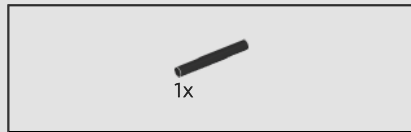
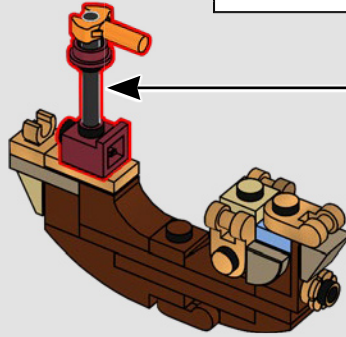
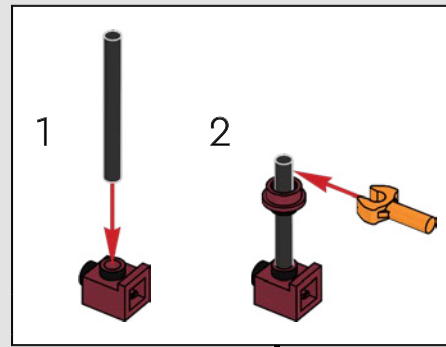

638

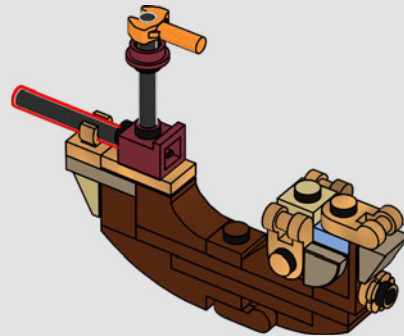

La magica Nave di Durmstrang veniva usata per viaggiare tra l'Istituto Durmstrang e Hogwarts™ in occasione del Torneo dei Tremaghi. Ma ti sei mai chiesto come la nave sia arrivata dal Mare del Nord al Lago Nero?



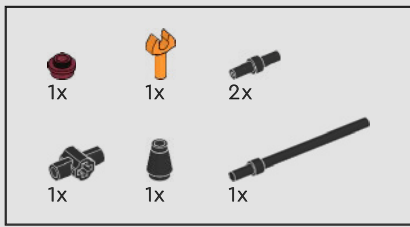

639

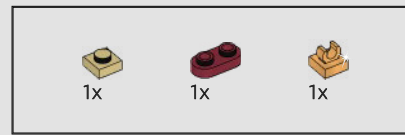
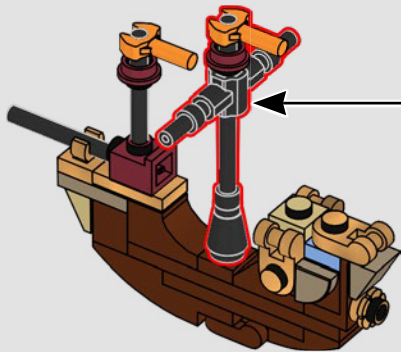
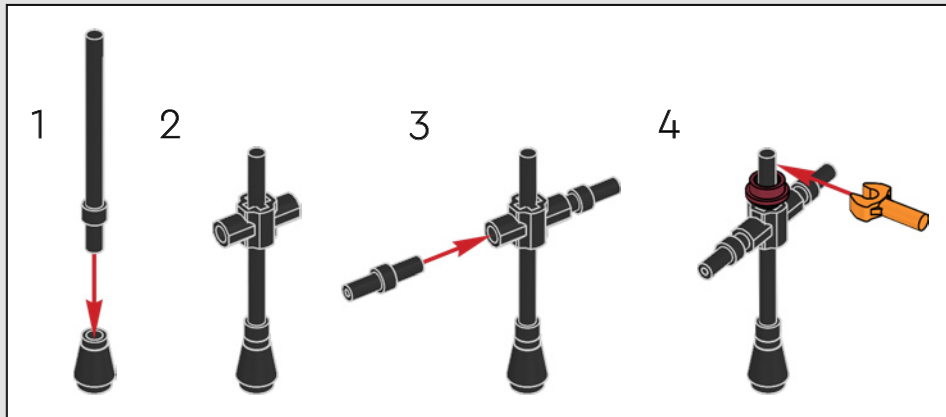

640

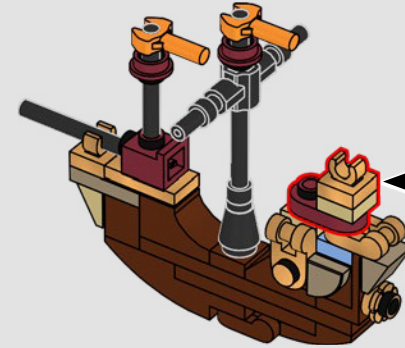
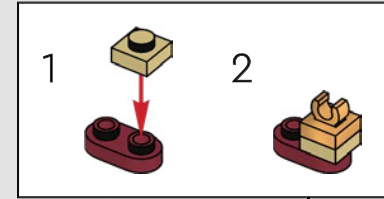

641

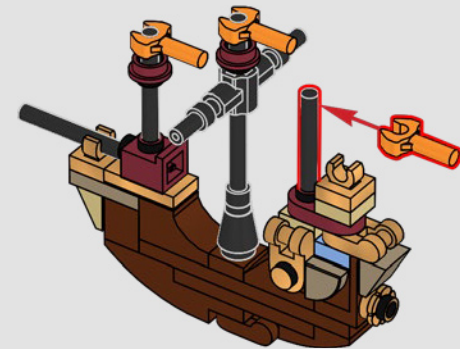



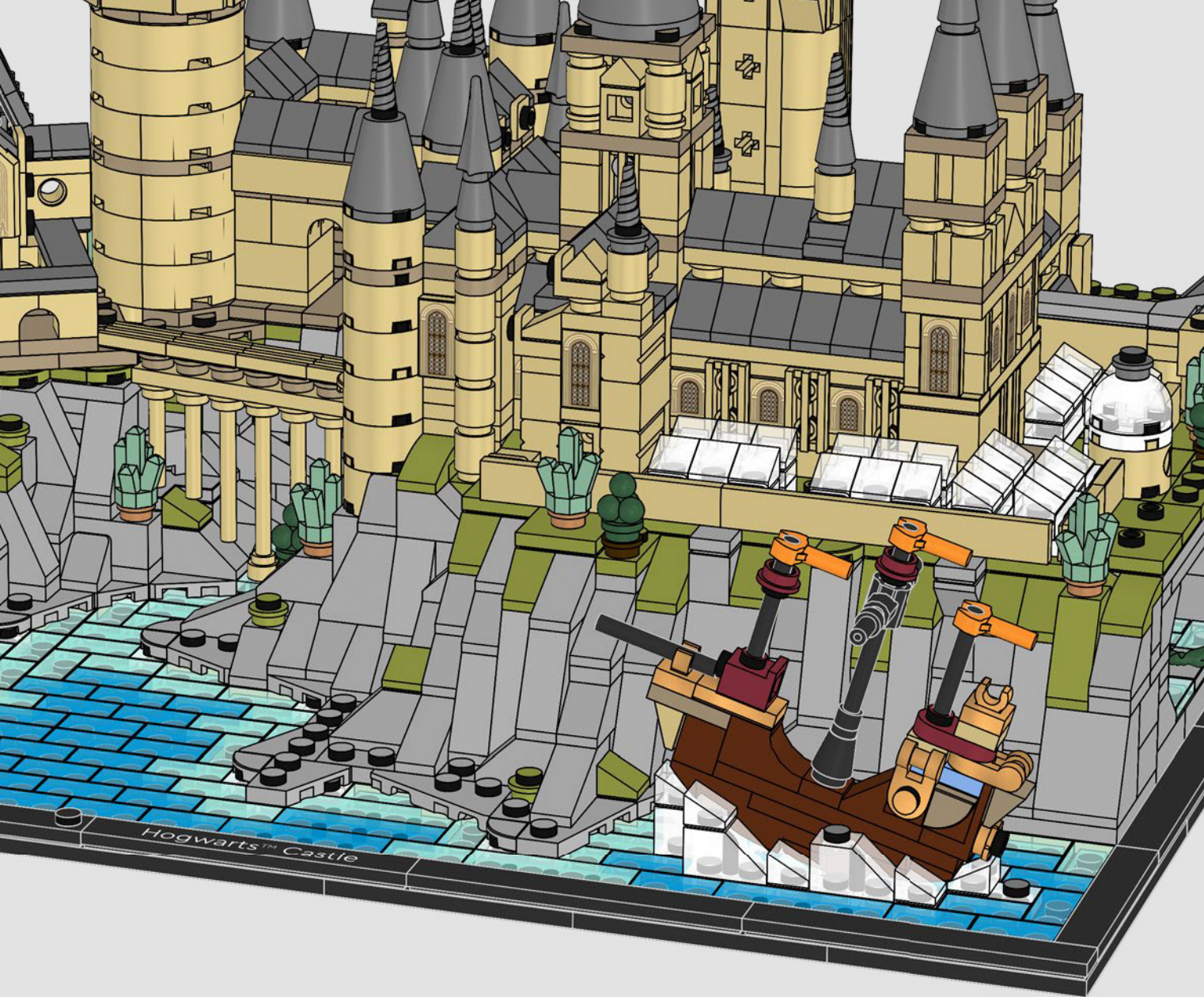

La nave di  
Durmstrang arrivò nel  
lago attraverso una  
scorciatoia magica  
creata tra il lago e  
altri corpi d'acqua -  
una vera magia!

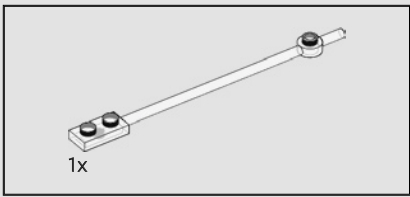

643

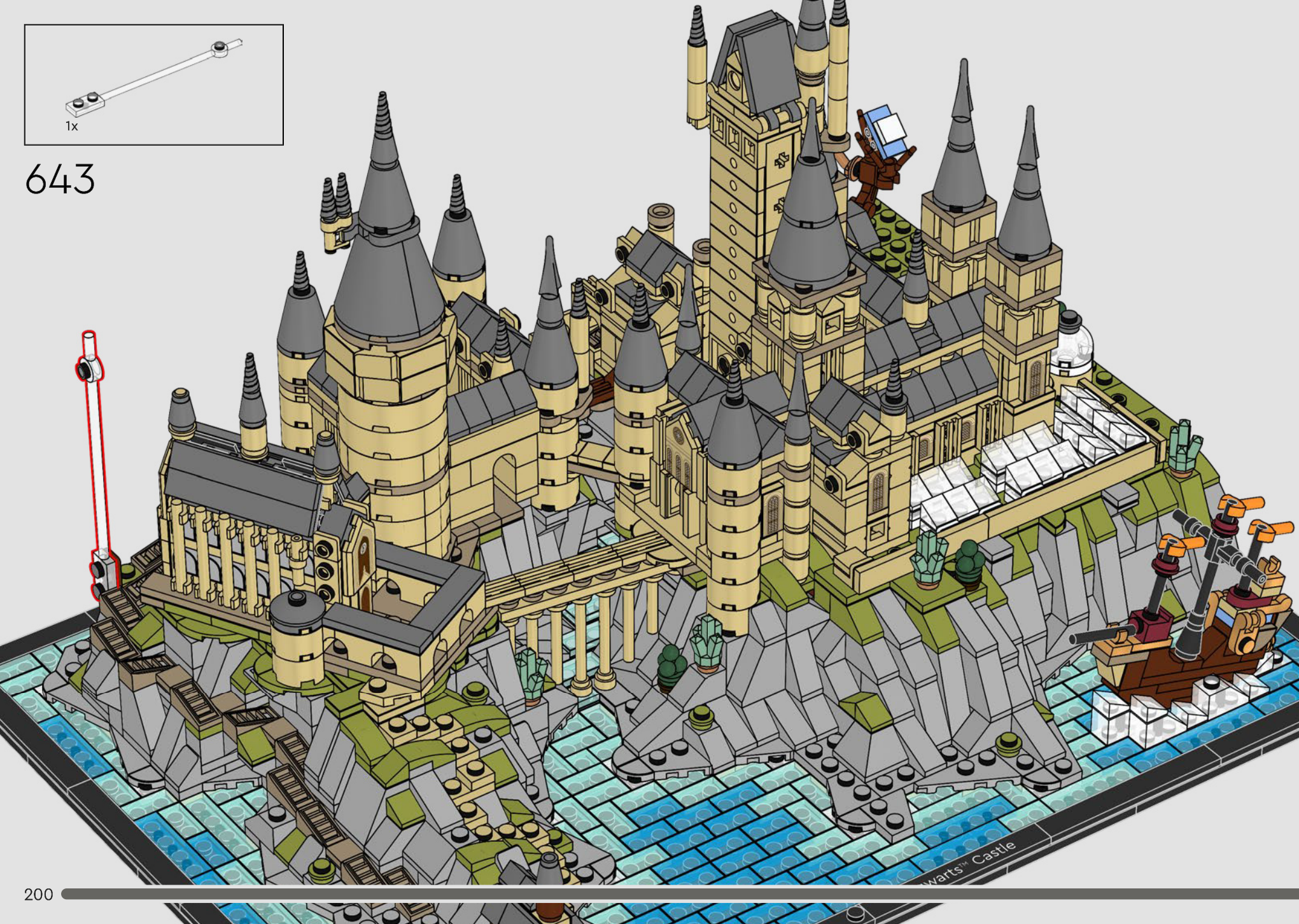



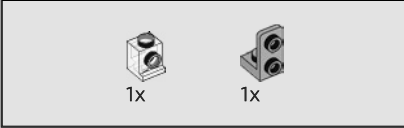

644

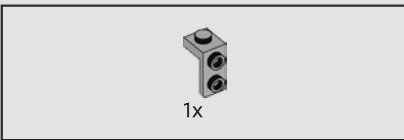
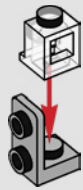

645



646

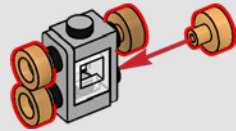



647

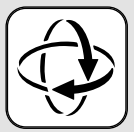
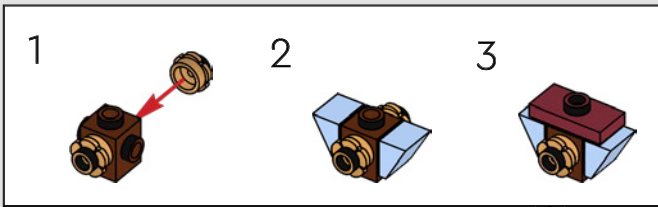

648

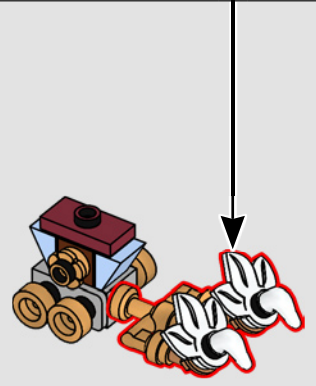
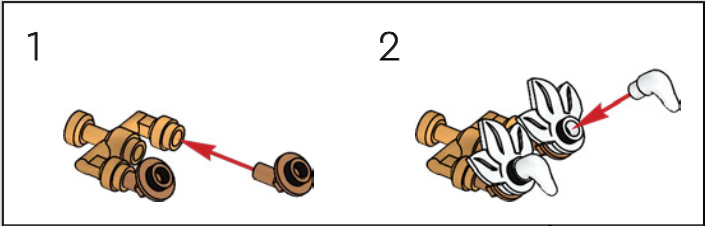

649

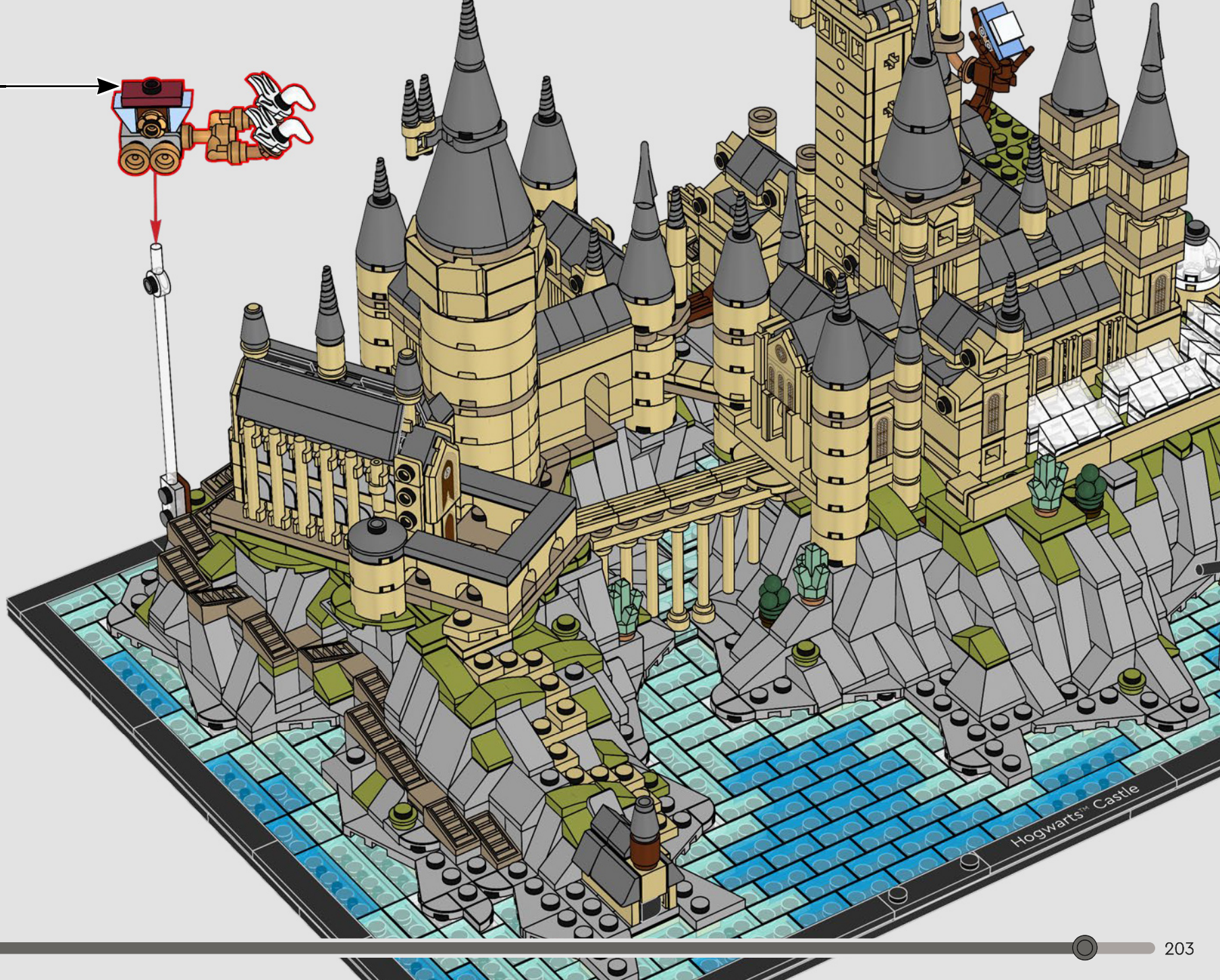

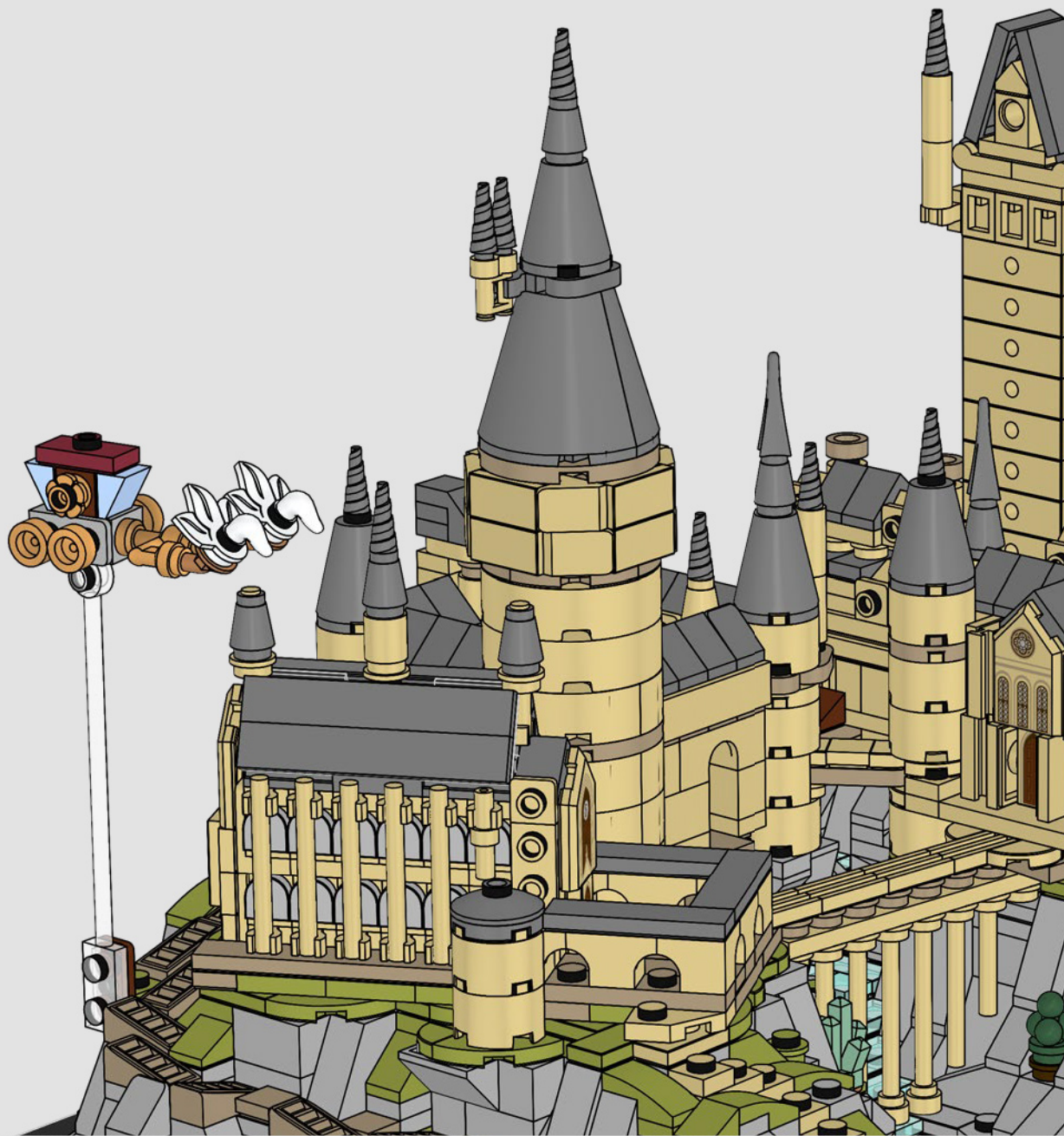

Il Pegaso della Carrozza di Beauxbatons è costruito con elementi corno e foglie bianchi LEGO®. Hai notato le redini? In realtà si tratta di un portacandele magicamente trasformato!

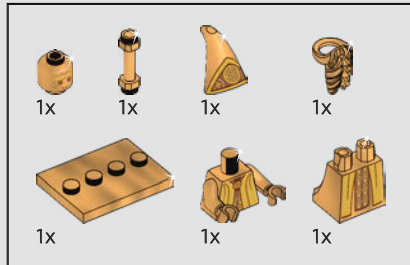

650

1

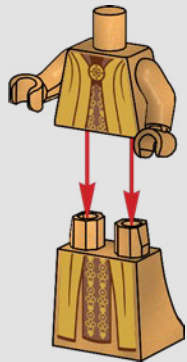

2

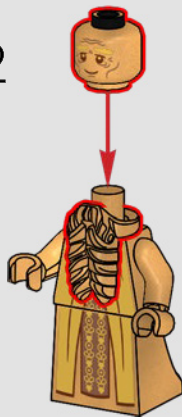

3

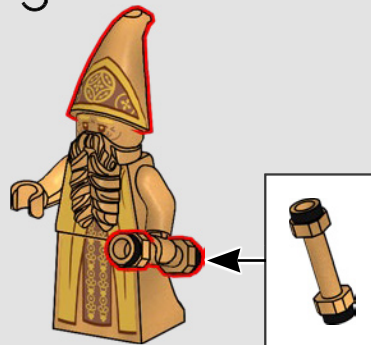

4



La minifigure dell'Architetto del Castello di Hogwarts™ è stata creata esclusivamente per questo set, con un nuovo elemento barba e un modello di Hogwarts e una pergamena con il progetto in mano.

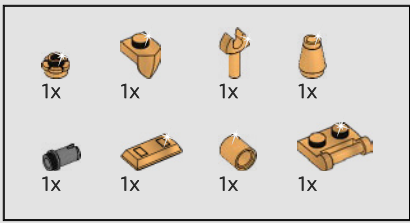

651

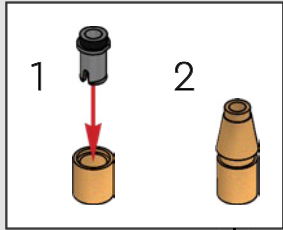

1

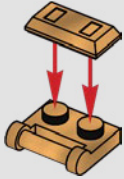

2

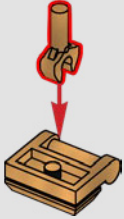

3

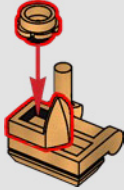

4





L'Architetto del Castello di Hogwarts™ era attivo negli anni a cavallo del X secolo. Non si sa molto della sua vita o di altre sue opere.





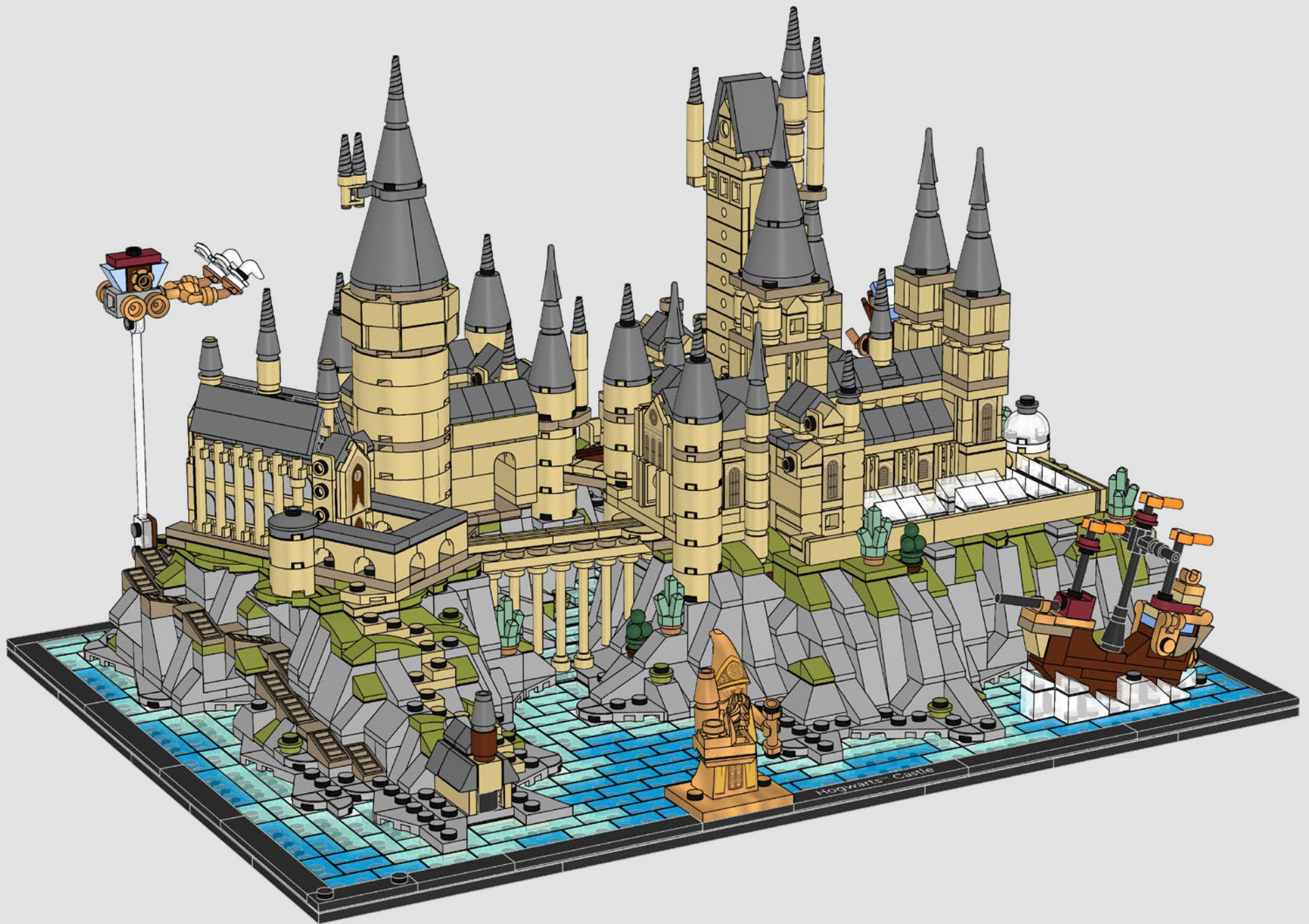

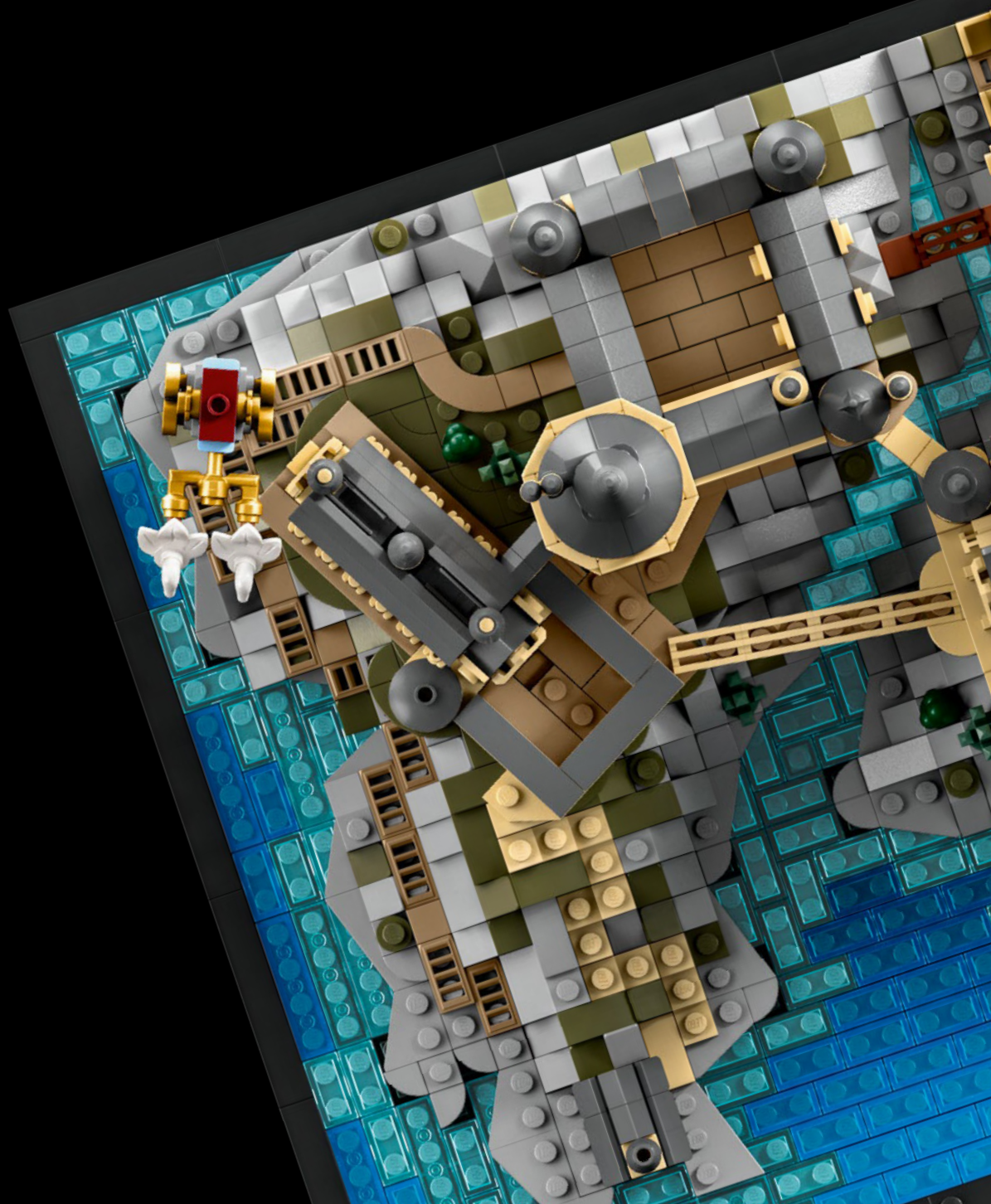

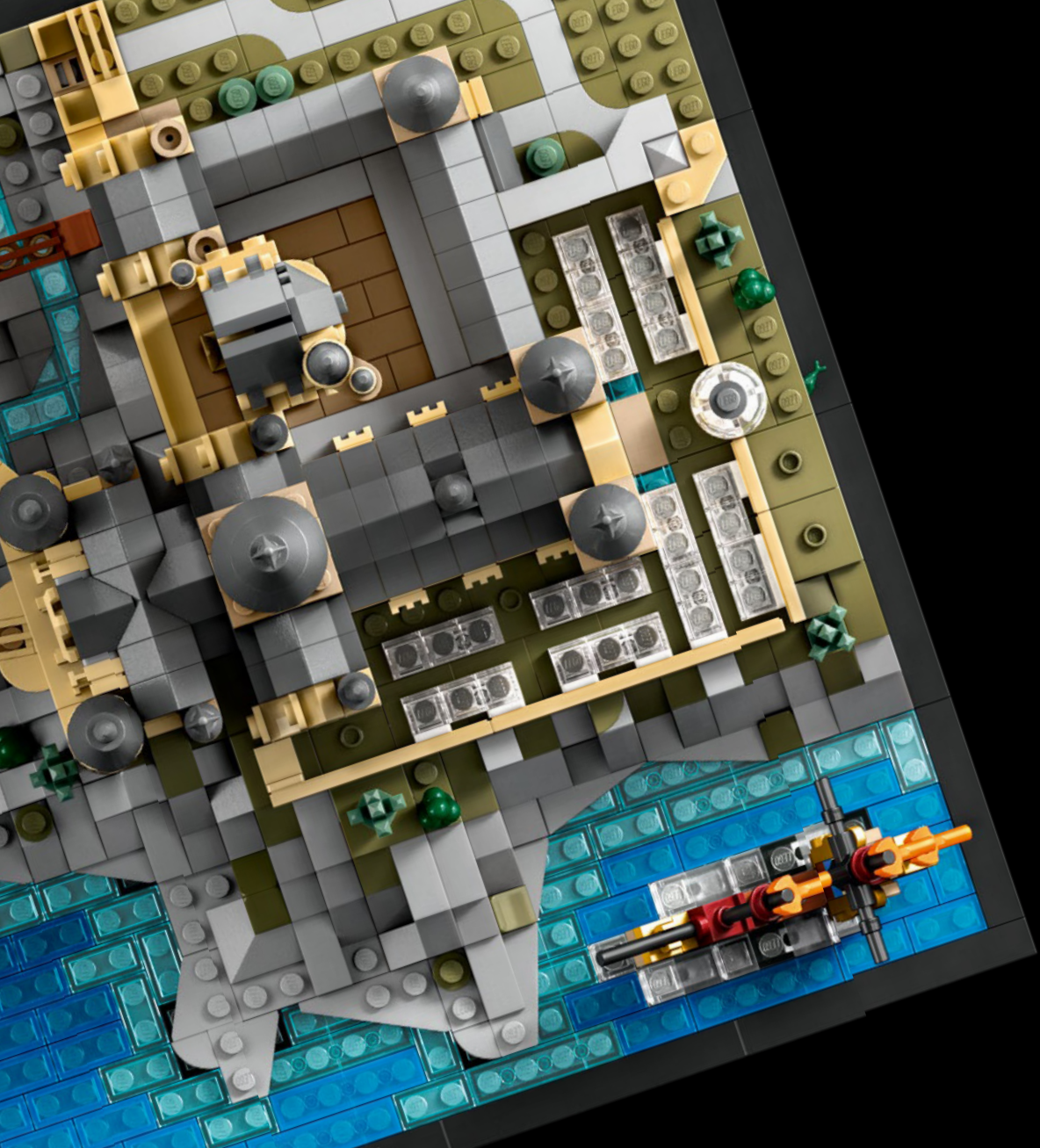

Hogwarts™ Castle



- 2x 614101
- 2x 6186681
- 2x 6328195
- 5x 307001
- 9x 302401
- 1x 6348055
- 8x 6242241
- 2x 4111971
- 2x 6382783
- 1x 6044691
- 1x 403201
- 1x 4667575
- 7x 302301
- 1x 6070698
- 3x 362301
- 11x 6195371
- 1x 4550745
- 1x 246501
- 3x 300201
- 2x 371001
- 2x 300101
- 1x 6222425
- 1x 366601
- 7x 6454936
- 27x 4117070
- 3x 4529237
- 63x 4161734
- 11x 6443061
- 2x 6353196
- 1x 4569547
- 1x 6167923
- 19x 4113915
- 20x 6454440
- 30x 4118793
- 9x 6230284
- 41x 4159553
- 16x 4125253
- 10x 4516055
- 8x 6232135
- 2x 4612603
- 3x 6145570
- 3x 4529237
- 63x 4161734
- 11x 6443061
- 2x 6353196
- 17x 6365720
- 3x 6374151
- 1x 4213568
- 1x 4224793
- 1x 6360037
- 1x 6454941
- 2x 6212758
- 5x 6351413
- 2x 6408047
- 1x 6447501
- 1x 6262018
- 1x 4624086
- 2x 4140562
- 2x 4579260
- 2x 4179771
- 4x 6175968
- 17x 6365720
- 3x 6374151
- 1x 4213568
- 1x 4224793
- 1x 6360037
- 1x 6454941
- 2x 6212758
- 5x 6351413
- 2x 6408047
- 1x 6447501
- 1x 6262018
- 1x 4624086
- 2x 4140562
- 2x 4579260
- 2x 4179771
- 4x 6175968
- 17x 6365720
- 3x 6374151
- 6x 6236425
- 40x 4113917
- 34x 4114026
- 9x 6148262
- 43x 6092587
- 36x 4124456
- 10x 6455327
- 3x 6236914
- 8x 6069165
- 4x 4109995
- 1x 6024495
- 1x 6214334
- 2x 4159279
- 5x 6236423
- 1x 6445058
- 3x 6455326
- 10x 6391523
- 9x 6219794
- 2x 6103001
- 1x 4205107
- 7x 6174925
- 1x 6313611
- 1x 6117975
- 1x 6249809
- 2x 6253003
- 4x 4160483
- 1x 6374166
- 2x 4217562
- 5x 6443062
- 2x 4124455
- 6x 4114077
- 6x 4114306
- 2x 6221467
- 5x 6454937
- 16x 4114084
- 4x 4185177
- 1x 4188866
- 1x 6148265
- 12x 6055868
- 1x 6469454
- 1x 6458487
- 1x 6454439
- 11x 4121921
- 6x 6131896
- 2x 4162465
- 7x 4618651
- 1x 6058093
- 4x 6211966
- 9x 6410762
- 1x 6245271
- 1x 4543858
- 12x 6116614
- 9x 4118790
- 4x 4159739
- 2x 6175367
- 10x 4113233
- 5x 6232136
- 7x 6257600
- 5x 4550324
- 23x 6352222
- 2x 4113916
- 1x 6213676
- 2x 6294592
- 4x 6115031
- 2x 6454935
- 10x 4114309
- 1x 6351905
- 7x 4124067
- 6x 4112982
- 1x 4157277
- 3x 4243824
- 1x 6383728
- 7x 4113993
- 2x 4181134
- 4x 4114324
- 2x 4159774
- 1x 4544139
- 4x 4114001
- 4x 4113988
- 1x 6075179
- 1x 4624185
- 2x 447721
- 2x 611121
- 4x 614121
- 2x 362221
- 1x 302121
- 5x 371021
- 2x 6372124
- 4x 6315780
- 1x 6347604
- 5x 242023
- 5x 301023
- 2x 366623
- 17x 614124
- 6x 362224
- 3x 362324
- 1x 4188313
- 1x 6457333
- 1x 6350055
- 1x 6454443
- 3x 6212377
- 1x 6207933
- 1x 6092594
- 1x 6326425
- 1x 6454437
- 1x 4585493
- 1x 6378168
- 4x 6209691
- 1x 4529247
- 1x 6186672
- 1x 6453281
- 1x 6454435
- 1x 6256803
- 2x 6262138
- 1x 6415995
- 1x 6083975

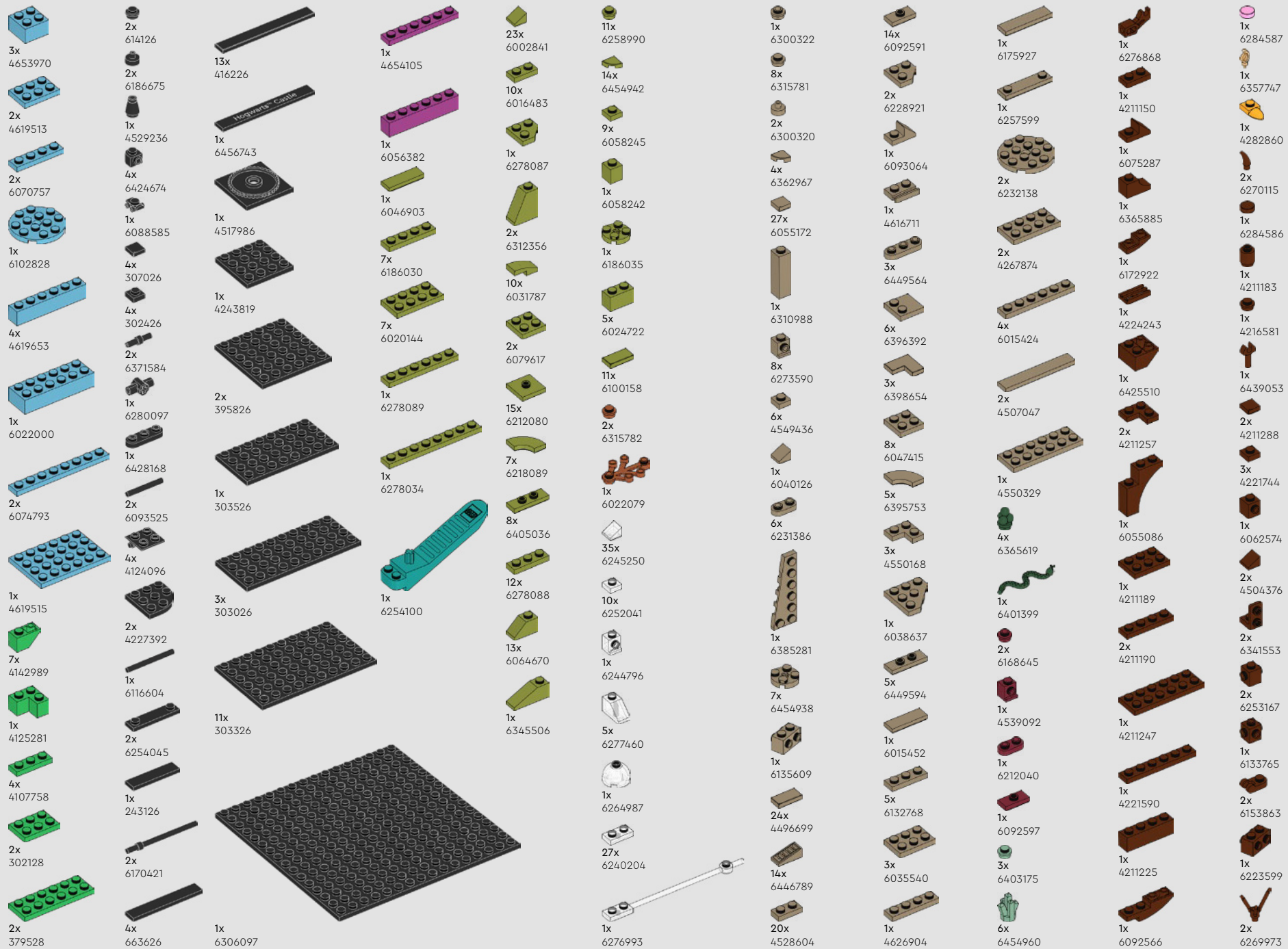

- 1x 4210763
- 2x 6168776
- 4x 4211066
- 2x 6331866
- 3x 4211094
- 1x 6126083
- 1x 6201630
- 10x 6092666
- 1x 6115080
- 1x 4211010
- 2x 6174938
- 17x 6445056
- 6x 6269969
- 15x 4529240
- 2x 6331689
- 1x 4210867
- 2x 4211100
- 8x 4210719
- 1x 4243831
- 1x 6186635
- 2x 4211103
- 3x 6231765
- 2x 4210633
- 1x 6431826
- 3x 6395635
- 4x 6454438
- 1x 4211098
- 5x 6343852
- 4x 4210651
- 4x 6262021
- 2x 4504378
- 2x 6234583
- 2x 6235153
- 7x 6167641
- 4x 6400315
- 51x 6251289
- 8x 6252050
- 1x 4179825
- 1x 6092601
- 1x 6221607
- 1x 6296892
- 45x 4226221
- 3x 4567887
- 14x 4211135
- 1x 4211088
- 3x 6069164
- 2x 6092572
- 3x 4211053
- 1x 4211105
- 1x 4529241
- 1x 6284071
- 3x 6448793
- 21x 6250597
- 1x 6455328
- 5x 4521921
- 23x 4211389
- 5x 6362975
- 12x 6176433
- 3x 6345639
- 2x 6433942
- 12x 6163478
- 6x 4211415
- 2x 4211489
- 1x 4526932
- 9x 4211394
- 1x 6420741
- 6x 4211791
- 5x 4211794
- 1x 6234738
- 18x 4211399
- 1x 6225242
- 46x 4211614
- 1x 6347715
- 3x 6258381
- 2x 4568637
- 2x 6075075
- 15x 4211488
- 2x 6211969
- 12x 4211428
- 7x 6116608
- 4x 6066097
- 5x 6186657
- 1x 4216248
- 3x 6308012
- 4x 6065824
- 1x 4651063
- 1x 6469440
- 1x 6269049
- 40x 4515374
- 12x 4211437
- 6x 4657459
- 2x 4211773
- 10x 4211445
- 13x 6093859
- 11x 4211494
- 46x 4211398
- 9x 4211414
- 2x 6170387
- 1x 4211564
- 2x 6123809
- 5x 4234535
- 8x 4211353
- 2x 4211410
- 1x 6163990
- 11x 4211396
- 2x 4211356
- 1x 6213378
- 13x 6435857
- 14x 4211349
- 11x 4211387
- 1x 4216250
- 3x 4211397
- 1x 6177078
- 1x 6126082
- 18x 4211429
- 8x 4211386
- 2x 6435930
- 1x 6306729
- 4x 6163477
- 1x 4645397
- 3x 4558169
- 1x 6075066
- 3x 4211438
- 2x 4211393
- 1x 4618874
- 2x 4243797
- 2x 4211549
- 1x 6015347
- 7x 4211385
- 2x 4211395
- 1x 6372029
- 1x 4211392
- 6x 4211404
- 1x 6037399
- 1x 4211474
- 3x 4251149
- 2x 4211521
- 2x 4211407
- 3x 6059033
- 3x 4211452
- 1x 4211795
- 2x 4211425
- 6x 4157103
- 3x 6439042
- 3x 4173805
- 16x 4121739
- 17x 4220634
- 23x 4164037
- 10x 6254256
- 85x 6251295
- 3x 6343877
- 11x 6252049
- 1x 4211522
- 1x 4211402
- 1x 4211405



 [LEGO.com/service](https://www.LEGO.com/service)



# YOU COULD WIN



## YOU COULD WIN

Your feedback will help shape the future development of this product series.

Visit:

## DU KÖNNTEST GEWINNEN

Dein Feedback trägt zur Weiterentwicklung dieser Produktreihe bei.

Geh auf:

## VOUS POURRIEZ GAGNER

Vos commentaires nous aideront à concevoir les futurs produits de cette gamme.

Visitez :

## POTRESTI VINCERE TU

La tua opinione ci aiuterà a migliorare la creazione futura di questa linea di prodotti.

Visita:

## PUEDES GANAR

Tu opinión contribuirá al futuro de esta serie de productos.

Visita:

## 轻松获奖

您的反馈将有助于我们在今后改进本产品系列。

请访问:

---

**[LEGO.com/productfeedback](https://www.lego.com/productfeedback)**

---

You also have the chance to win a LEGO® set.

Terms and conditions apply.\*

Außerdem hast du die Chance, ein LEGO® Set zu gewinnen.

Es gelten die Teilnahmebedingungen.\*

Vous pourriez également gagner un ensemble LEGO®.

Des conditions s'appliquent.\*

Hai anche la possibilità di vincere un set LEGO®.

Termini e condizioni sono applicabili.\*

También tienes la oportunidad de ganar un set LEGO®.

Aplican términos y condiciones.\*

您还有机会赢取乐高®套装。

条款和条件适用。\*

\*[LEGO.com/productfeedback-terms](https://www.lego.com/productfeedback-terms)

# II

LEGO and the LEGO logo are trademarks of the LEGO Group. ©2023 The LEGO Group.

WIZARDING WORLD and all related trademarks, characters, names, and indicia are  
© & ™ Warner Bros. Entertainment Inc. Publishing Rights © JKR. (s23)