

Harry Potter

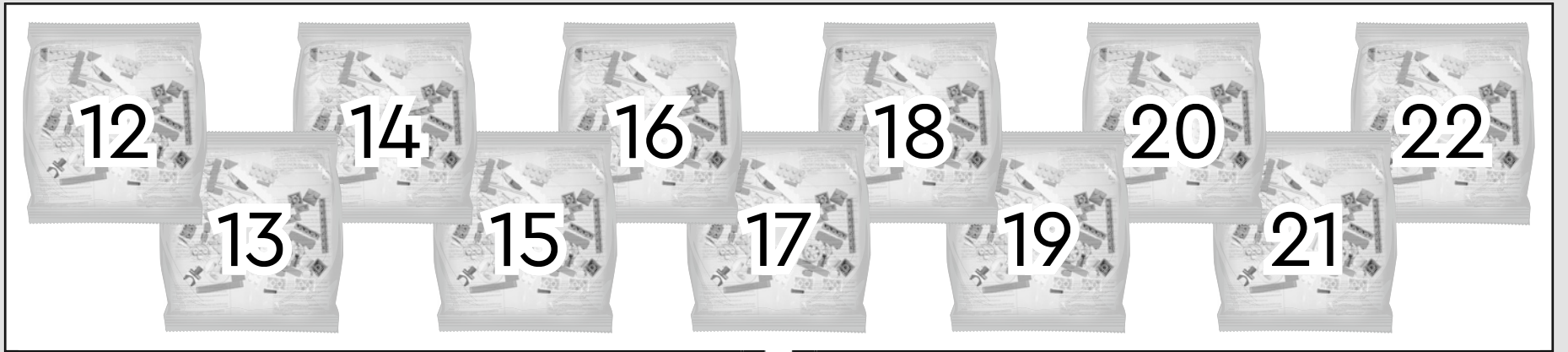

WIZARDING  
WORLD







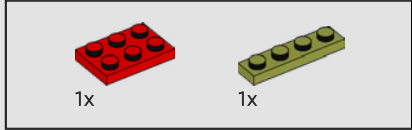
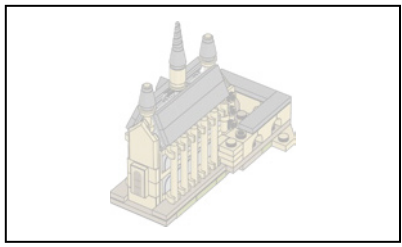

309

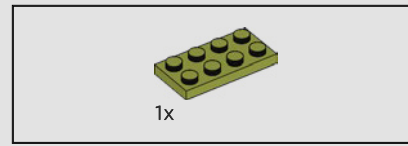
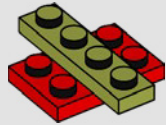

310

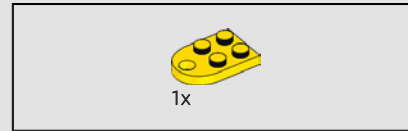
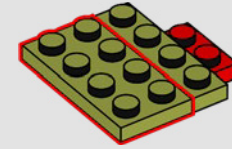

311

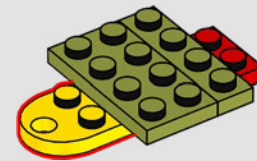



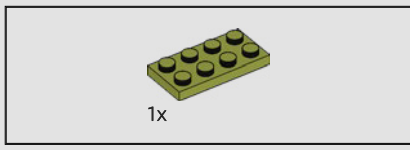

312

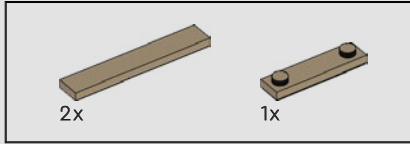
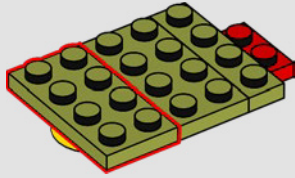

313

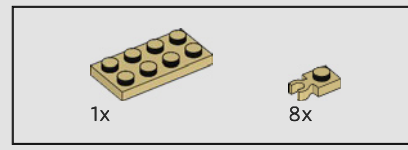
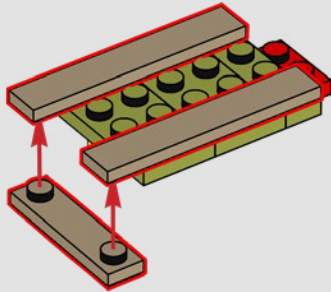

314

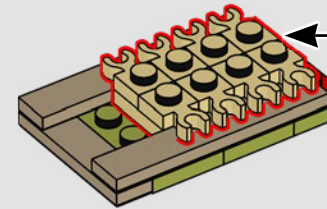
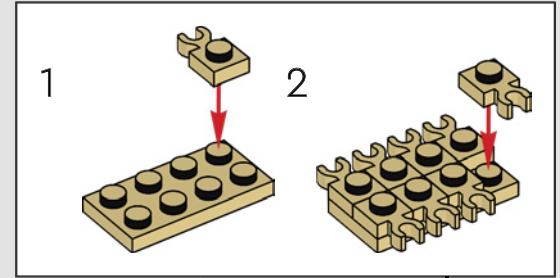

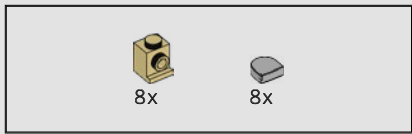

315

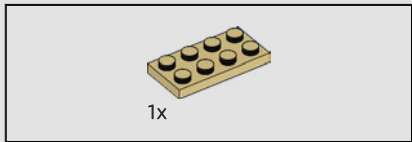
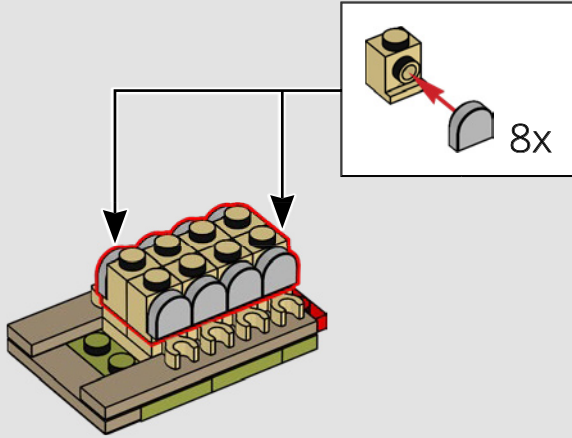

316

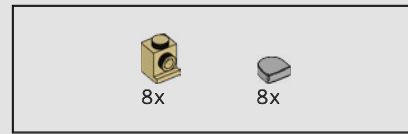
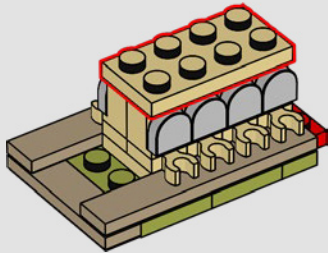

317

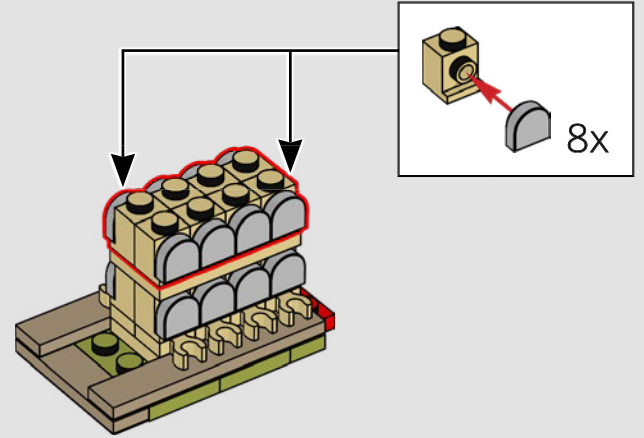

318

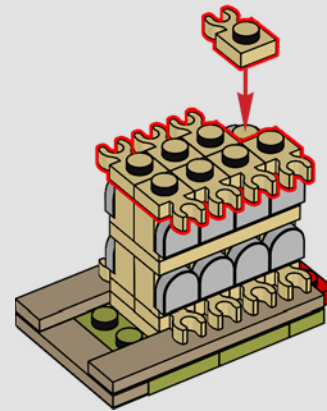



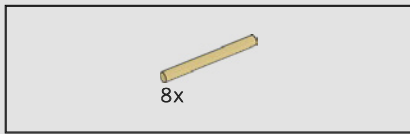

319

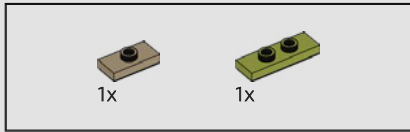
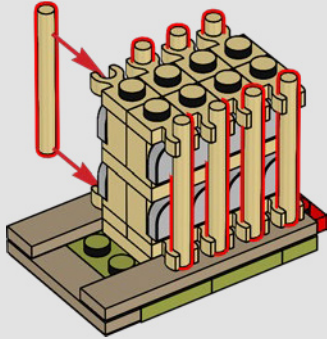

320

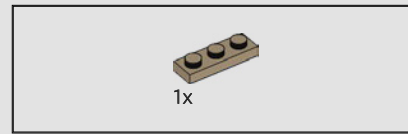
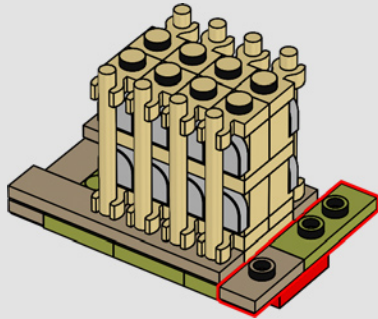

321

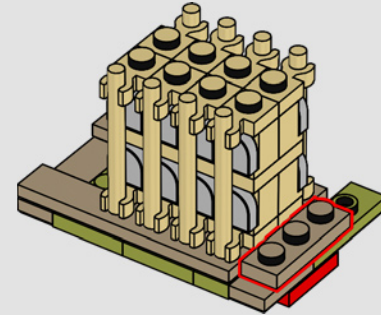

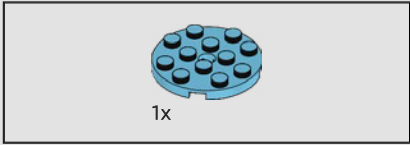
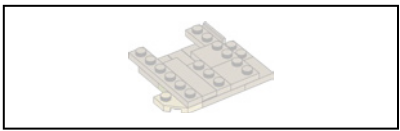

322

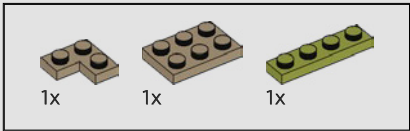
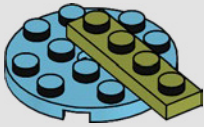

323

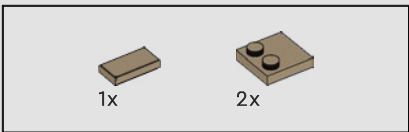
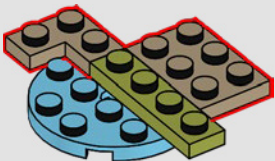

324

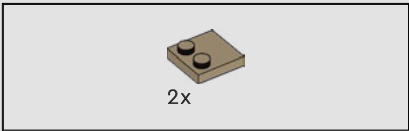
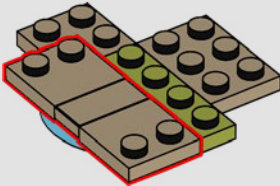

325

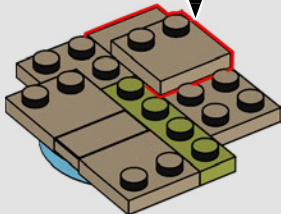
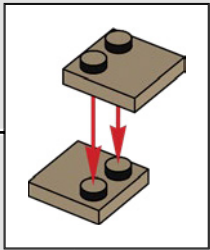



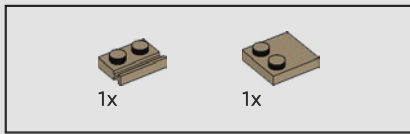

326

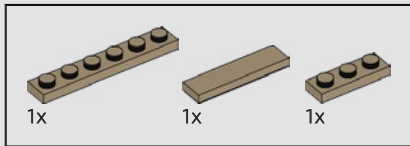
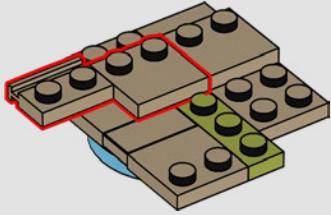

327

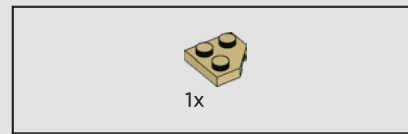
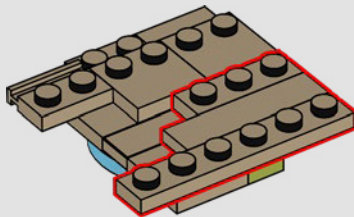

328

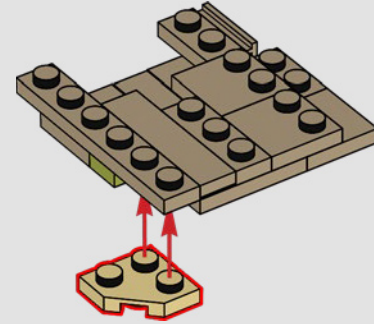
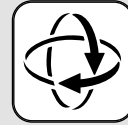

329

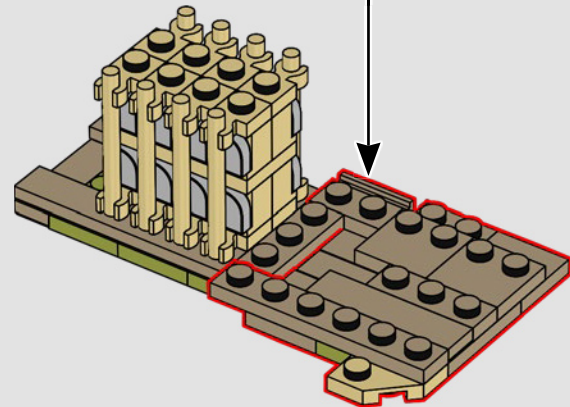

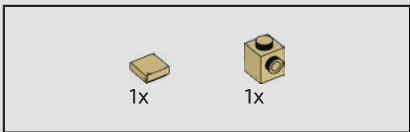

330

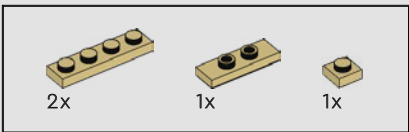
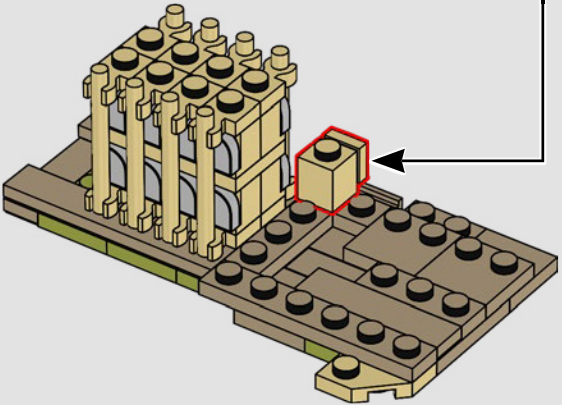
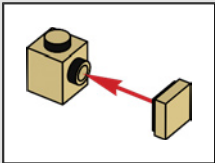

331

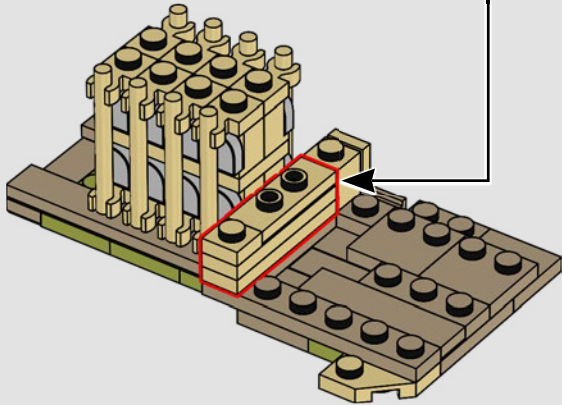
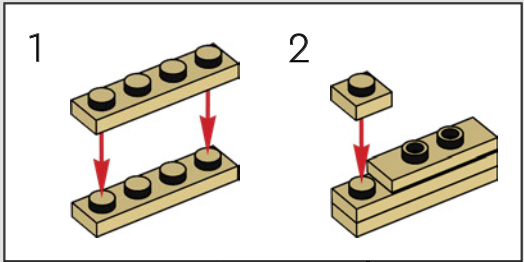



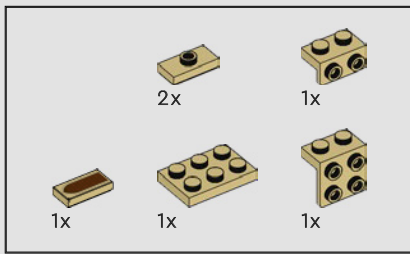

332

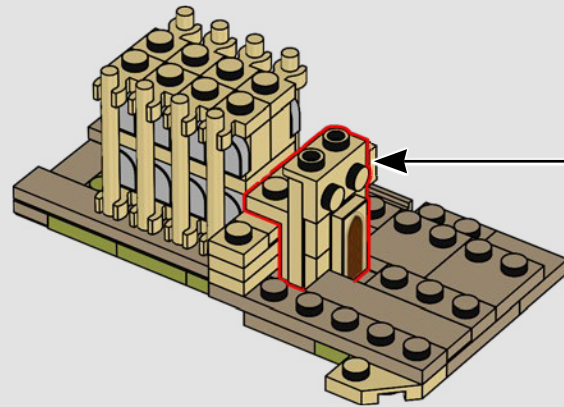
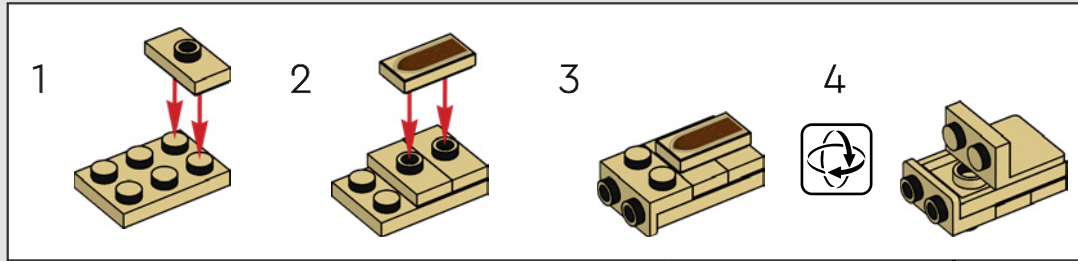



333

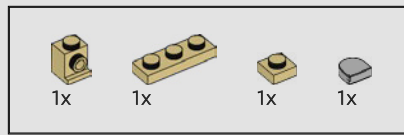
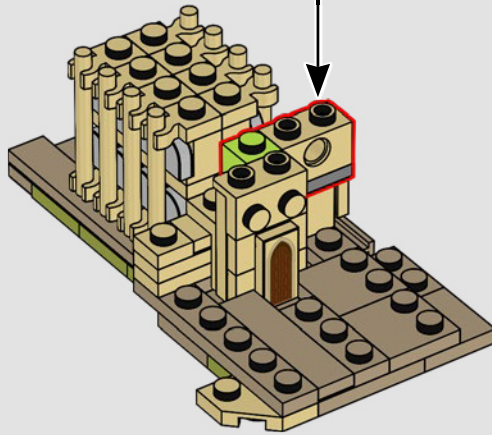
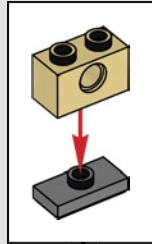

334

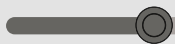
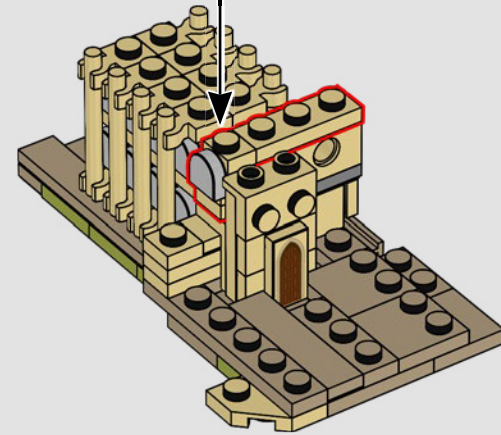
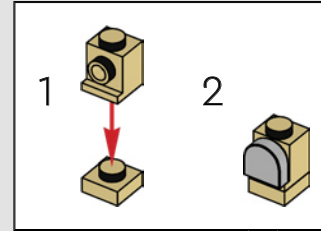



335

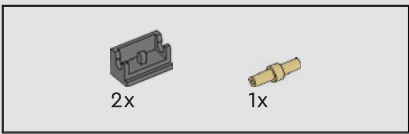
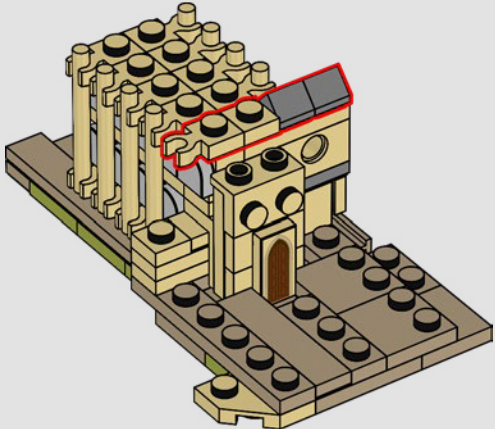

336

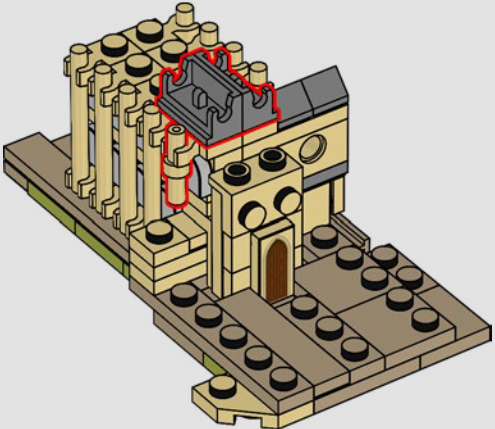

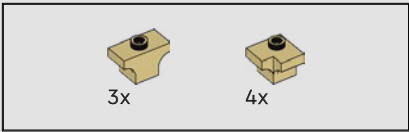

337

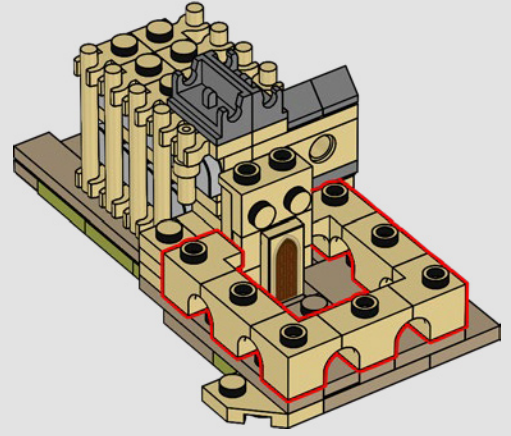

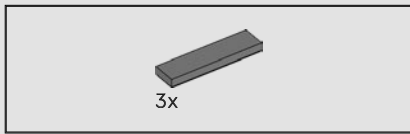

338

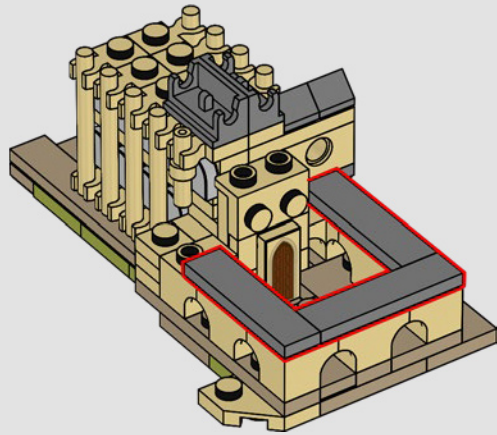

339

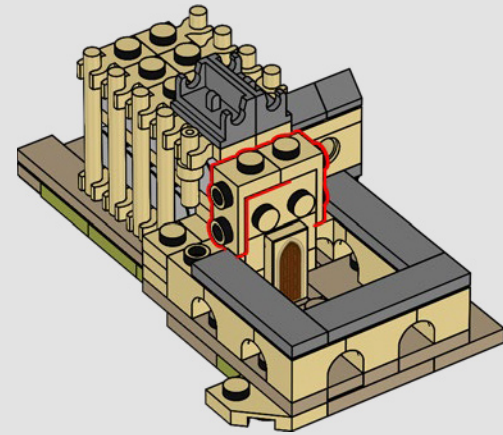





340

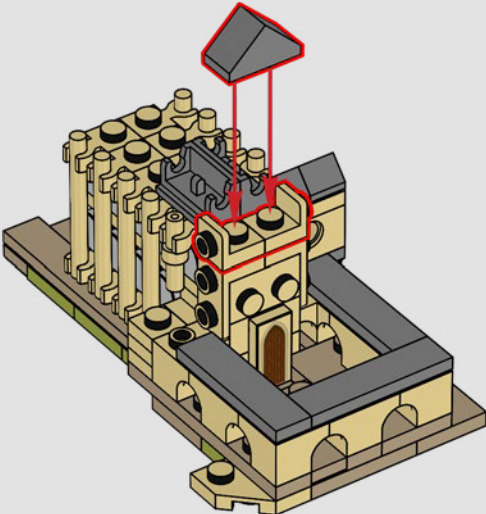

341

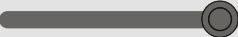
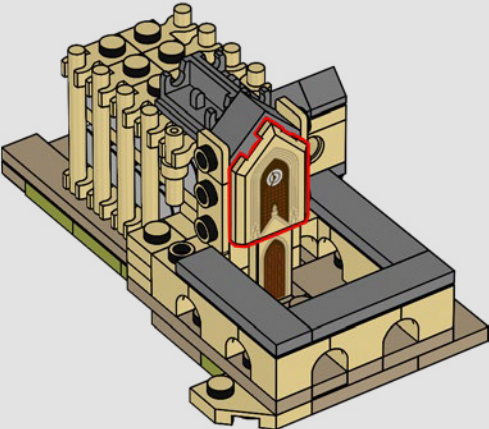

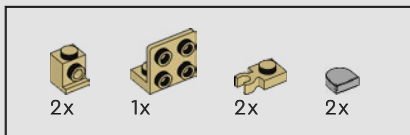

342

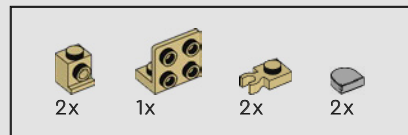
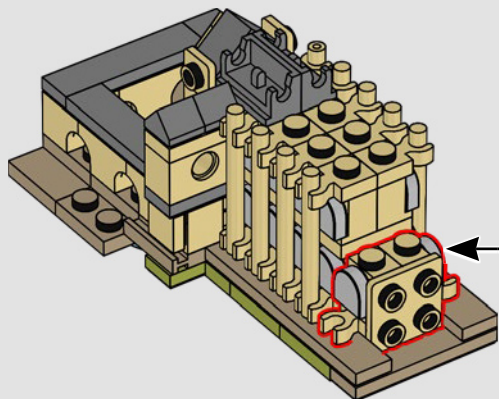
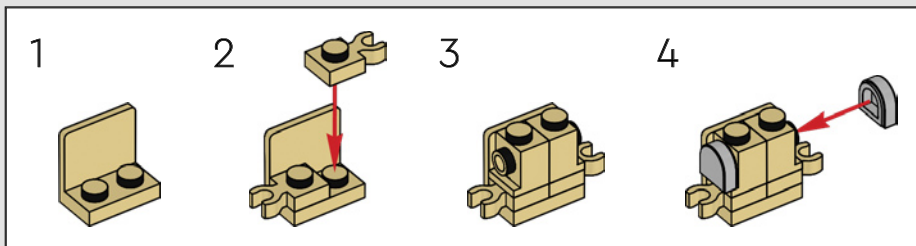

343

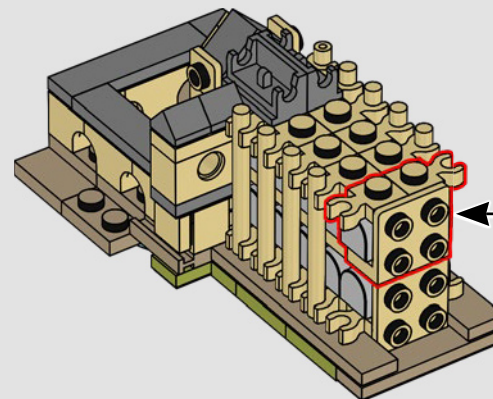
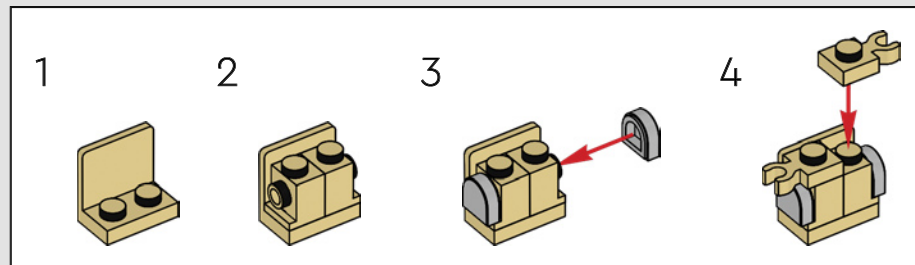

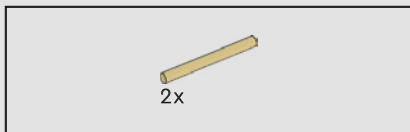

344

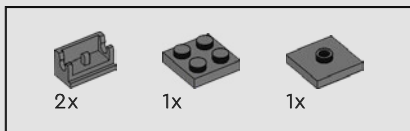
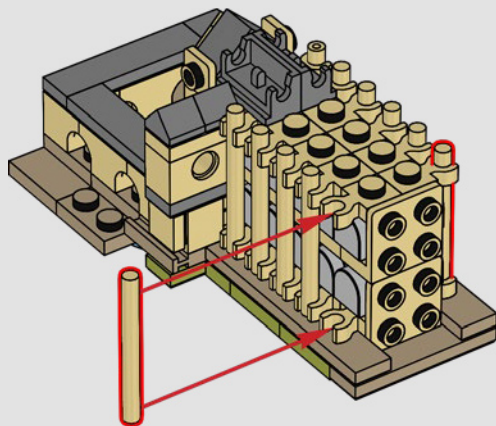

345

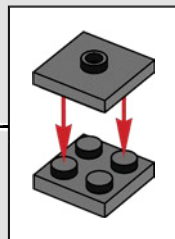
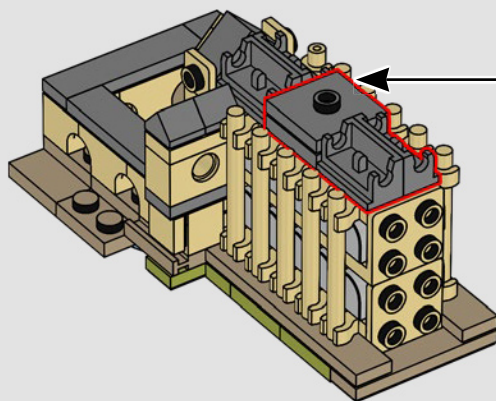

346

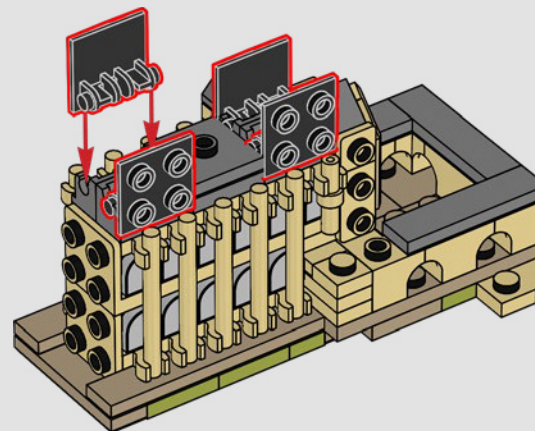

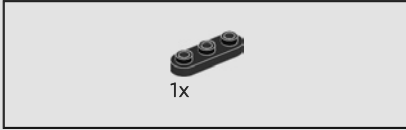
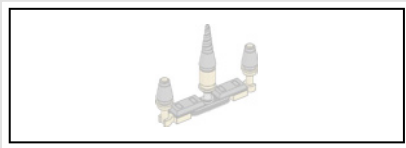

1x

347

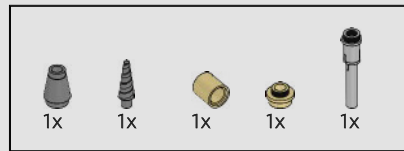

348

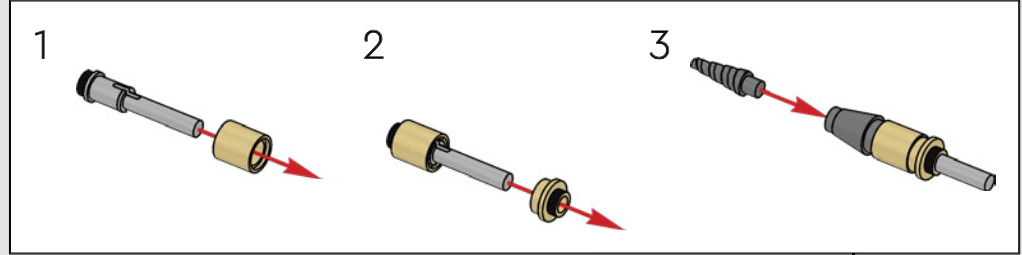



349

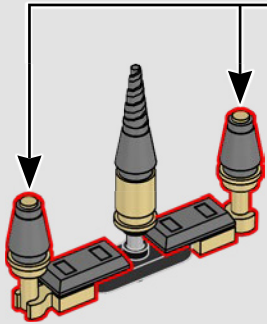
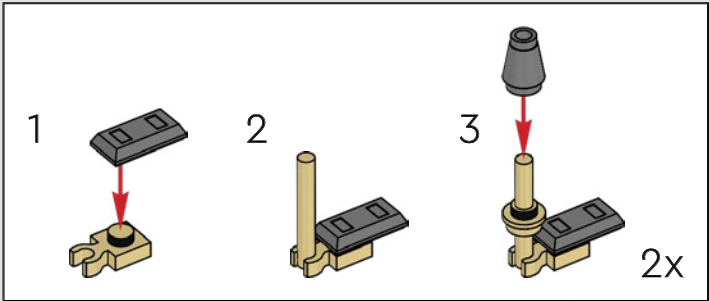

350

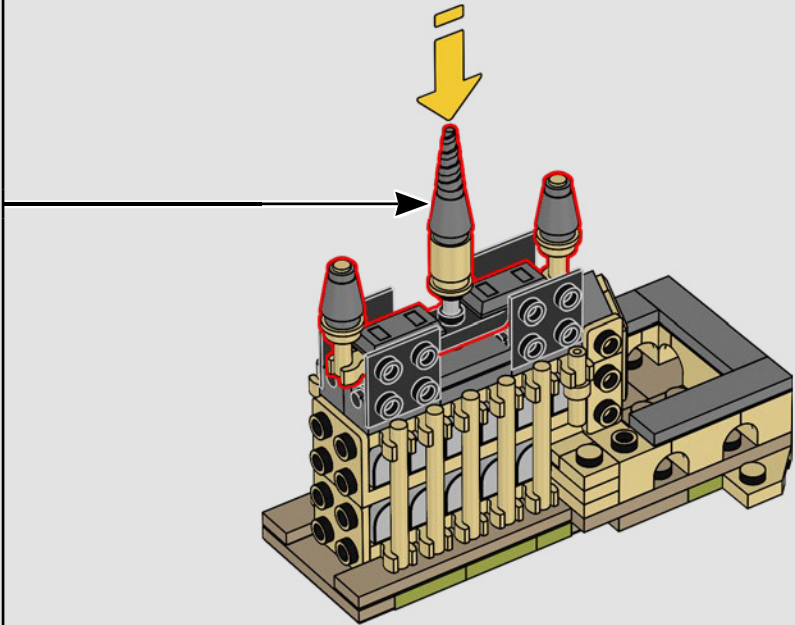



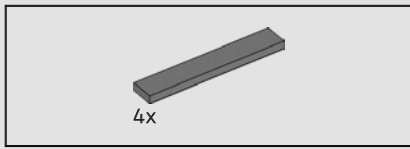

351

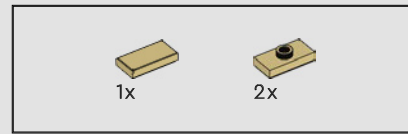
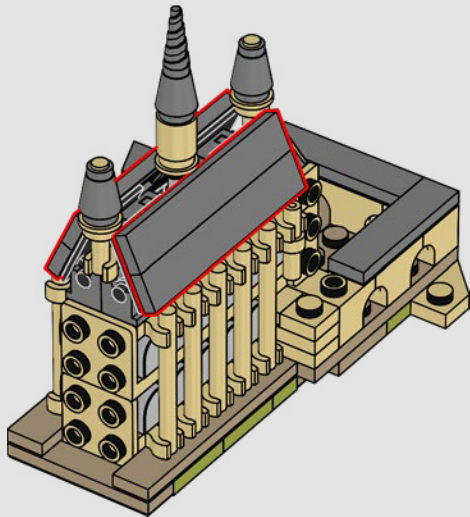

352

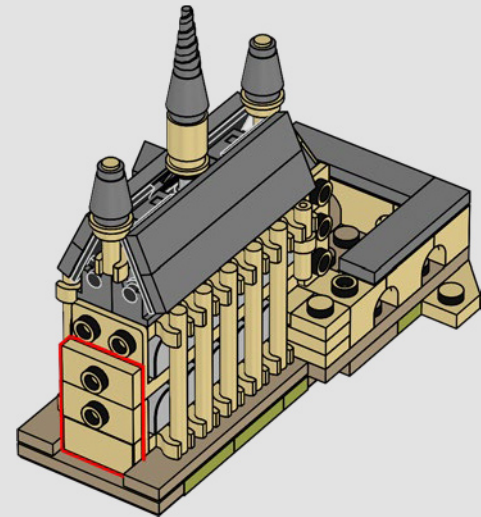

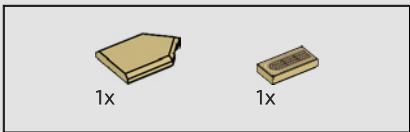

353

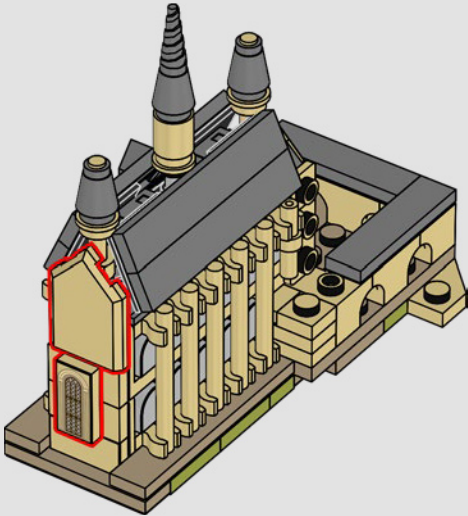

El techo del Gran Comedor se puede encantar para que parezca un cielo nocturno.





354

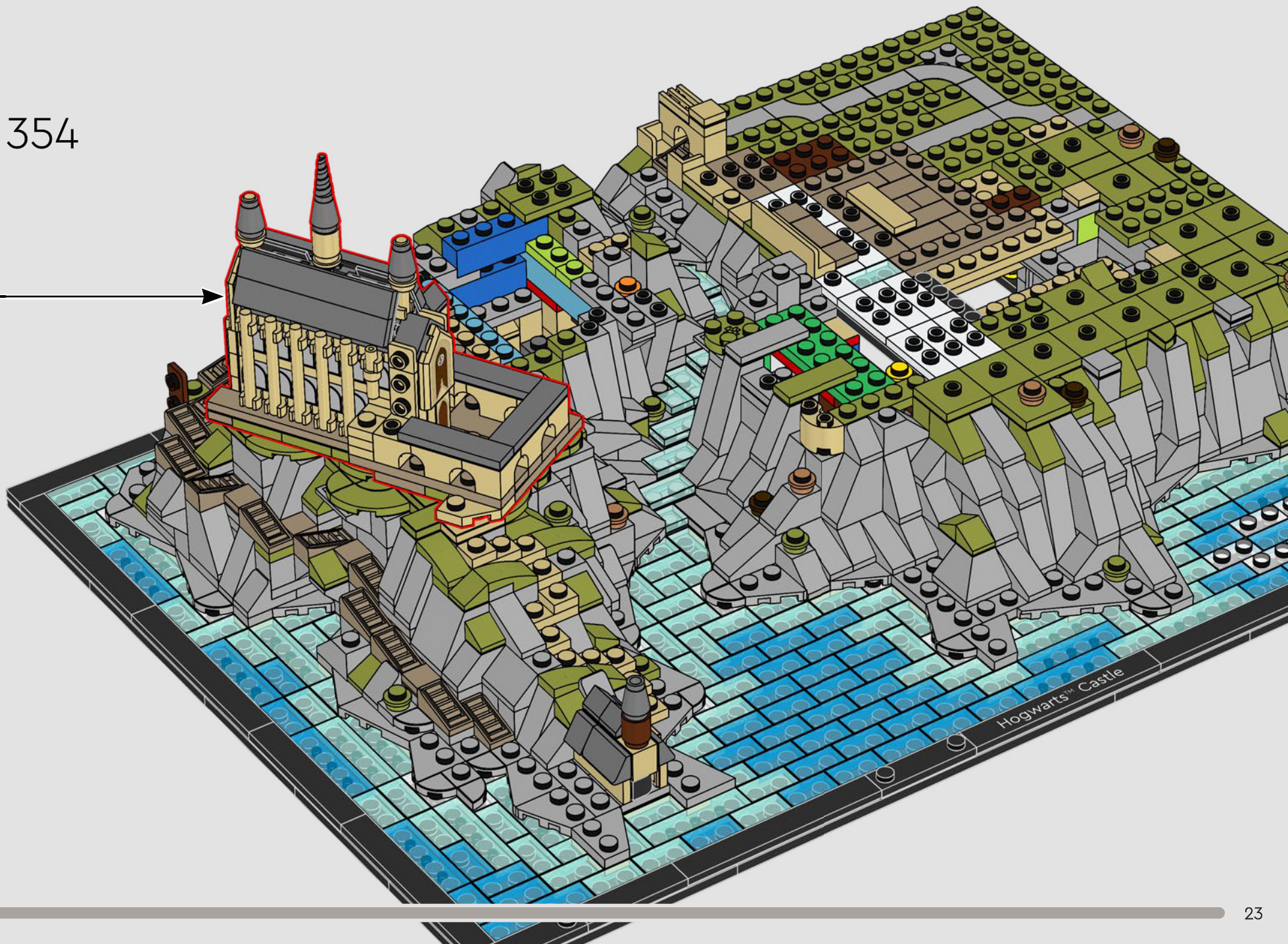



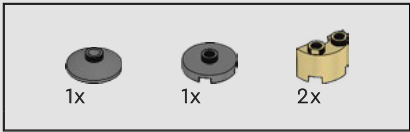

355

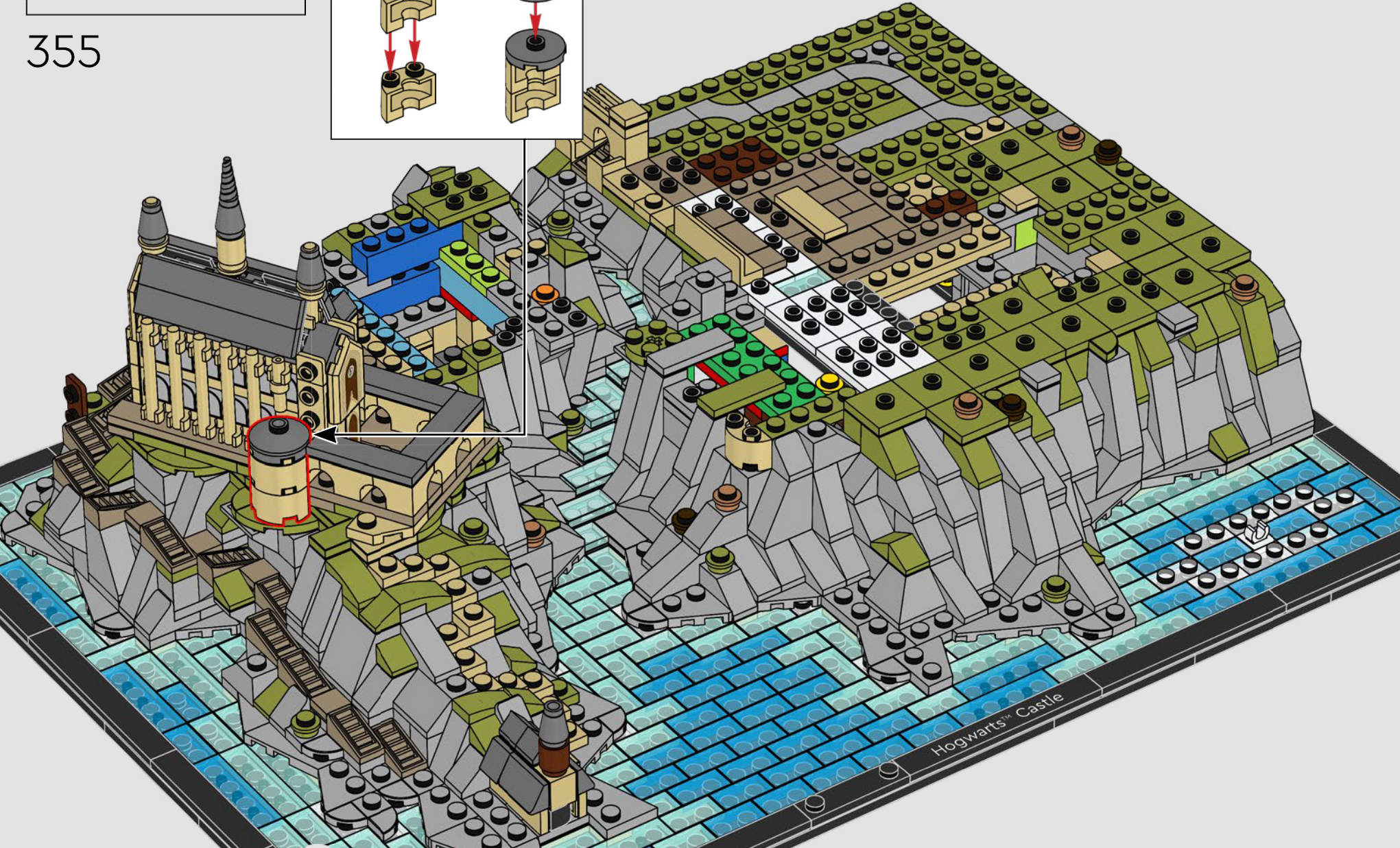
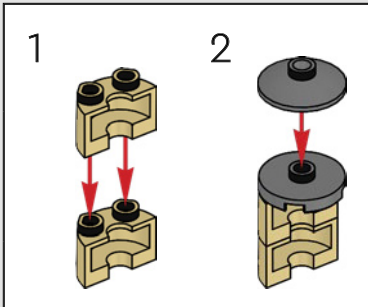



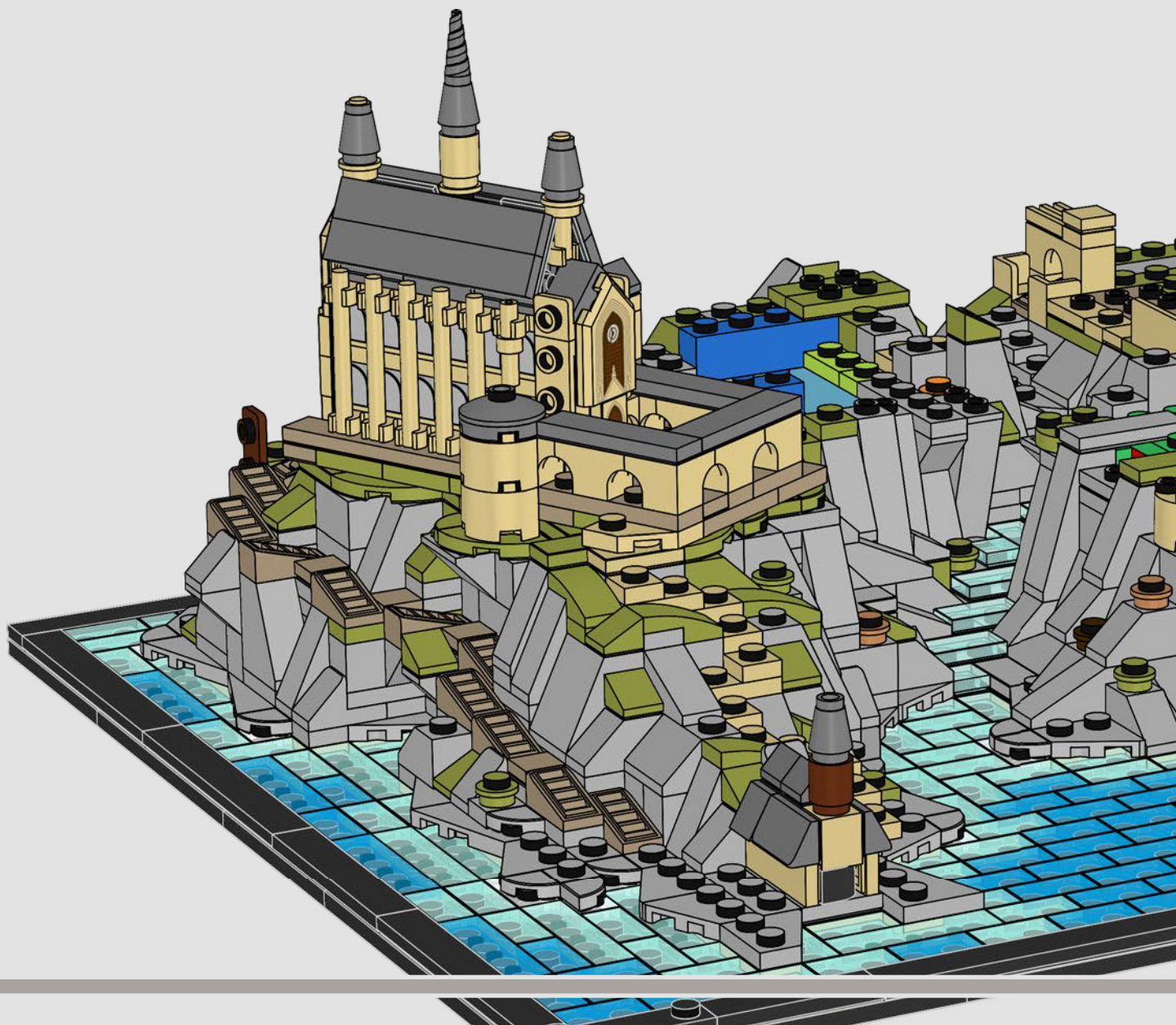

Inmediatamente después de llegar a Hogwarts™, los alumnos de primer año son conducidos al Gran Comedor, donde el Sombrero Seleccionador determina qué casa será su hogar.





356



Los árboles están  
construidos con  
elementos LEGO® que  
representan cristales  
y helado (y un poco  
de magia).





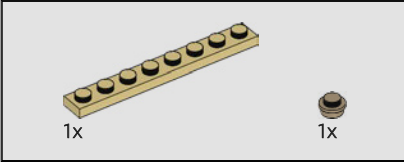
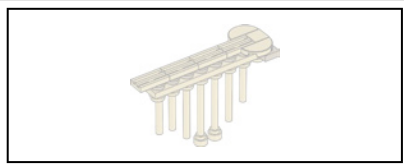

357

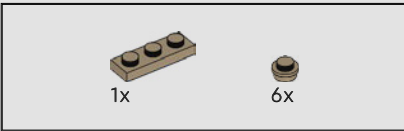
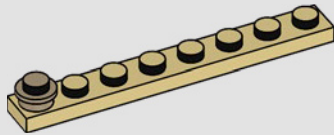

358

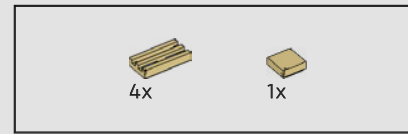
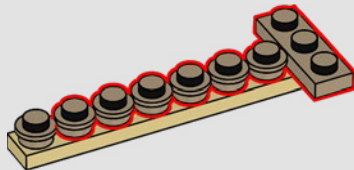

359

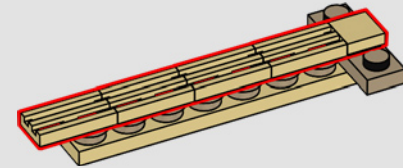

360

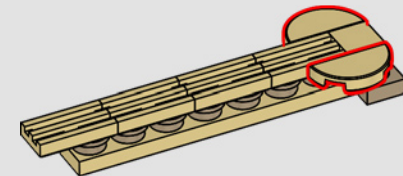

8x

361

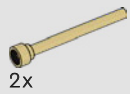
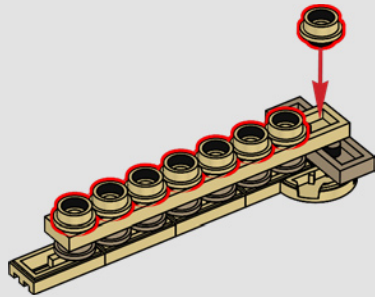

2x

362

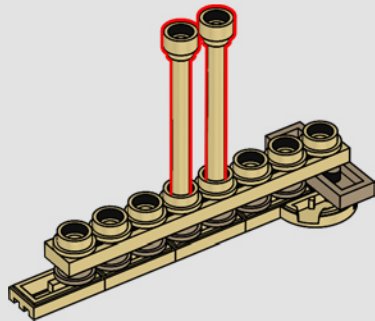

2x

3x

363

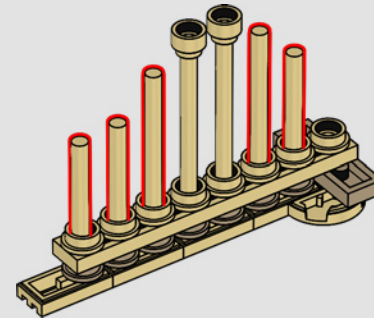

364





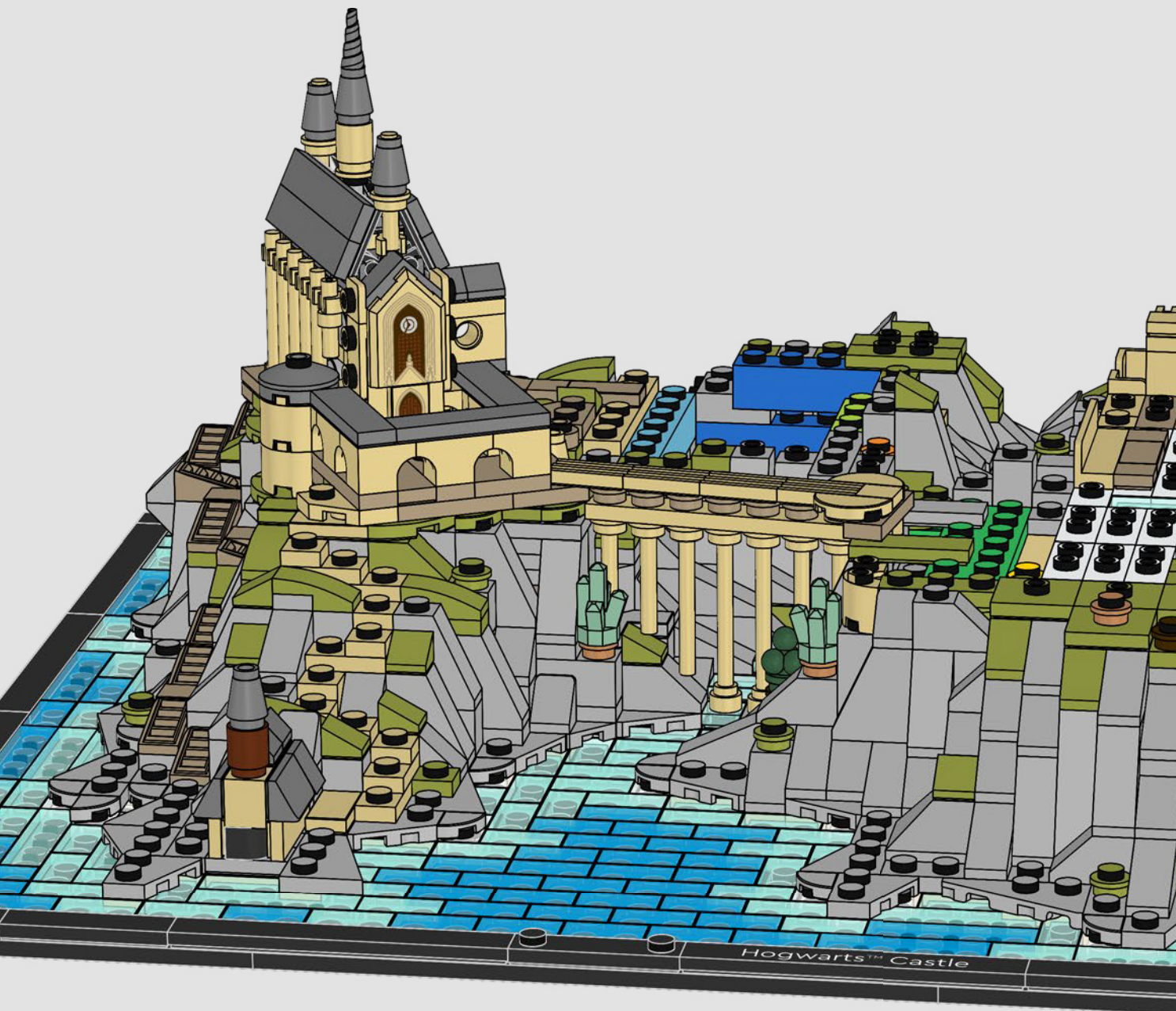

El puente del viaducto no solo constituye un elemento característico de la silueta de Hogwarts™, sino que es también el escenario de algunos momentos clave de la batalla que tiene lugar en el castillo: cuando la Profesora McGonagall lanza el hechizo a las armaduras, les pide que cumplan su deber para con la escuela y protejan a quienes están dentro mientras emprenden el camino hacia el puente. También cobra especial protagonismo durante la primera prueba del Torneo de los Tres Magos, cuando el Colacuerno Húngaro pasa por debajo persiguiendo a Harry.





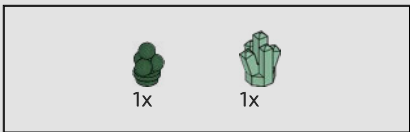

365







2x

366

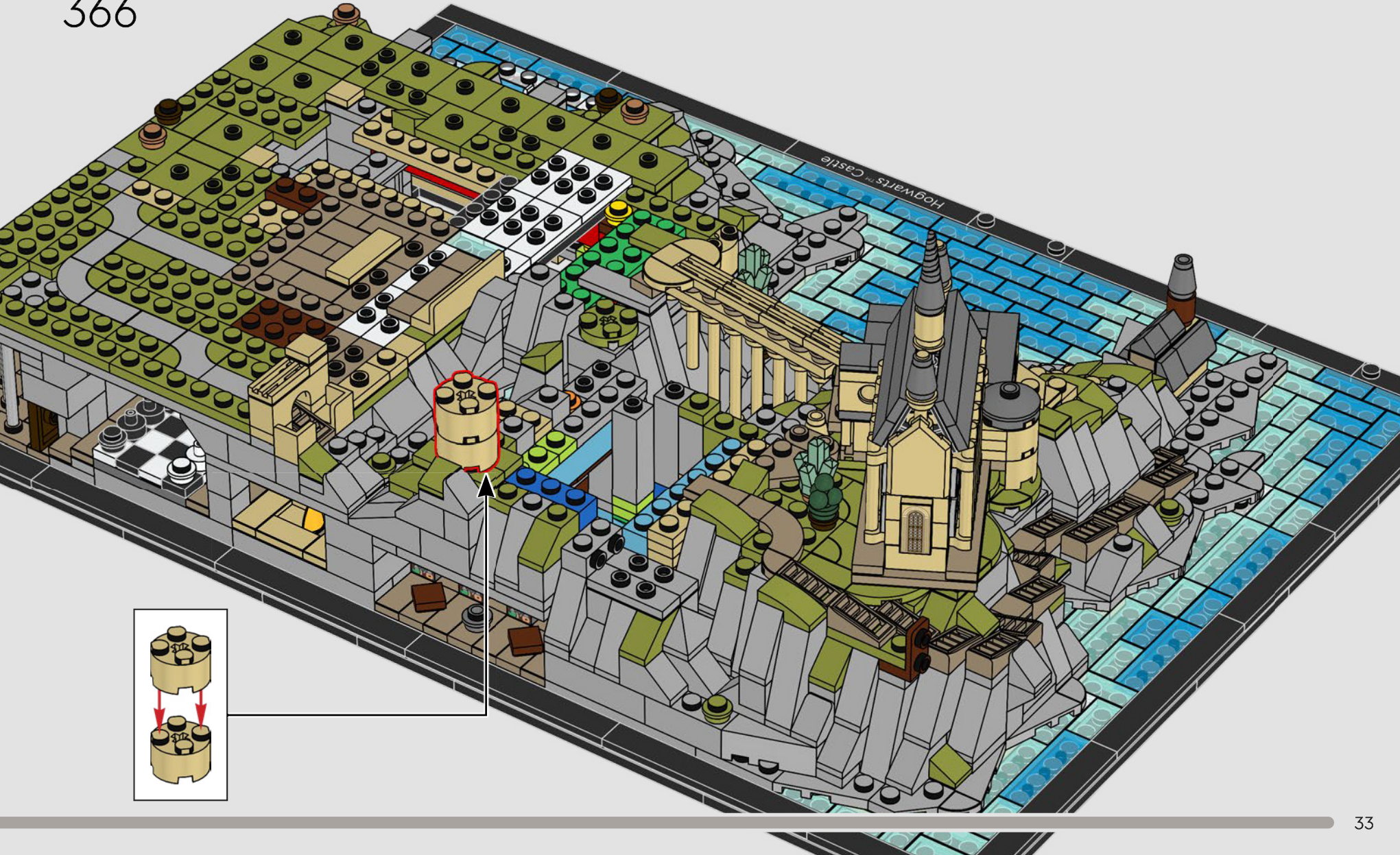



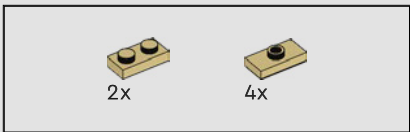

367

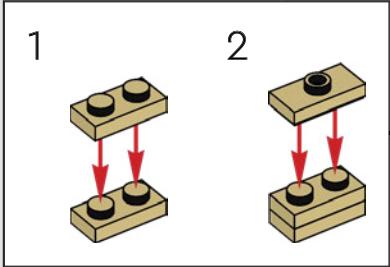
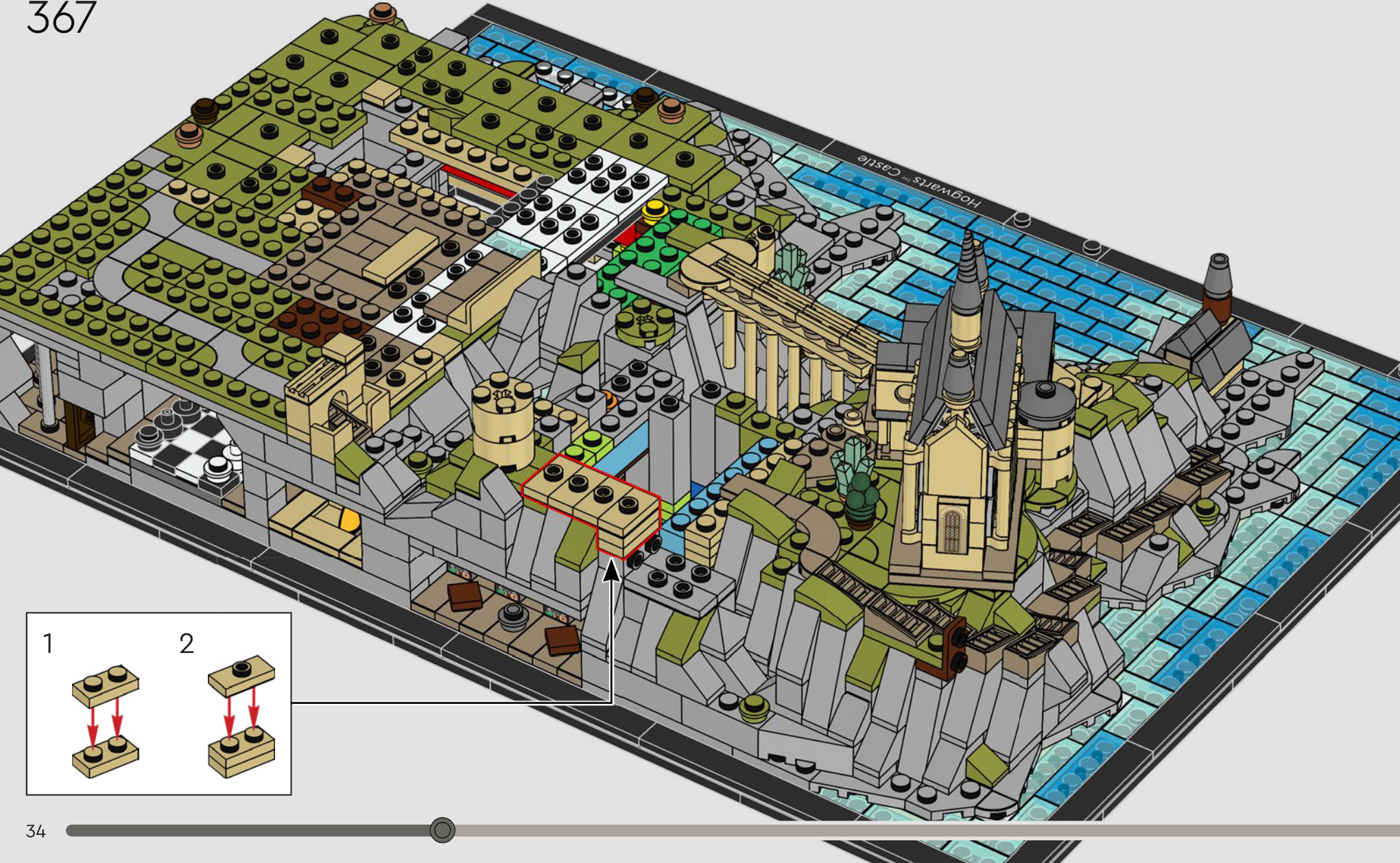



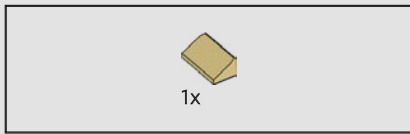

368

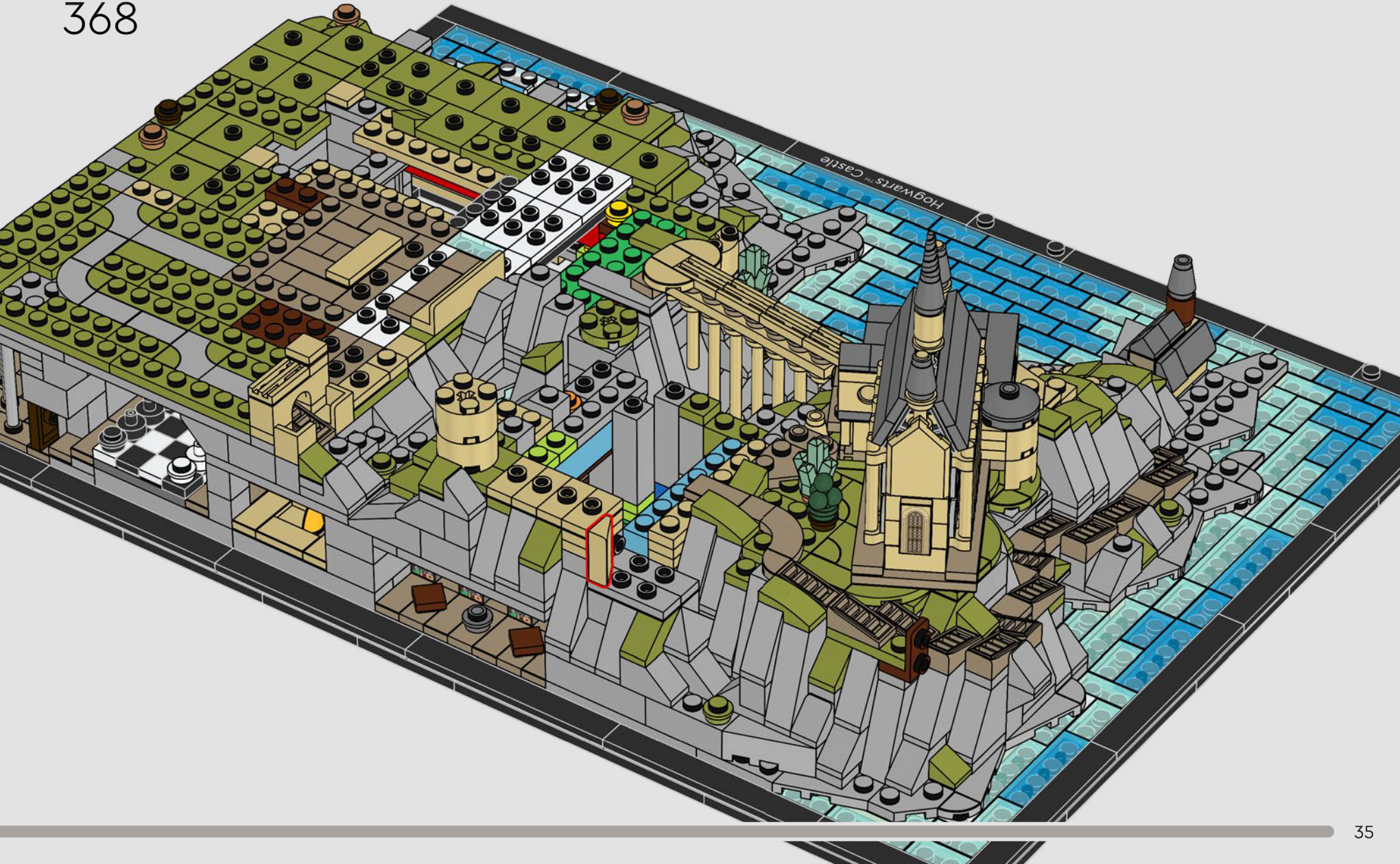

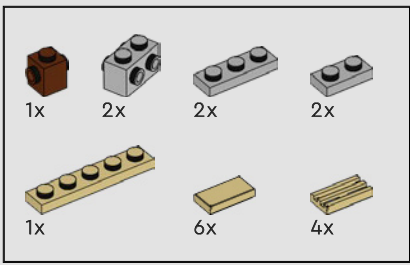

369

1

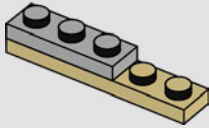

2

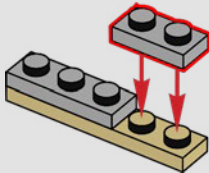

3

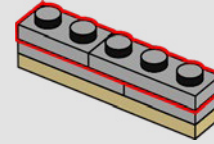

4

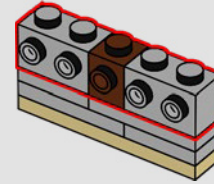

5

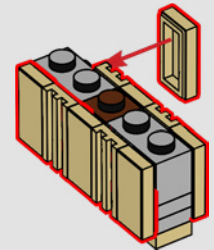



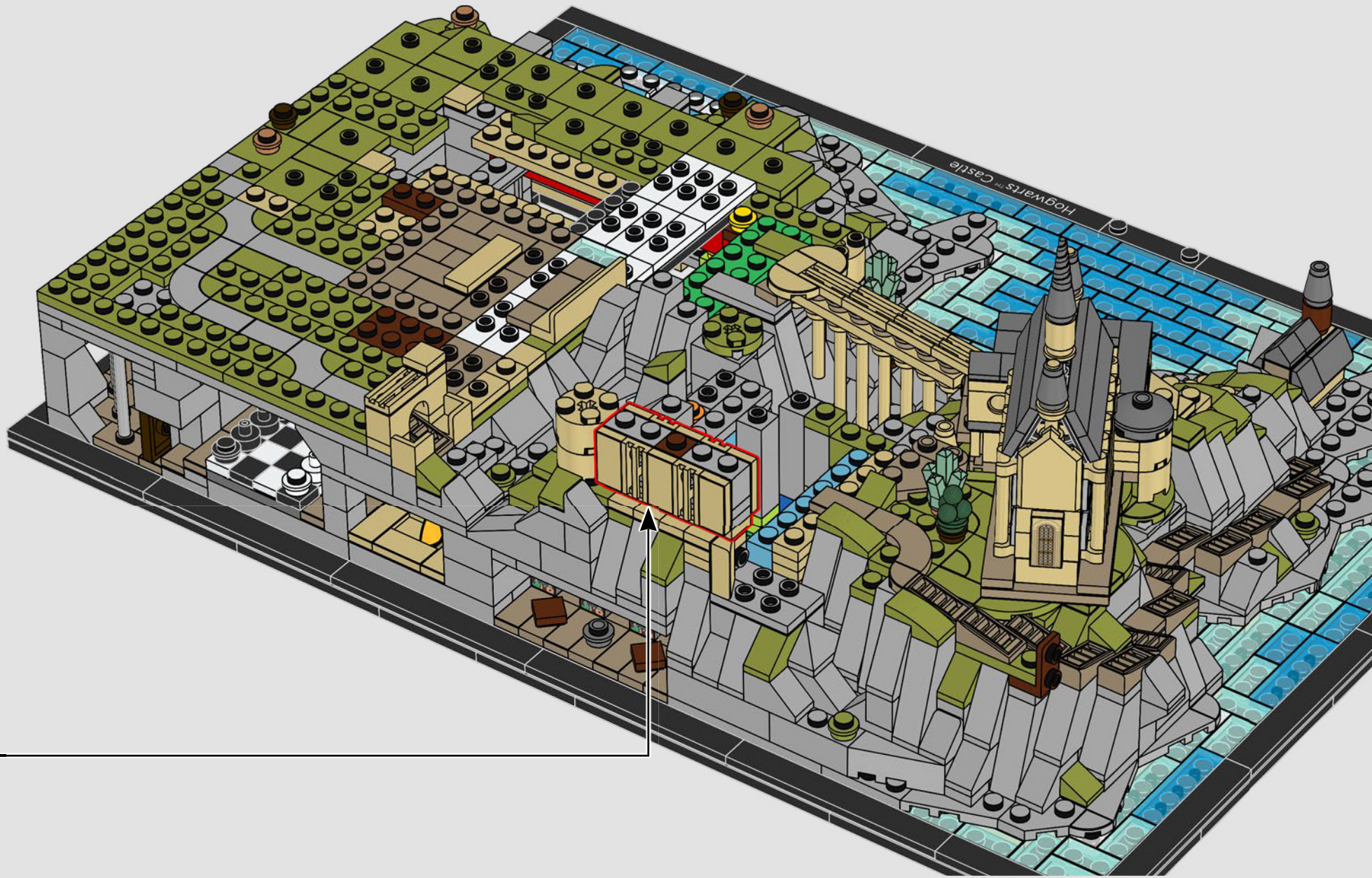



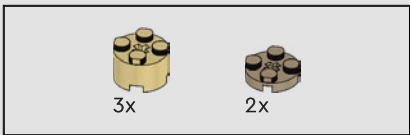

370

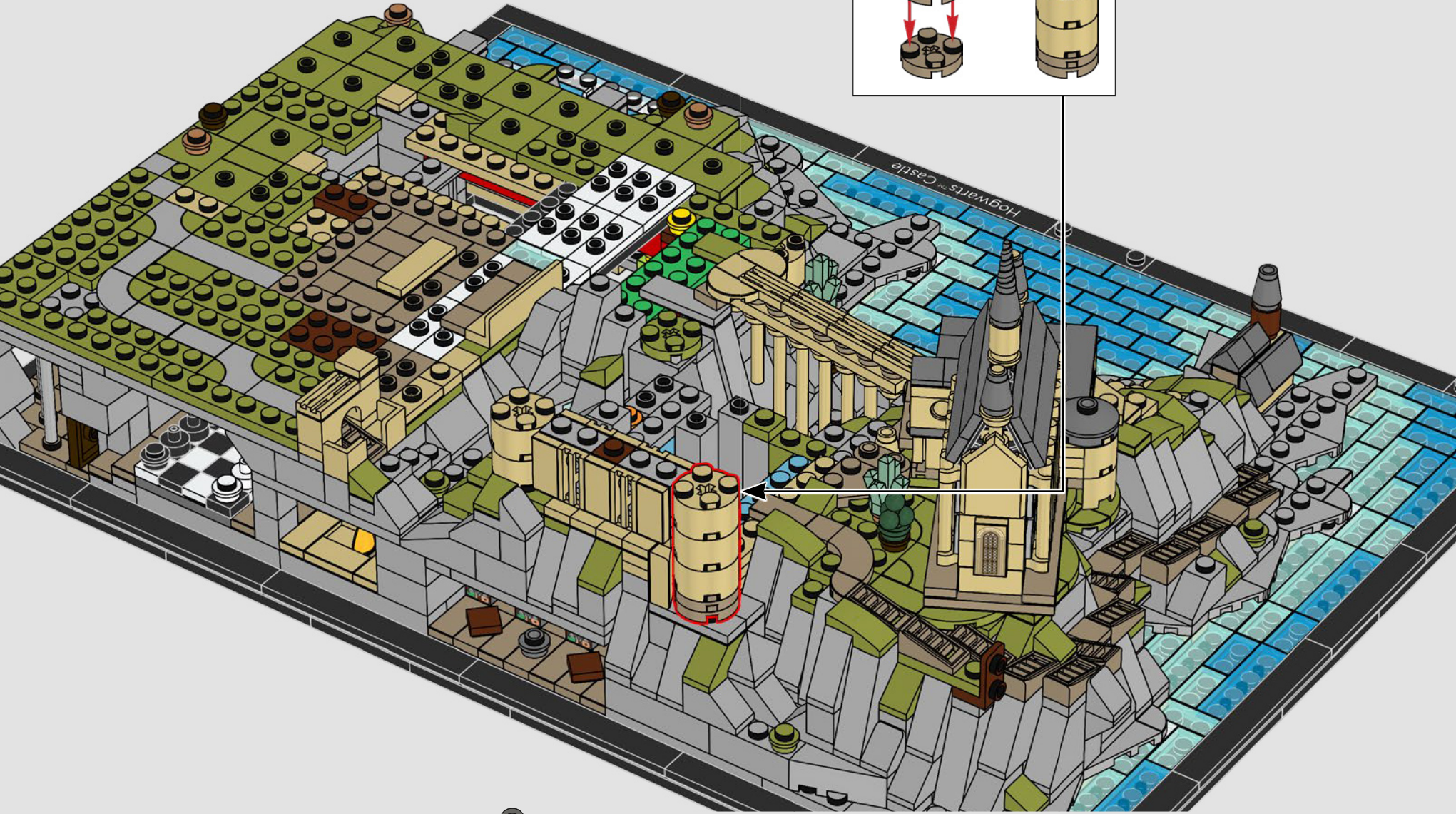
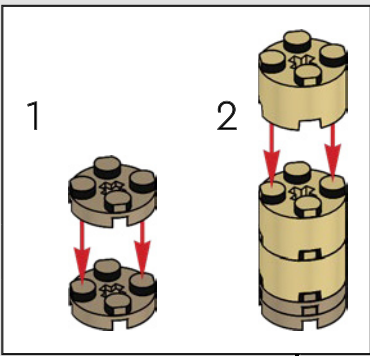



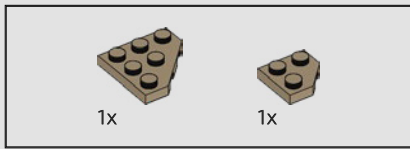

371

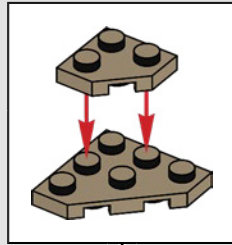

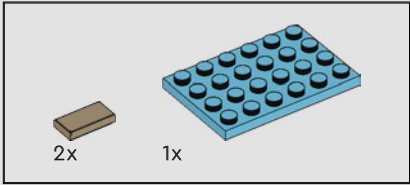
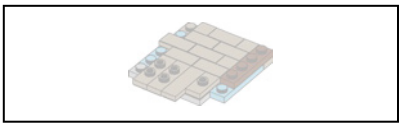

372

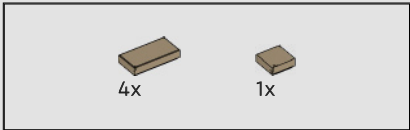
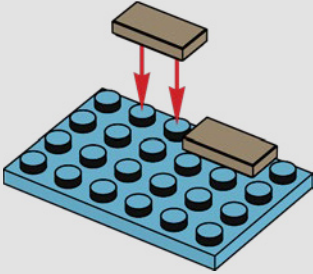

373

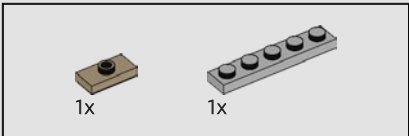
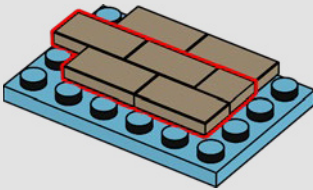

374

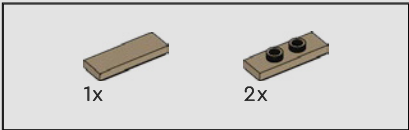
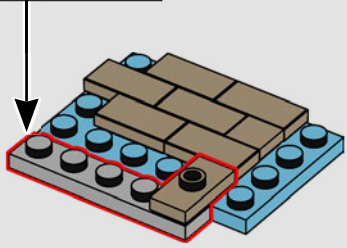
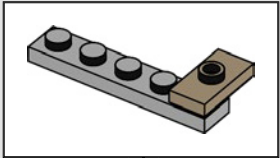

375

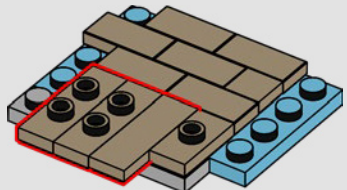

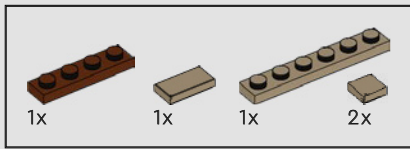

376

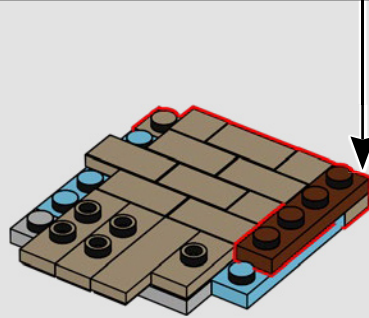
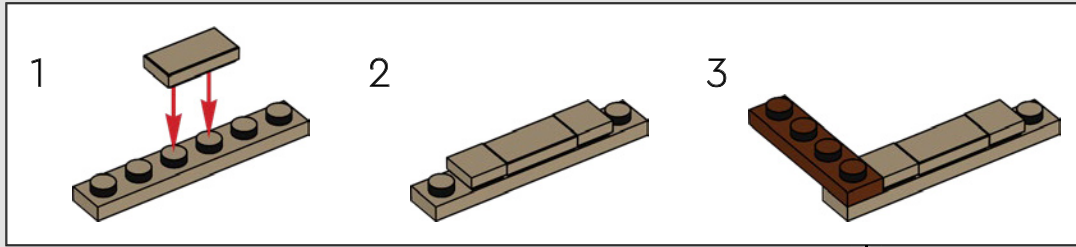



377



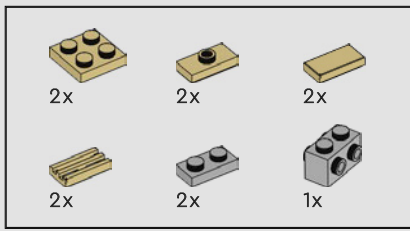

378

1

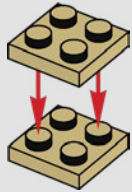

2

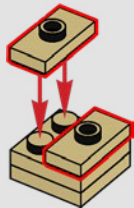

3

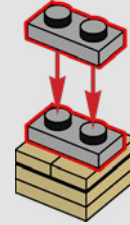

4

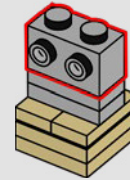

5

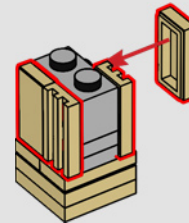





Hogwarts™ Castle



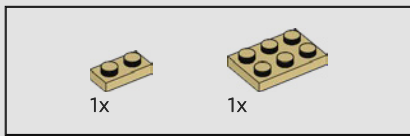

379

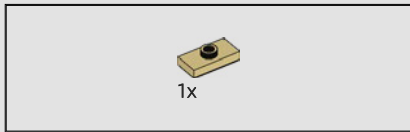
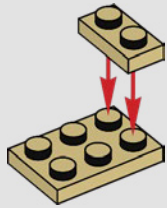

380

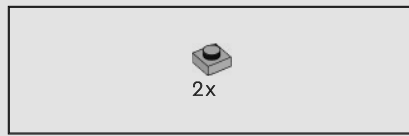
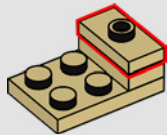

381

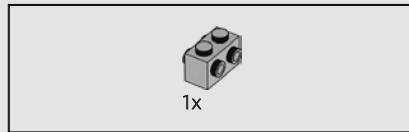
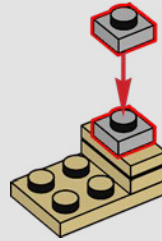

382

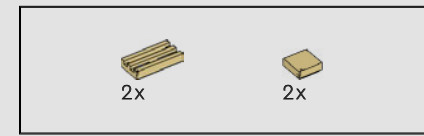
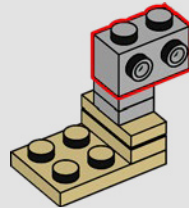

383

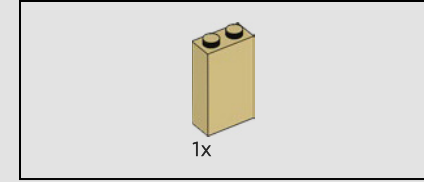
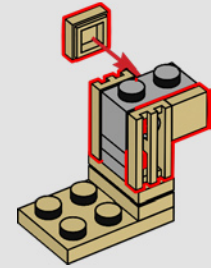

384

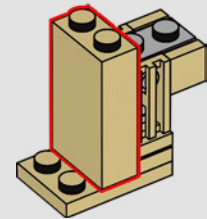

385

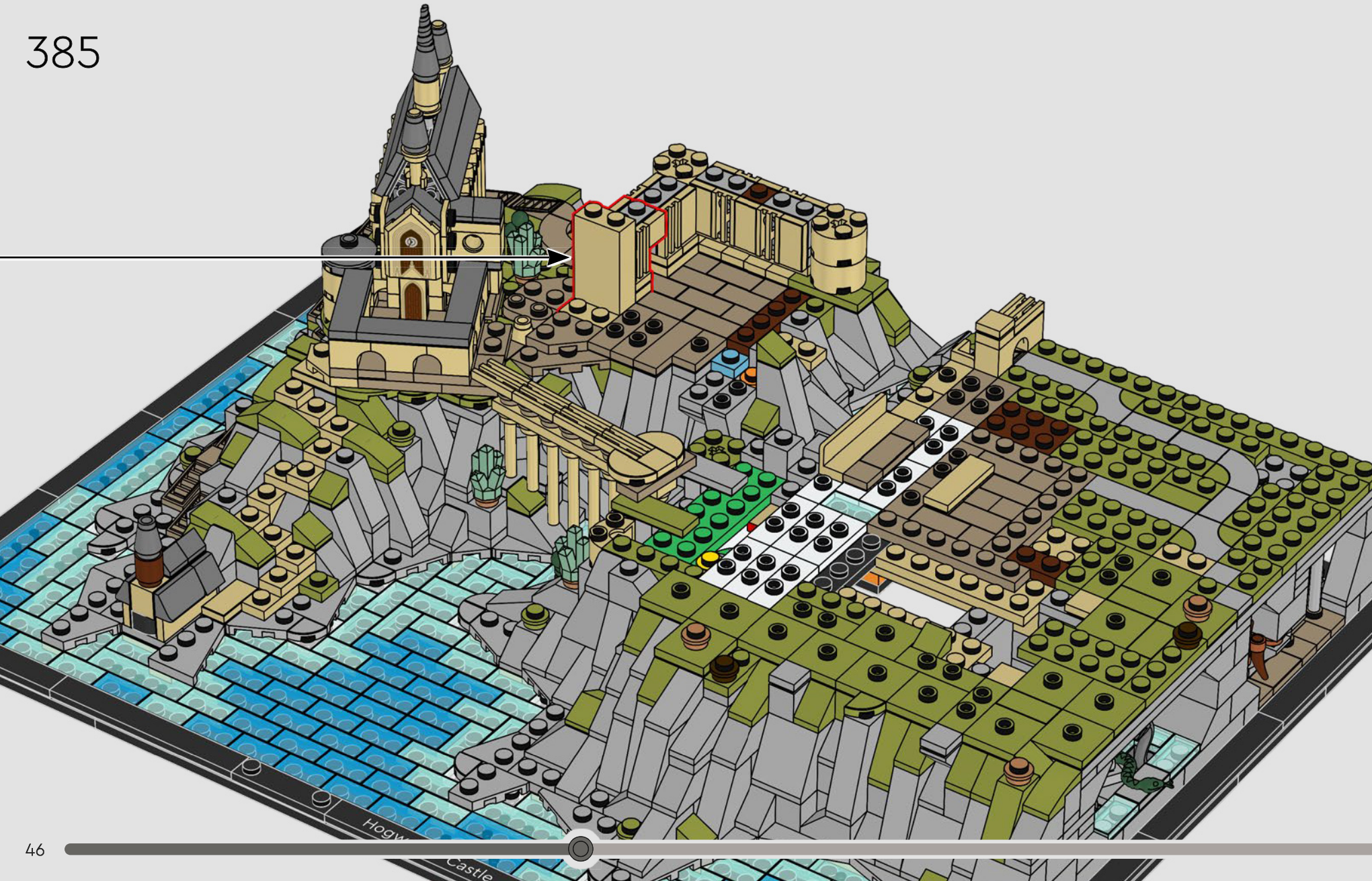



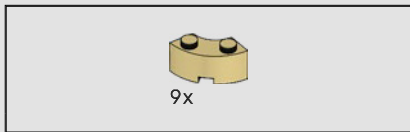

386

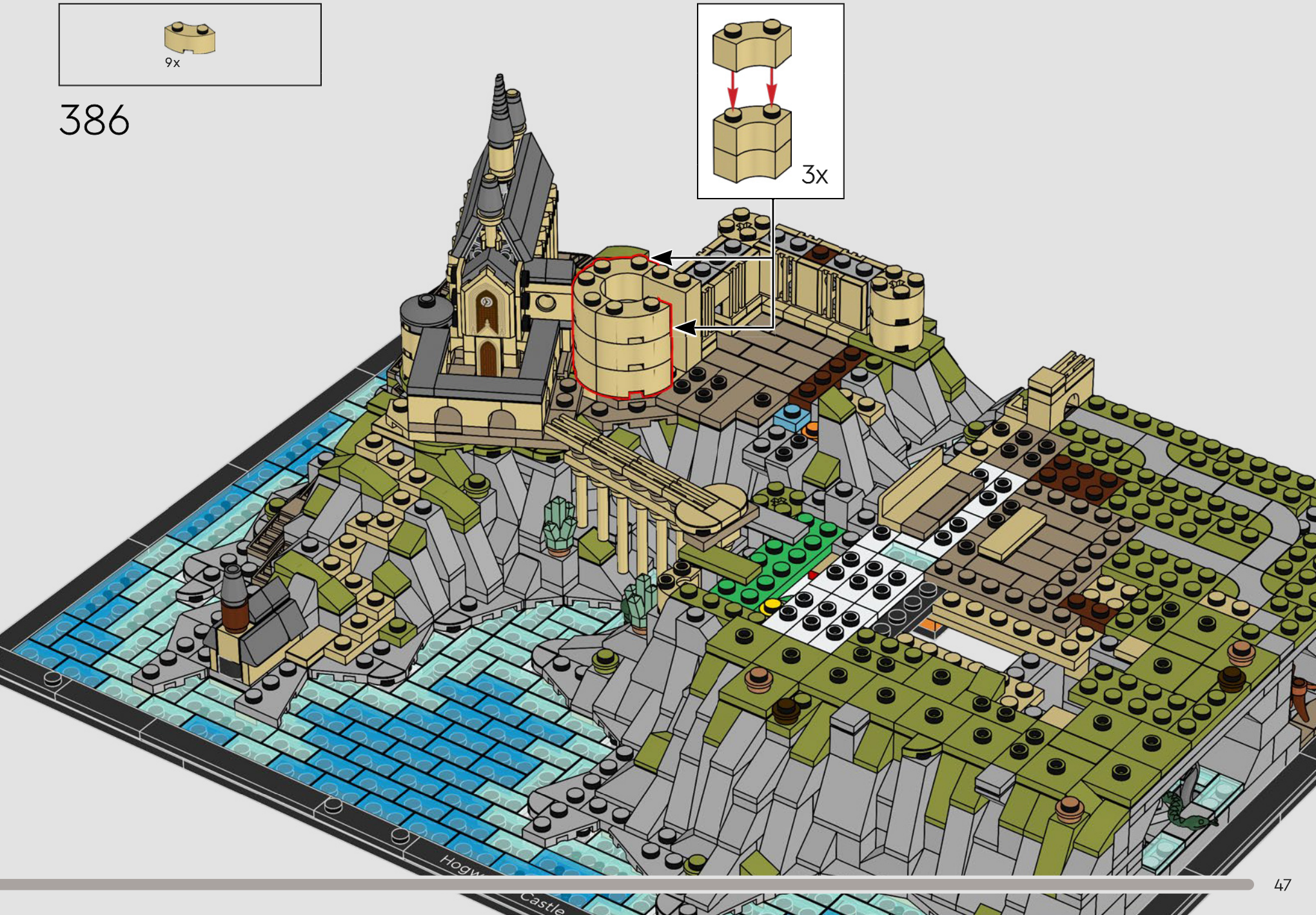
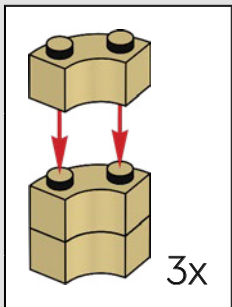



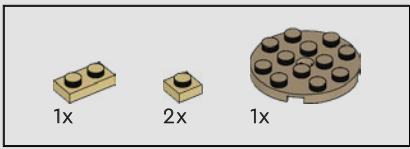

387

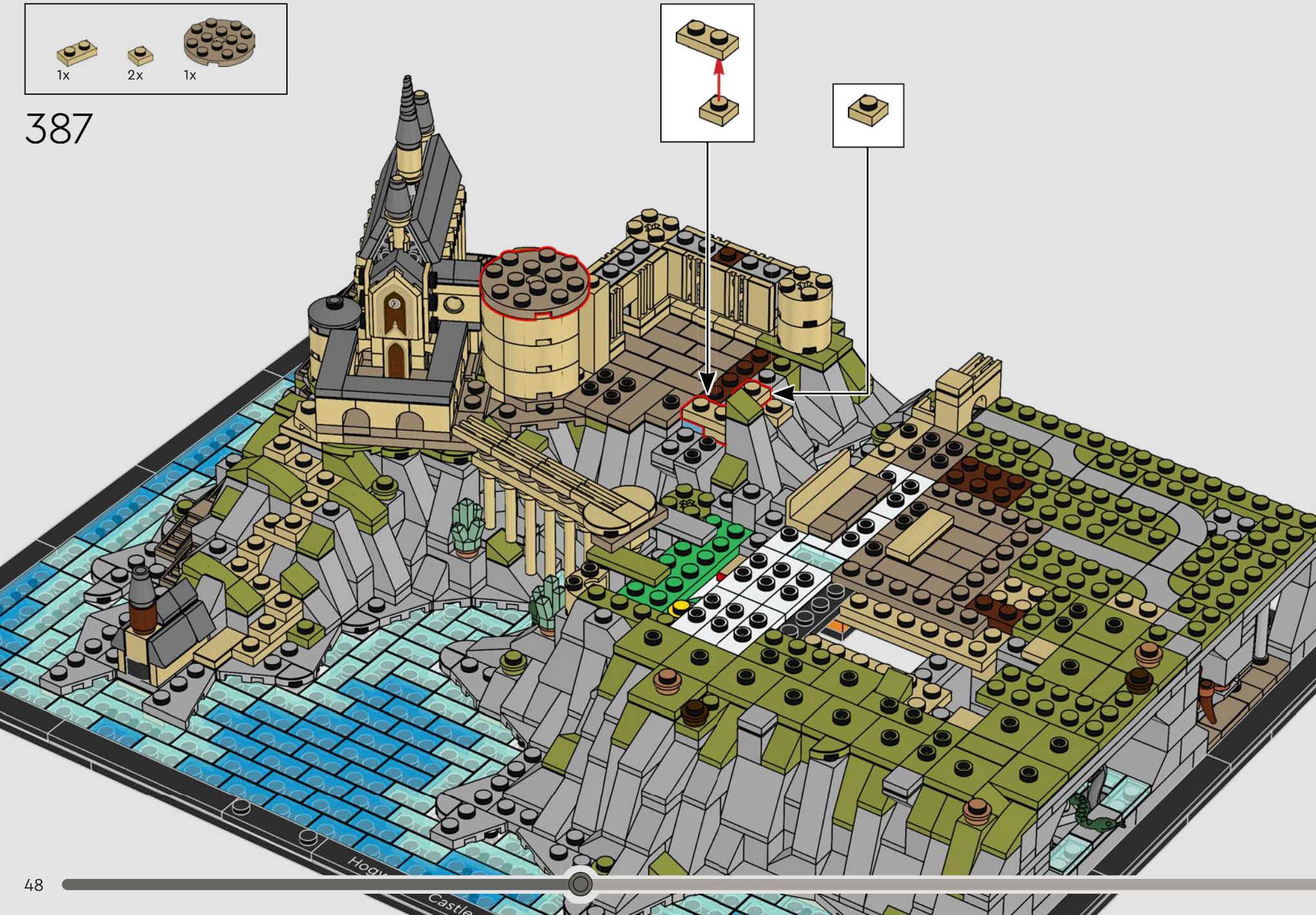
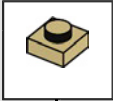
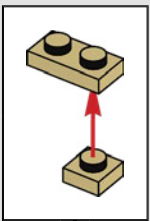



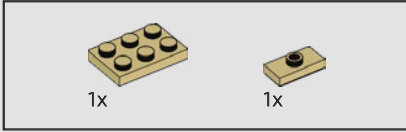
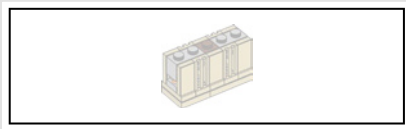

388

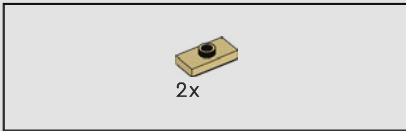
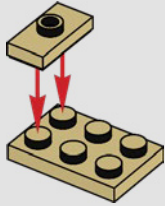

389

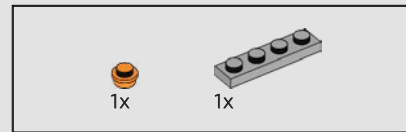
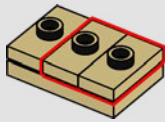

390

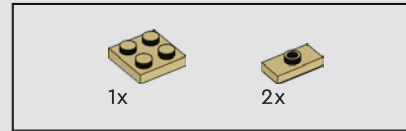
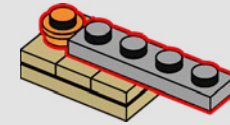

391

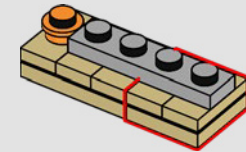
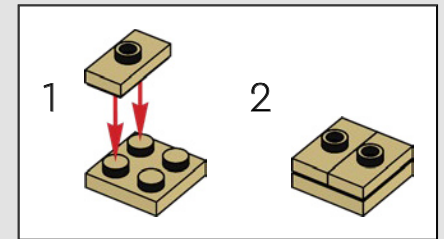

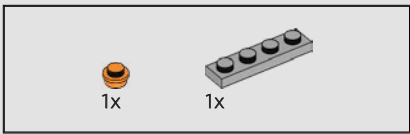

392

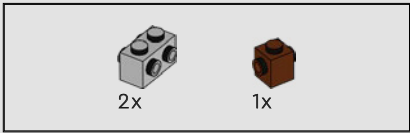
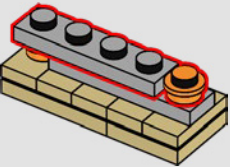

393

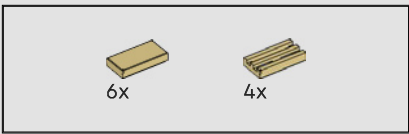
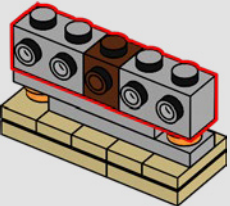

394

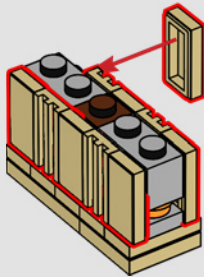

395

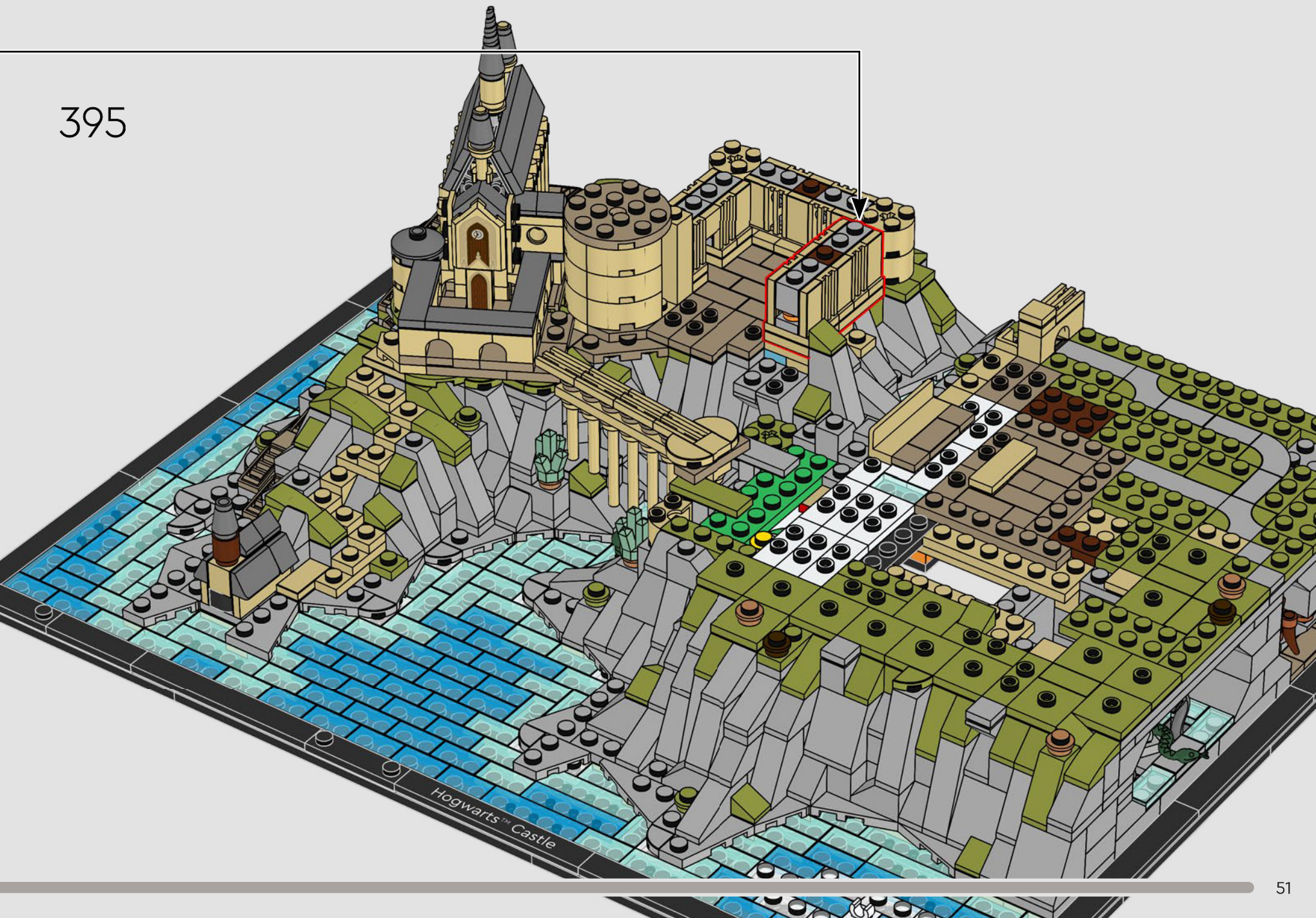

Hogwarts™ Castle



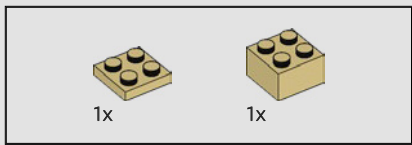

396

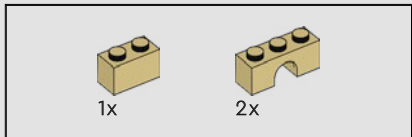
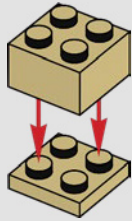

397

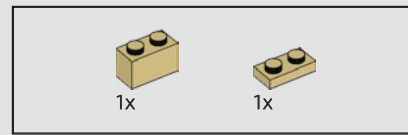
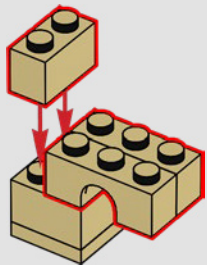

398

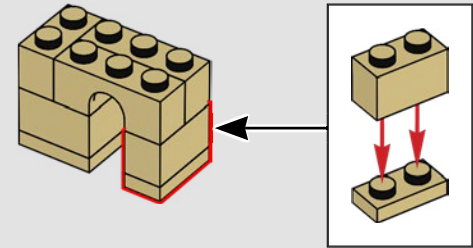

399

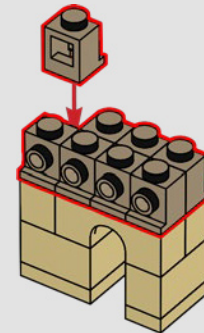

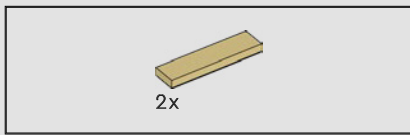

400

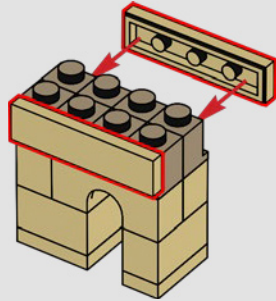

401

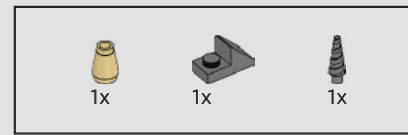
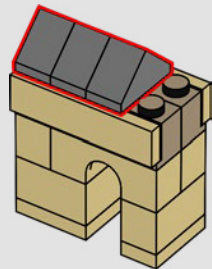

402

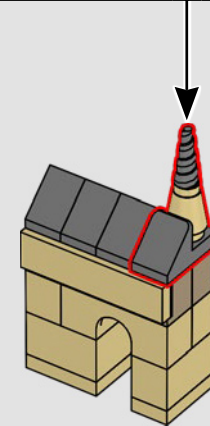
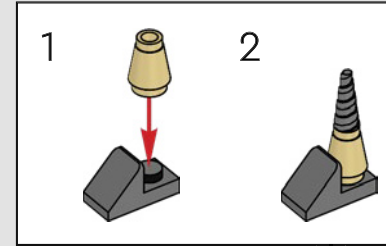

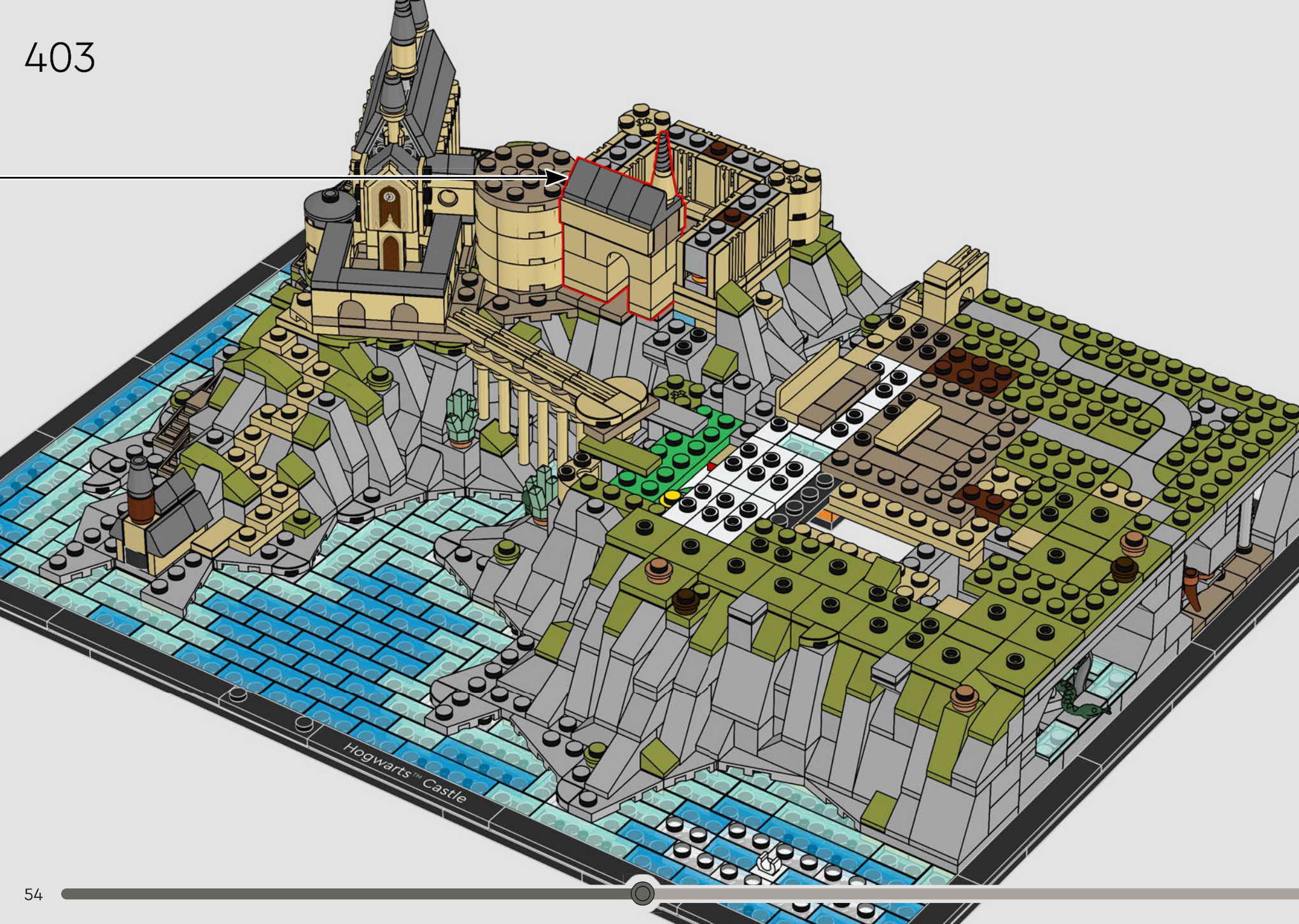



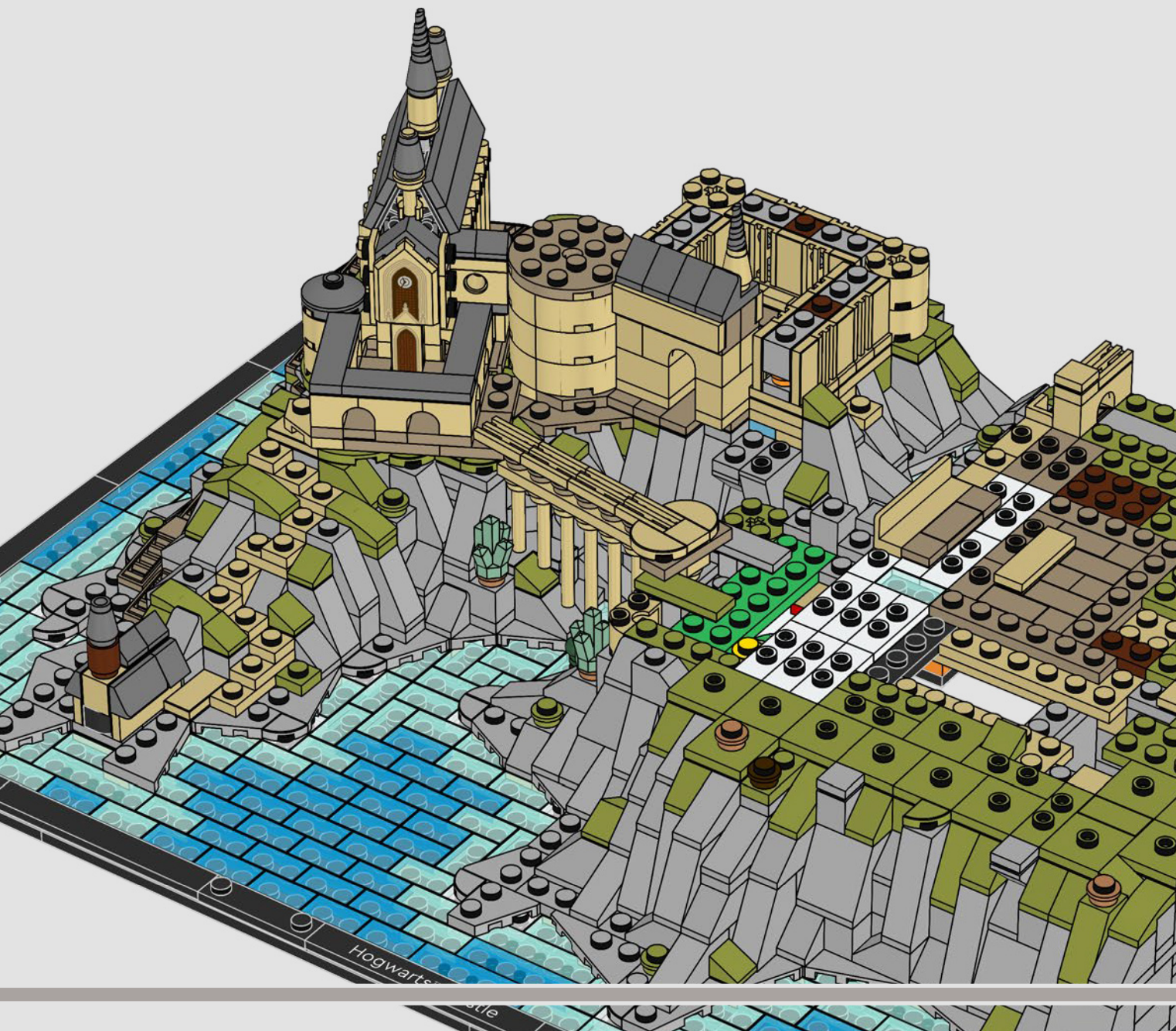

El patio empedrado es un espacio de reunión exterior para los alumnos, emplazado cerca de la Torre del Reloj.

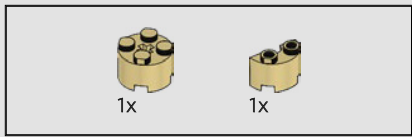

404

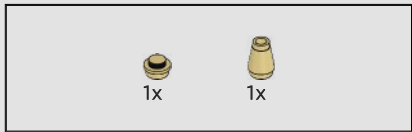
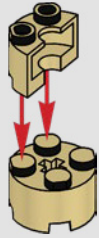

405

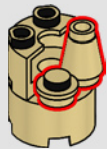

406

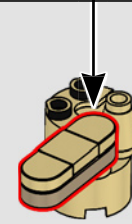
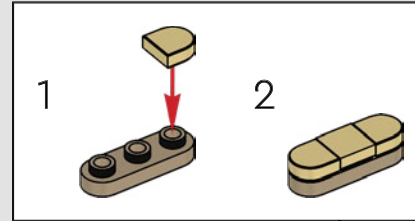

407

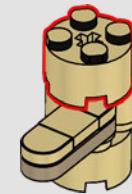



408

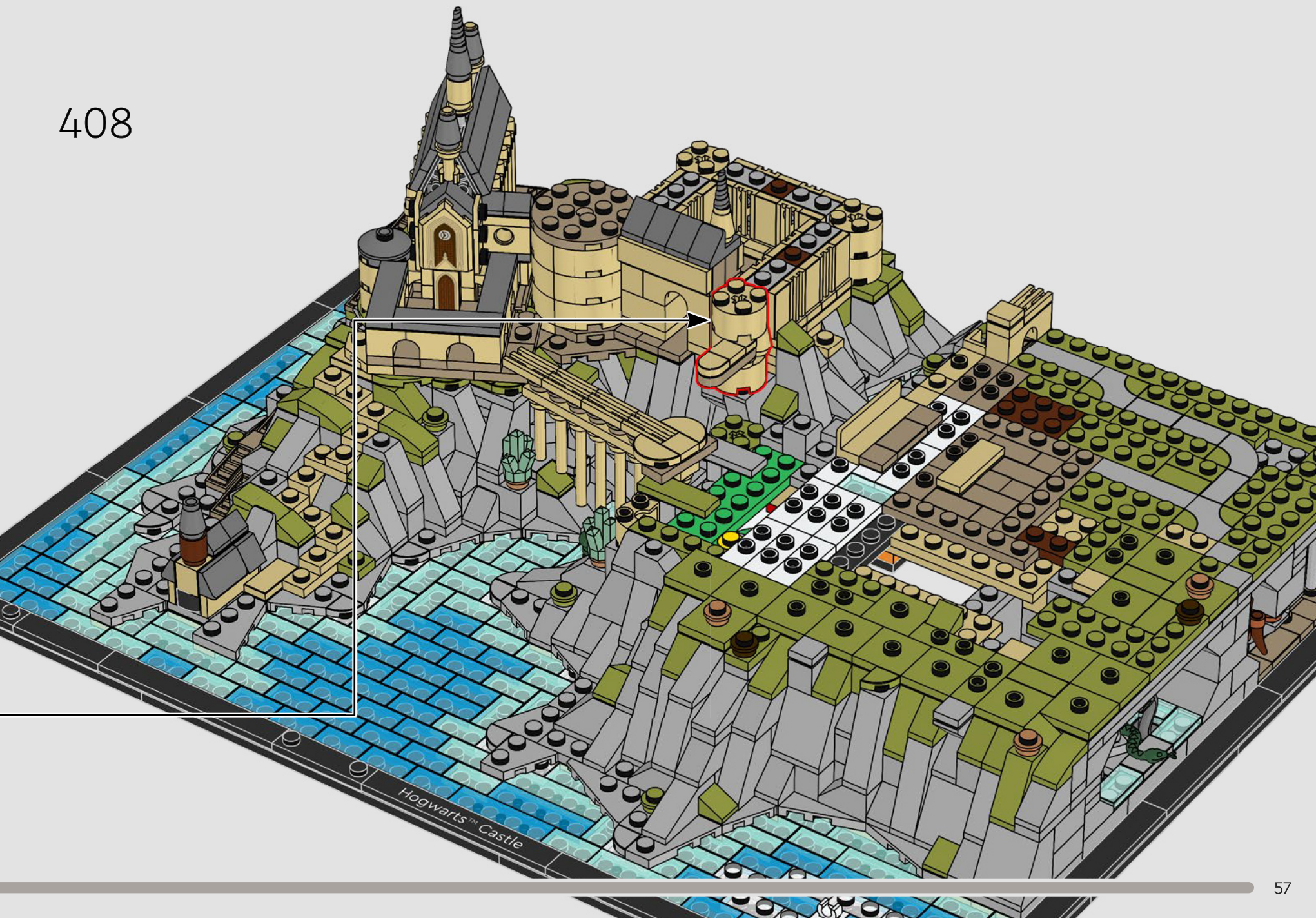







409





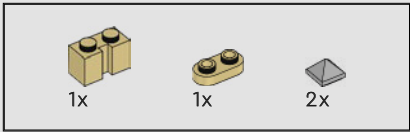

410

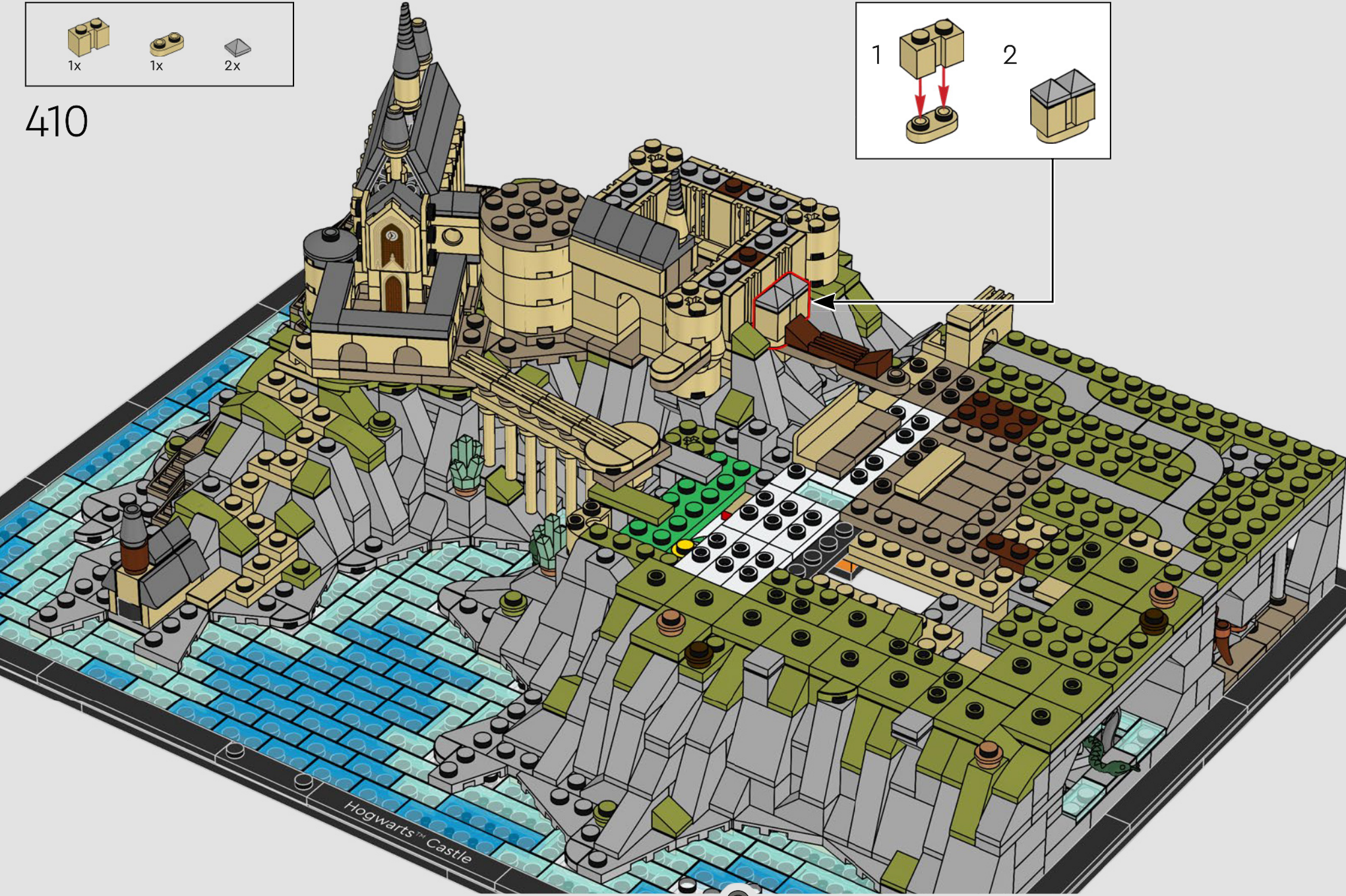
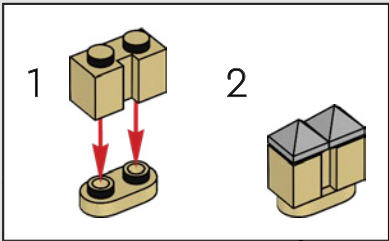



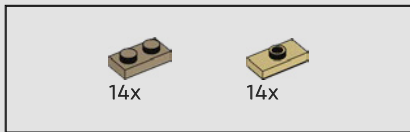

411

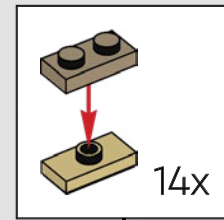



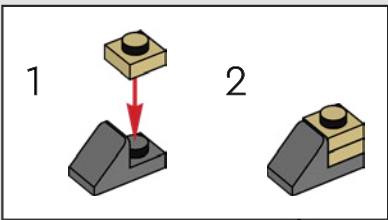
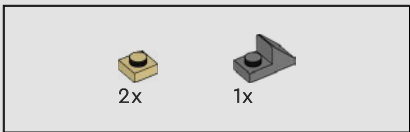

412

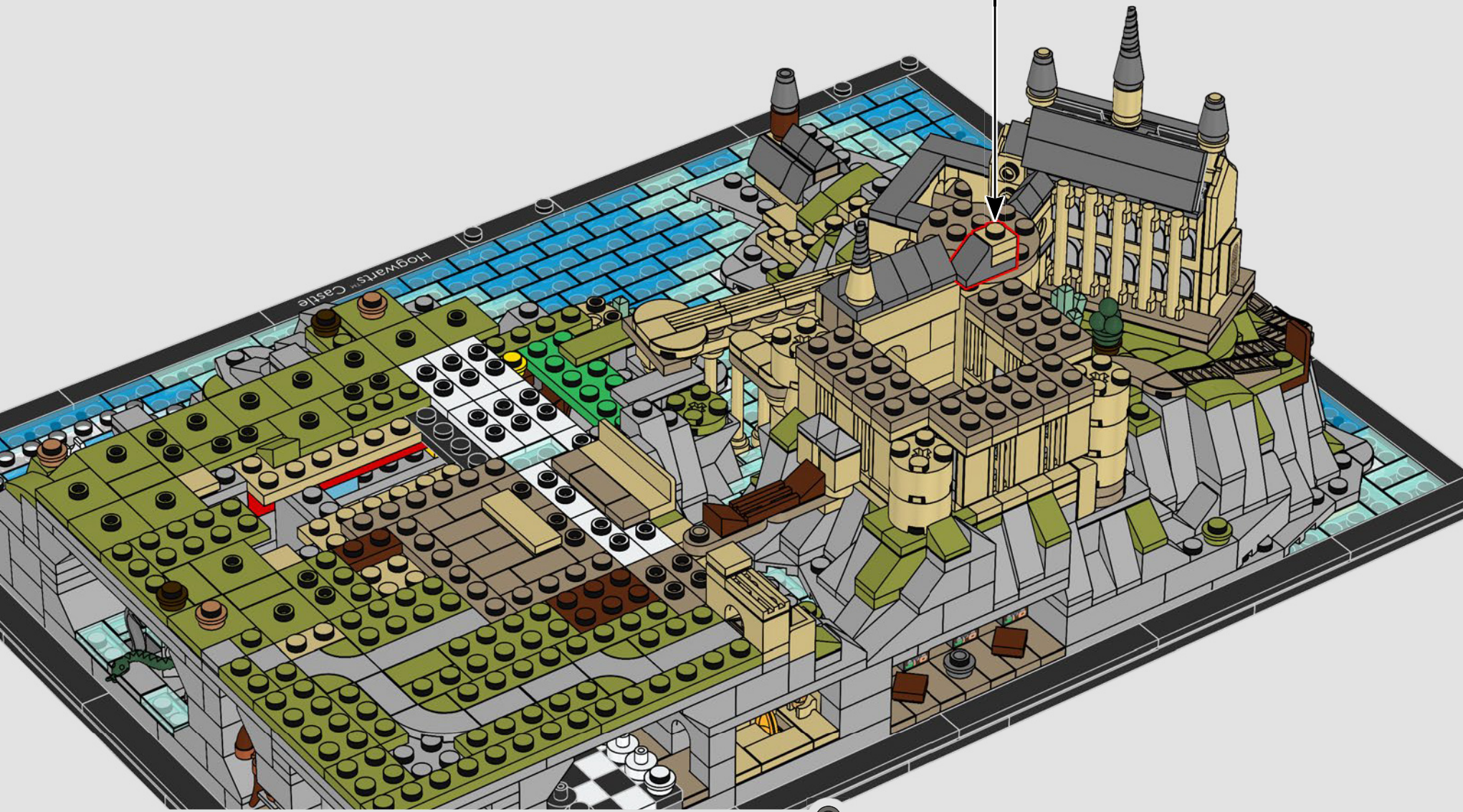



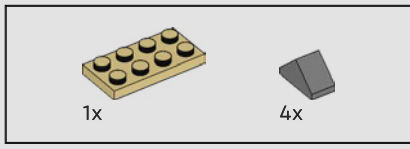

413

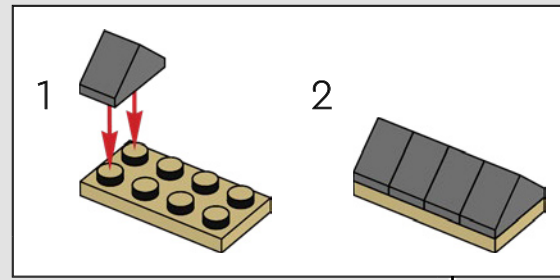



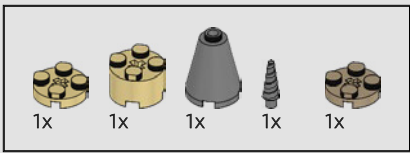

414

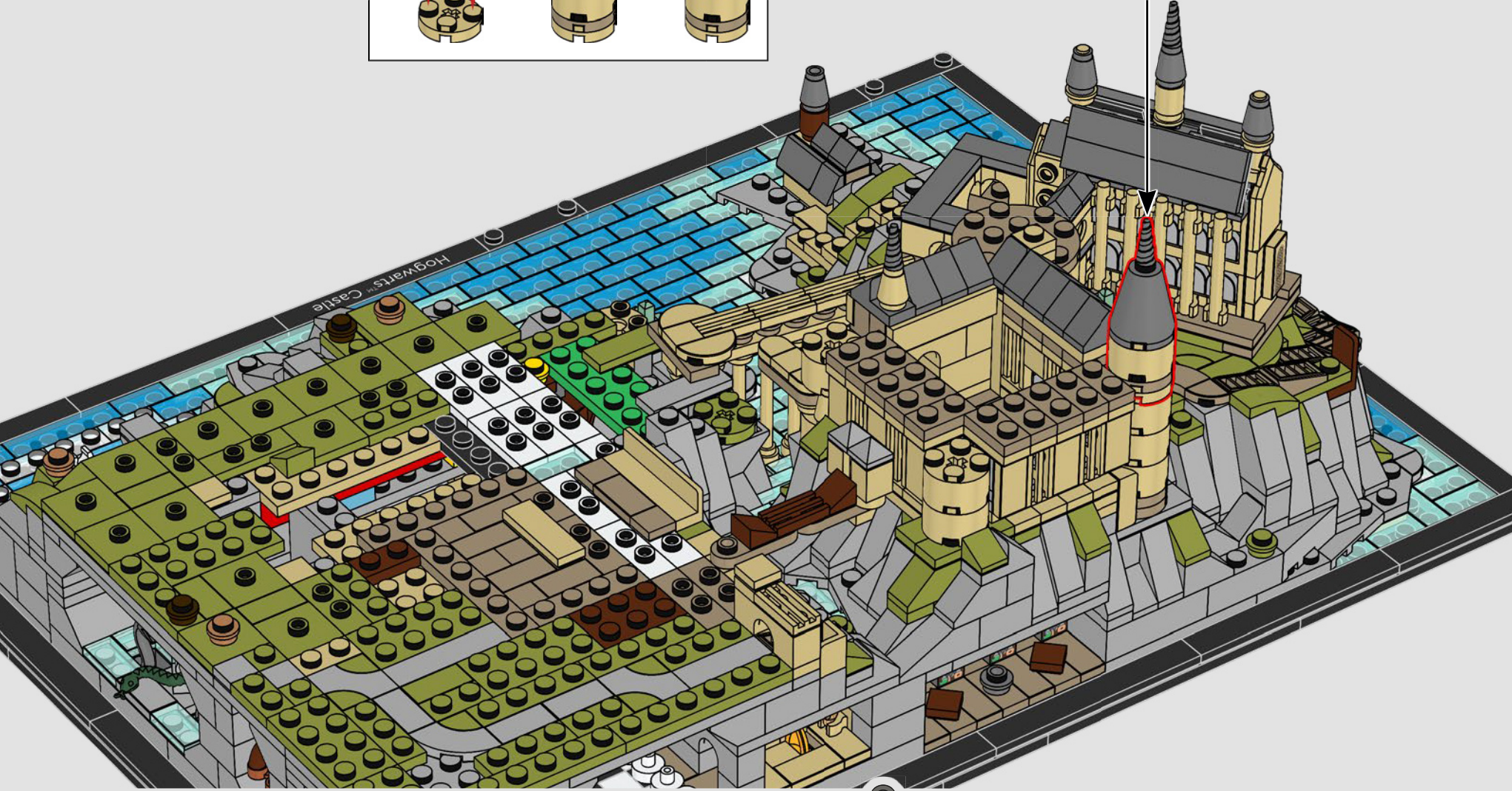
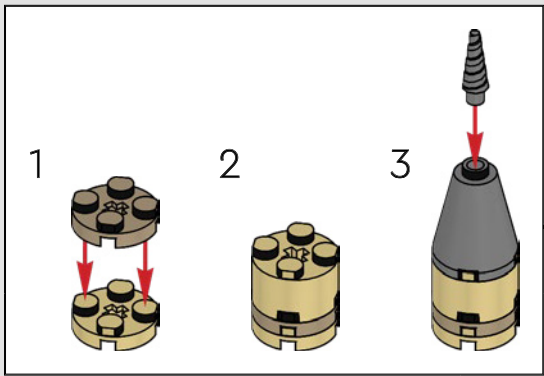



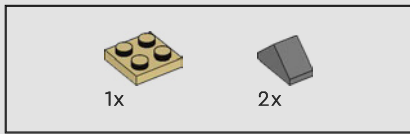

415

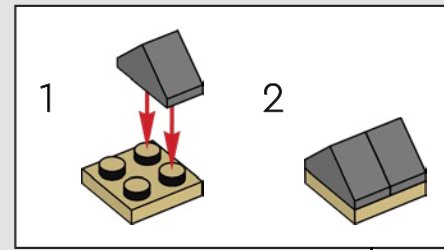

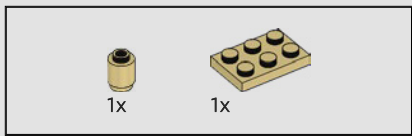

416

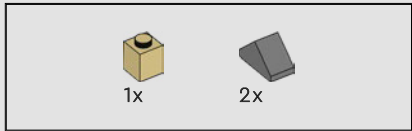
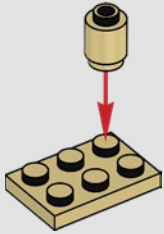

417

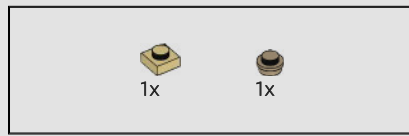
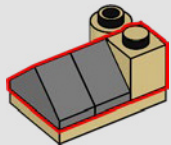

418

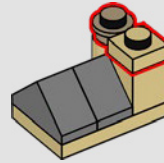

419

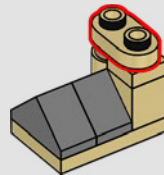

420

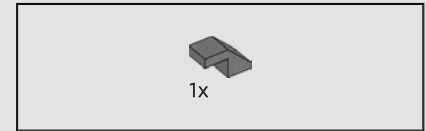
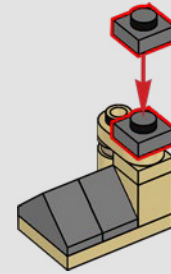

421

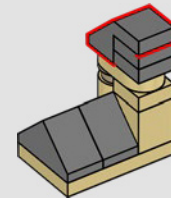



422

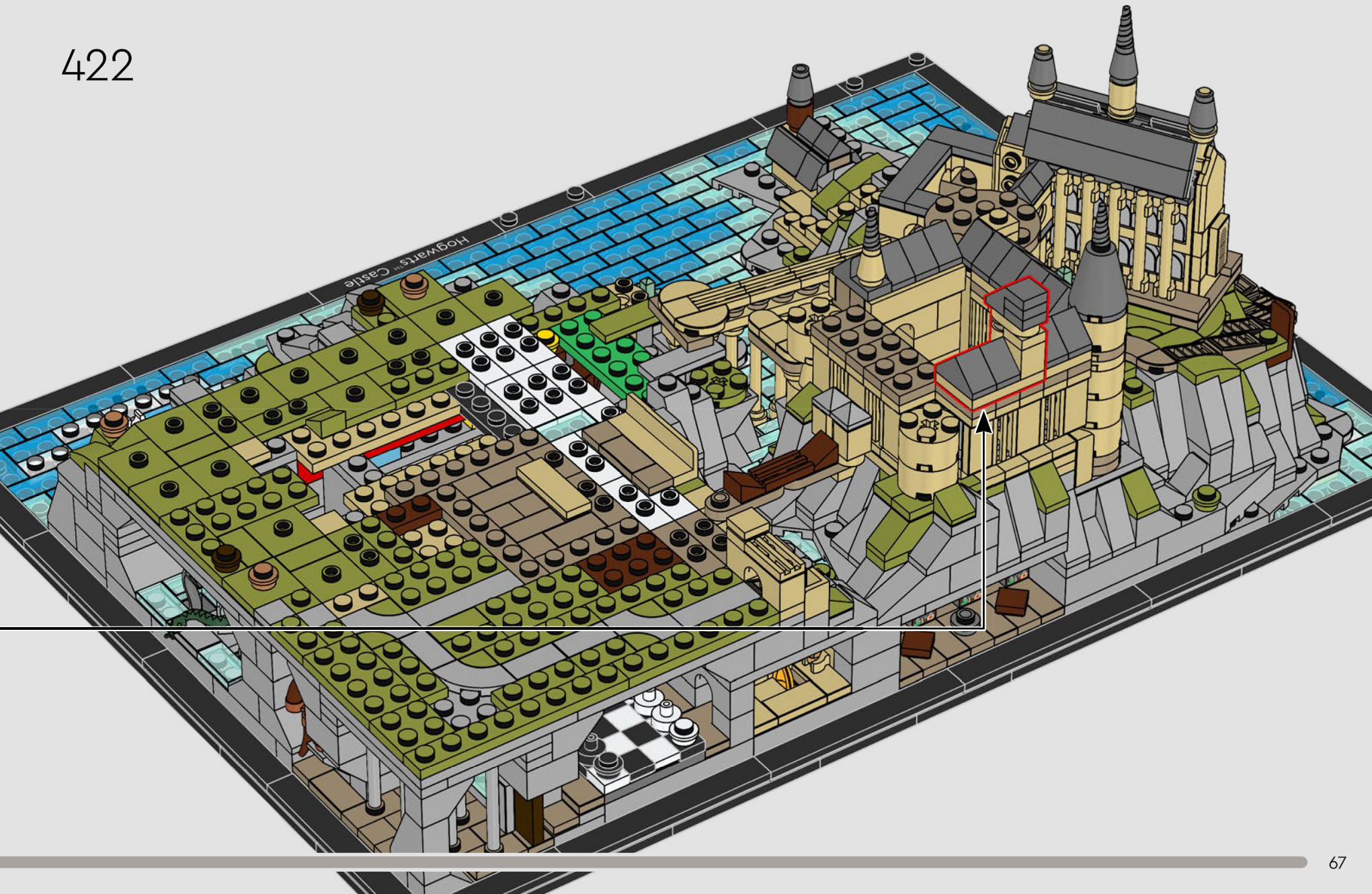



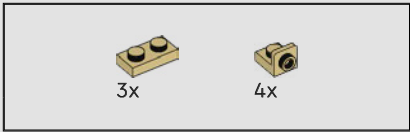

423





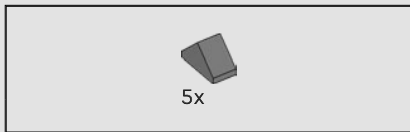

424





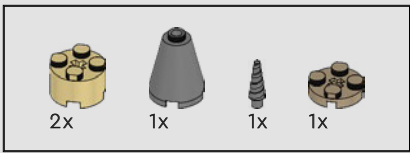

425

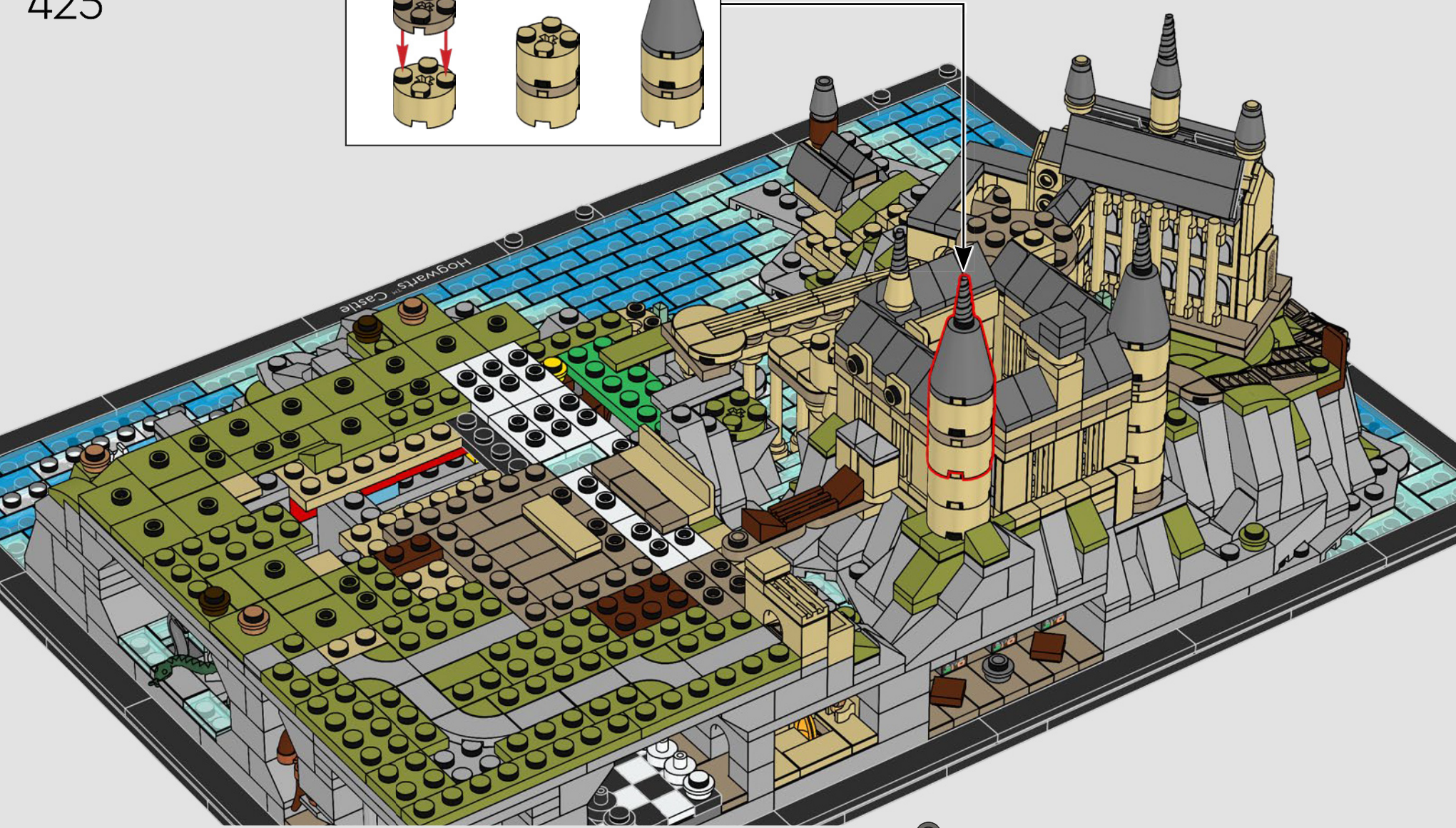
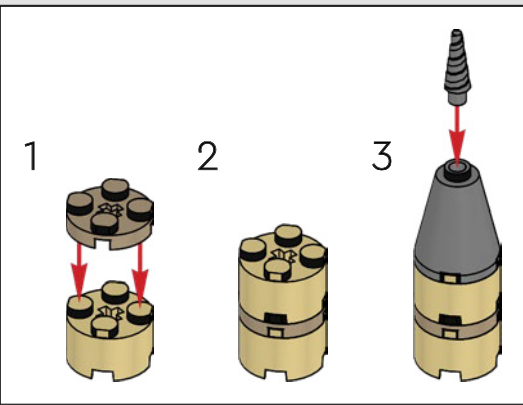



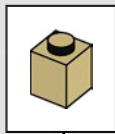
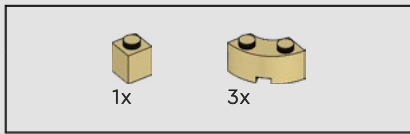

426

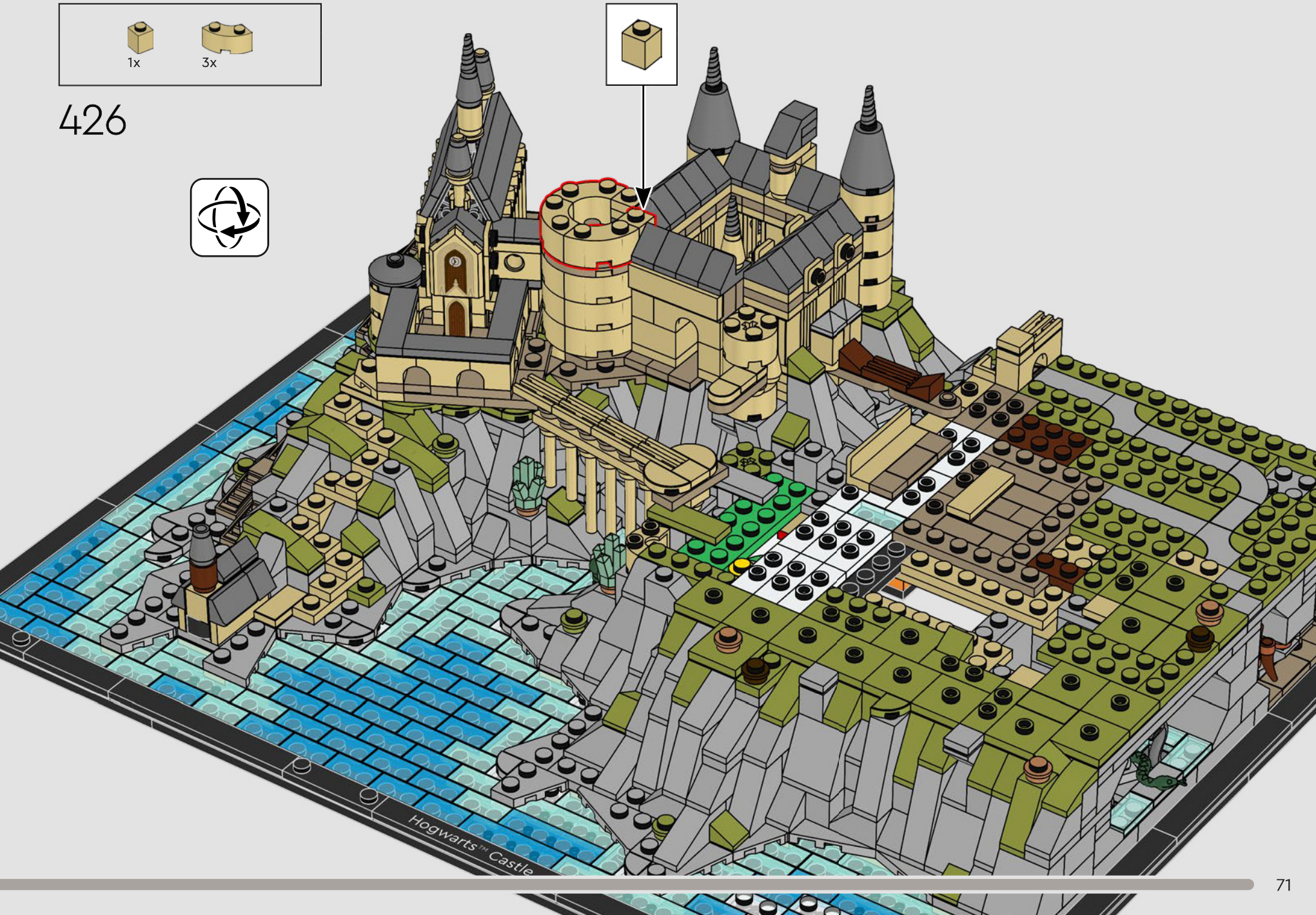

Hogwarts™ Castle

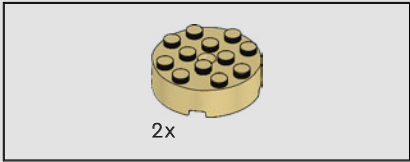
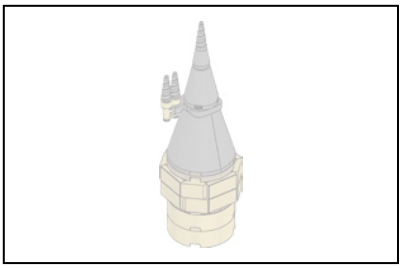

427

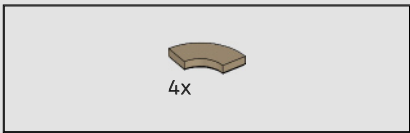
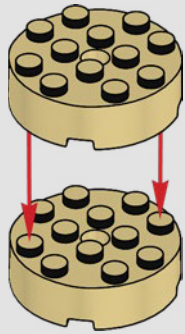

428

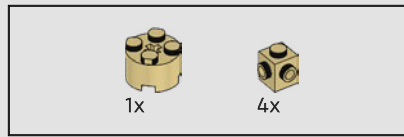
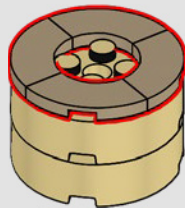

429

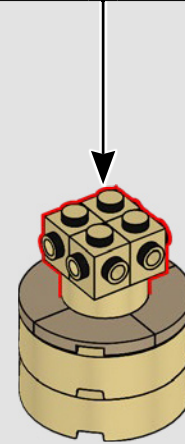
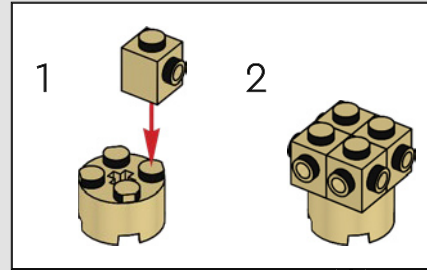



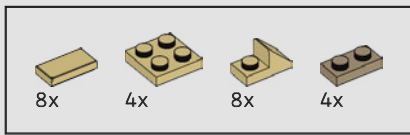

430

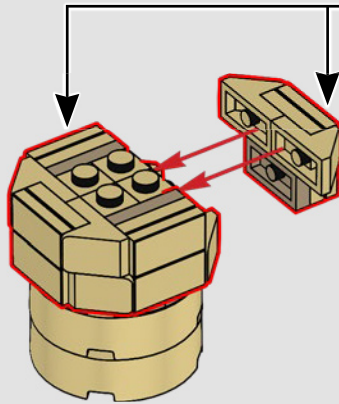
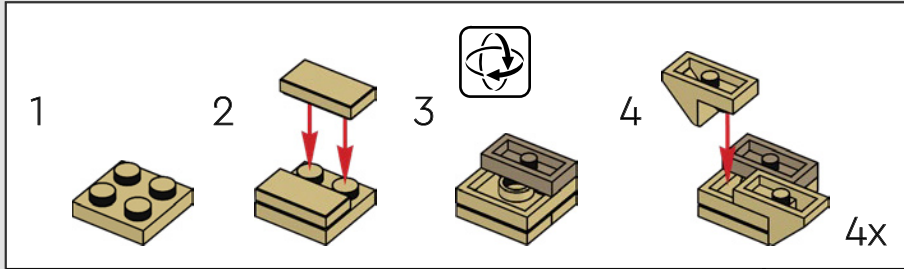

431

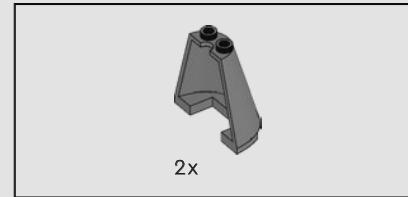
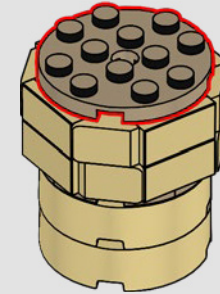

432

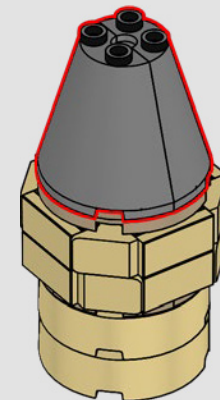

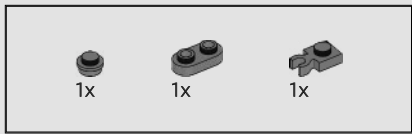

433

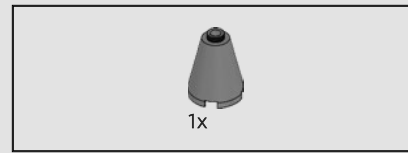
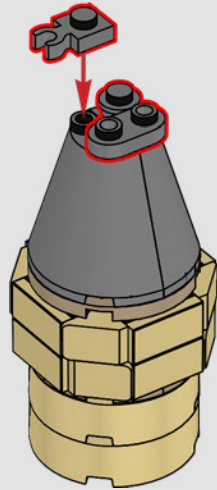

434

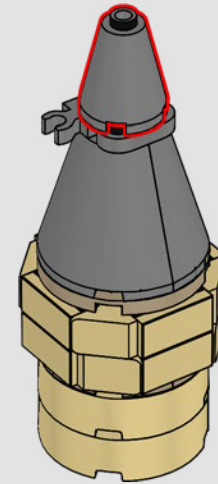



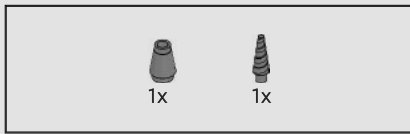

435

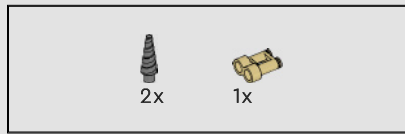
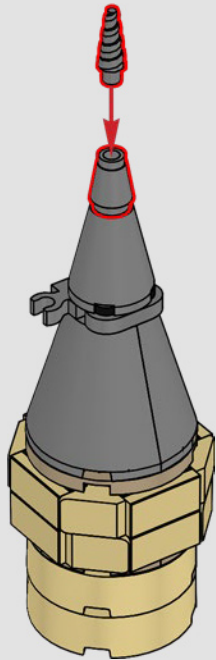

436

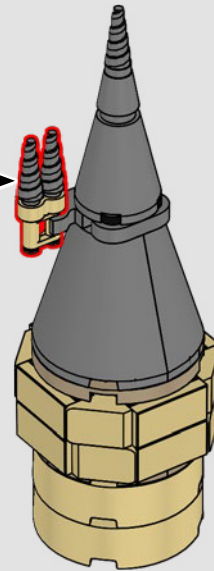
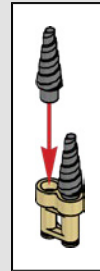

La oficina de Albus Dumbledore™ (las pequeñas torres de la Torre Central) está construida con elementos LEGO® que representan telescopios.



437

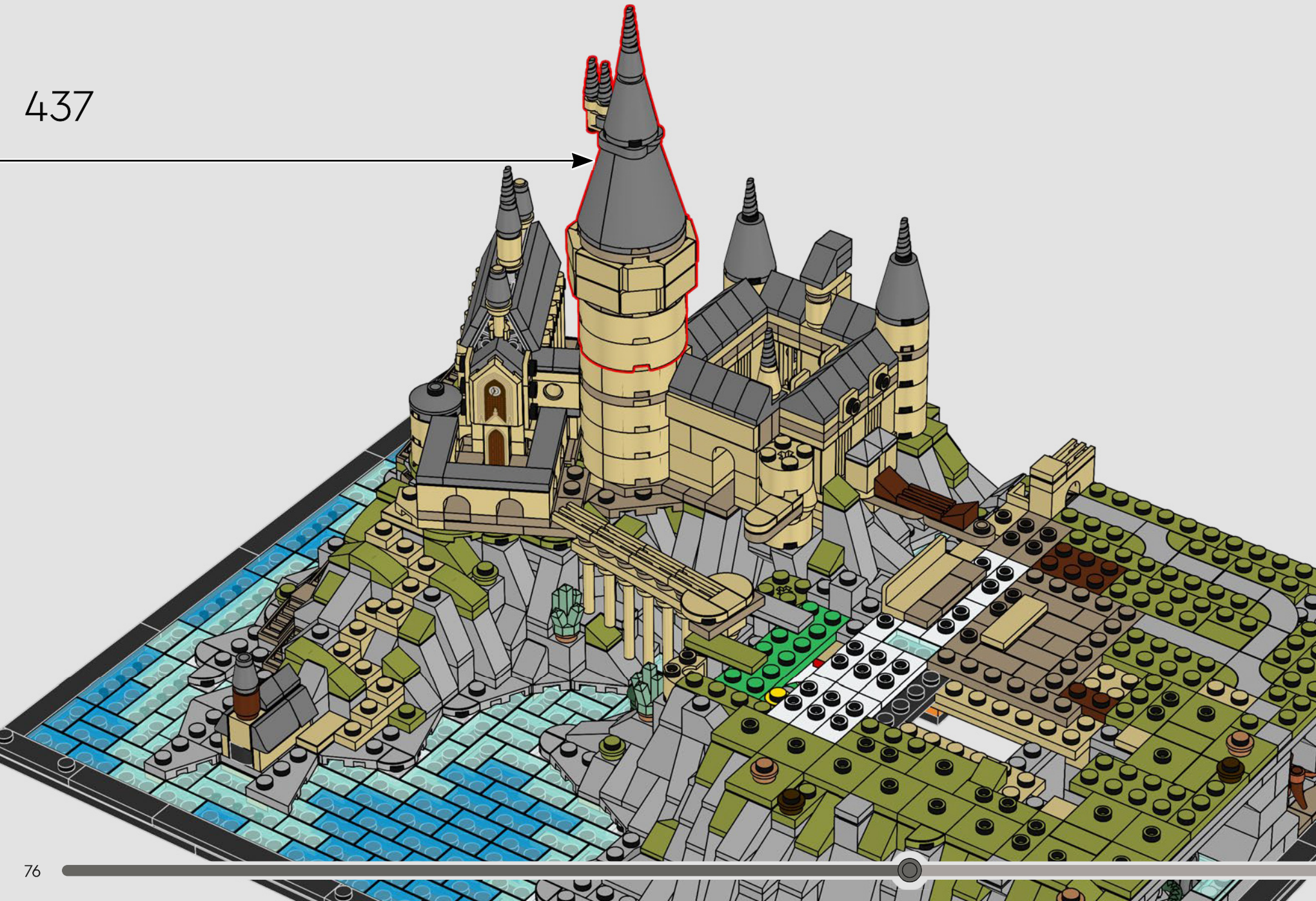





438

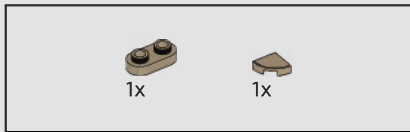
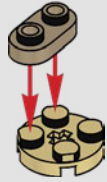

439

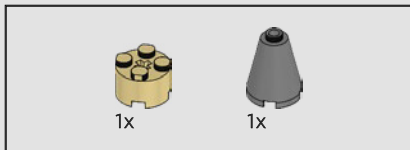

440

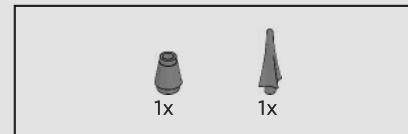
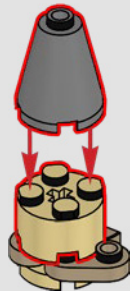

441

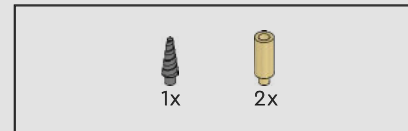
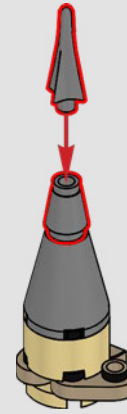

442

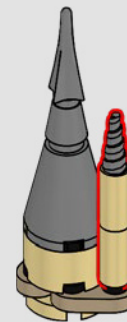
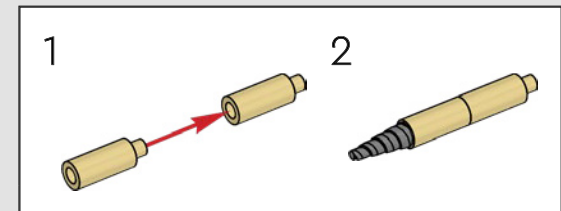

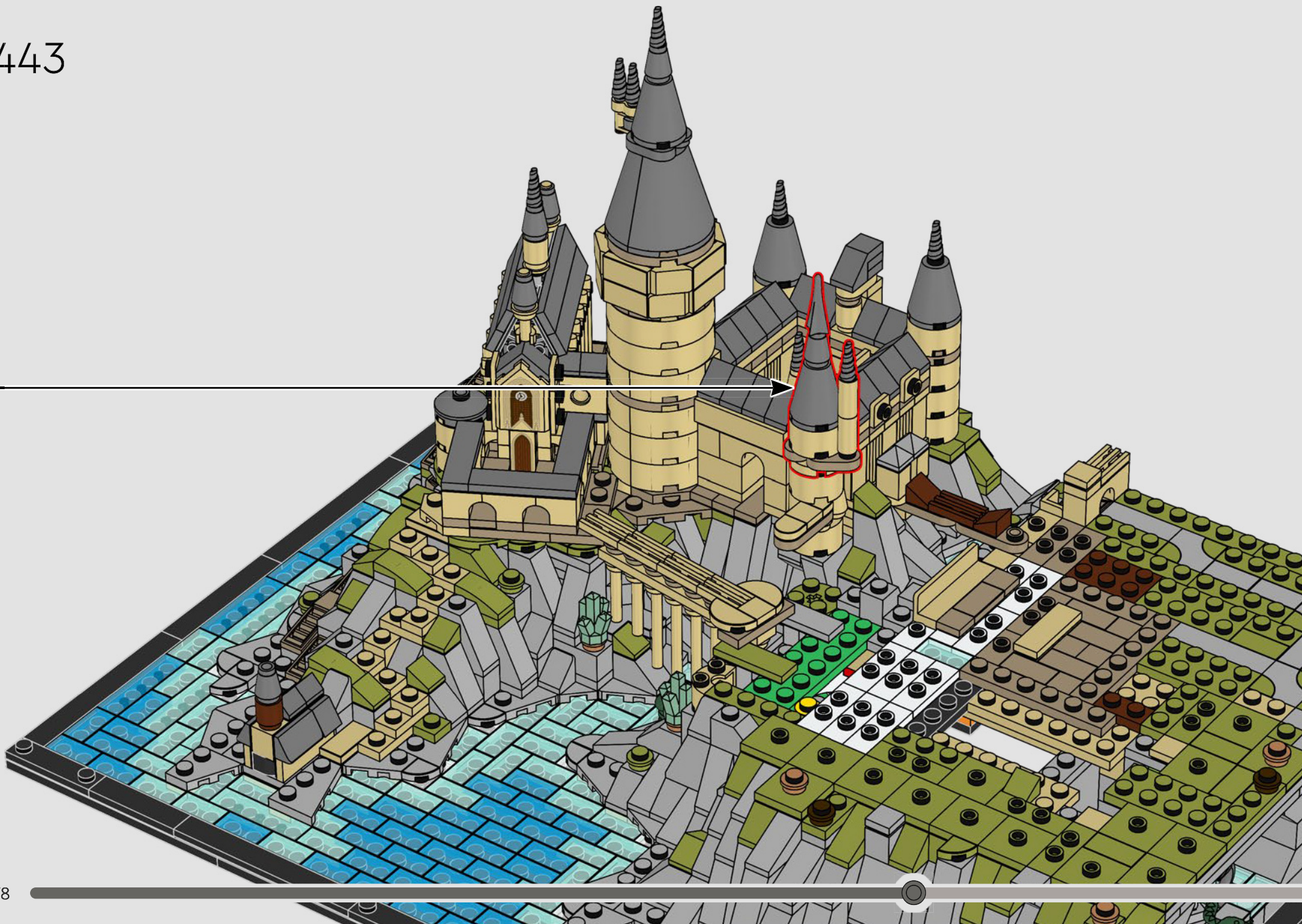





Nunca imaginarías que las torres que brotan de la Torre Central pudieran ser una estructura arquitectónicamente sostenible... Pero, claro, ¡en Hogwarts™ todo es posible!





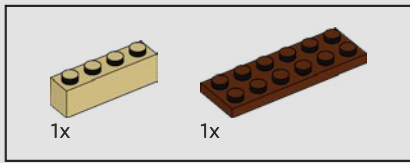

444

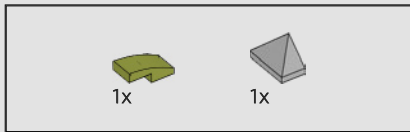
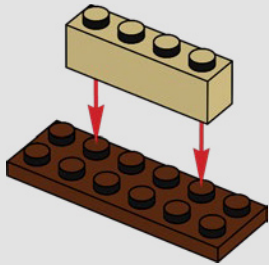

445

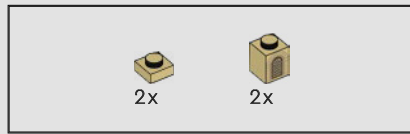
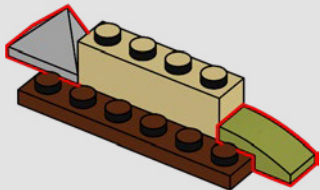

446

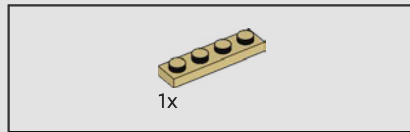
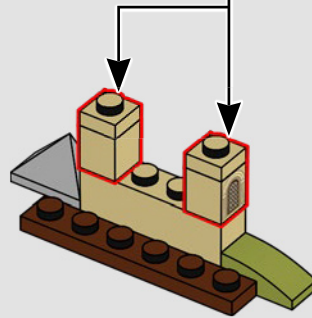
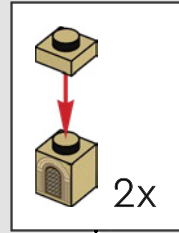

447

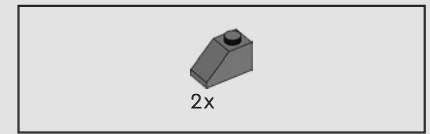
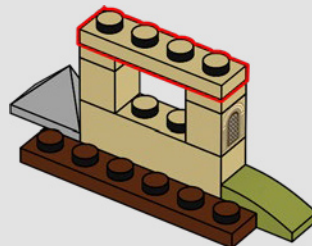

448

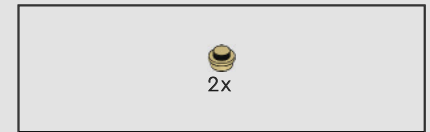
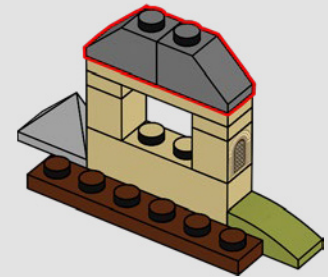

449

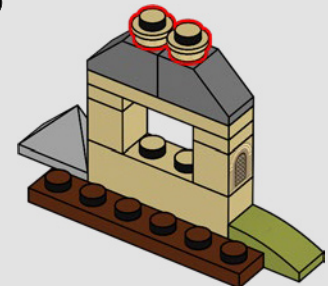

450

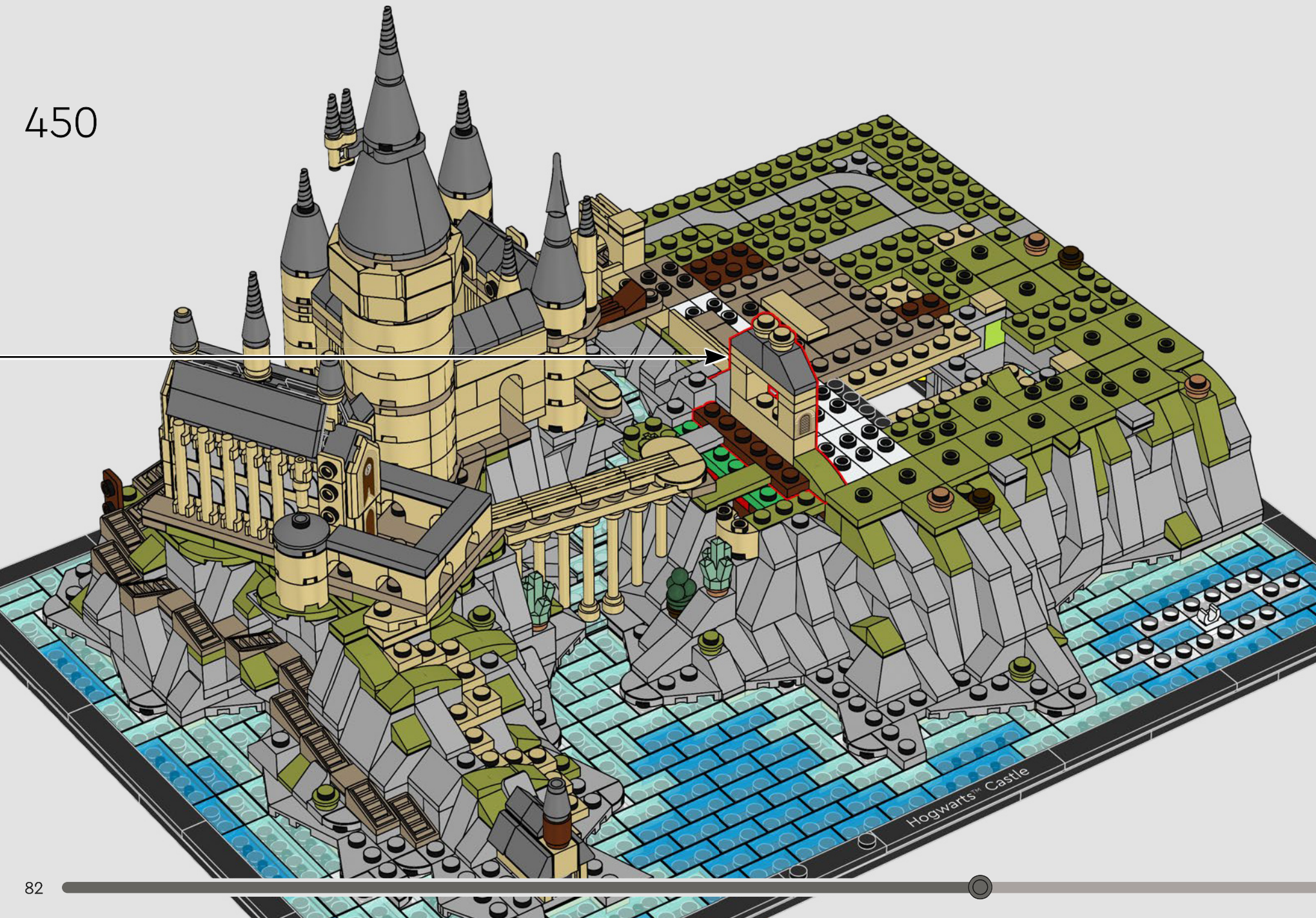



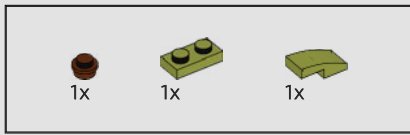

451

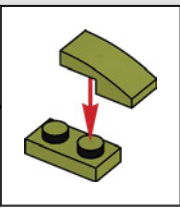
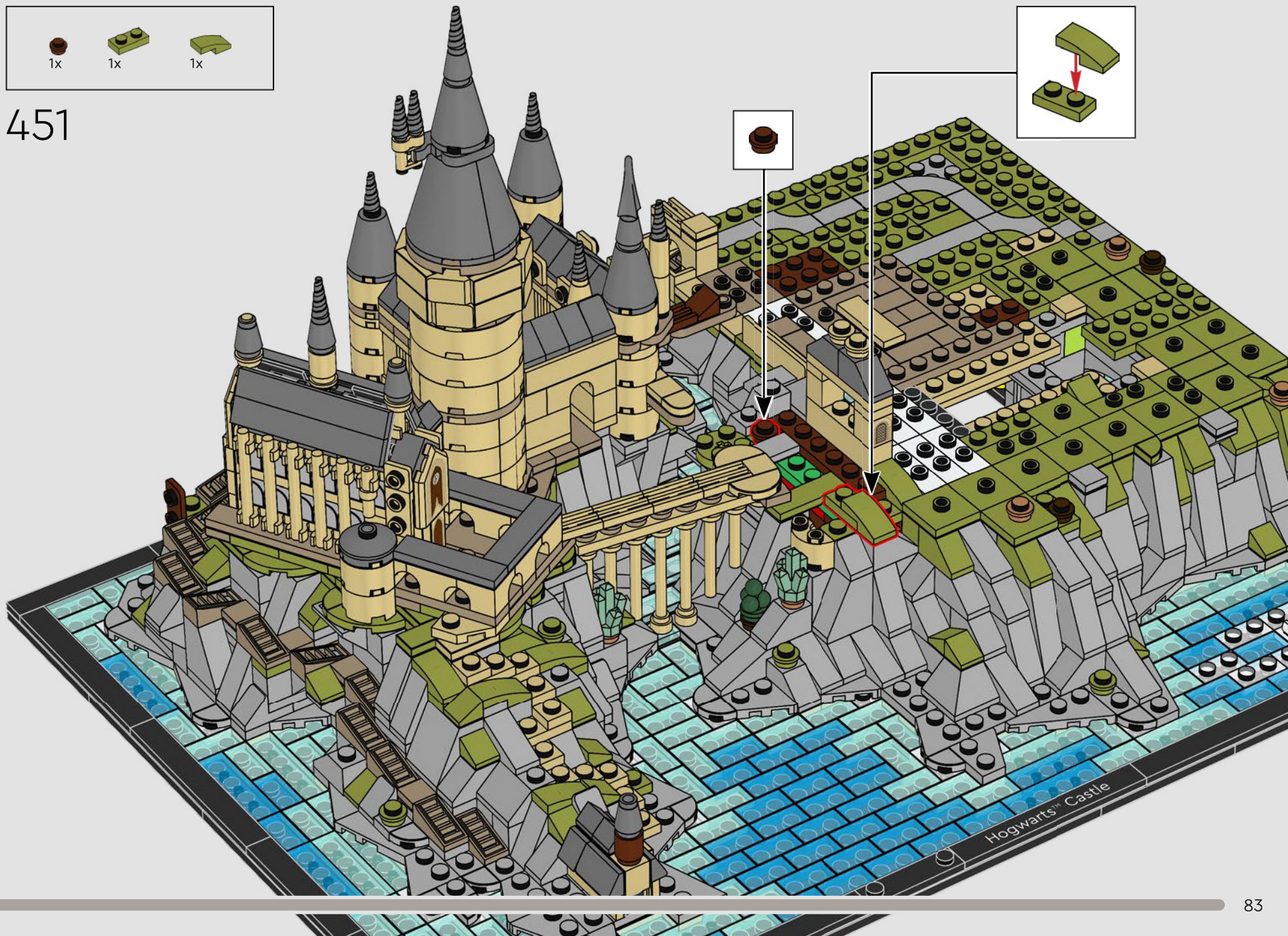



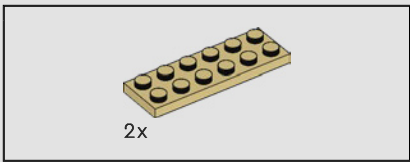

452

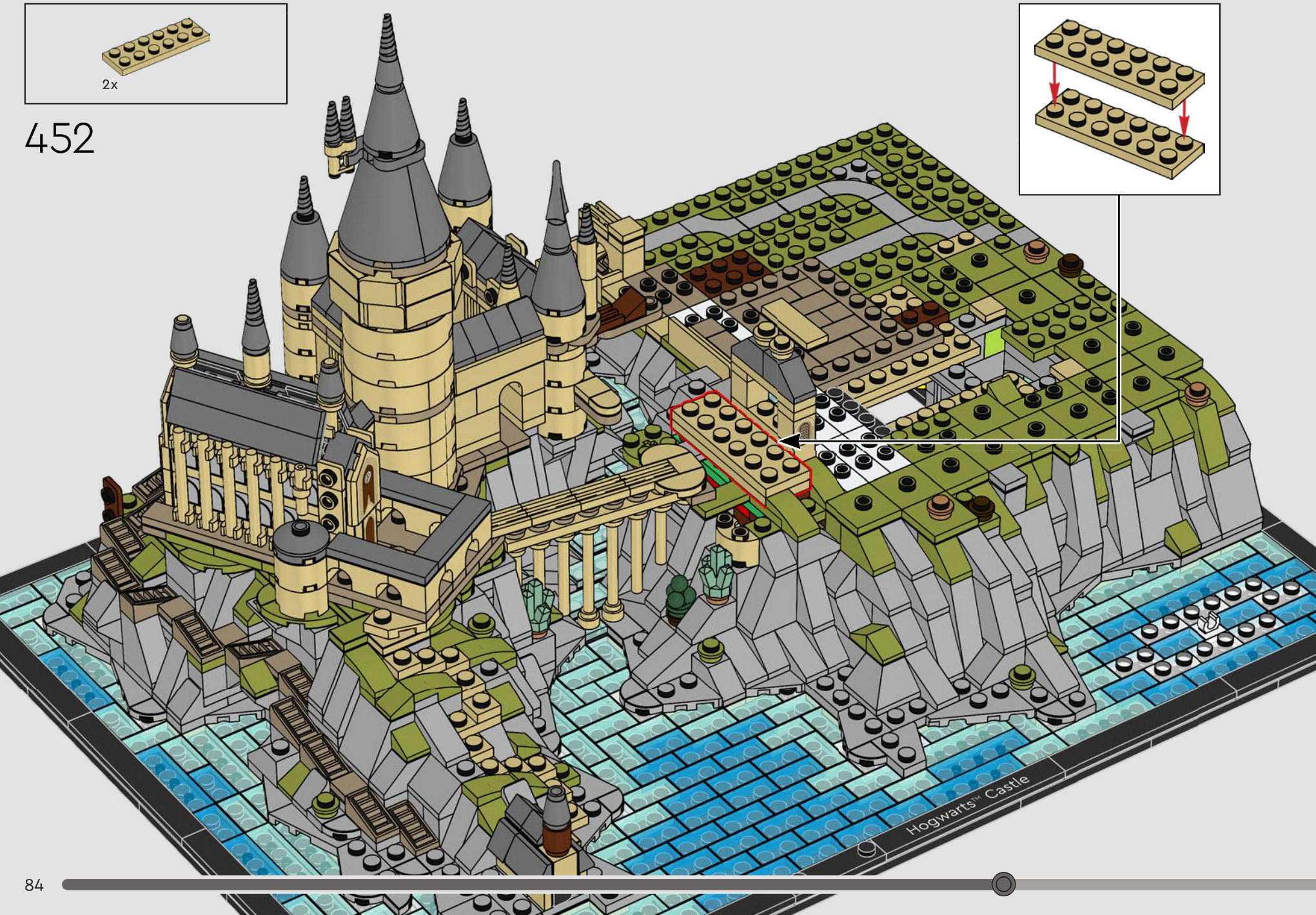
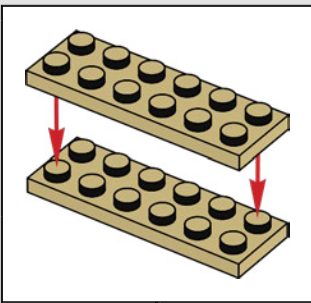

Hogwarts™ Castle





453

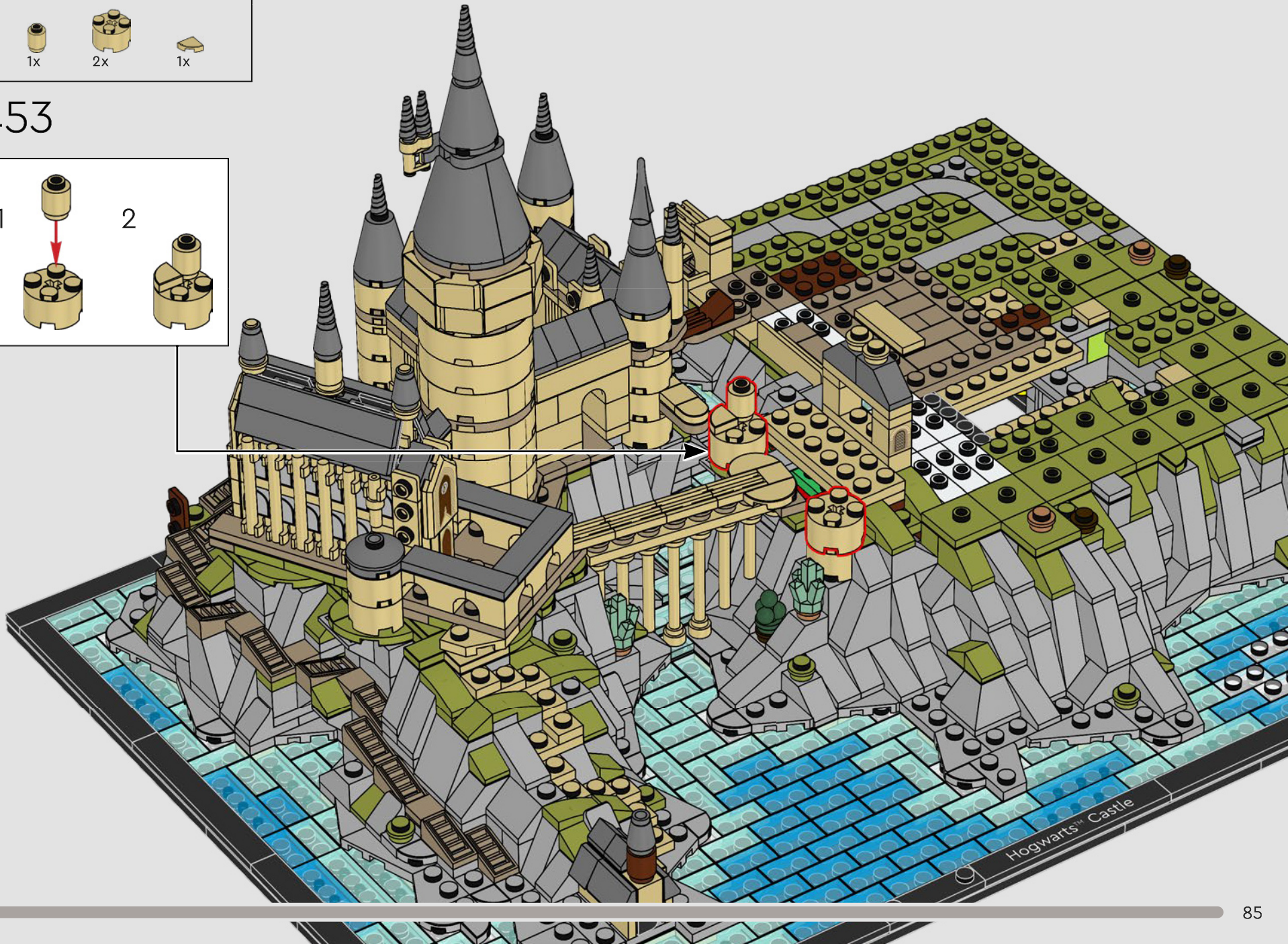
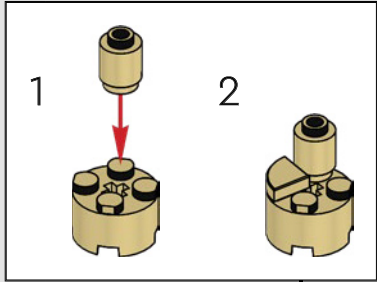





3x

454

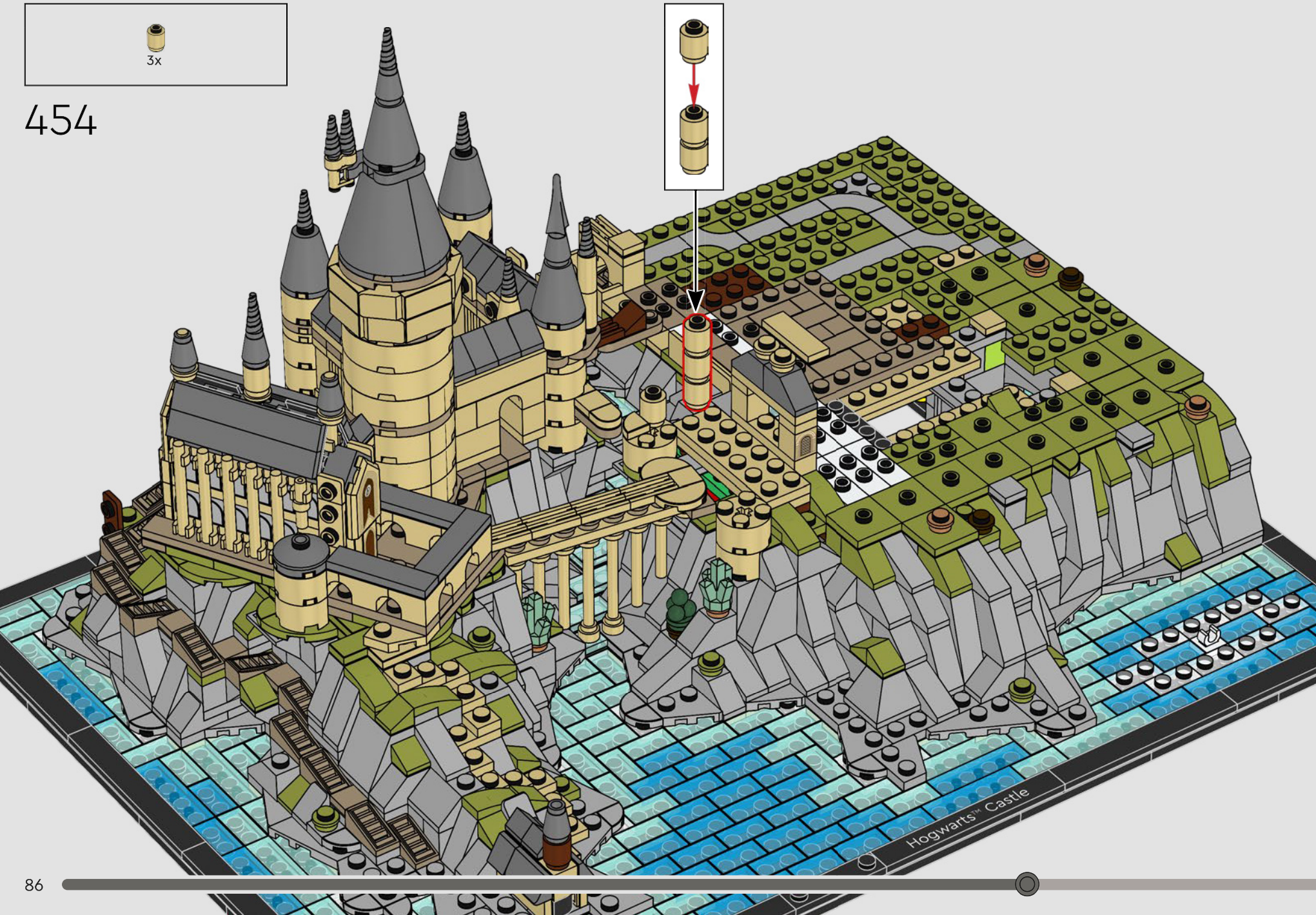
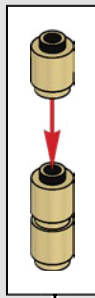

Hogwarts™ Castle



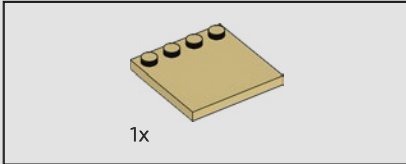
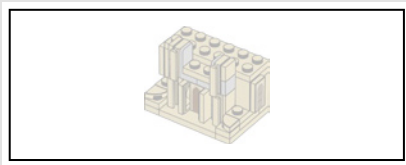

455

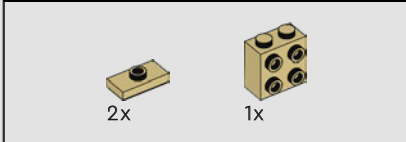
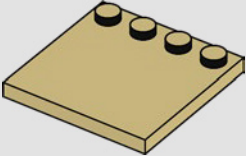

456

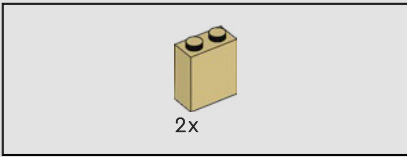
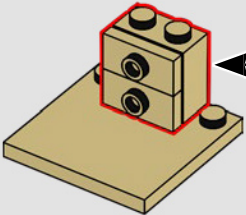
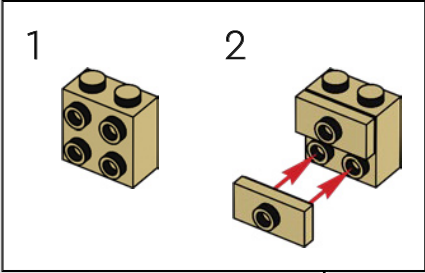

457

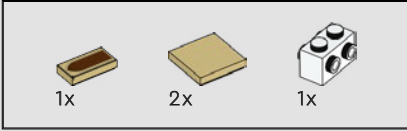
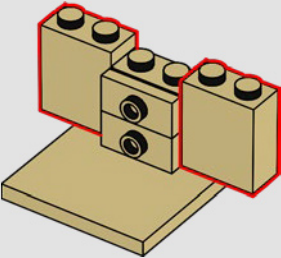

458

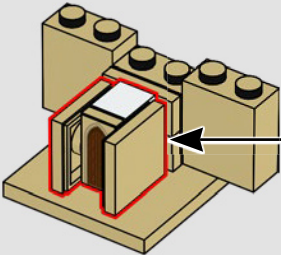
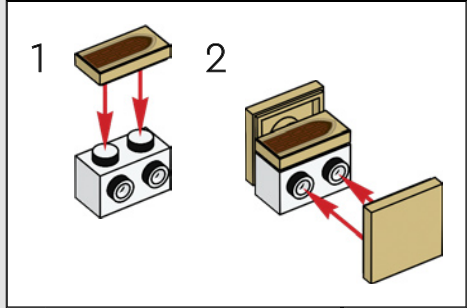

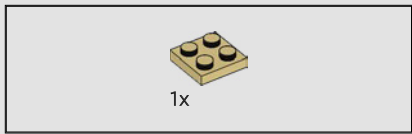

459

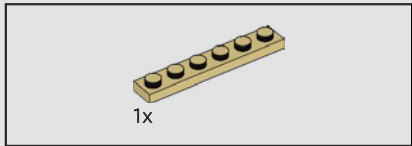
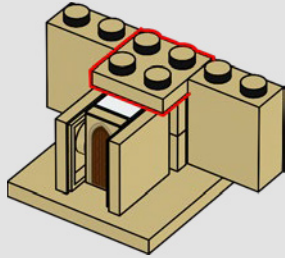

460

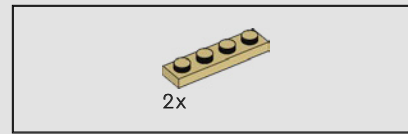
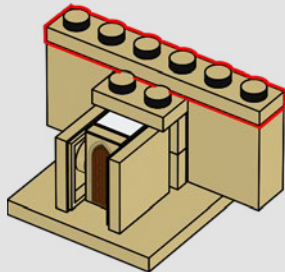

461

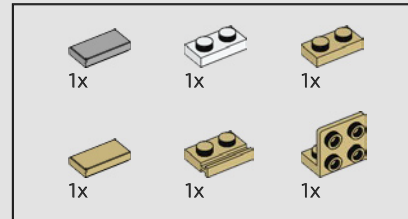
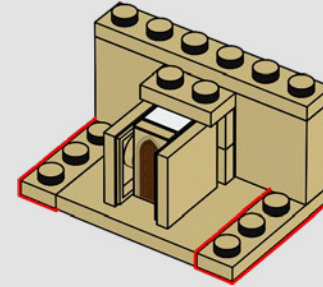

462

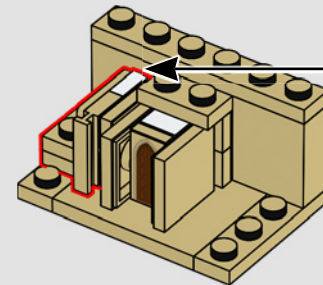
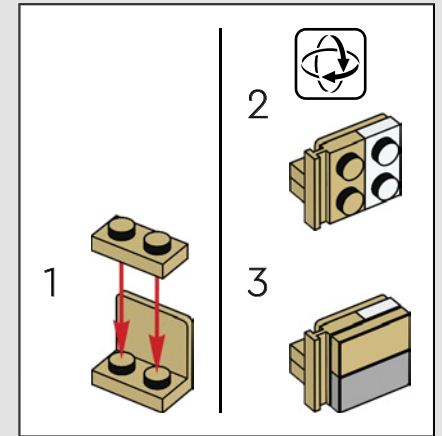



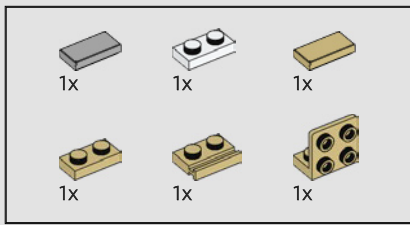

463

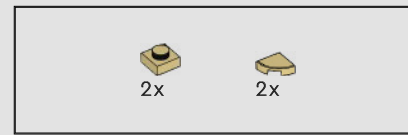
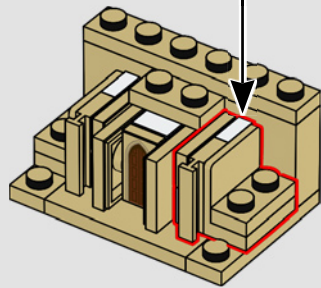
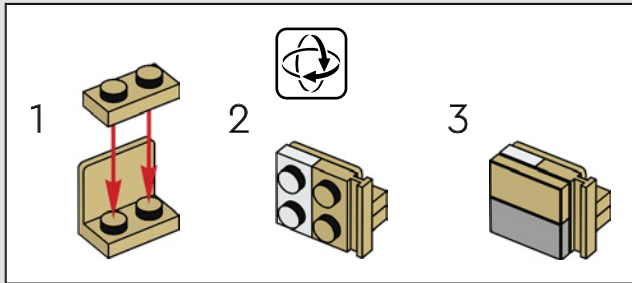

464

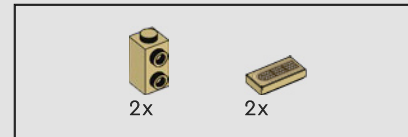
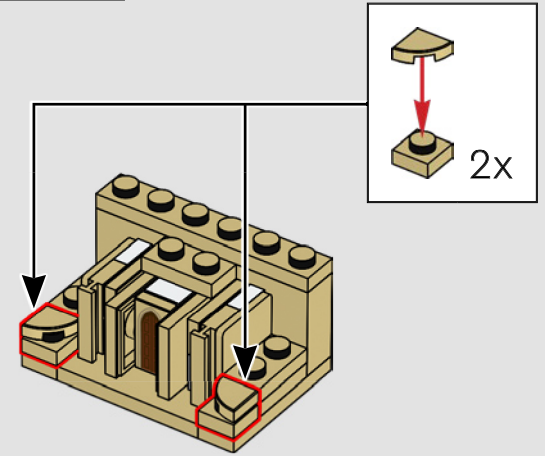

465

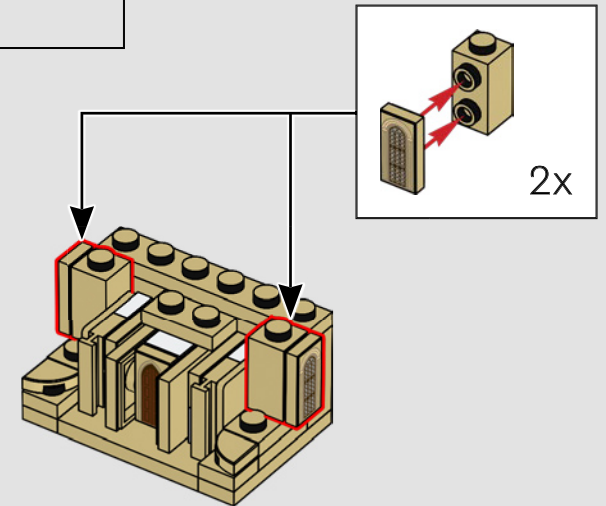

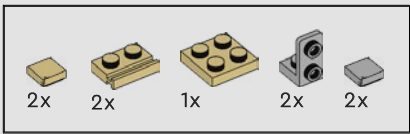

466

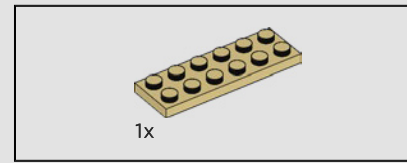
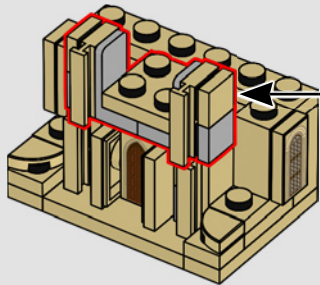
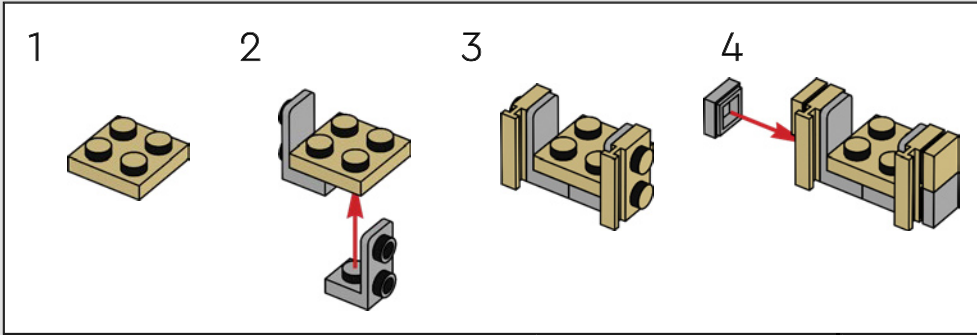

467

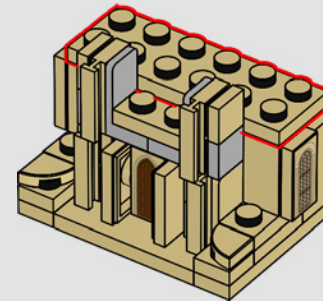



468

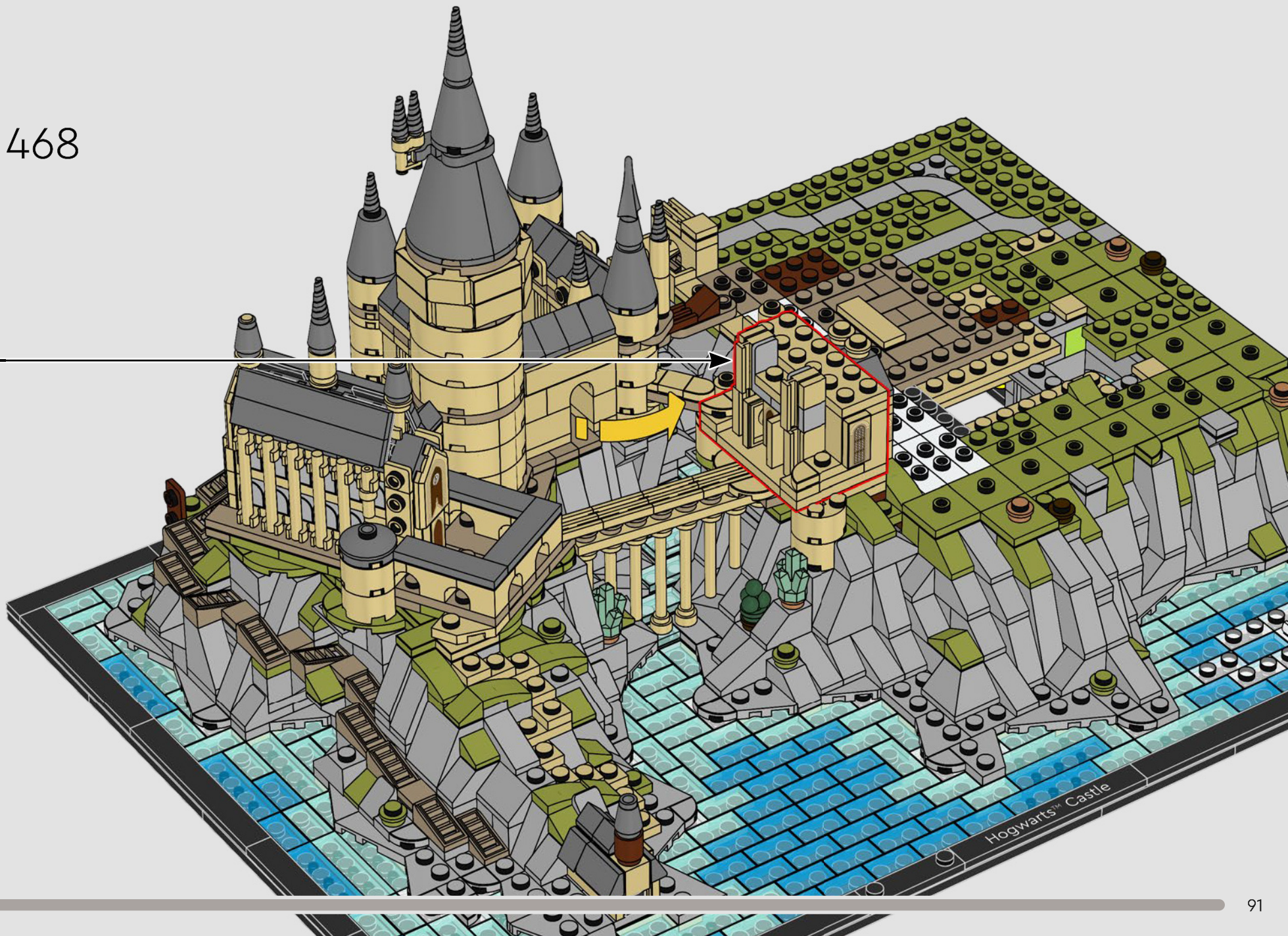



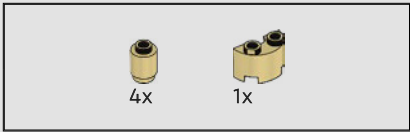

469

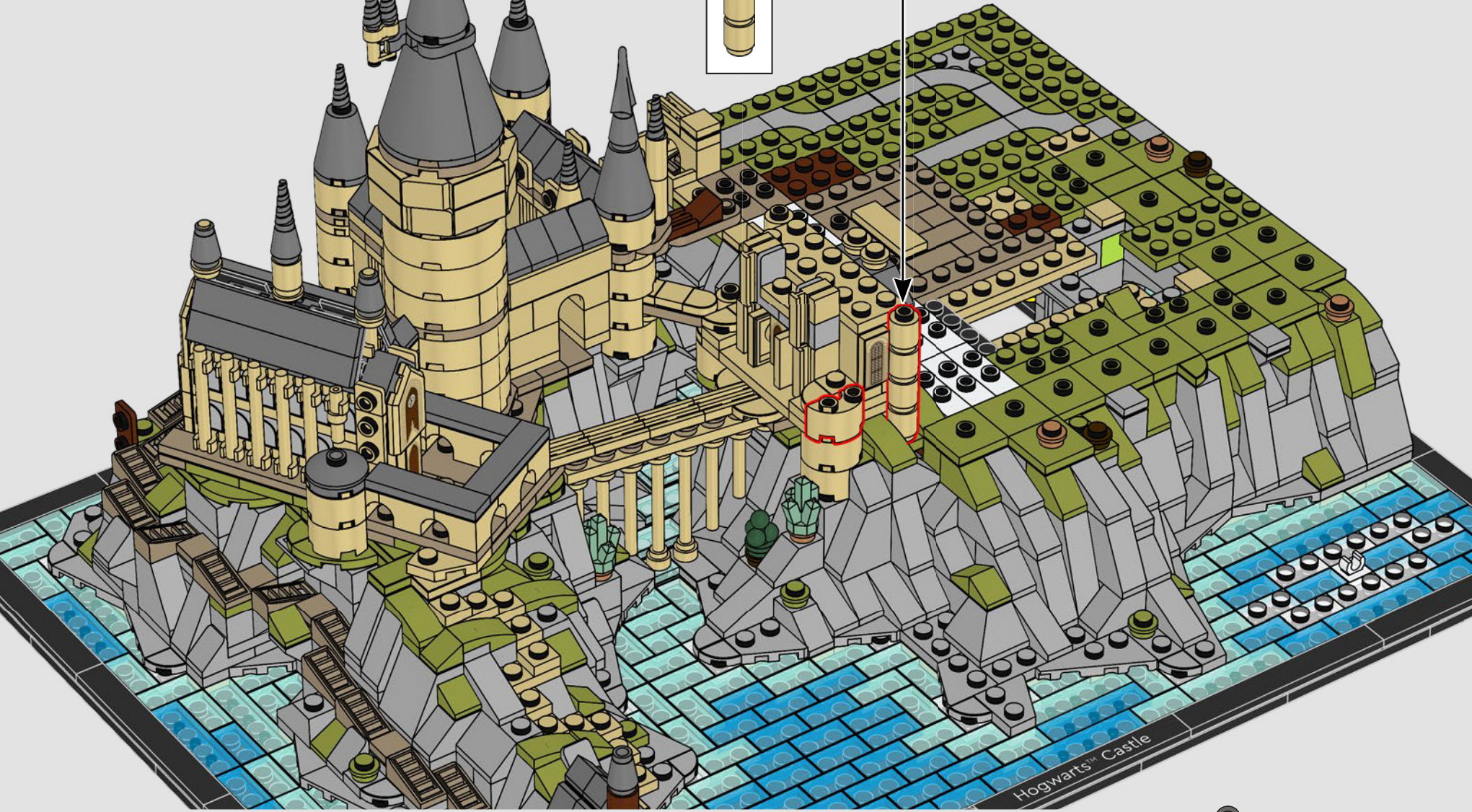
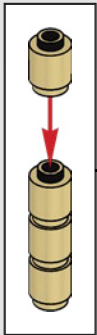



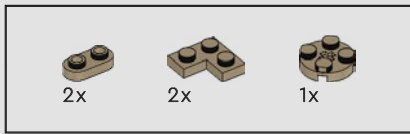

470

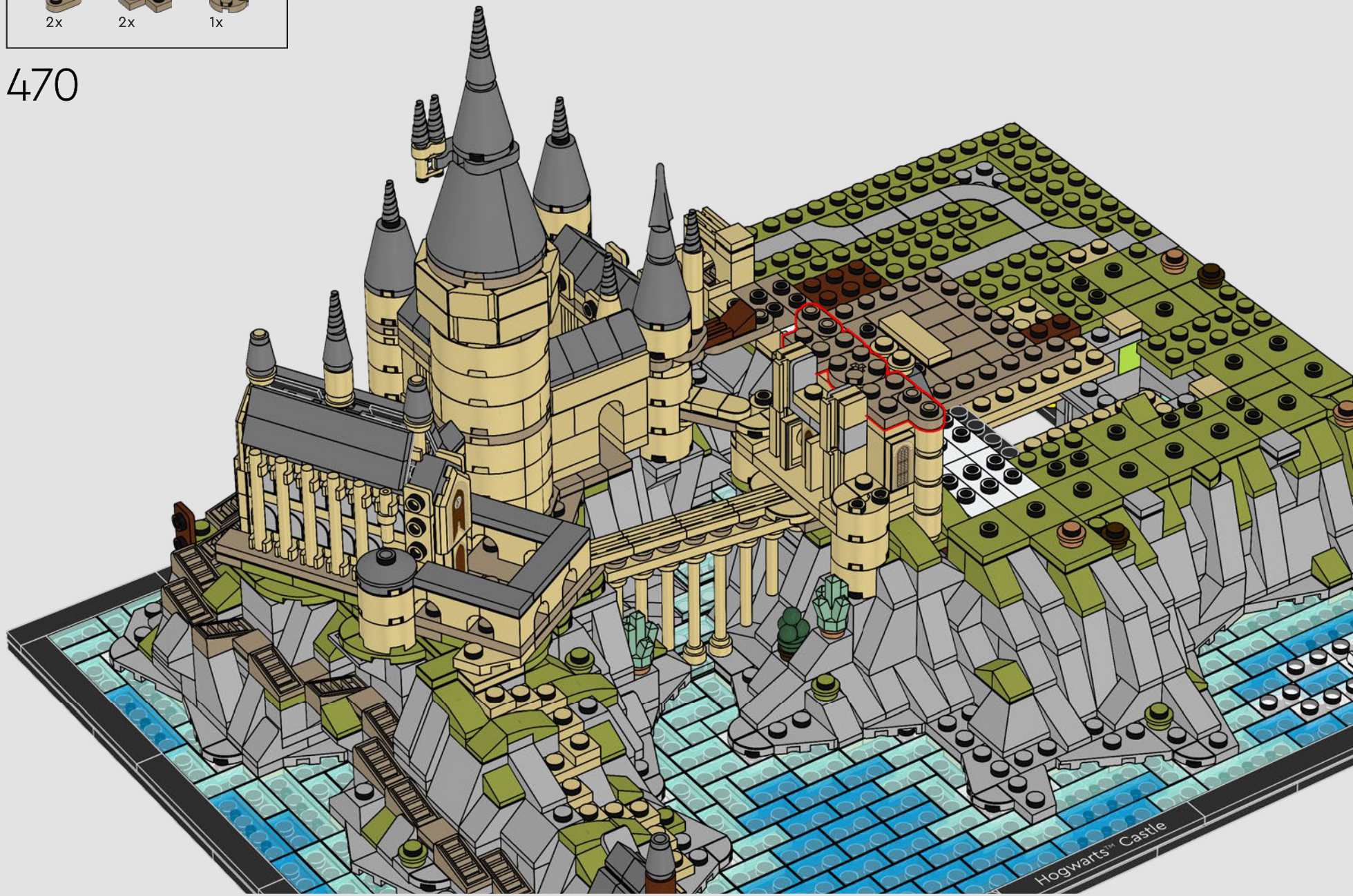



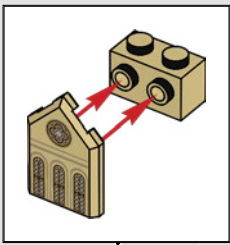
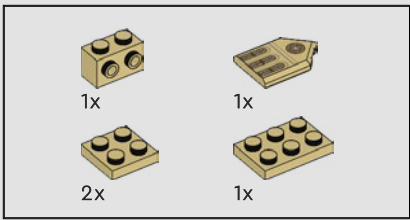

471

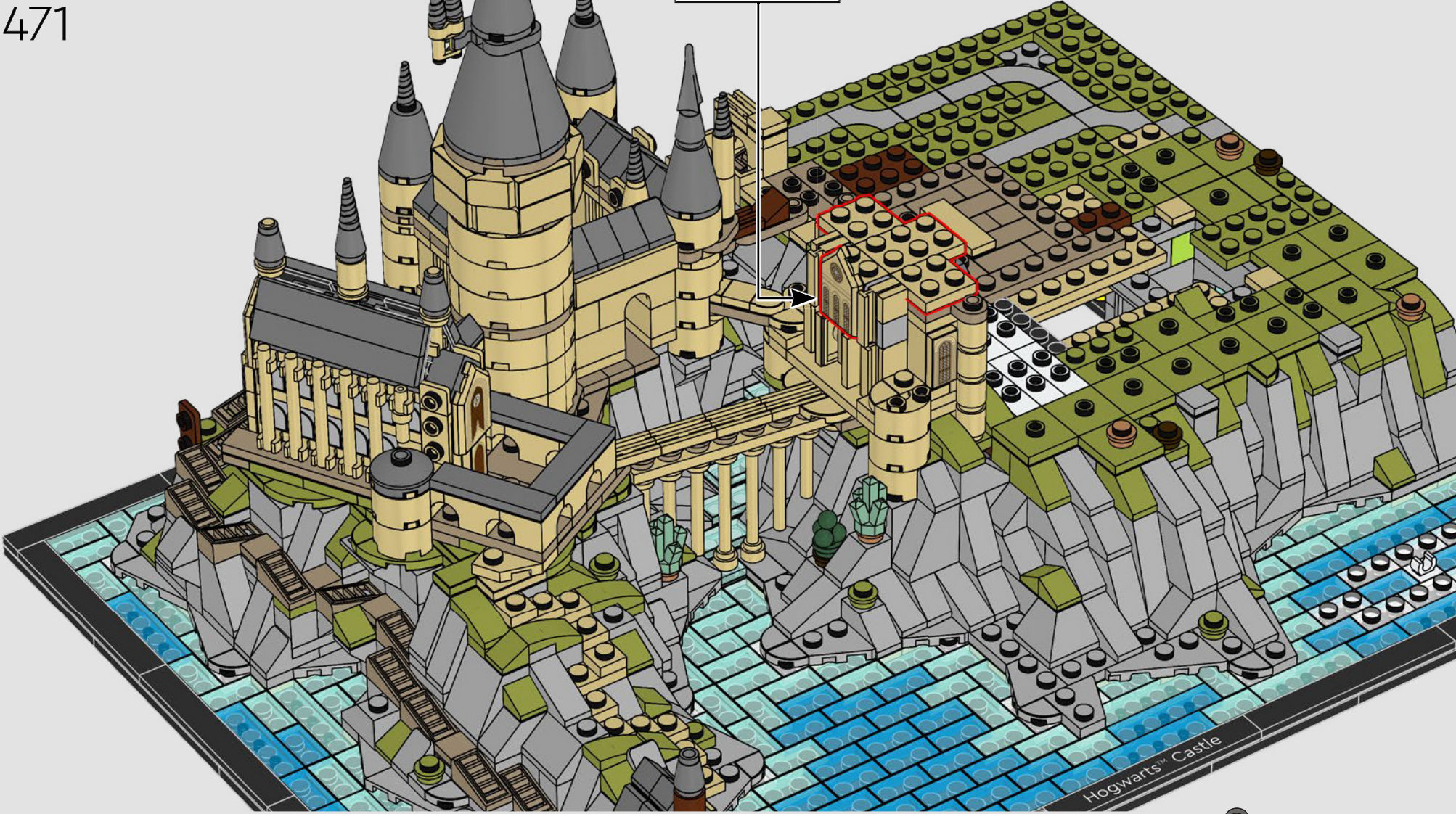





472

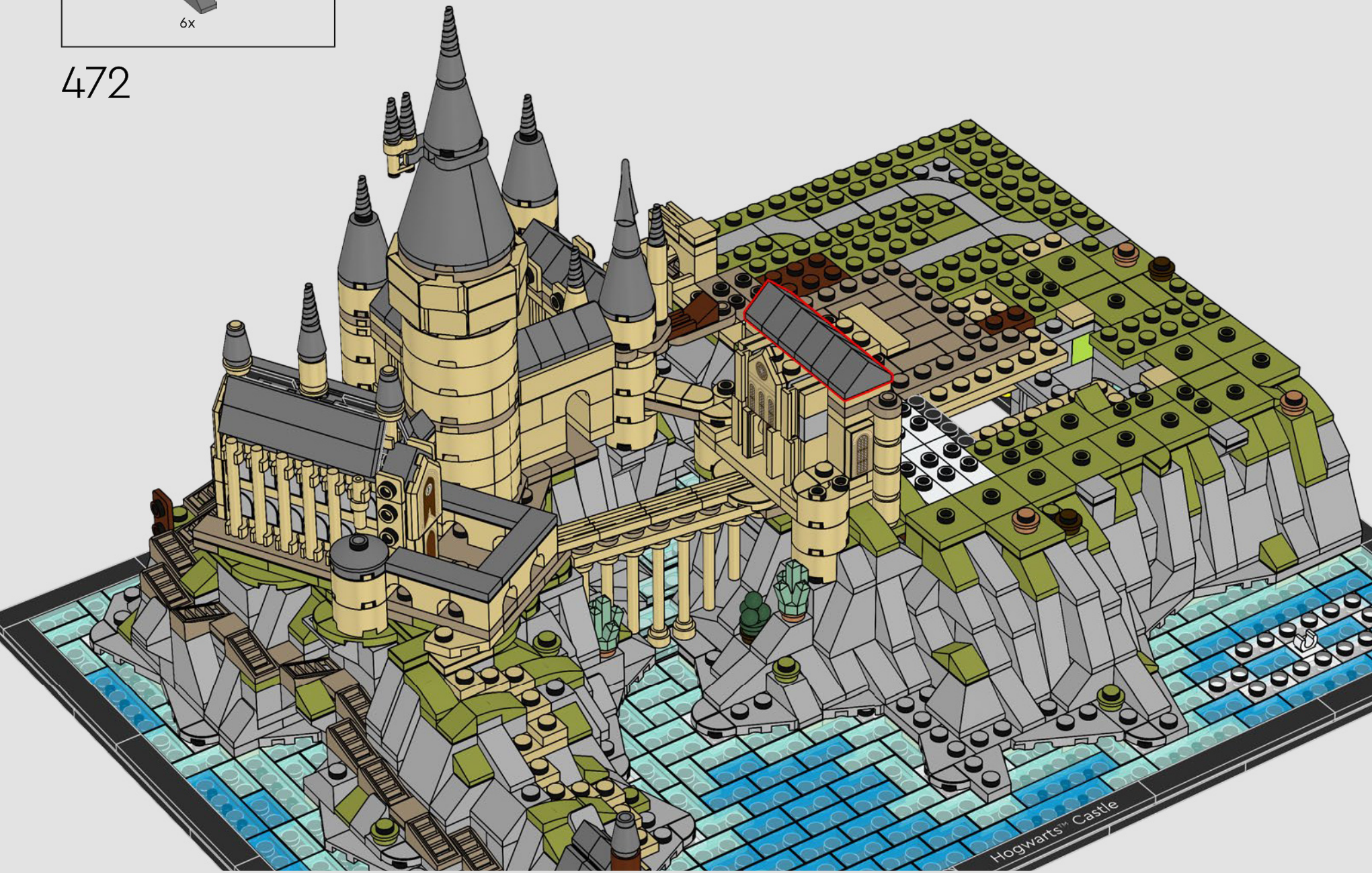



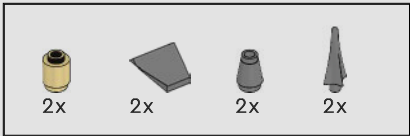

473

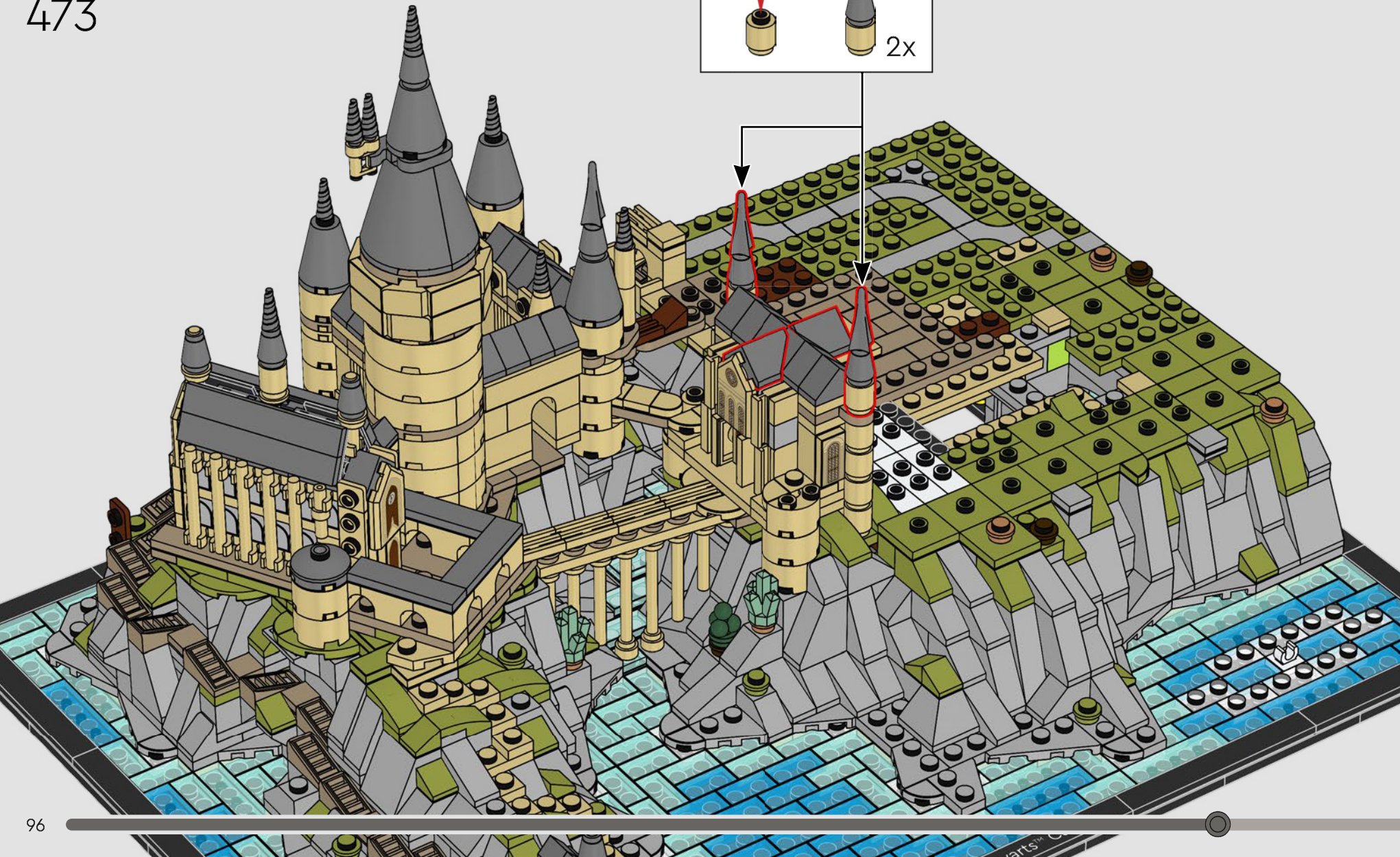
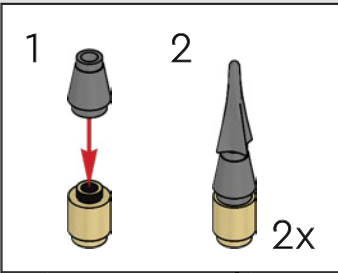



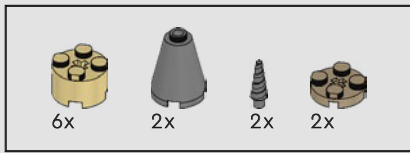

474

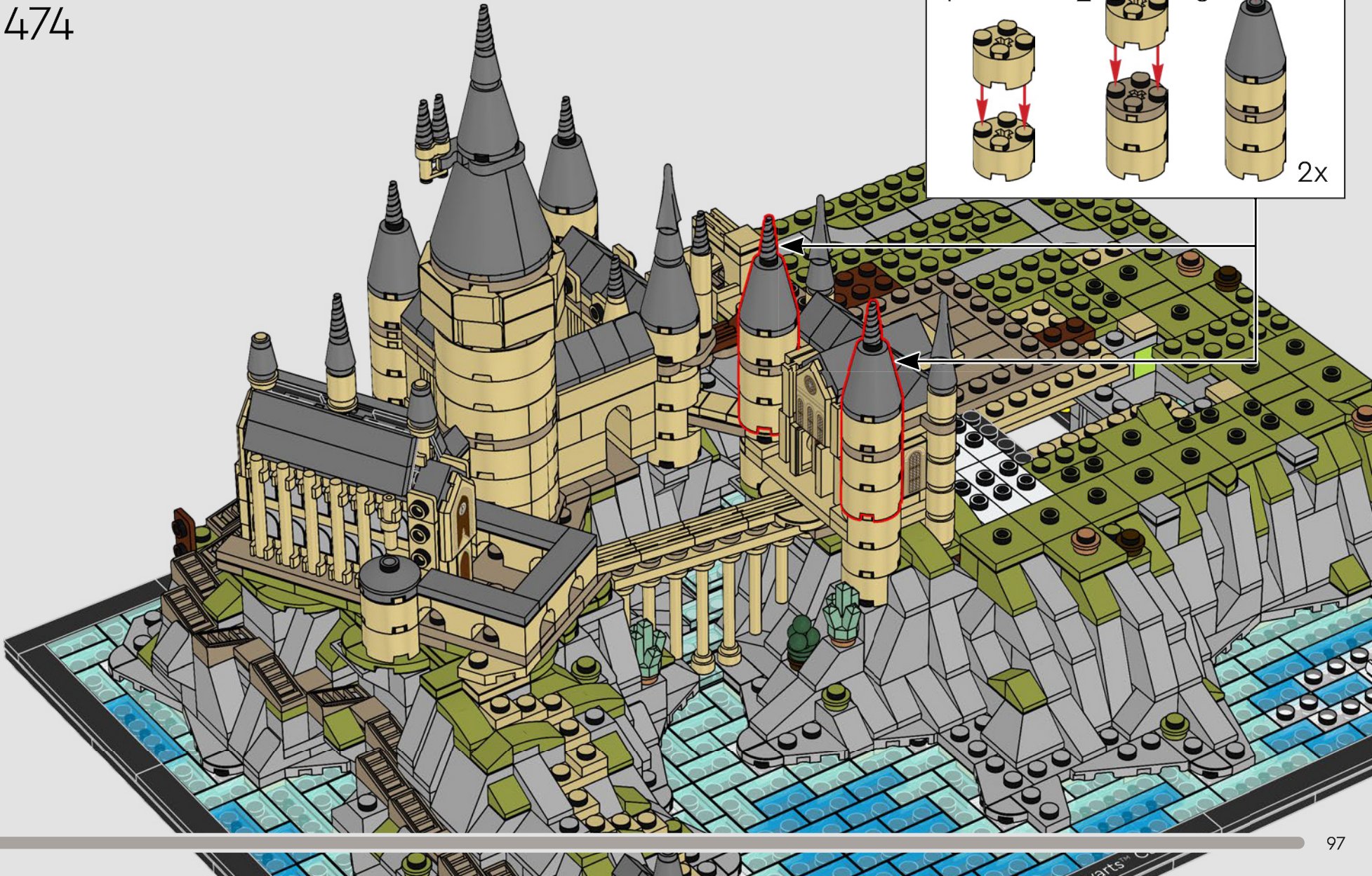
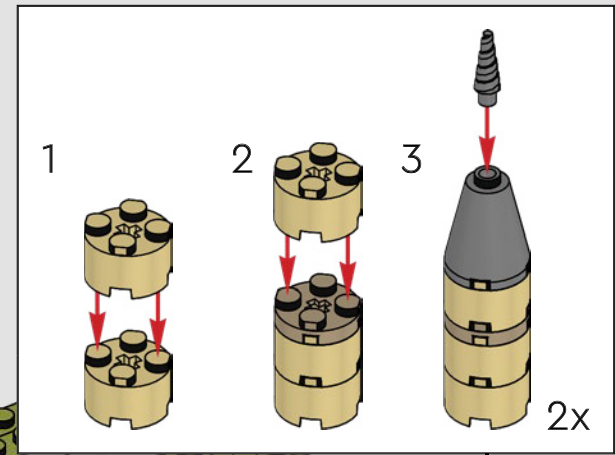



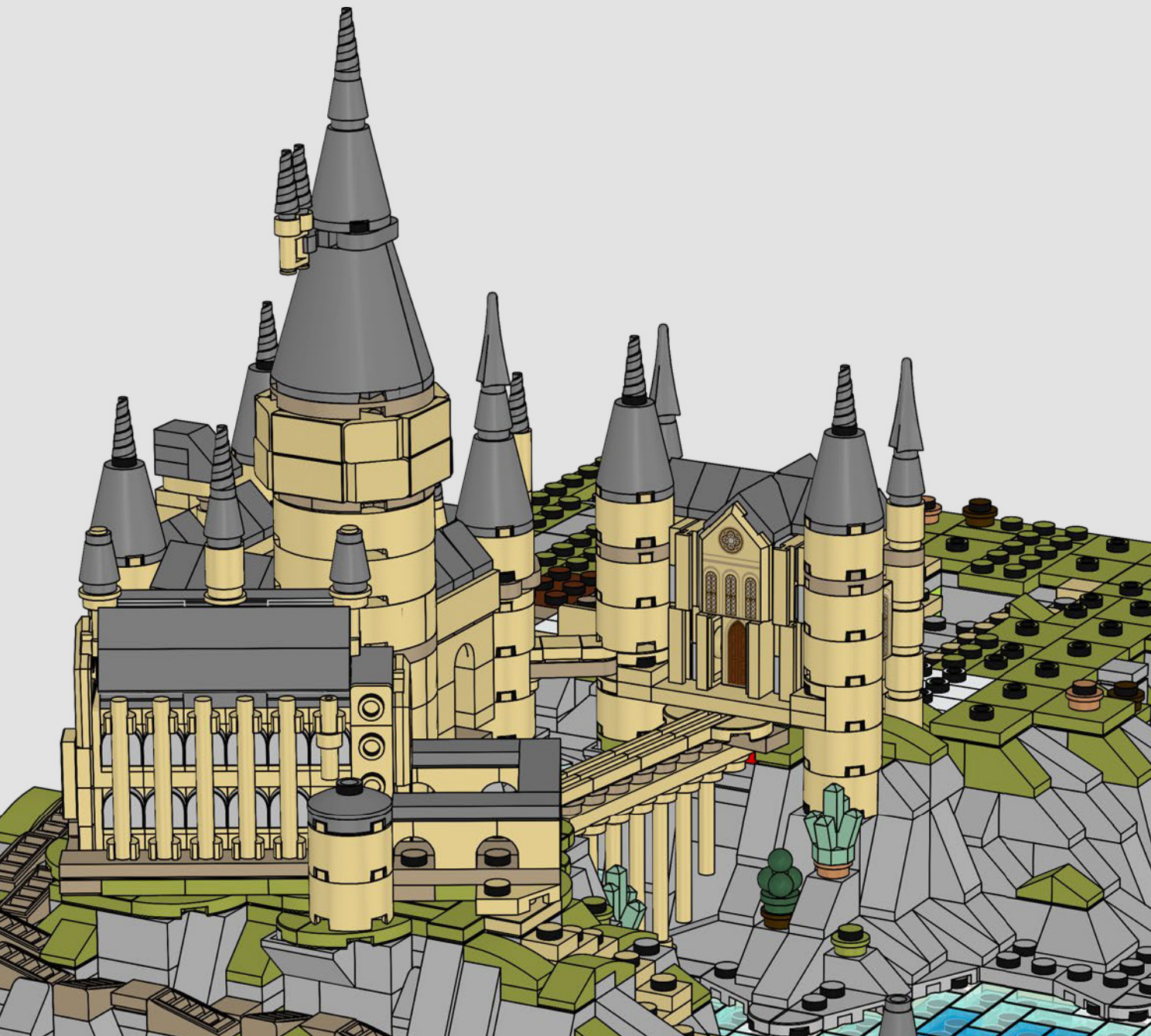

Los baños de chicas se encuentran en esta parte del castillo. Quizá Myrtle la Llorona se pase por aquí mientras construyes. Solo ten cuidado con los troles.







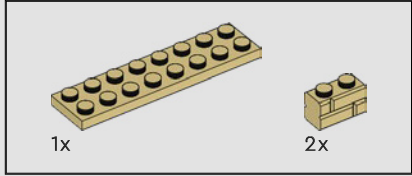
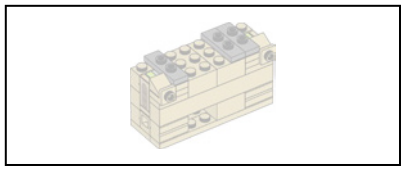

475

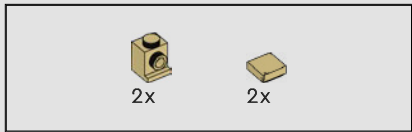
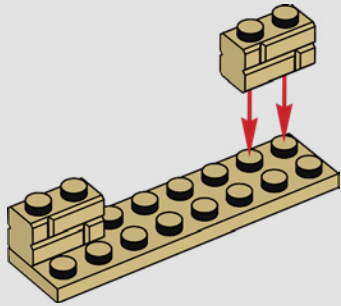

476

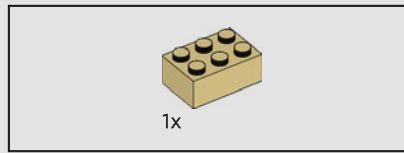
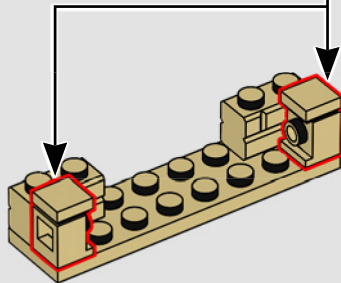
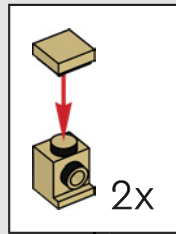

1x

477

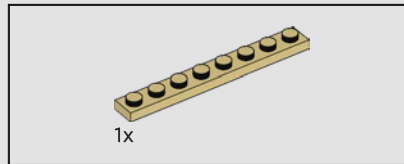
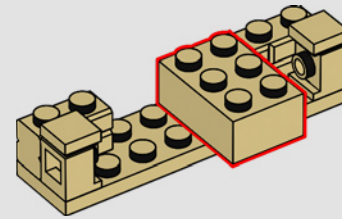

1x

478

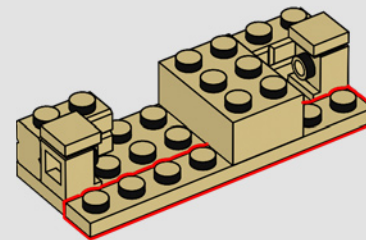



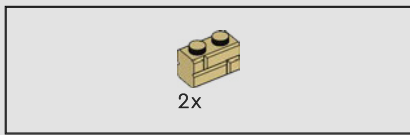

479

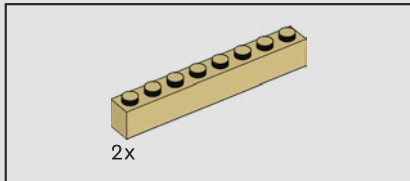
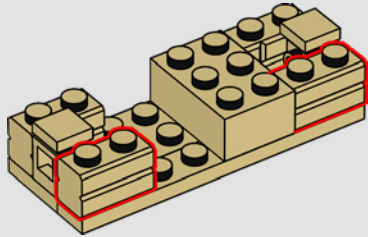

480

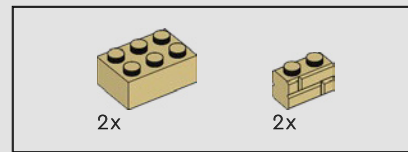
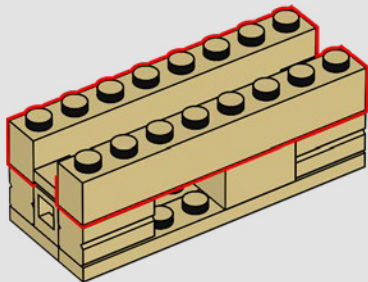

481

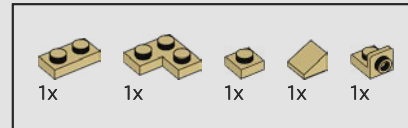
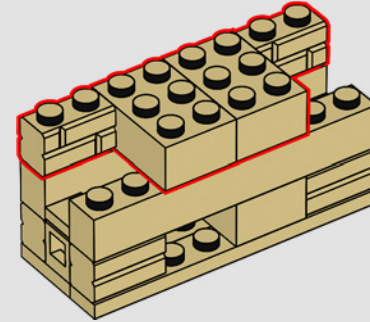

482

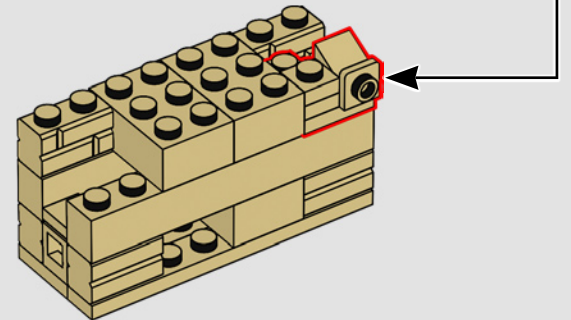
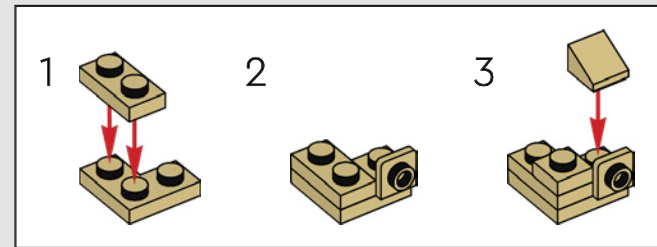

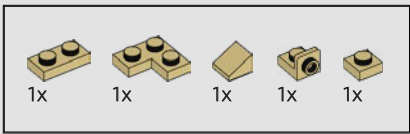

483

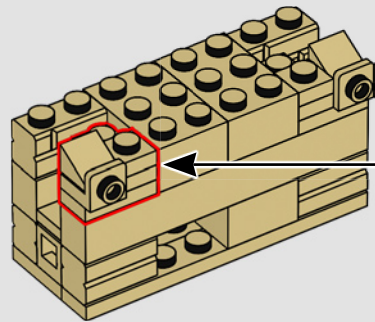
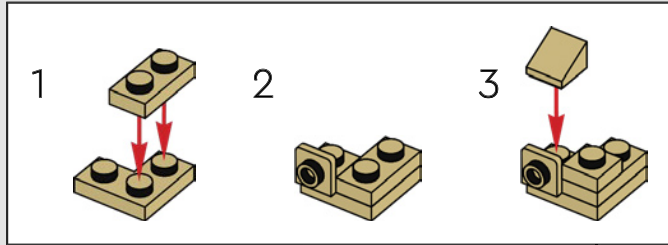

484

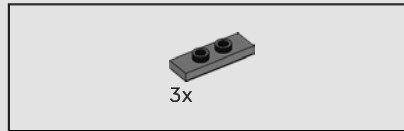
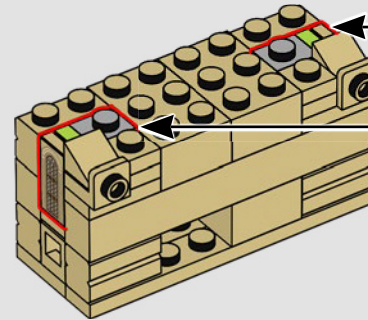
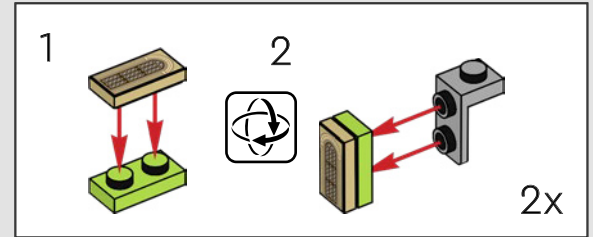

485

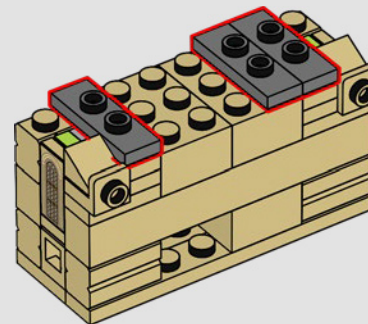



486





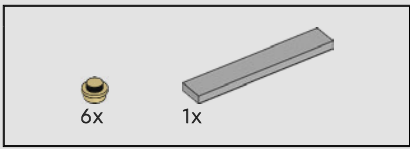

487

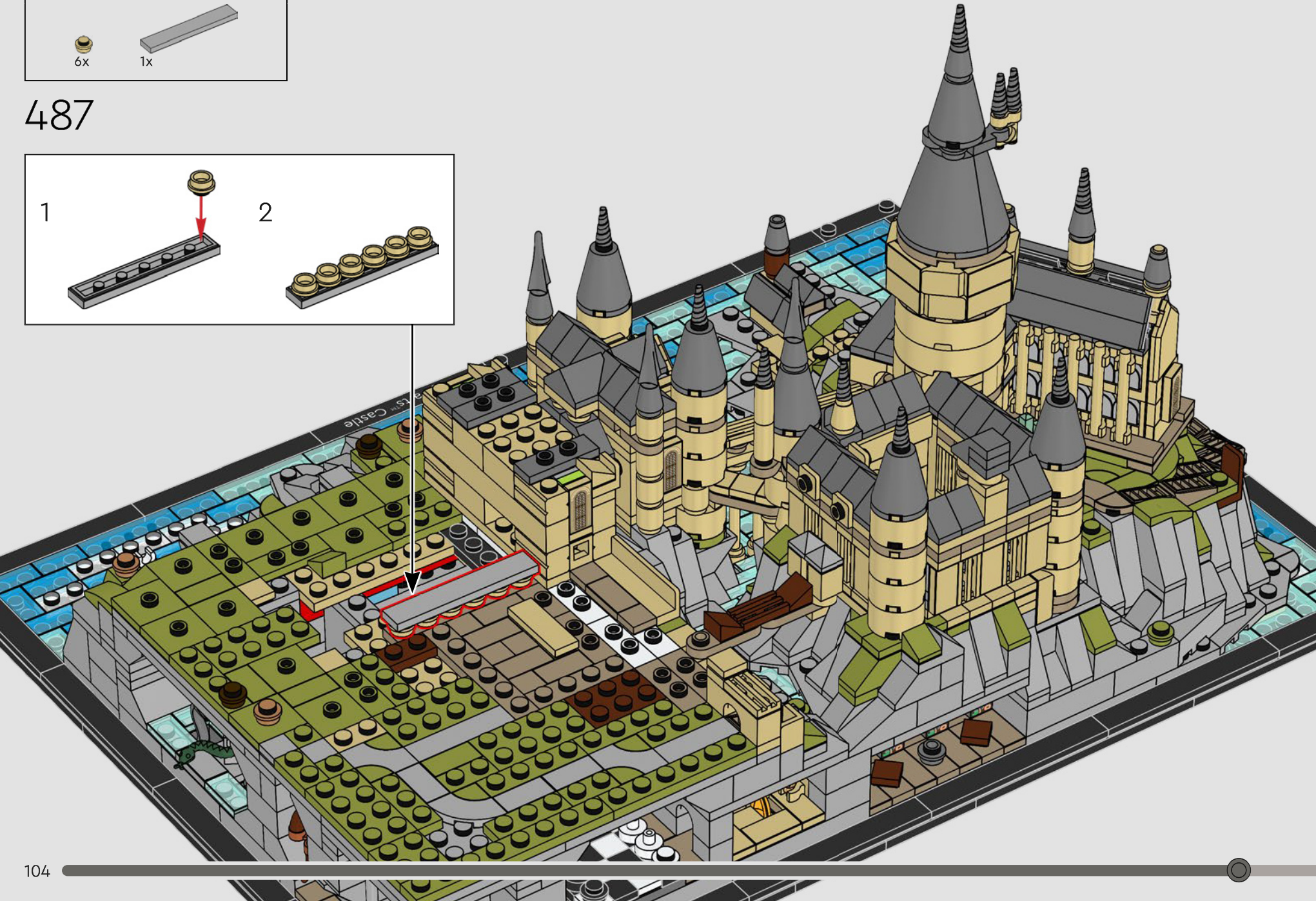
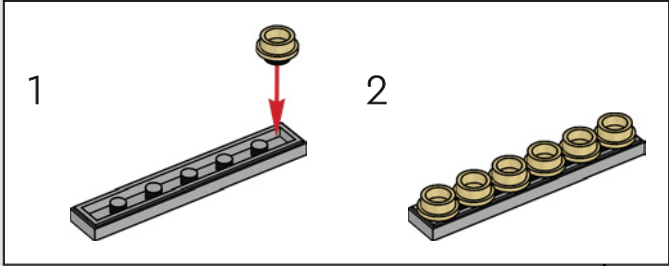



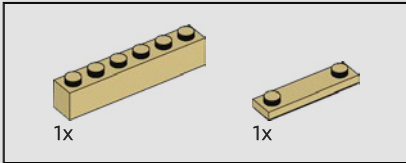
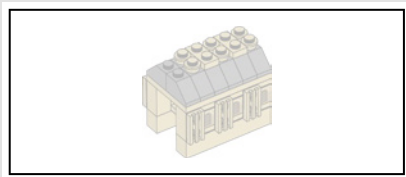

488

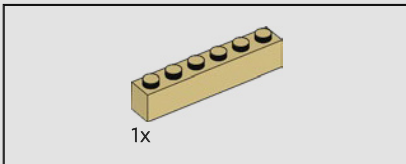
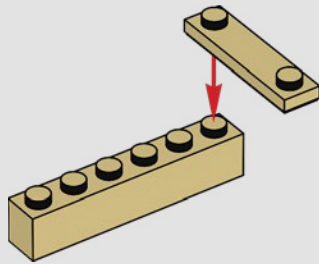

489

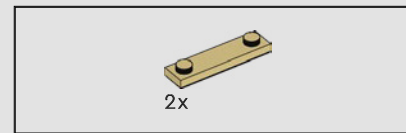
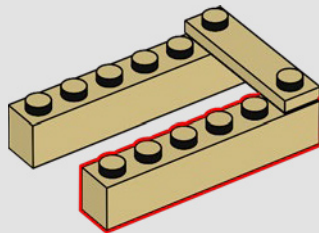

490

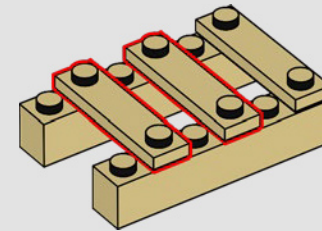

491

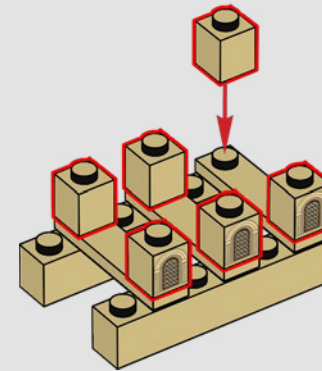

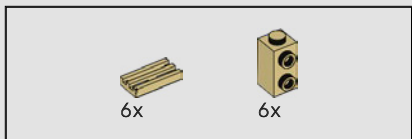

492

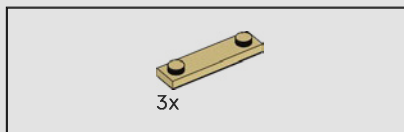
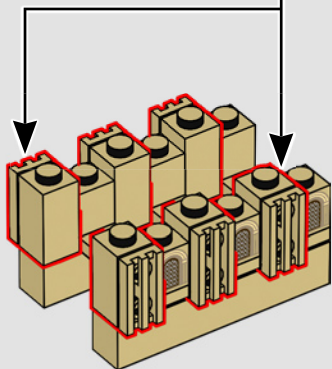
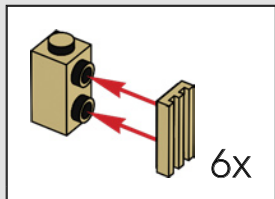

493

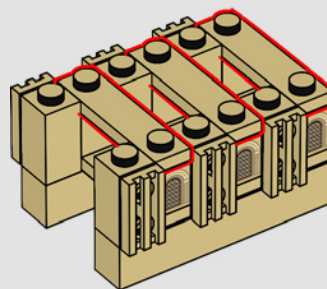



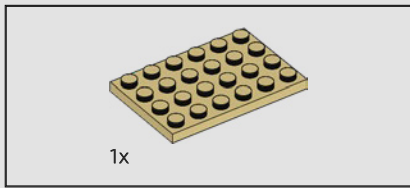

494

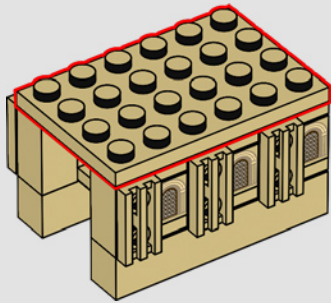

495

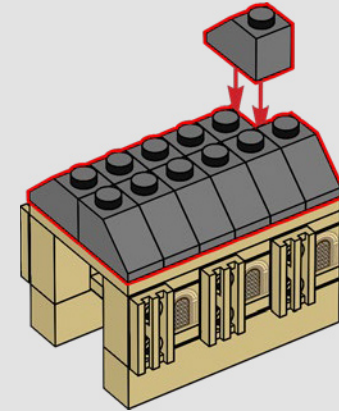

496

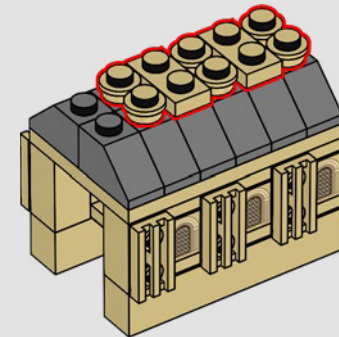

497

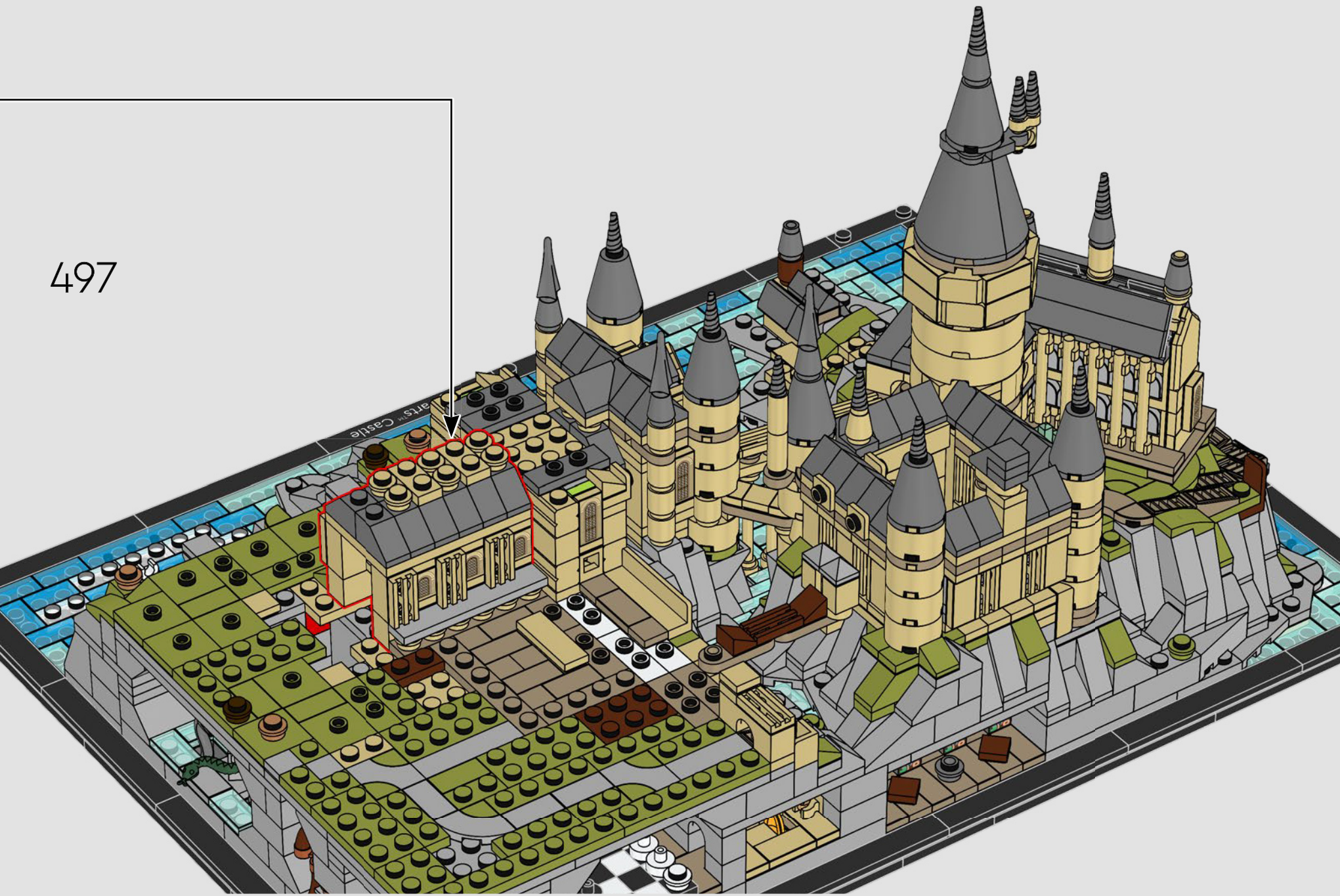



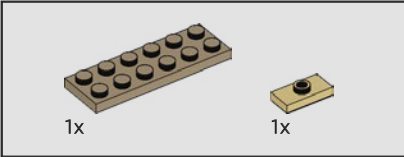
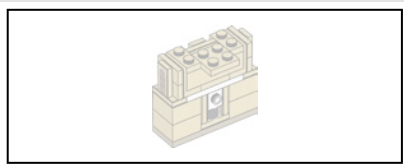

498

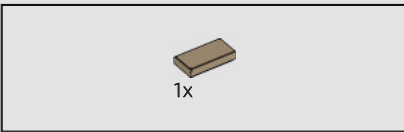
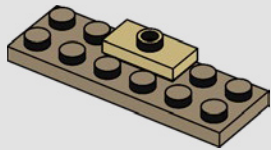

499

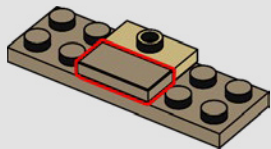

500

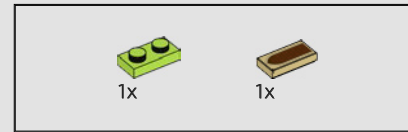
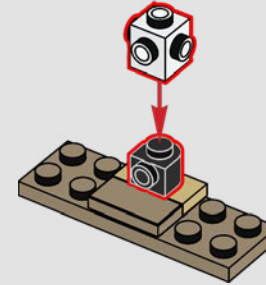

501

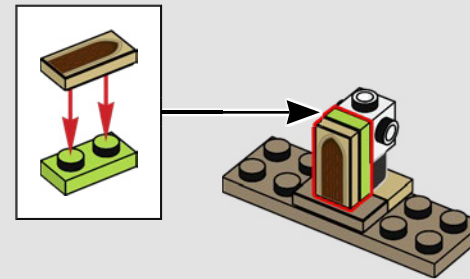

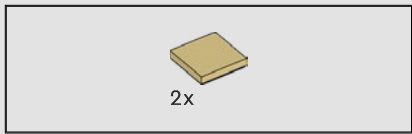

502

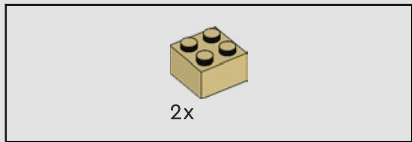
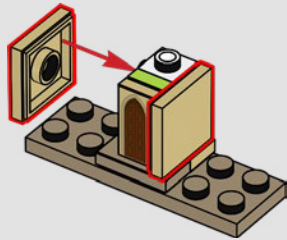

503

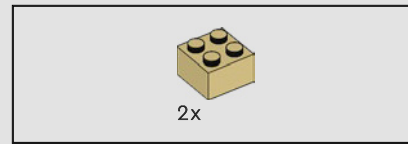
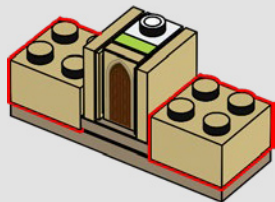

504

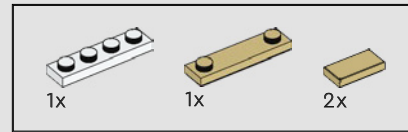
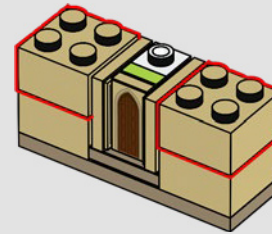

505

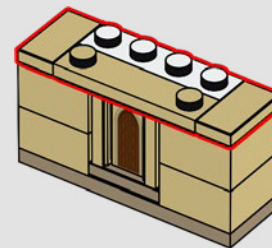



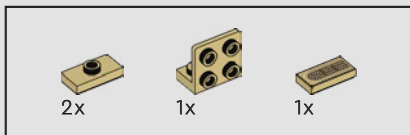

506

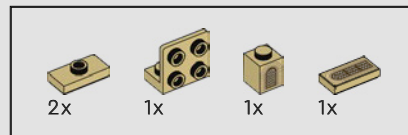
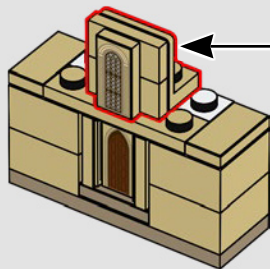
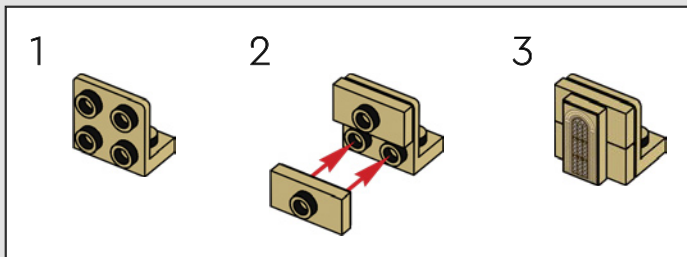

507

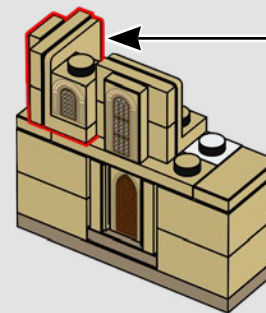
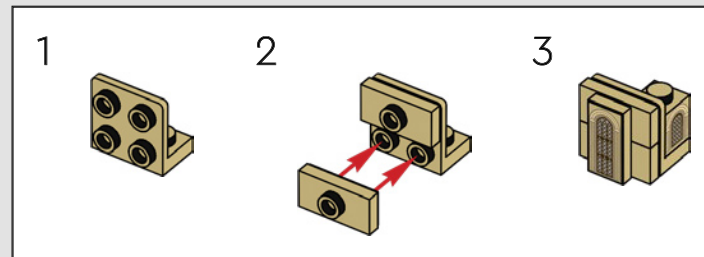

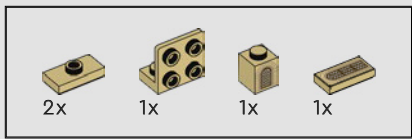

508

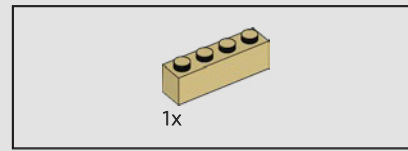
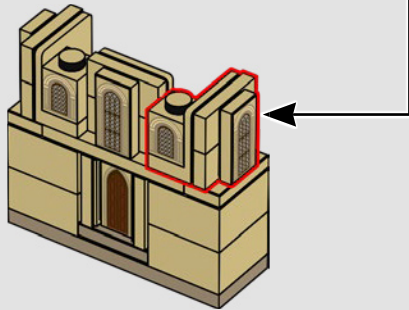
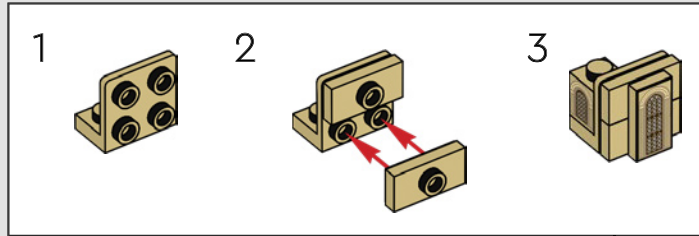

509

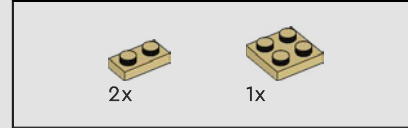
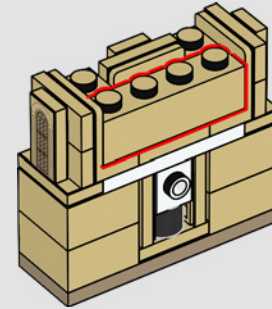
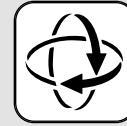

510

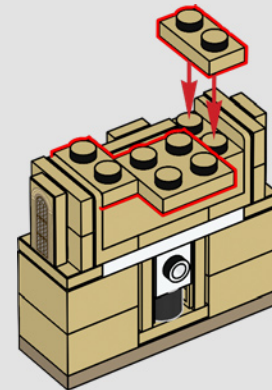



511





2x



2x



2x



2x



2x



2x



2x



2x



2x

512

1

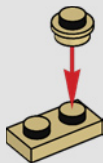

2

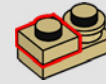

3

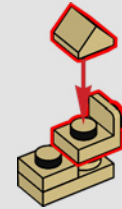

4

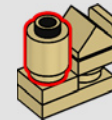

5

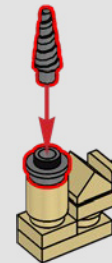

2x







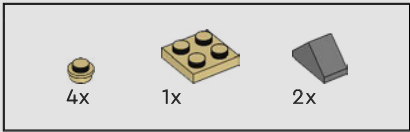

513

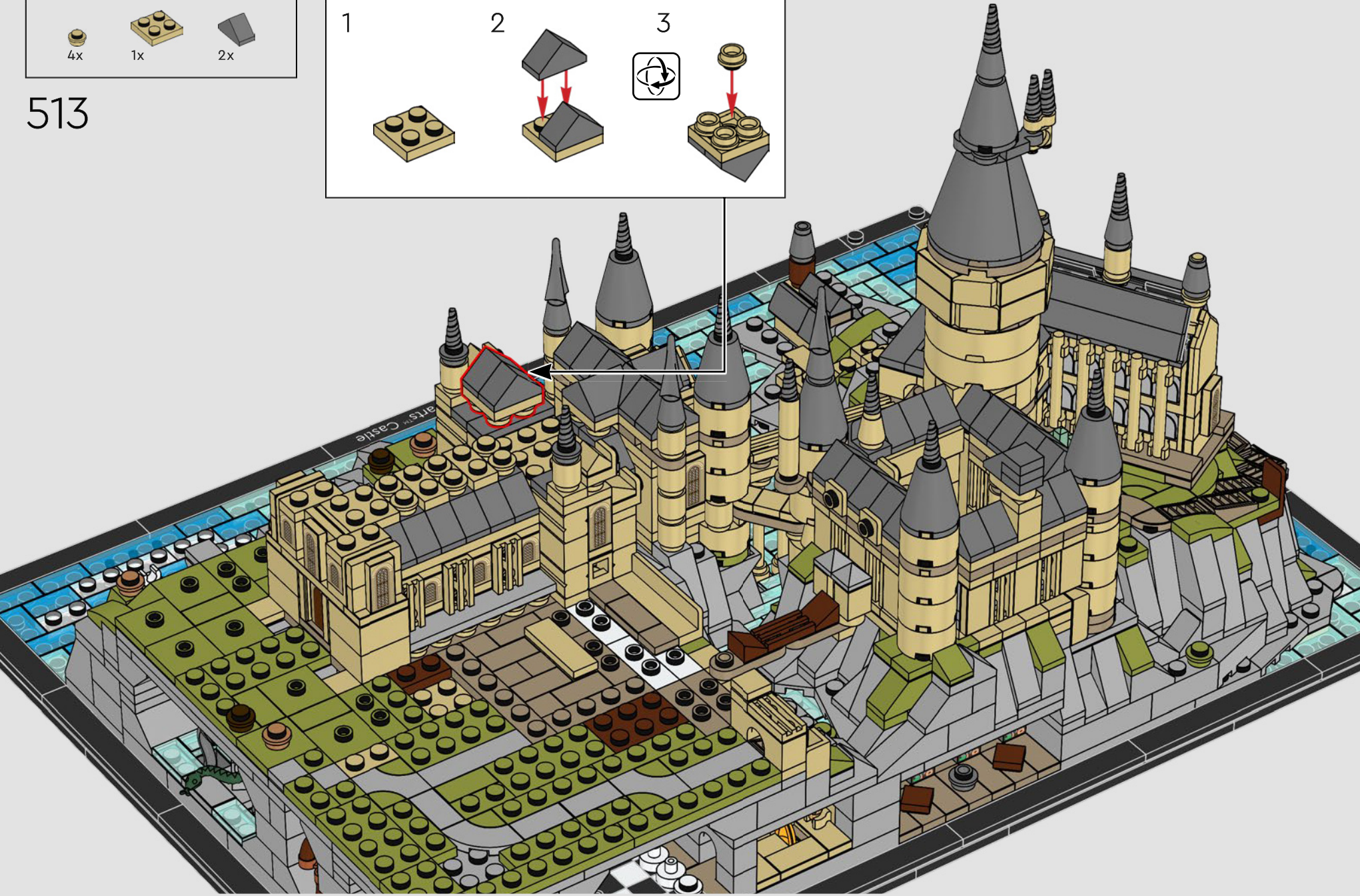
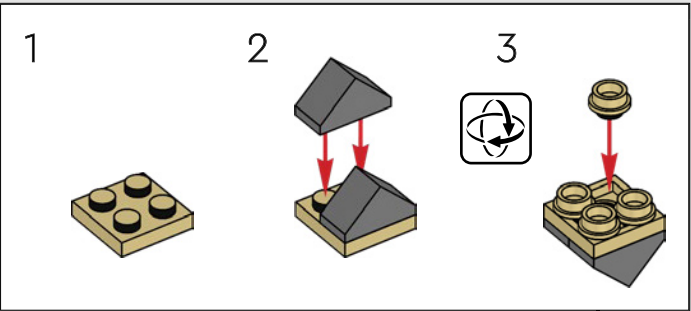



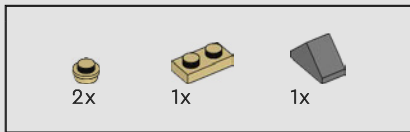

514

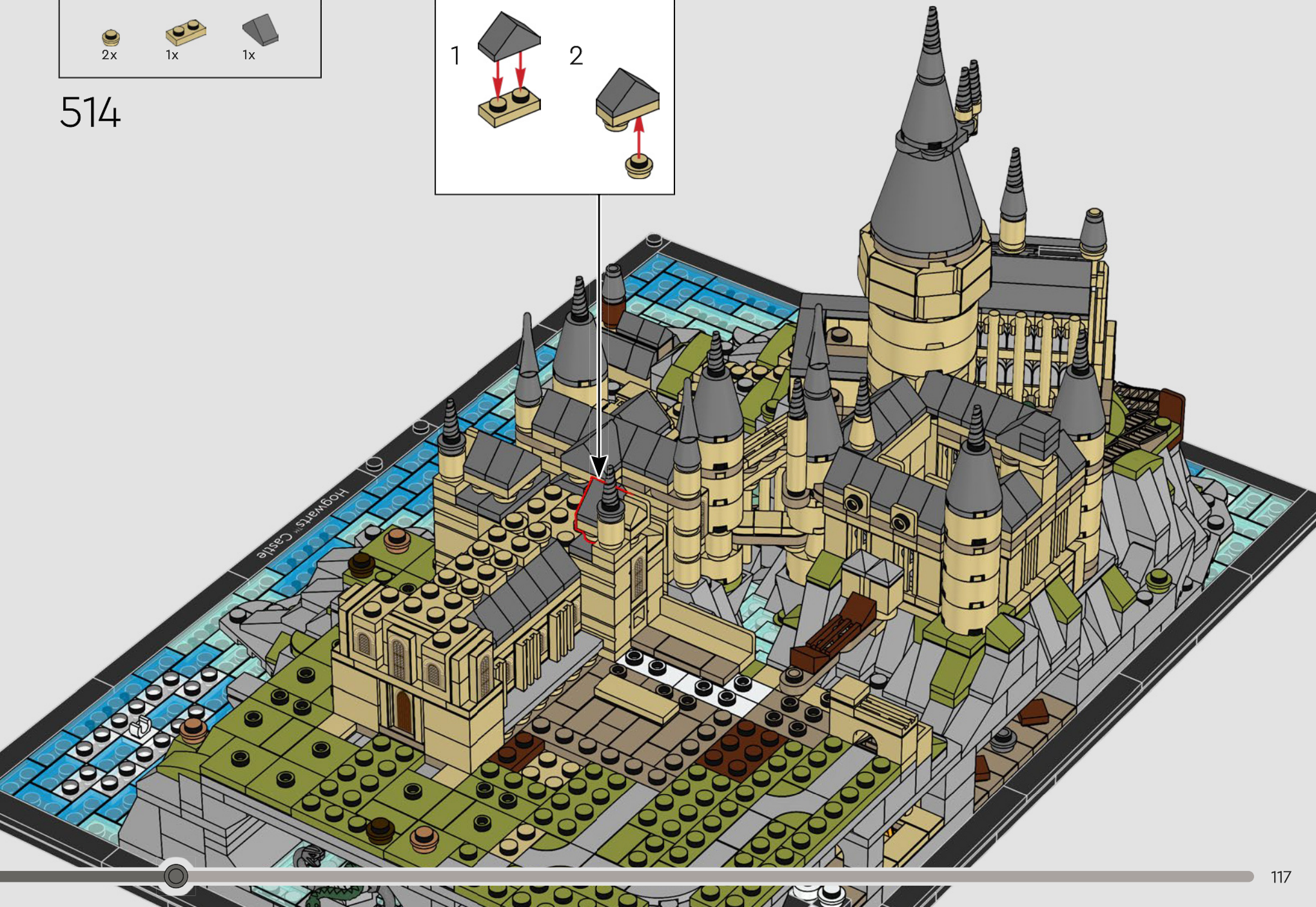
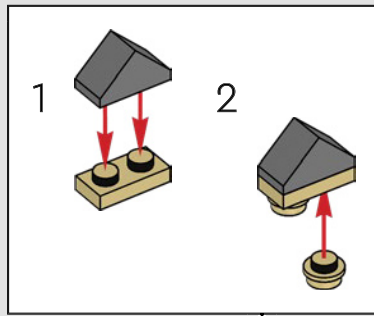

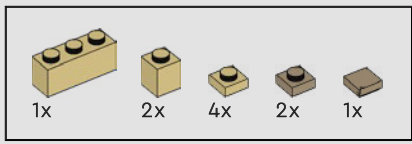

515

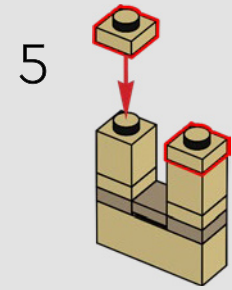
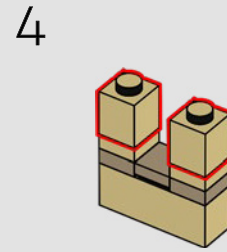
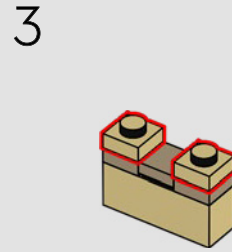
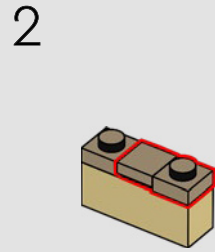
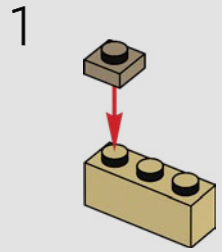



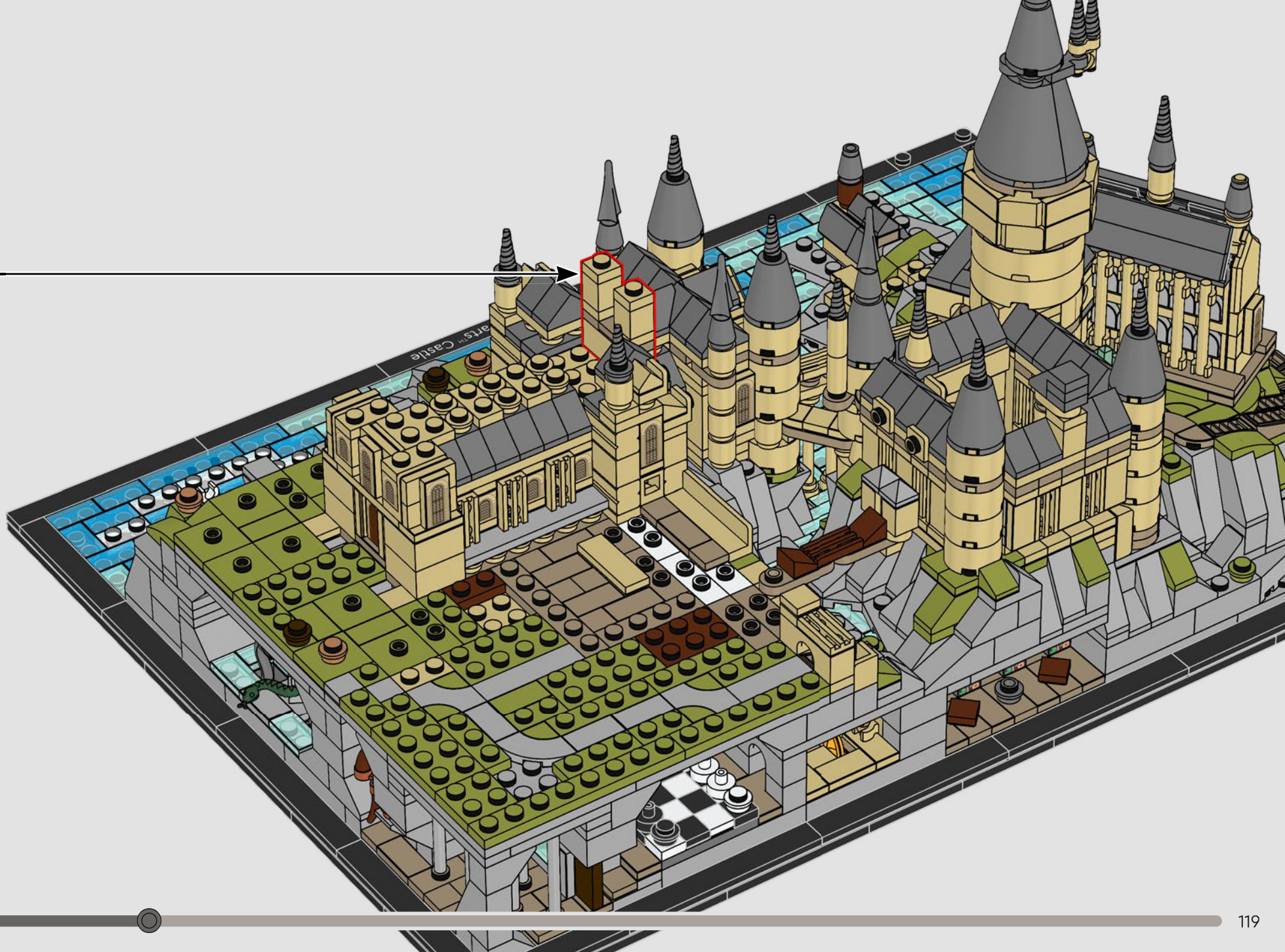

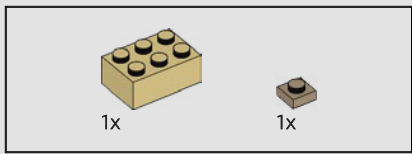

516

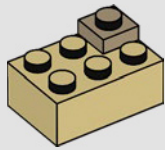

517

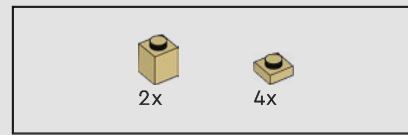
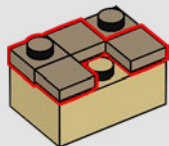

518

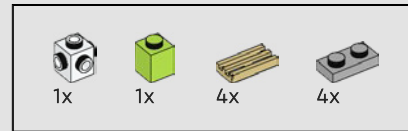
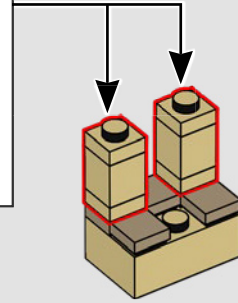
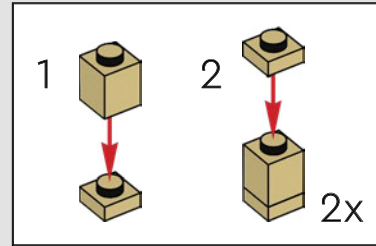

519

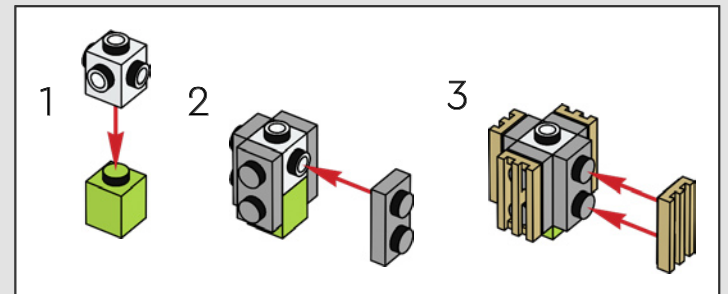



520

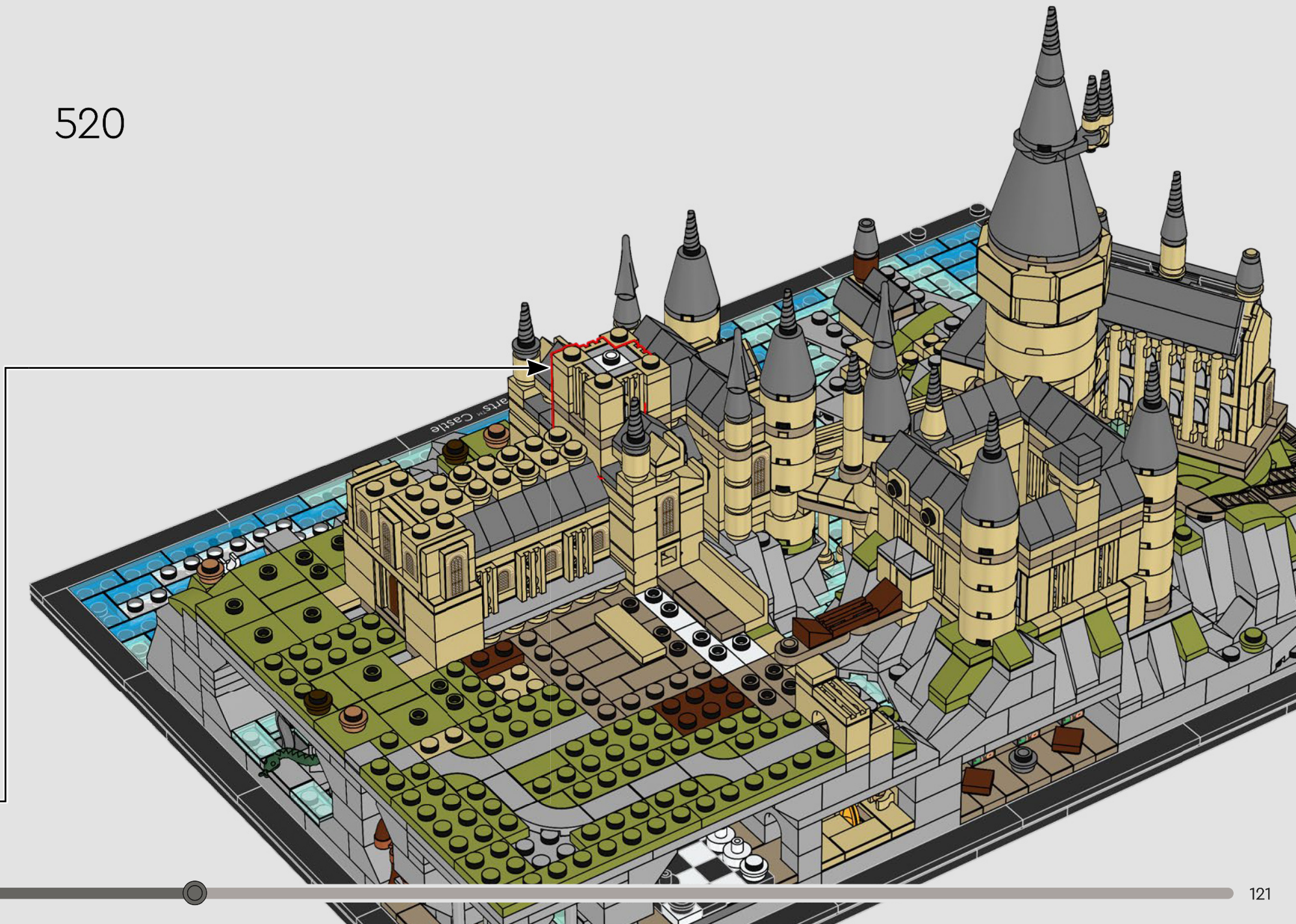



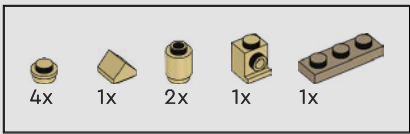

521

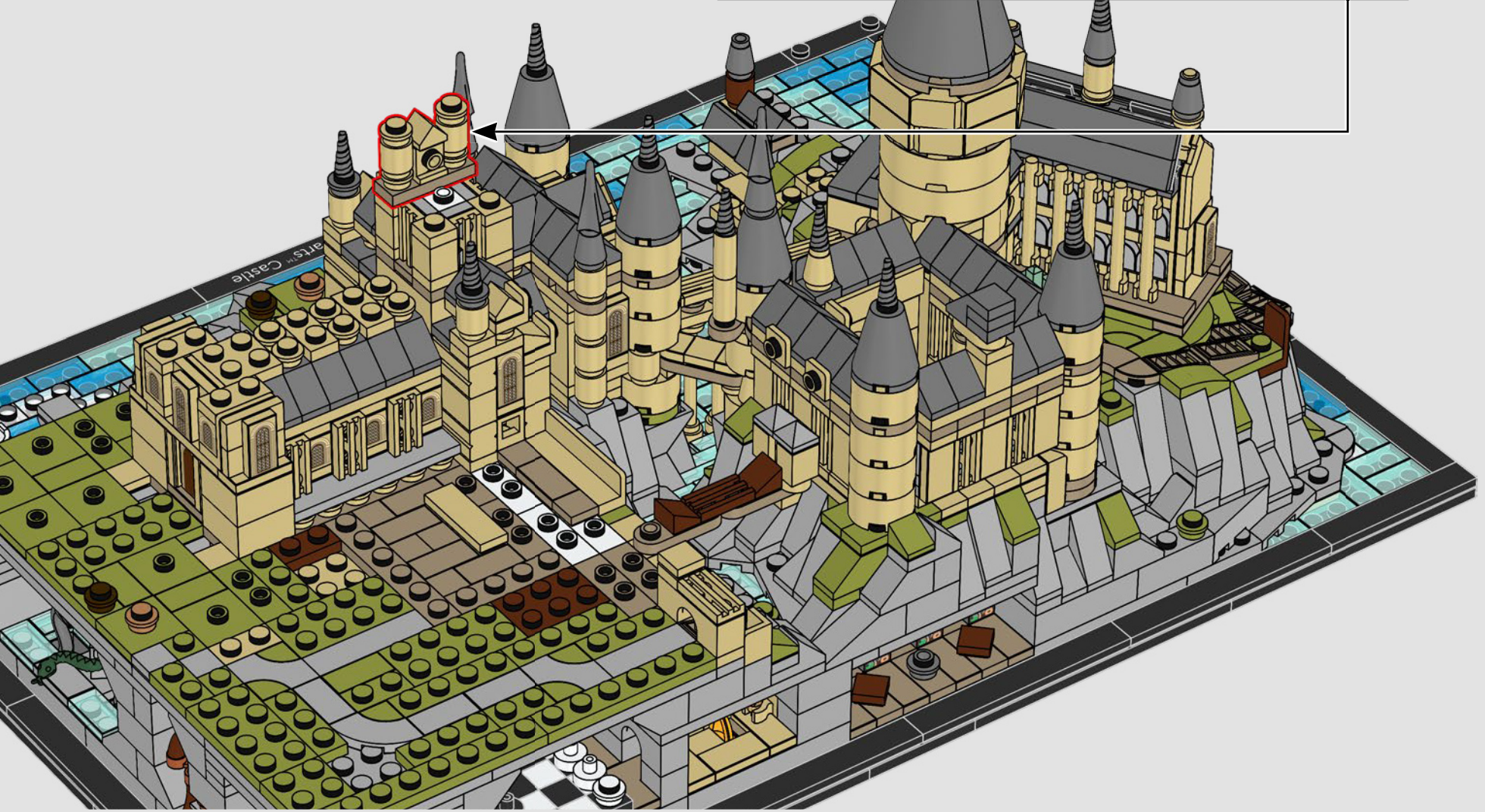
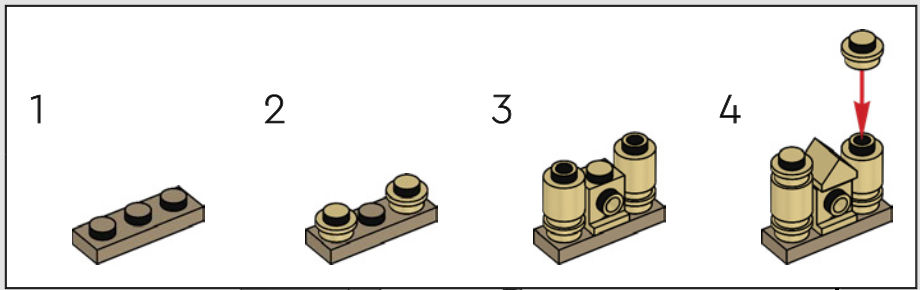



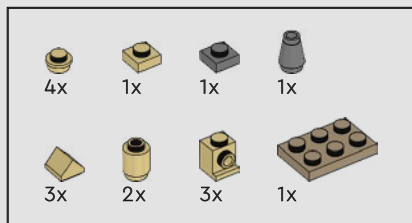

522

1

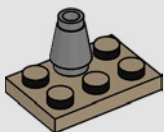

2

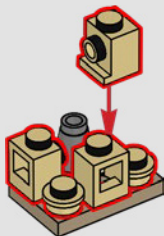

3

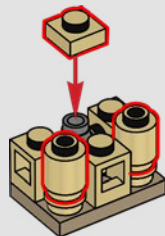

4

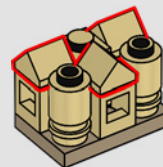

5

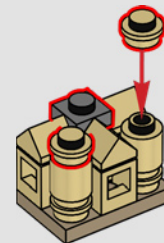

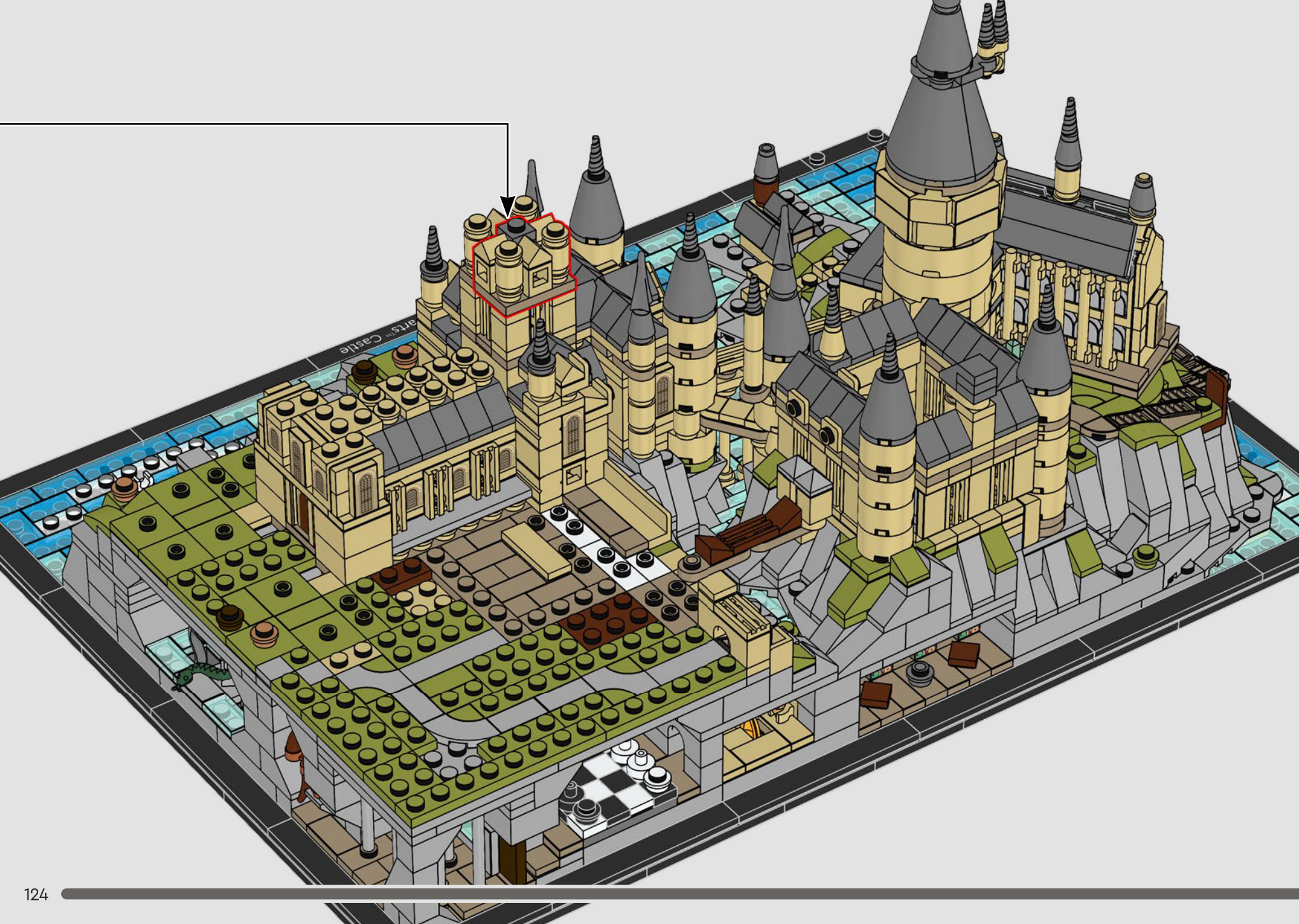



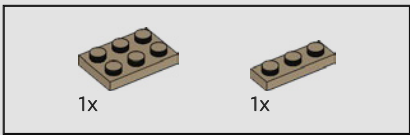

523





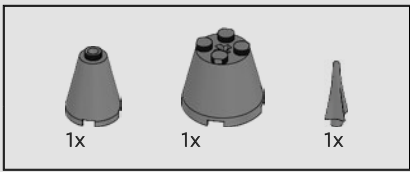

524

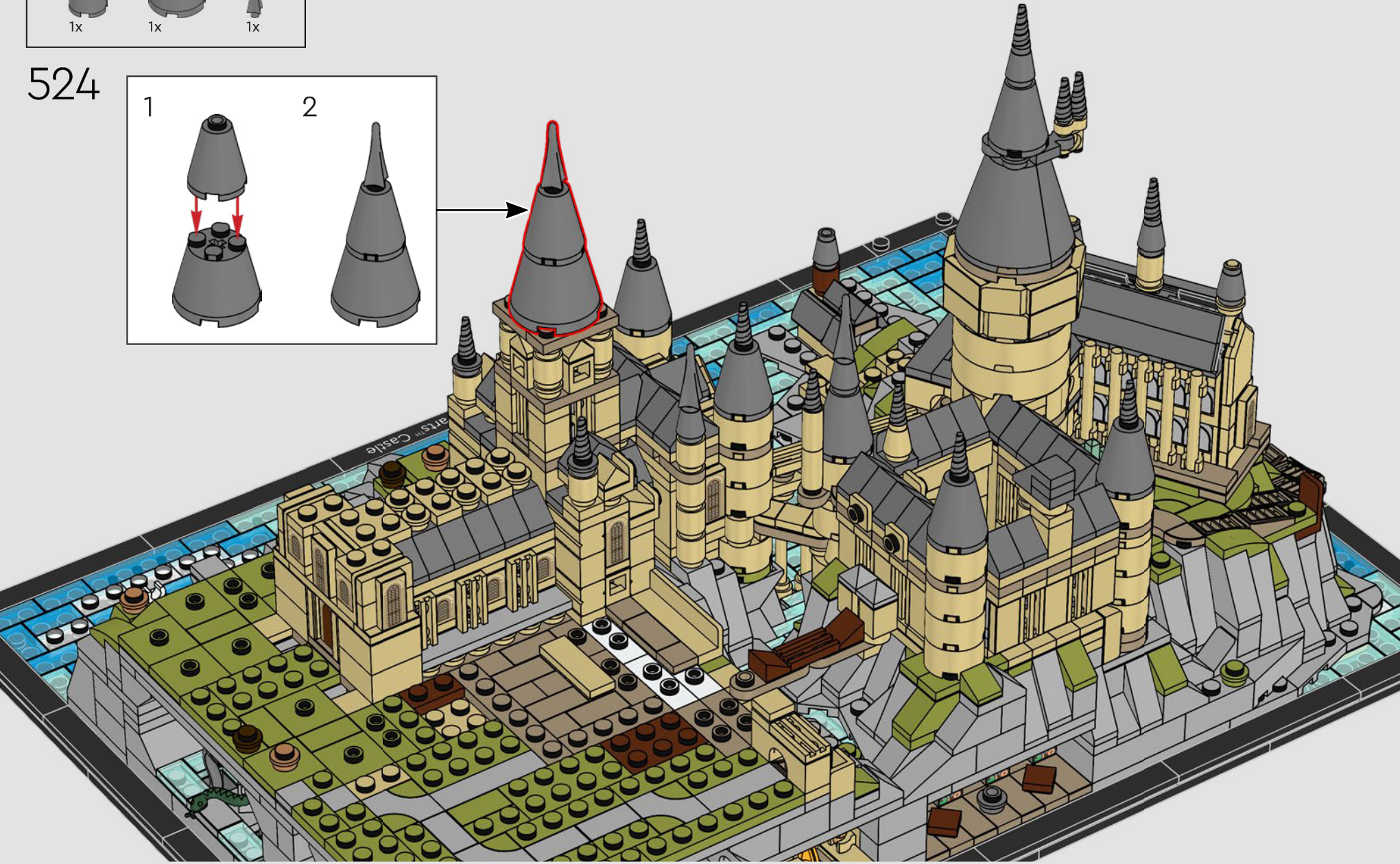
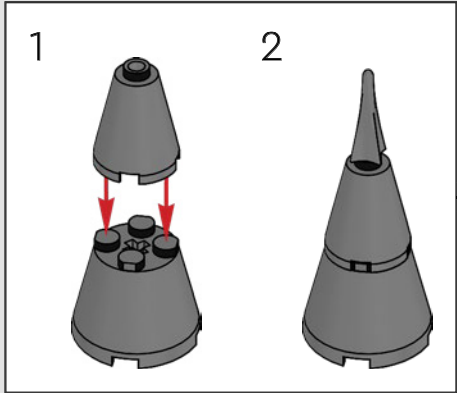



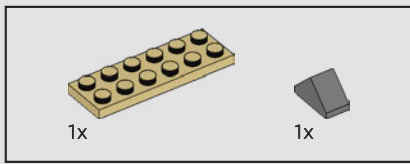

525

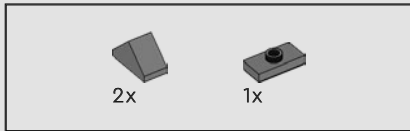
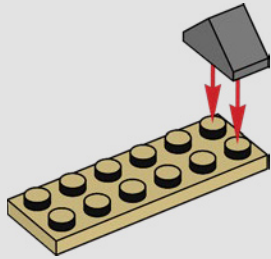

526

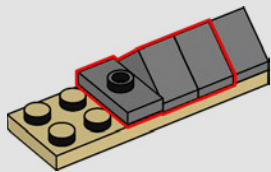

527

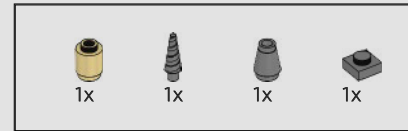
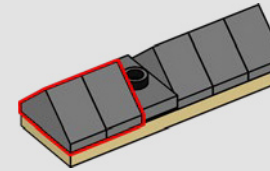

528

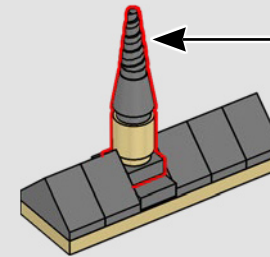
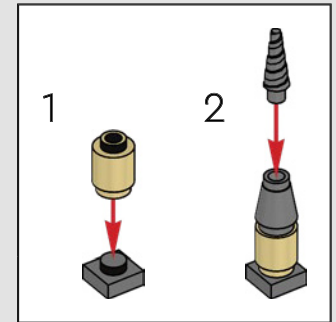

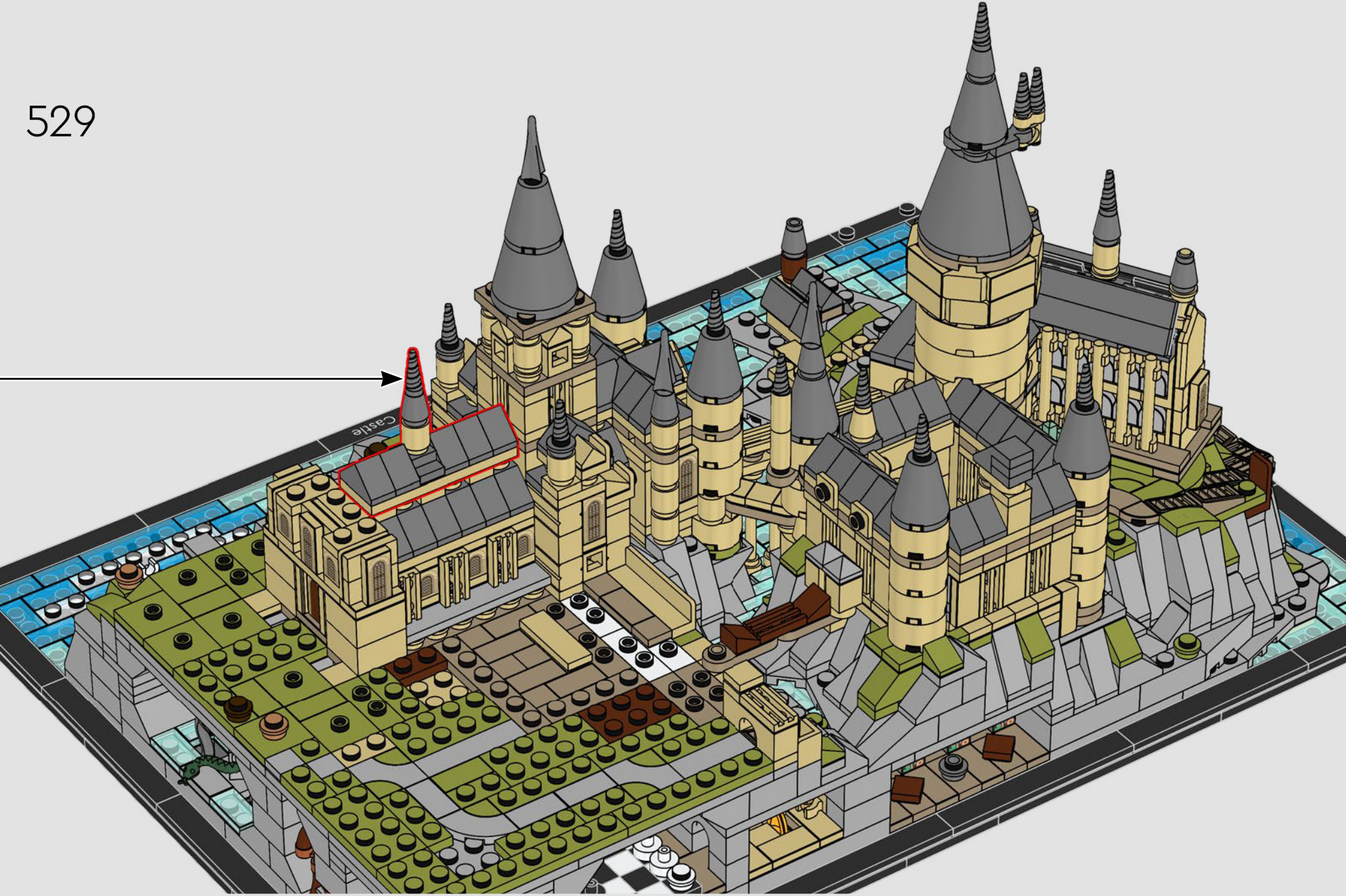



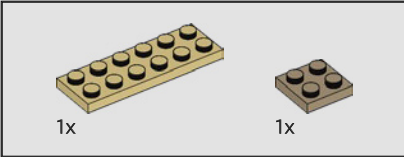
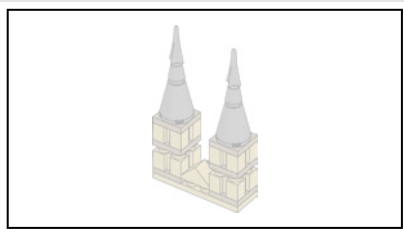

530

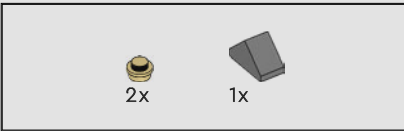
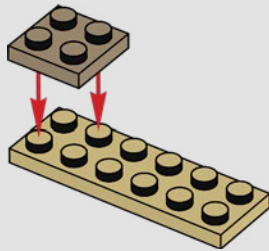

531

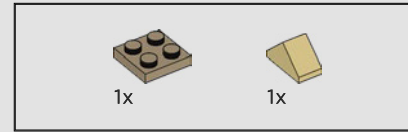
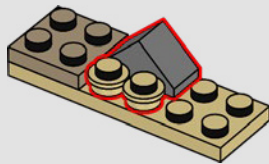

532

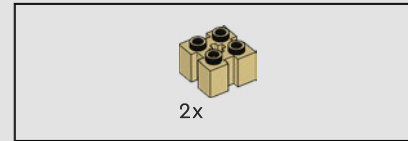
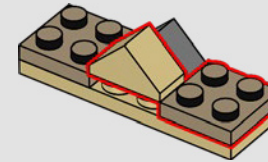

533

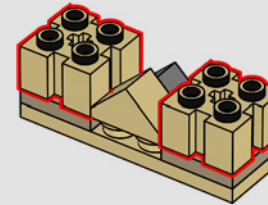



8x

534

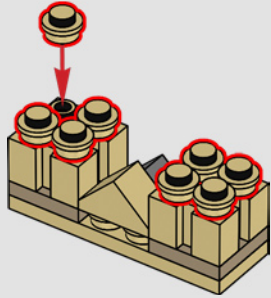

2x

535

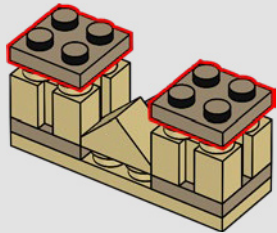

2x

536

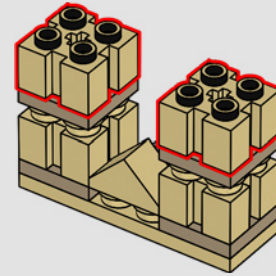

2x

537

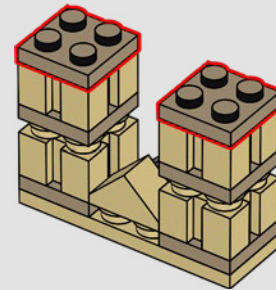



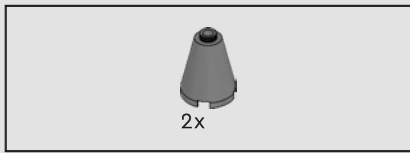

538

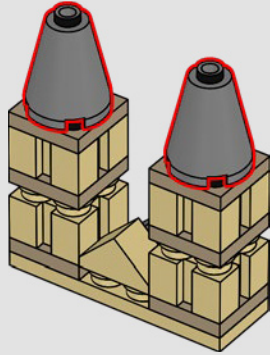

539

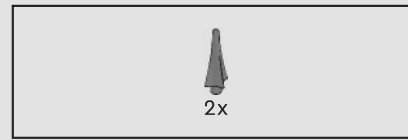
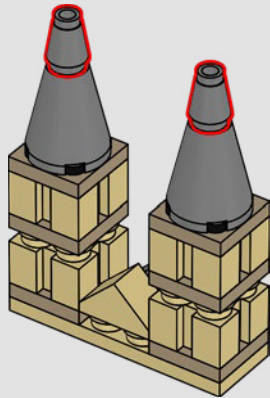

540

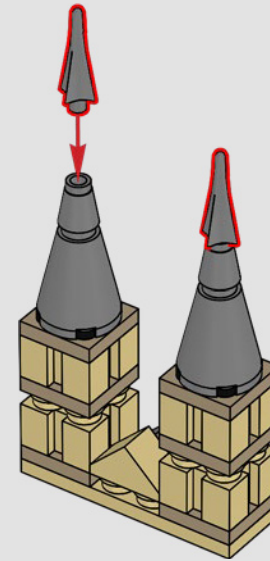

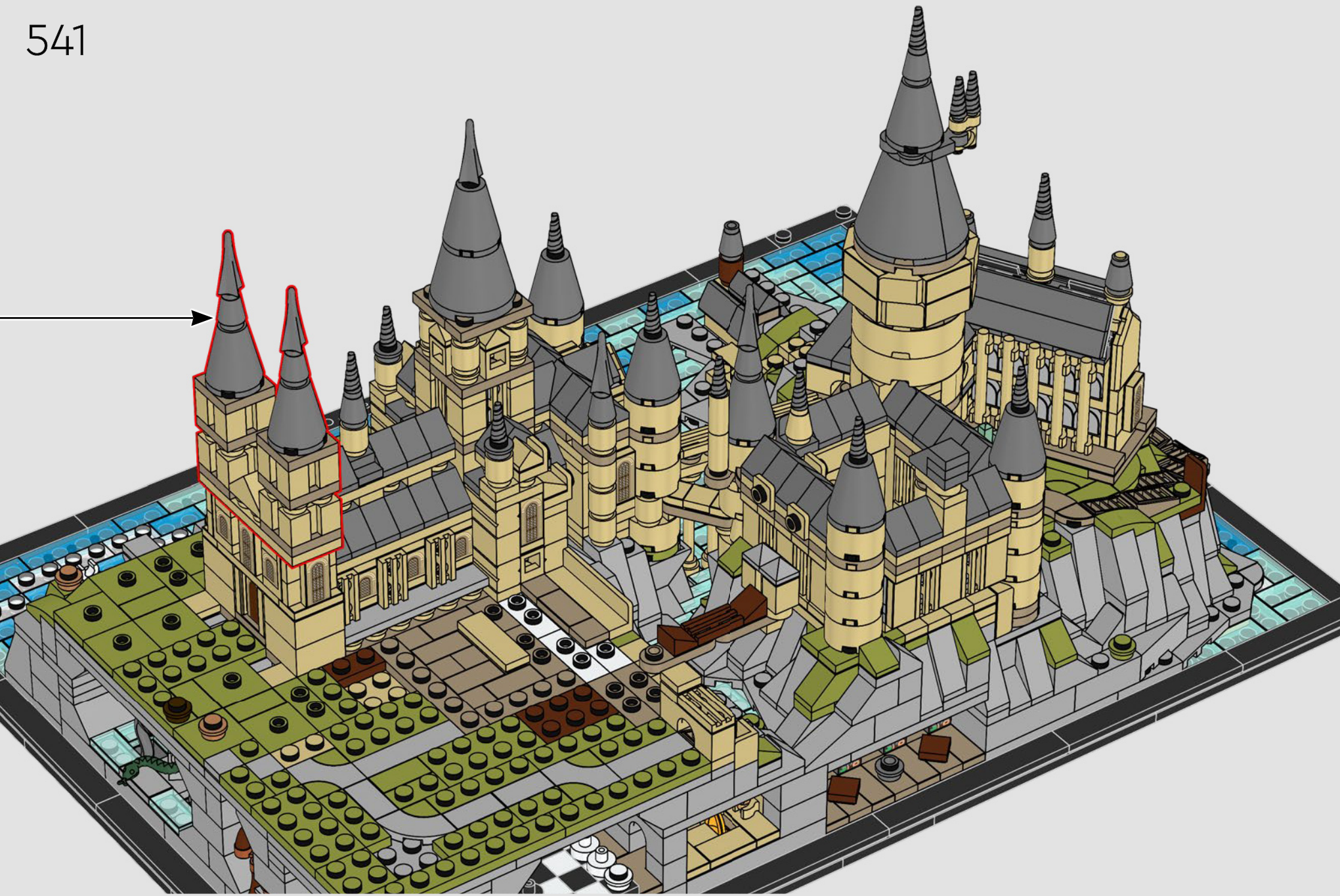



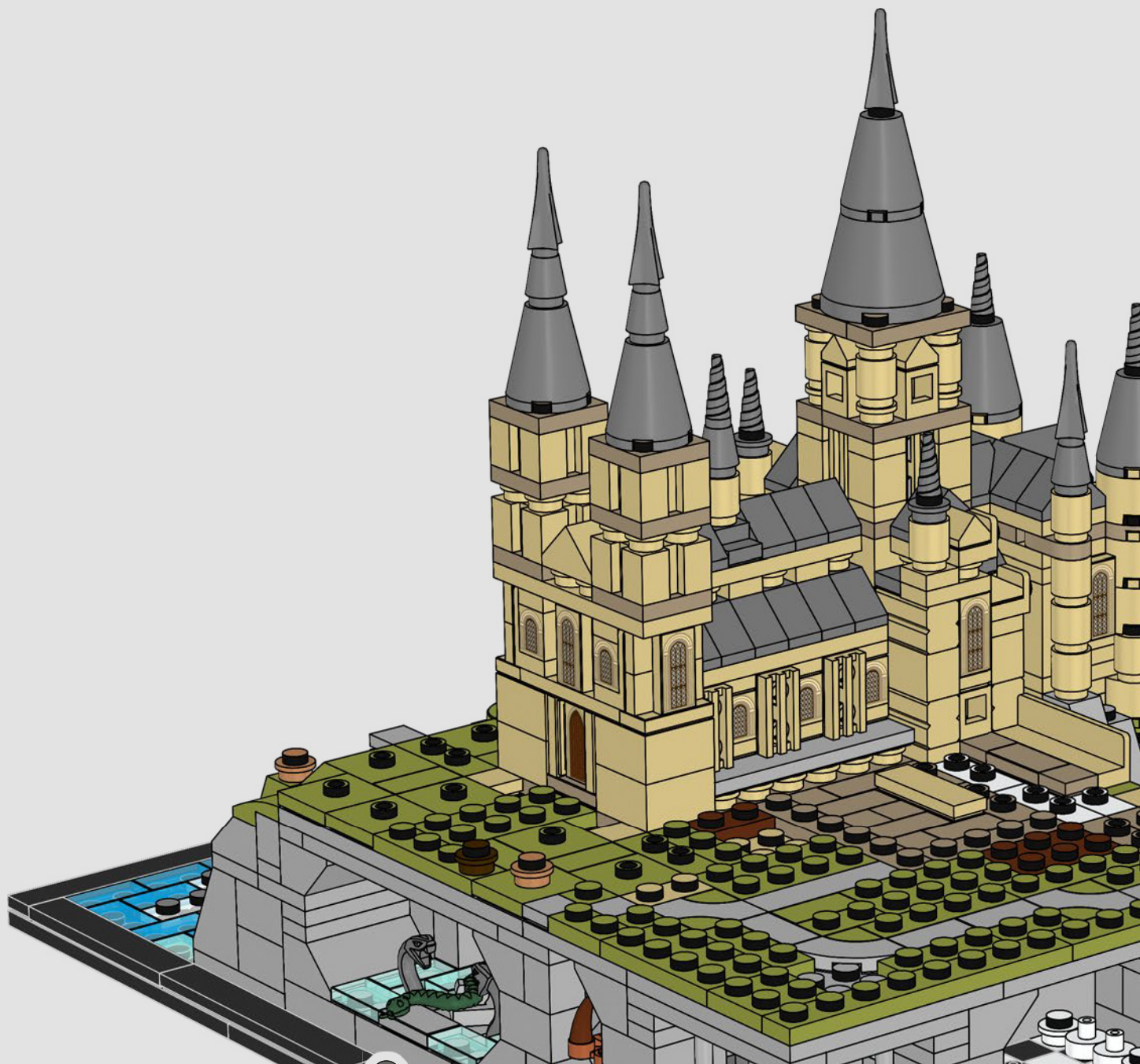

No importa cuáles sean las asignaturas favoritas de un alumno de Hogwarts™, lo más probable es que pase gran parte de su tiempo en el ala este, donde se encuentran muchas de las aulas.





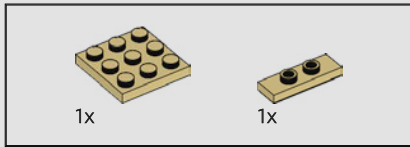
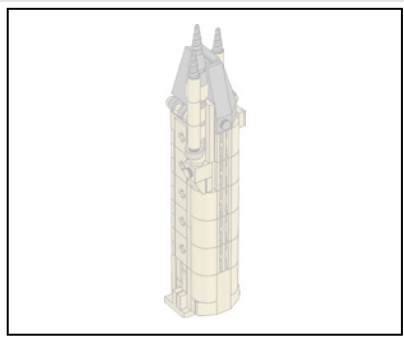

542

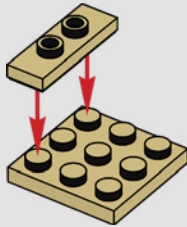

543

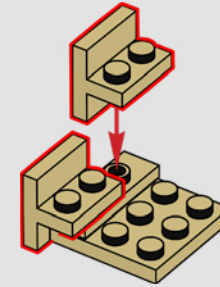

544

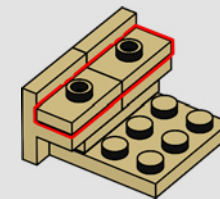



2x

545

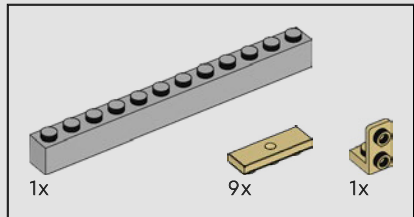
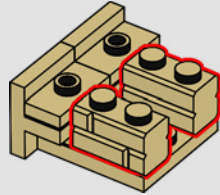

546

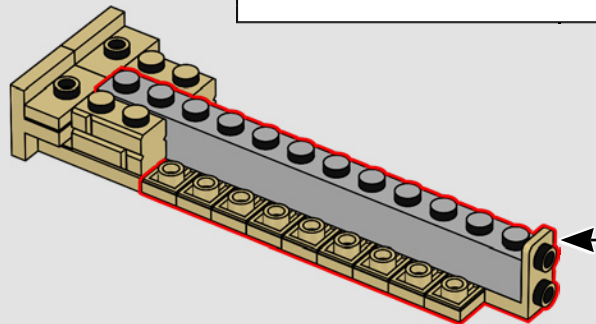
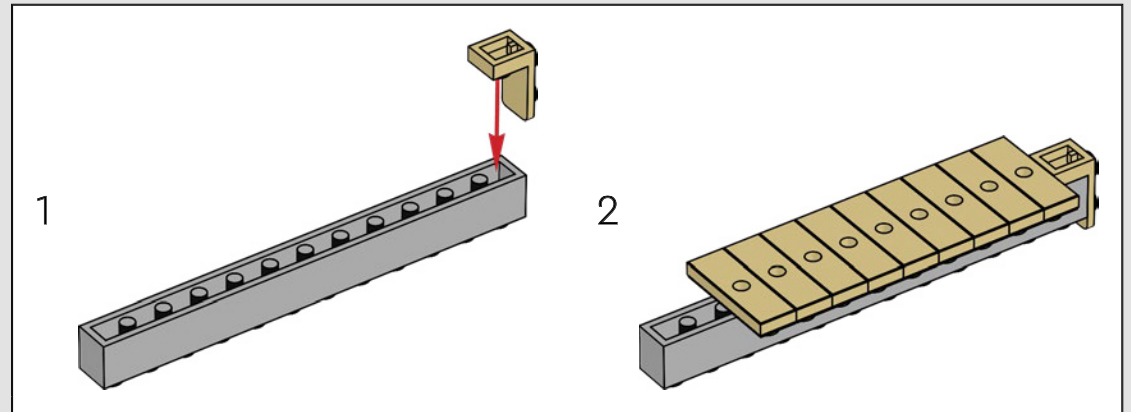



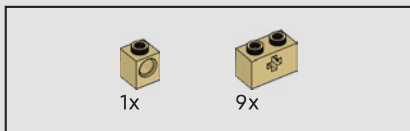

547

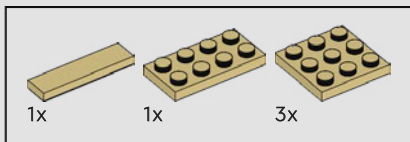
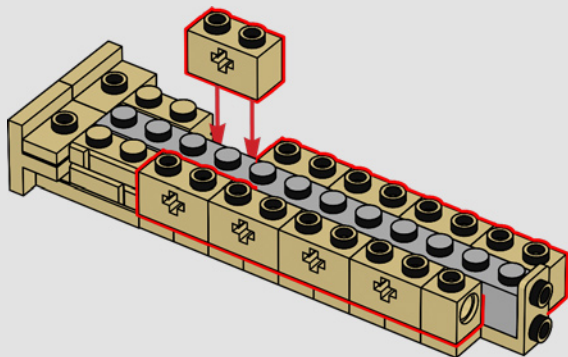

548

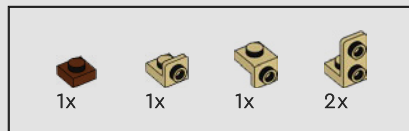
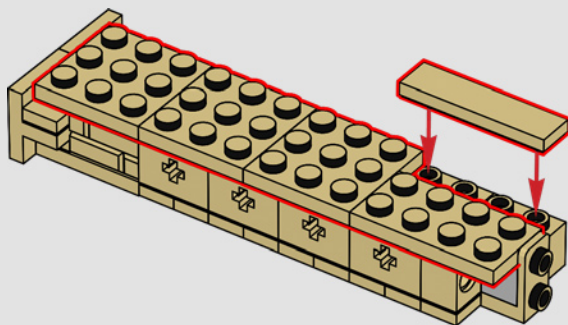

549

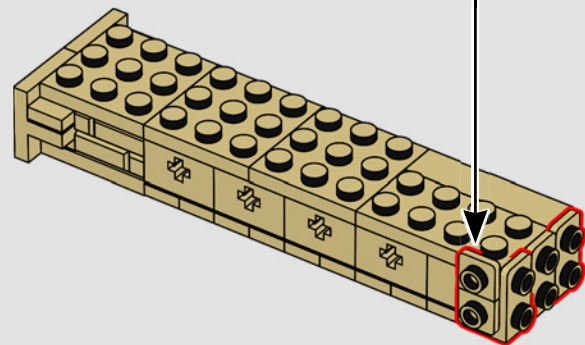
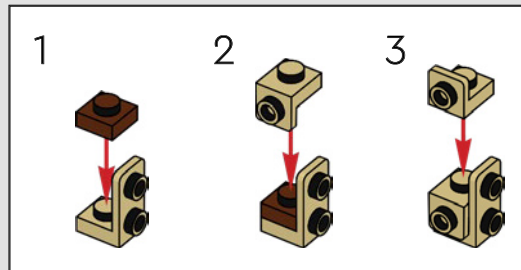

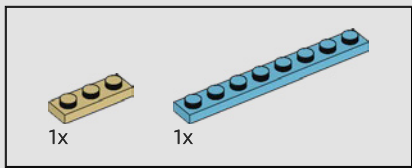

550

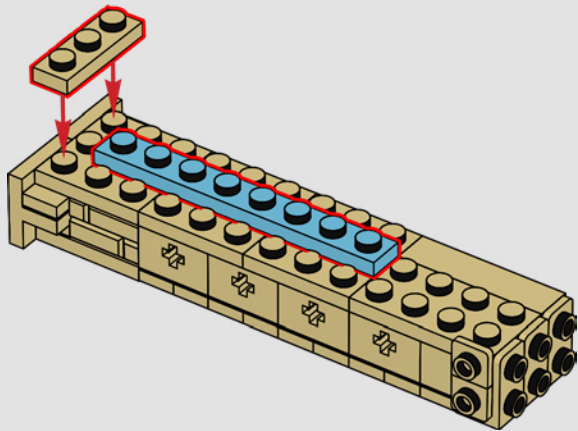

551

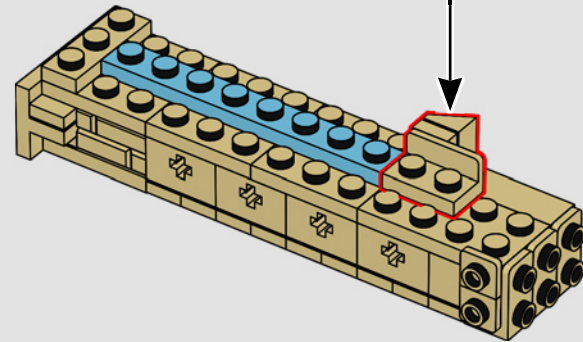
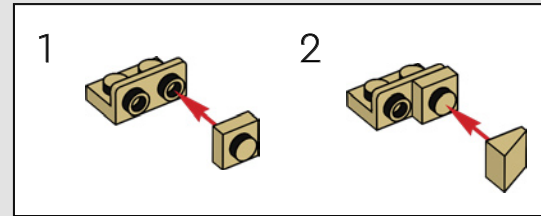



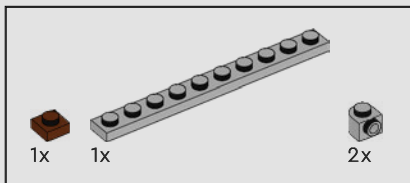

552

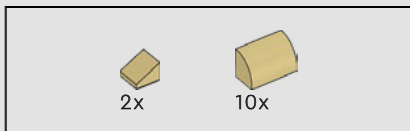
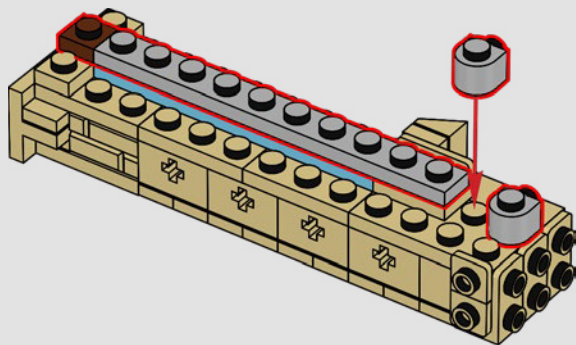

553

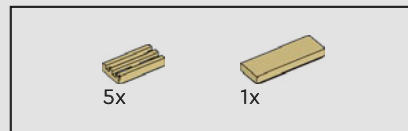
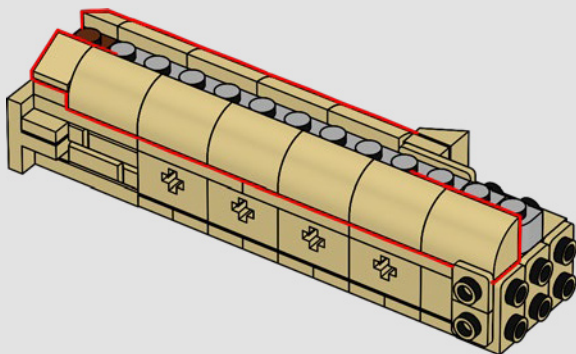

554

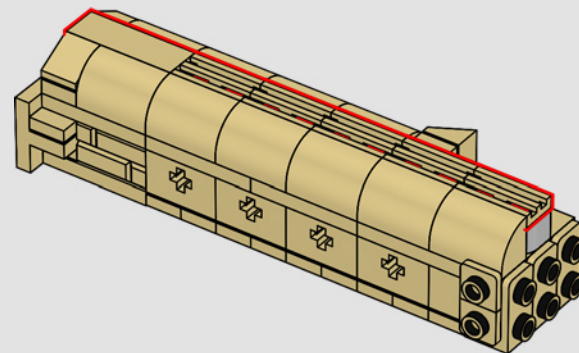



1x

555

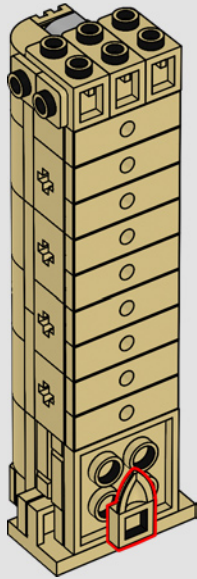

2x

556

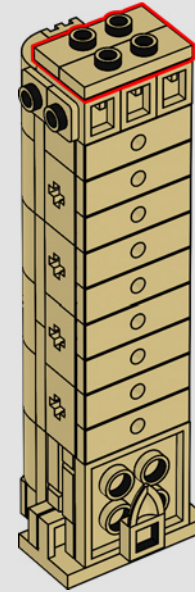



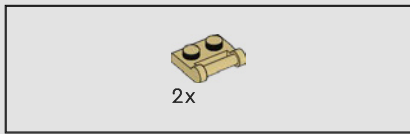

557

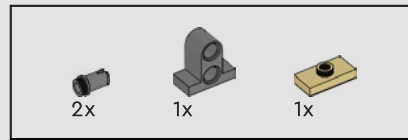
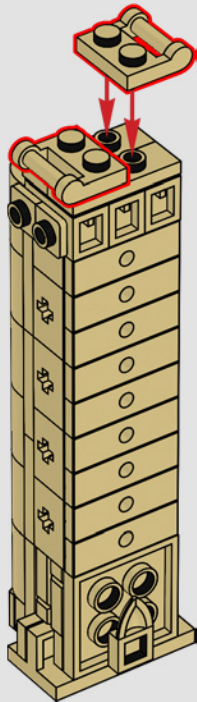

558

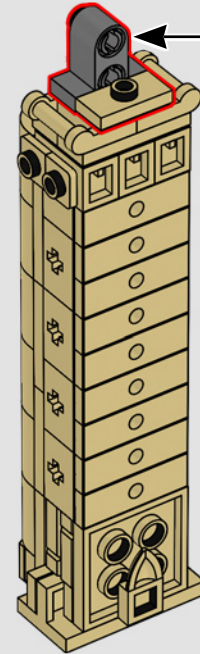
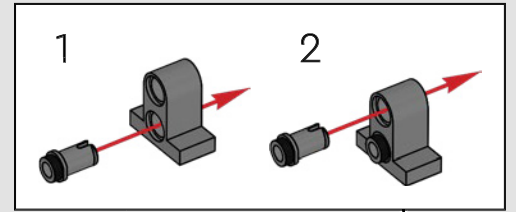



559

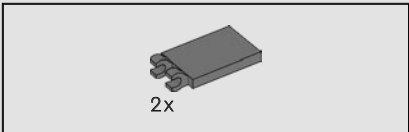

560

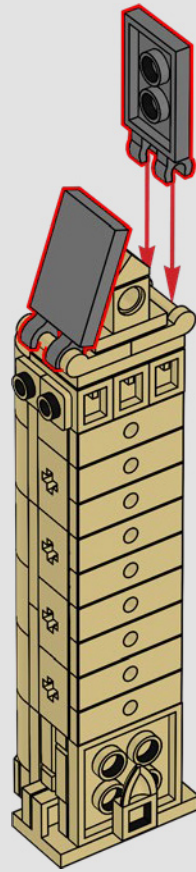





561

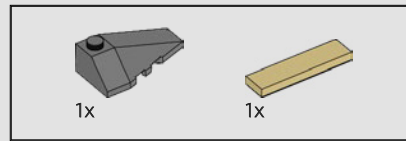
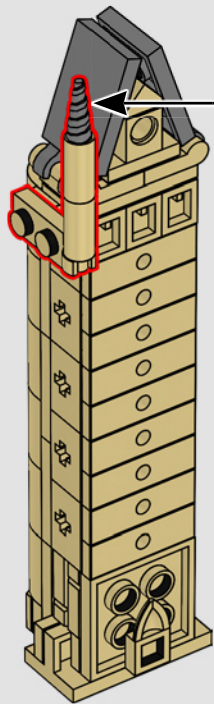
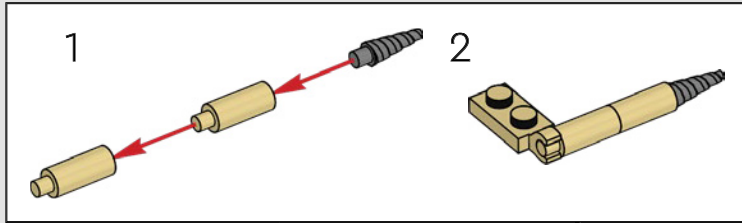

562

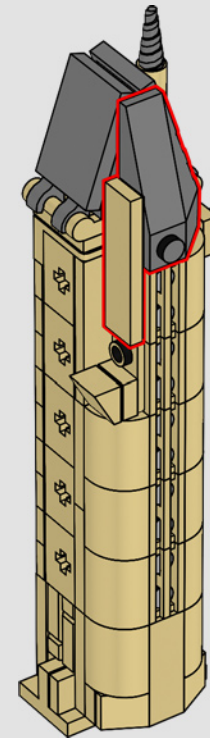
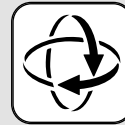

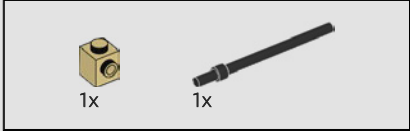
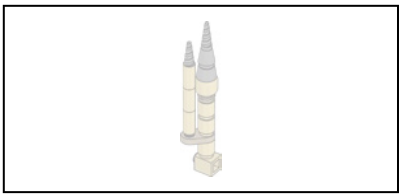

563

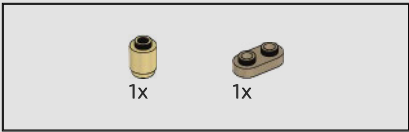

564



565







566

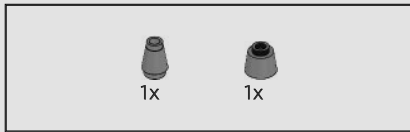
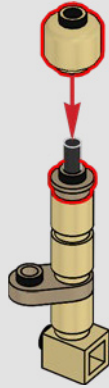

567

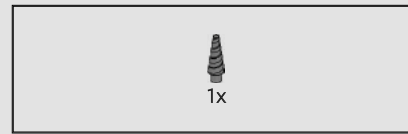
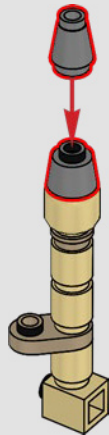

568

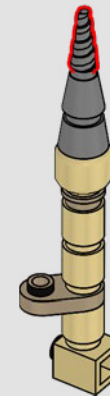

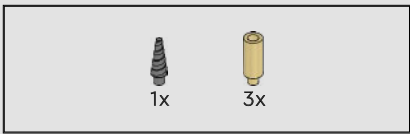

569

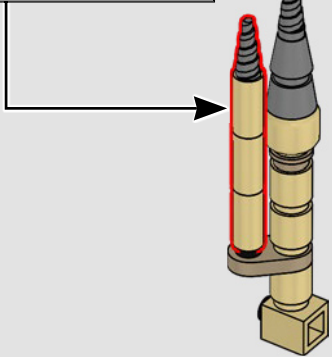
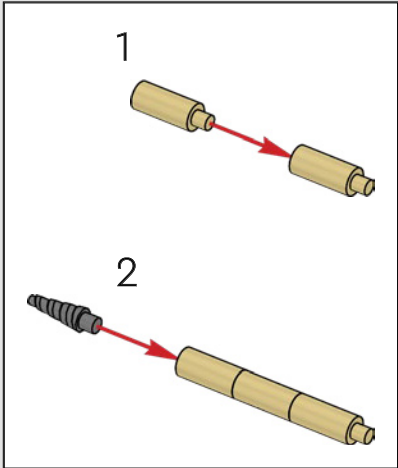

570

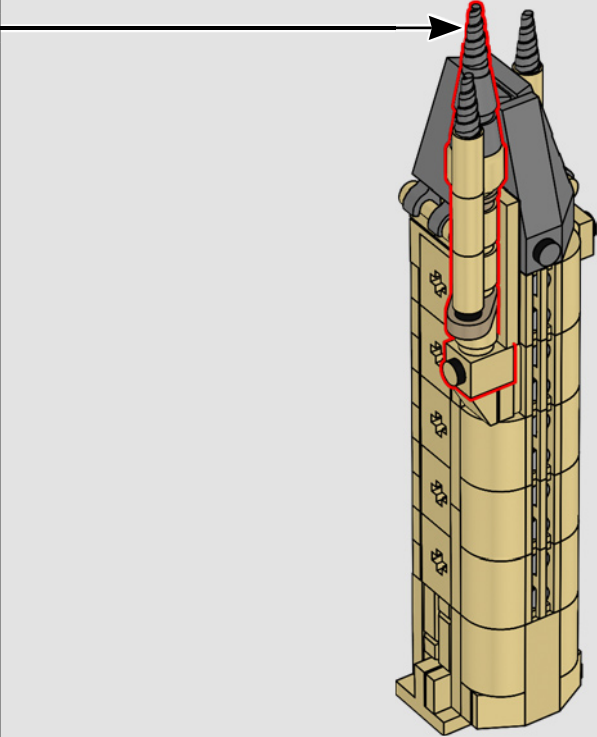



571





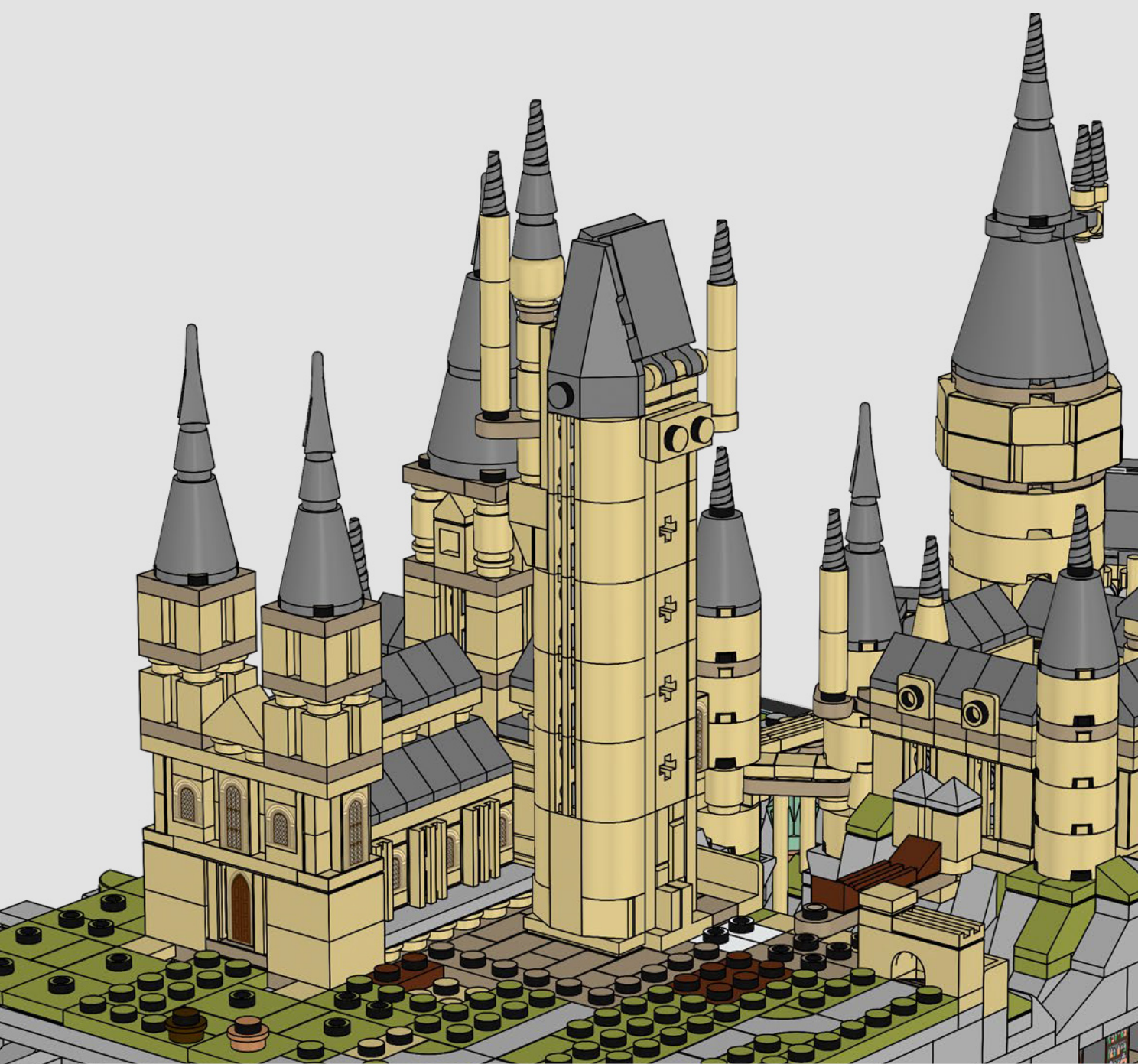

Se podría pensar que la Torre Central sería el punto más alto del Castillo de Hogwarts™, pero, en realidad, lo es la Torre de Astronomía.





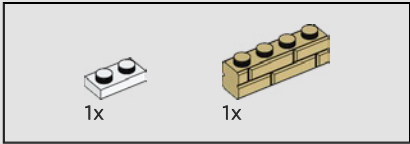
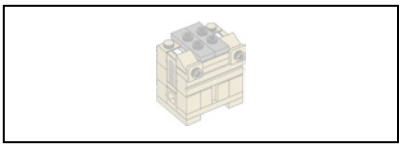

572

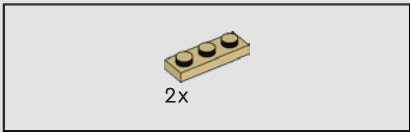
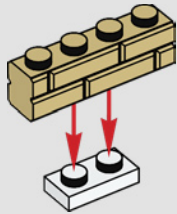

573

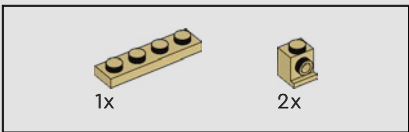
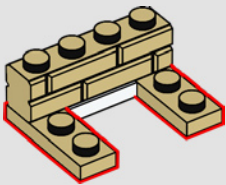

574

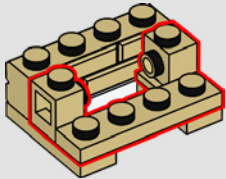

575

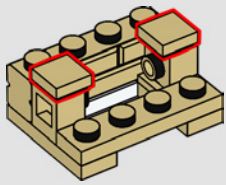



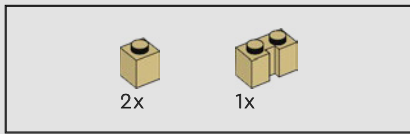

576

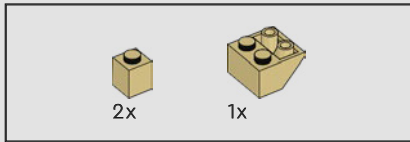
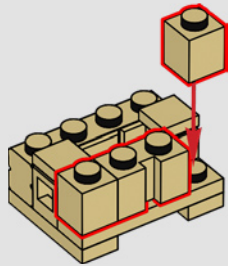

577

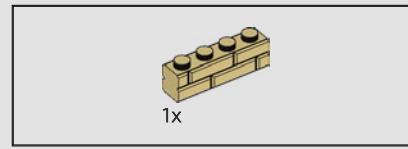
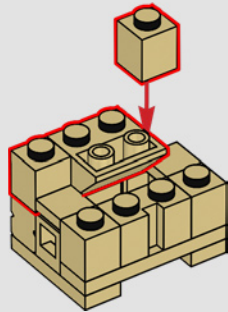

578

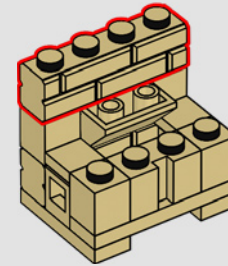

579

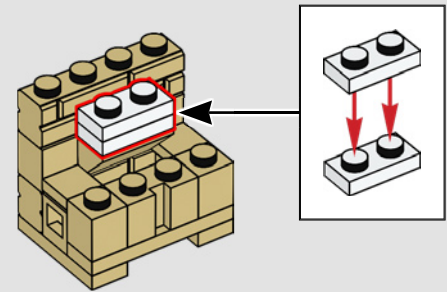

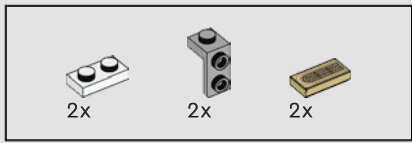

580

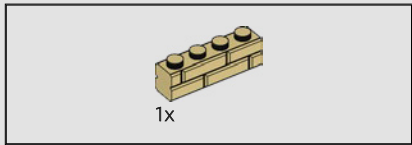
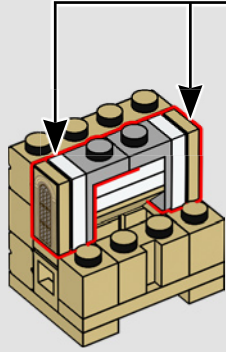
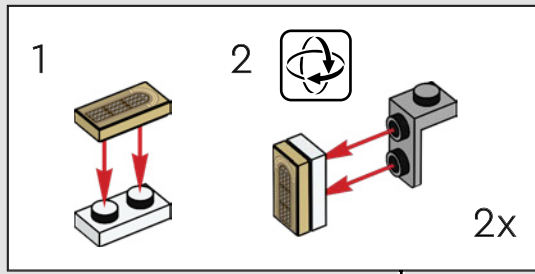

581

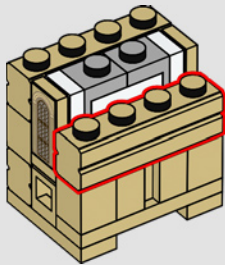

582

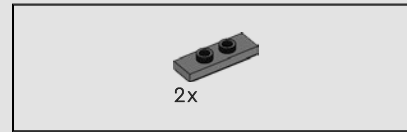
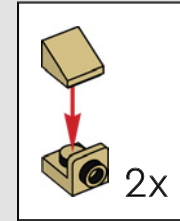
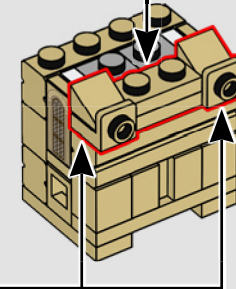
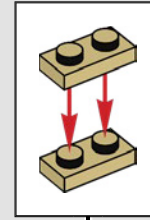

583

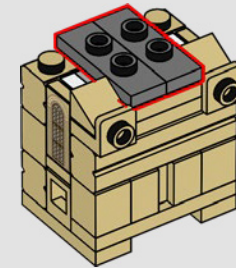



584

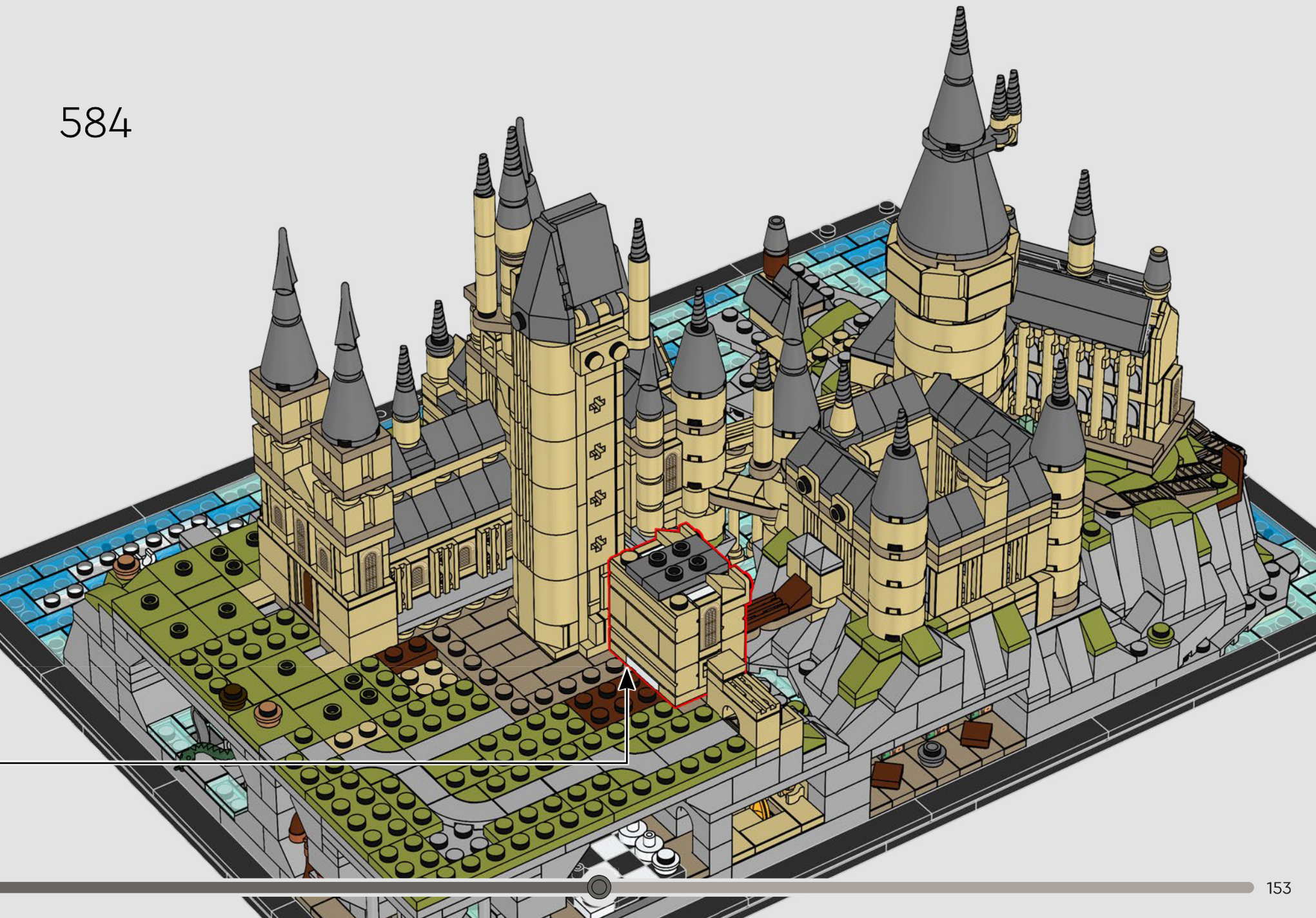



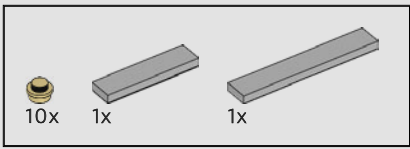

585

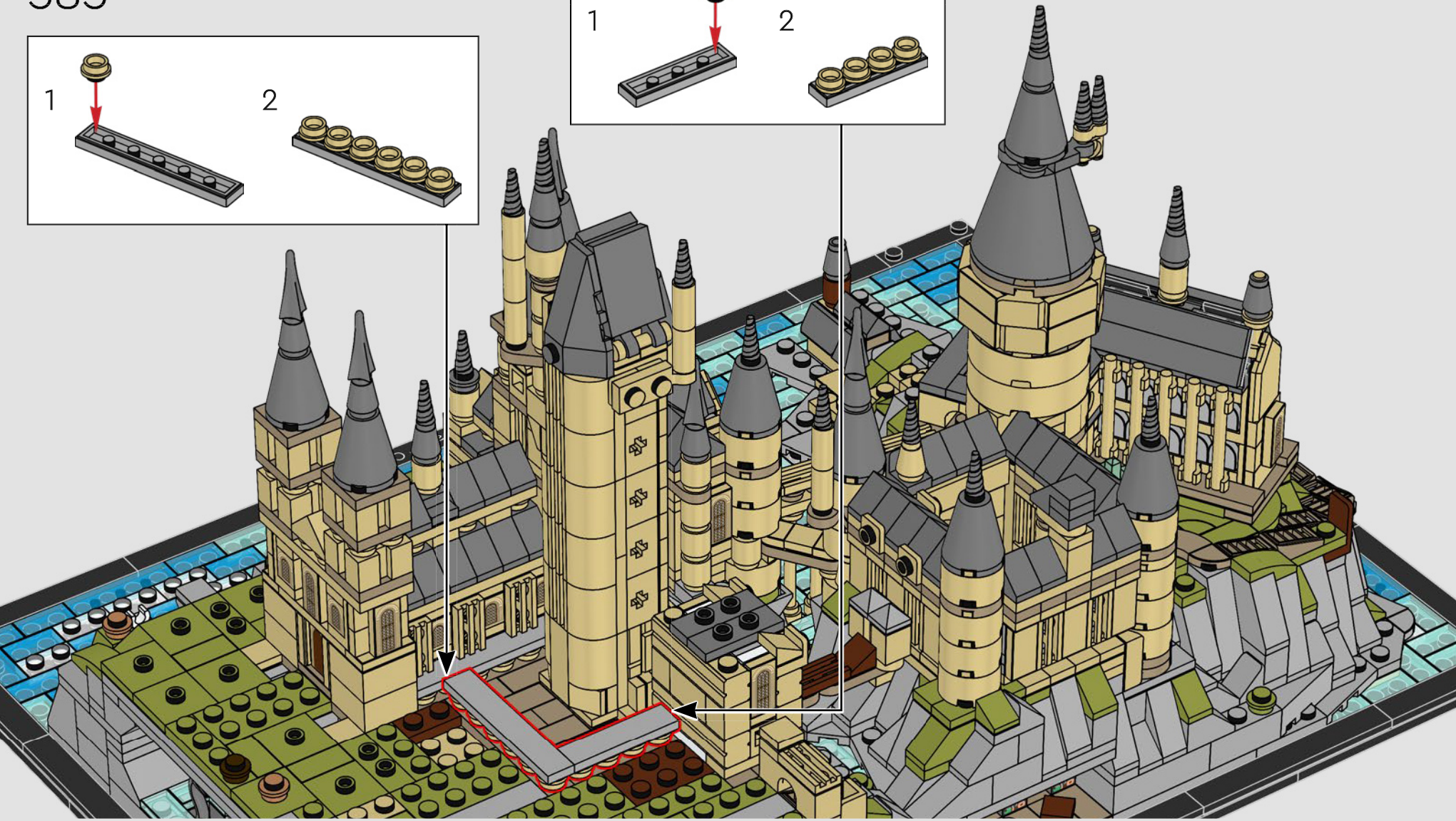
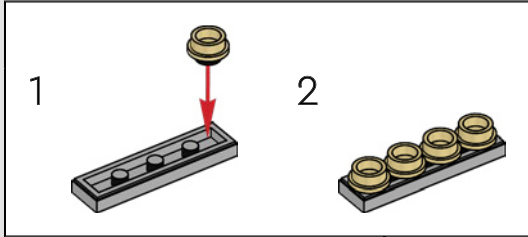
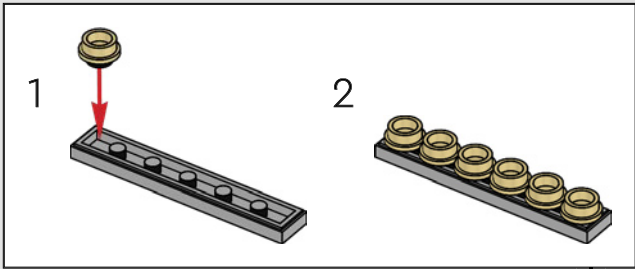



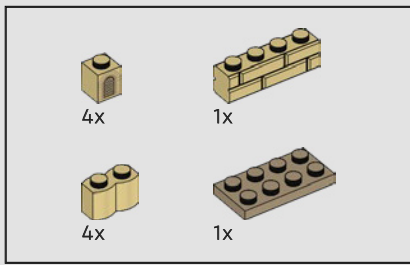

586

1

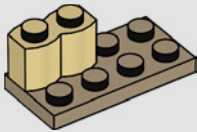

2

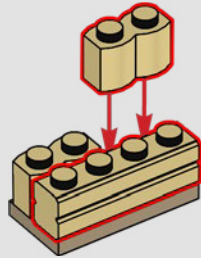

3

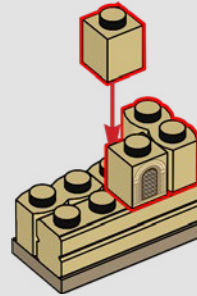

4

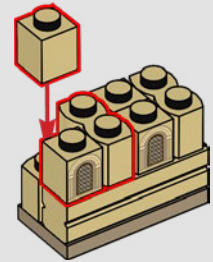







587





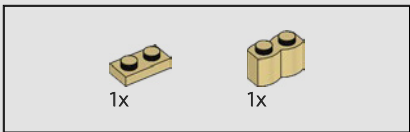

588

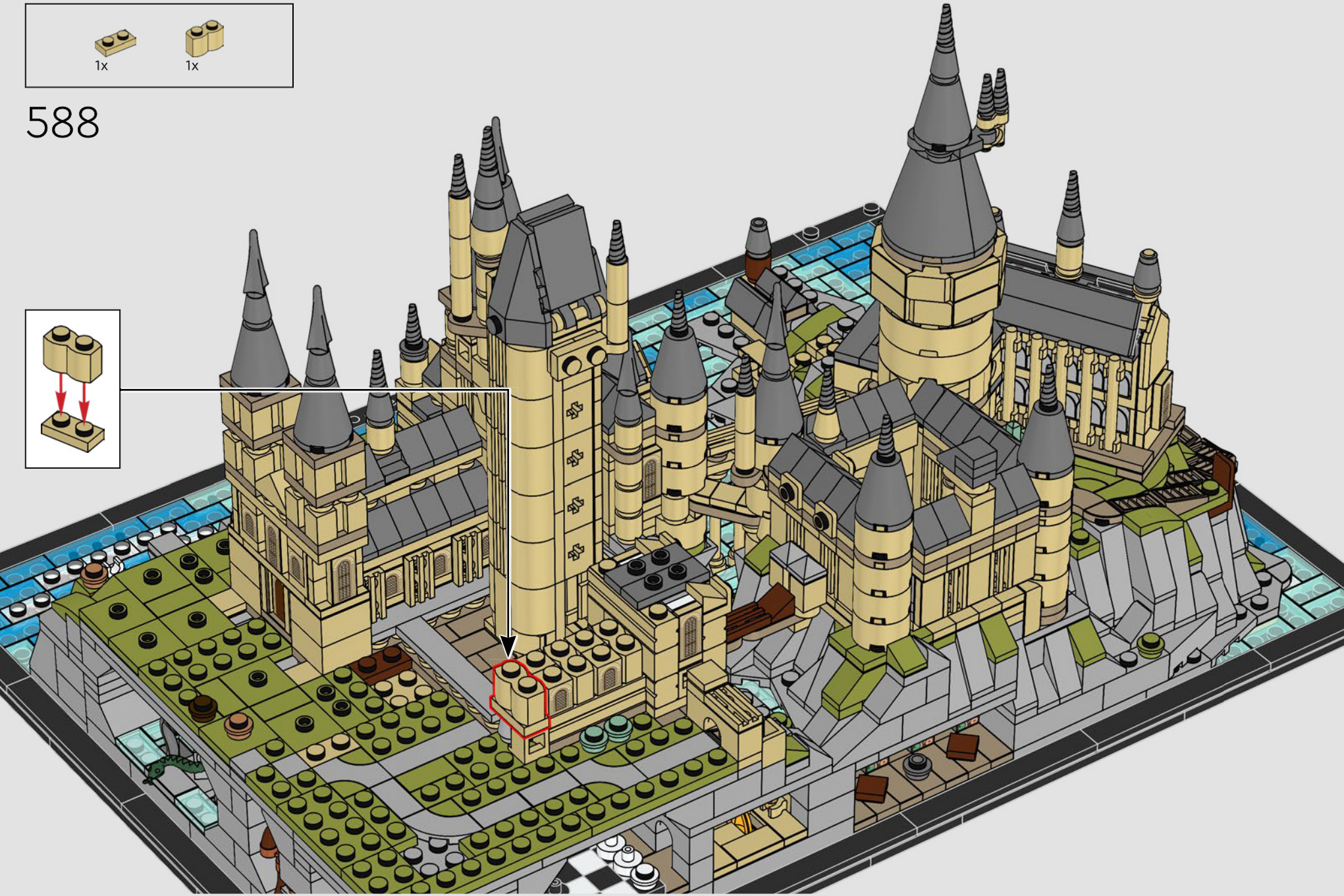
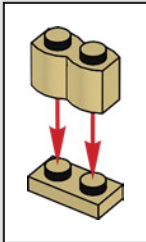



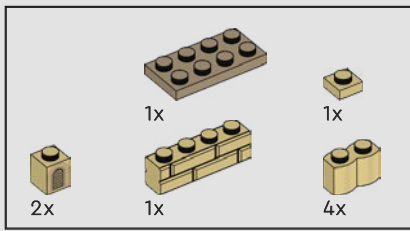

589

1

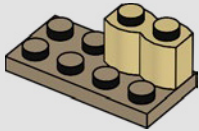

2

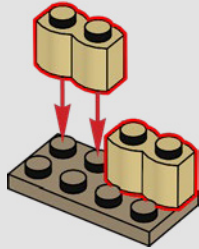

3

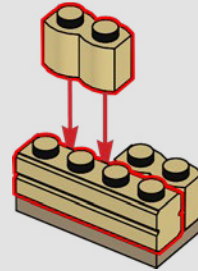

4

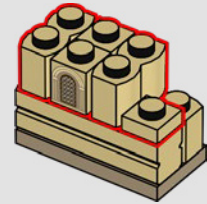

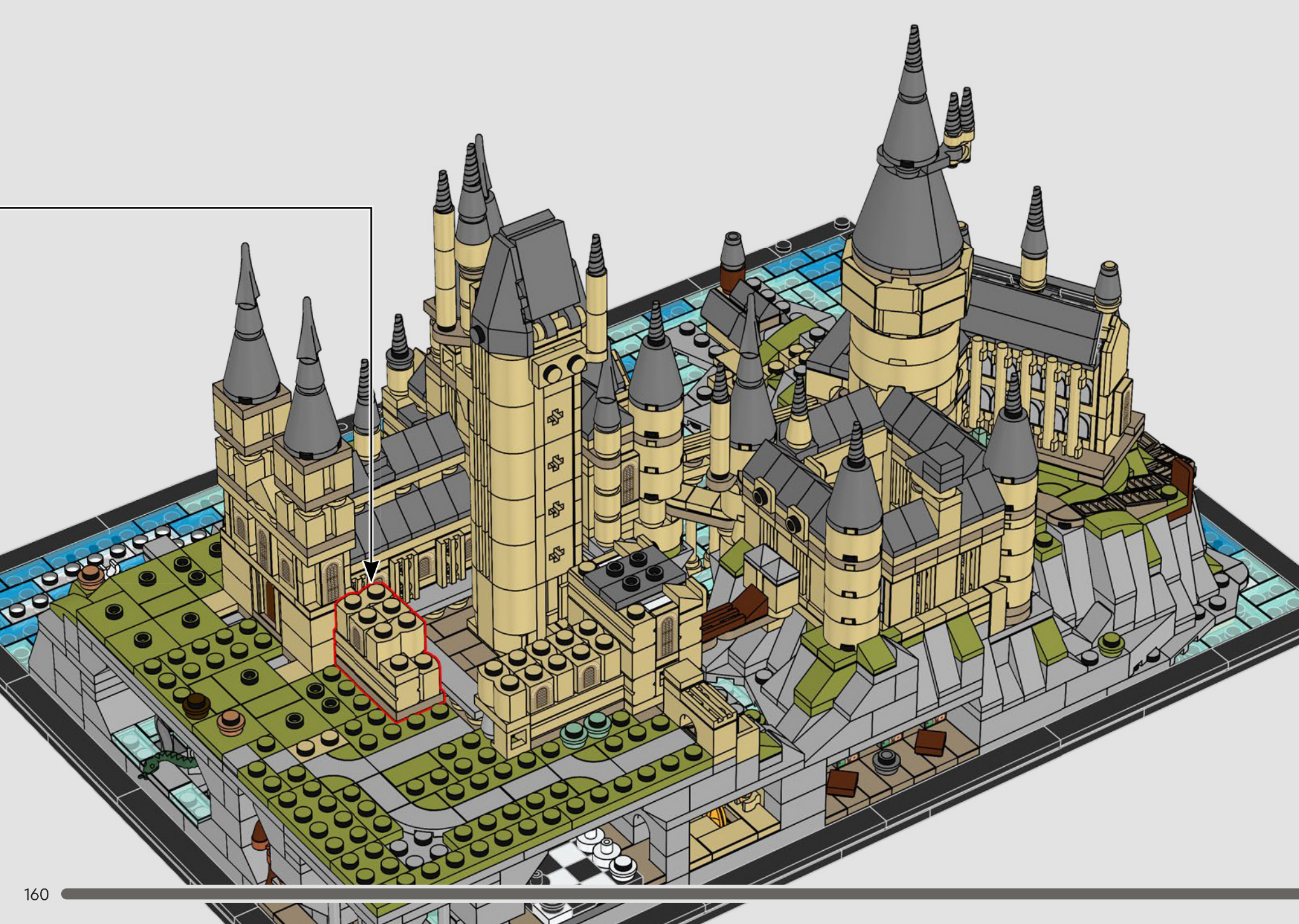



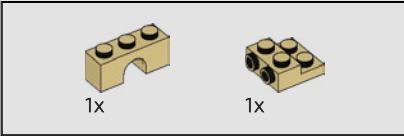
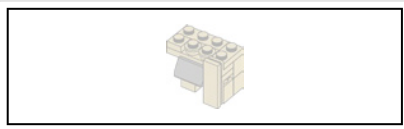

590

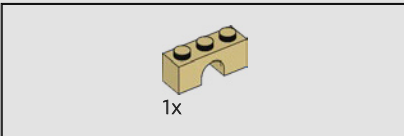
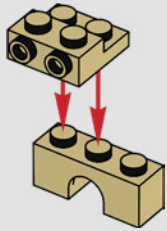

591

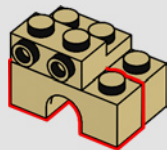

592

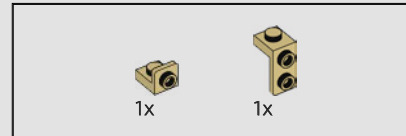
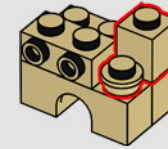

593

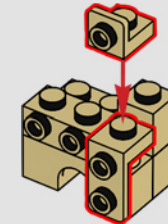

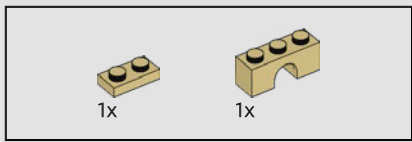

594

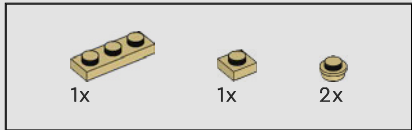
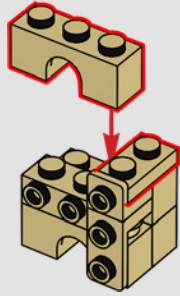

595

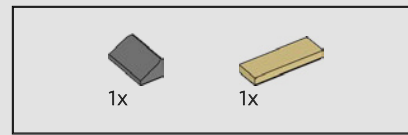
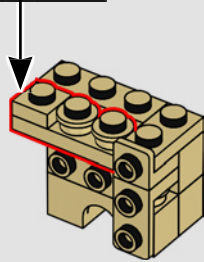
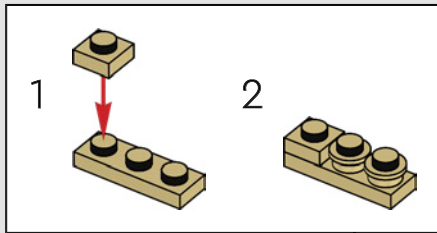

596

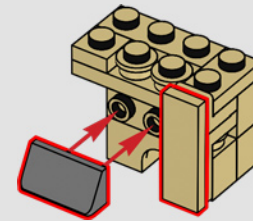



597





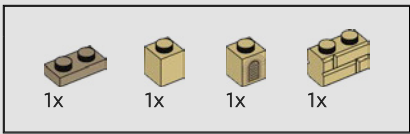

598

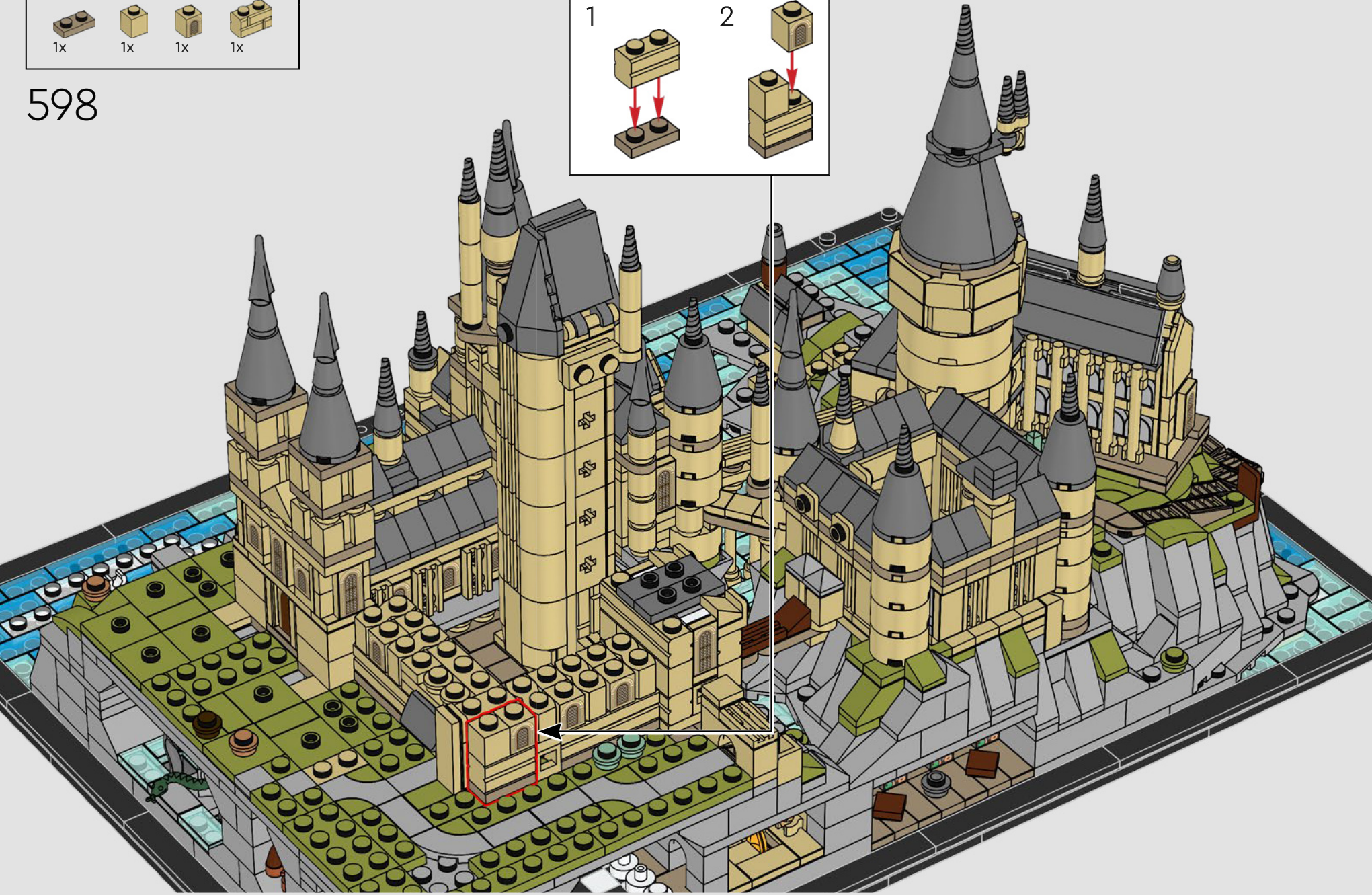
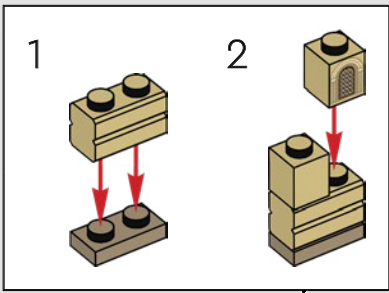



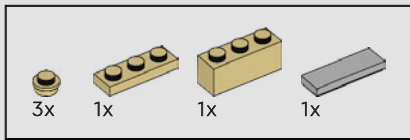

599

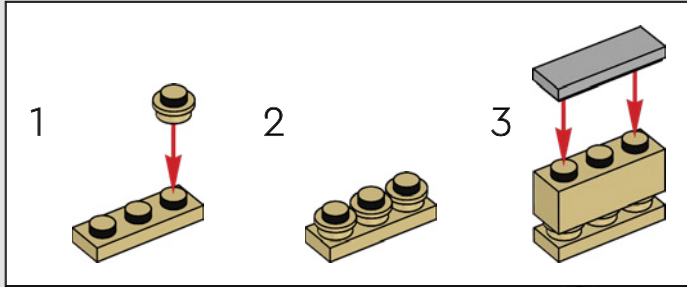



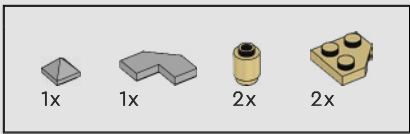

600

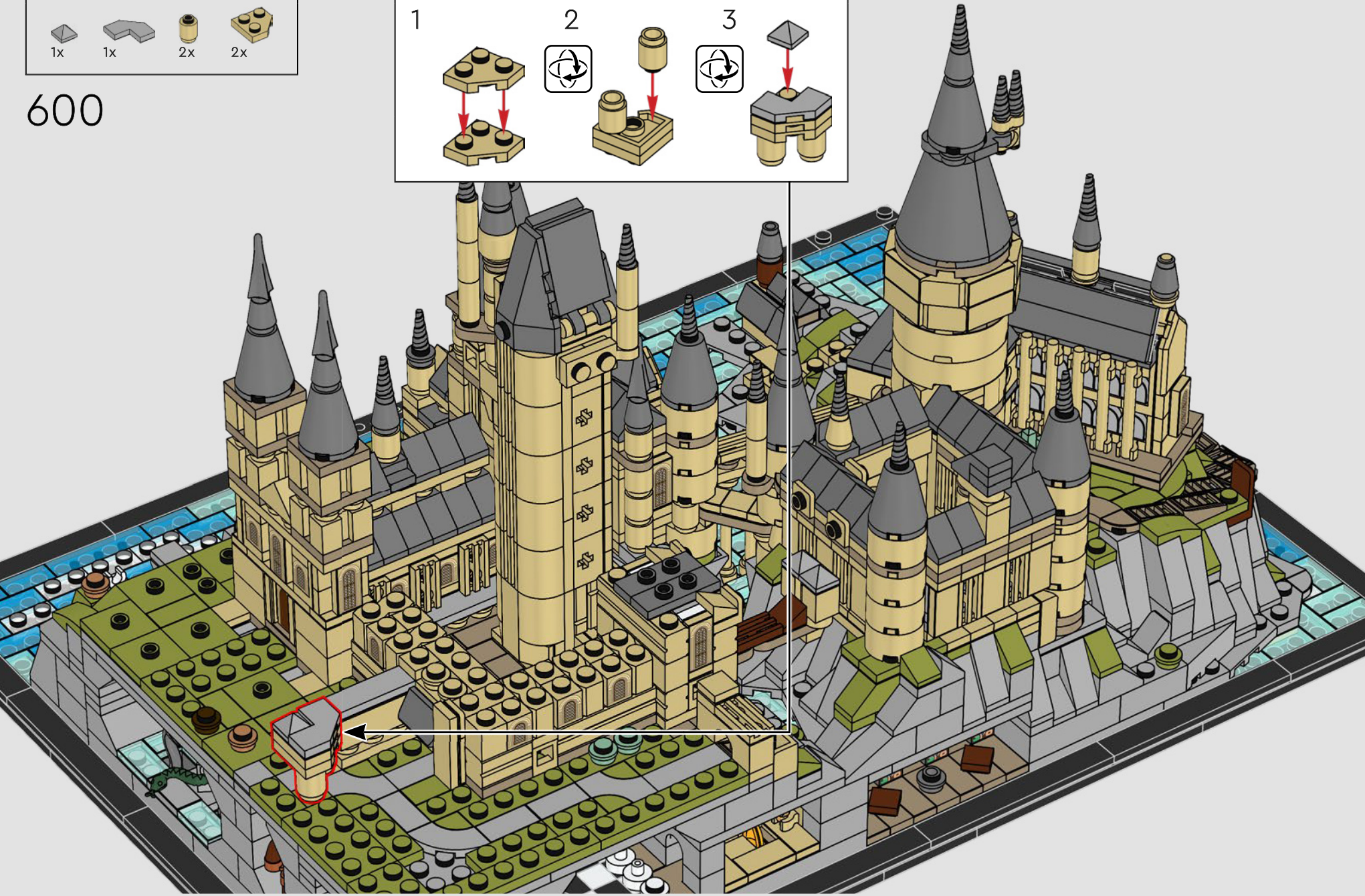
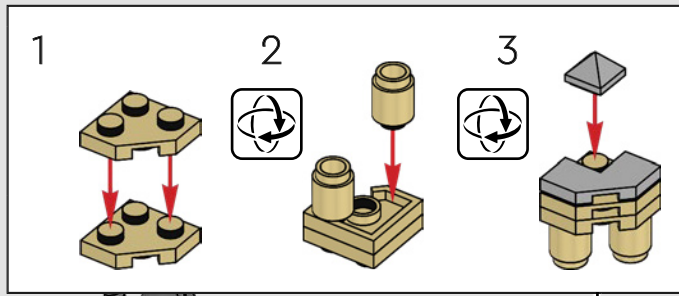



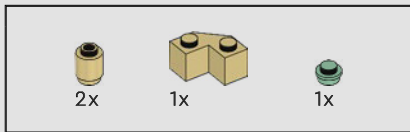

601

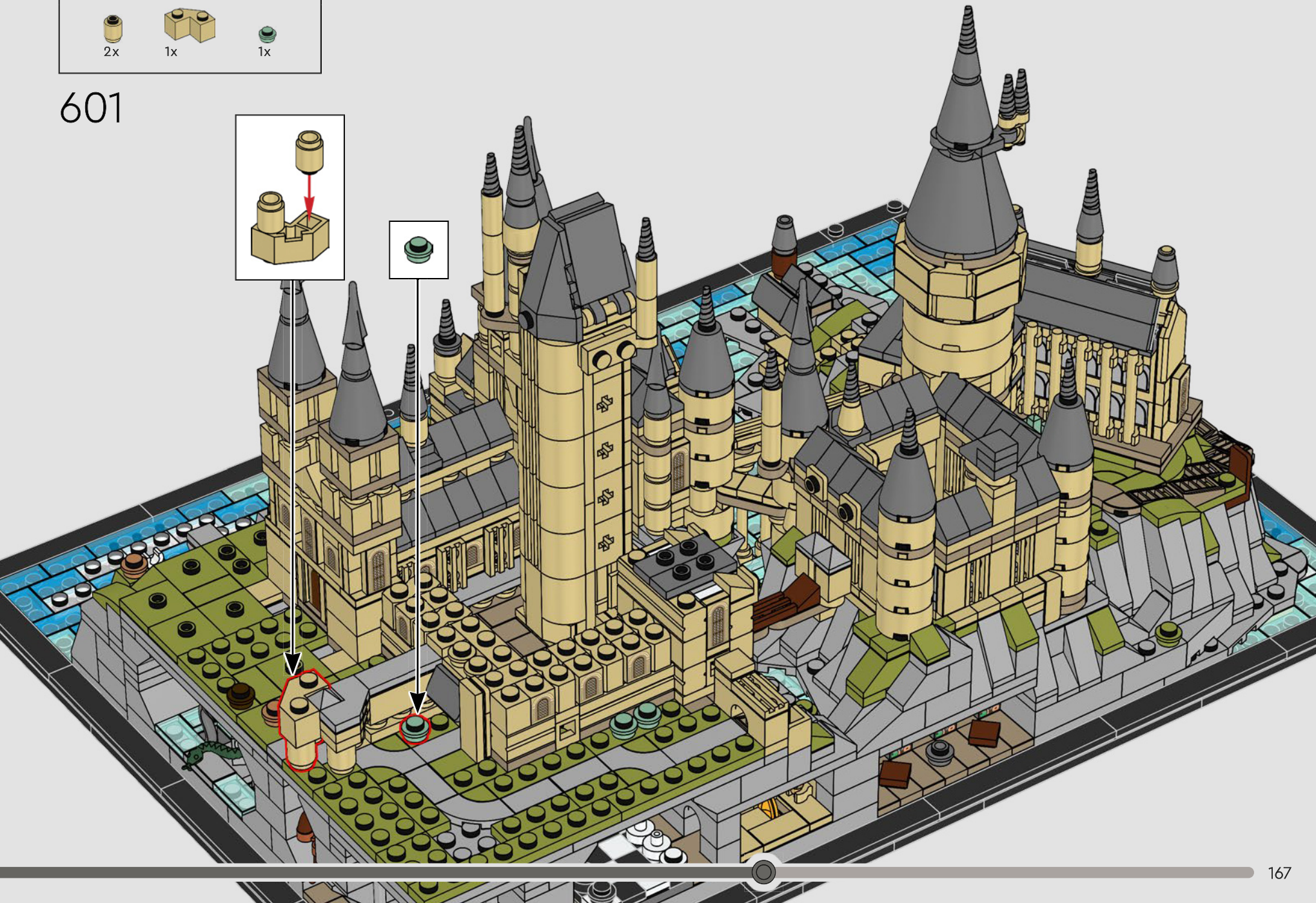
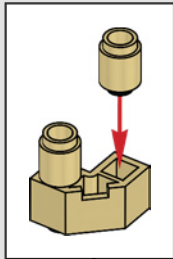





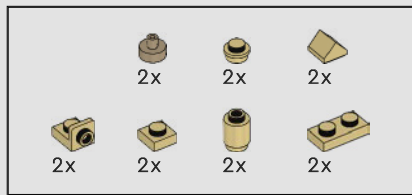

602

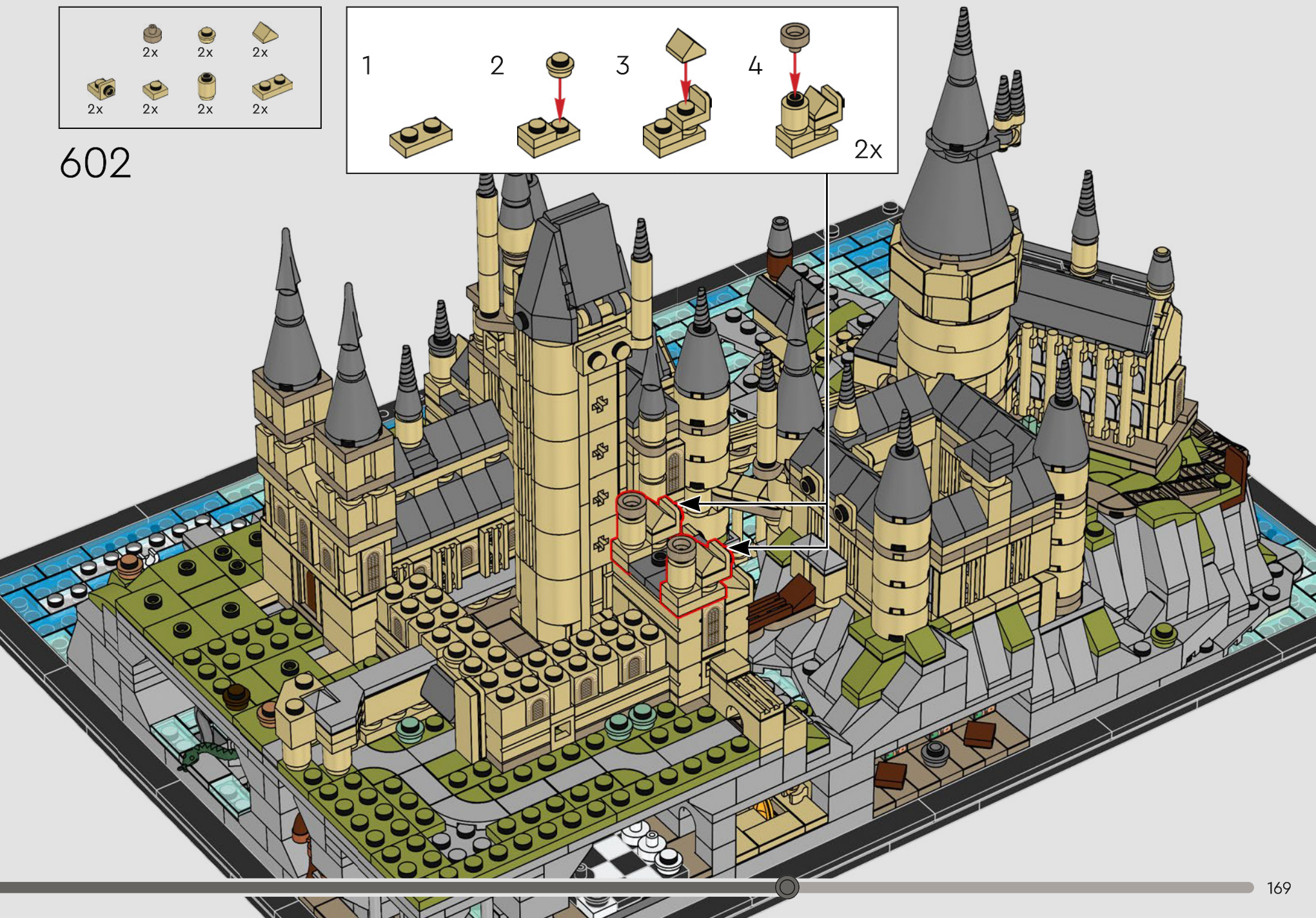
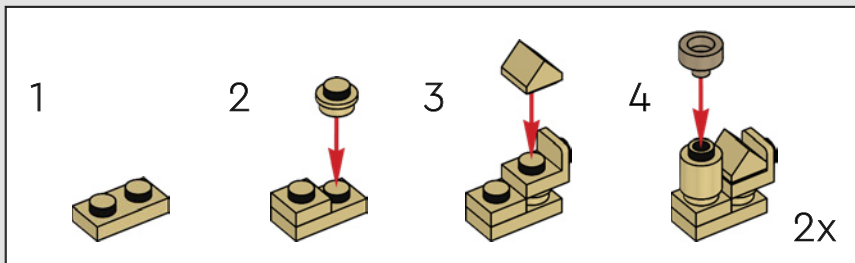



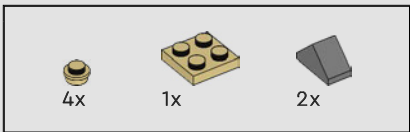

603

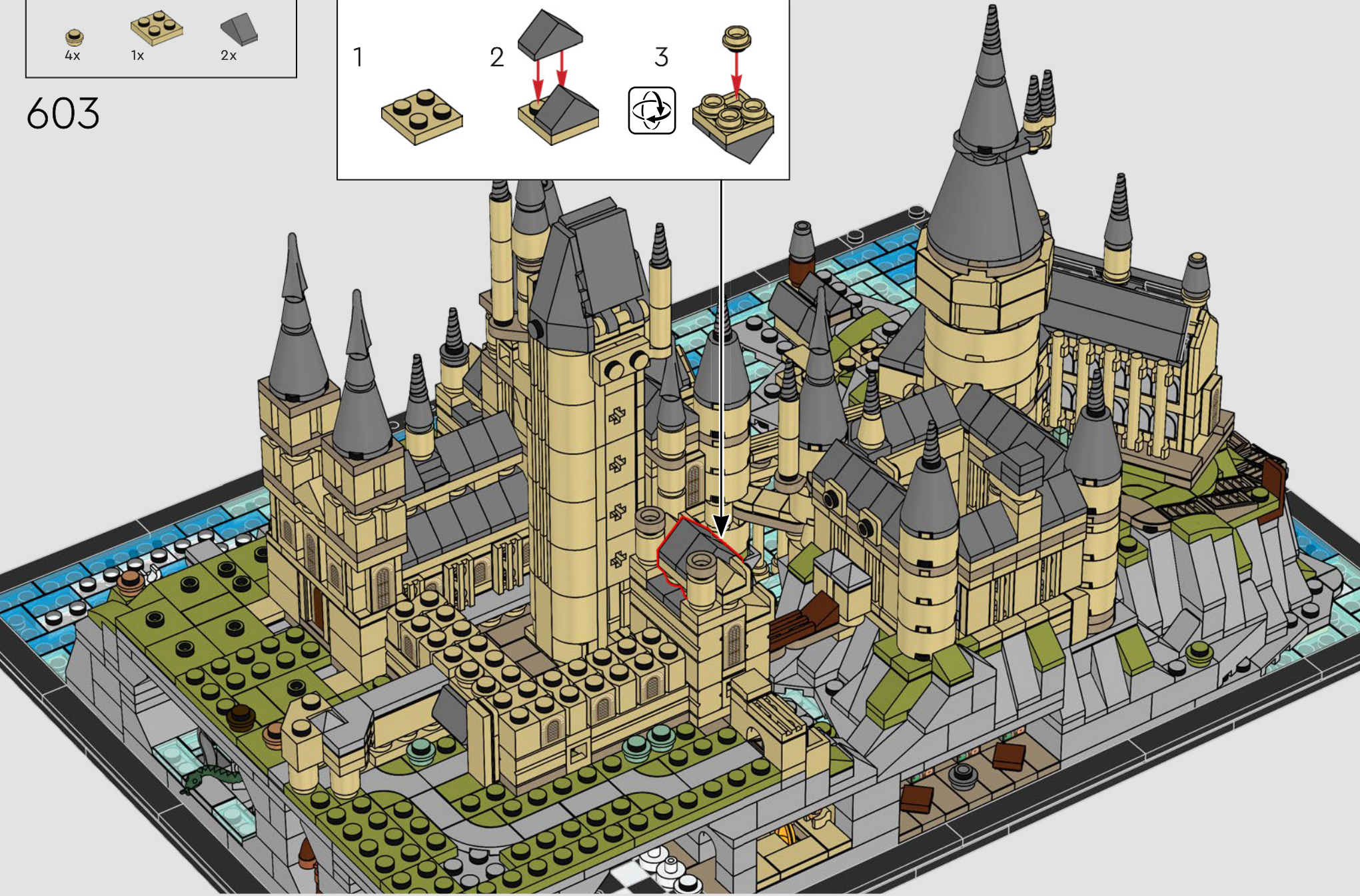
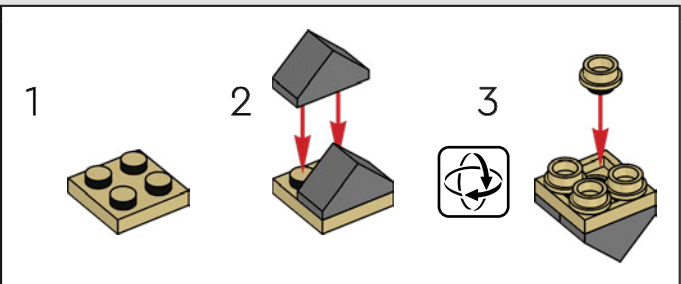



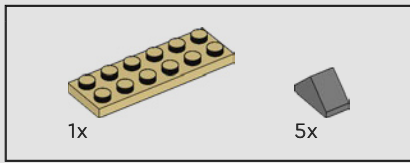

604

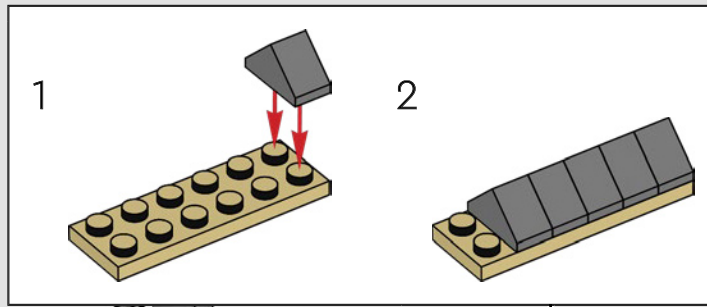



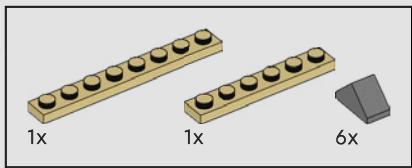

605

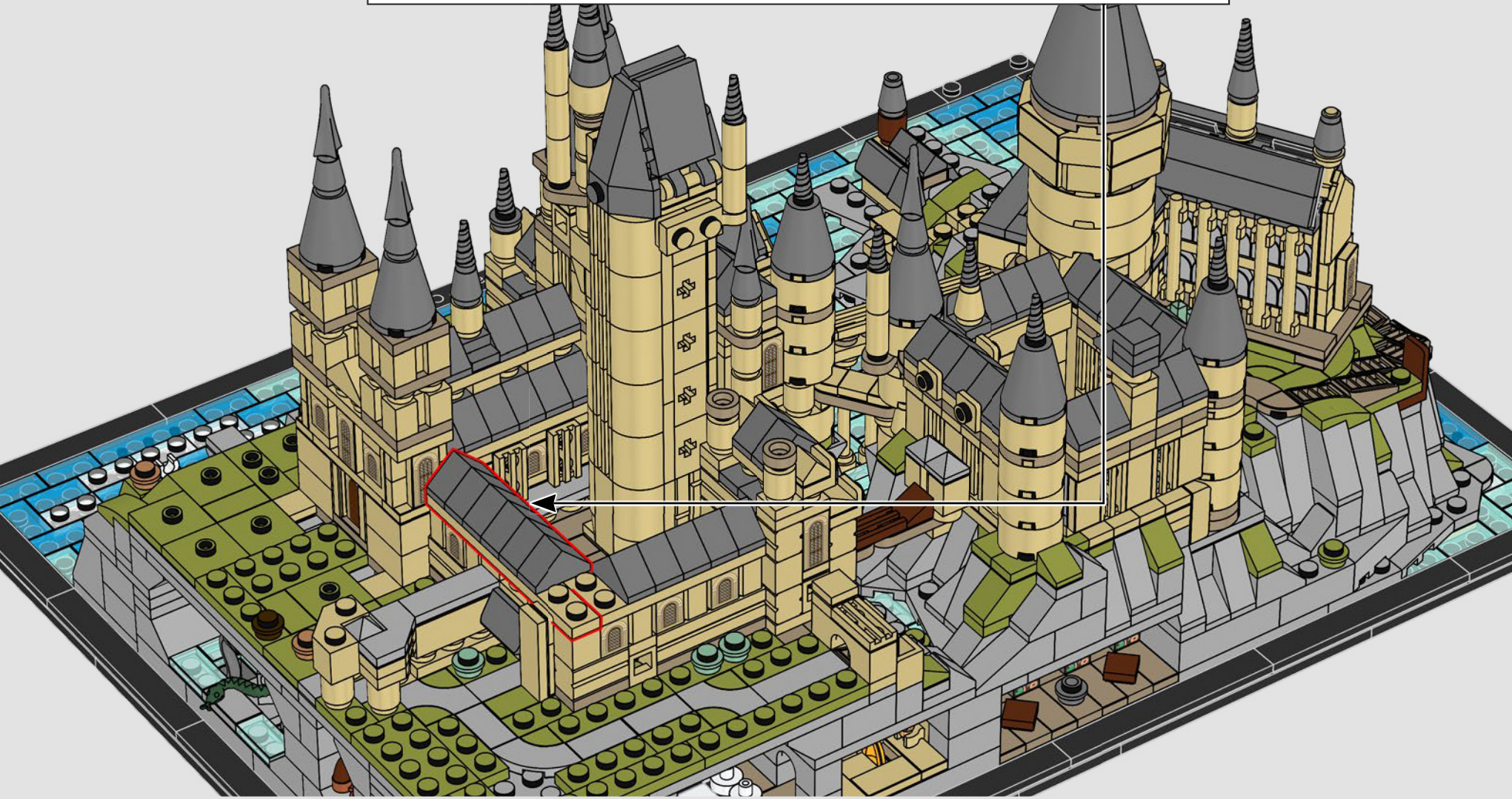
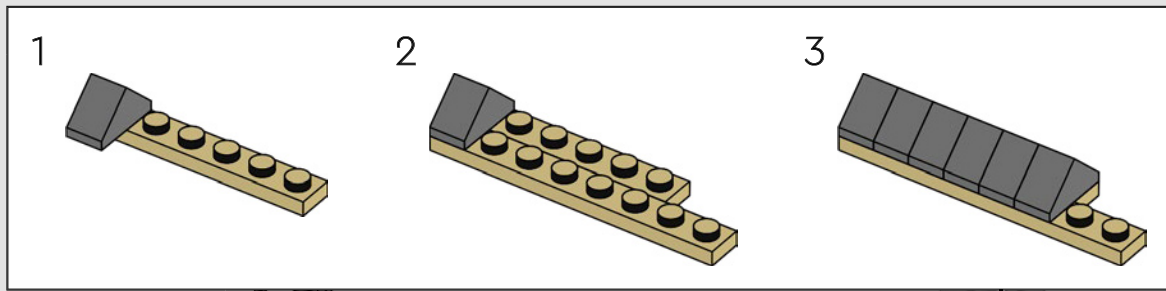



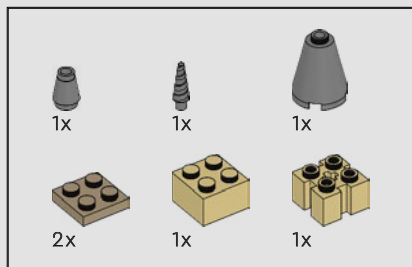

606

1

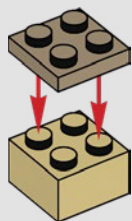

2

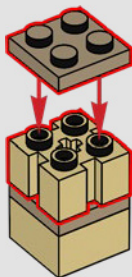

3

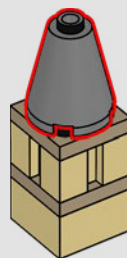

4

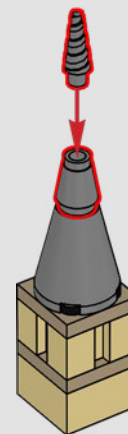





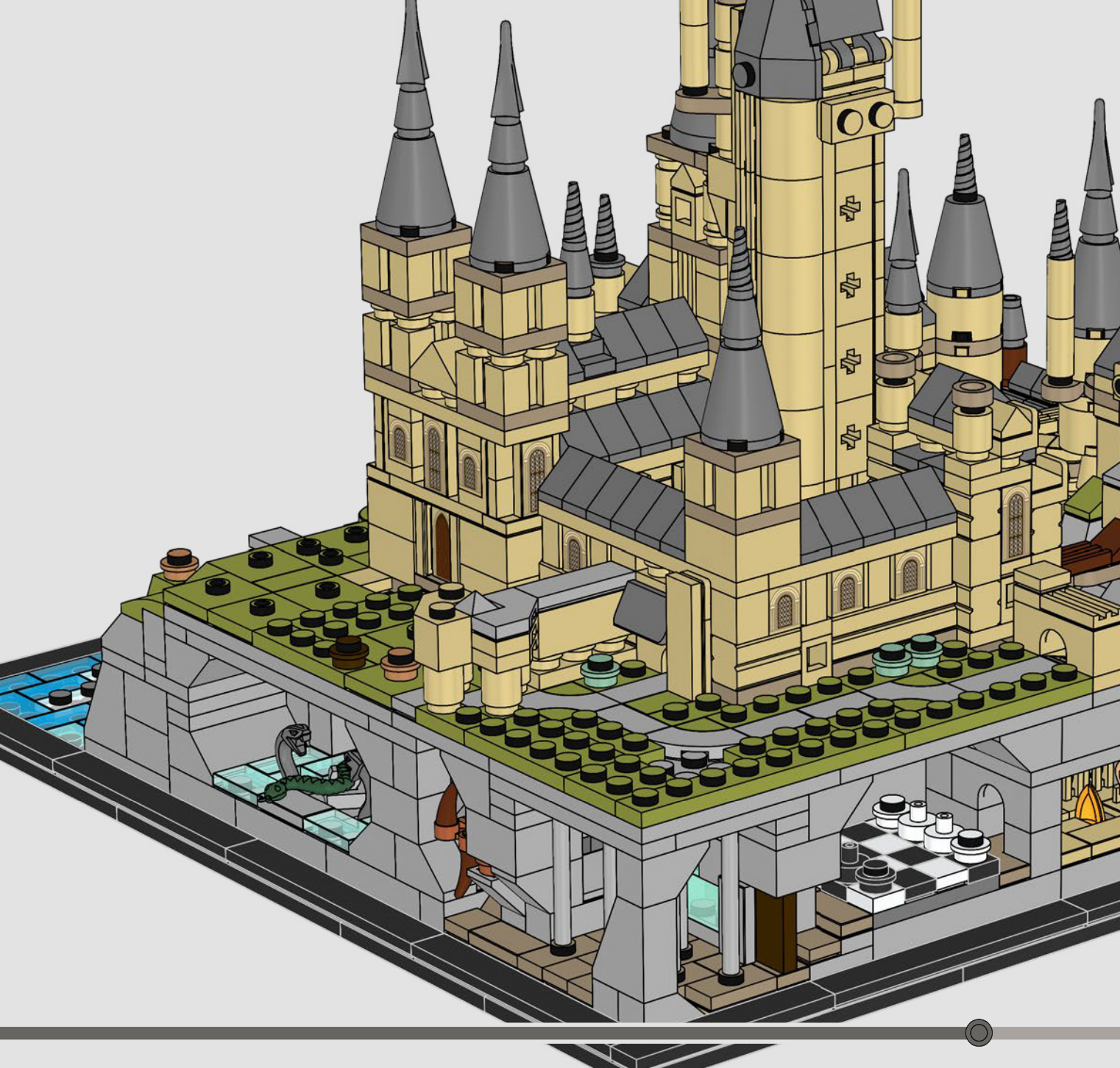

Hogwarts™ es un castillo enorme en el que puede ser difícil encontrar el camino, ¿pero sabías que cuenta con 142 escaleras? Cambian de posición constantemente, lo que no hace más fácil orientarse, precisamente.



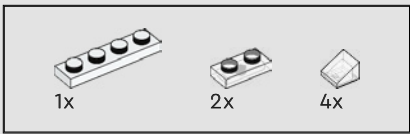

607

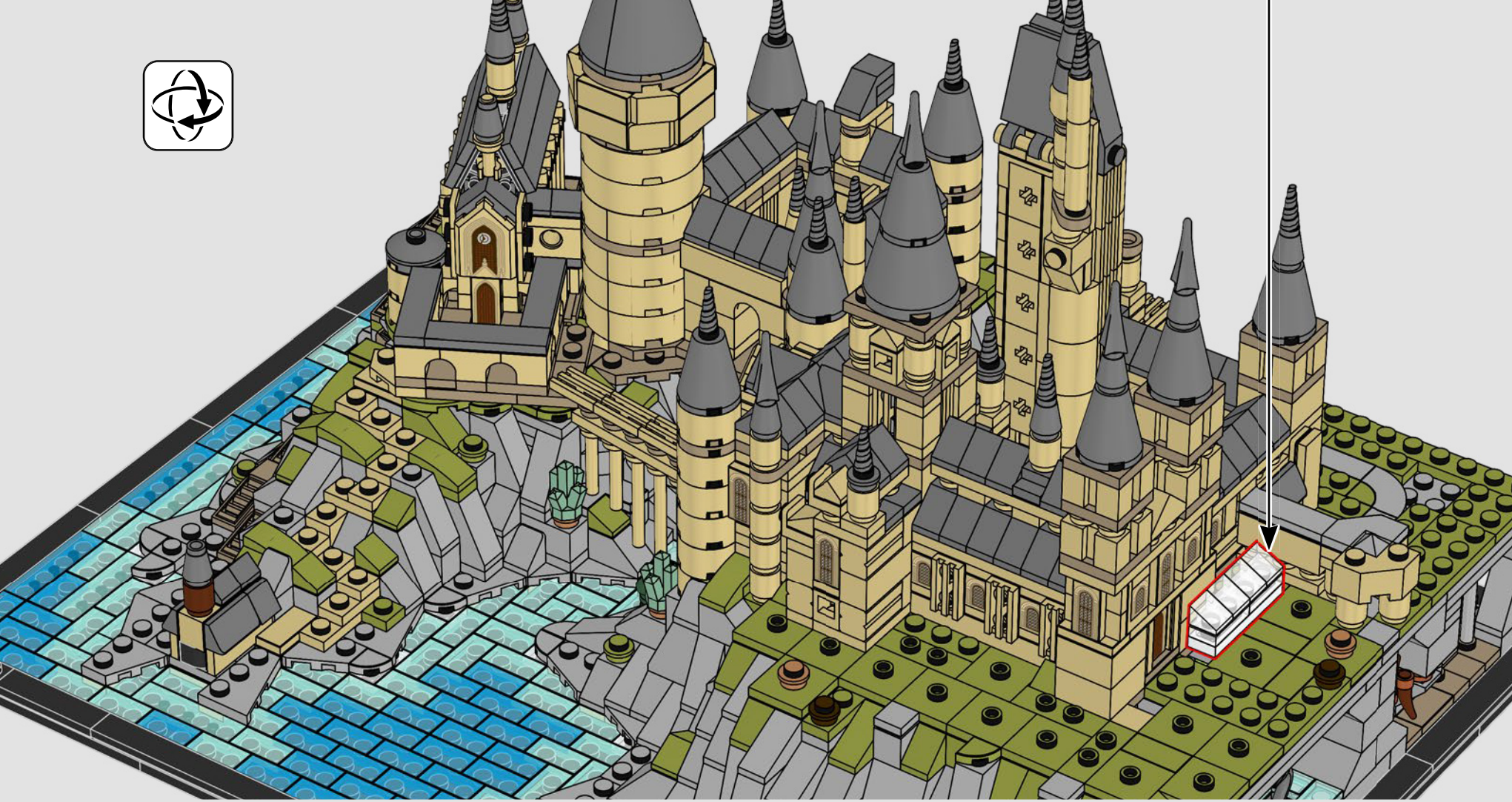
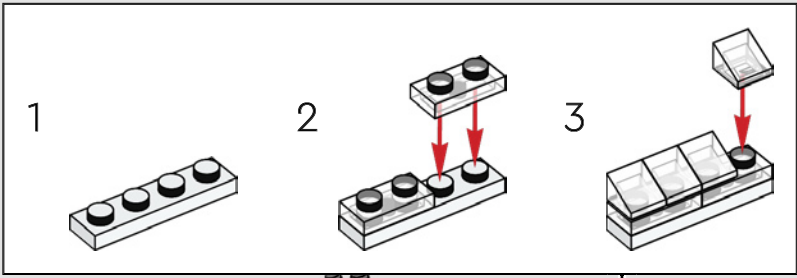



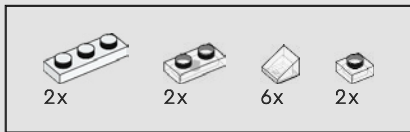

608

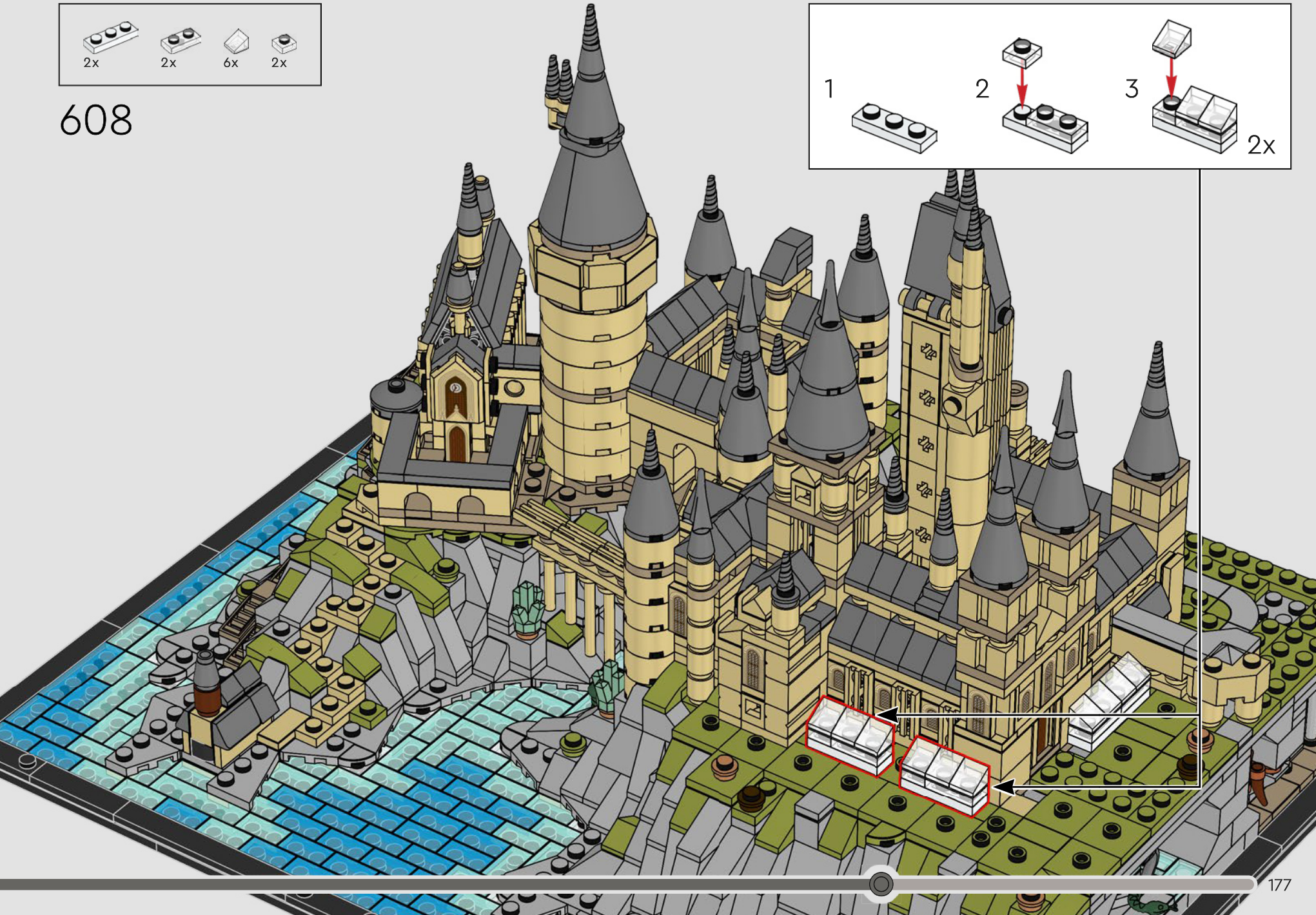
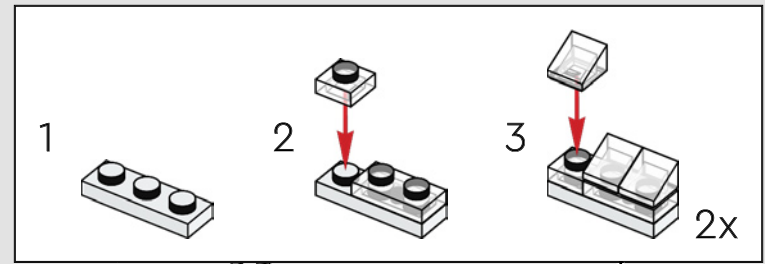





609

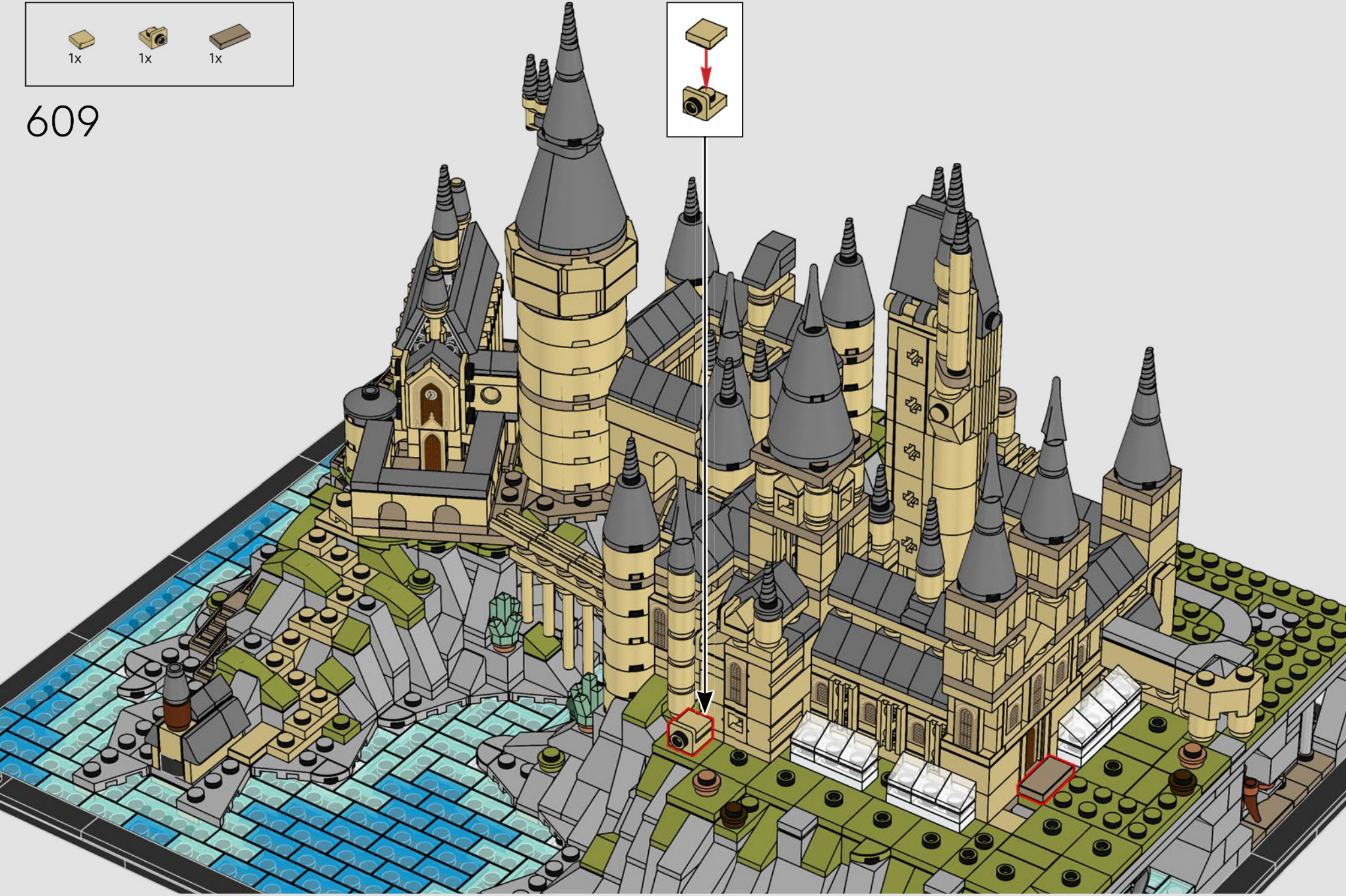
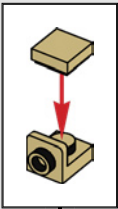





610

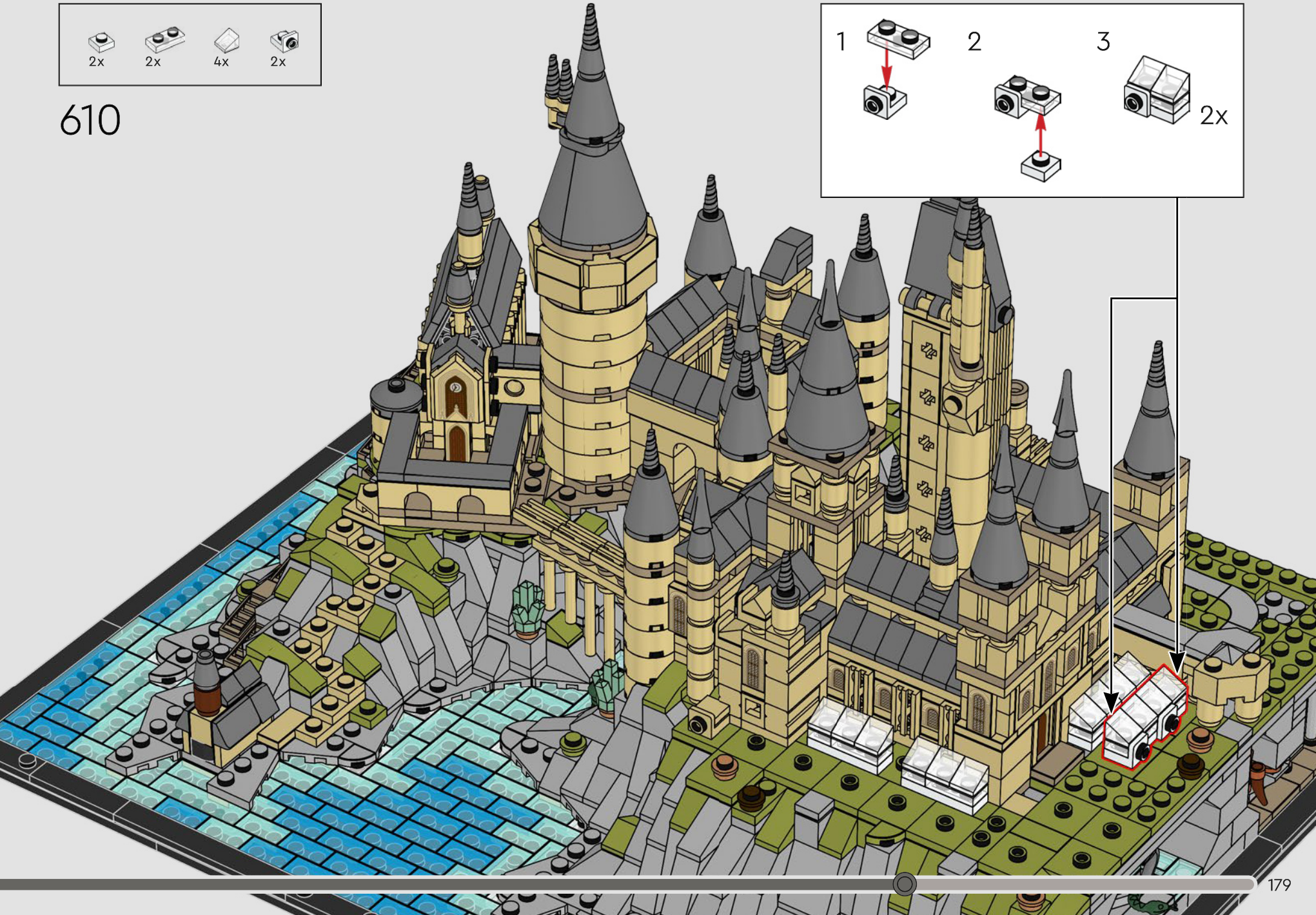
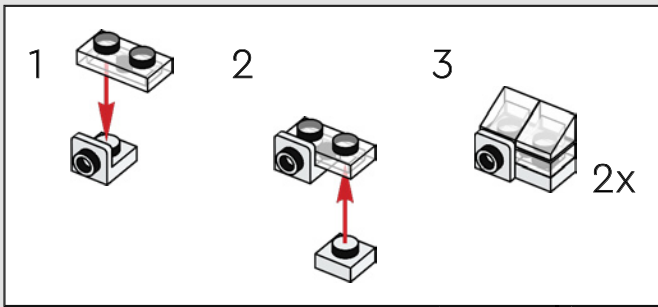



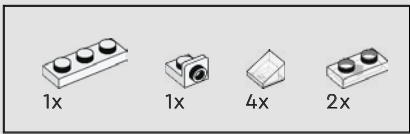

611

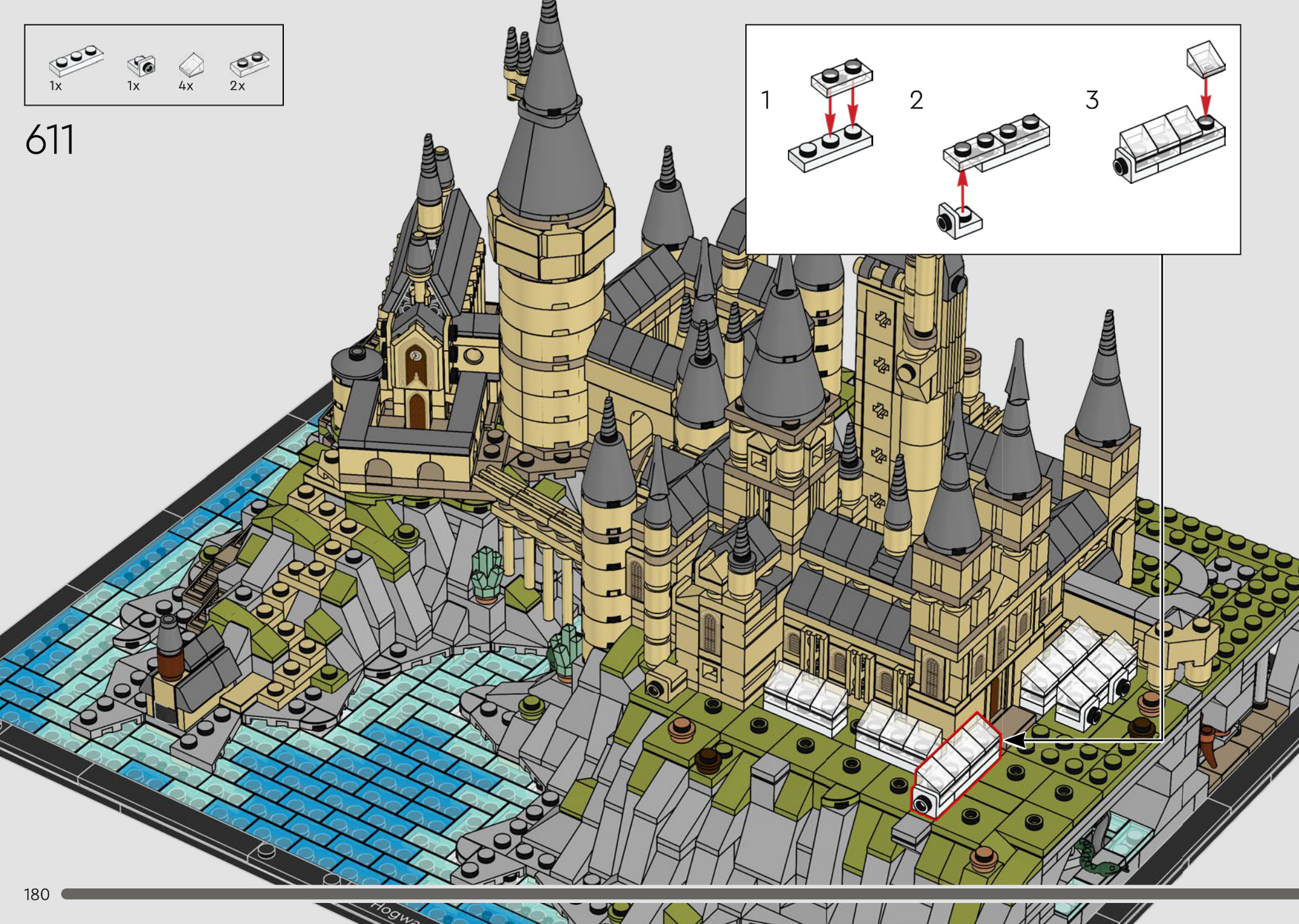
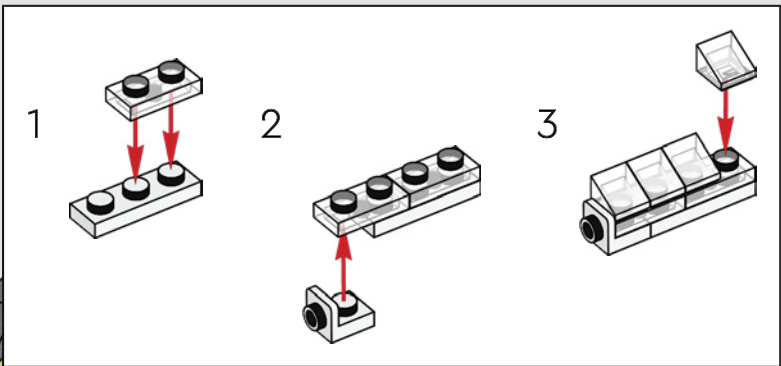



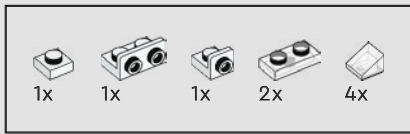

612

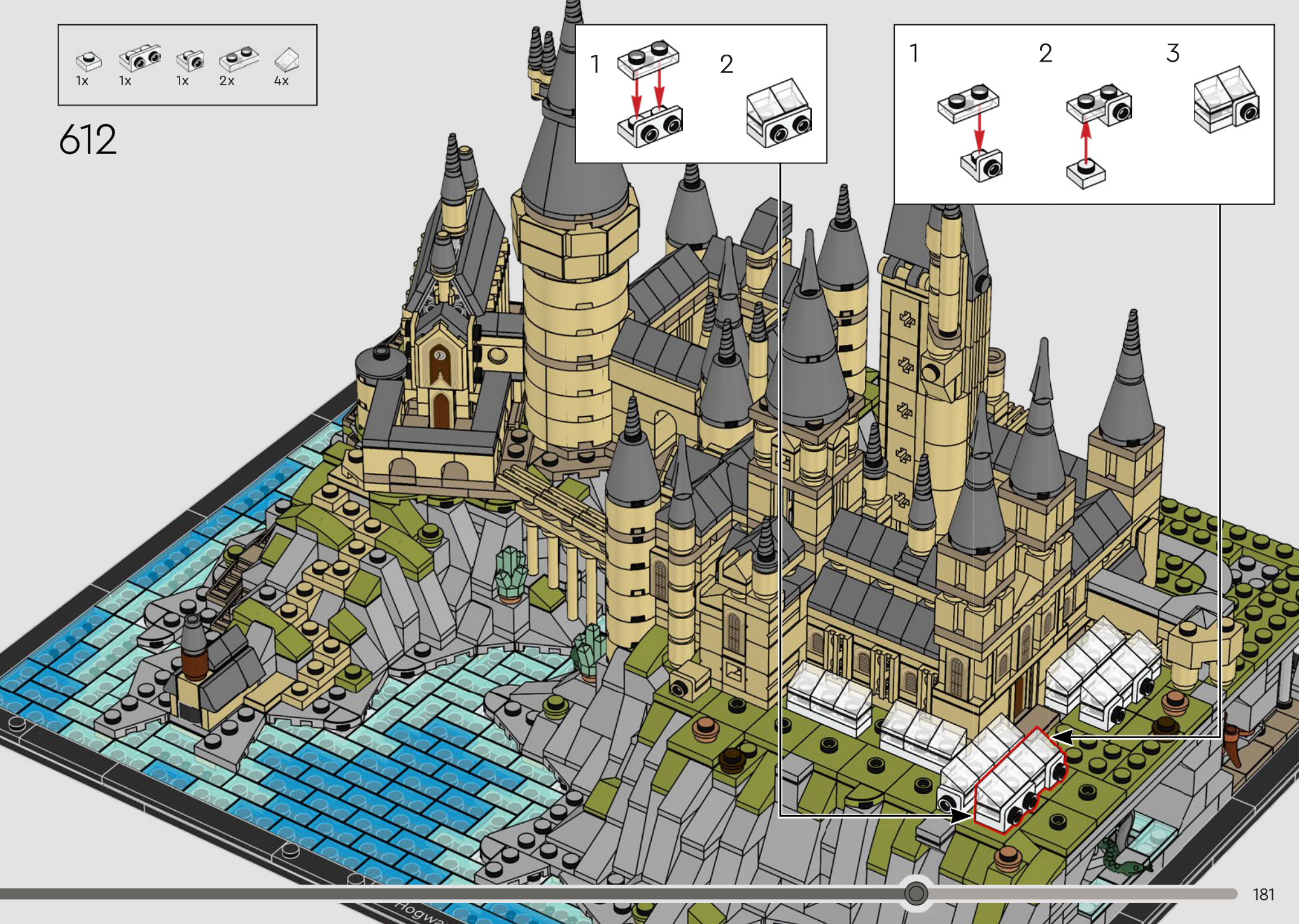
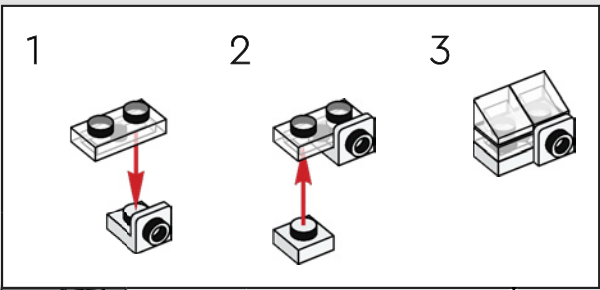
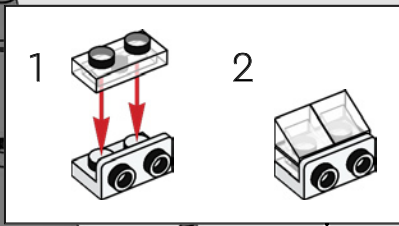



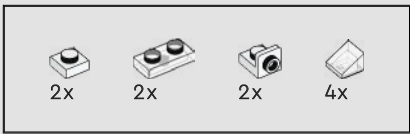

613

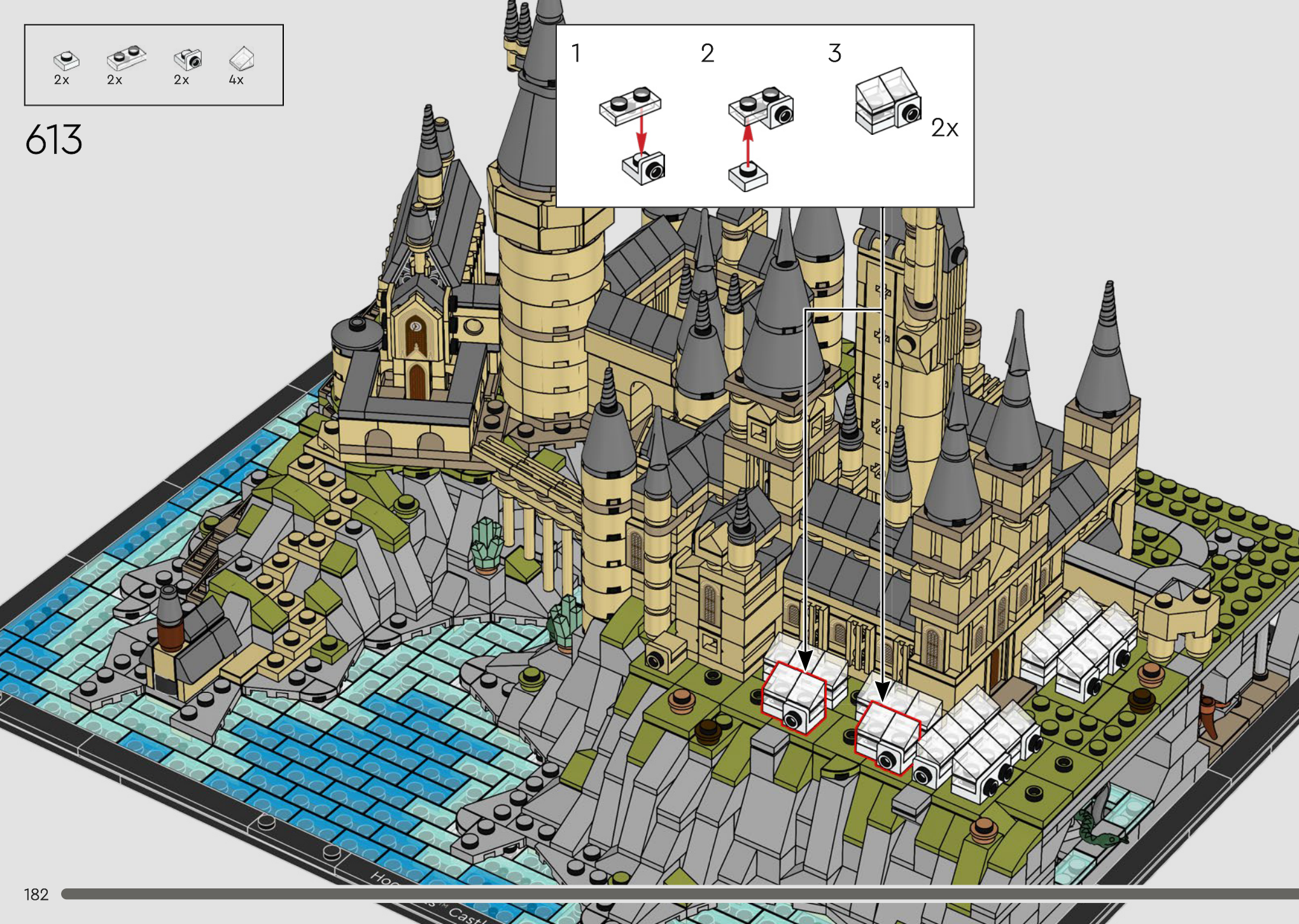
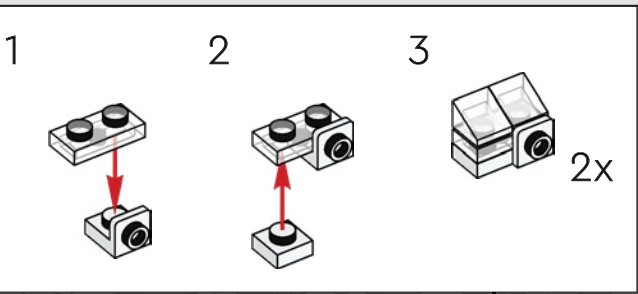





614

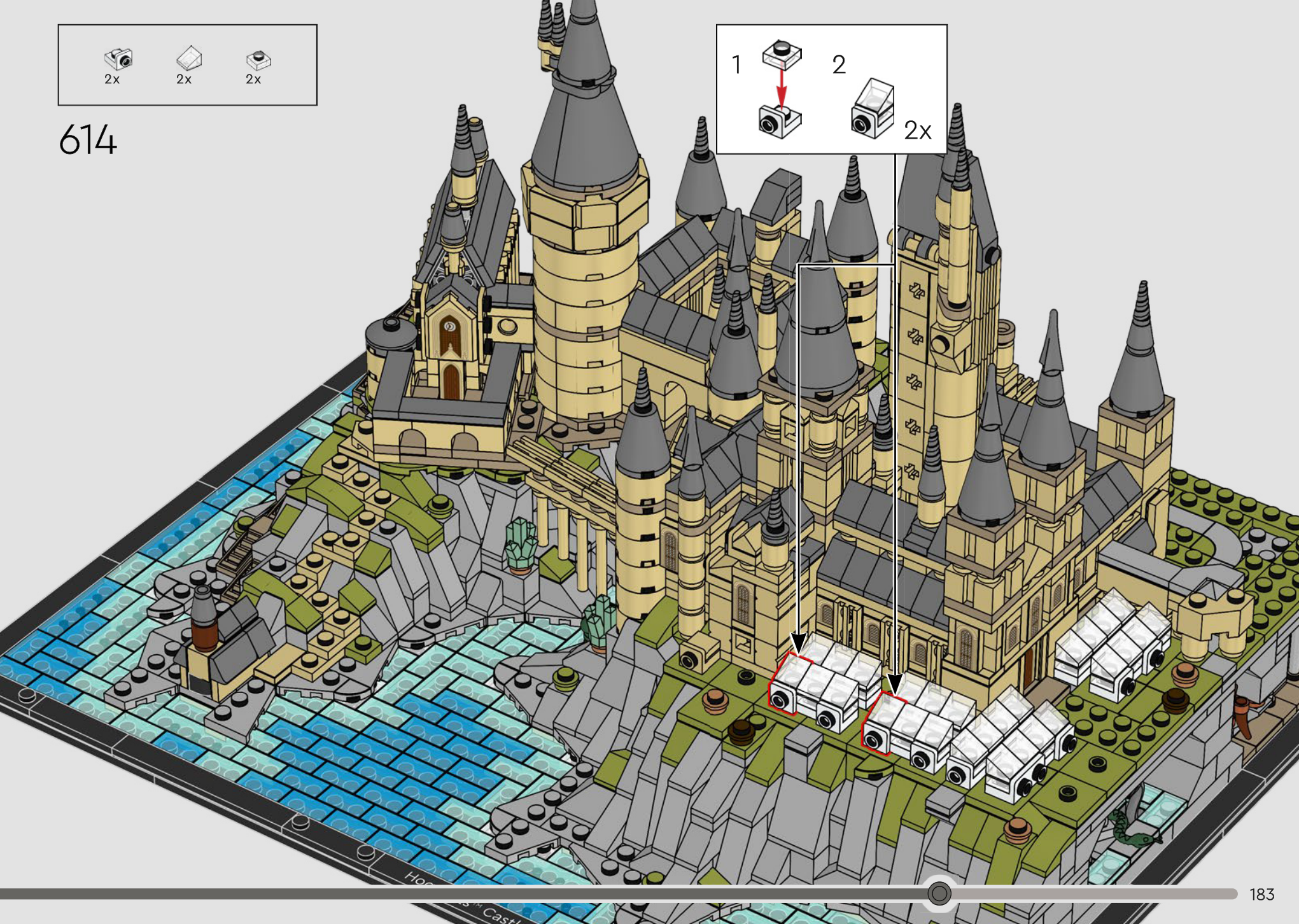
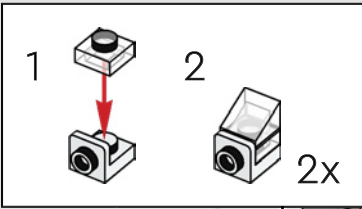



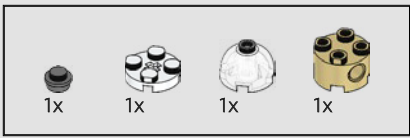

615

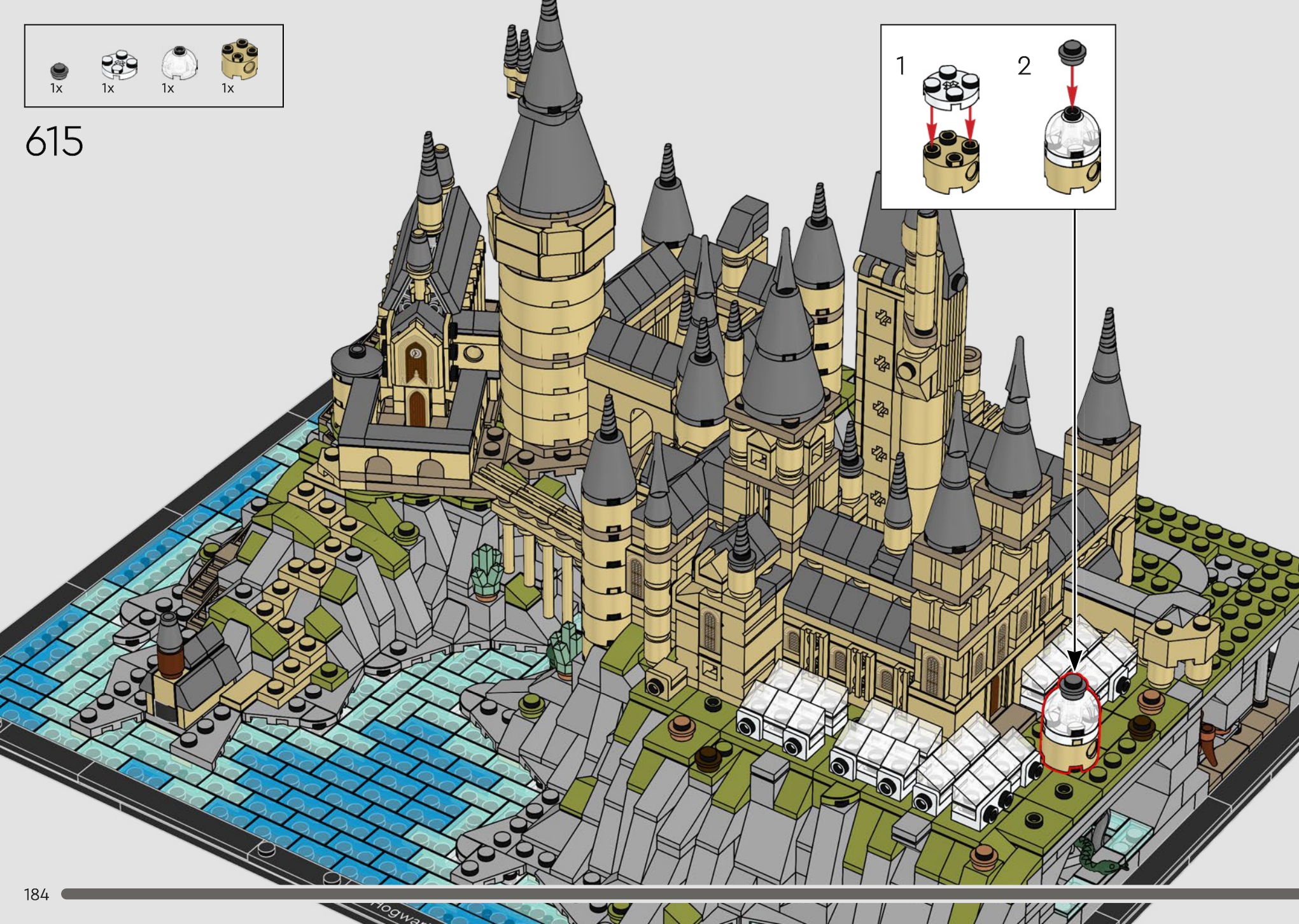
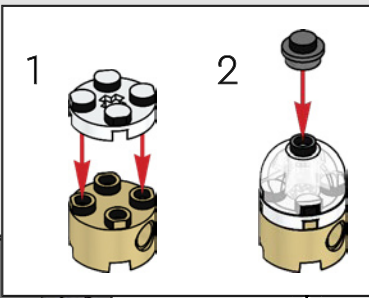



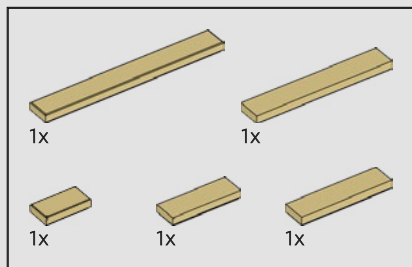

616

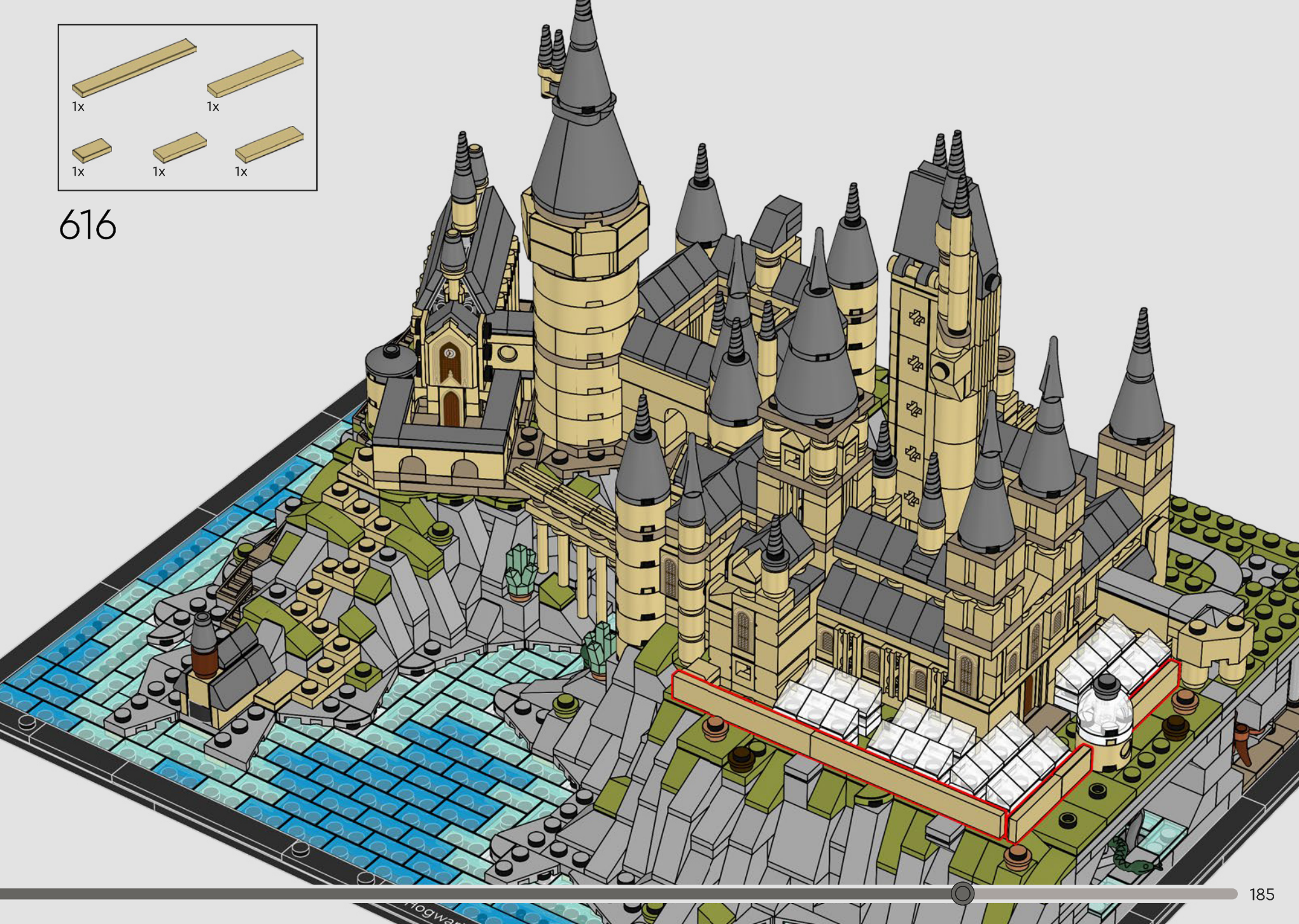



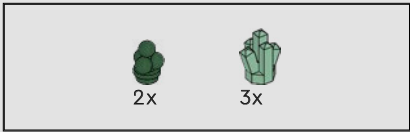

617

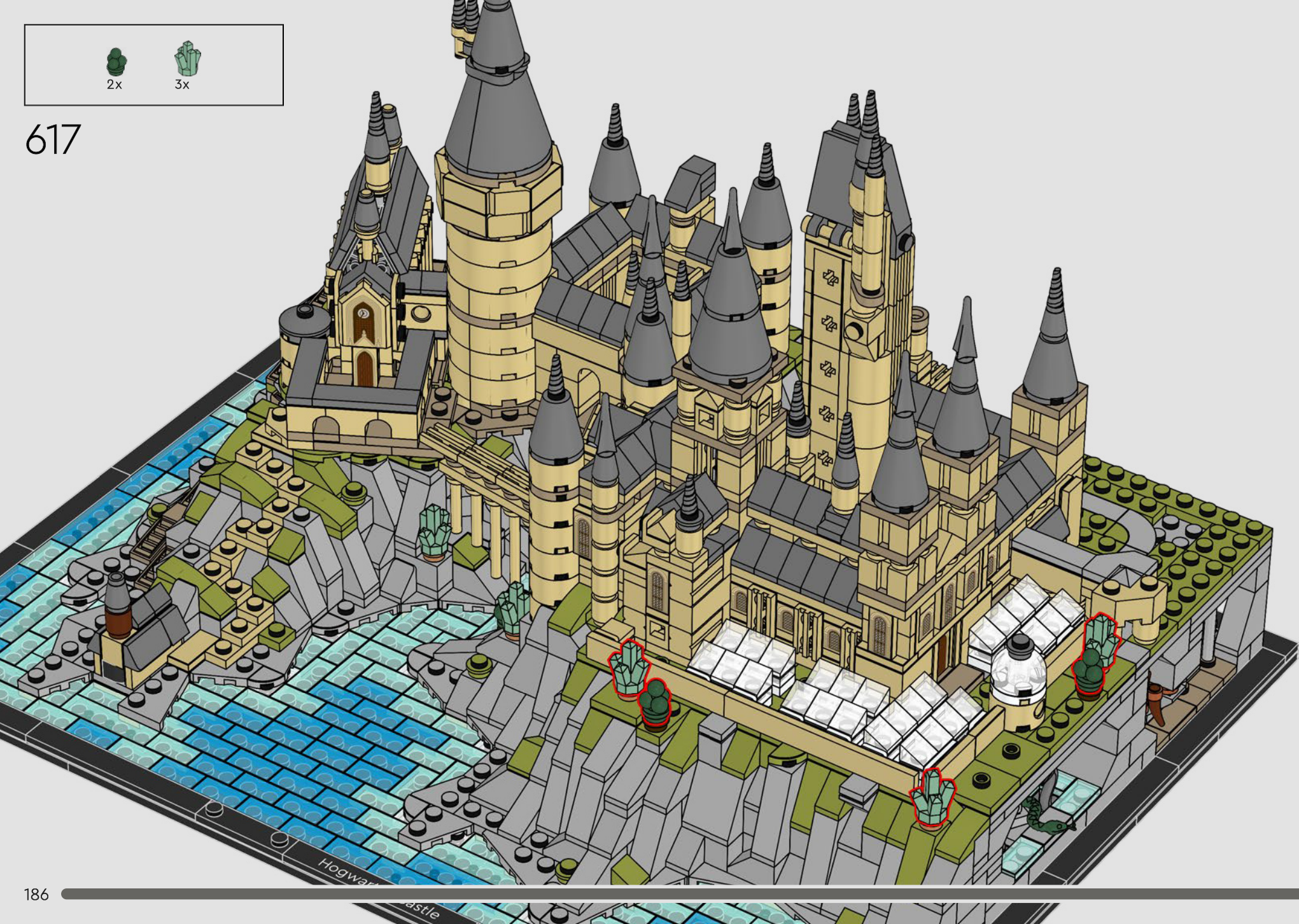



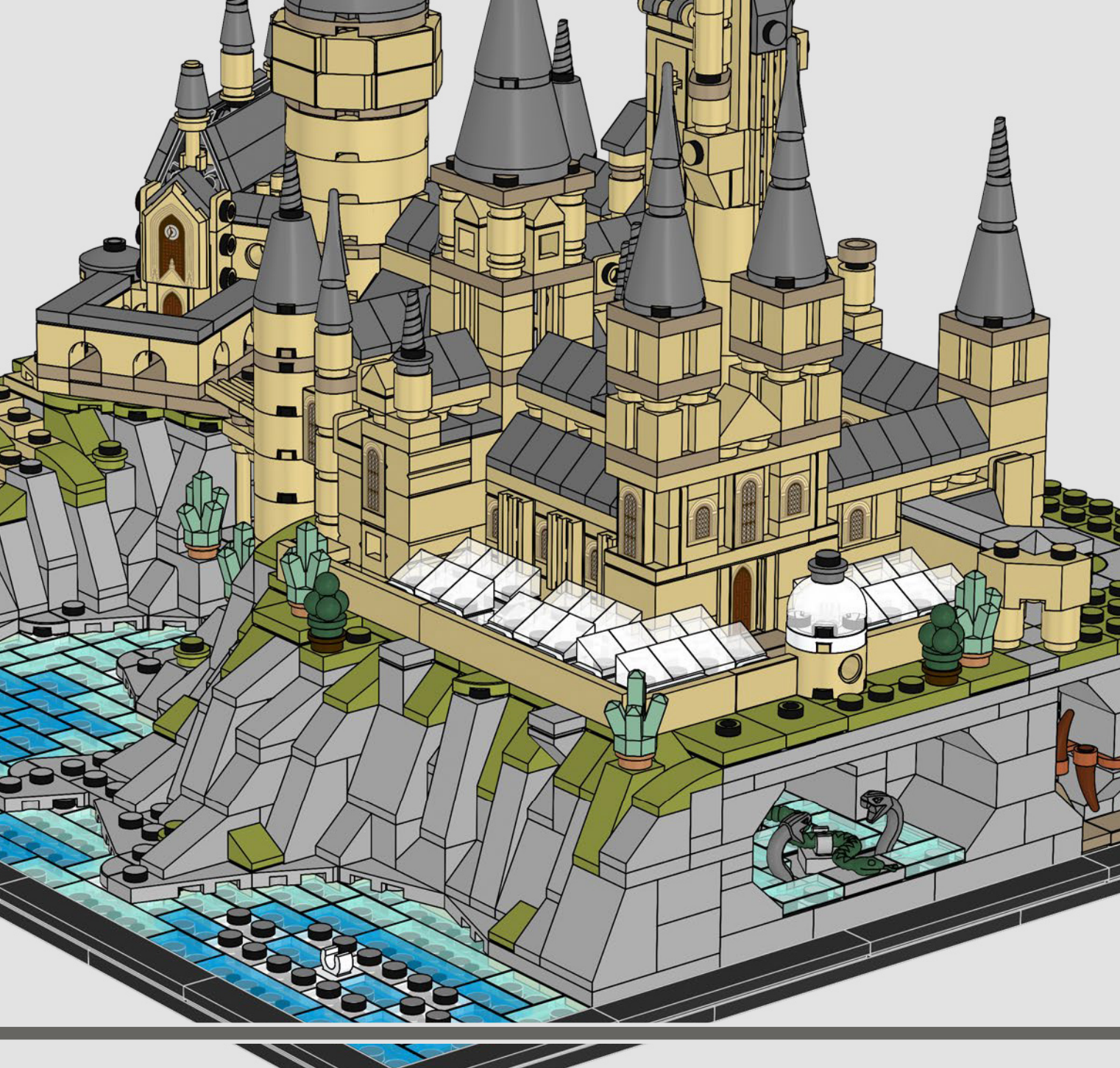

Los invernaderos son el lugar donde la Profesora Sprout, jefa del Departamento de Herbología de Hogwarts™, guía a los alumnos con seguridad en el cuidado y uso de las plantas mágicas. Ahora, que si todo el mundo usara sus orejeras...



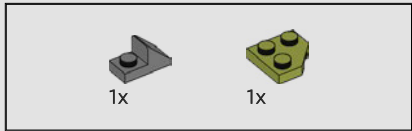

618

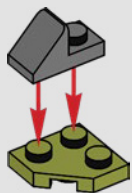

619

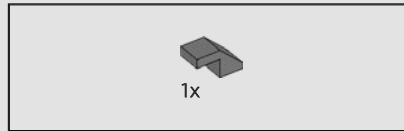
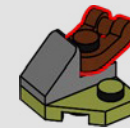

620

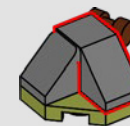



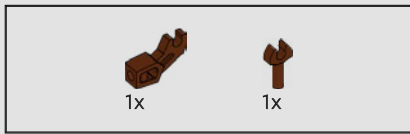

621

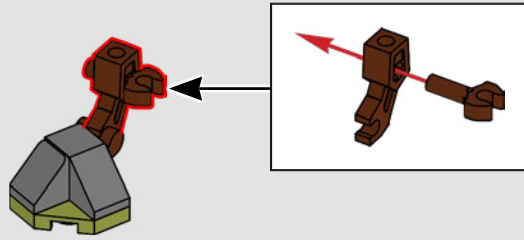

622



623

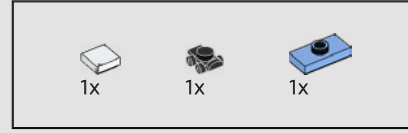
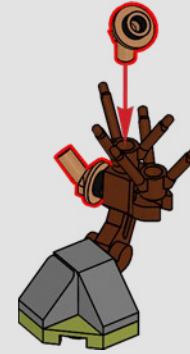

624

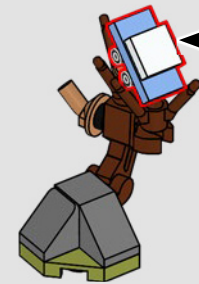
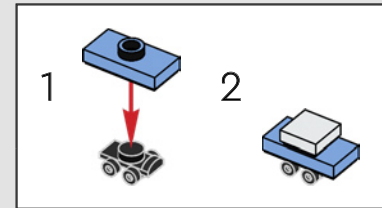





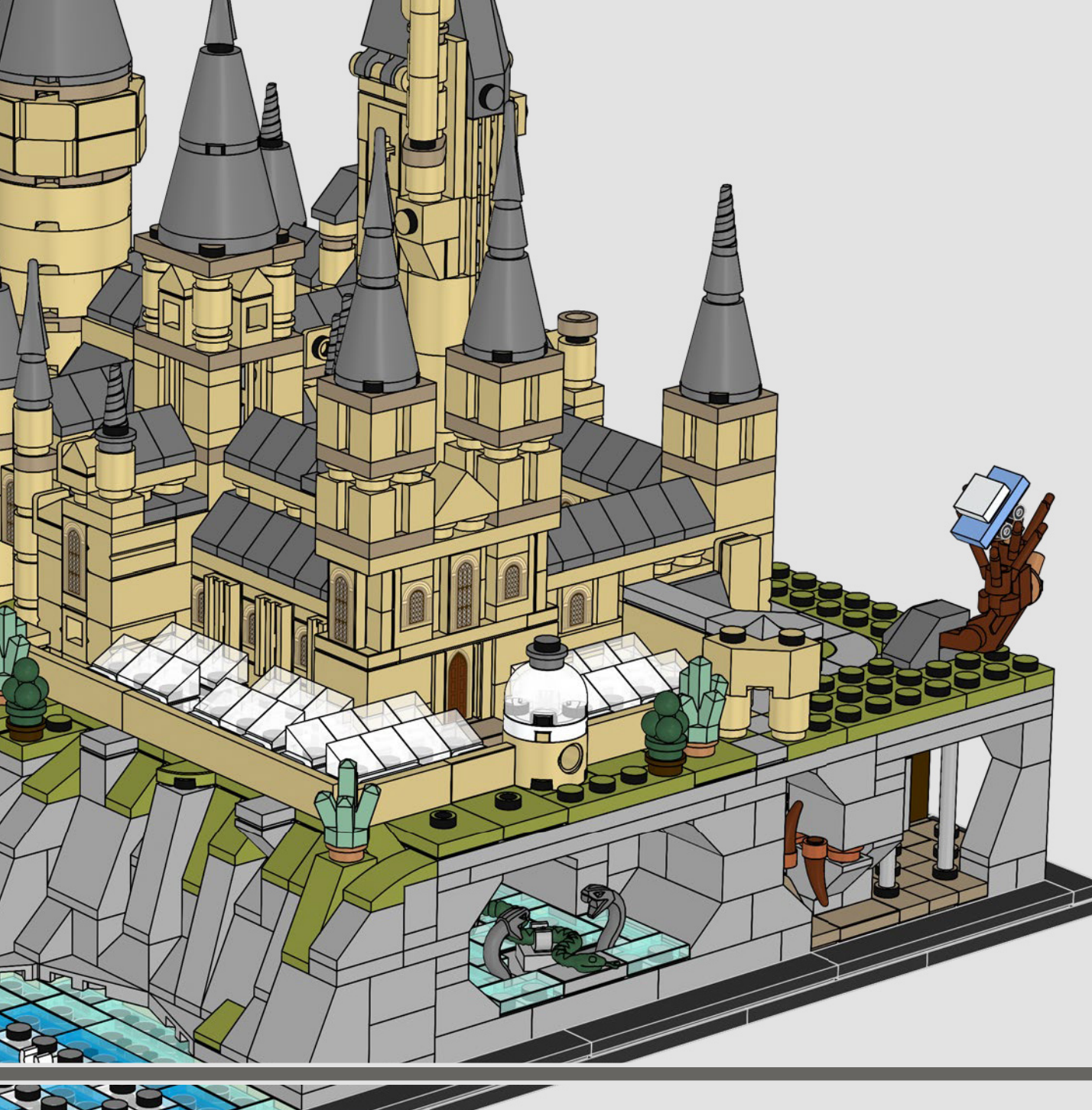

El Sauce Boxeador se plantó para que el Profesor Lupin pudiera escabullirse discretamente durante sus episodios de hombre lobo por efecto de la luna llena. Esconde un túnel secreto que conduce a la Casa de los Gritos, donde Lupin permanecía hasta recuperar su forma humana.





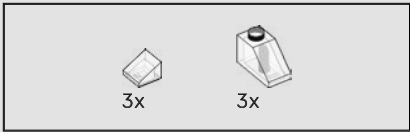

626

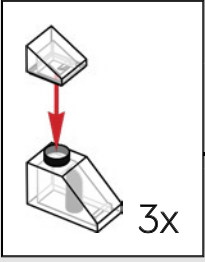
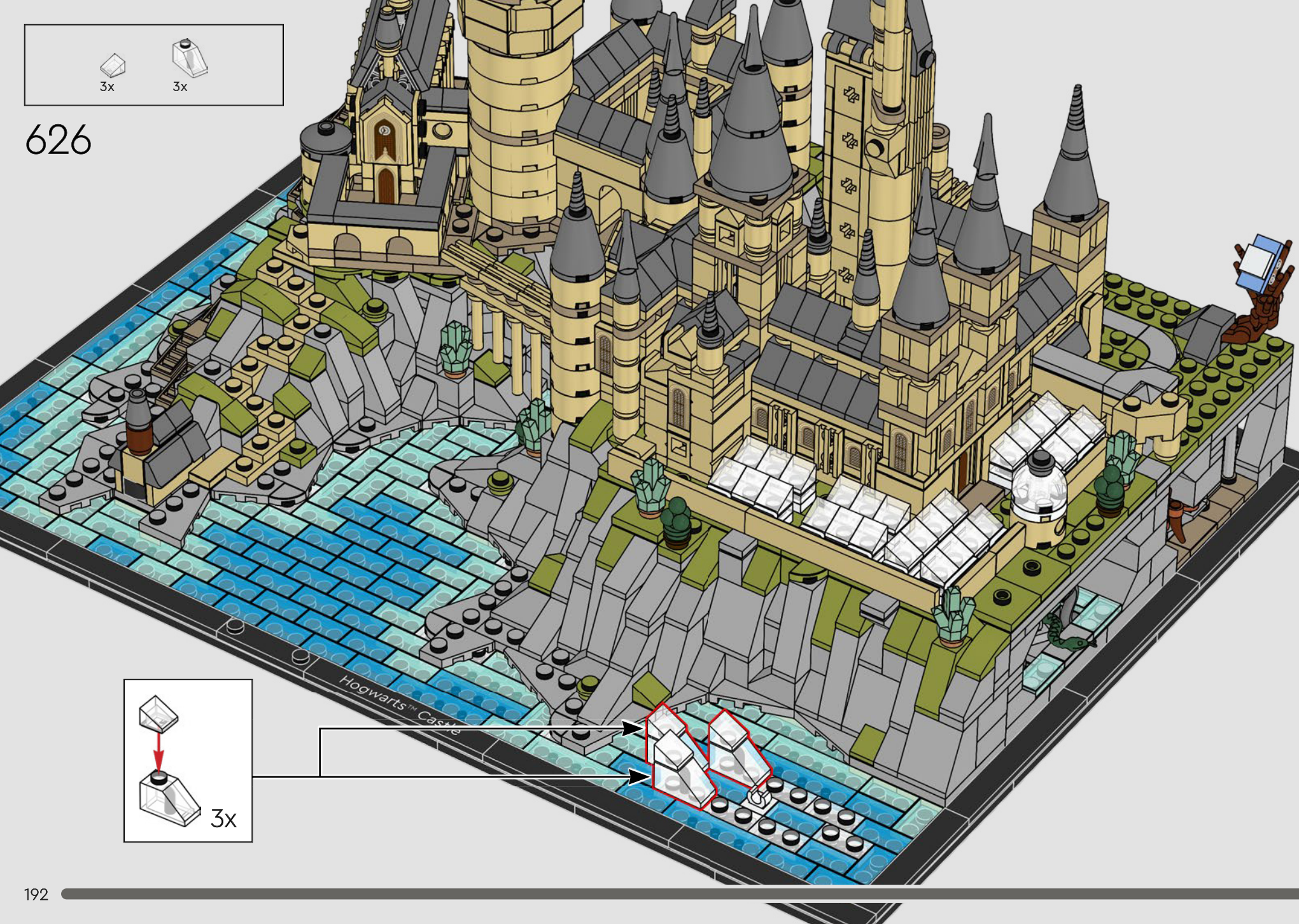





627

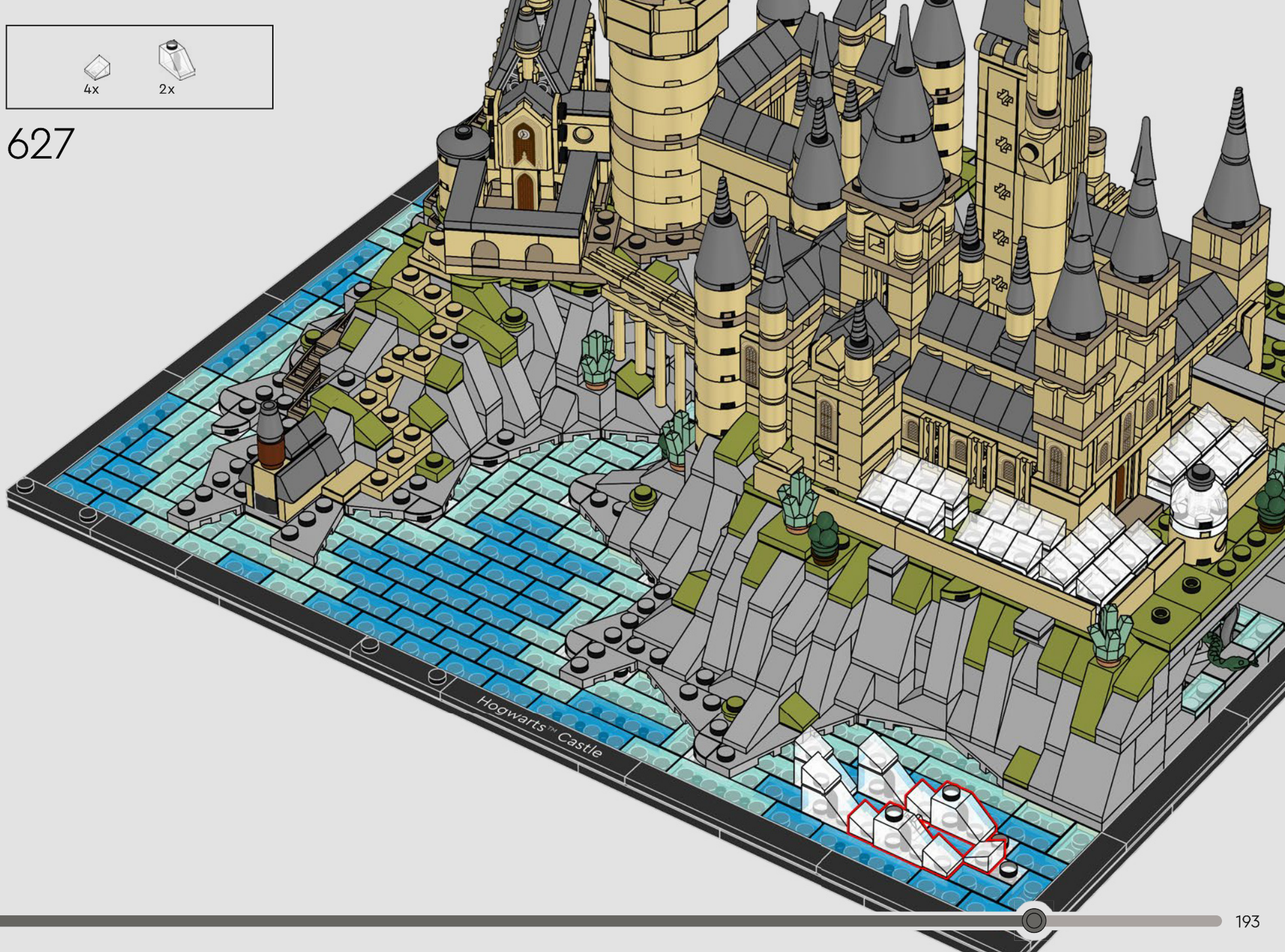

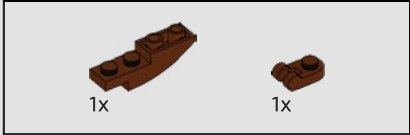
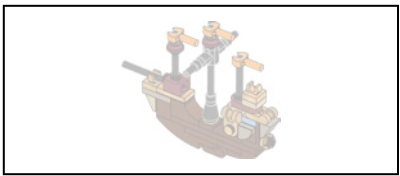

628

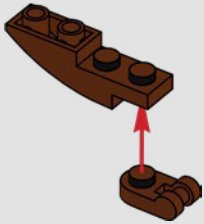

629

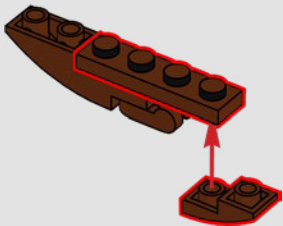

630

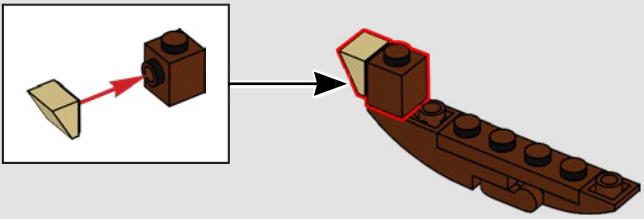

631

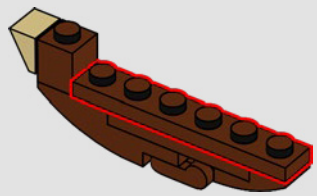



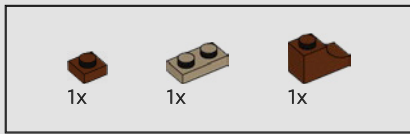

632

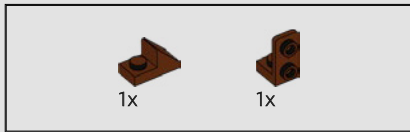
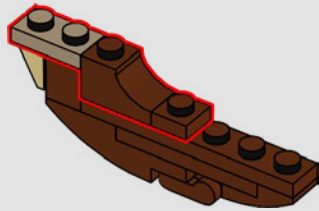

633

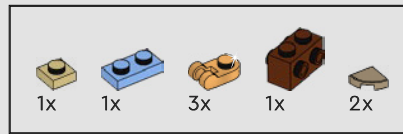
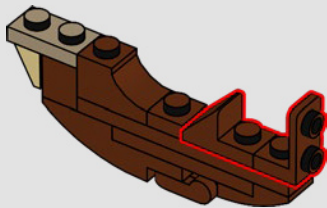

634

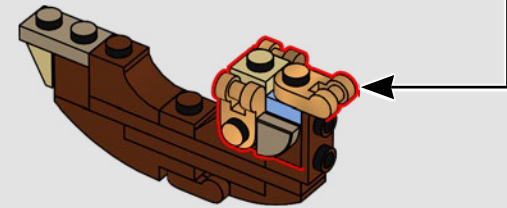
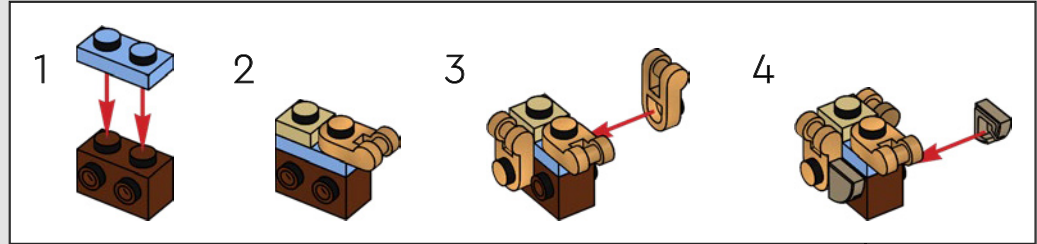

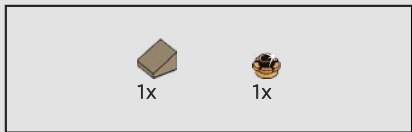

635

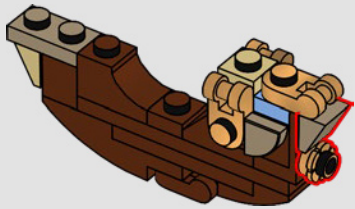

636

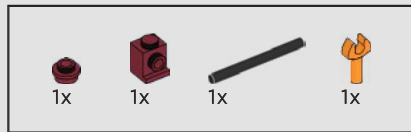
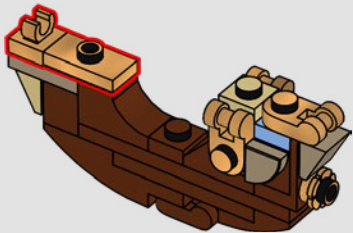

637

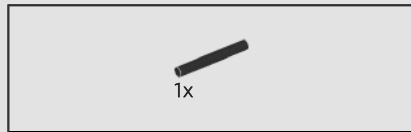
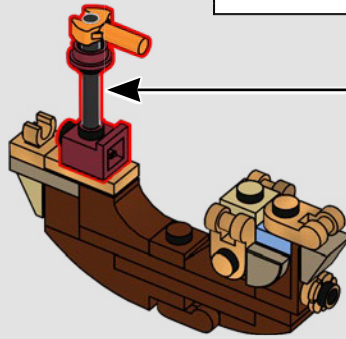
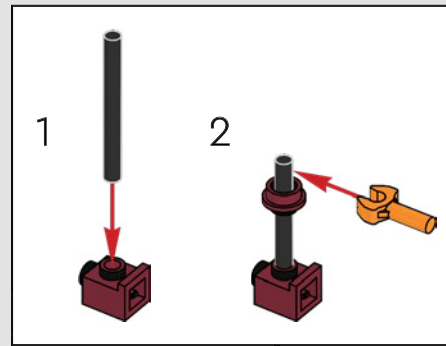

638

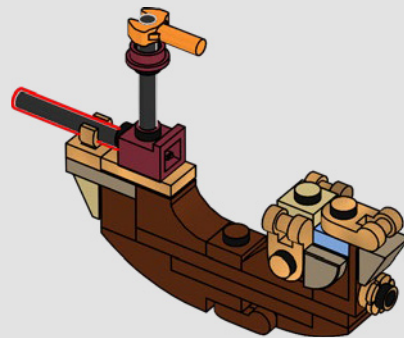

El Barco de Durmstrang se usaba para trasladar a los alumnos entre el Instituto Durmstrang y Hogwarts™ con motivo del Torneo de los Tres Magos. ¿Pero te has preguntado alguna vez cómo pasaba del mar del Norte al Lago Negro?



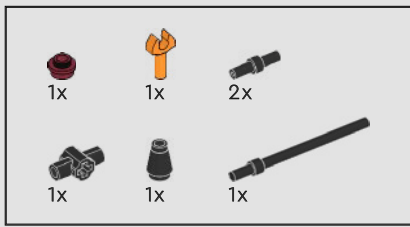

639

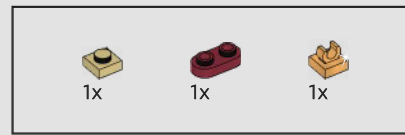
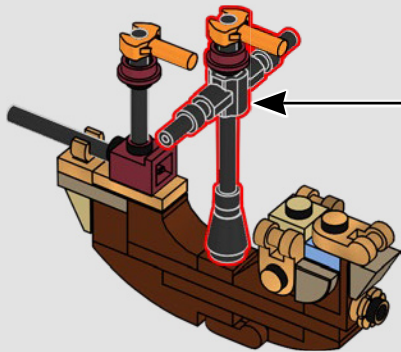
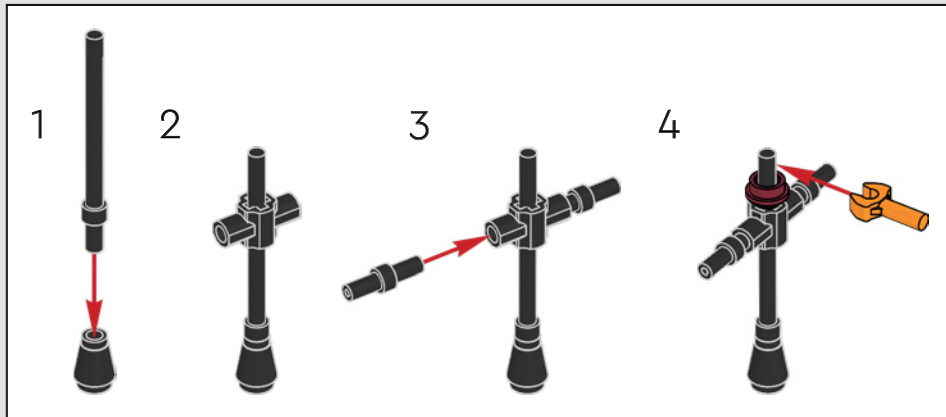

640

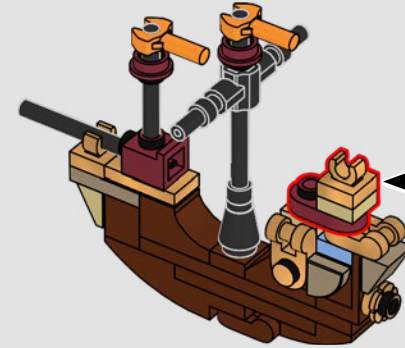
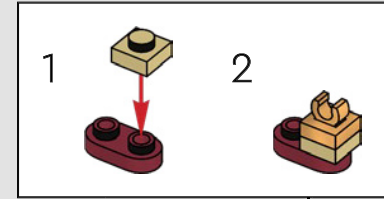

641

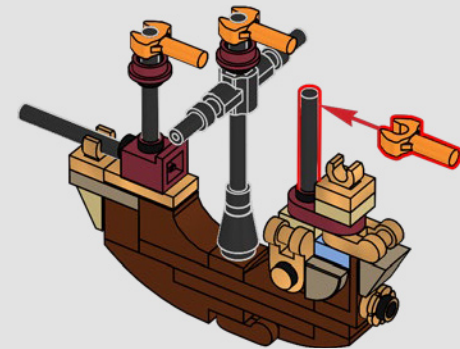







El Barco de Durmstrang llegaba hasta el lago a través de un acceso mágico creado entre este y otras masas de agua. ¡Magia en estado puro!



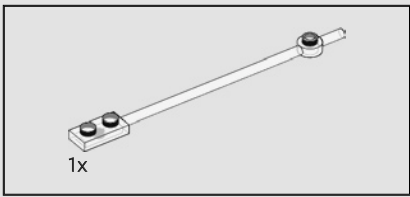

643









647

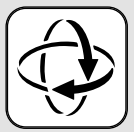
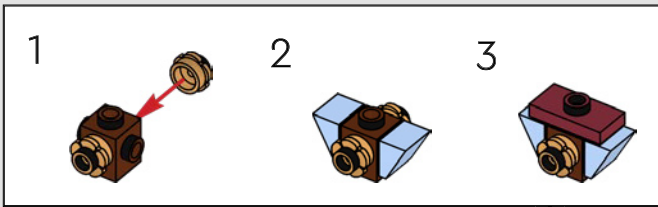

648

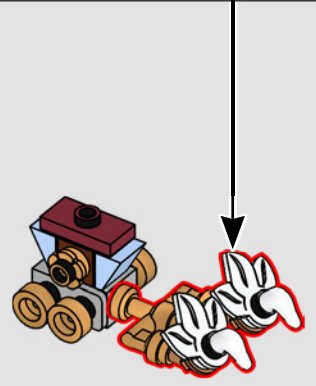
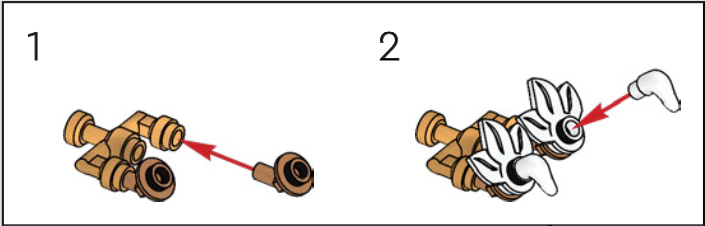



649

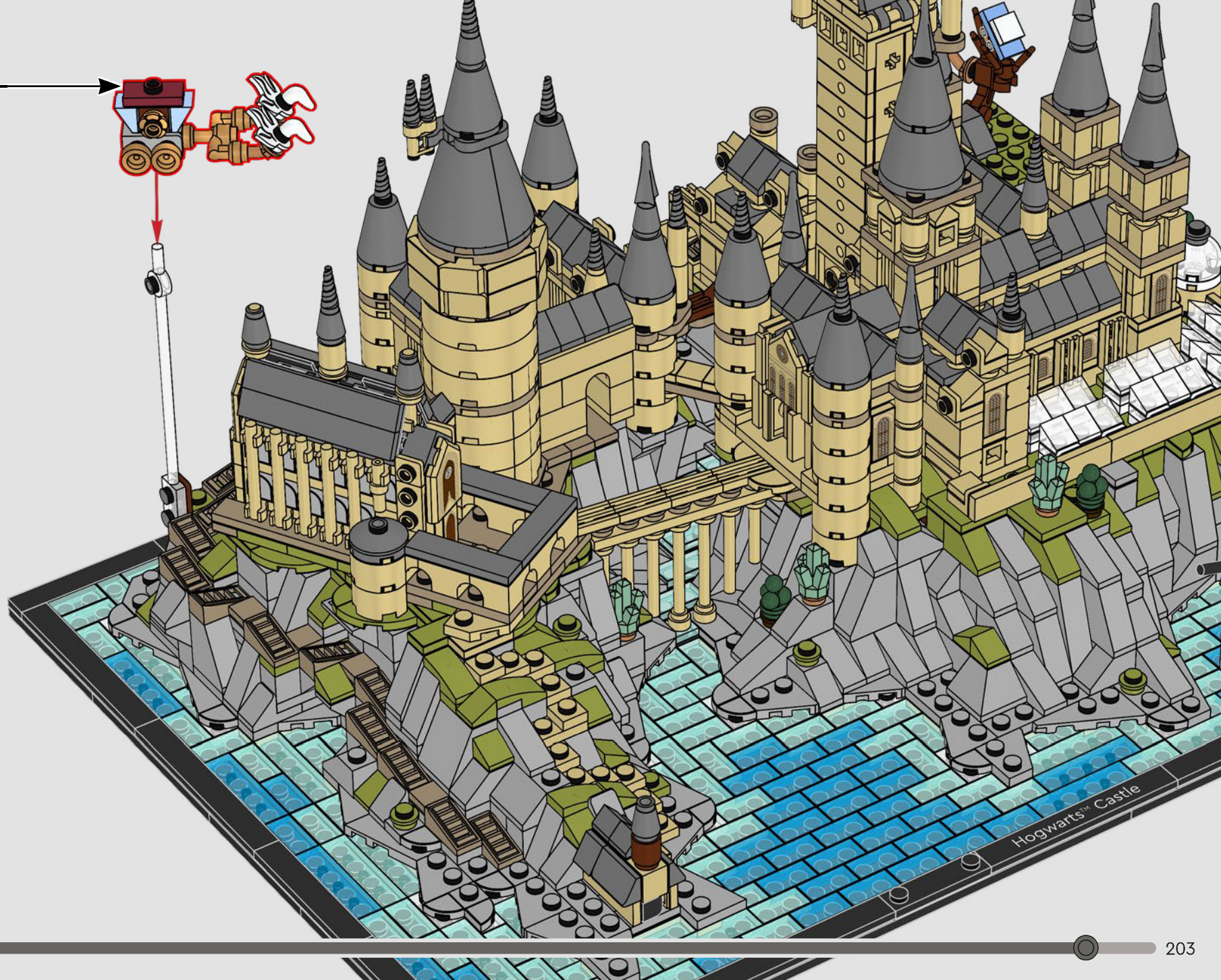



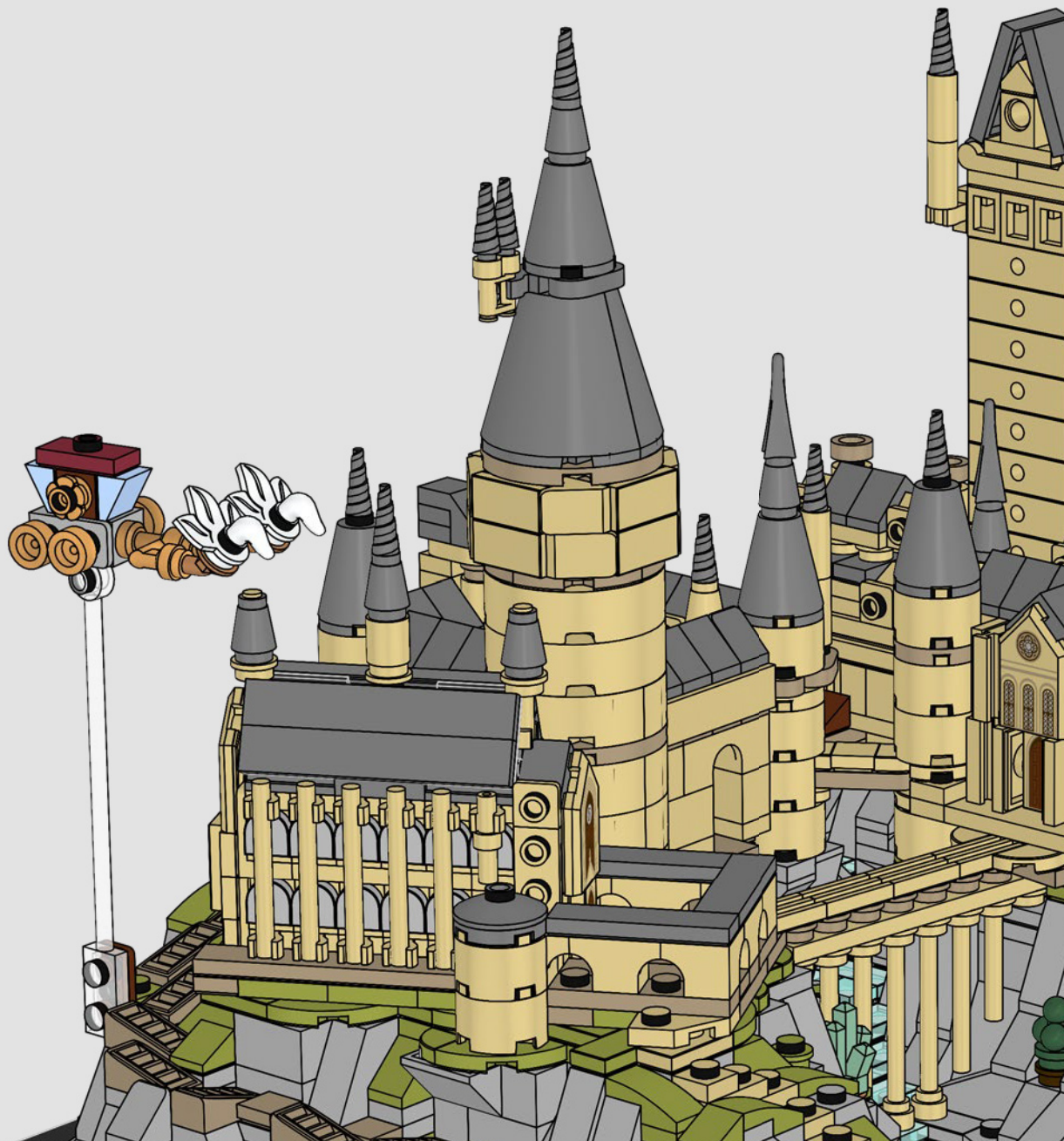

El Pegaso del Carruaje de Beauxbatons se construye con elementos LEGO® blancos que representan cuernos y hojas. ¿Te has fijado en las riendas? En realidad, ¡son un candelabro transformado como por arte de magia!



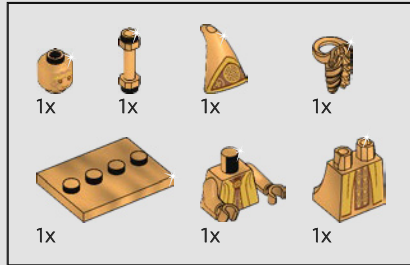

650

1

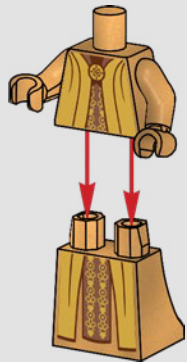

2

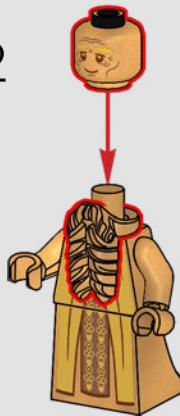

3

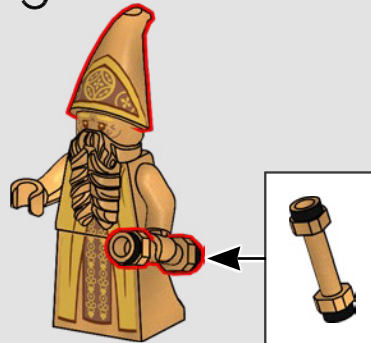

4



La minifigura del arquitecto de Hogwarts™ se creó exclusivamente para este set con un nuevo elemento que representa su barba y, además, lleva una maqueta de Hogwarts en una mano y un plano enrollado en la otra.

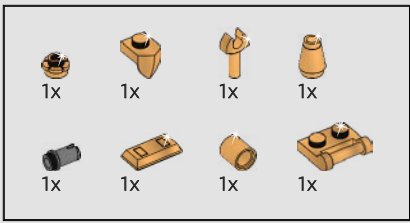

651

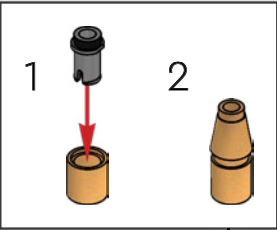

1

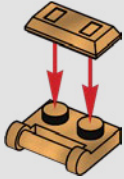

2

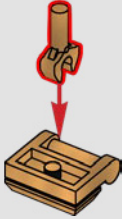

3

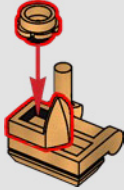

4







El arquitecto del  
Castillo de Hogwarts™  
estuvo activo en  
los años finales del  
siglo X. No se sabe  
mucho sobre su vida  
u otras obras.





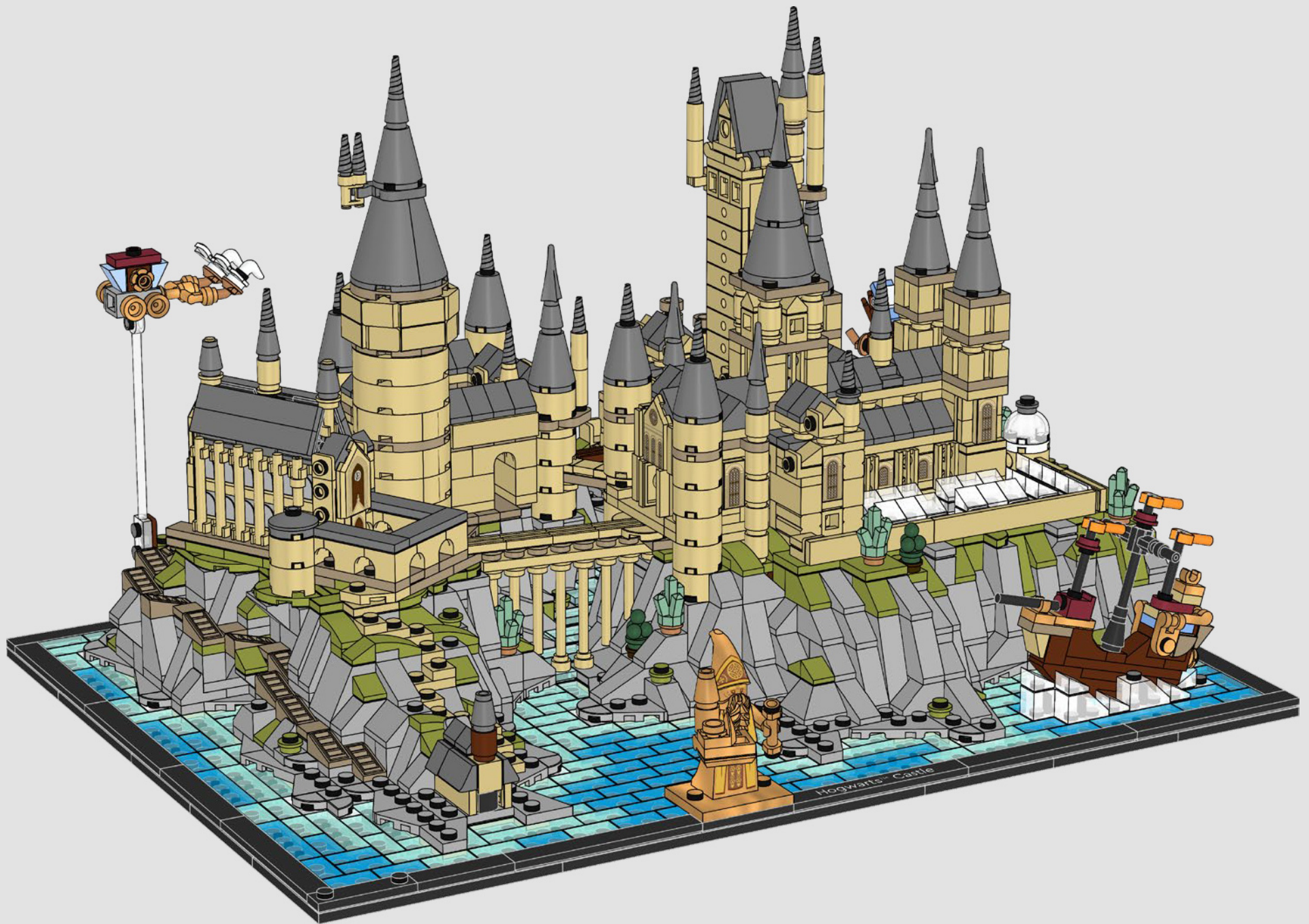







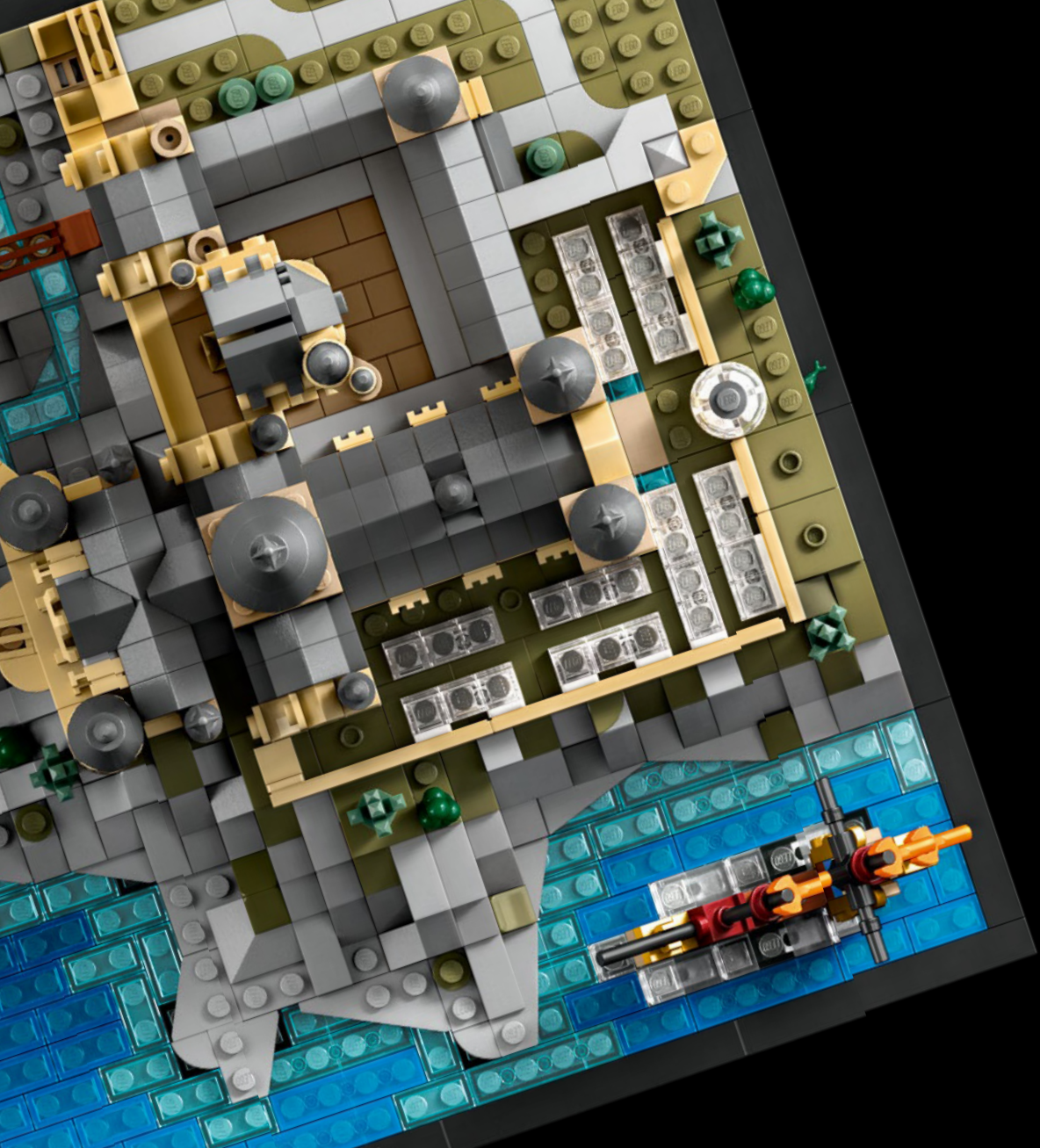

Hogwarts™ Castle



- 2x 614101
- 2x 6186681
- 2x 6328195
- 5x 307001
- 9x 302401
- 1x 6348055
- 8x 6242241
- 2x 4111971
- 2x 6382783
- 1x 6044691
- 1x 403201
- 1x 4667575
- 7x 302301
- 1x 6070698
- 3x 362301
- 11x 6195371
- 1x 4550745
- 1x 246501
- 3x 300201
- 2x 371001
- 2x 300101
- 1x 6222425
- 1x 366601
- 7x 6454936
- 27x 4117070
- 3x 4529237
- 63x 4161734
- 11x 6443061
- 2x 6353196
- 1x 4569547
- 1x 6167923
- 1x 4213568
- 1x 4224793
- 1x 6360037
- 1x 6454941
- 2x 6212758
- 5x 6351413
- 2x 6408047
- 1x 6447501
- 1x 6262018
- 1x 4624086
- 2x 4140562
- 2x 4579260
- 2x 4179771
- 4x 6175968
- 17x 6365720
- 3x 6374151
- 1x 6374192
- 1x 4213568
- 1x 4224793
- 1x 6360037
- 1x 6454941
- 2x 6212758
- 5x 6351413
- 2x 6408047
- 1x 6447501
- 1x 6262018
- 1x 4624086
- 2x 4140562
- 2x 4579260
- 2x 4179771
- 4x 6175968
- 17x 6365720
- 3x 6374151
- 6x 6236425
- 40x 4113917
- 34x 4114026
- 9x 6148262
- 43x 6092587
- 36x 4124456
- 10x 6455327
- 3x 6236914
- 8x 6069165
- 4x 4109995
- 1x 6024495
- 1x 6214334
- 2x 4159279
- 5x 6236423
- 1x 6445058
- 3x 6455326
- 10x 6391523
- 9x 6219794
- 2x 6103001
- 1x 4205107
- 7x 6174925
- 1x 6313611
- 1x 6117975
- 1x 6249809
- 2x 6253003
- 4x 4160483
- 1x 6374166
- 2x 4217562
- 5x 6443062
- 2x 4124455
- 6x 4114077
- 6x 4114306
- 2x 6221467
- 5x 6454937
- 16x 4114084
- 4x 4185177
- 1x 4188866
- 1x 6148265
- 12x 6055868
- 1x 6469454
- 1x 6458487
- 1x 6454439
- 11x 4121921
- 6x 6131896
- 2x 4162465
- 7x 4618651
- 1x 6058093
- 4x 6211966
- 9x 6410762
- 1x 6245271
- 1x 4543858
- 12x 6116614
- 9x 4118790
- 4x 4159739
- 2x 6175367
- 10x 4113233
- 5x 6232136
- 7x 6257600
- 5x 4550324
- 23x 6352222
- 2x 4113916
- 1x 6213676
- 2x 6294592
- 4x 6115031
- 2x 6454935
- 10x 4114309
- 1x 6351905
- 7x 4124067
- 2x 4112982
- 1x 4157277
- 3x 4243824
- 1x 6383728
- 7x 4113993
- 2x 4181134
- 4x 4114324
- 2x 4159774
- 1x 4544139
- 4x 4114001
- 4x 4113988
- 1x 6075179
- 1x 4624185
- 2x 447721
- 2x 611121
- 4x 614121
- 2x 362221
- 1x 302121
- 5x 371021
- 2x 6372124
- 4x 6315780
- 1x 6347604
- 5x 242023
- 5x 301023
- 2x 366623
- 17x 614124
- 6x 362224
- 3x 362324
- 1x 4188313
- 1x 6457333
- 1x 6350055
- 1x 6454443
- 3x 6212377
- 1x 6207933
- 1x 6092594
- 1x 6326425
- 1x 6454437
- 1x 4585493
- 1x 6378168
- 4x 6209691
- 1x 4529247
- 1x 6186672
- 1x 6453281
- 1x 6454435
- 1x 6256803
- 2x 6262138
- 1x 6415995
- 1x 6083975



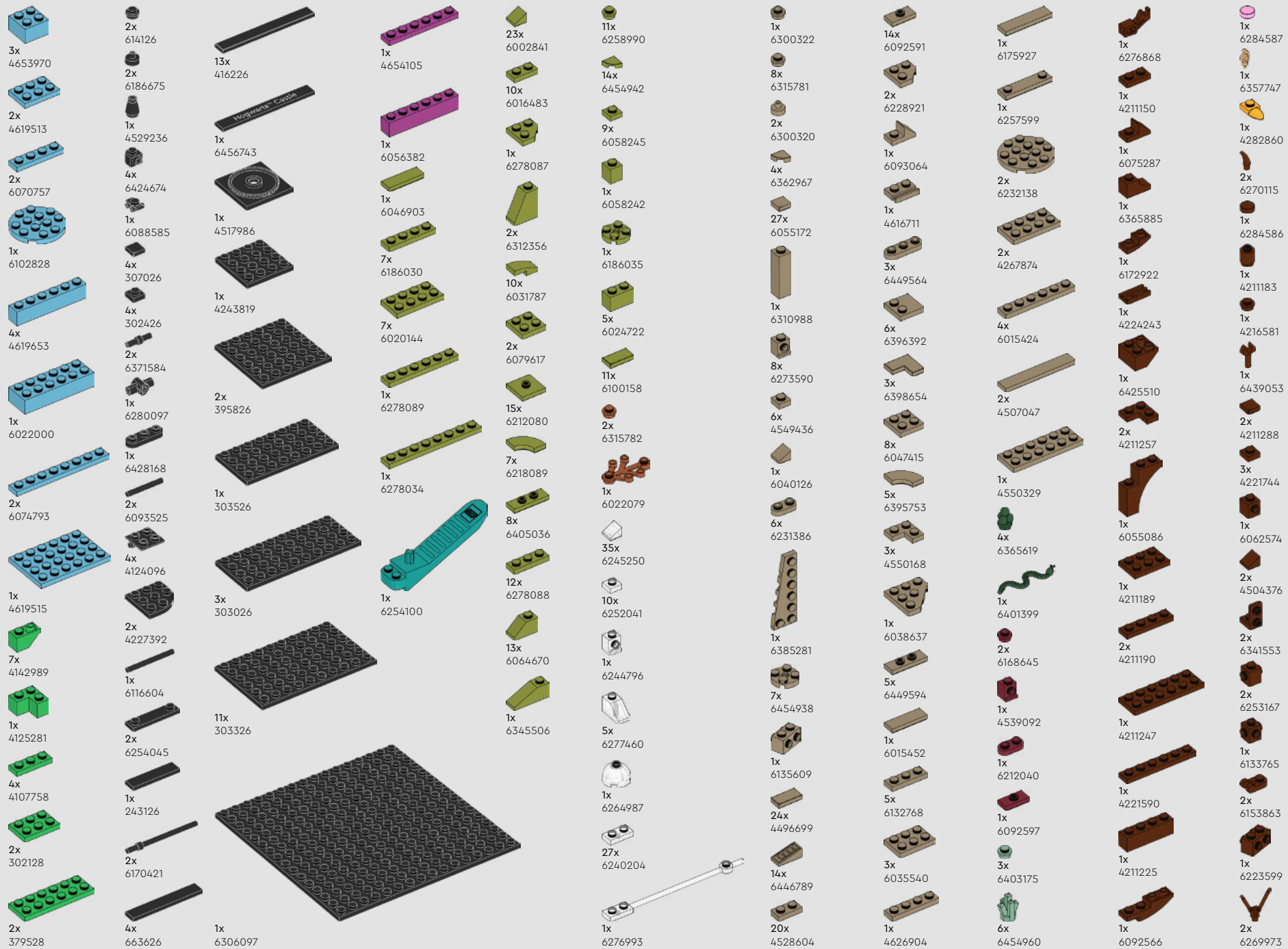

- 1x 4210763
- 2x 6168776
- 4x 4211066
- 2x 6331866
- 3x 4211094
- 1x 6126083
- 1x 6201630
- 10x 6092666
- 1x 6115080
- 1x 4211010
- 2x 6174938
- 17x 6445056
- 6x 6269969
- 15x 4529240
- 2x 6331689
- 1x 4210867
- 2x 4211100
- 8x 4210719
- 1x 4243831
- 1x 6186635
- 2x 4211103
- 3x 6231765
- 2x 4210633
- 1x 6431826
- 3x 6395635
- 4x 6454438
- 1x 4211098
- 5x 6343852
- 4x 4210651
- 4x 6262021
- 2x 4504378
- 2x 6234583
- 2x 6235153
- 7x 6167641
- 4x 6400315
- 51x 6251289
- 8x 6252050
- 1x 4179825
- 1x 6092601
- 1x 6221607
- 1x 6296892
- 45x 4226221
- 3x 4567887
- 14x 4211135
- 1x 4211088
- 3x 6069164
- 2x 6092572
- 3x 4211053
- 1x 4211105
- 1x 4529241
- 1x 6284071
- 3x 6448793
- 21x 6250597
- 1x 6455328
- 5x 4521921
- 23x 4211389
- 5x 6362975
- 12x 6176433
- 3x 6345639
- 2x 6433942
- 12x 6163478
- 6x 4211415
- 2x 4211489
- 1x 4526932
- 9x 4211394
- 1x 6420741
- 6x 4211791
- 5x 4211794
- 1x 6234738
- 18x 4211399
- 1x 6225242
- 46x 4211614
- 1x 6347715
- 3x 6258381
- 2x 4568637
- 2x 6075075
- 15x 4211488
- 2x 6211969
- 12x 4211428
- 7x 6116608
- 4x 6066097
- 5x 6186657
- 1x 4216248
- 3x 6308012
- 4x 6065824
- 1x 4651063
- 1x 6469440
- 1x 6269049
- 40x 4515374
- 12x 4211437
- 6x 4657459
- 2x 4211773
- 10x 4211445
- 13x 6093859
- 11x 4211494
- 46x 4211398
- 9x 4211414
- 2x 6170387
- 1x 4211564
- 2x 6123809
- 5x 4234535
- 8x 4211353
- 2x 4211410
- 1x 6163990
- 11x 4211396
- 2x 4211356
- 1x 6213378
- 13x 6435857
- 14x 4211349
- 11x 4211387
- 1x 4216250
- 3x 4211397
- 1x 6177078
- 1x 6126082
- 18x 4211429
- 8x 4211386
- 2x 6435930
- 1x 6306729
- 4x 6163477
- 1x 4645397
- 3x 4558169
- 1x 6075066
- 3x 4211438
- 2x 4211393
- 1x 4618874
- 2x 4243797
- 2x 4211549
- 1x 6015347
- 7x 4211385
- 2x 4211395
- 1x 6372029
- 1x 4211392
- 6x 4211404
- 1x 6037399
- 1x 4211474
- 3x 4251149
- 2x 4211521
- 2x 4211407
- 3x 6059033
- 3x 4211452
- 1x 4211795
- 2x 4211425
- 6x 4157103
- 3x 6439042
- 3x 4173805
- 16x 4121739
- 17x 4220634
- 23x 4164037
- 10x 6254256
- 85x 6251295
- 3x 6343877
- 11x 6252049
- 1x 4211522
- 1x 4211402
- 1x 4211405

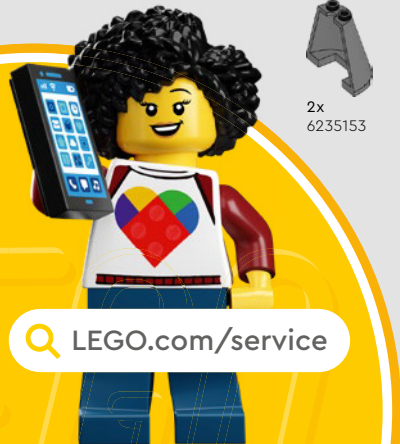

 [LEGO.com/service](https://www.LEGO.com/service)





# YOU COULD WIN



## YOU COULD WIN

Your feedback will help shape the future development of this product series.

Visit:

## DU KÖNNTEST GEWINNEN

Dein Feedback trägt zur Weiterentwicklung dieser Produktreihe bei.

Geh auf:

## VOUS POURRIEZ GAGNER

Vos commentaires nous aideront à concevoir les futurs produits de cette gamme.

Visitez :

## POTRESTI VINCERE TU

La tua opinione ci aiuterà a migliorare la creazione futura di questa linea di prodotti.

Visita:

## PUEDES GANAR

Tu opinión contribuirá al futuro de esta serie de productos.

Visita:

## 轻松获奖

您的反馈将有助于我们在今后改进本产品系列。

请访问:

---

**[LEGO.com/productfeedback](https://www.lego.com/productfeedback)**

---

You also have the chance to win a LEGO® set.

Terms and conditions apply.\*

Außerdem hast du die Chance, ein LEGO® Set zu gewinnen.

Es gelten die Teilnahmebedingungen.\*

Vous pourriez également gagner un ensemble LEGO®.

Des conditions s'appliquent.\*

Hai anche la possibilità di vincere un set LEGO®.

Termini e condizioni sono applicabili.\*

También tienes la oportunidad de ganar un set LEGO®.

Aplican términos y condiciones.\*

您还有机会赢取乐高®套装。

条款和条件适用。\*

\*[LEGO.com/productfeedback-terms](https://www.lego.com/productfeedback-terms)

# II

LEGO and the LEGO logo are trademarks of the LEGO Group. ©2023 The LEGO Group.

WIZARDING WORLD and all related trademarks, characters, names, and indicia are  
© & ™ Warner Bros. Entertainment Inc. Publishing Rights © JKR. (s23)