

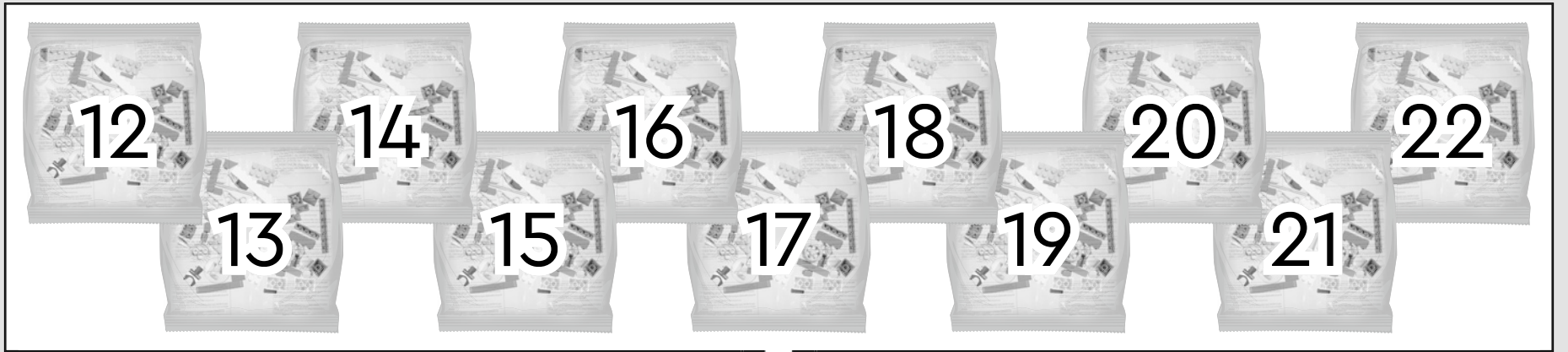

Harry Potter



WIZARDING  
WORLD





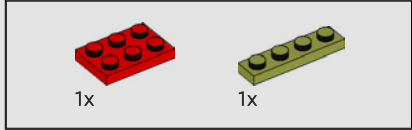
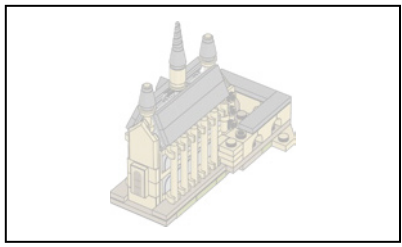

309

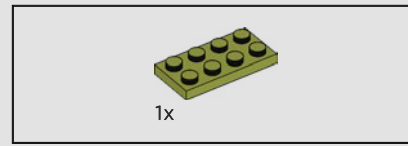
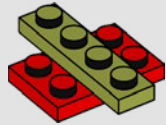

310

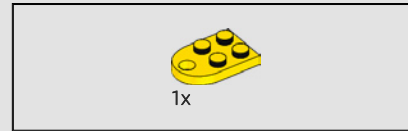
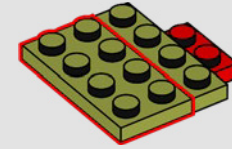

311

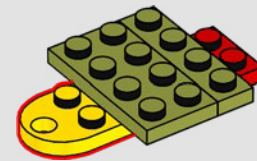

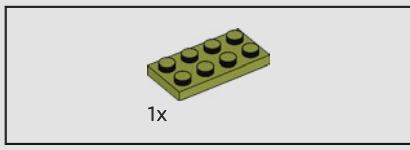

312

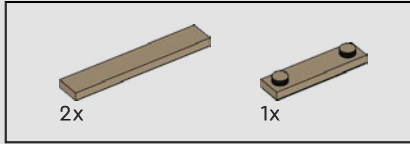
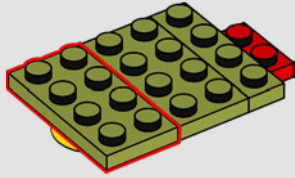

313

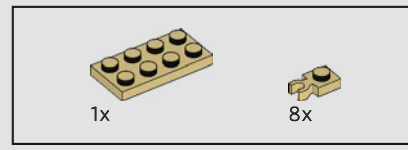
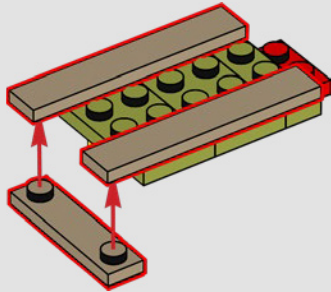

314

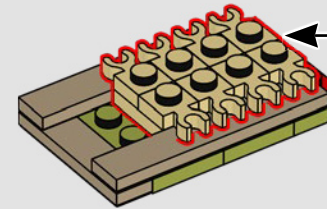
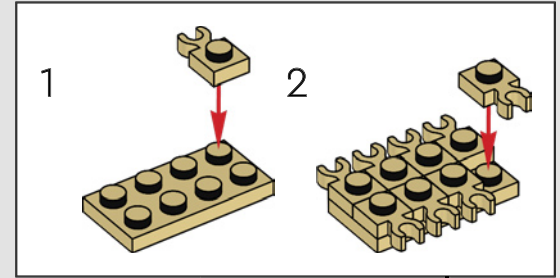

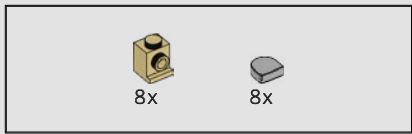

315

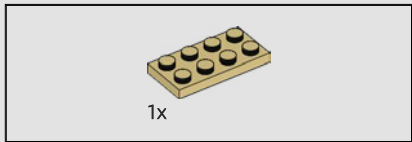
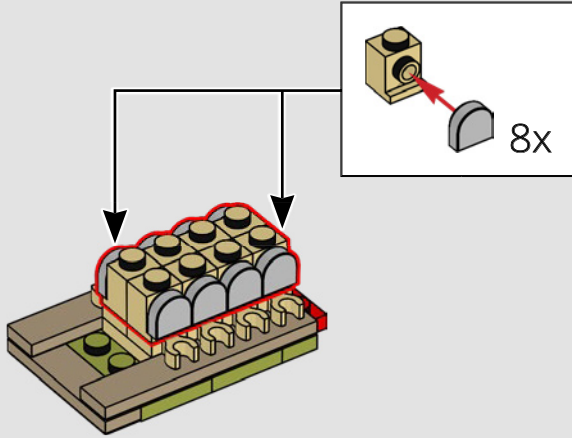

316

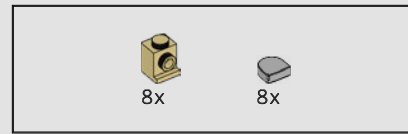
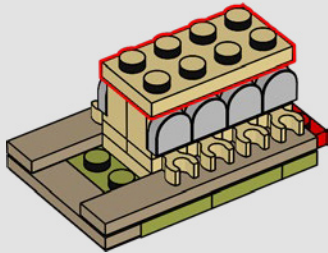

317

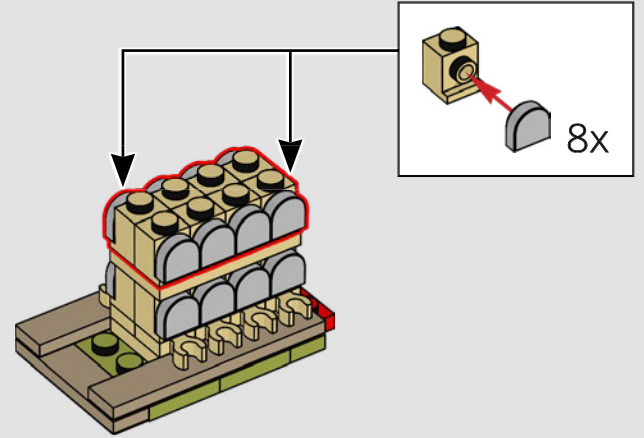

318

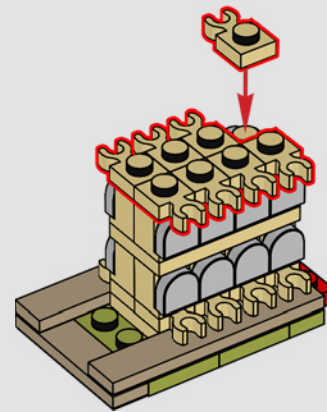

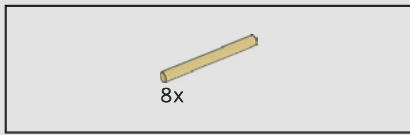

319

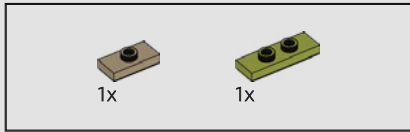
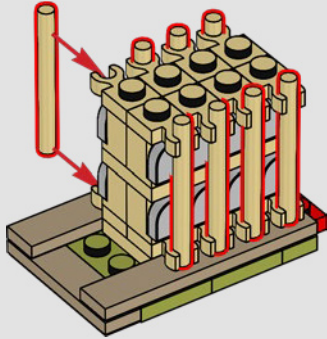

320

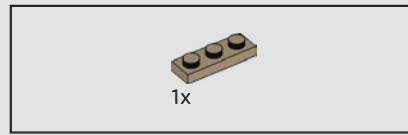
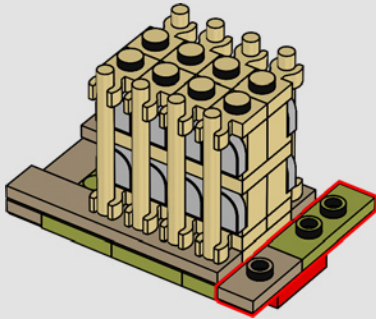

321

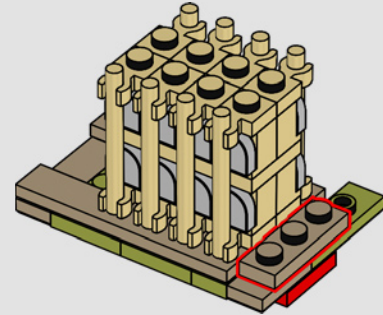

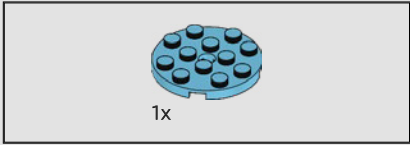
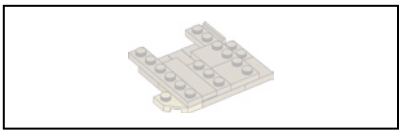

322

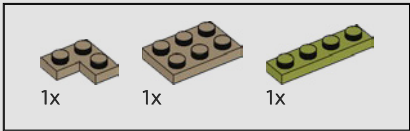
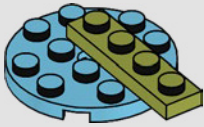

323

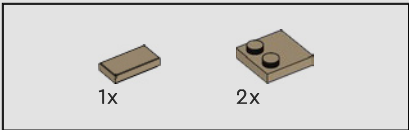
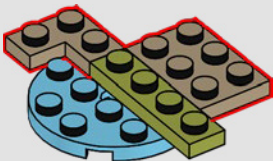

324

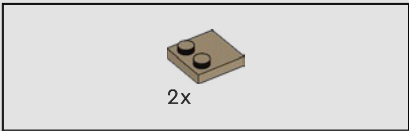
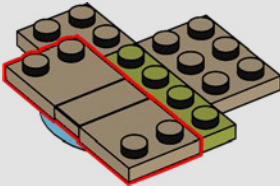

325

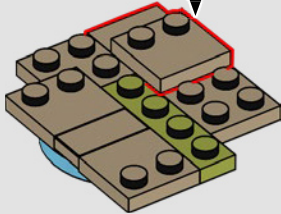
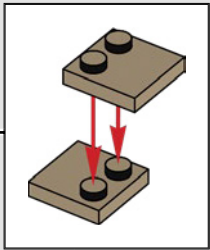



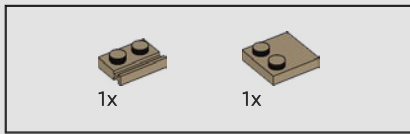

326

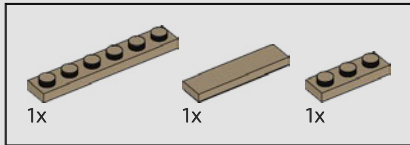
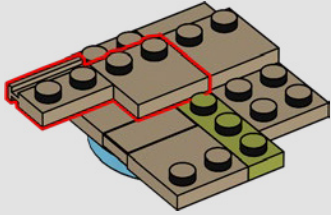

327

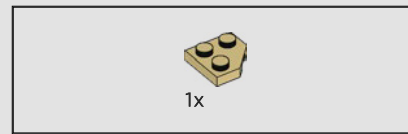
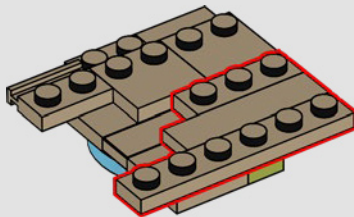

328

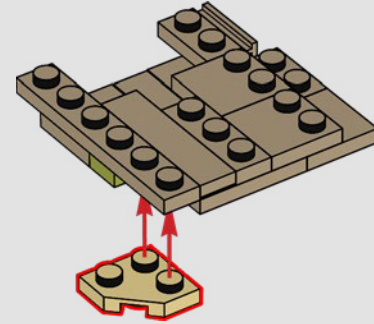
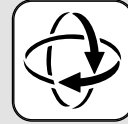

329

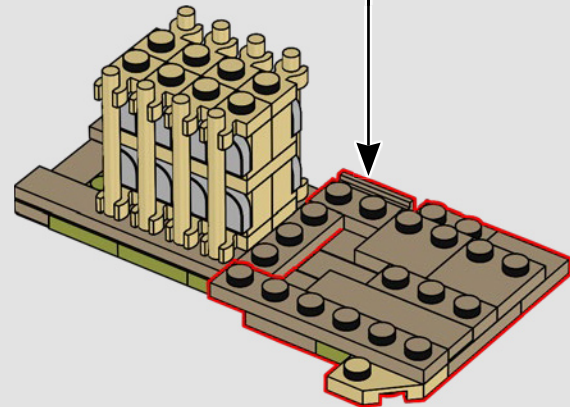

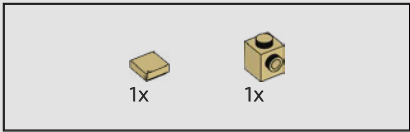

330

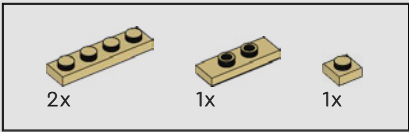
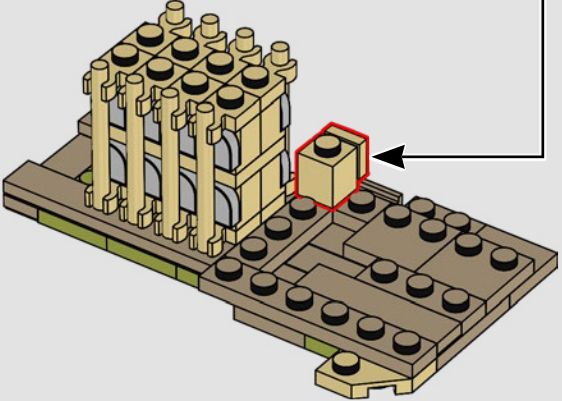
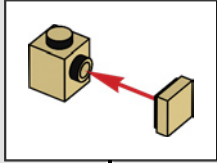

331

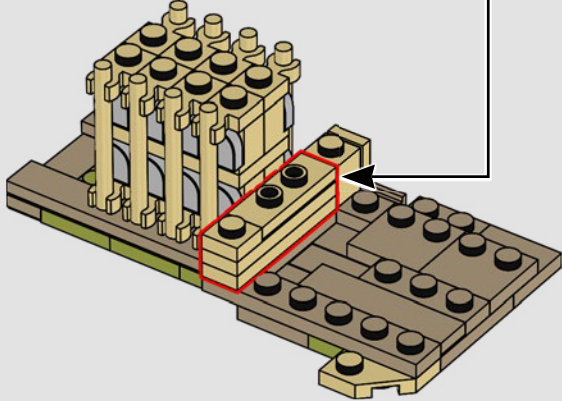
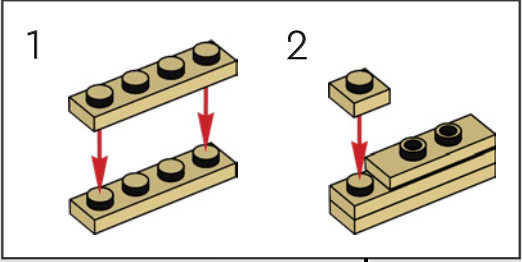

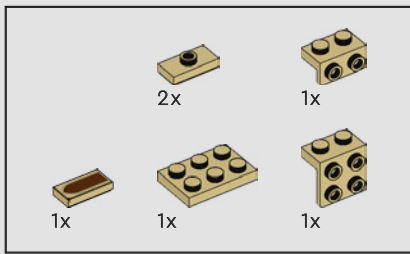

332

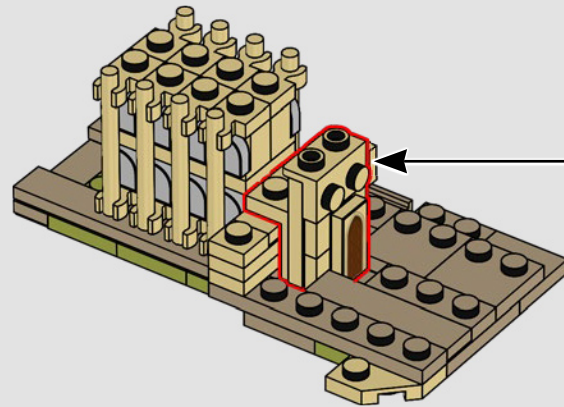
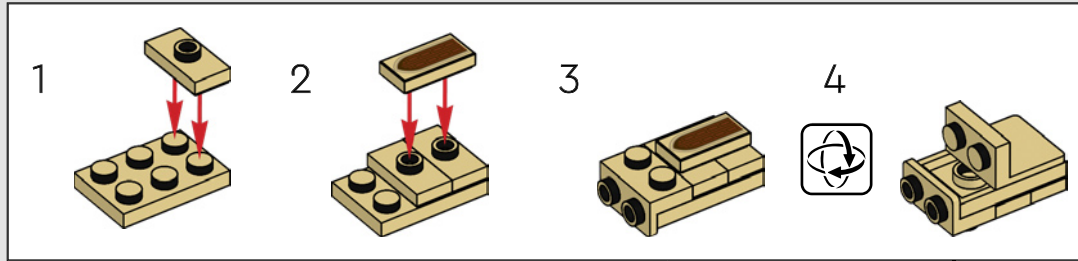

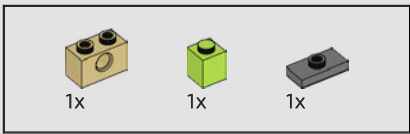

333

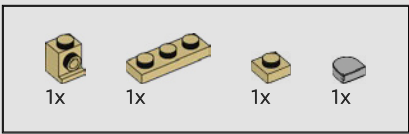
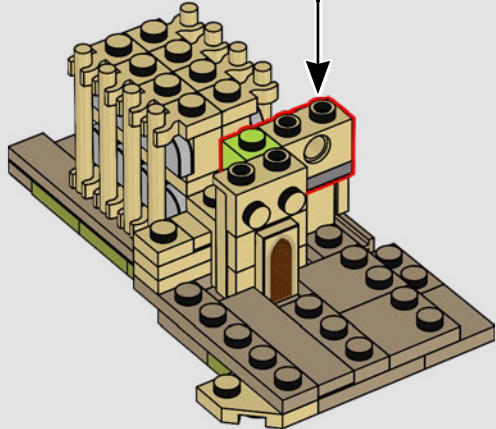
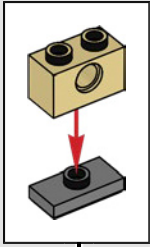

334

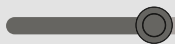
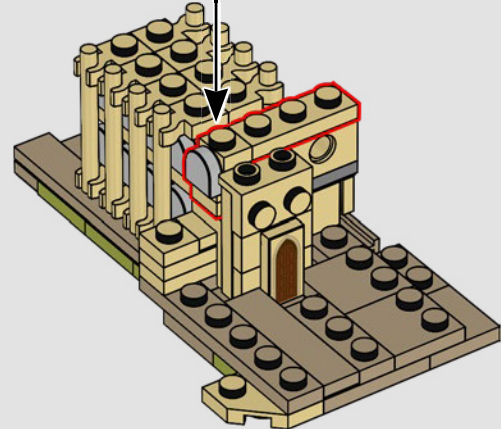
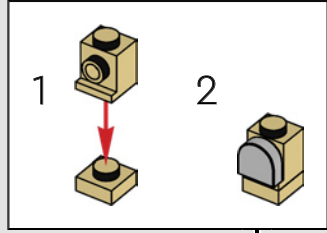



335

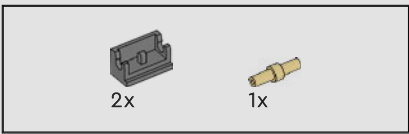
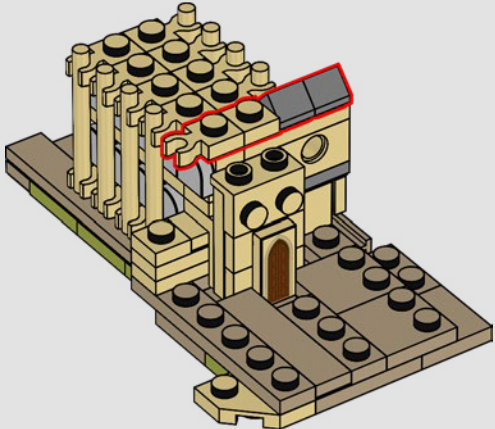

336

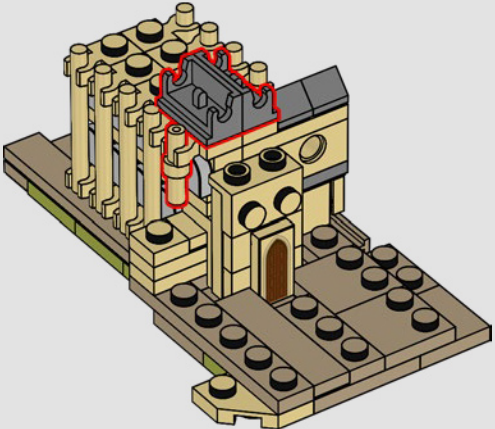

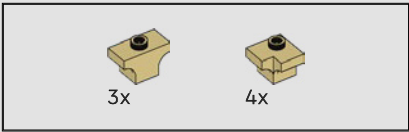

337

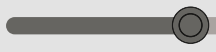
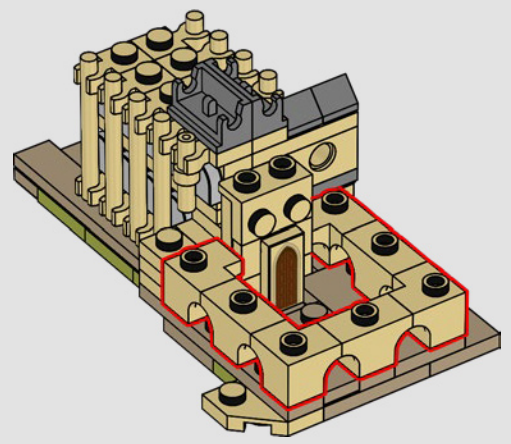

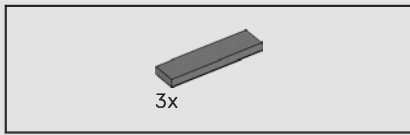

338

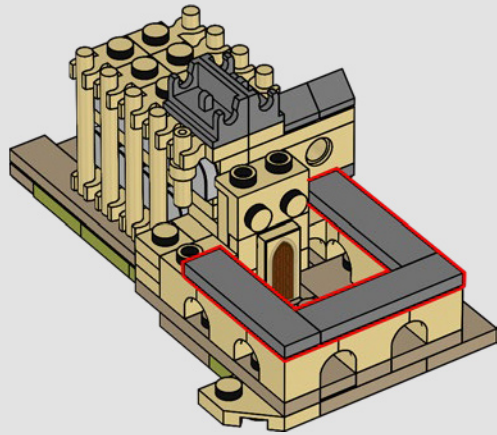

339

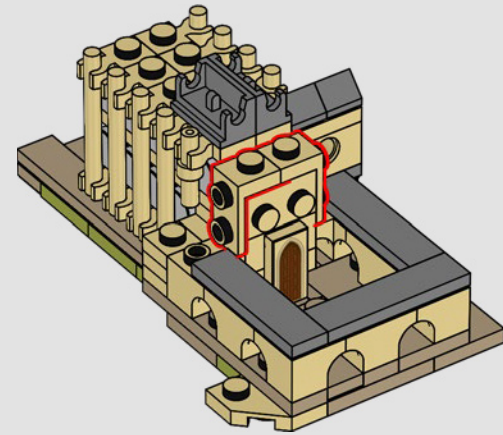



340

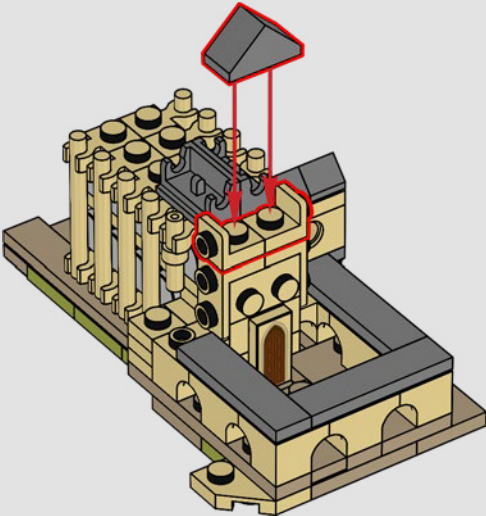

341

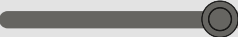
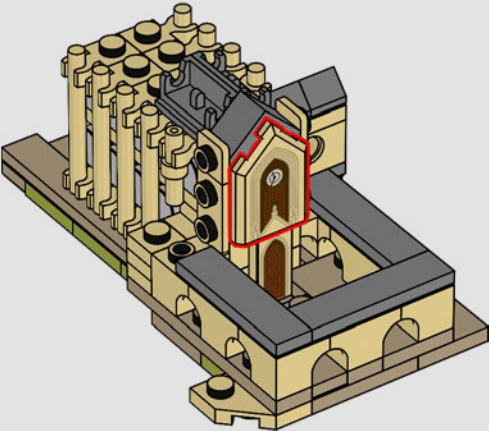



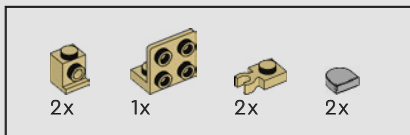

342

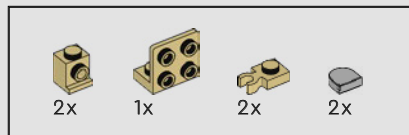
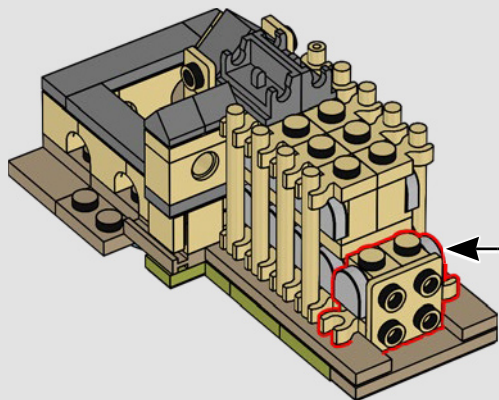
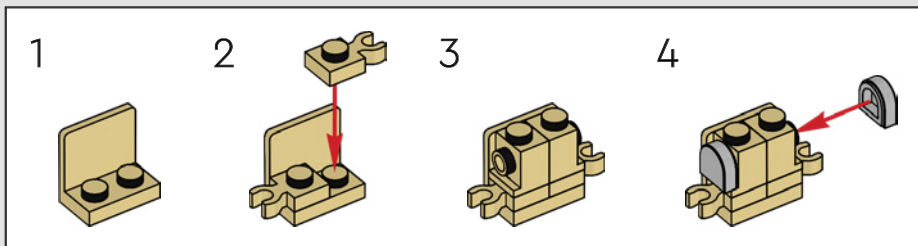

343

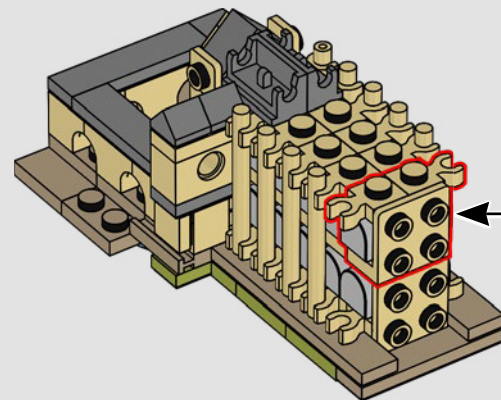
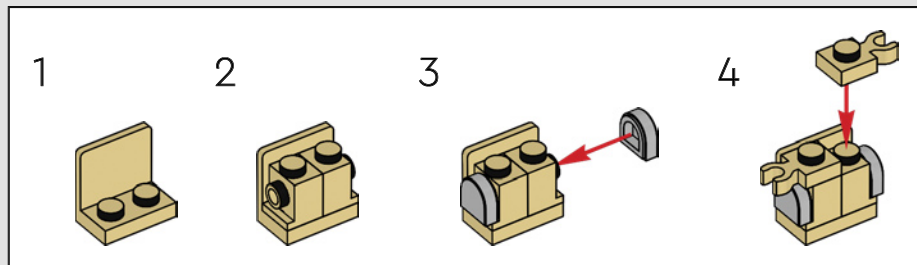

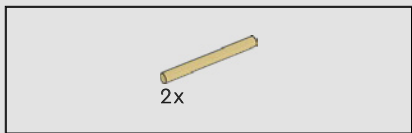

344

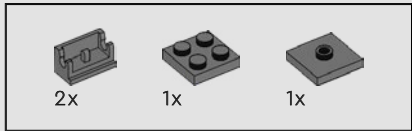
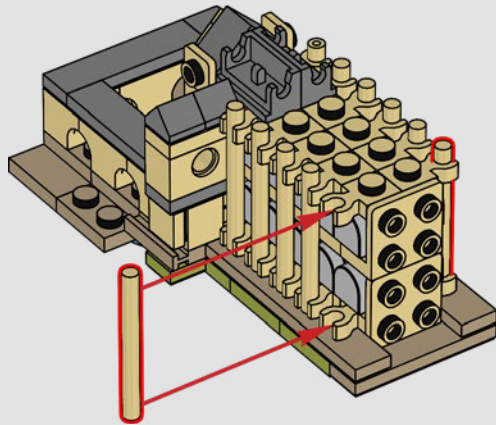

345

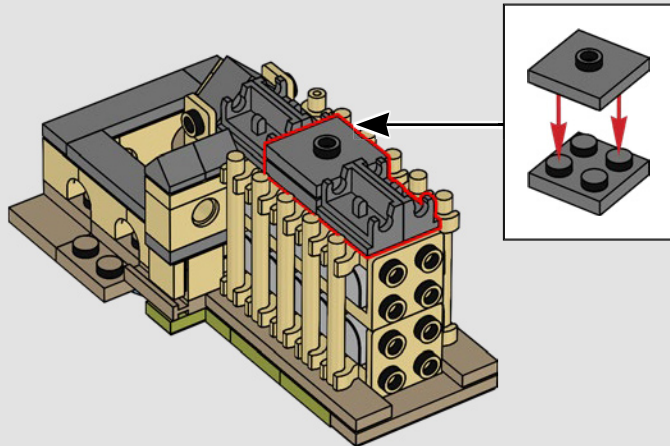

346

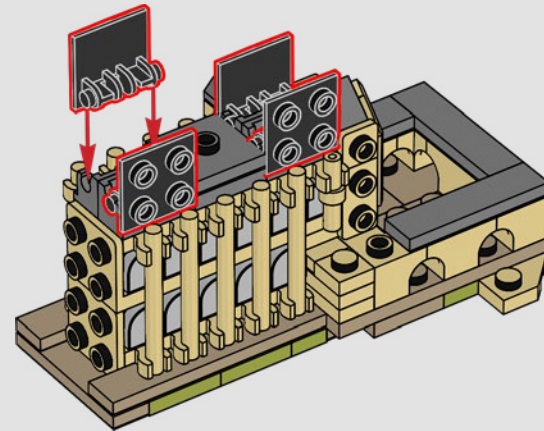
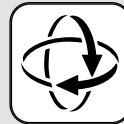

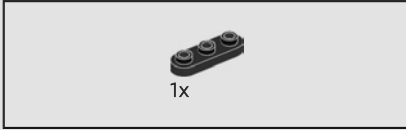
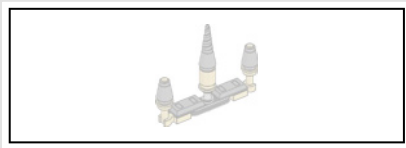

1x

347

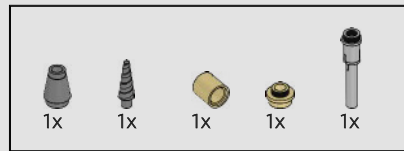
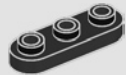

348

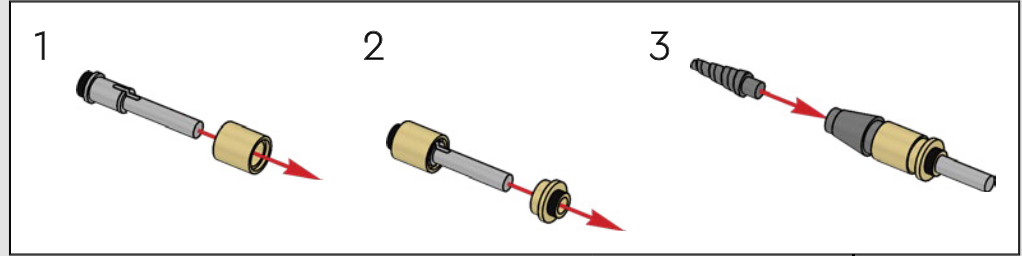



349

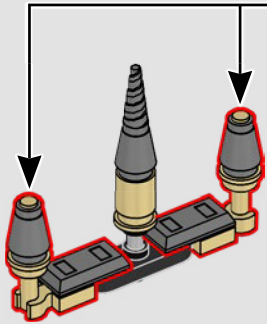
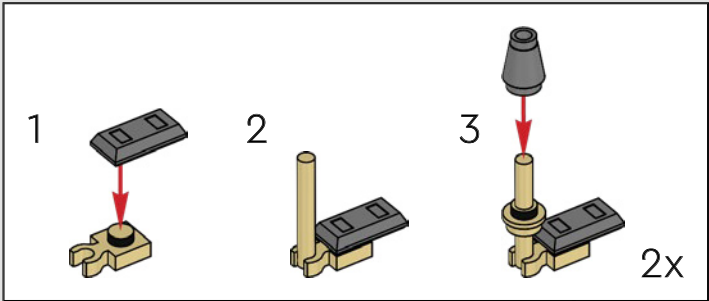

350

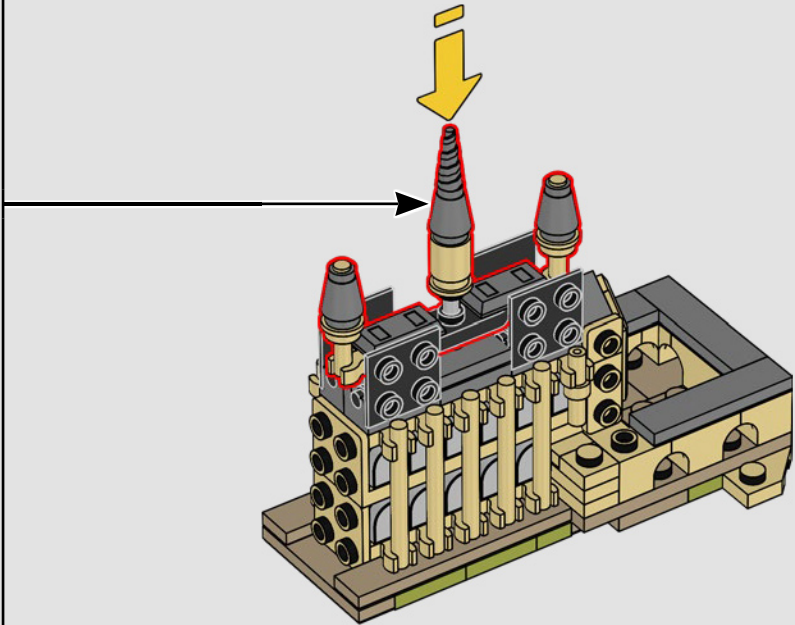

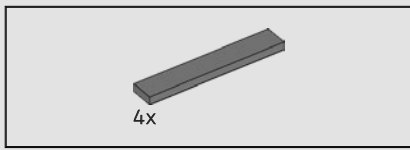

351

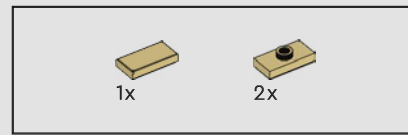
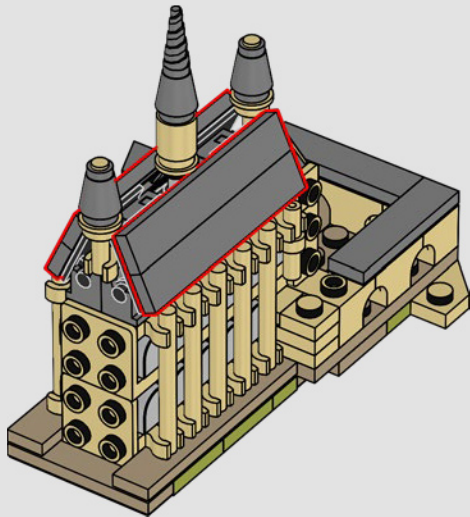

352

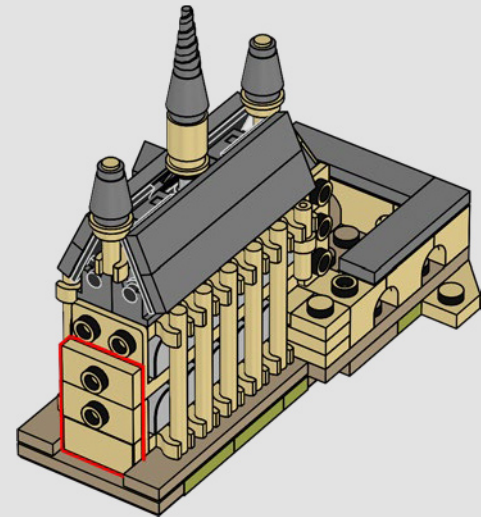

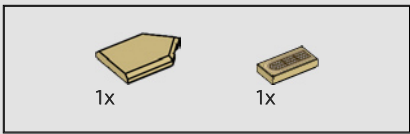

353

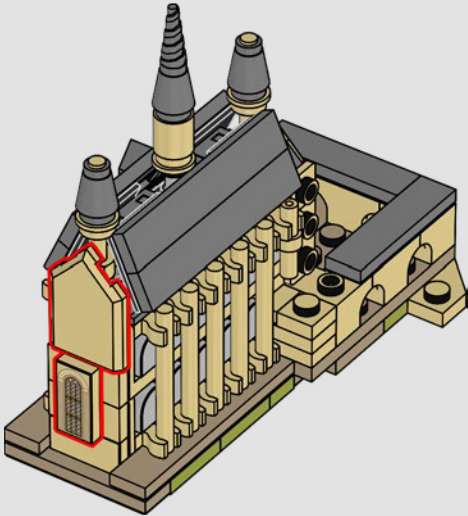

An die Decke der Großen Halle kann man den Nachthimmel zaubern.

354

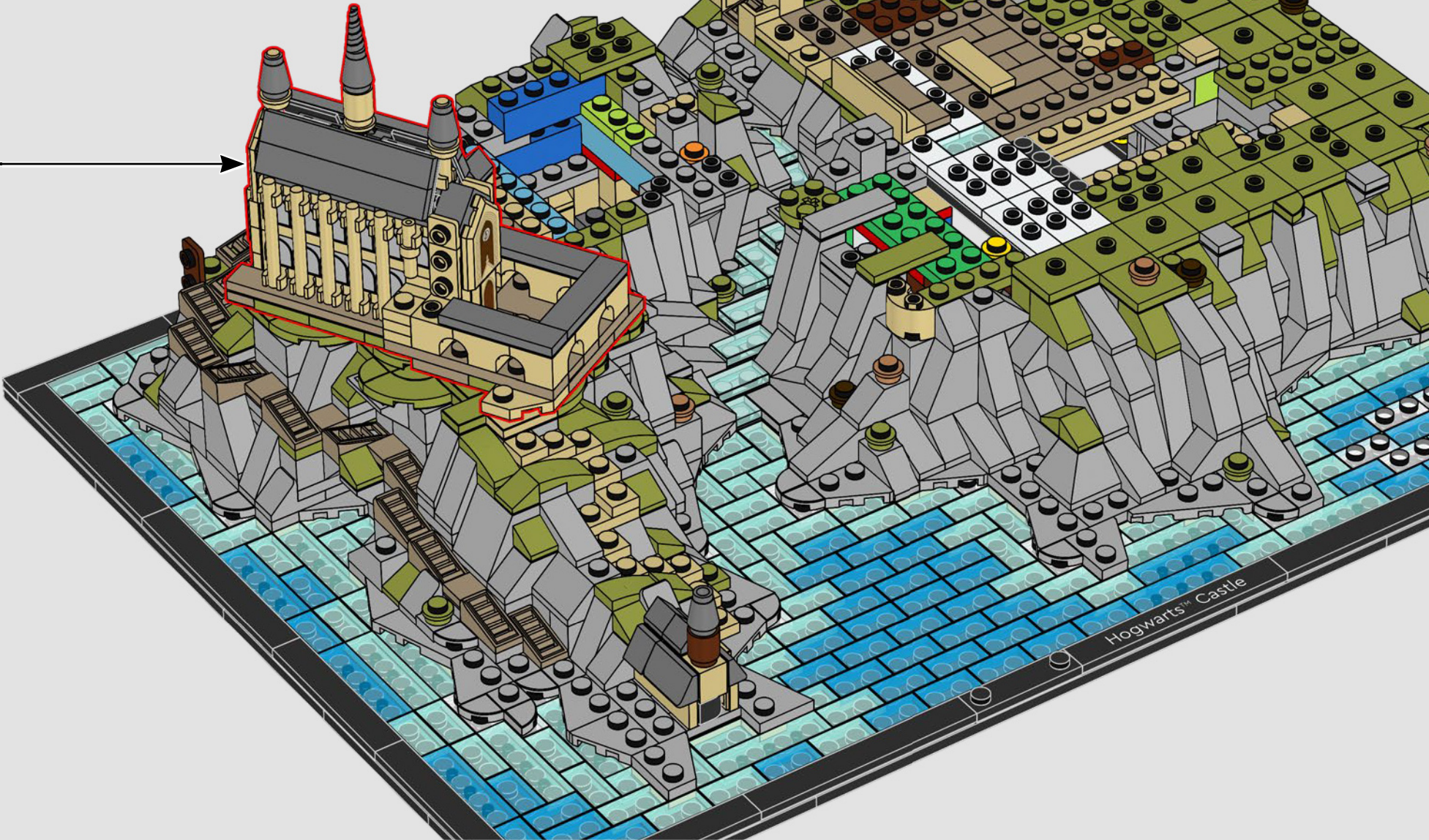

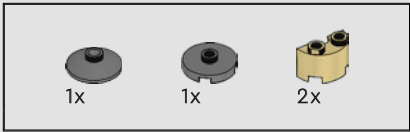

355

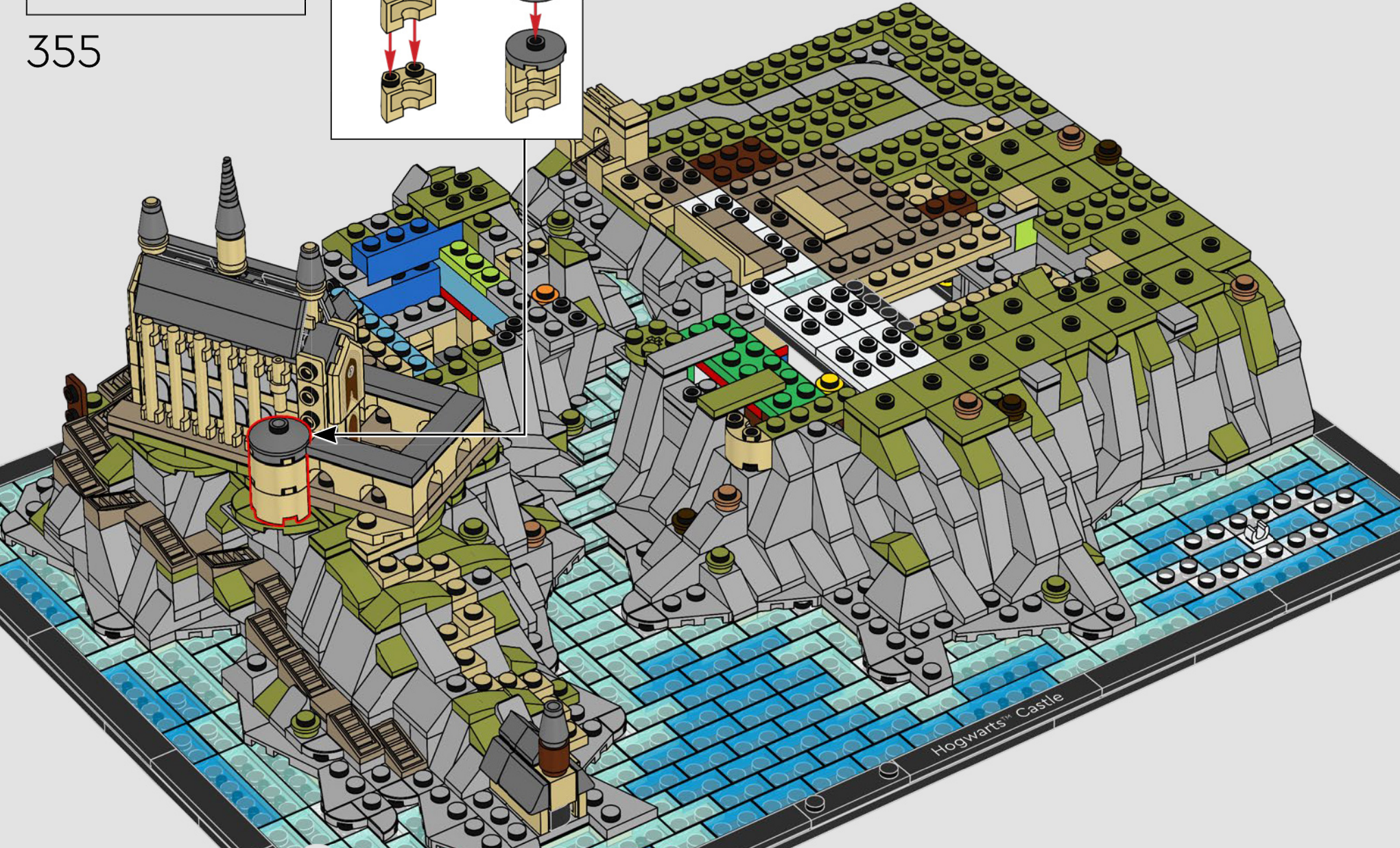
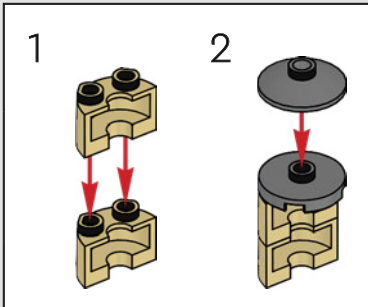



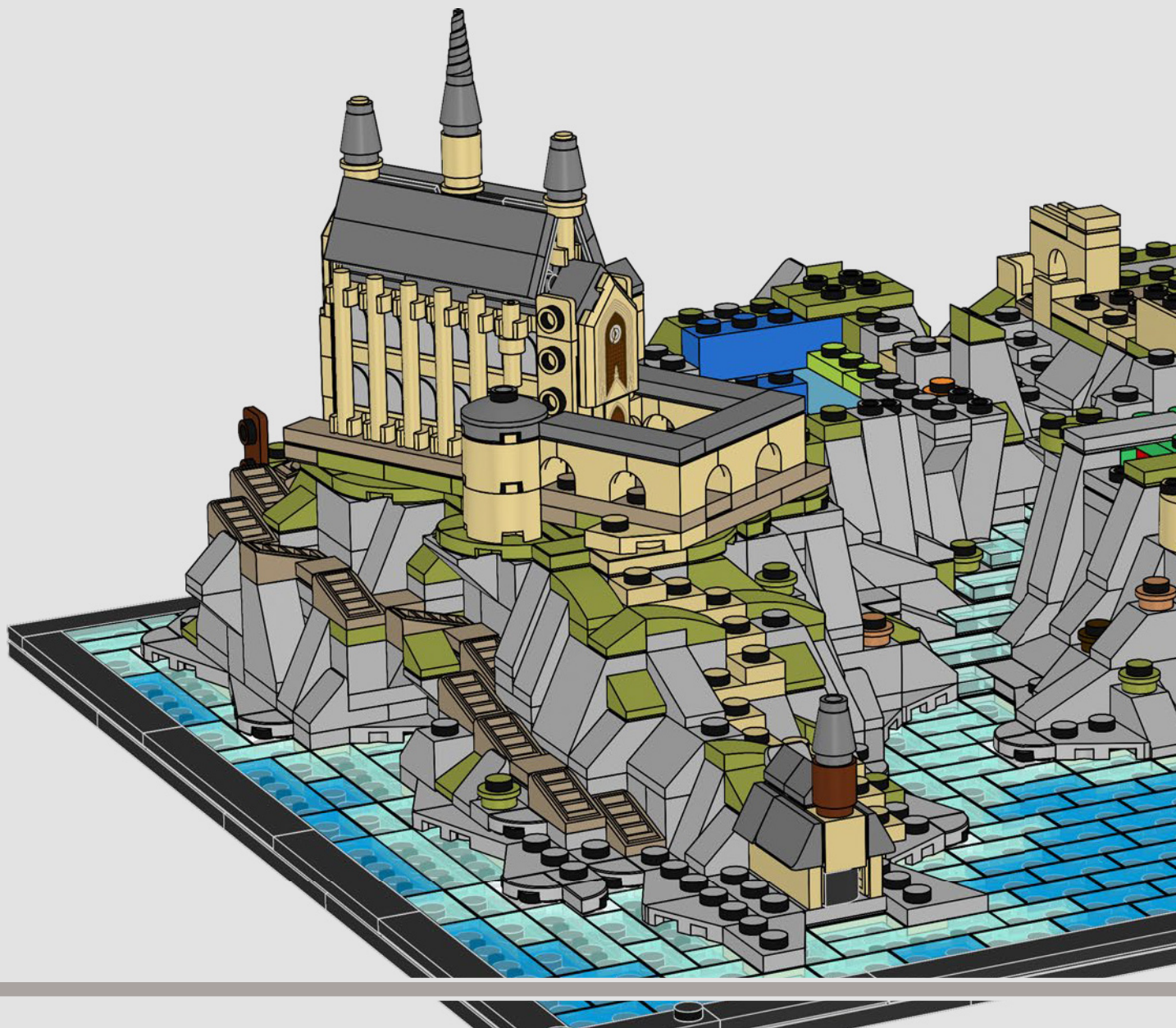

Sofort nach der Ankunft in Hogwarts™ werden die Erstklässler in die Große Halle gebracht, wo der Sprechende Hut™ bestimmt, welches Haus ihr neues Zuhause wird.



356



Die Bäume werden aus  
LEGO® Kristallen und  
Eiscreme und mit ein  
wenig Magie gebaut.

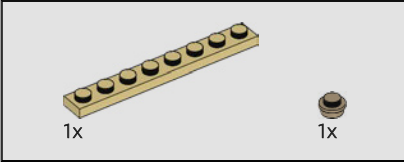
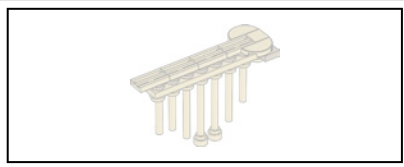

357

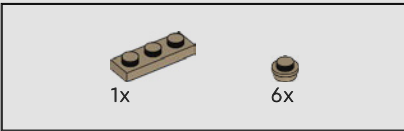
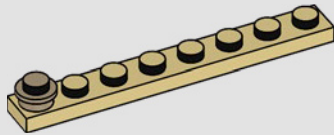

358

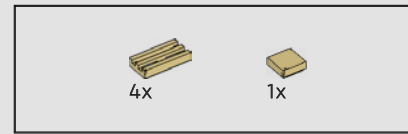
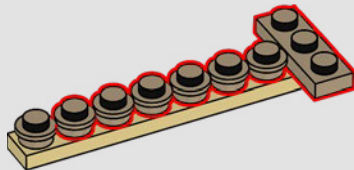

359

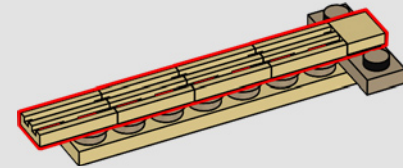

360

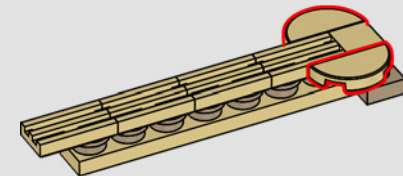

8x

361

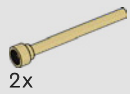
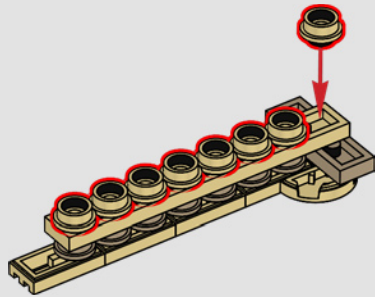

2x

362

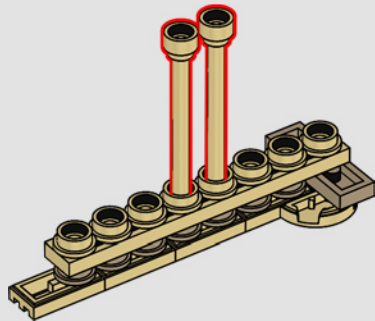

2x

3x

363

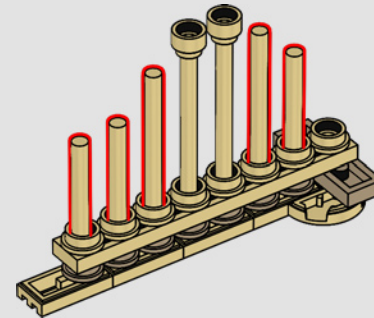

364



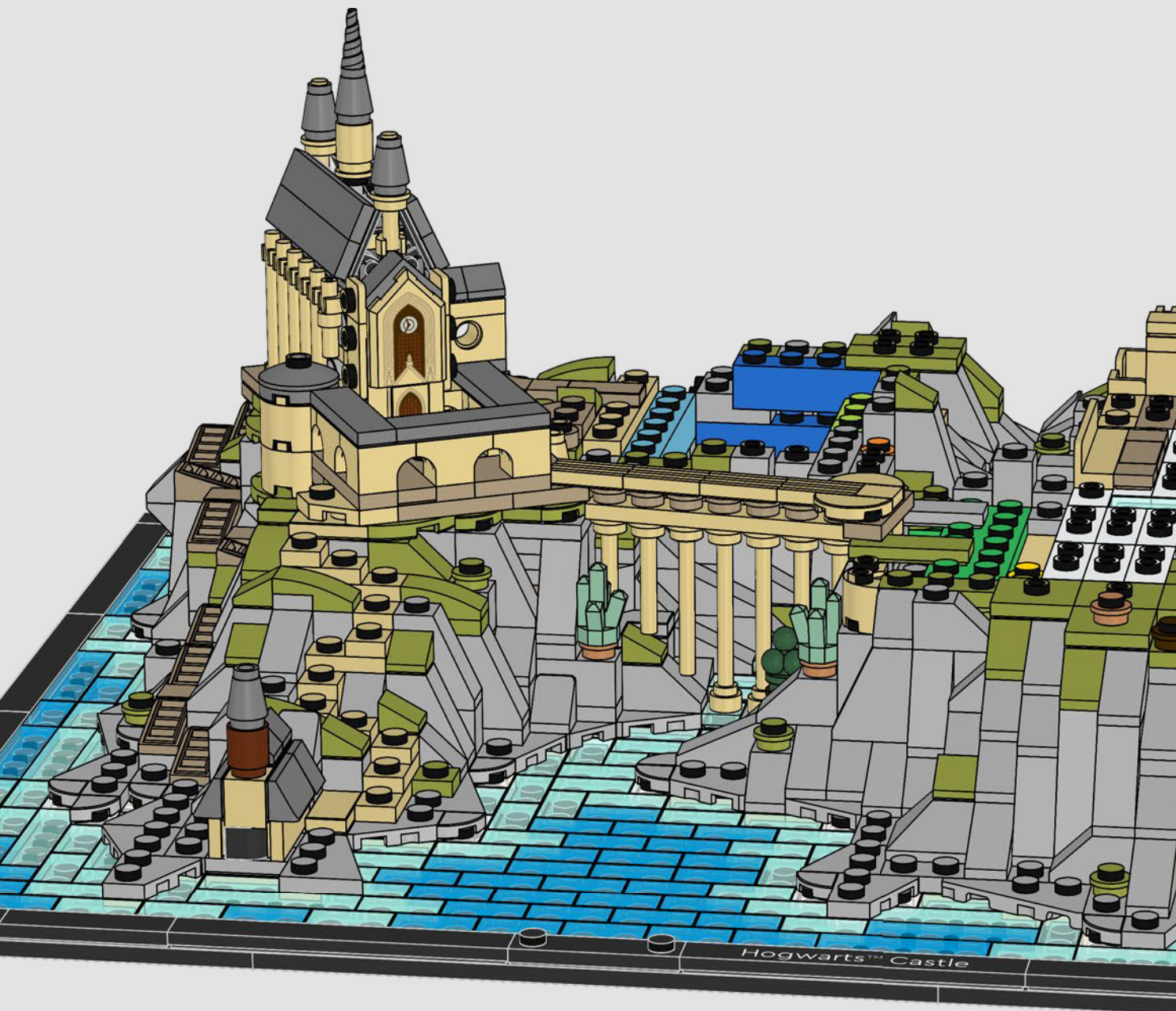

Das Viadukt ist nicht nur ein legendärer Anblick in der Silhouette von Schloss Hogwarts™, sondern auch ein zentraler Schauplatz während der Schlacht von Hogwarts: Als Professor McGonagall die Ritterrüstungen verzaubert, damit sie ihre Pflicht gegenüber der Schule erfüllen und alle in der Schule beschützen, begeben sie sich zur Brücke. Eine weitere Schlüsselszene spielt sich während der Ersten Aufgabe des Trimagischen Turniers am Viadukt ab, als der Ungarische Hornschwanz unter der Brücke hindurchfliegt, um Harry zu jagen.



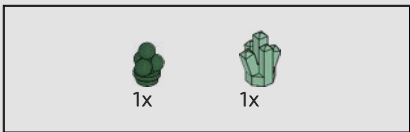

365







2x

366

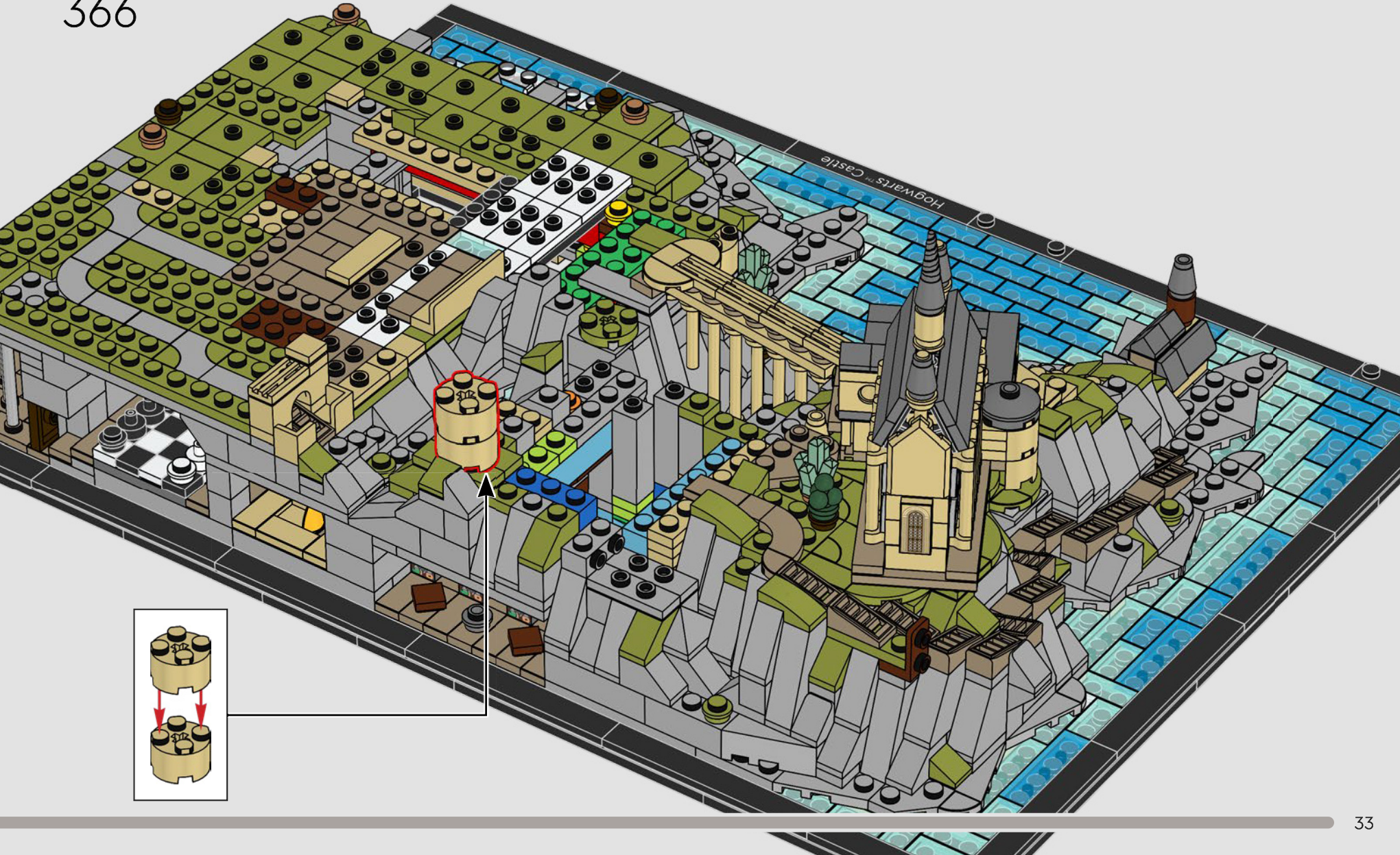

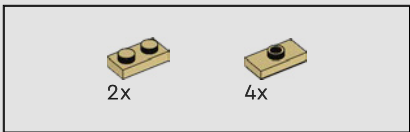

367

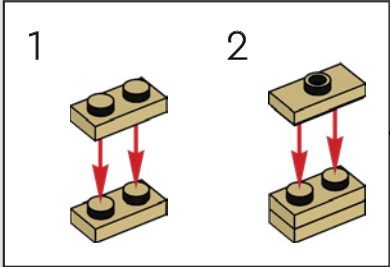
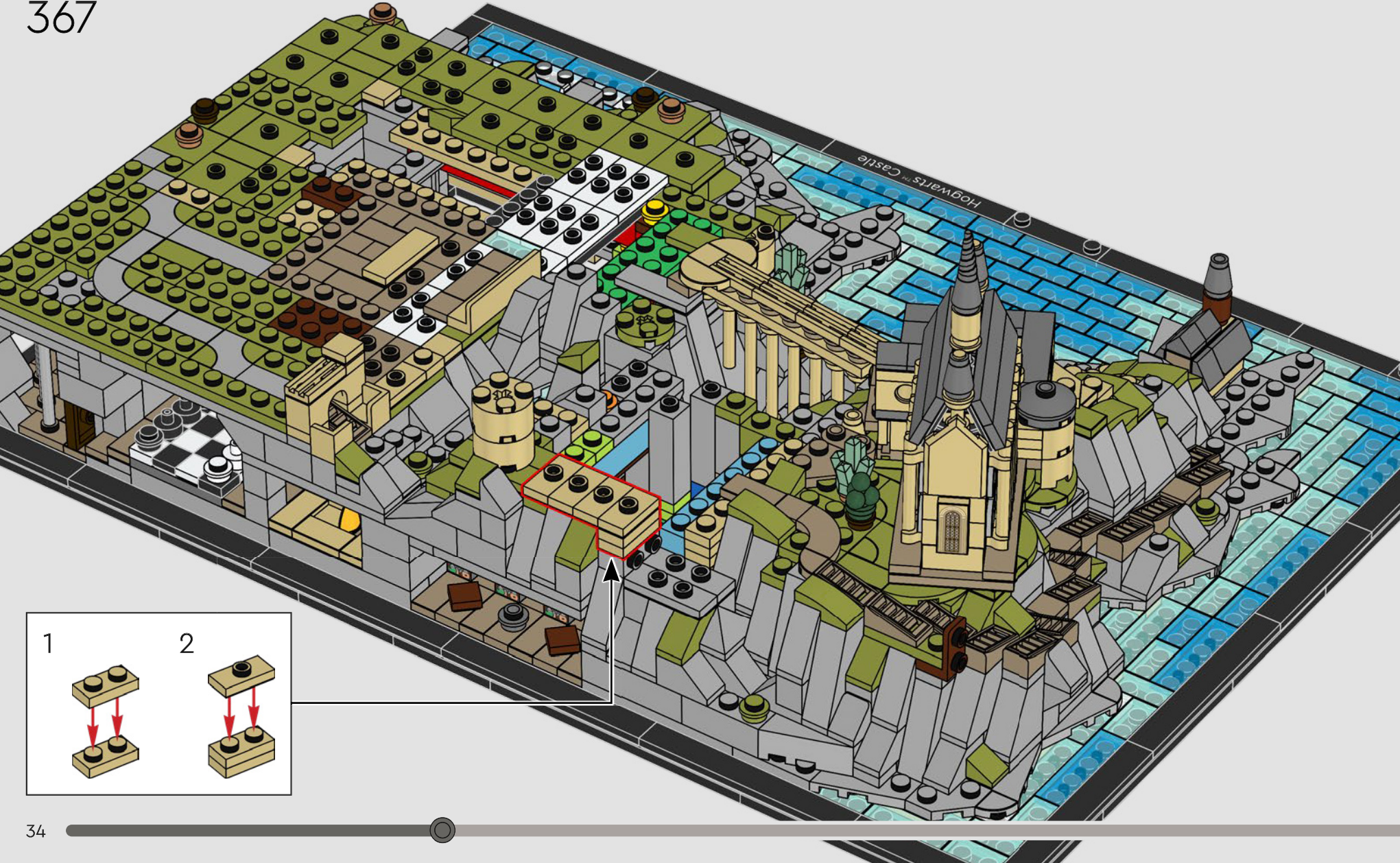

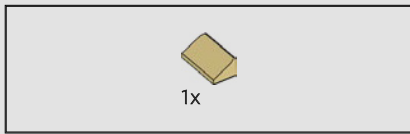

368

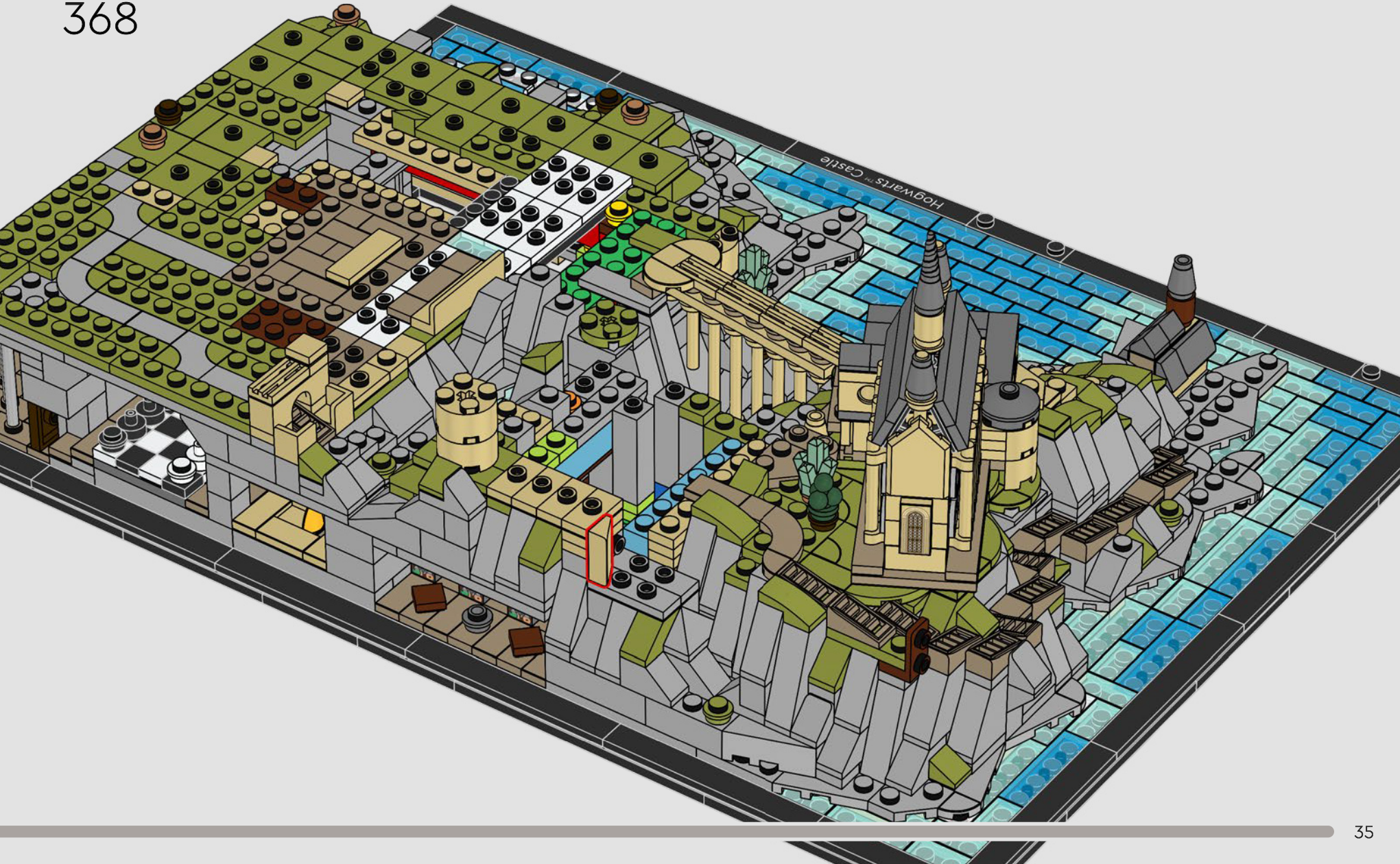

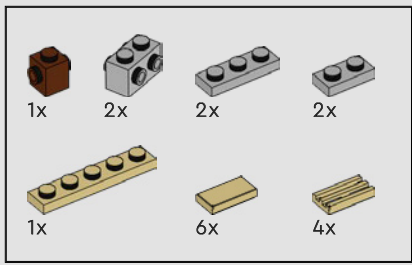

369

1

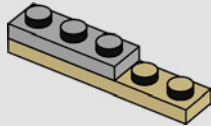

2

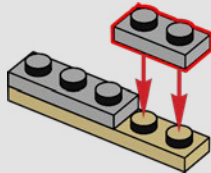

3

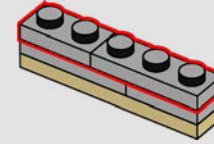

4

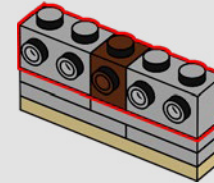

5

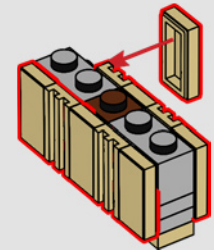

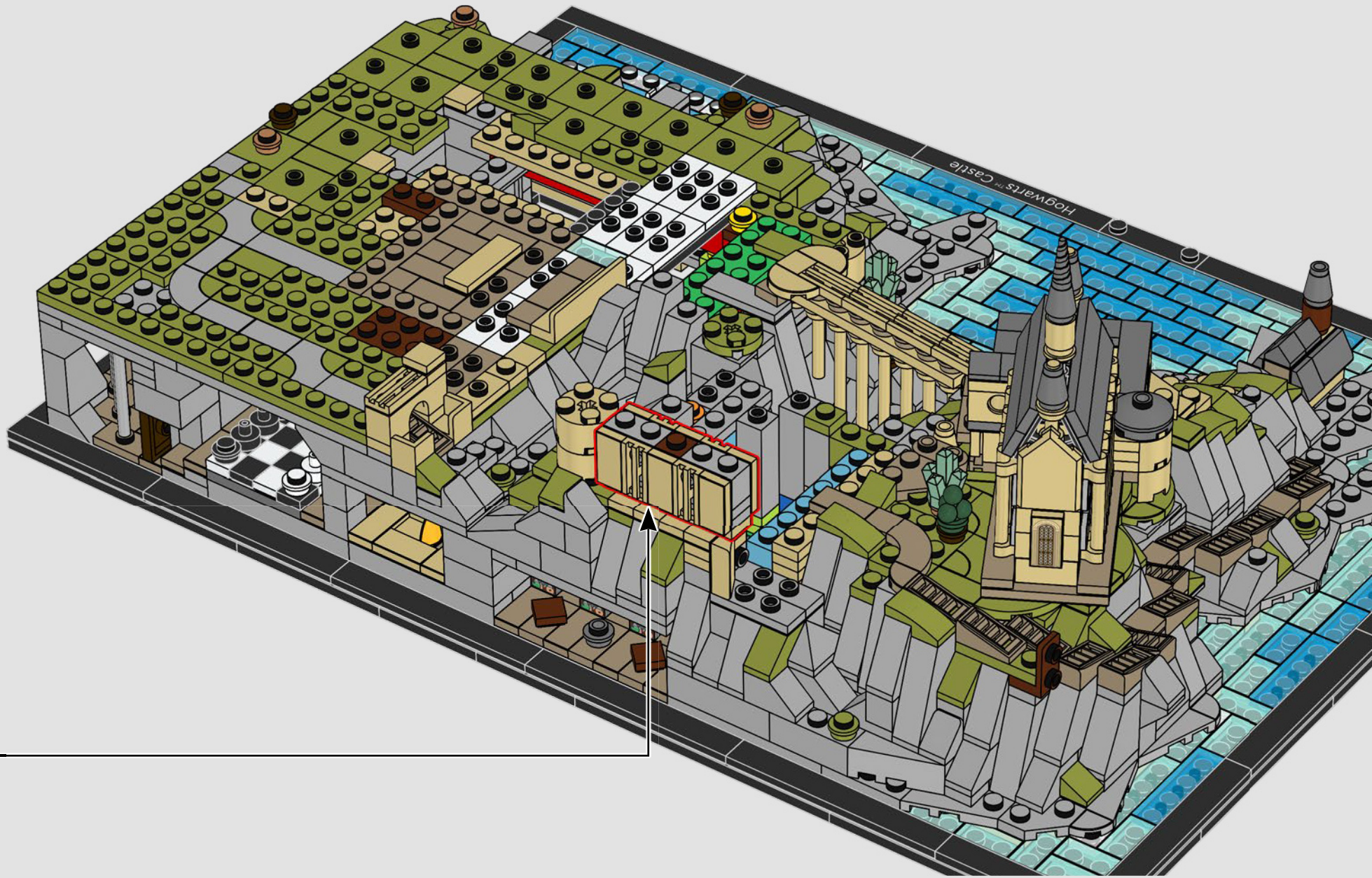

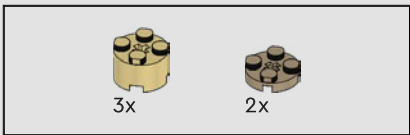

370

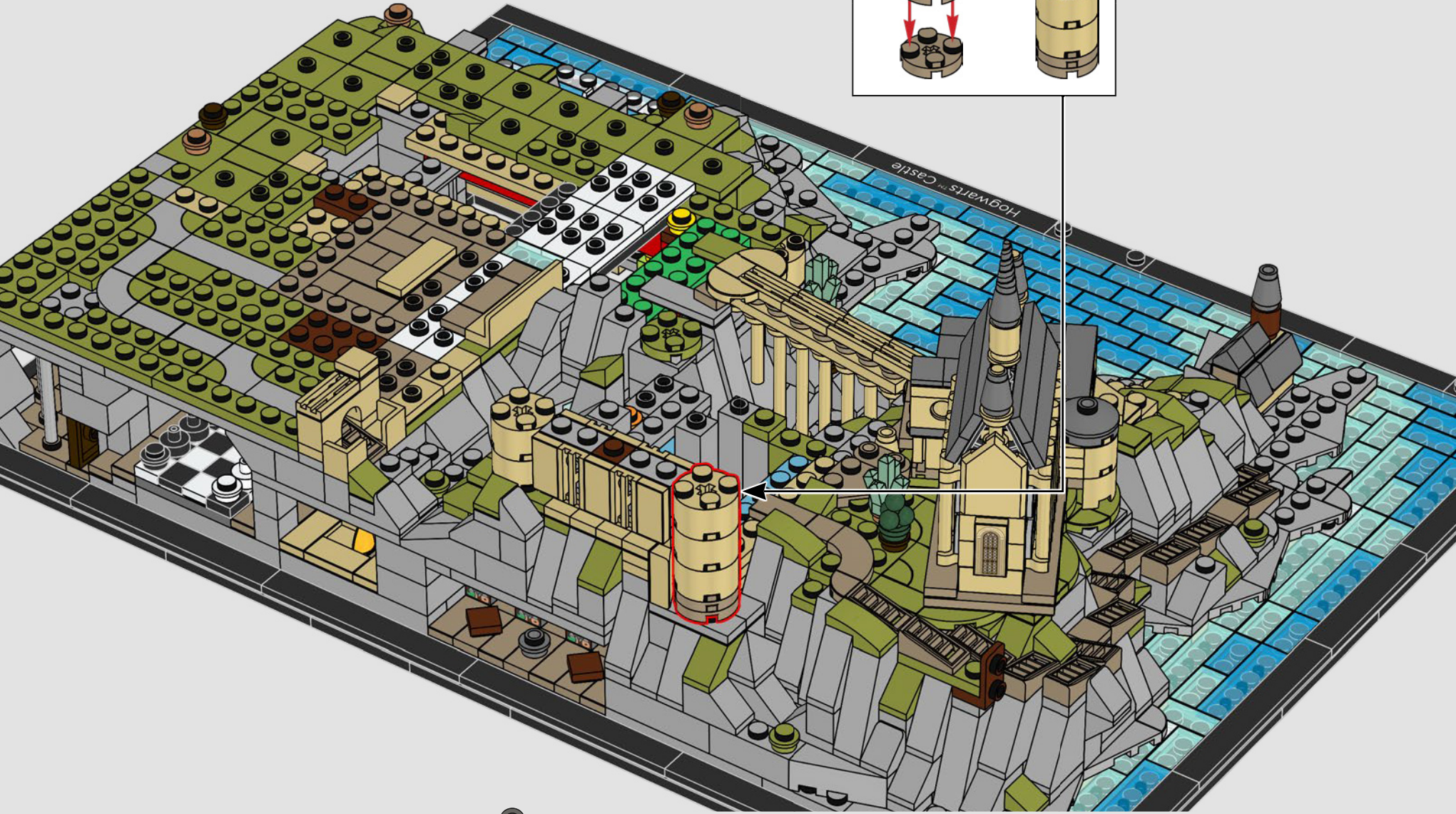
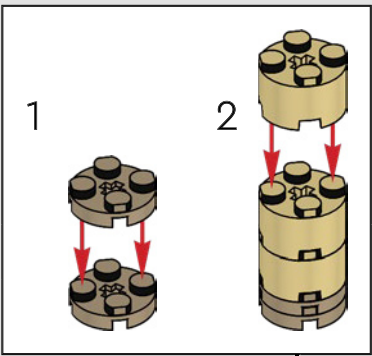

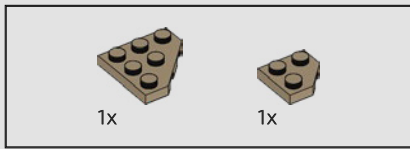

371

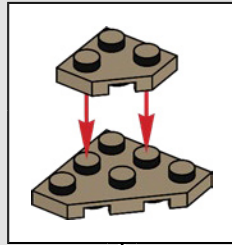

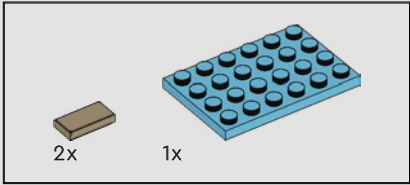
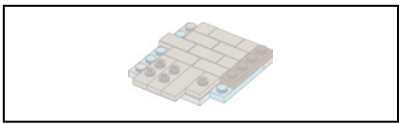

372

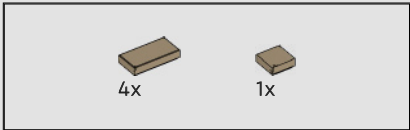
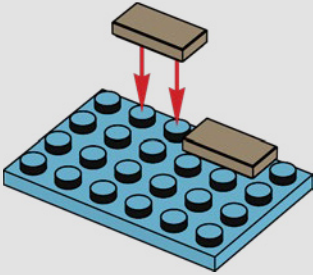

373

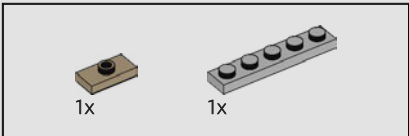
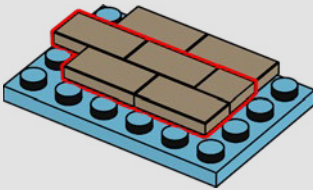

374

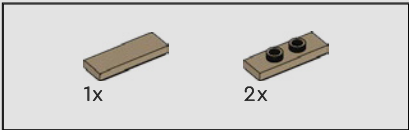
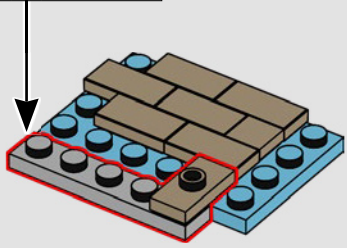
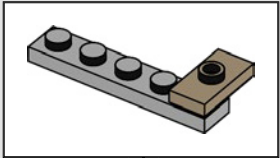

375

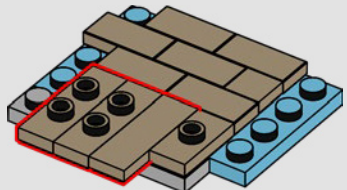



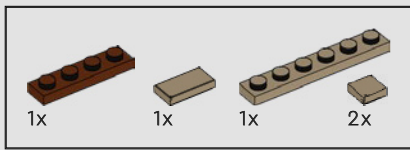

376

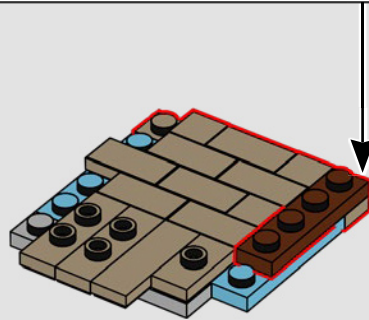
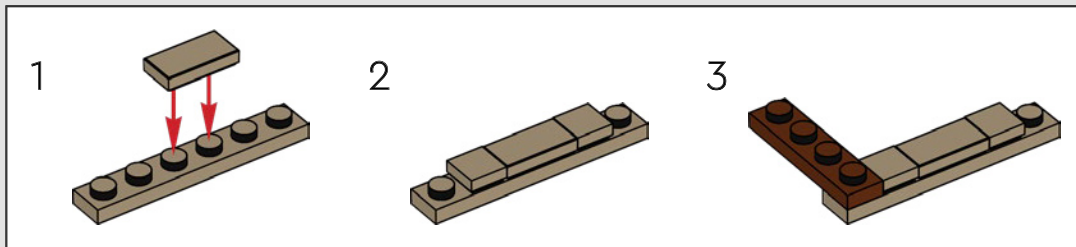

377



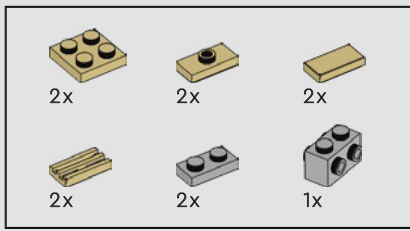

378

1

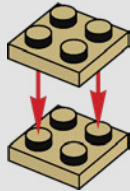

2

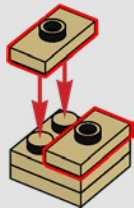

3

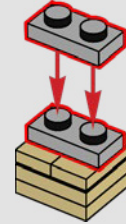

4

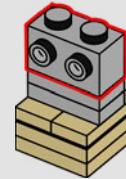

5

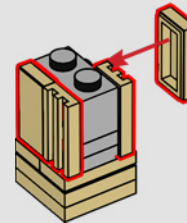



Hogwarts™ Castle

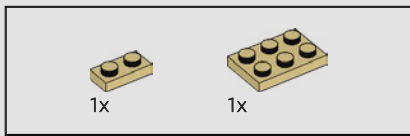

379

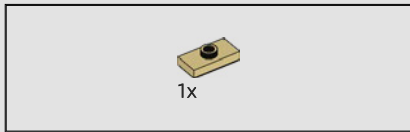
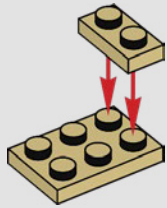

380

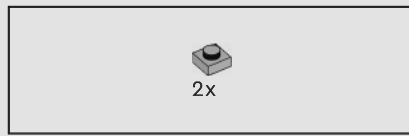
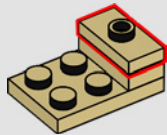

381

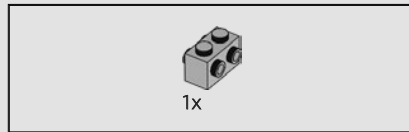
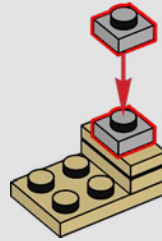

382

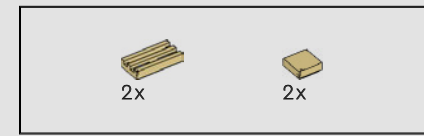
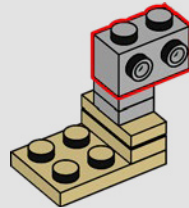

383

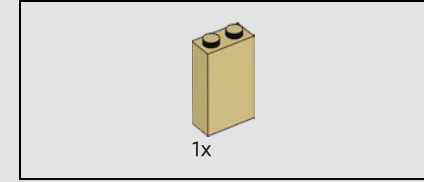
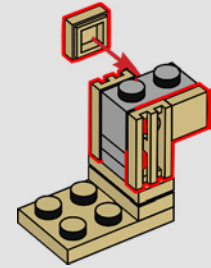

384

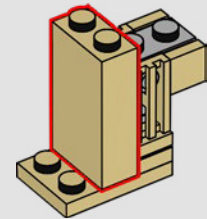

385

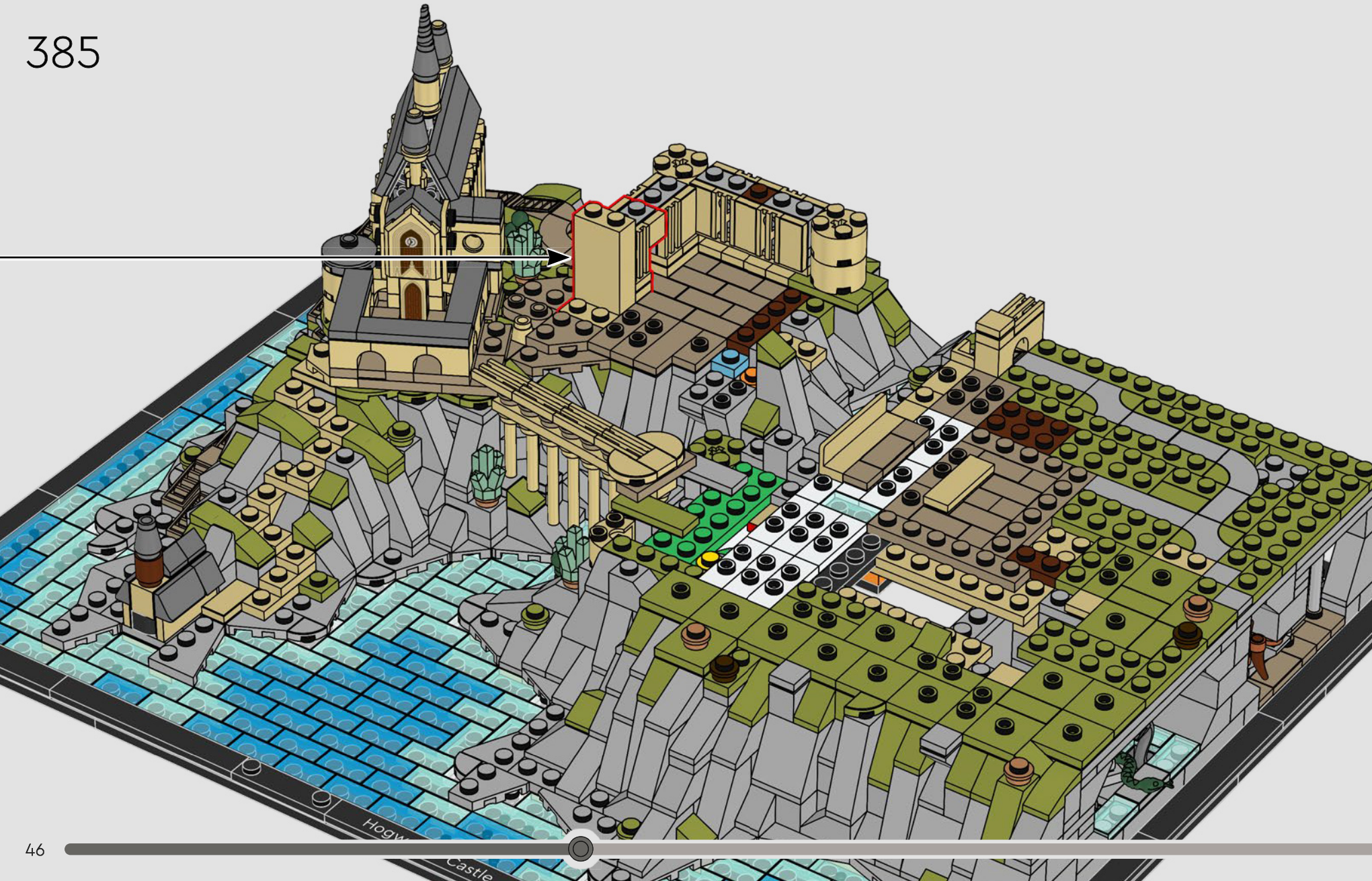

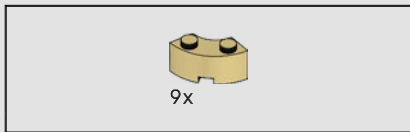

386

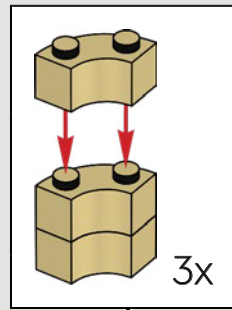

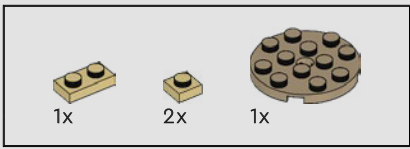

387

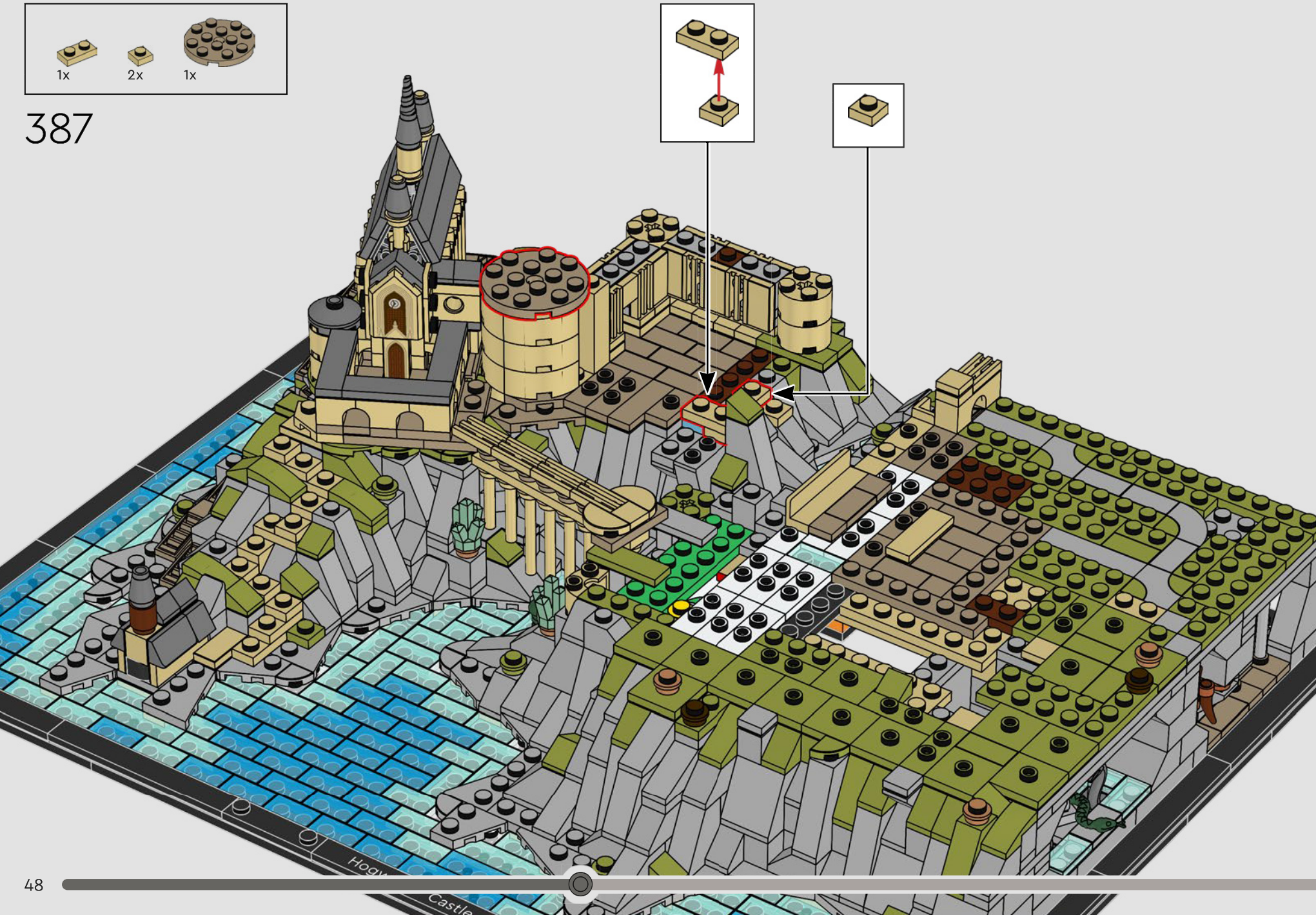
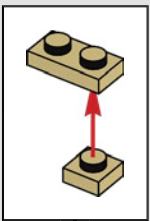



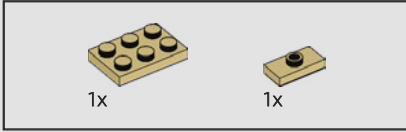
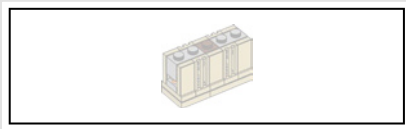

388

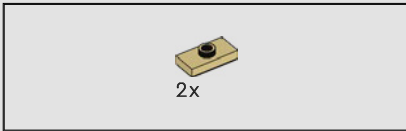
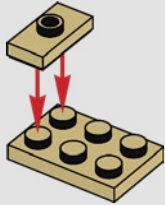

389

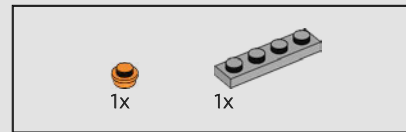
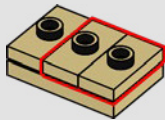

390

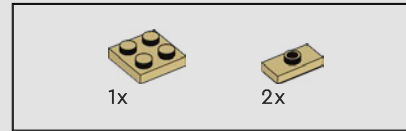
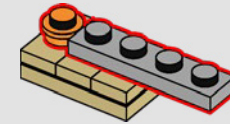

391

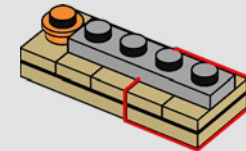
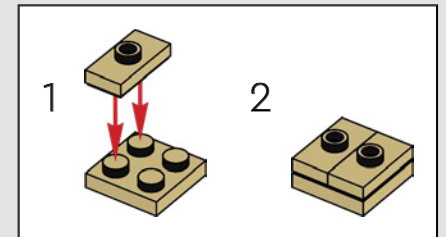

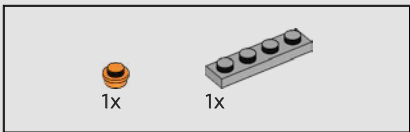

392

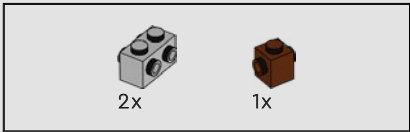
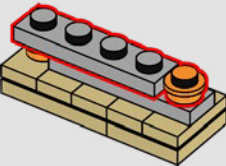

393

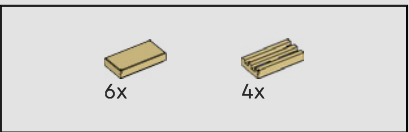
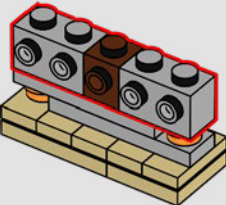

394

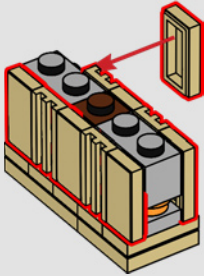

395

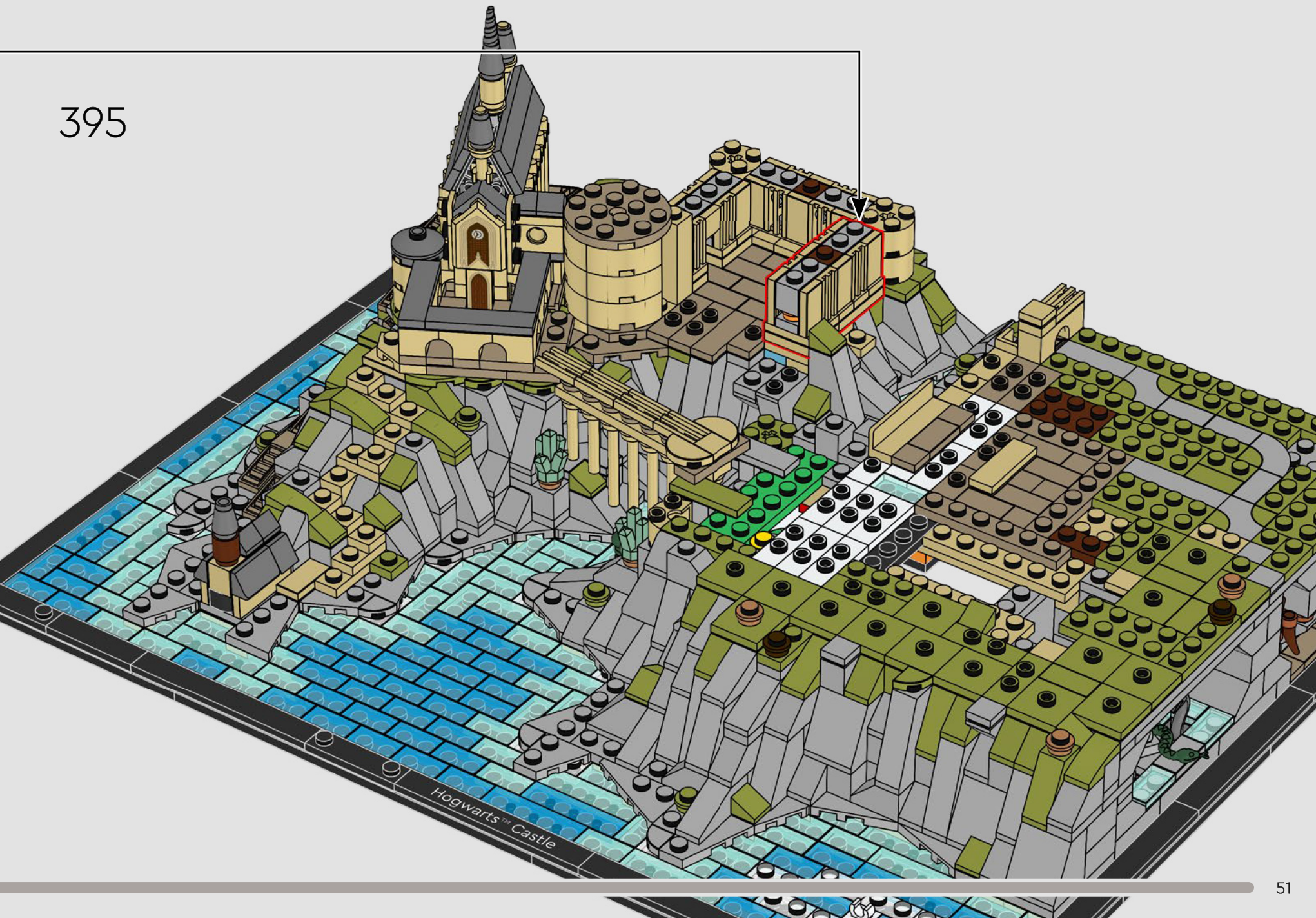

Hogwarts™ Castle

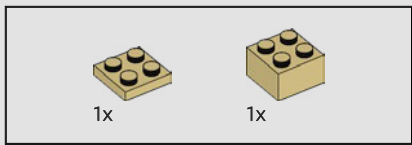

396

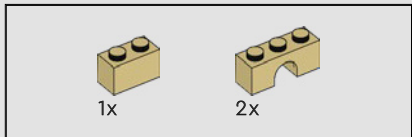
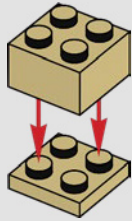

397

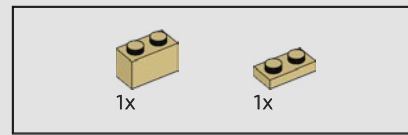
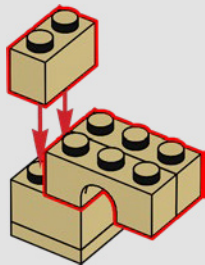

398

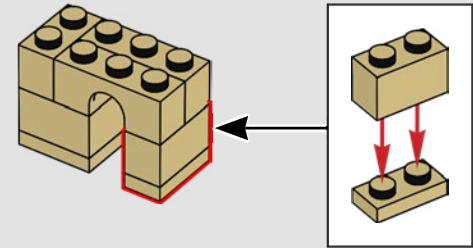

399

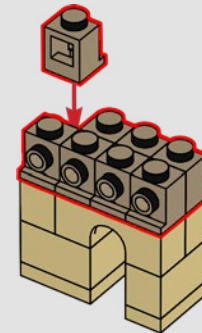

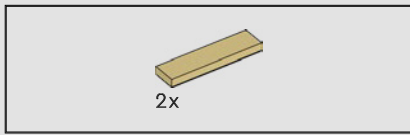

400

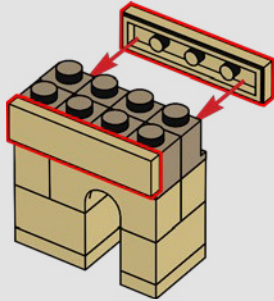

401

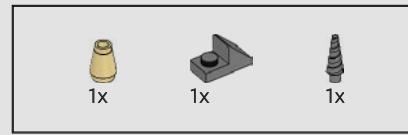
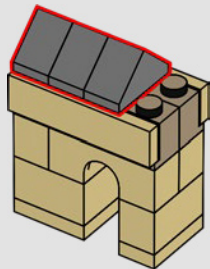

402

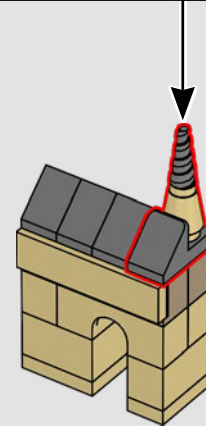
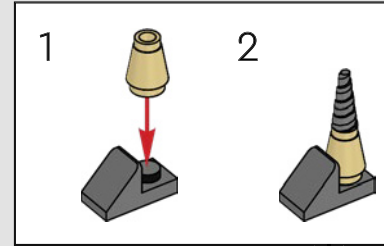

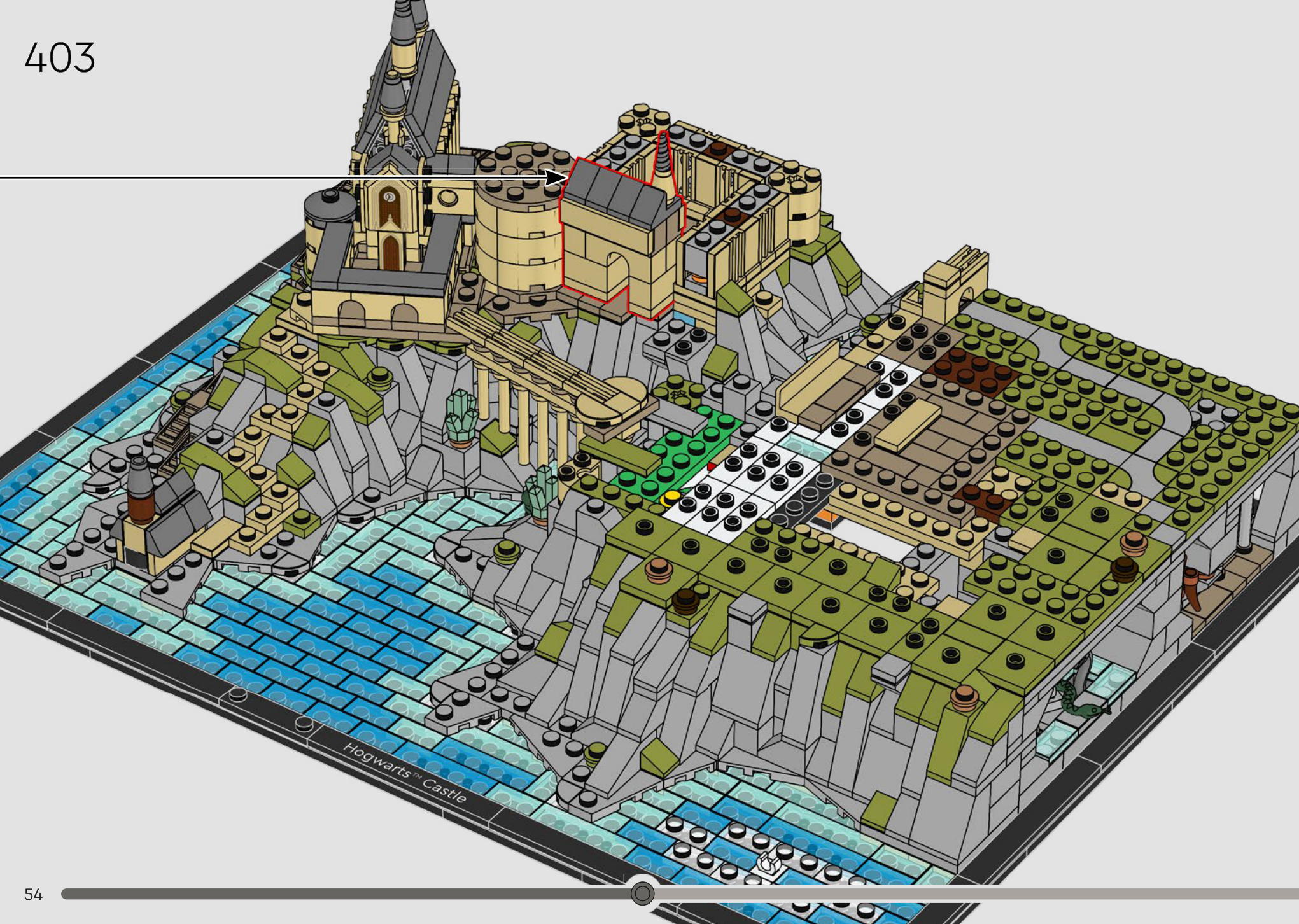

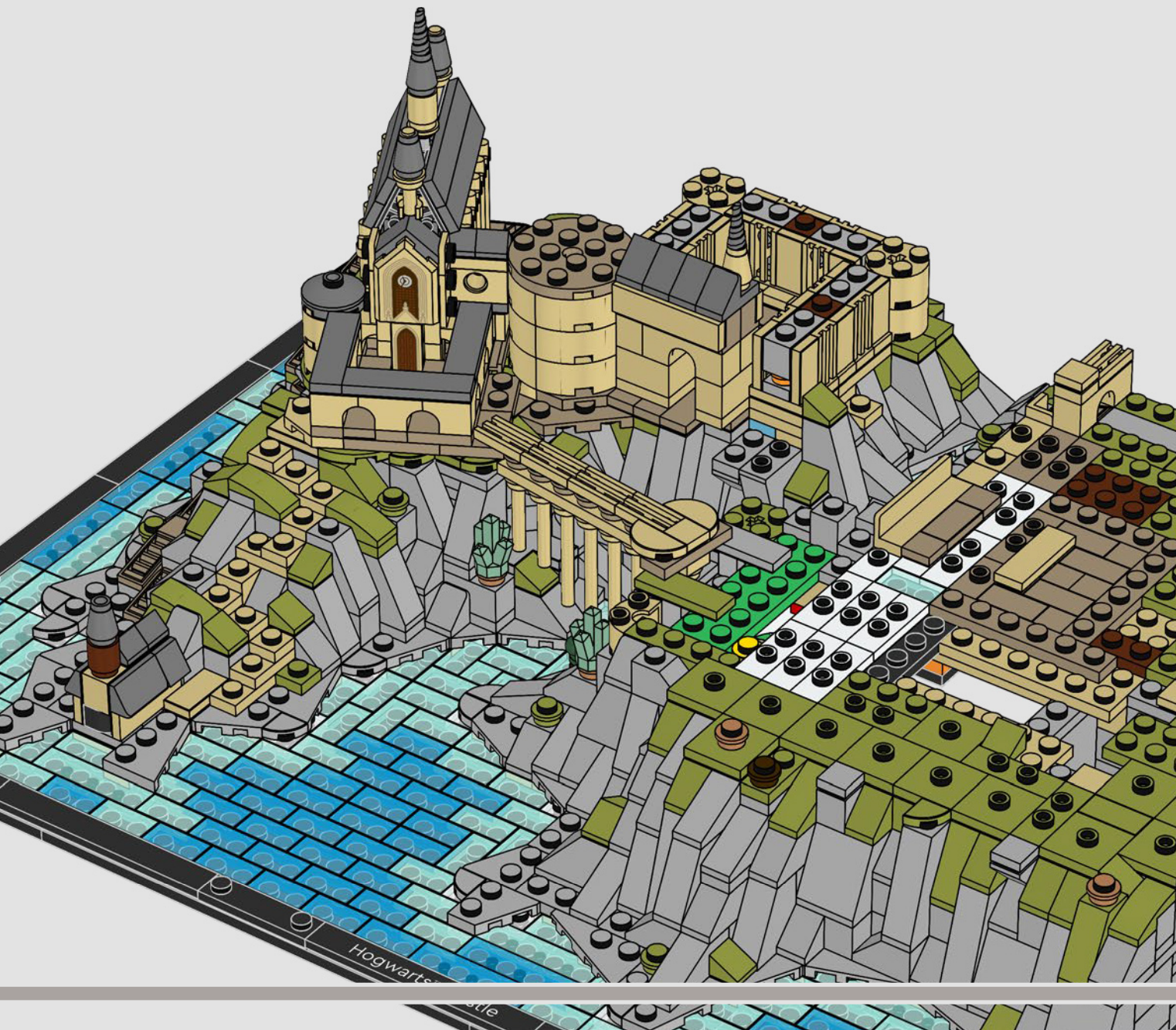

Der Viereckhof grenzt an den Uhrenturm und ist ein beliebter Treffpunkt im Freien.

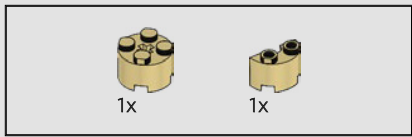

404

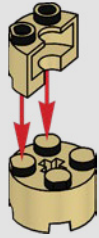

405

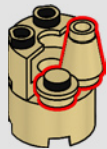

406

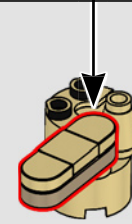
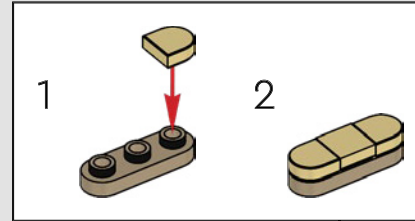

407

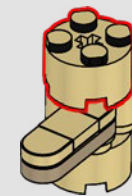



408







409



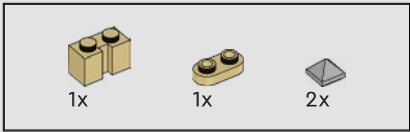

410

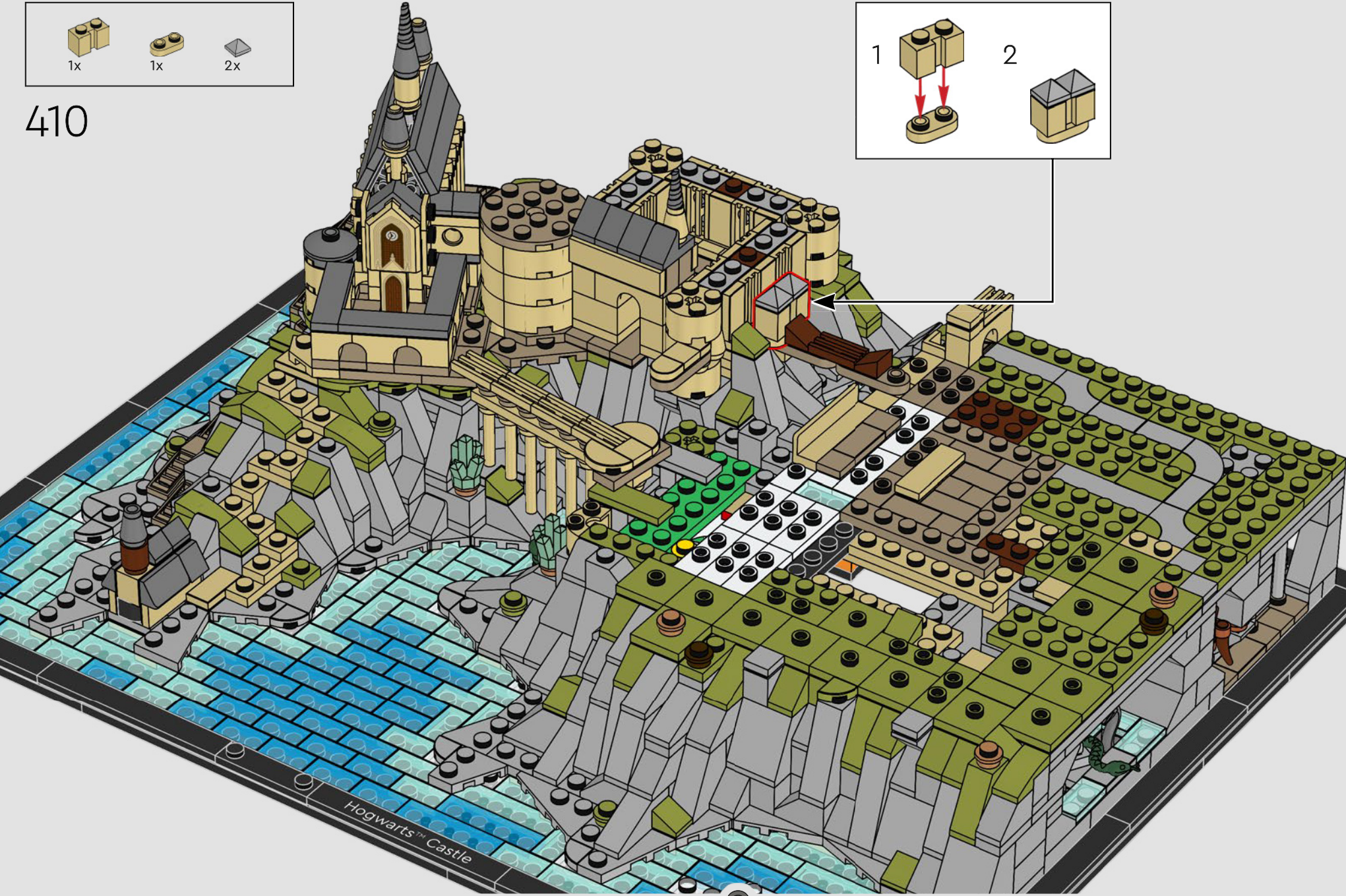
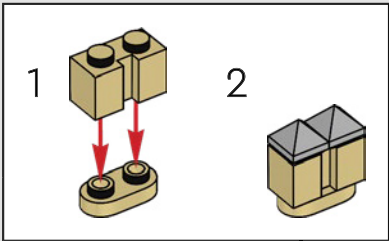

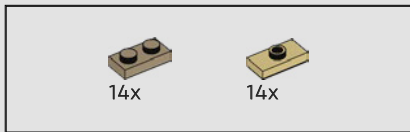

411

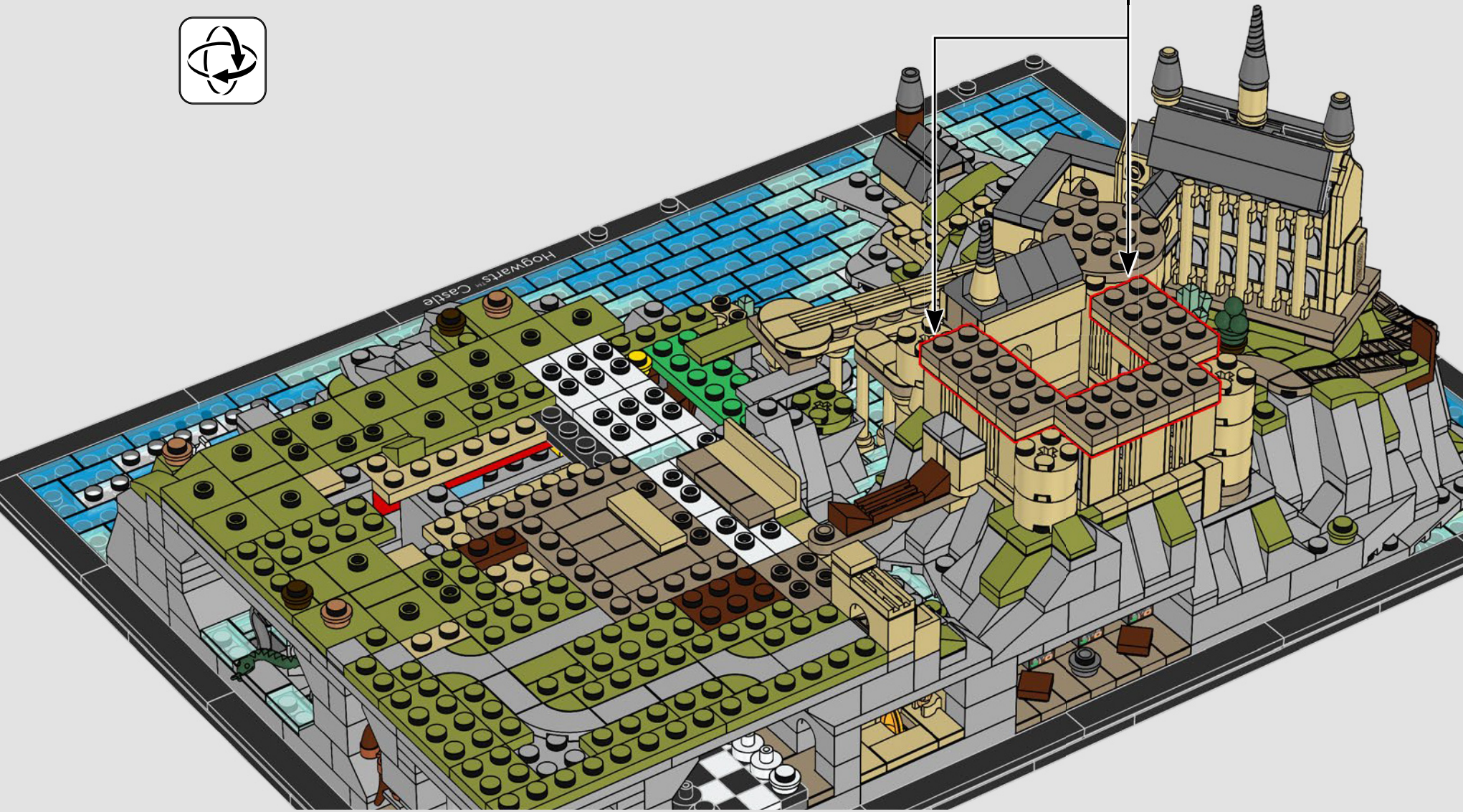
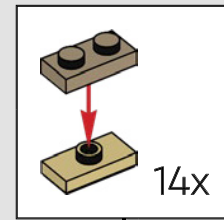

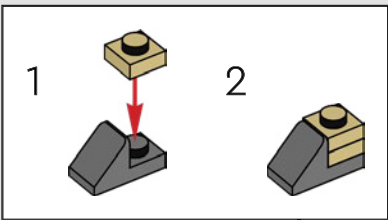
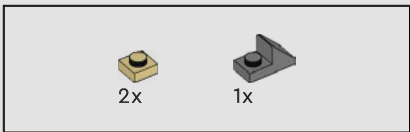

412

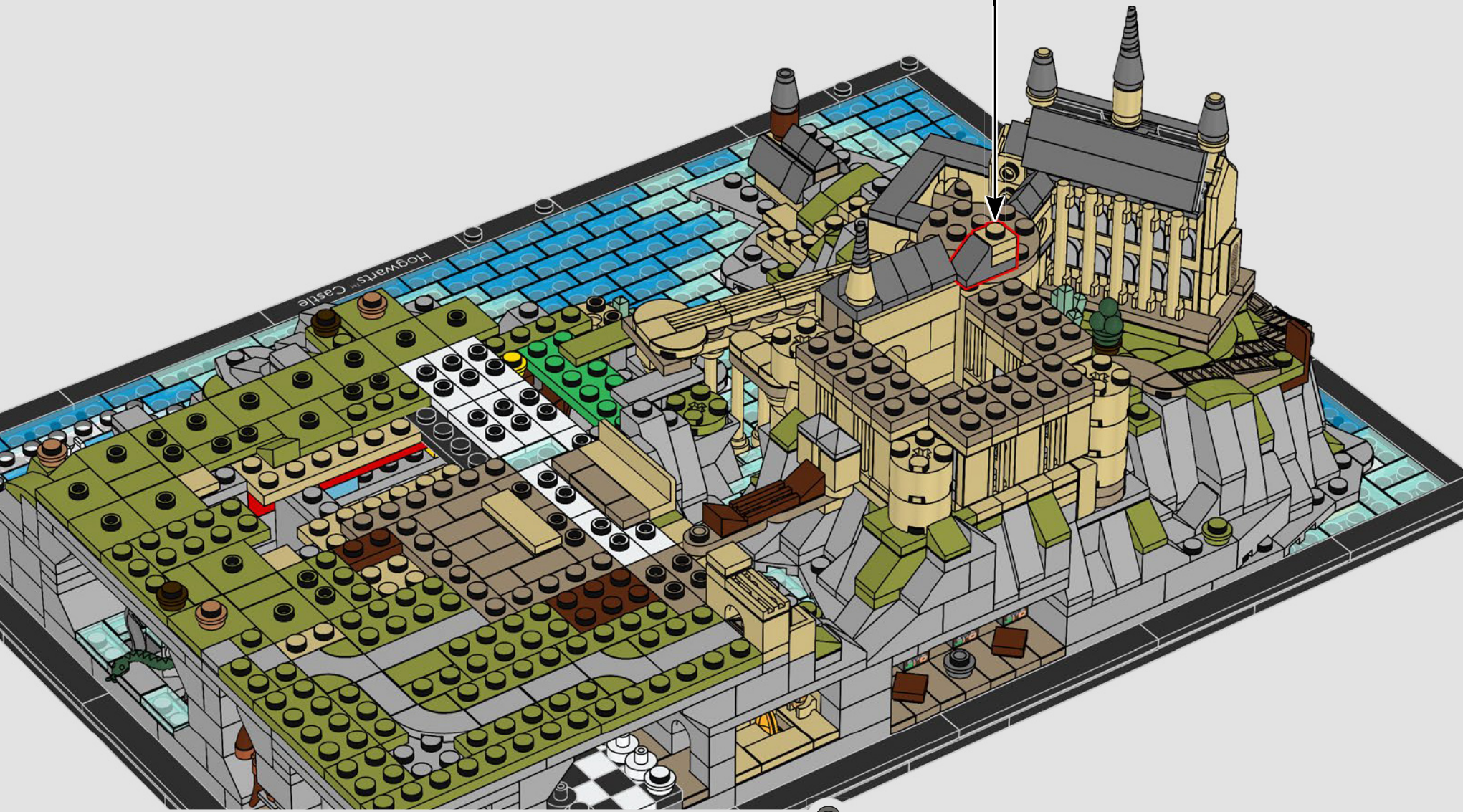

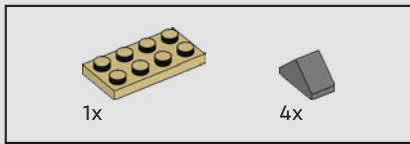

413

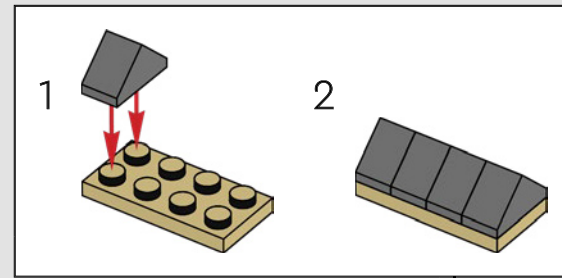

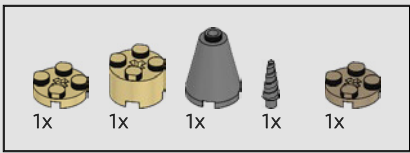

414

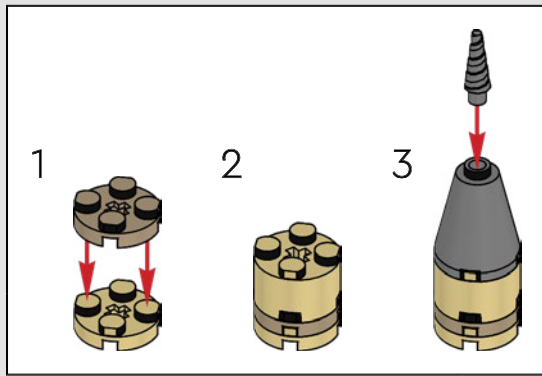



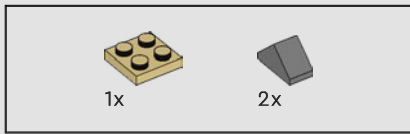

415

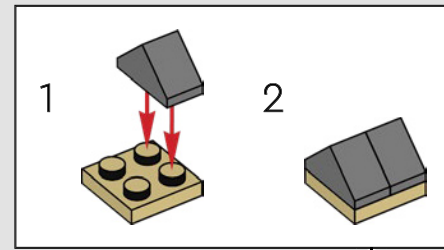

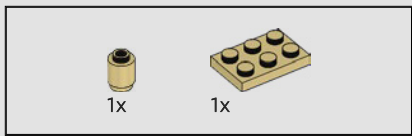

416

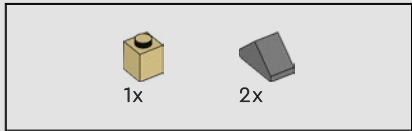
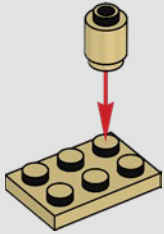

417

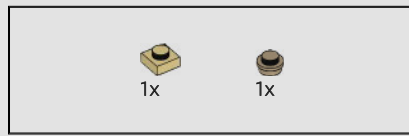
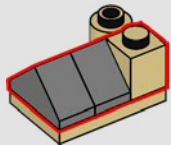

418

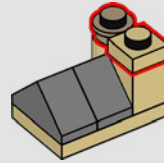

419

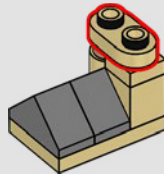

420

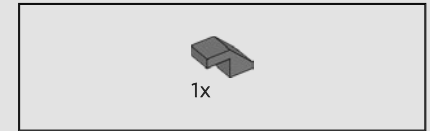
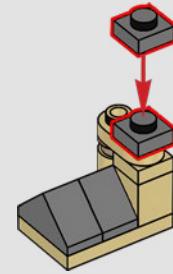

421

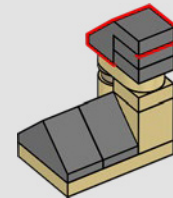

422

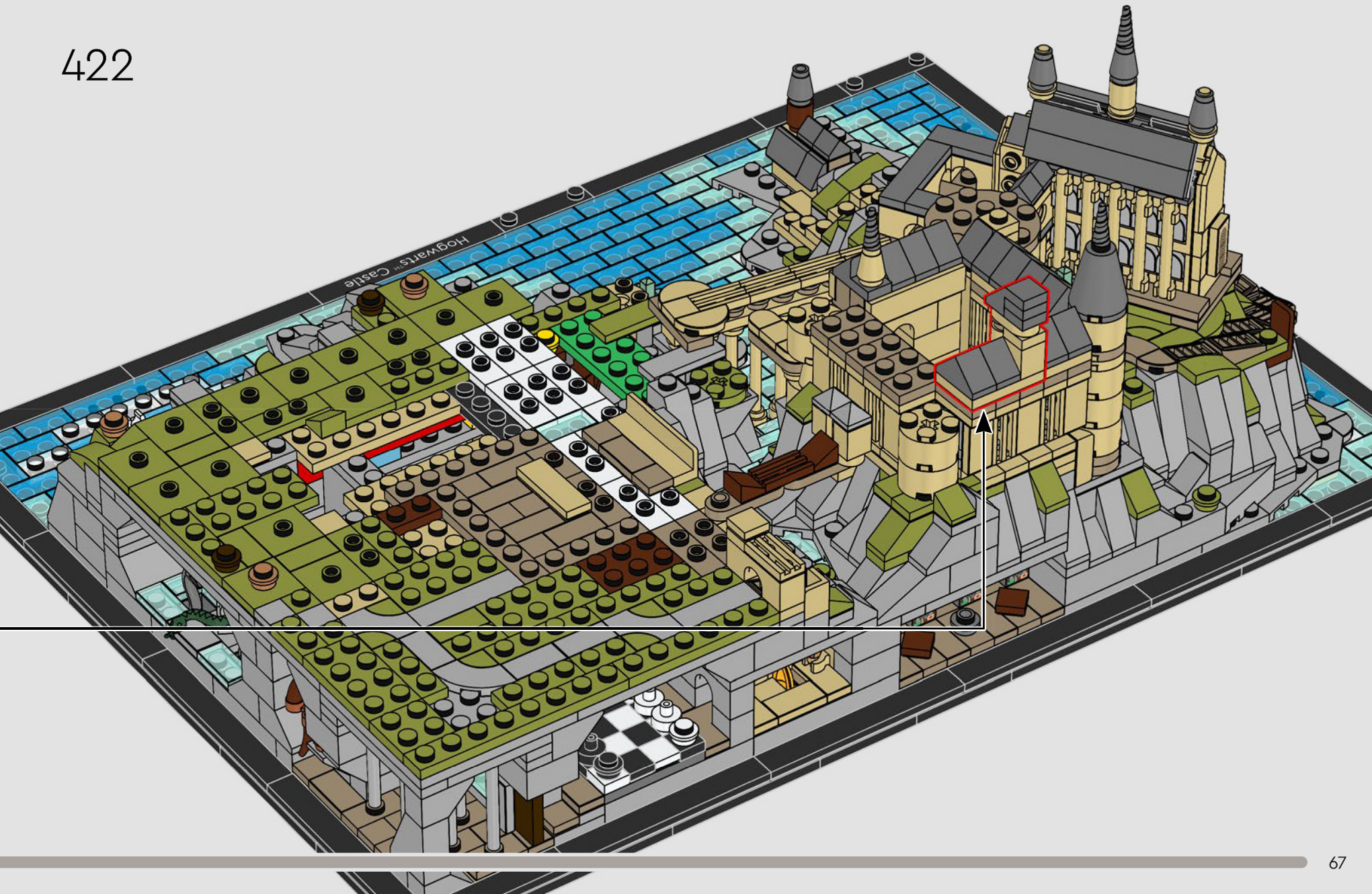

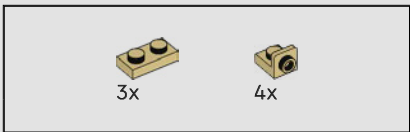

423



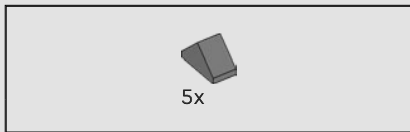

424



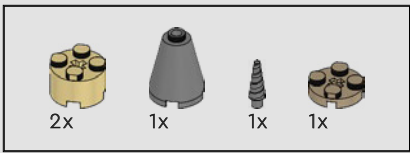

425

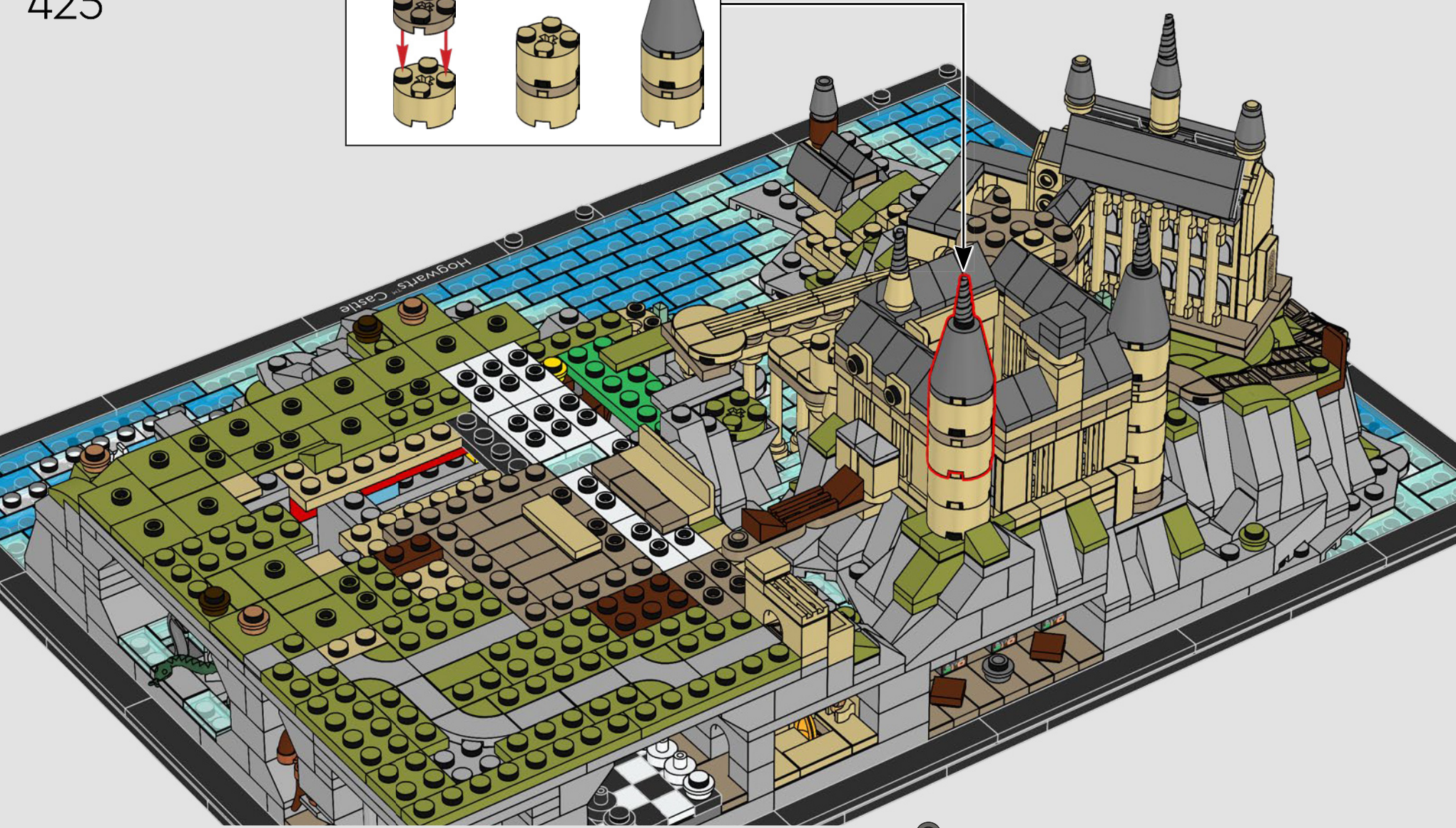
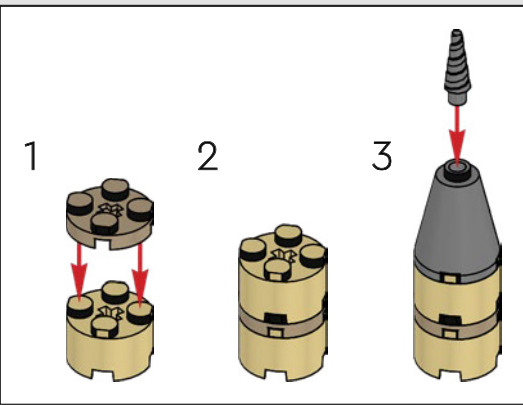

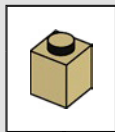
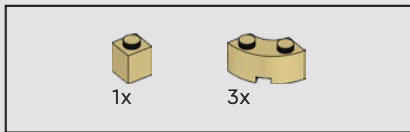

426

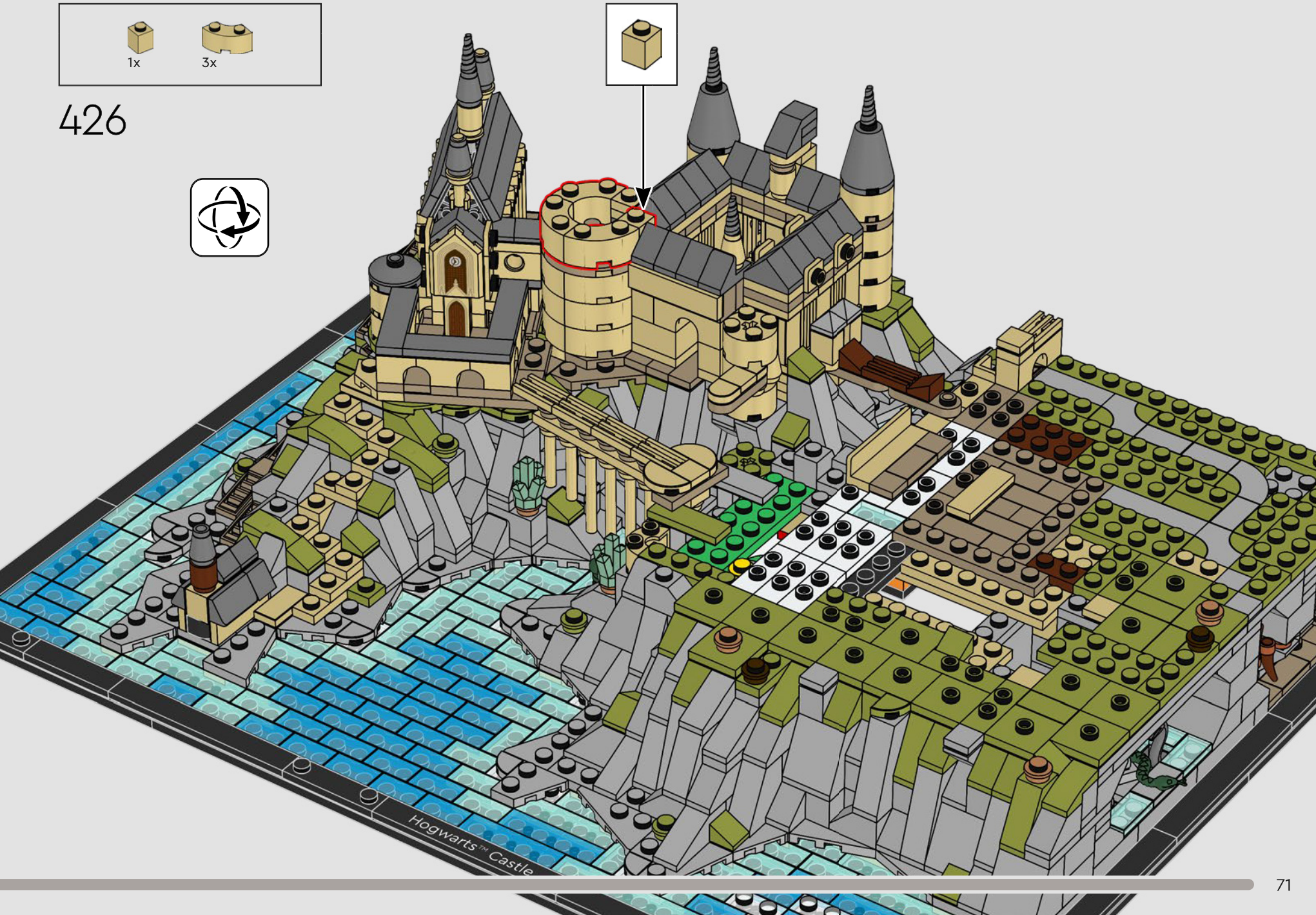

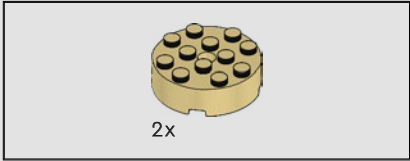
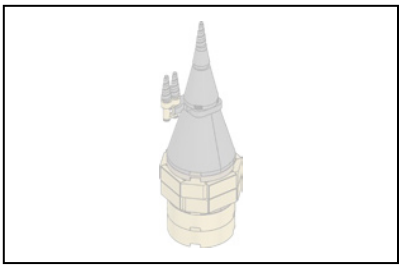

427

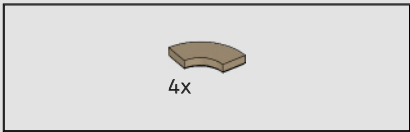
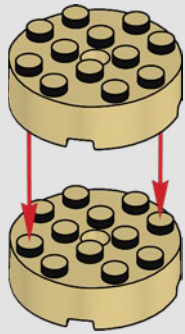

428

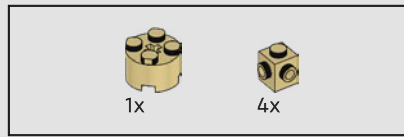
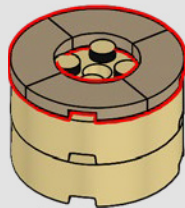

429

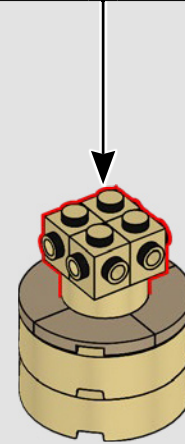
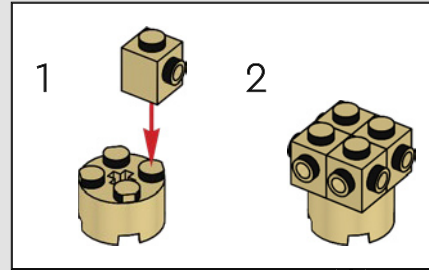



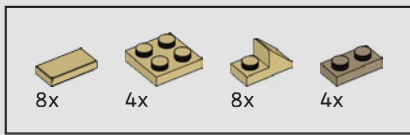

430

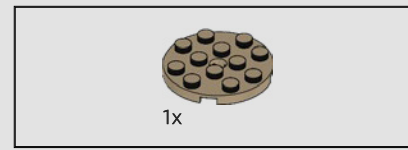
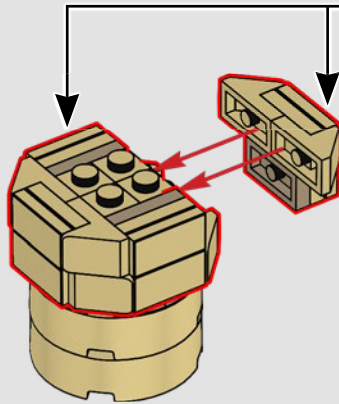
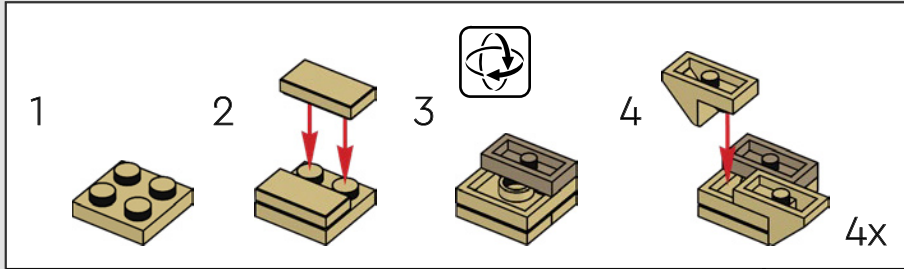

431

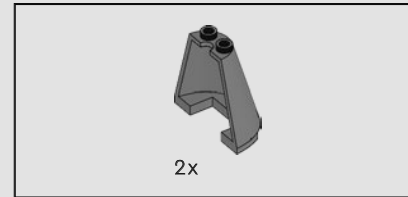
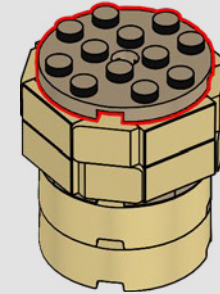

432

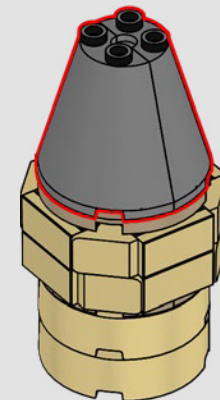

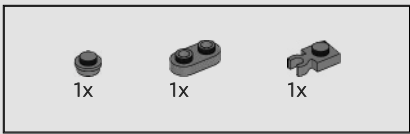

433

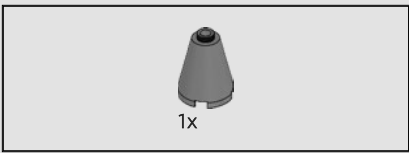
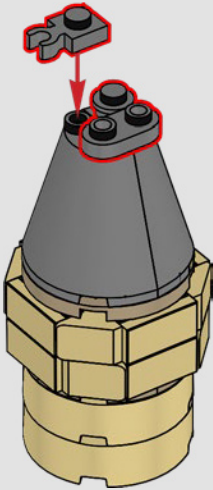

434

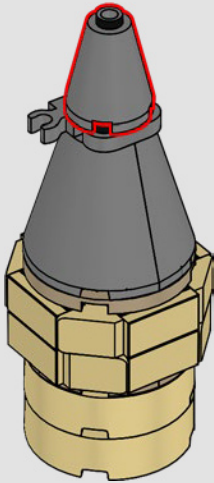

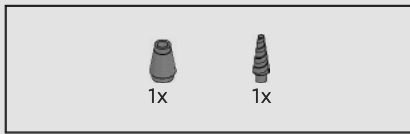

435

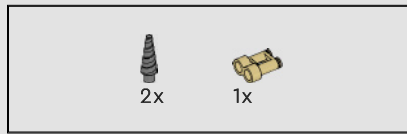
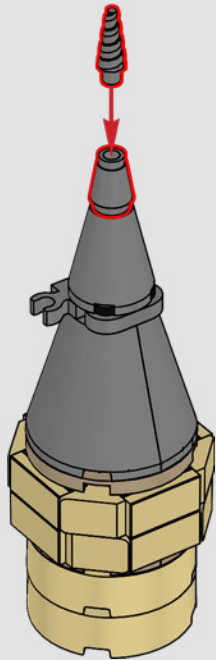

436

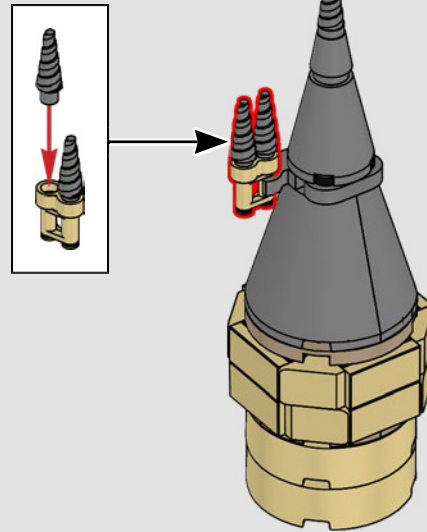

Das Büro von Albus  
Dumbledore™ (die kleinen  
Türme auf dem Hauptturm)  
wird mit einem LEGO®  
Fernrohr dargestellt.

437

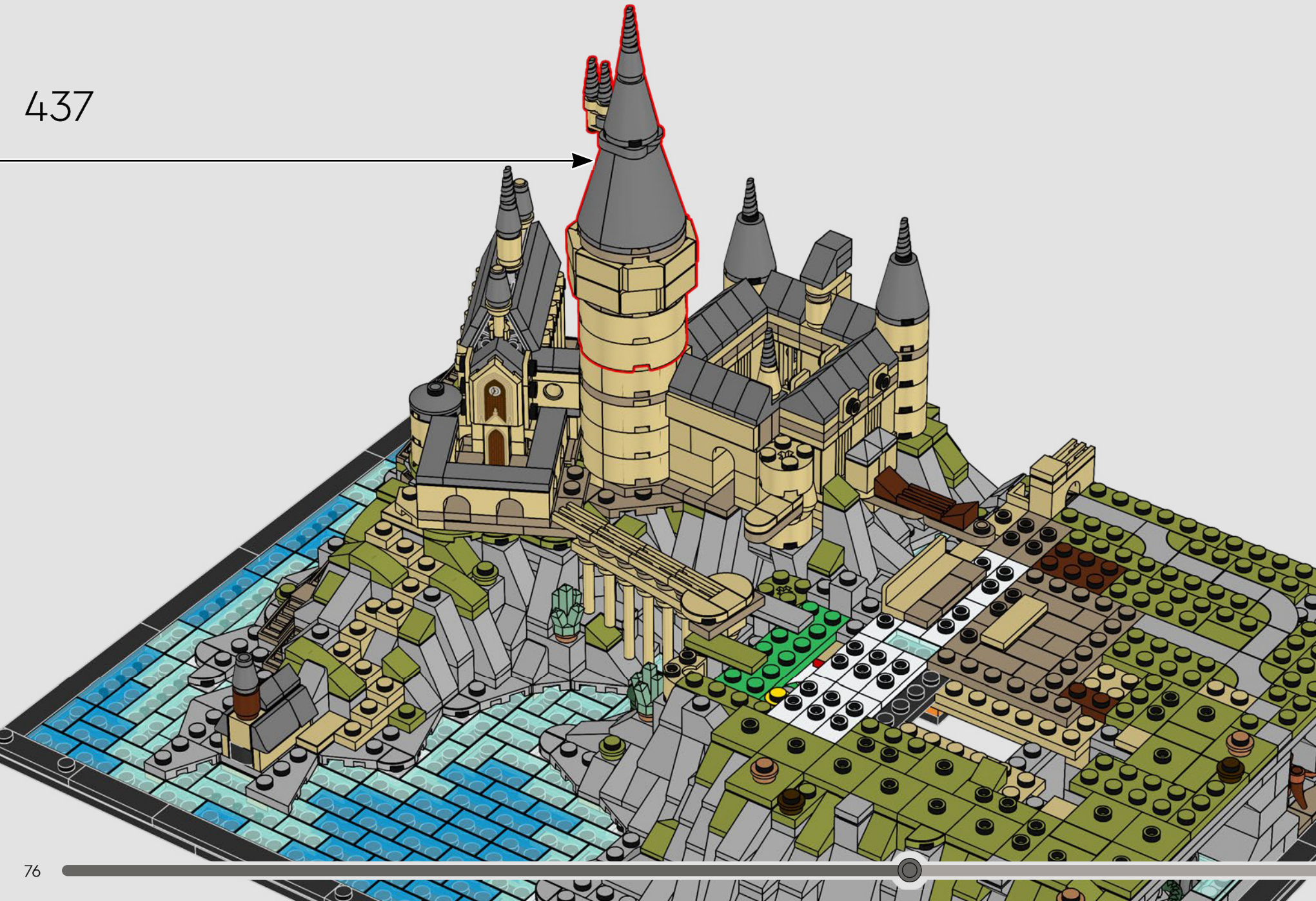



438

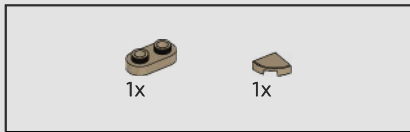
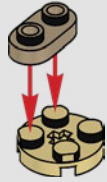

439

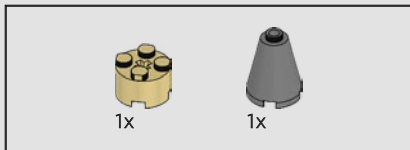

440

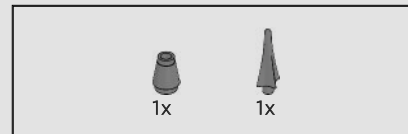
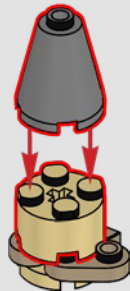

441

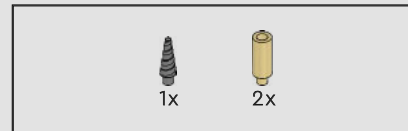
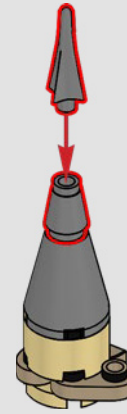

442

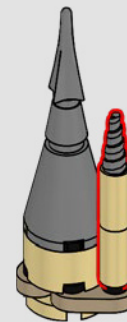
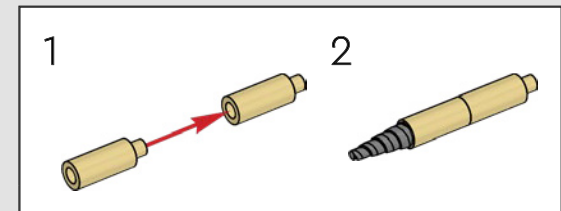

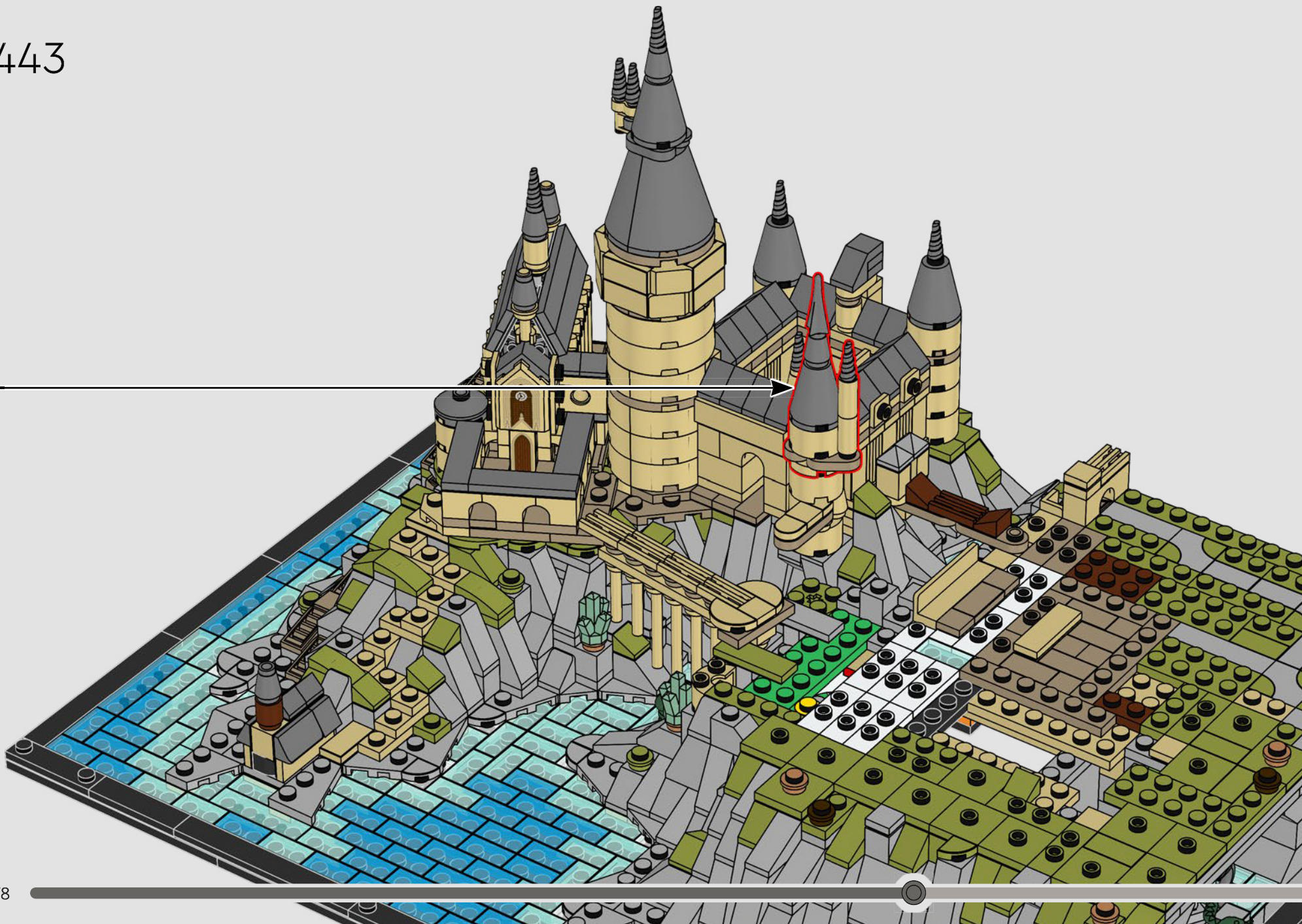



Man kann sich nicht vorstellen, dass die auf dem Schulleiterturm spießenden Türme besonders standfest wären, aber in Hogwarts™ ist eben alles möglich!





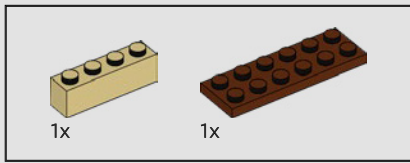

444

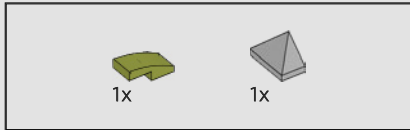
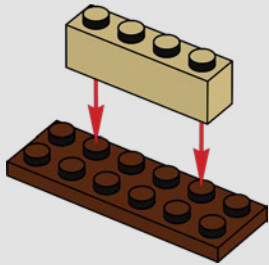

445

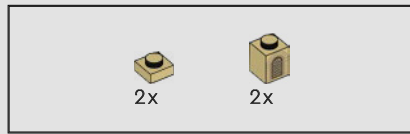
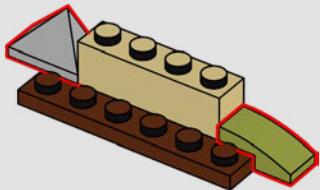

446

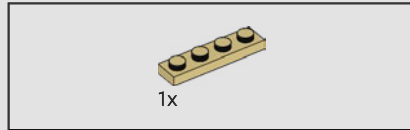
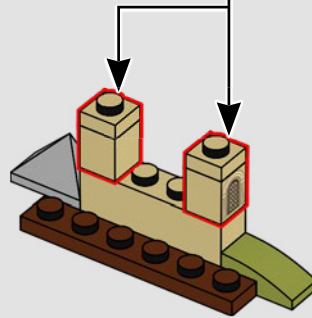
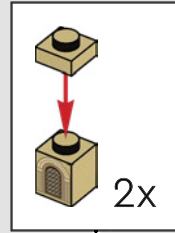

447

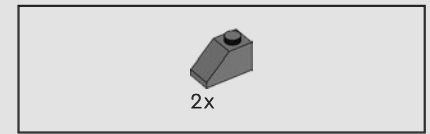
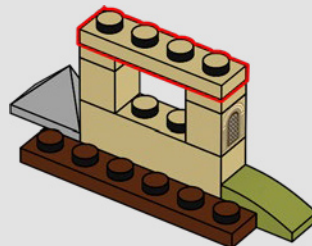

448

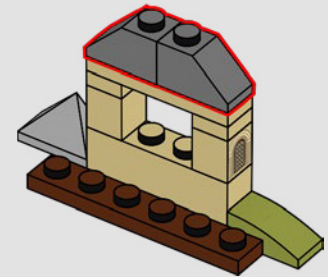

449

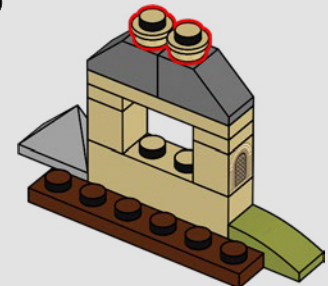

450

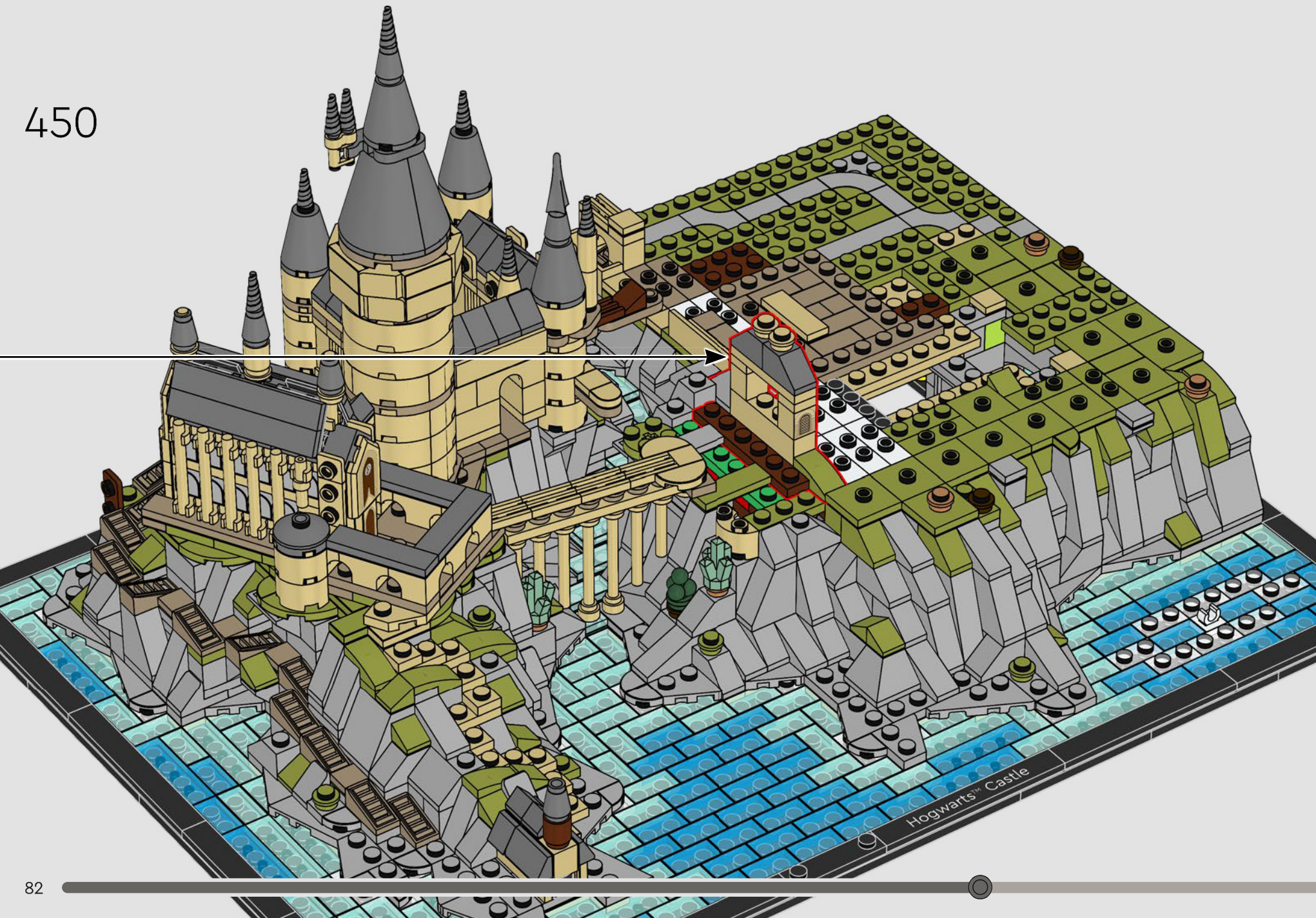

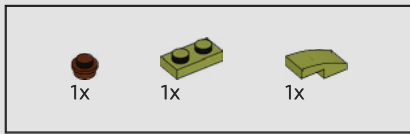

451

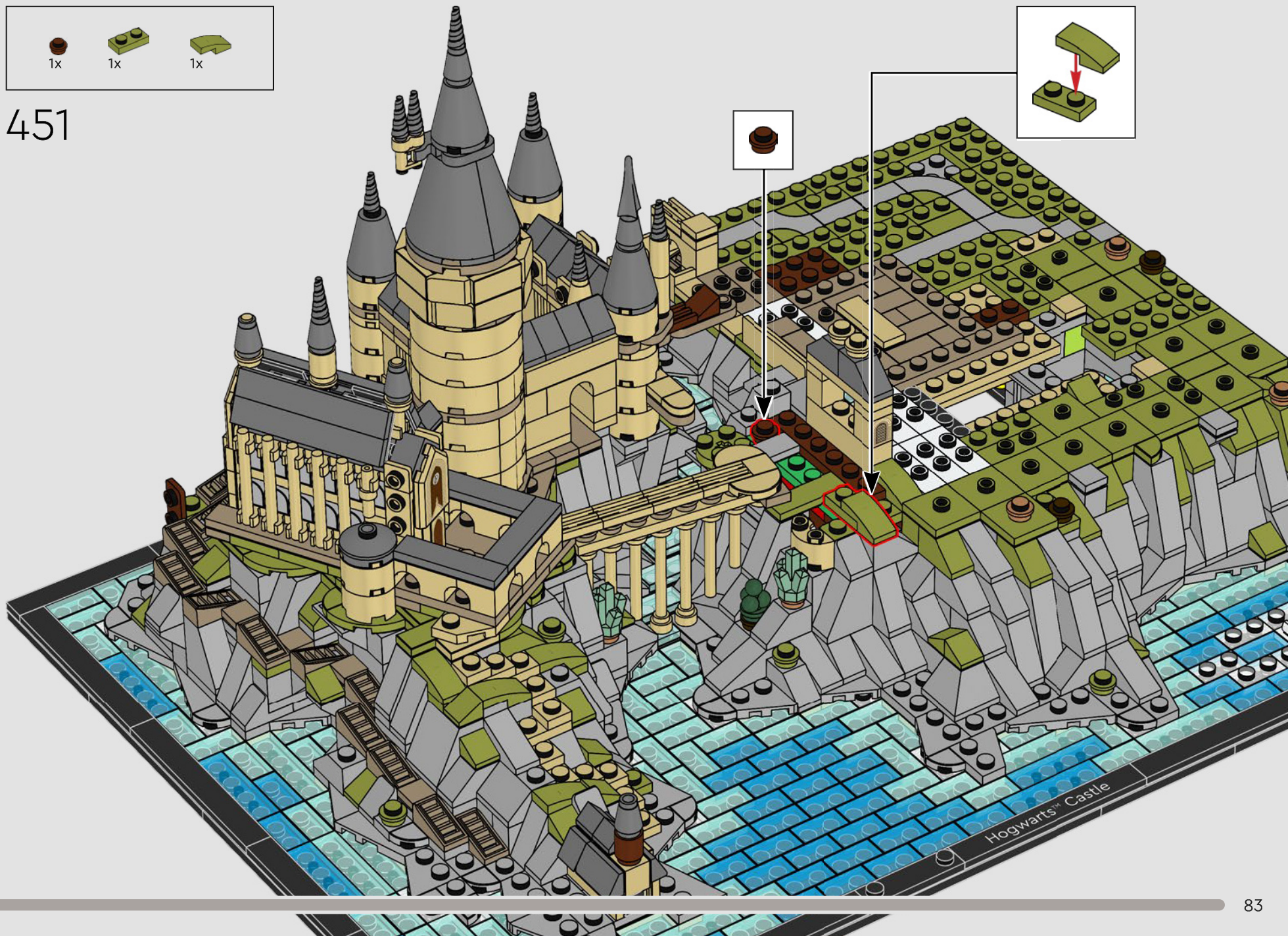

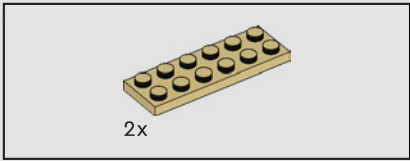

452

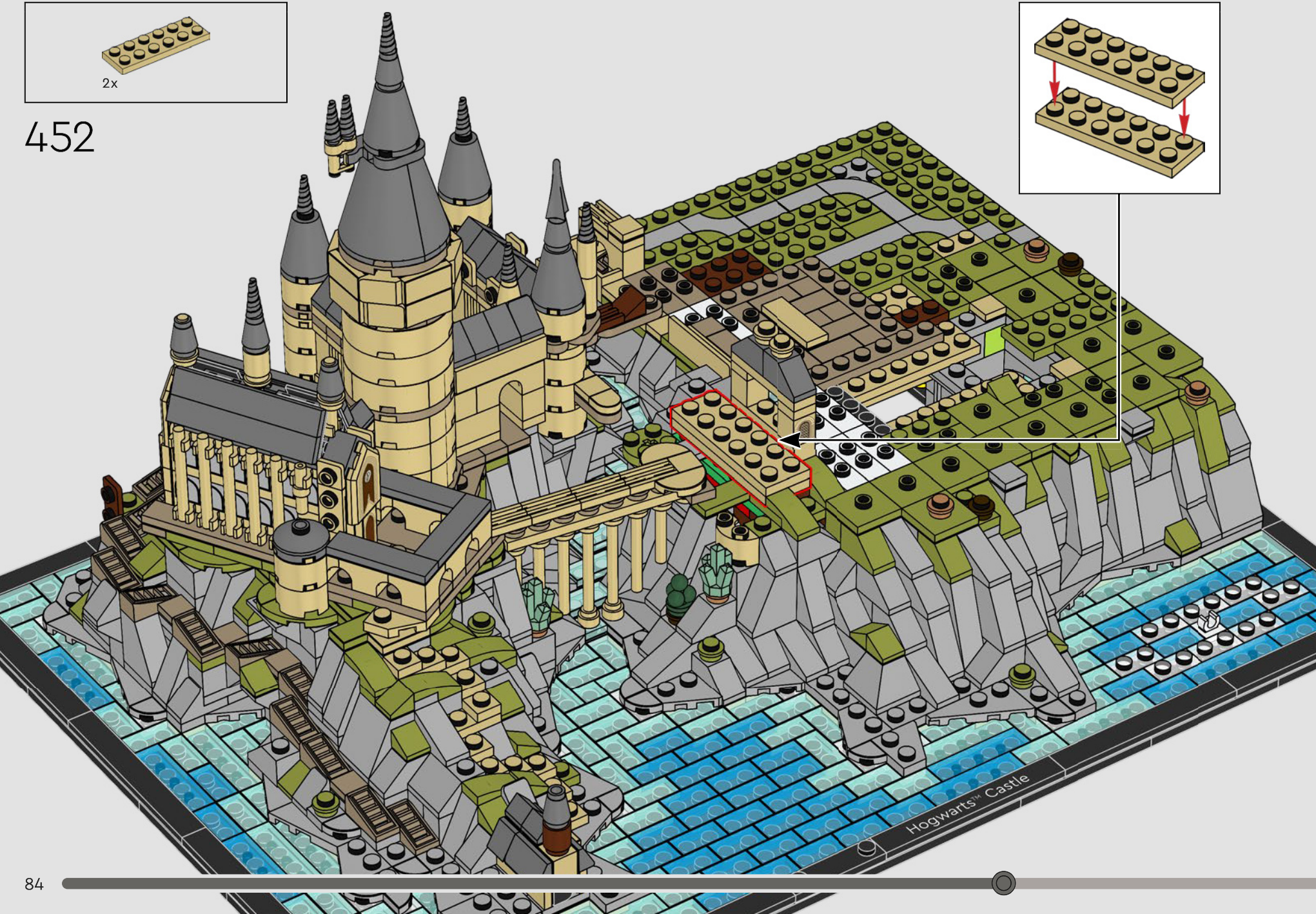
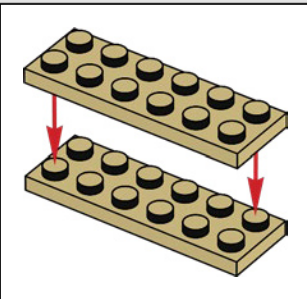



453

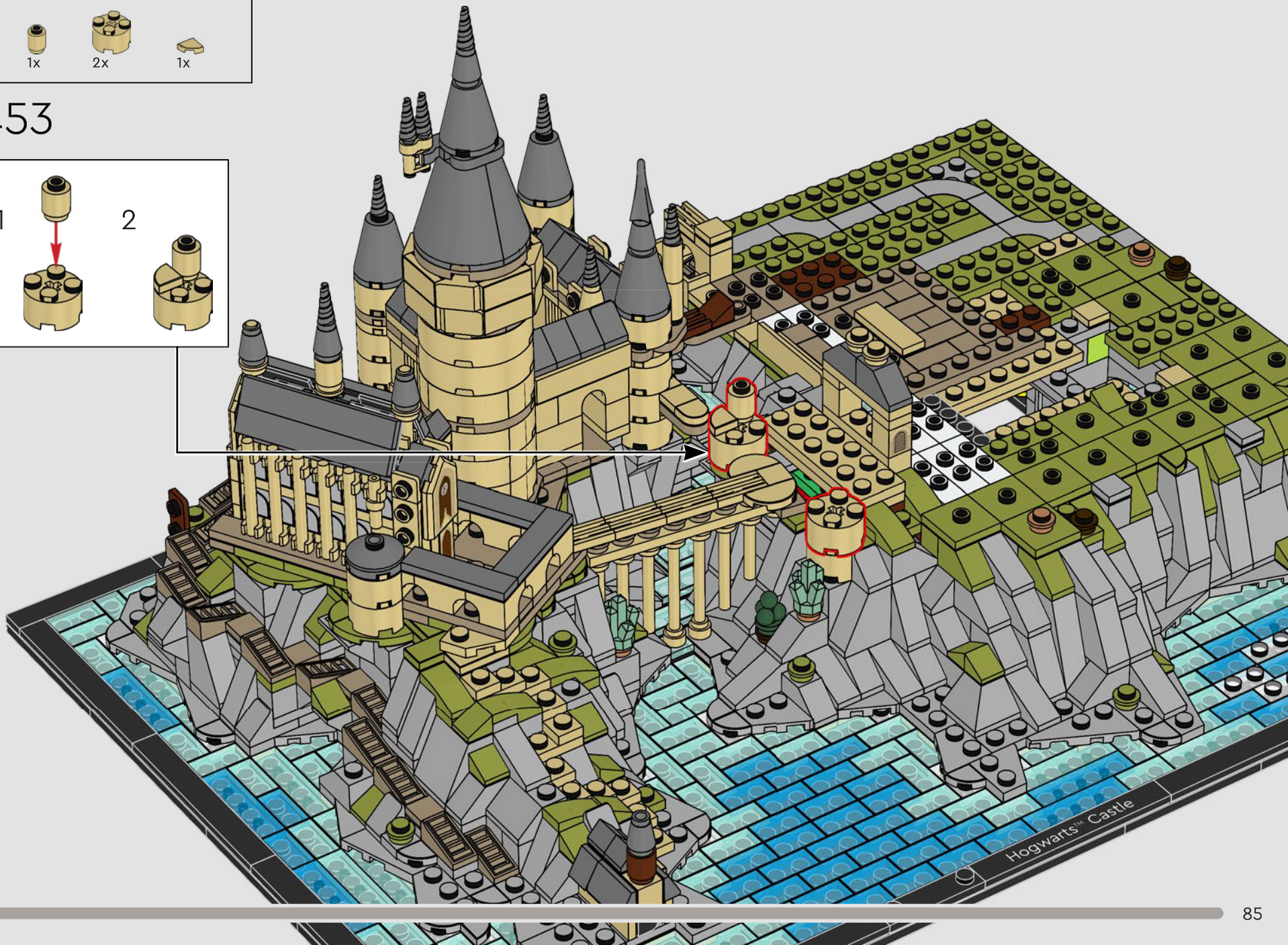
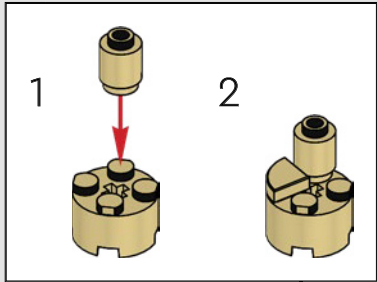



3x

454

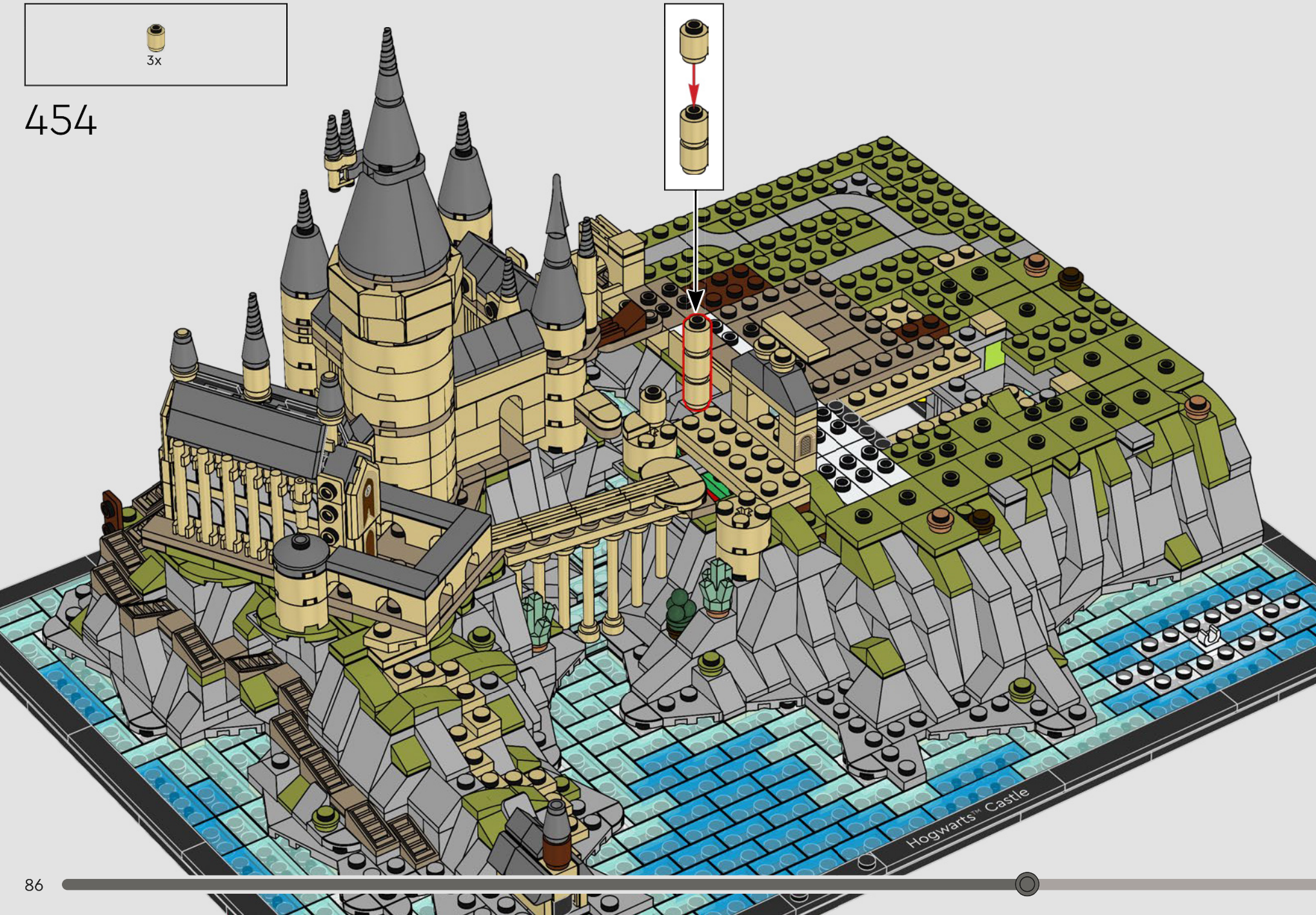
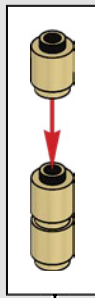

Hogwarts™ Castle

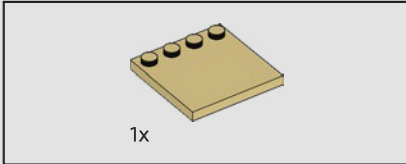
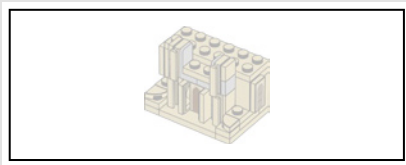

455

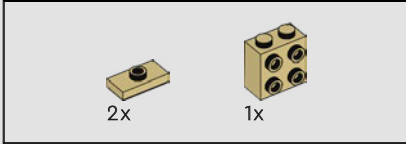
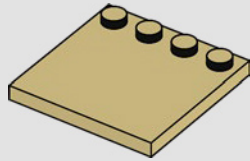

456

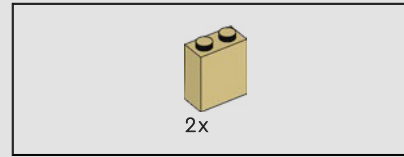
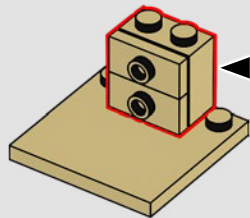
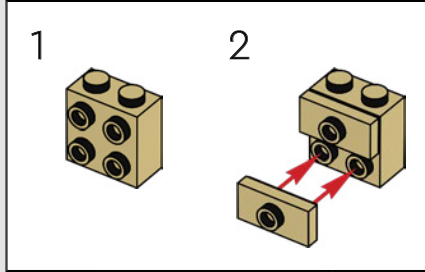

457

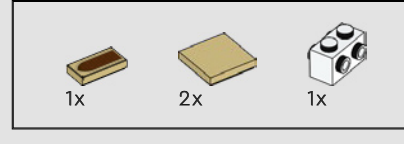
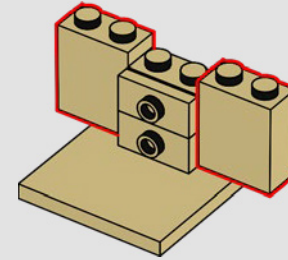

458

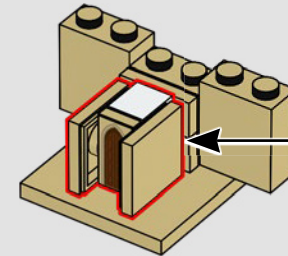
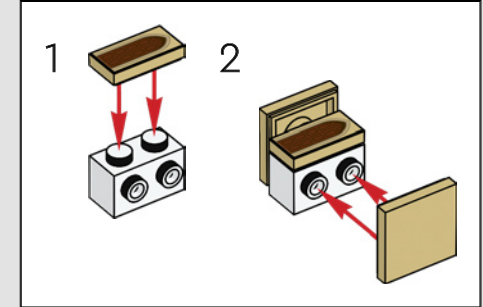

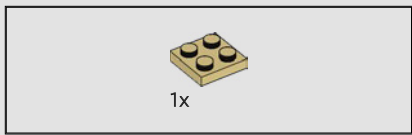

459

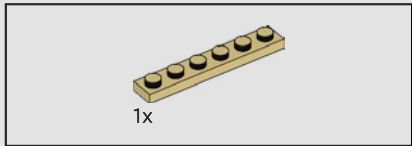
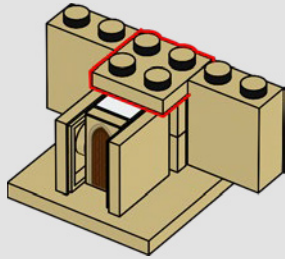

460

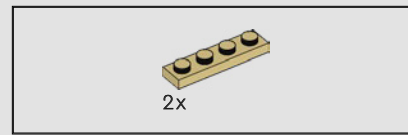
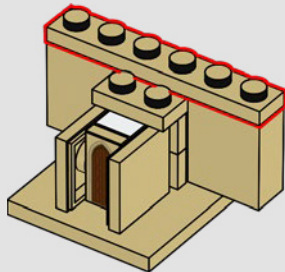

461

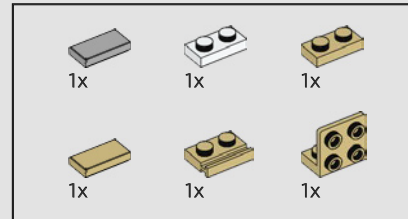
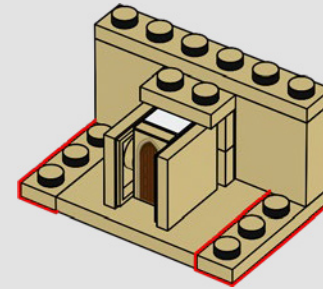

462

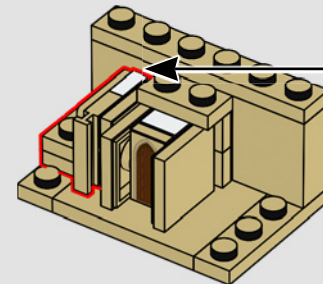
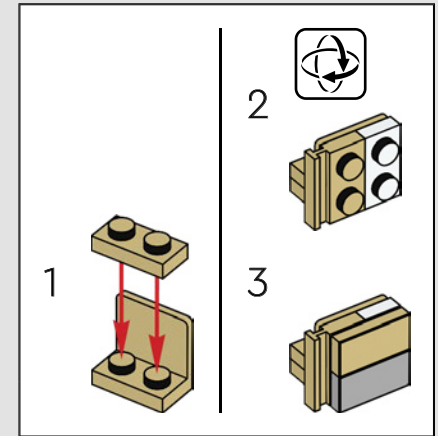



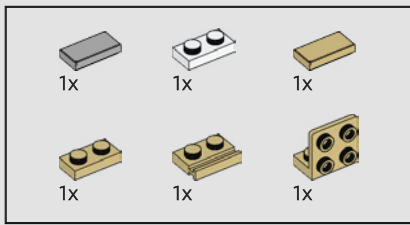

463

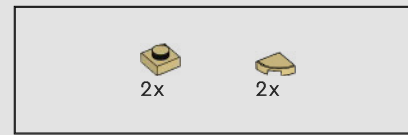
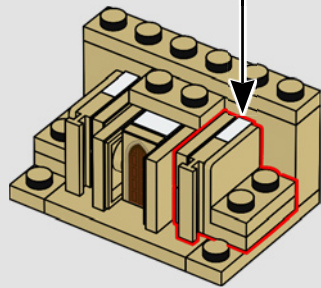
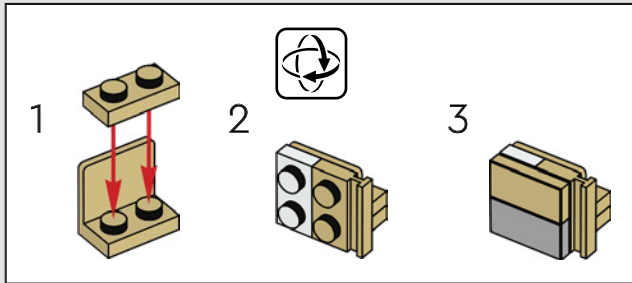

464

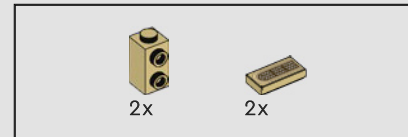
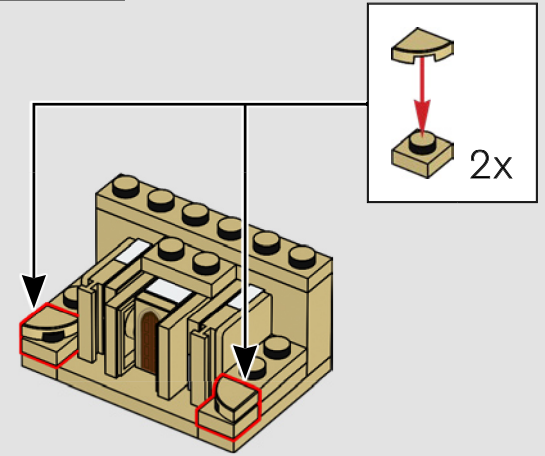

465

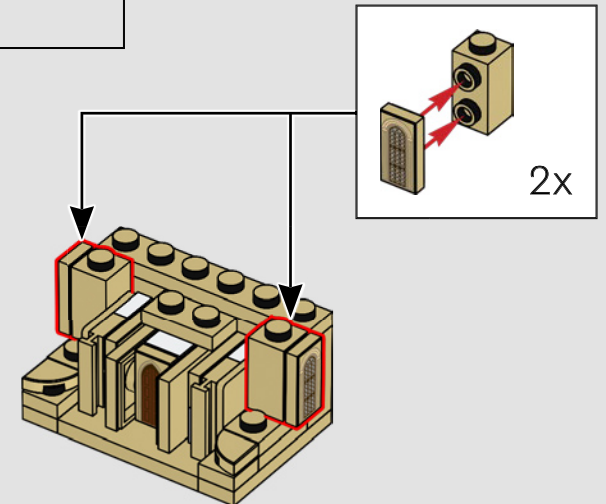

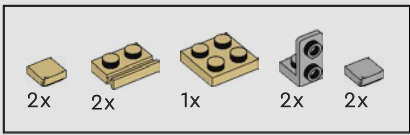

466

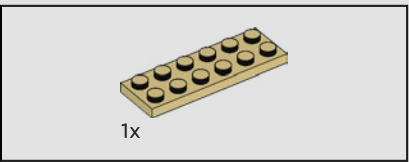
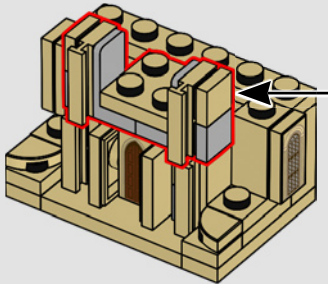
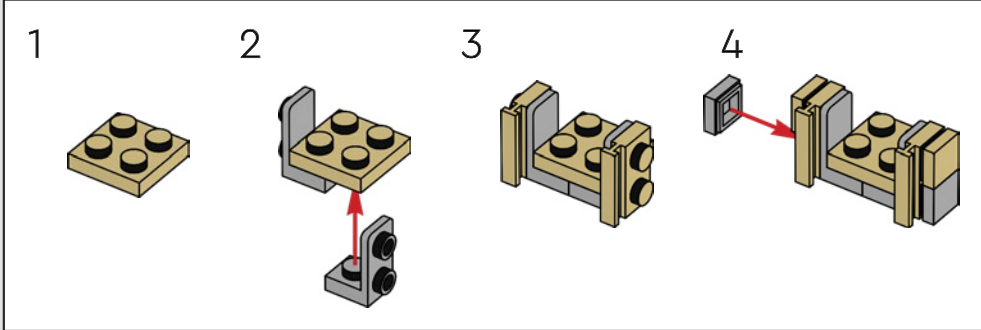

467

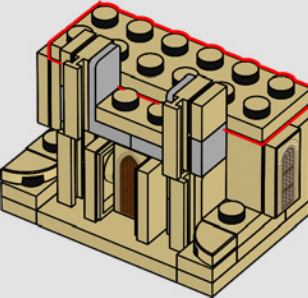

468

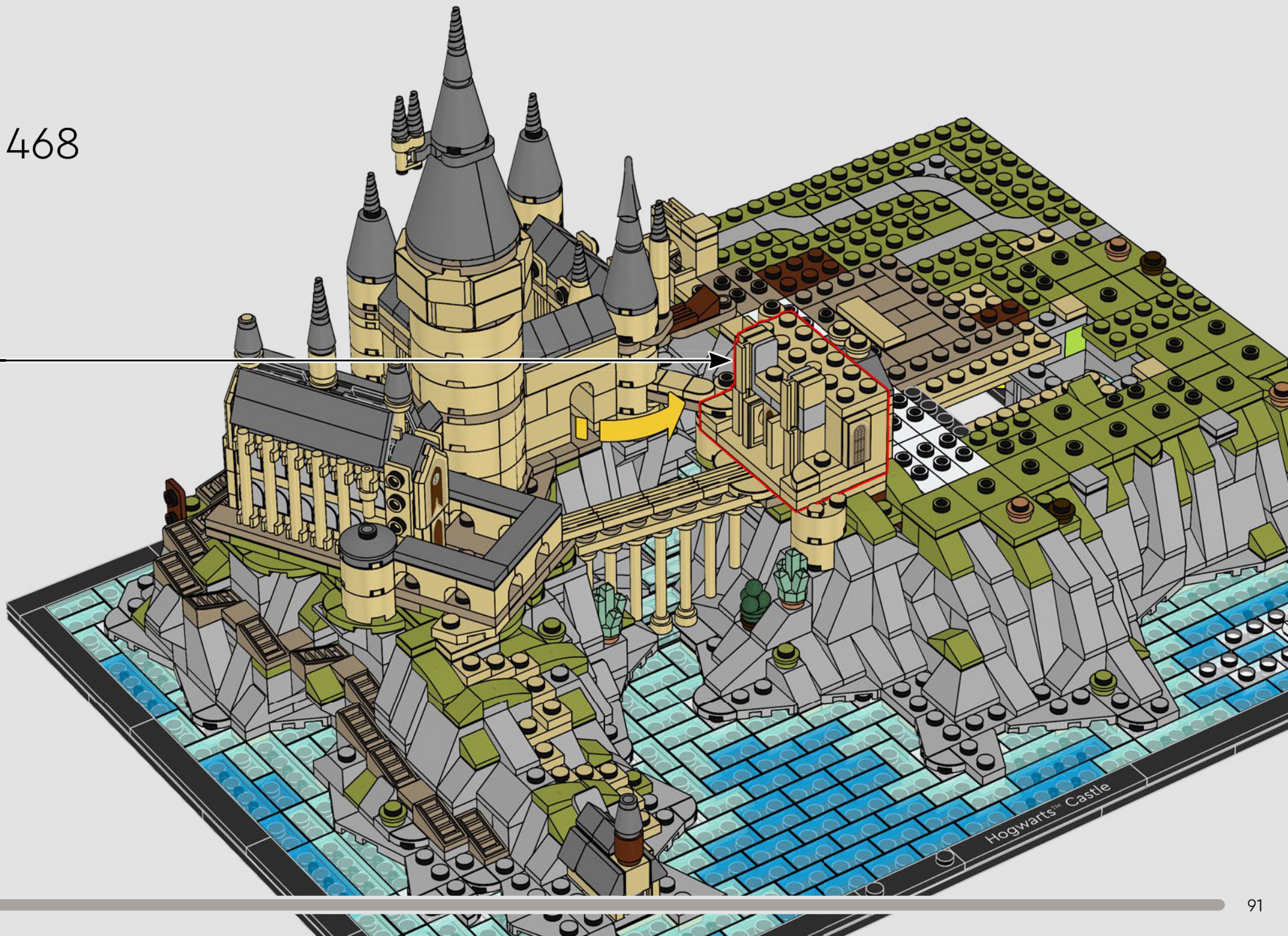

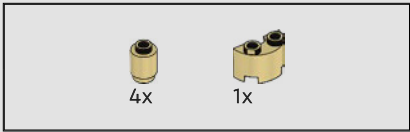

469

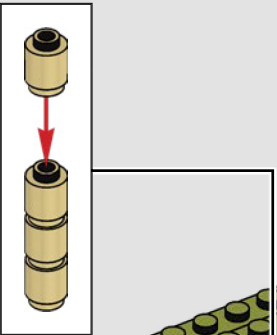



470

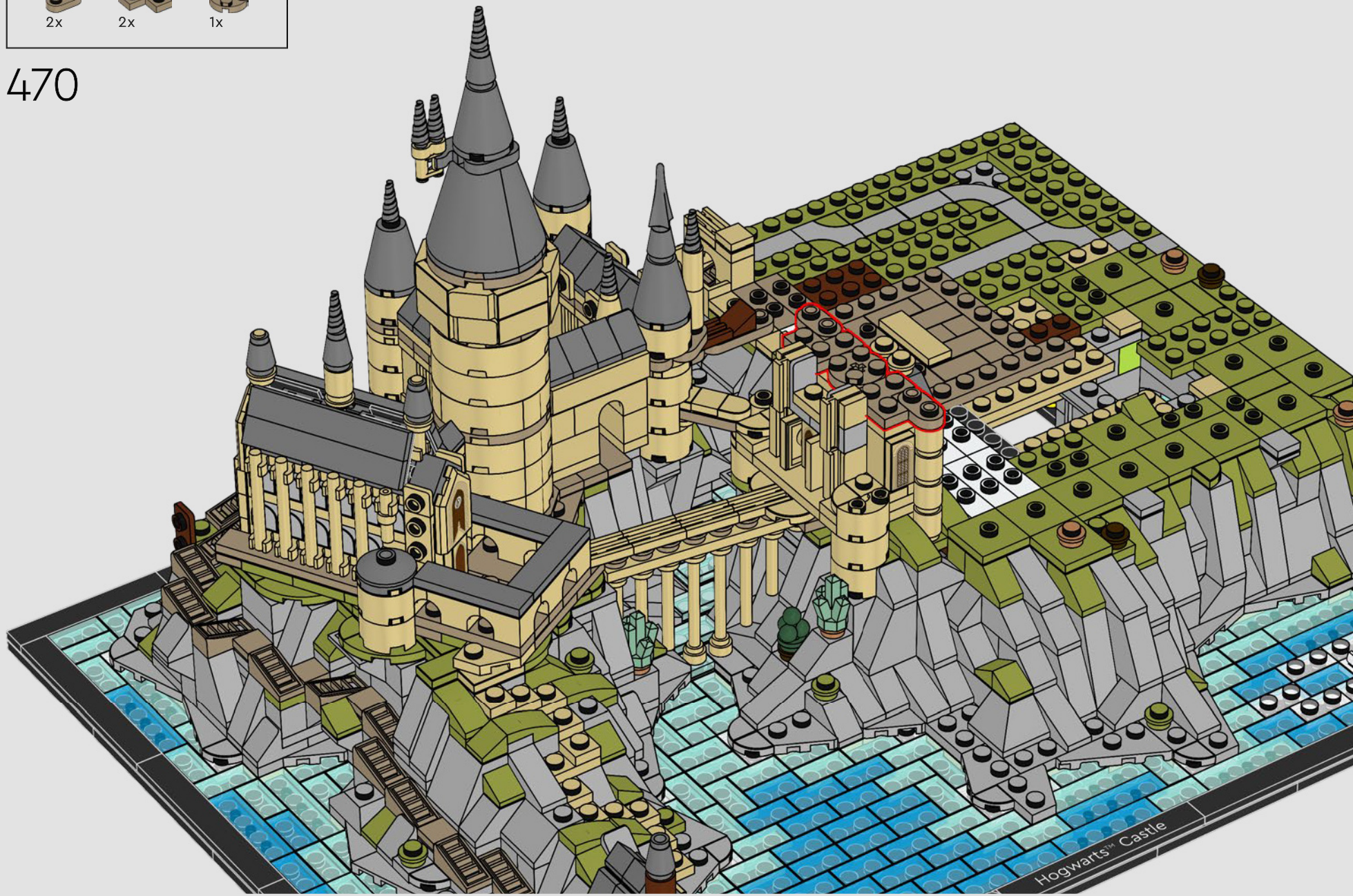

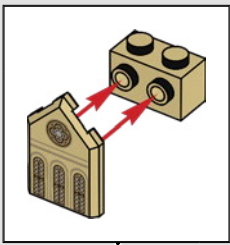
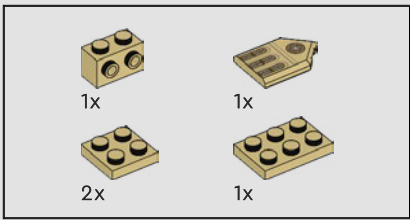

471

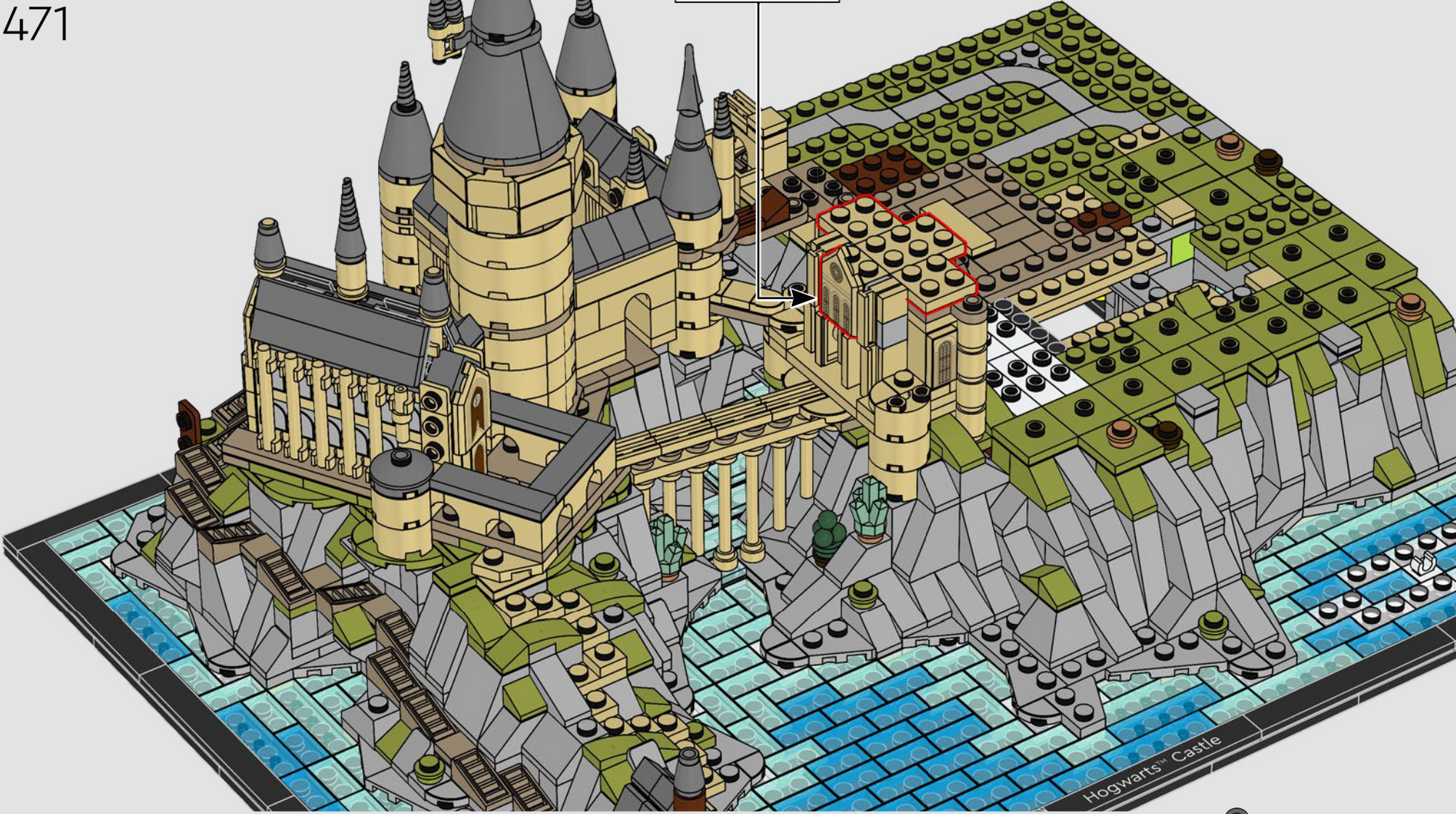

Hogwarts™ Castle



472

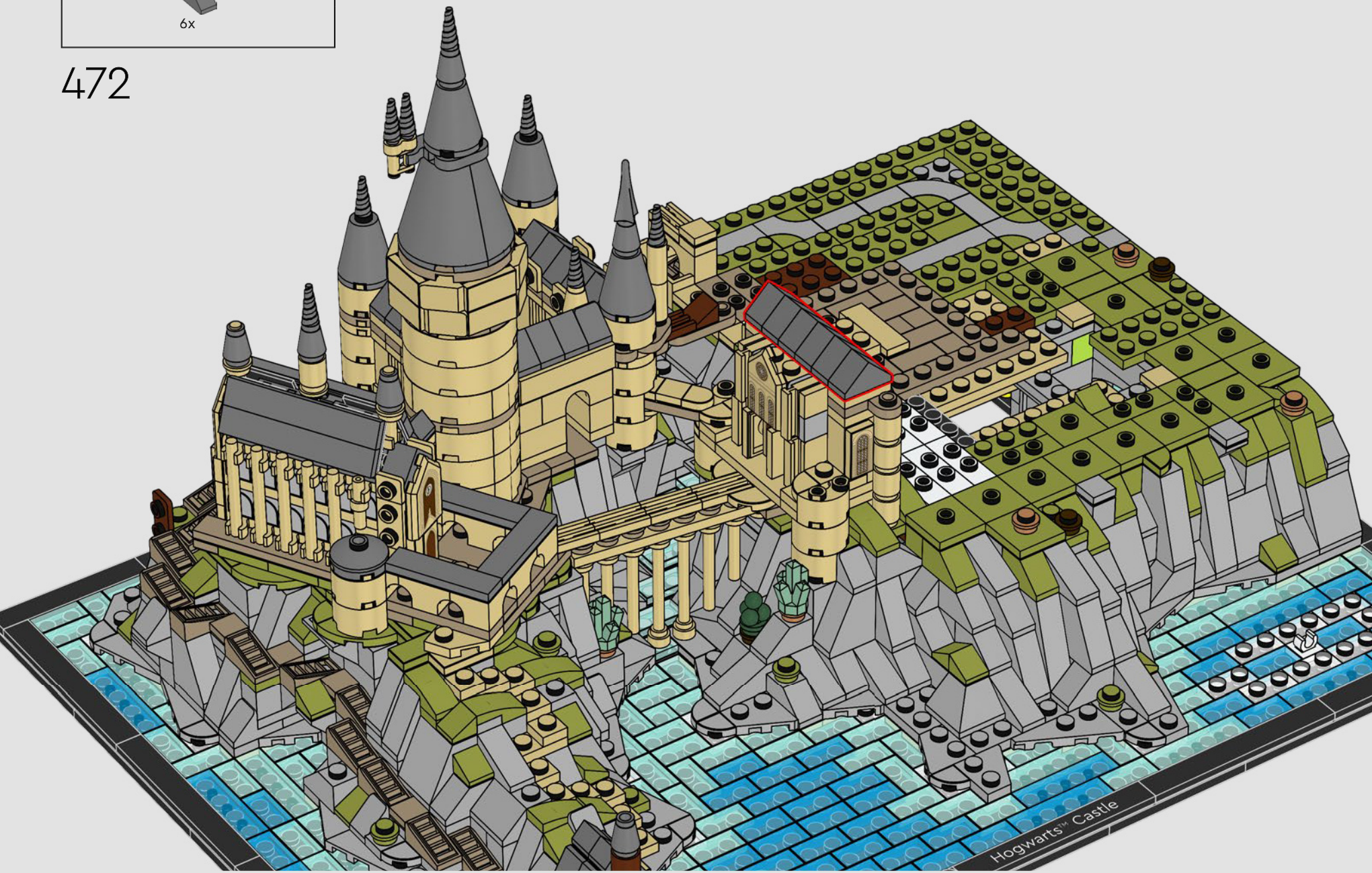

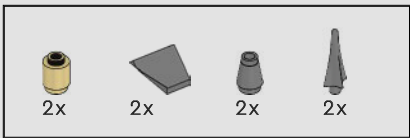

473

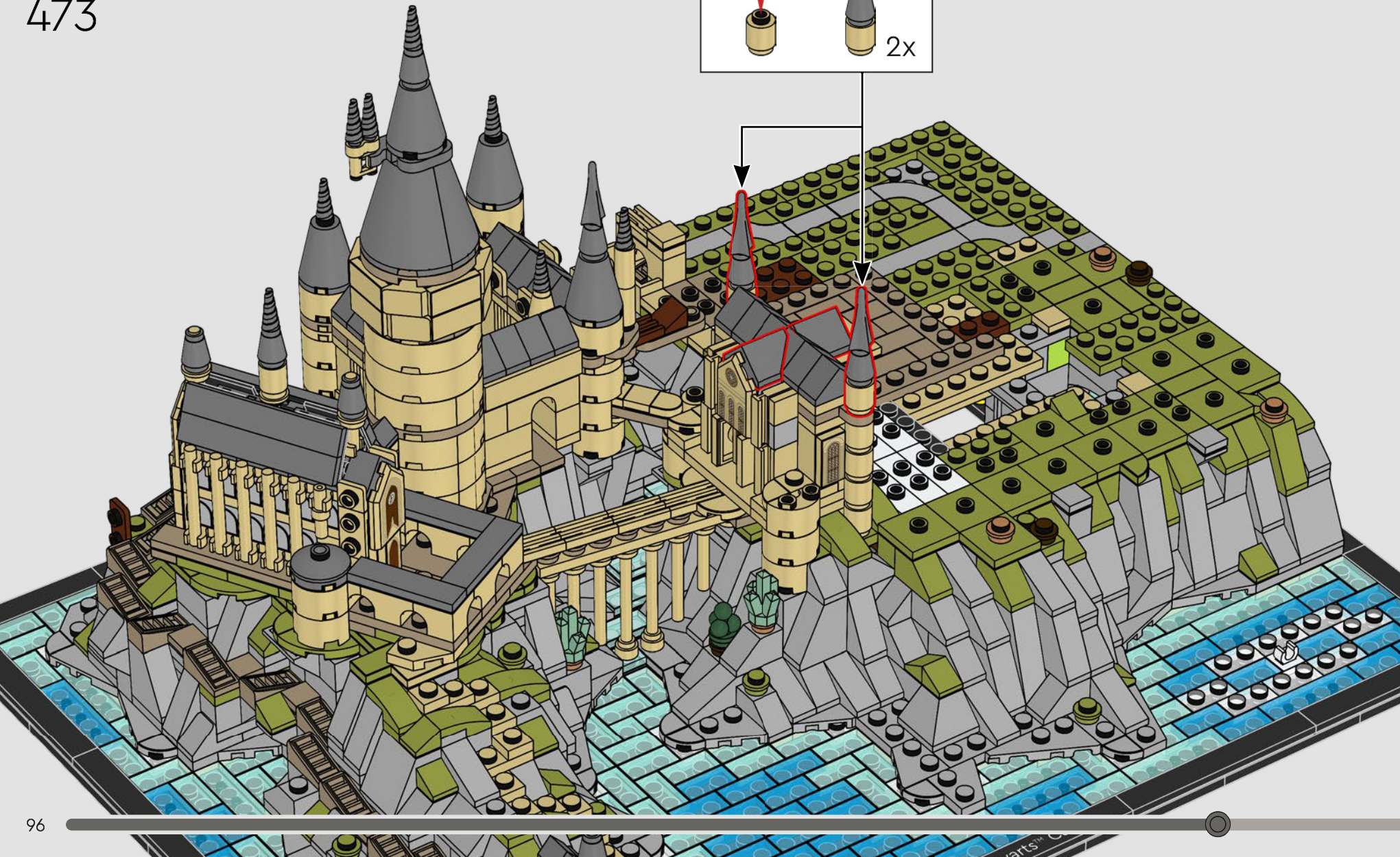
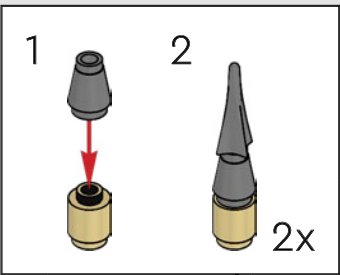



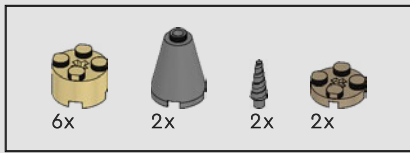

474

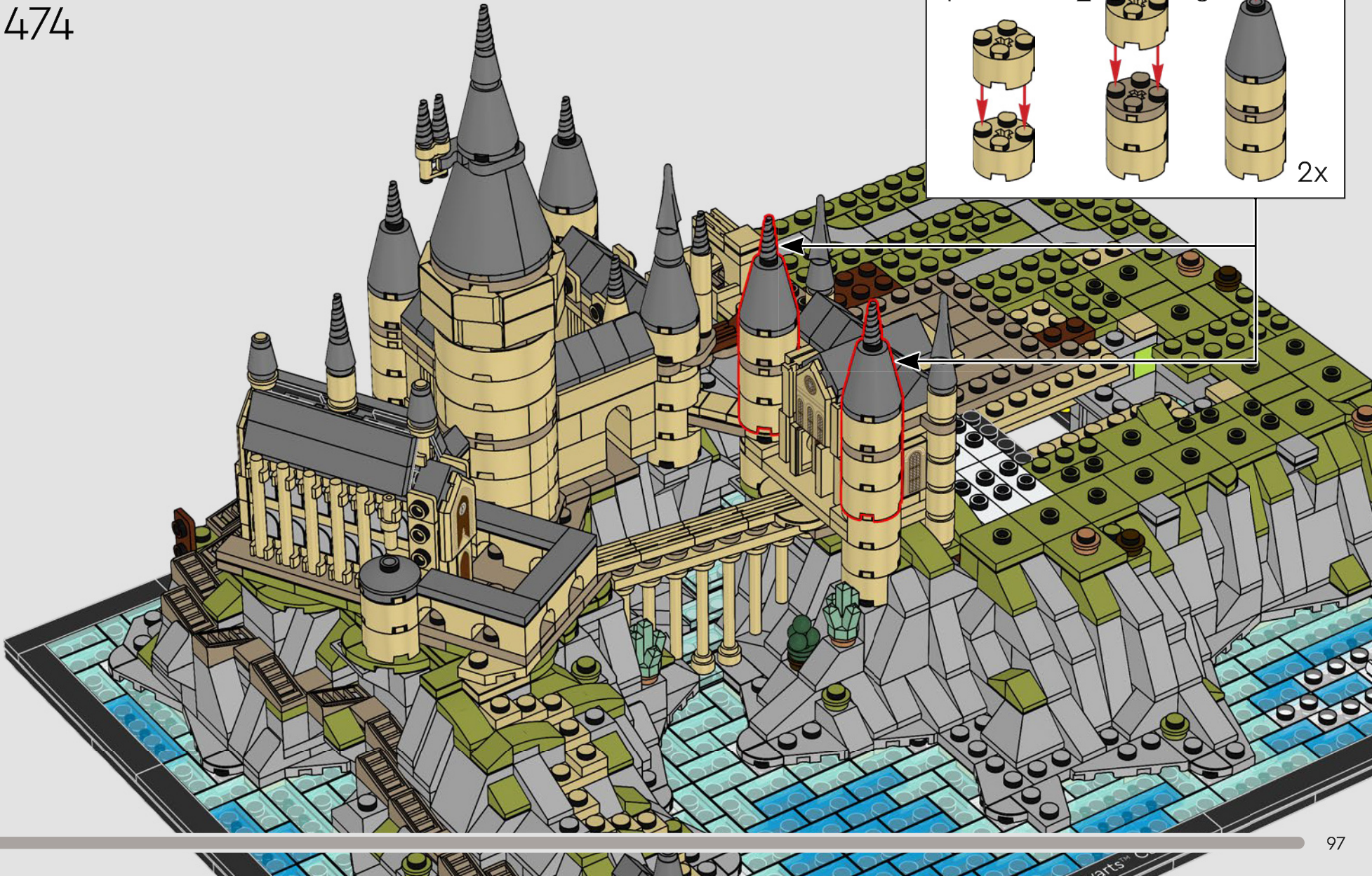
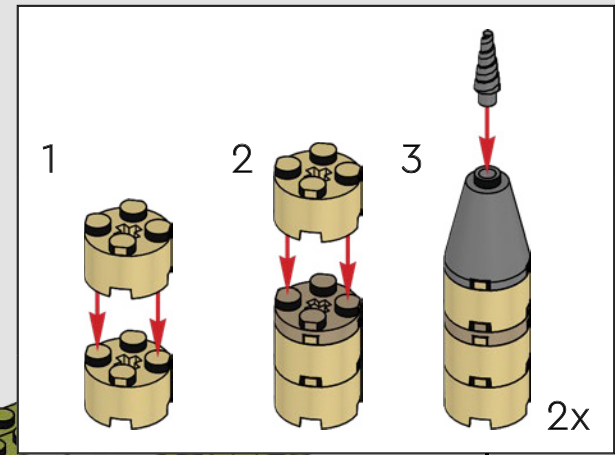

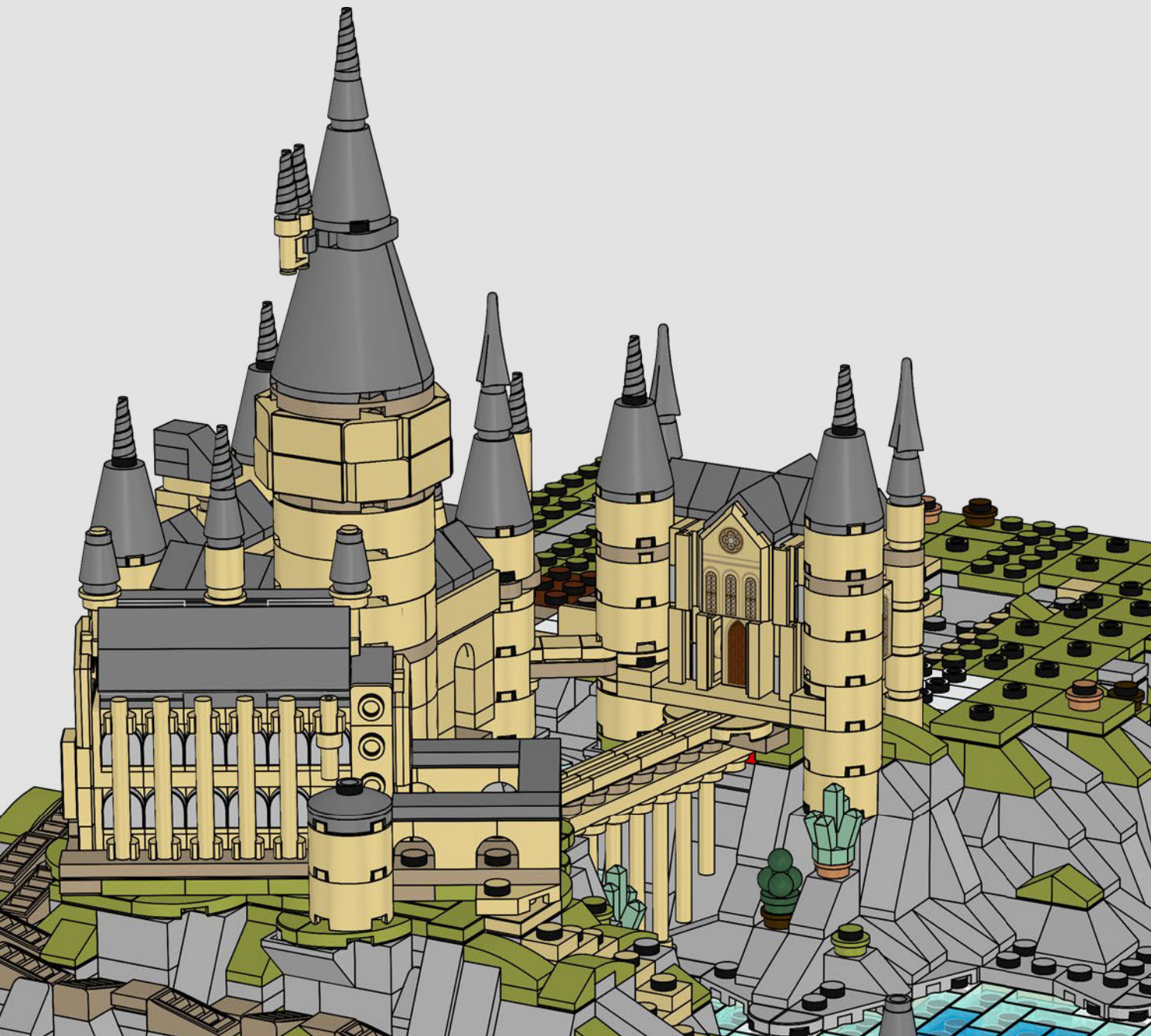

In diesem Teil des Schlosses befinden sich die Mädchentoiletten. Vielleicht schaut die Maulende Myrte vorbei, während du das Modell baust. Aber hüte dich vor den Trollen.





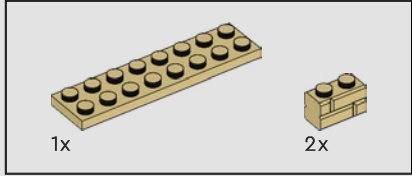
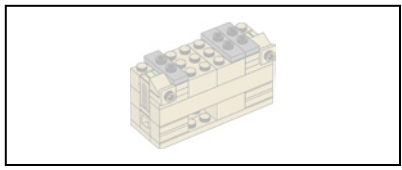

475

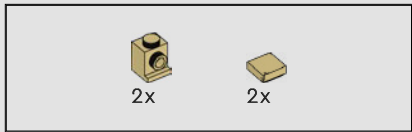
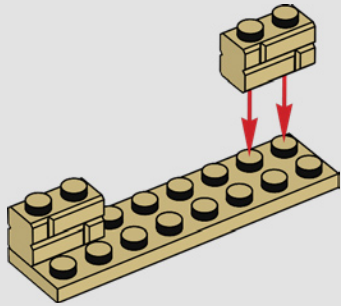

476

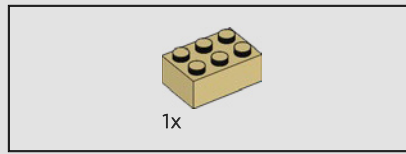
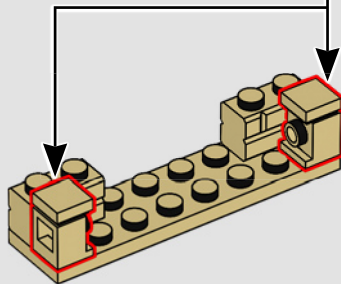
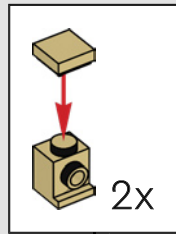

477

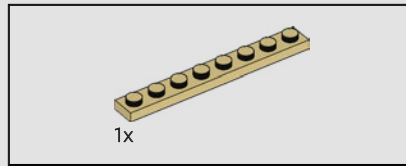
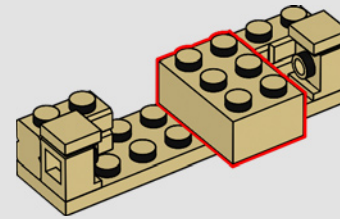

478

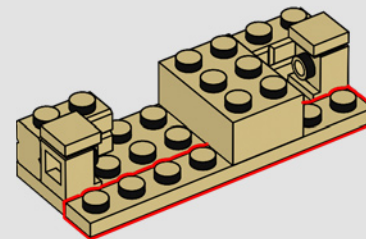

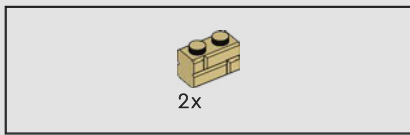

479

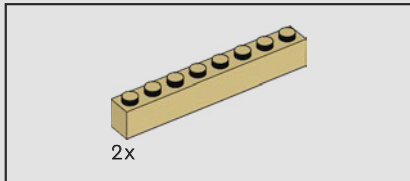
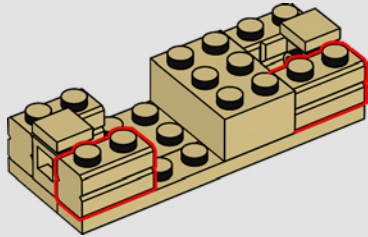

480

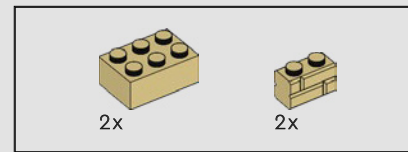
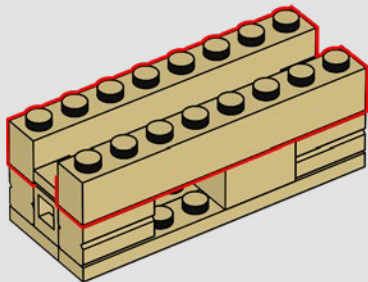

481

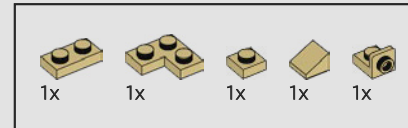
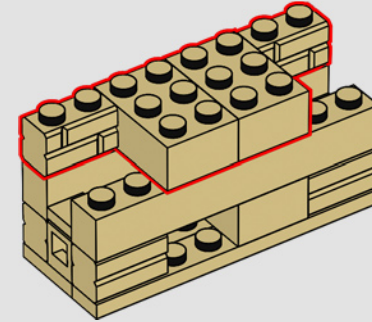

482

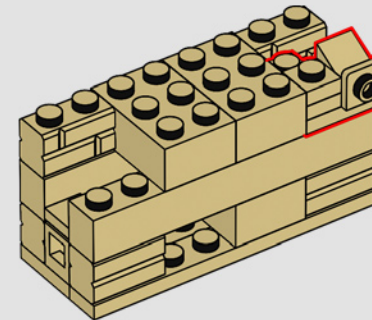
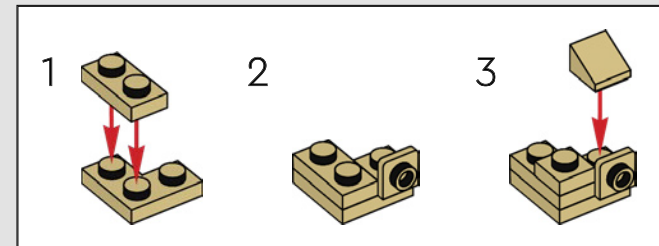

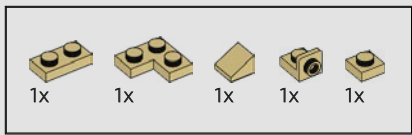

483

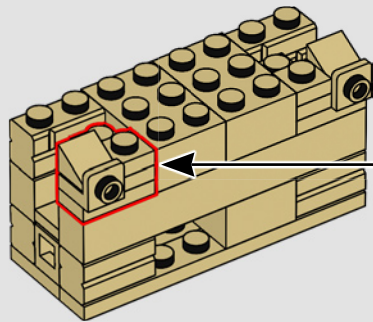
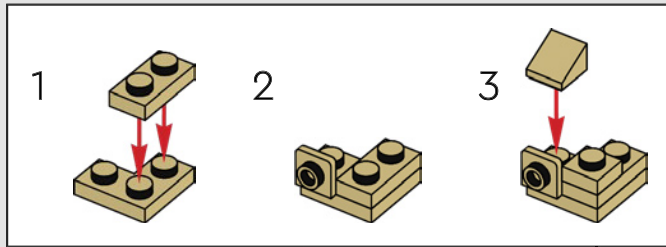

484

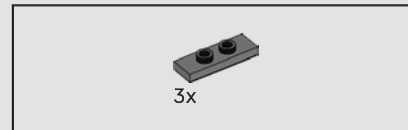
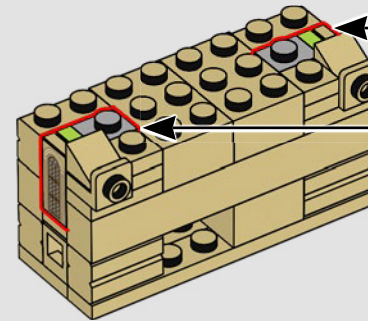
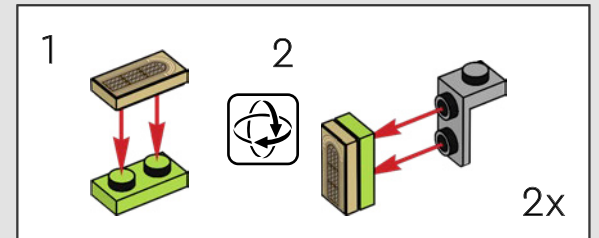

485

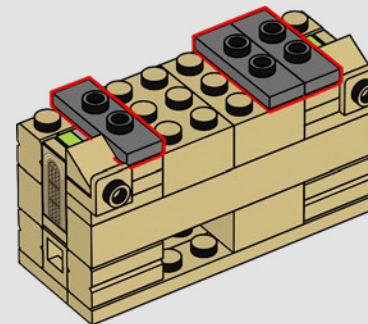

486



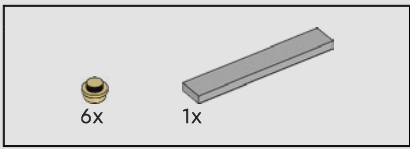

487

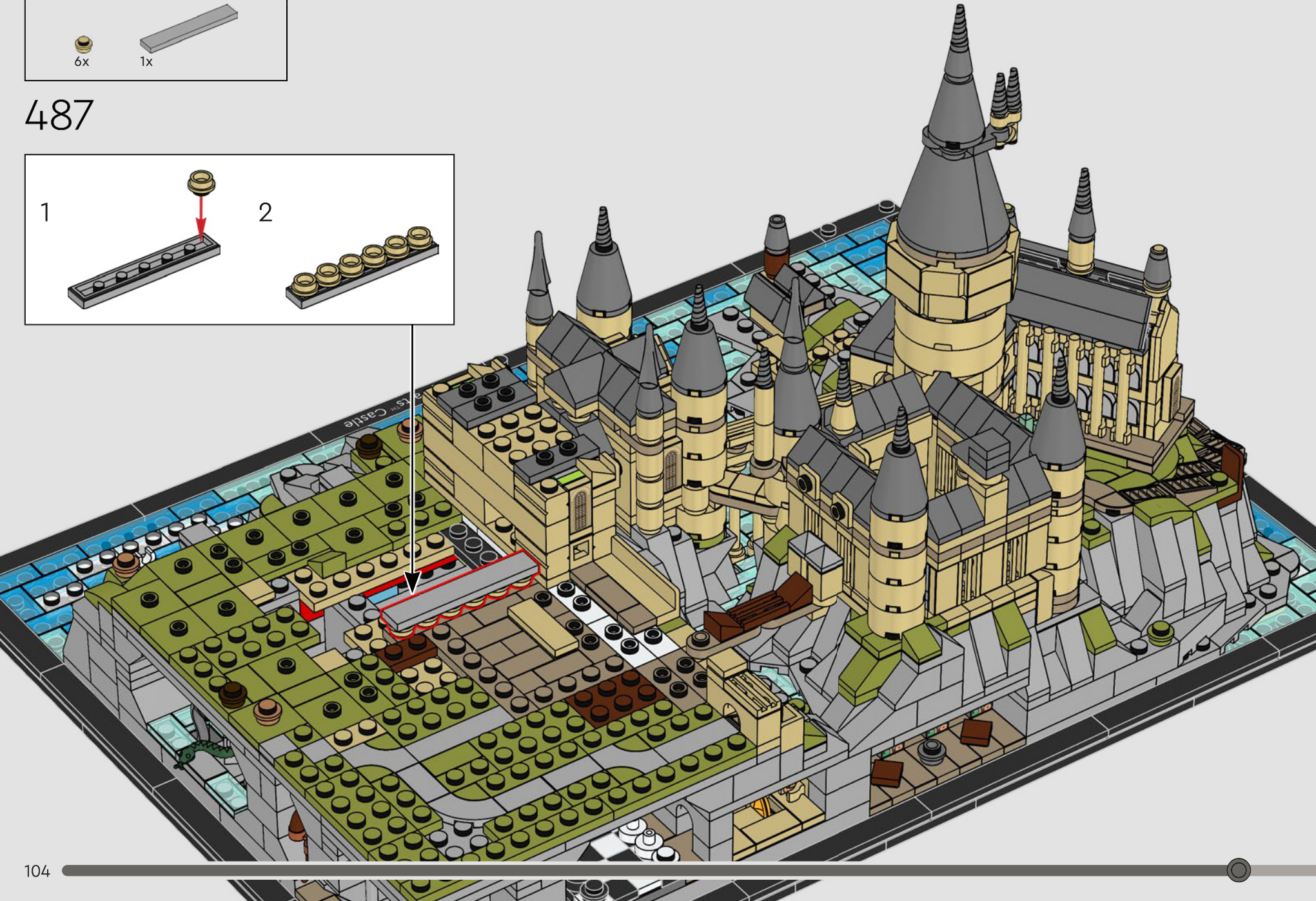
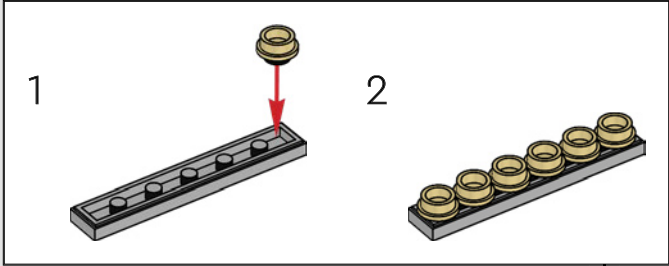



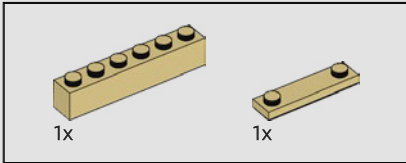
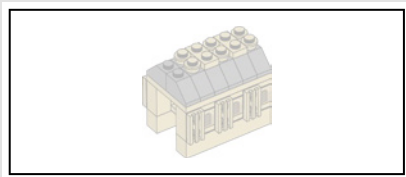

488

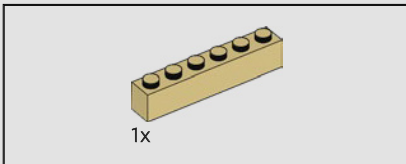
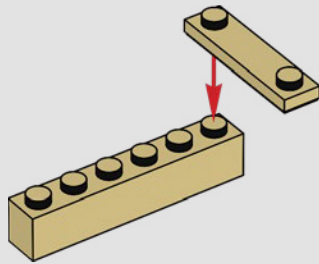

489

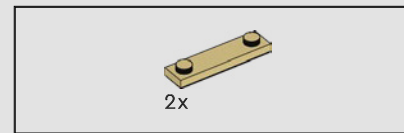
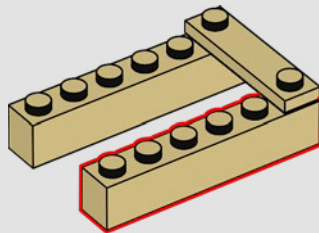

490

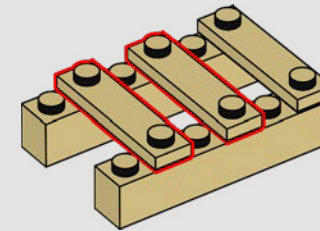

491

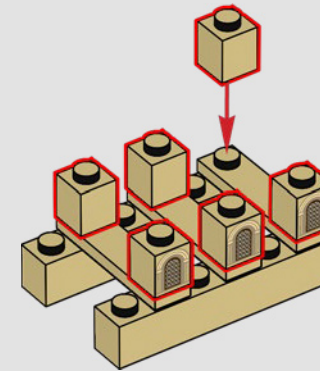

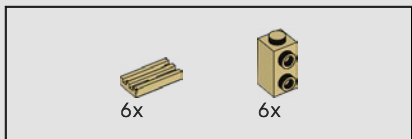

492

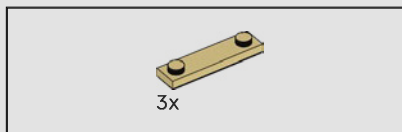
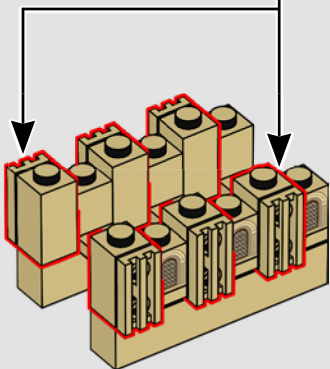
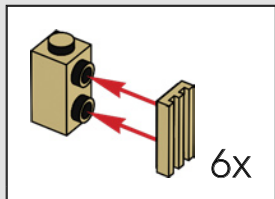

493

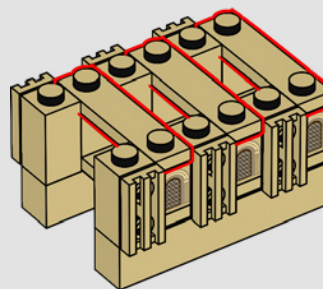

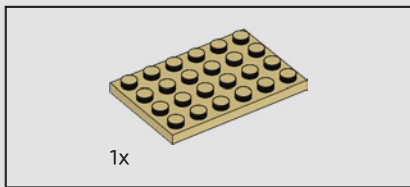

494

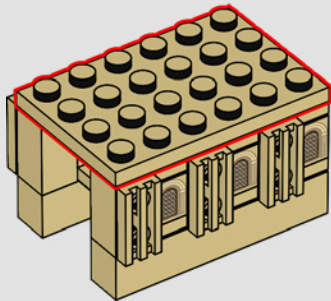

495

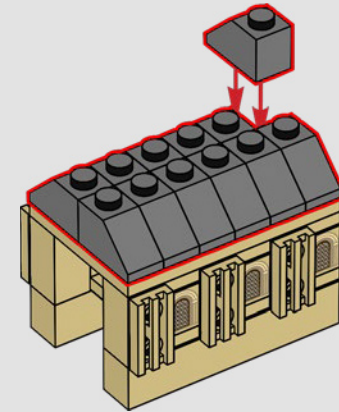

496

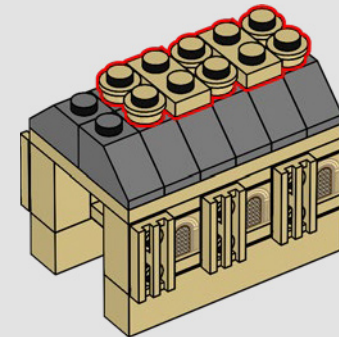

497

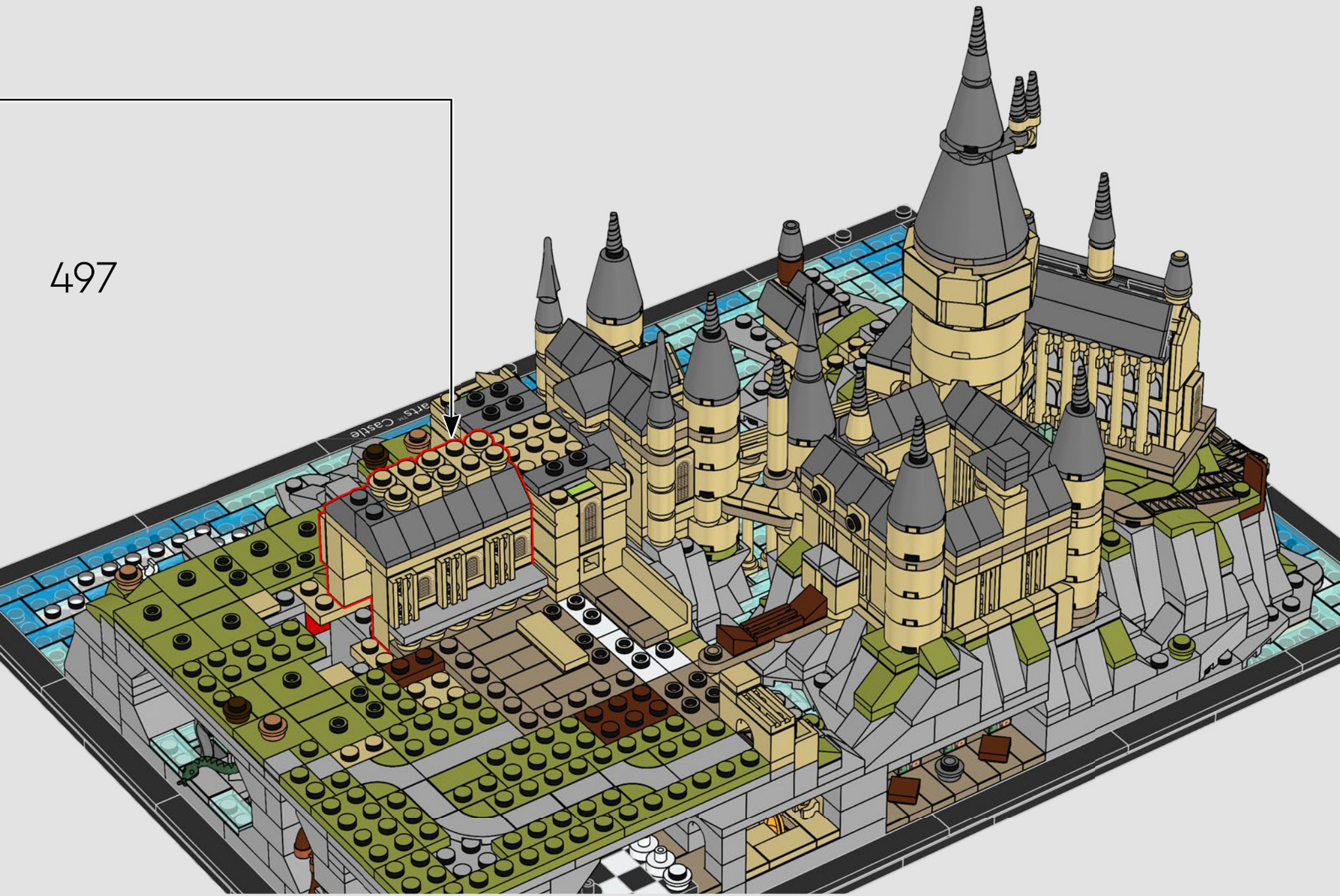

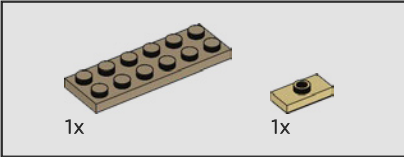
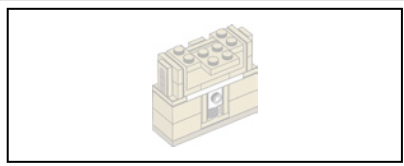

498

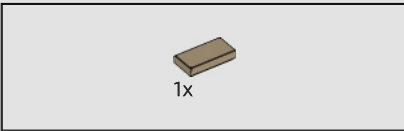
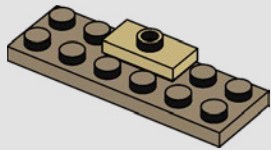

499

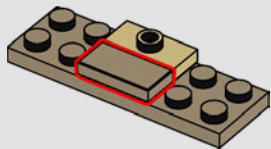

500

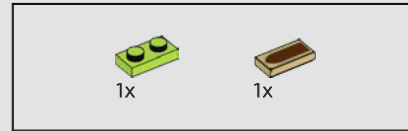
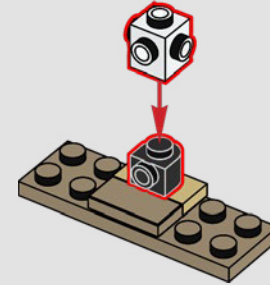

501

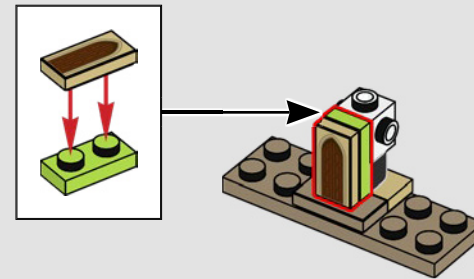

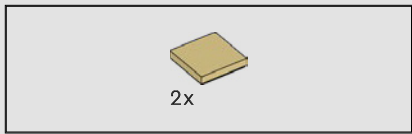

502

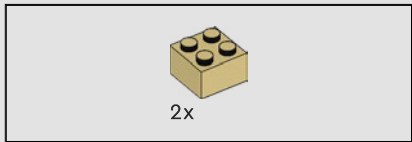
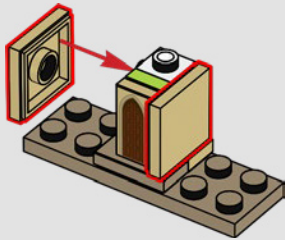

503

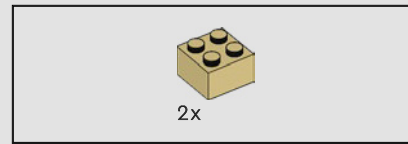
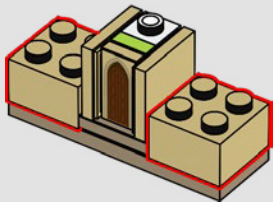

504

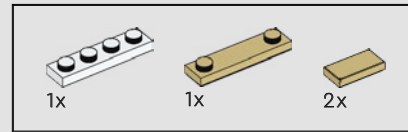
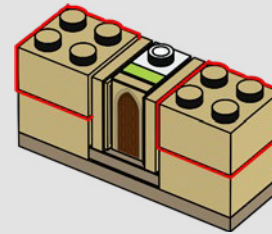

505

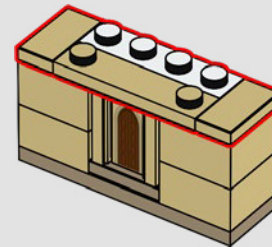

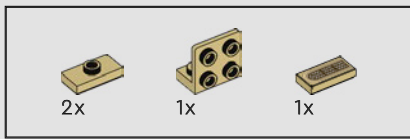

506

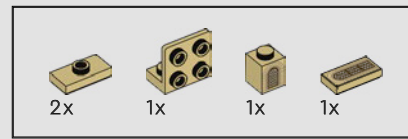
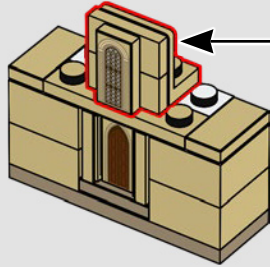
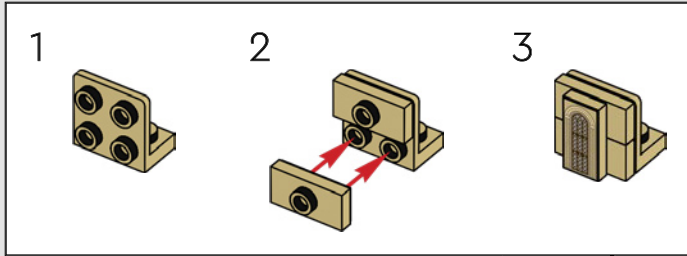

507

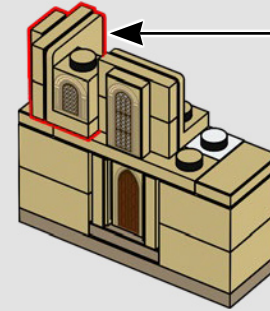
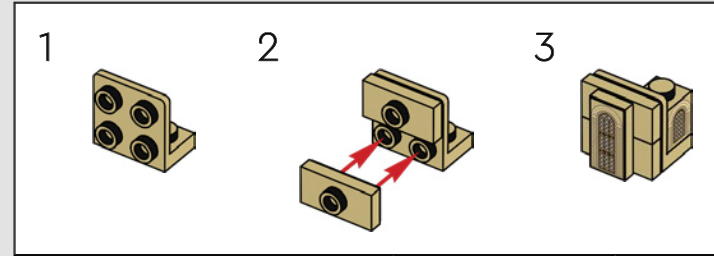

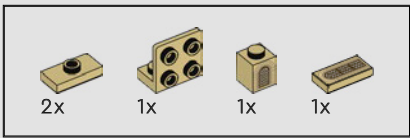

508

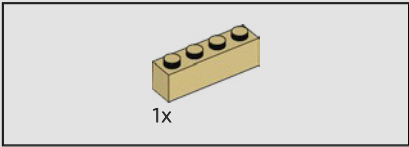
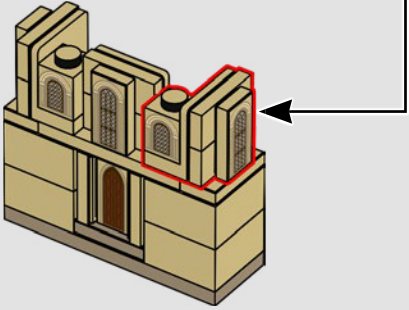
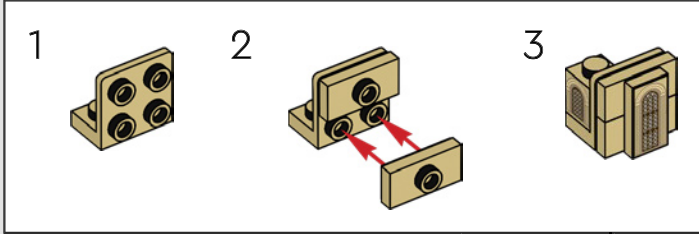

509

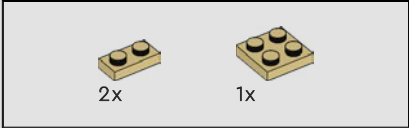
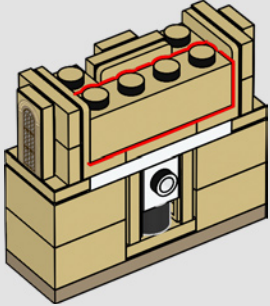

510

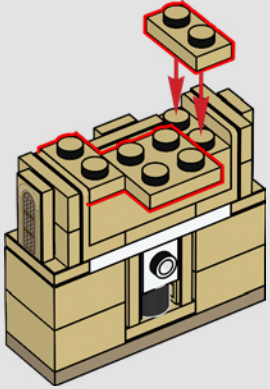



511

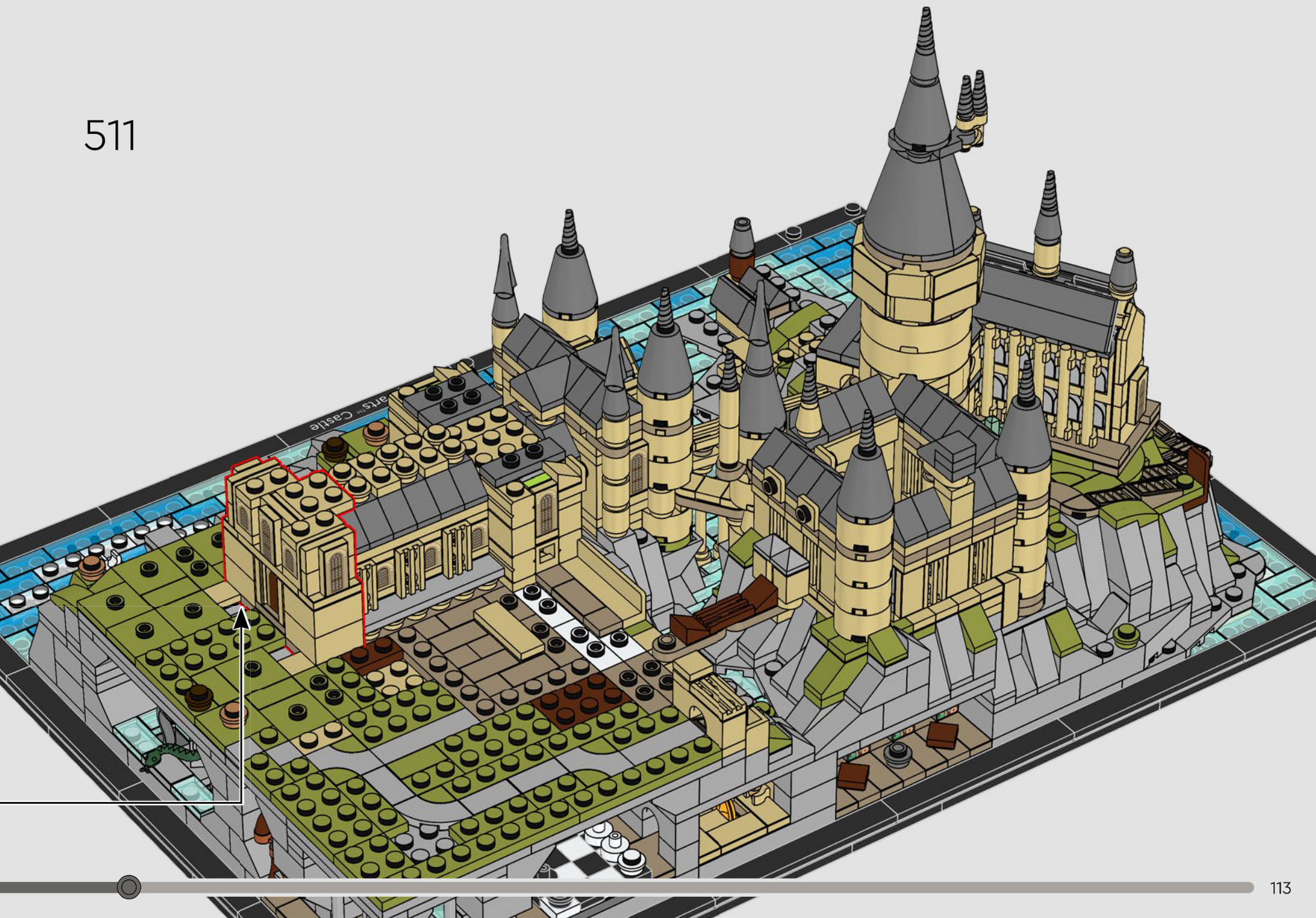



2x



2x



2x



2x



2x



2x



2x



2x



2x

512

1

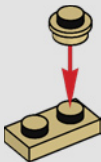

2

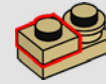

3

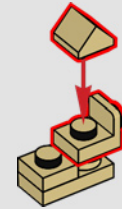

4

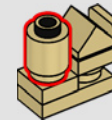

5

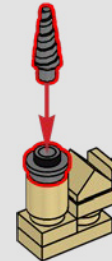

2x



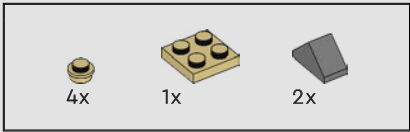

513

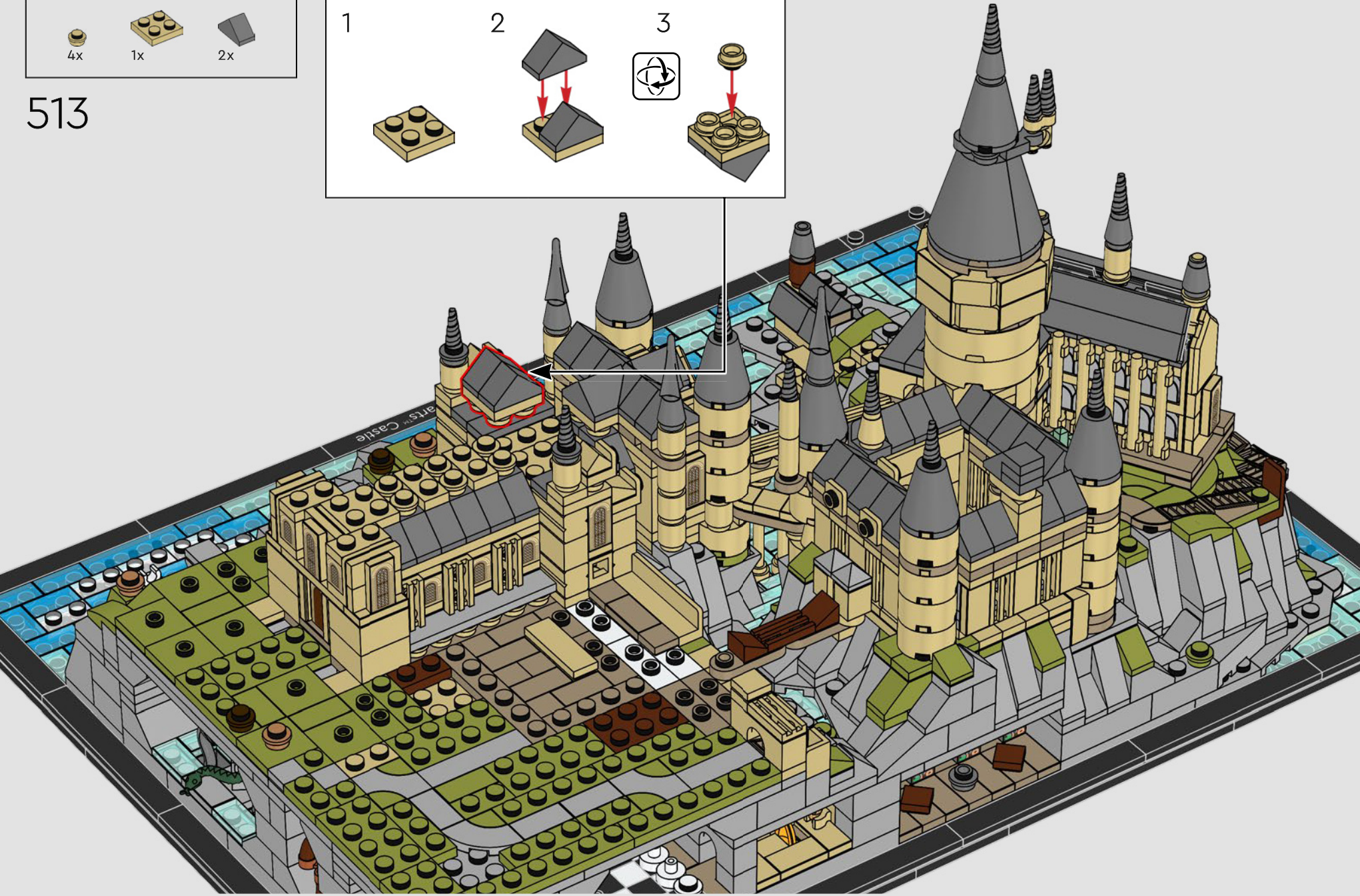
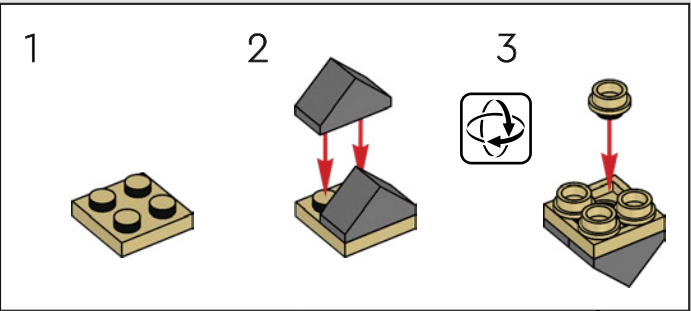

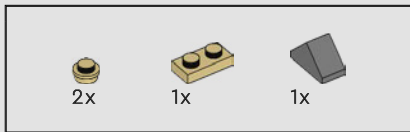

514

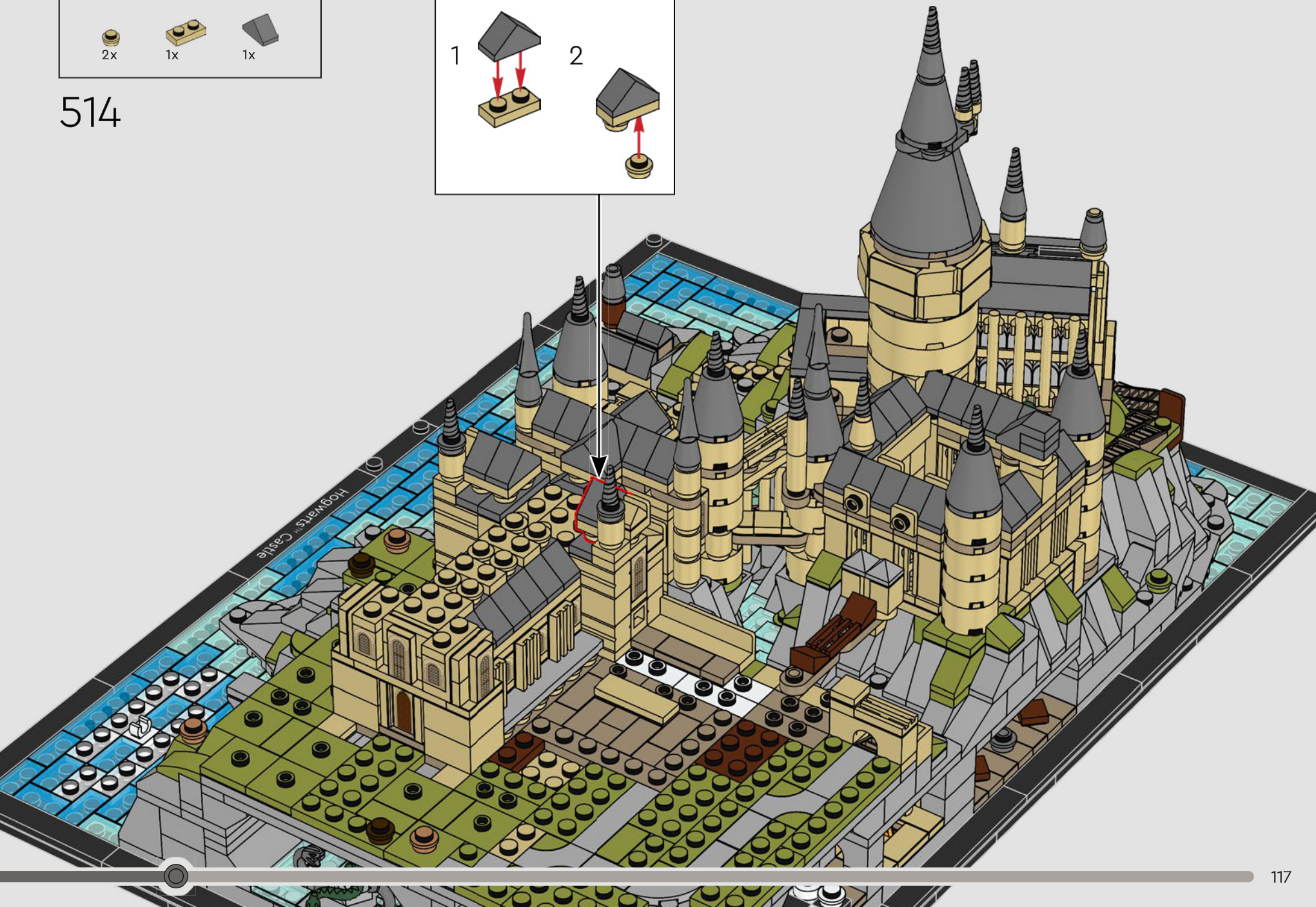
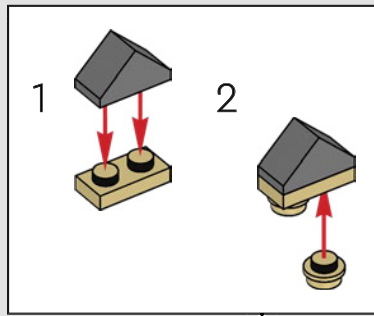

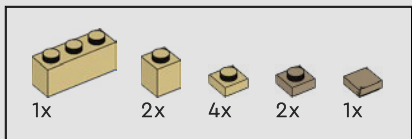

515

1

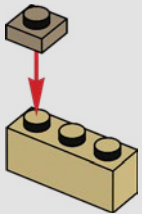

2

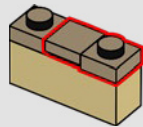

3

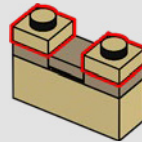

4

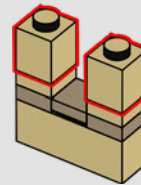

5

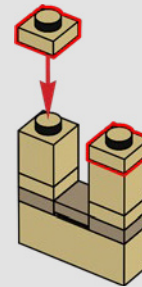

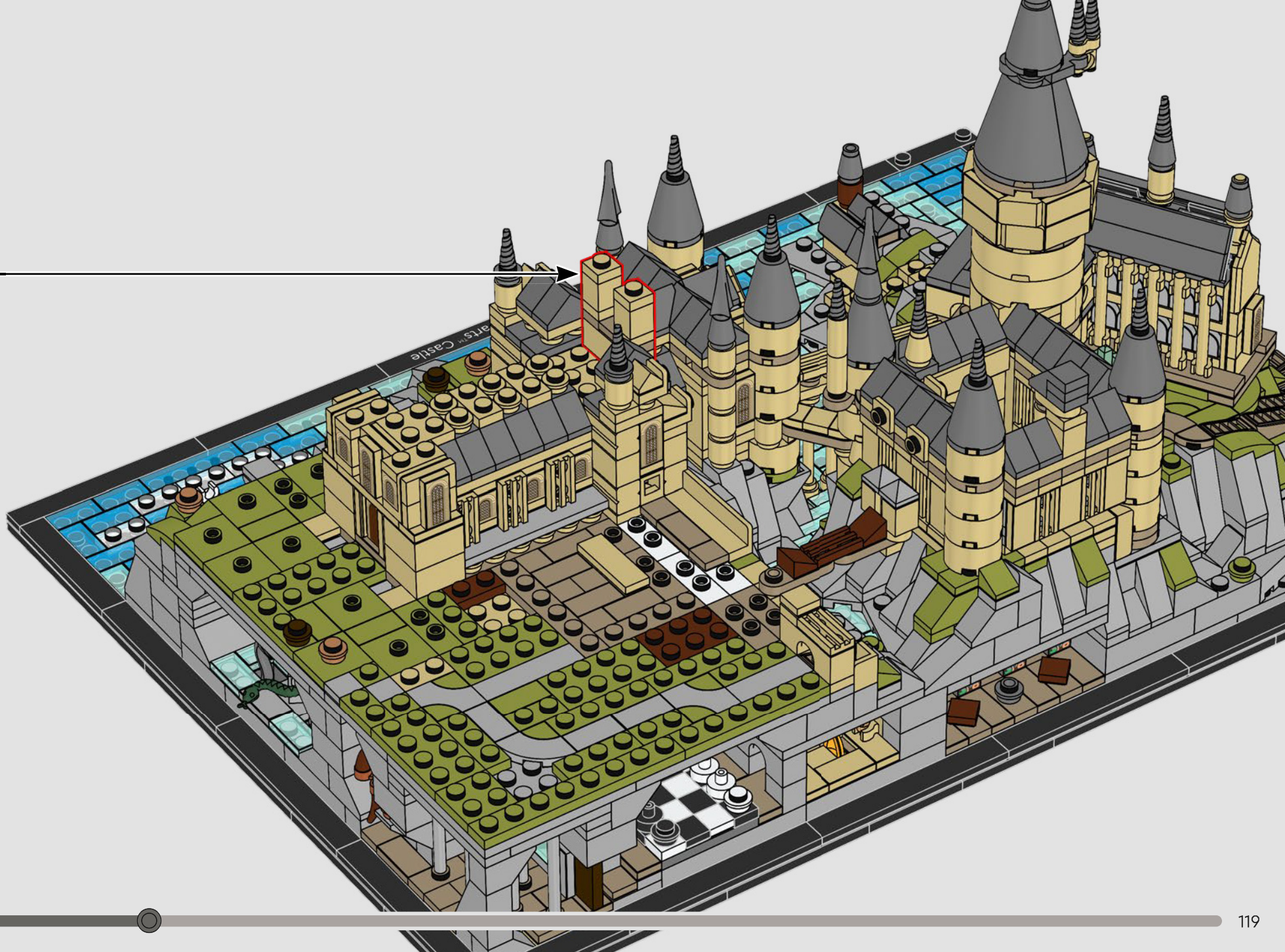

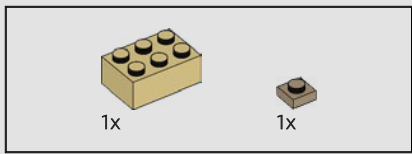

516

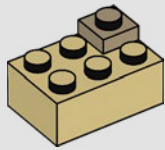

517

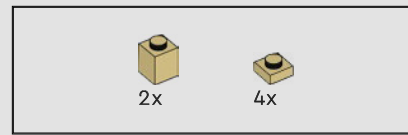
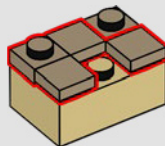

518

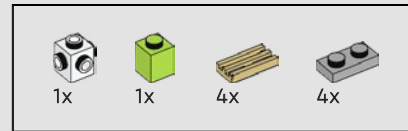
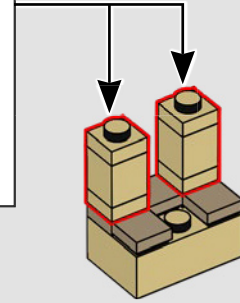
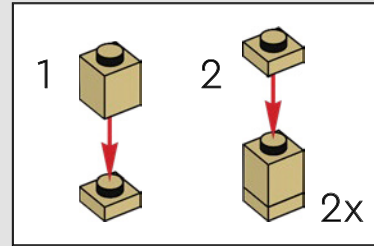

519

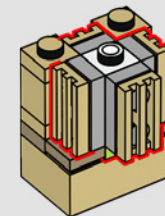
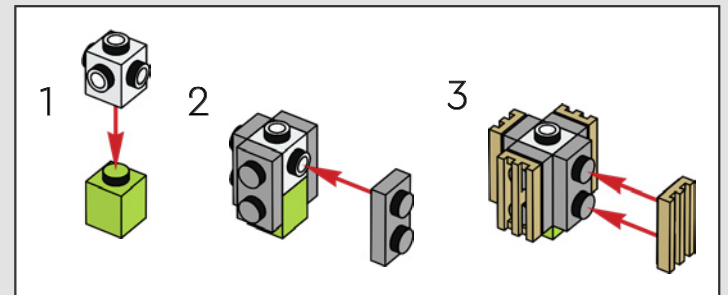



520

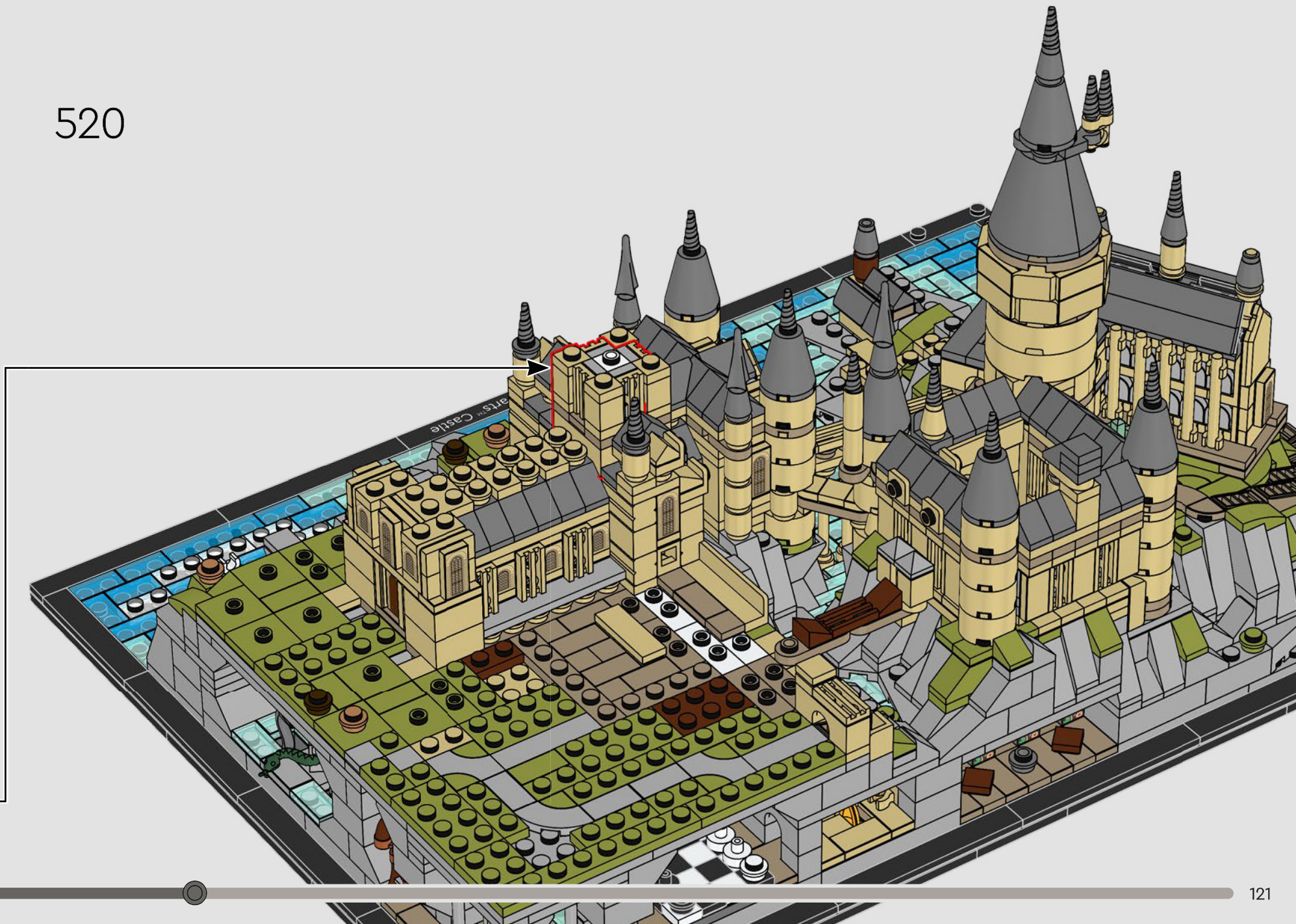

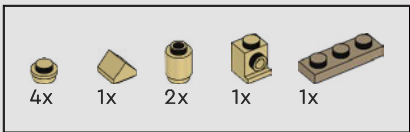

521

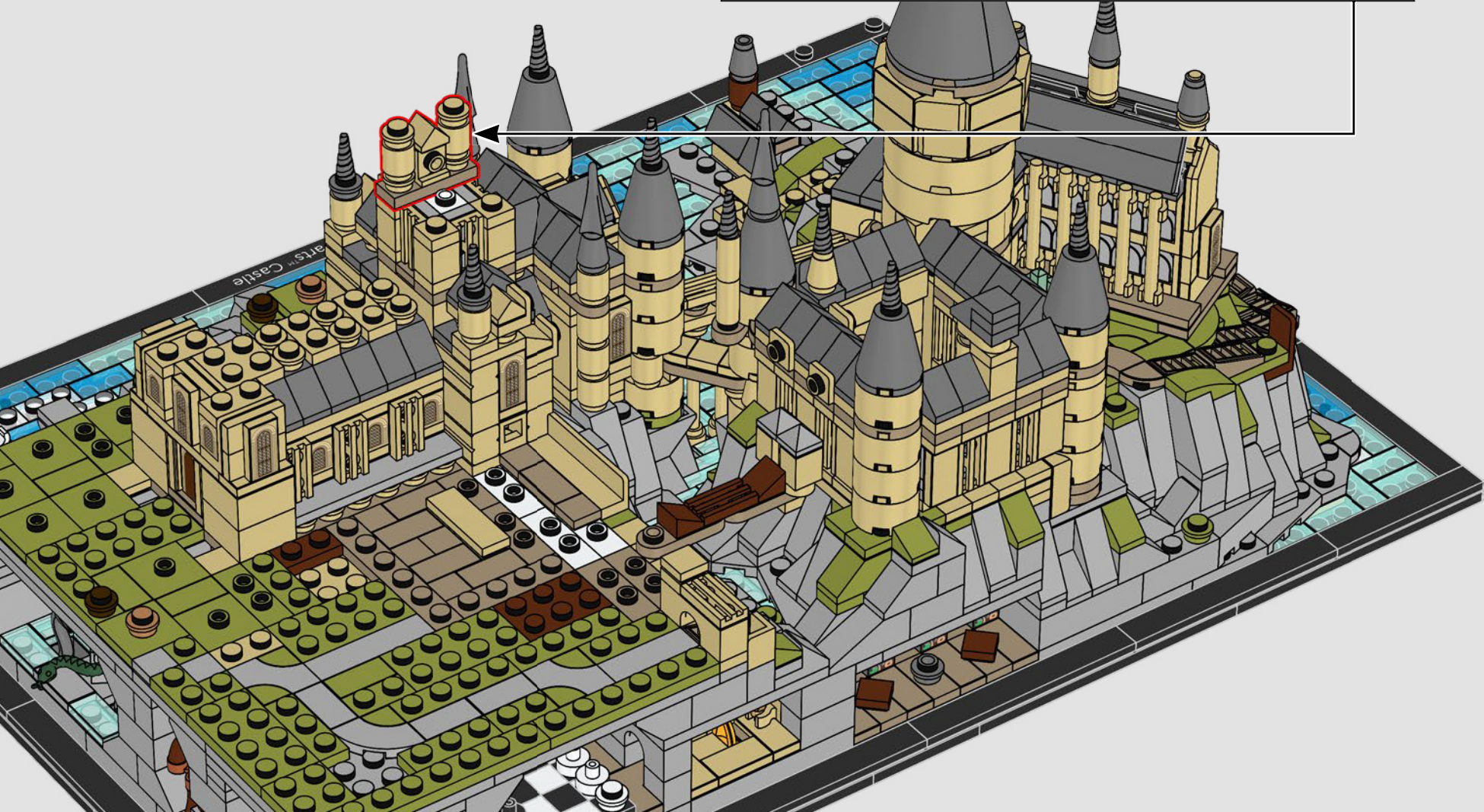
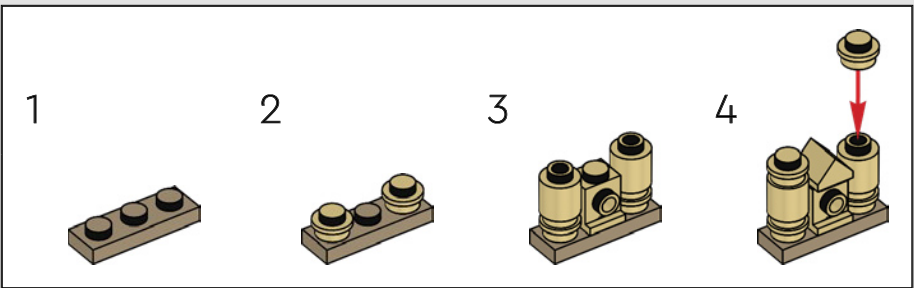

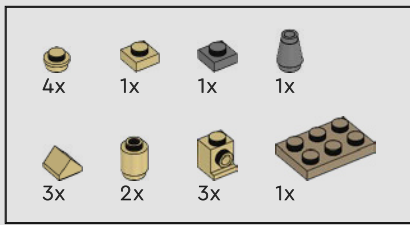

522

1

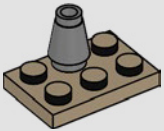

2

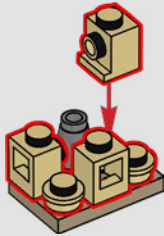

3

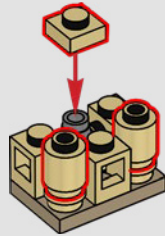

4

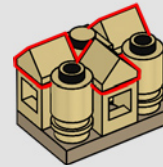

5

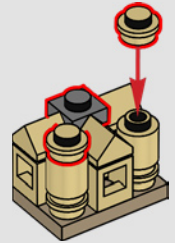

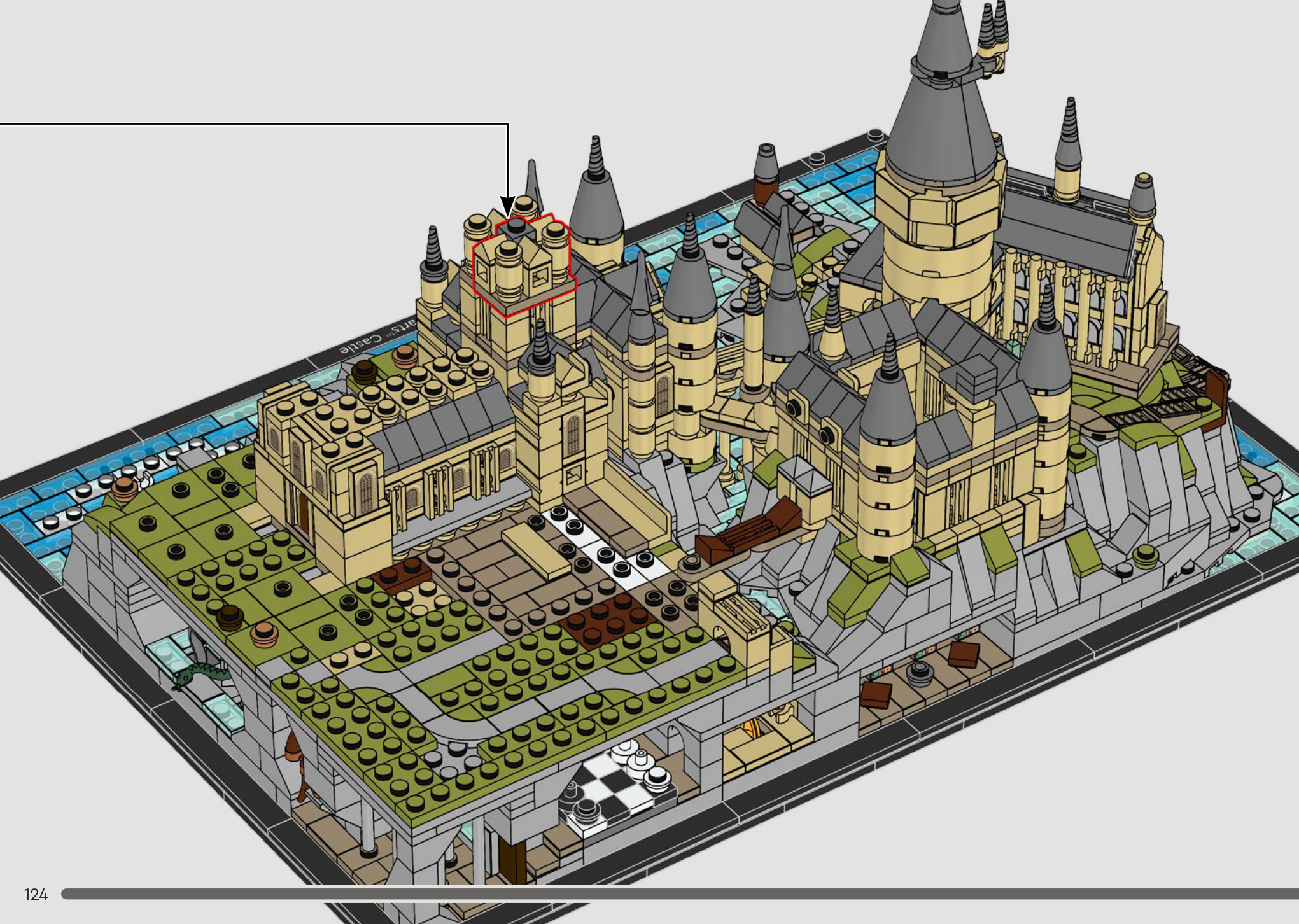

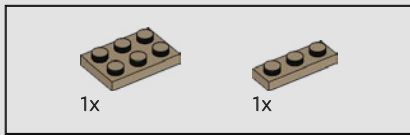

523



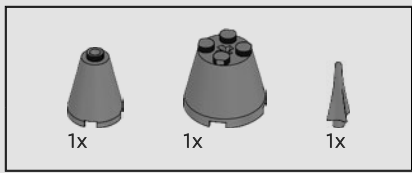

524

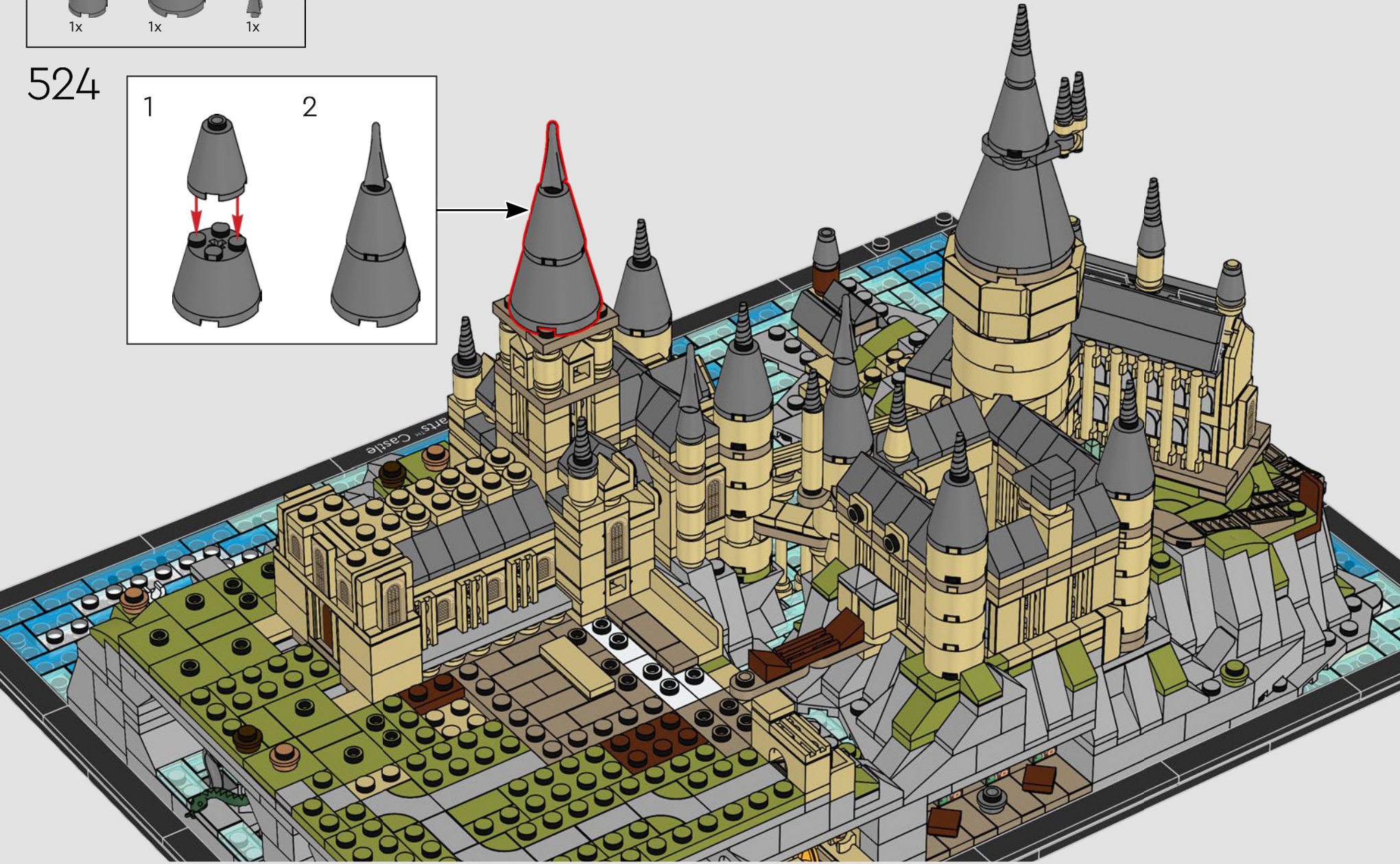
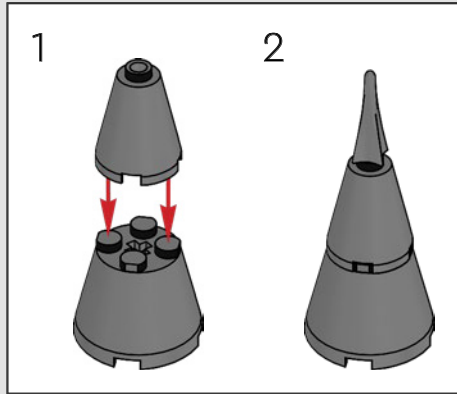

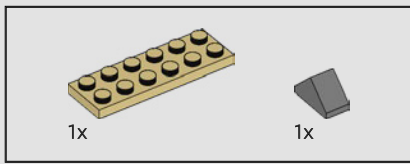

525

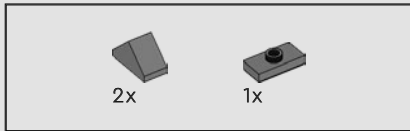
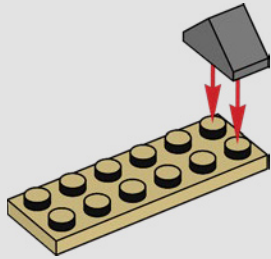

526

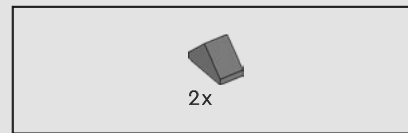
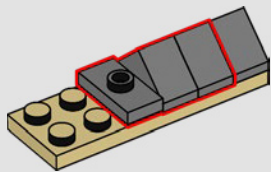

527

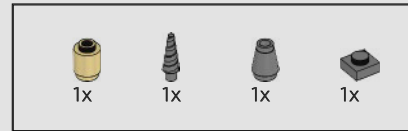
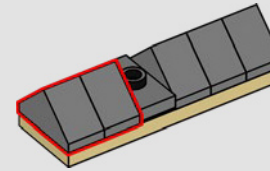

528

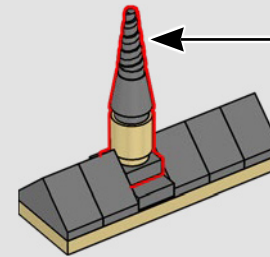
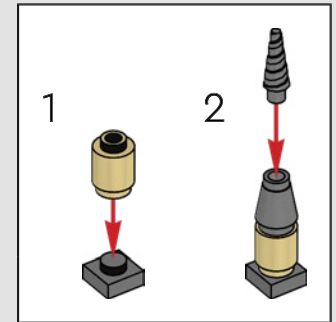

529

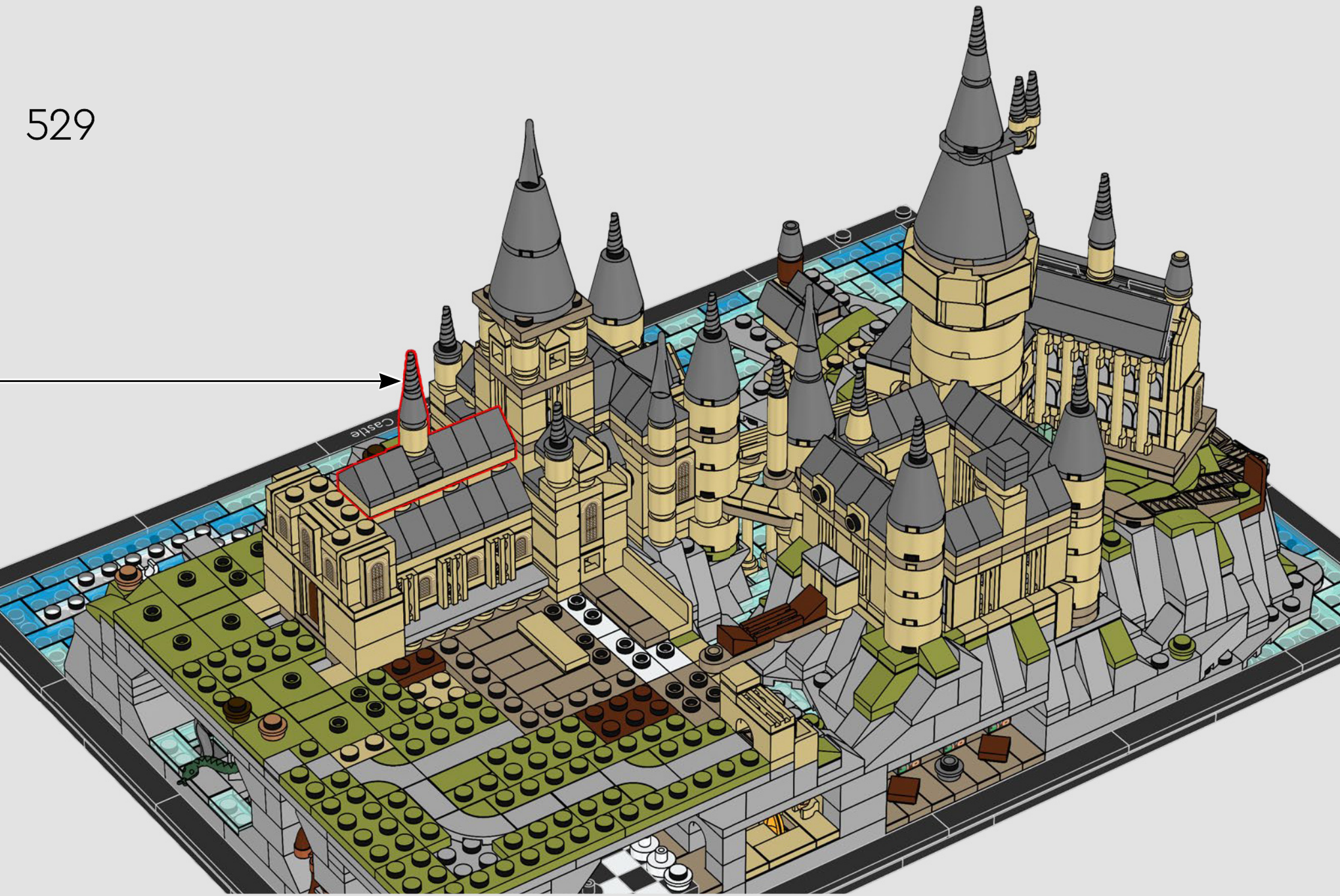



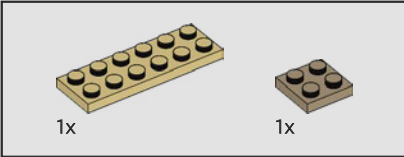
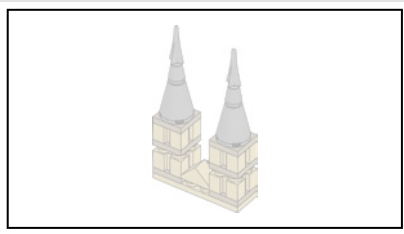

530

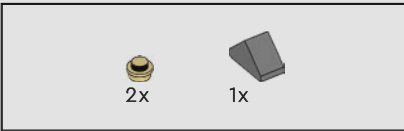
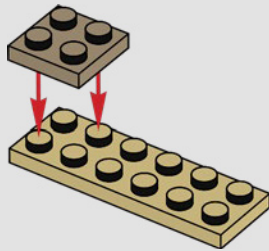

531

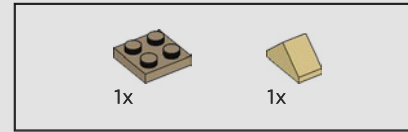
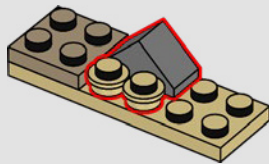

532

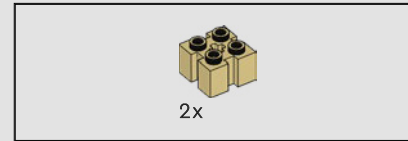
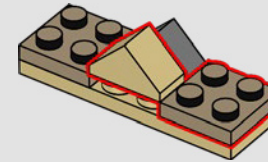

533

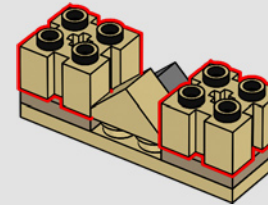



8x

534

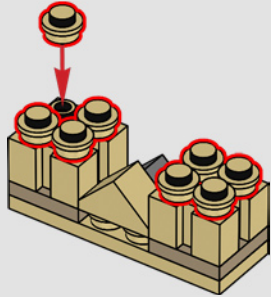

2x

535

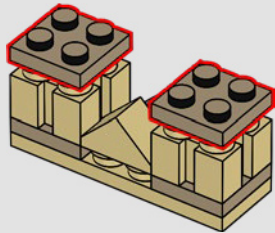

2x

536

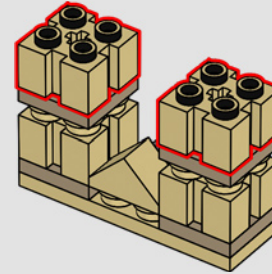

2x

537

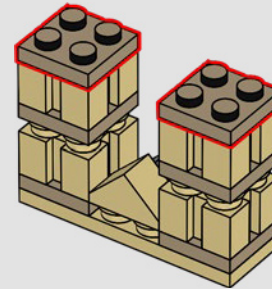

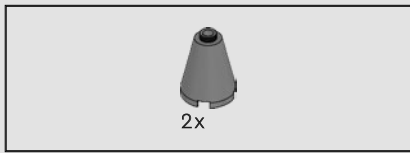

538

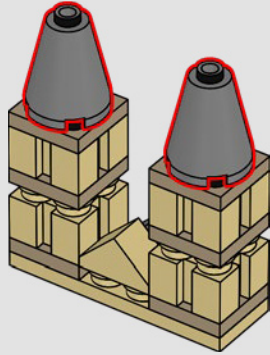

539

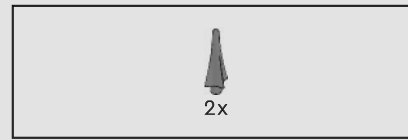
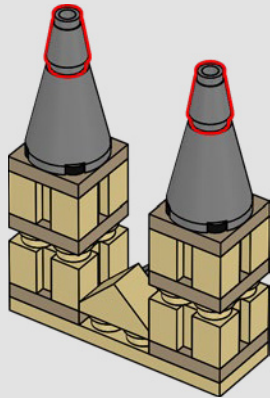

540

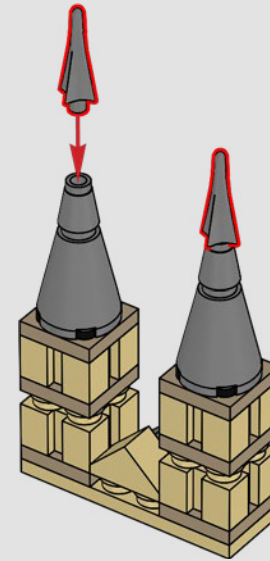



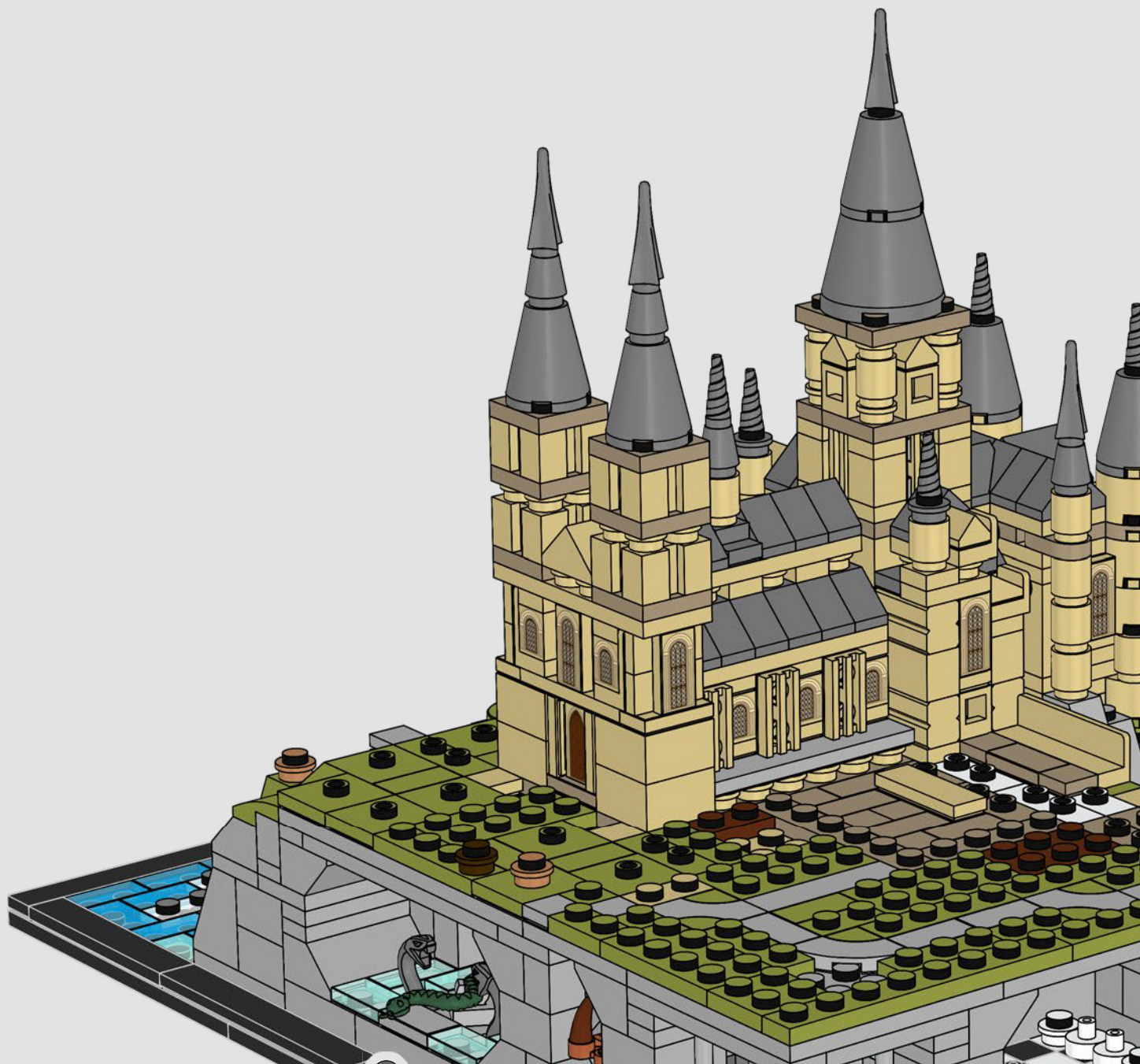

Unabhängig von ihren Lieblingsfächern werden Hogwarts™ Schülerinnen und Schüler sehr viel Zeit im Ostflügel verbringen, der viele Klassenzimmer beherbergt.



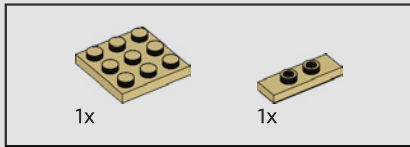
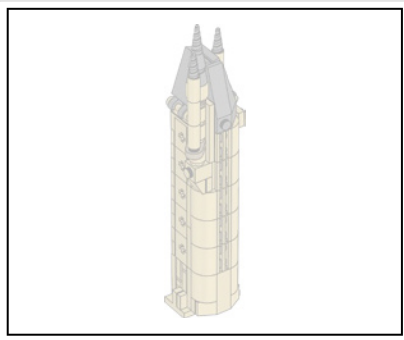

542

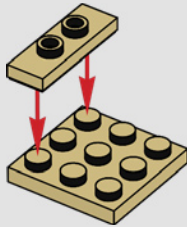

543

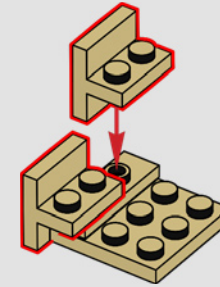

544

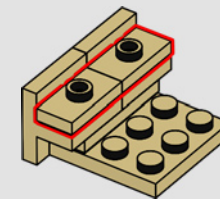



2x

545

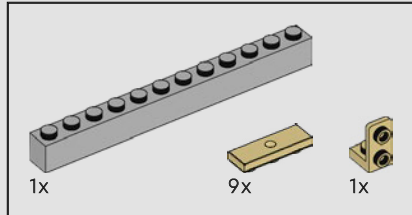
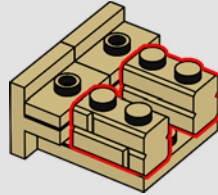

546

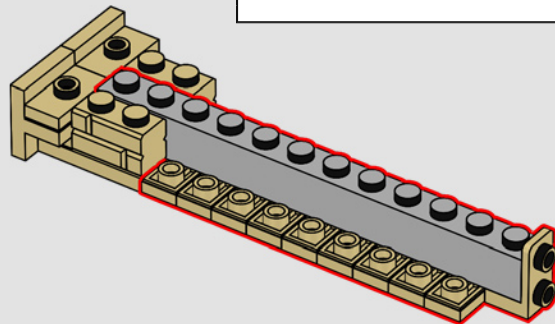
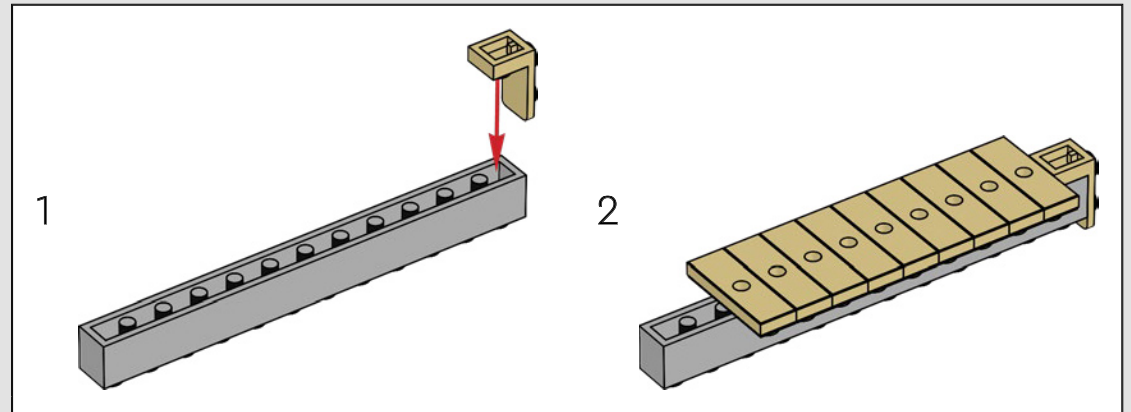



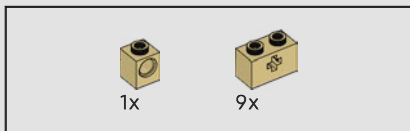

547

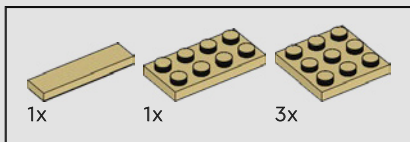
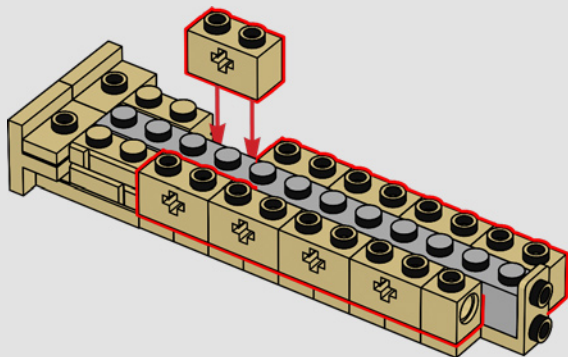

548

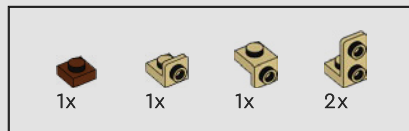
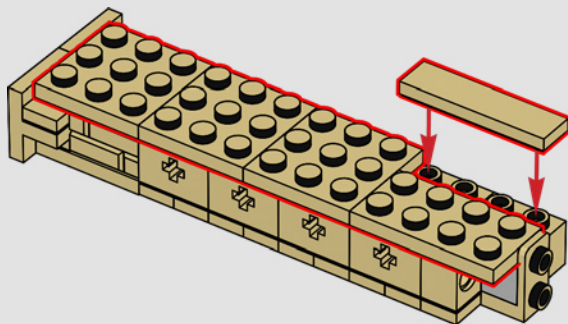

549

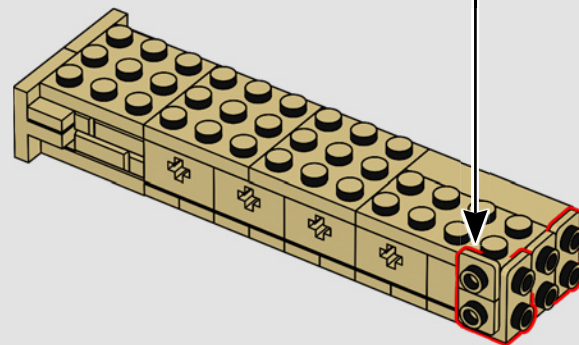
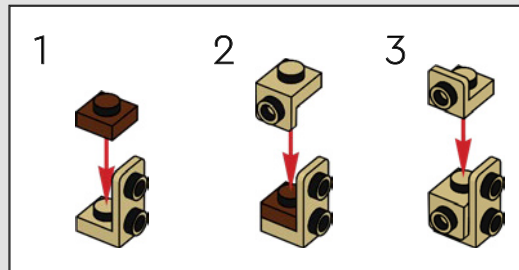

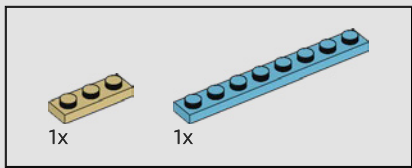

550

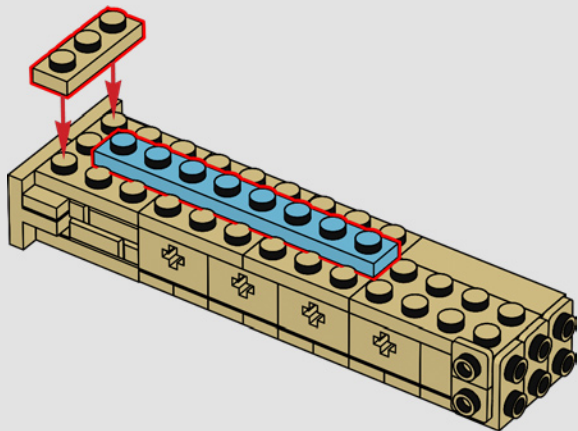

551

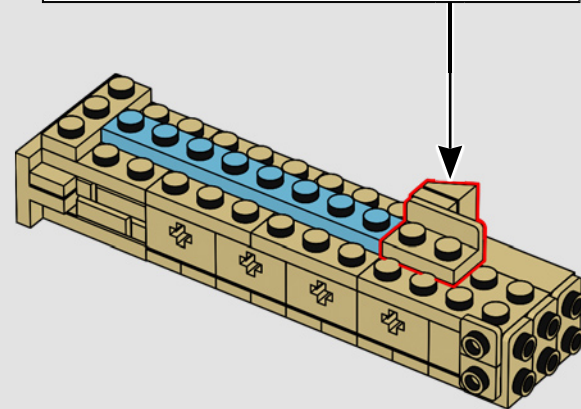
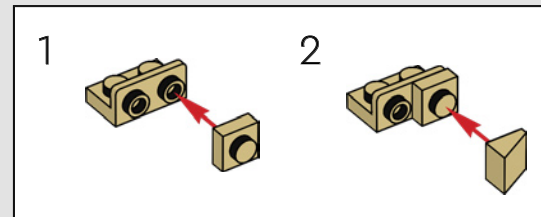

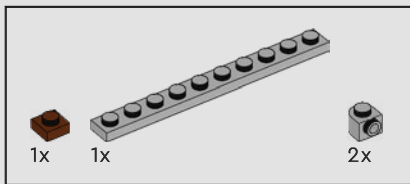

552

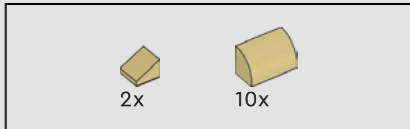
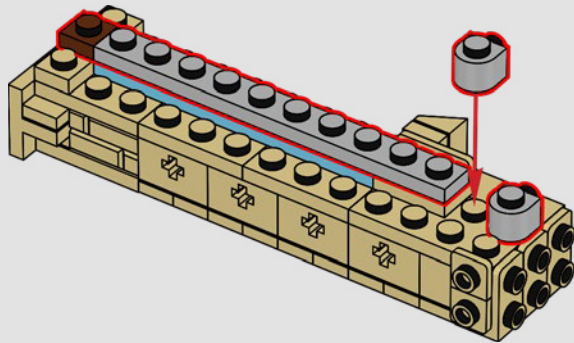

553

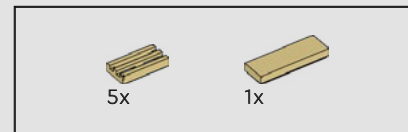
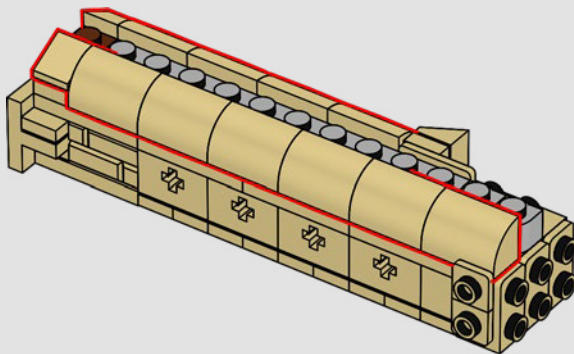

554

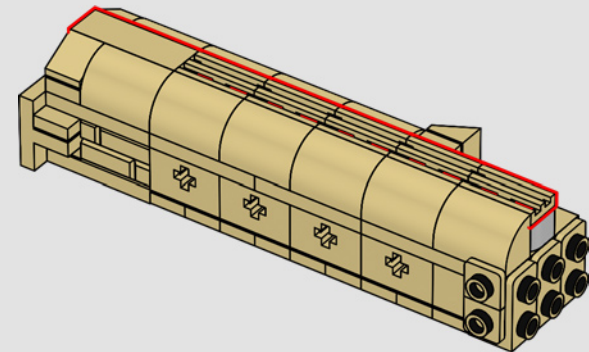



555

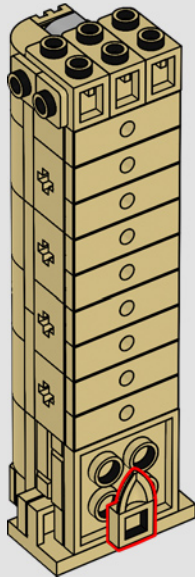

556

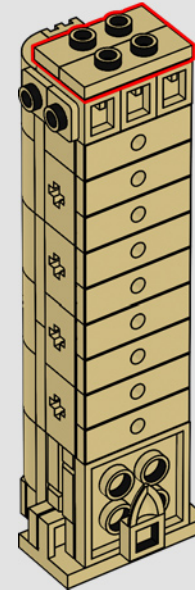

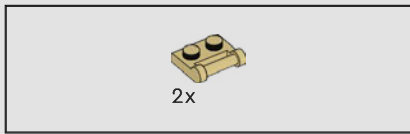

557

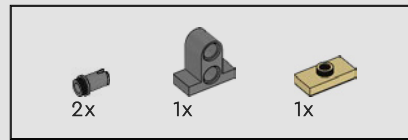
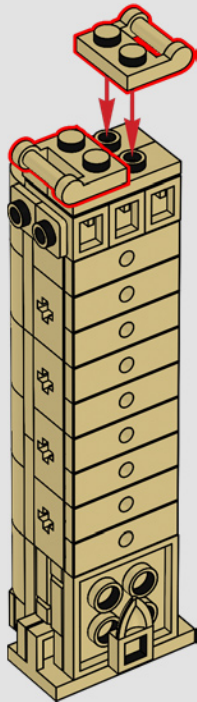

558

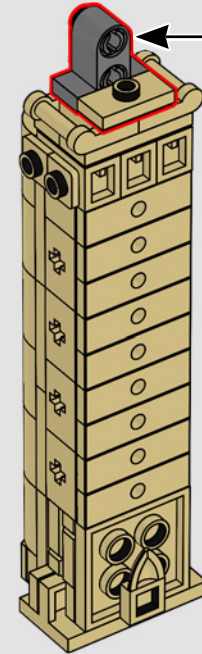
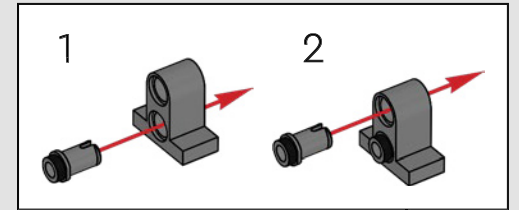



559

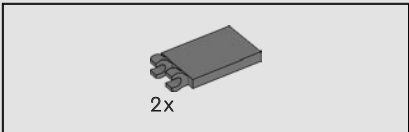

560

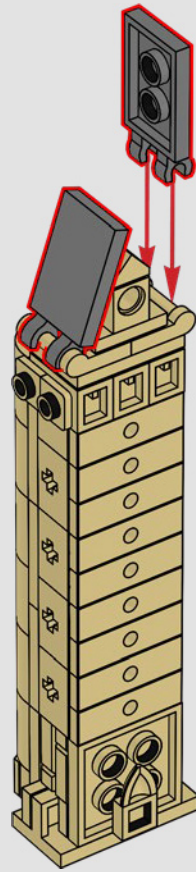



561

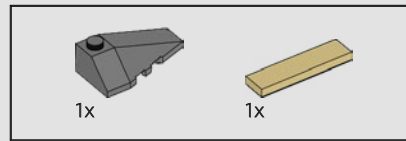
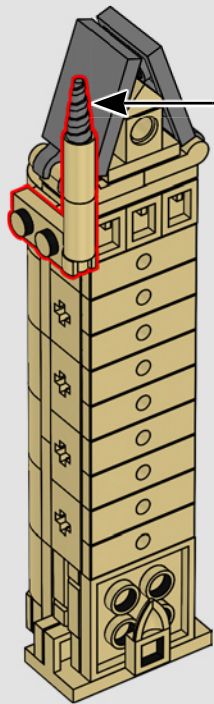
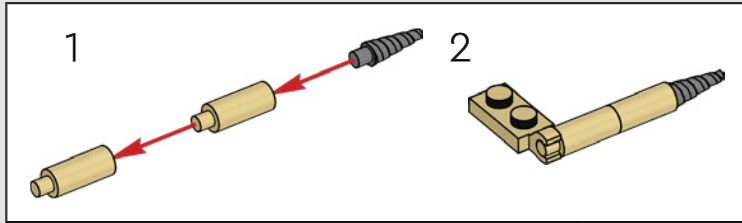

562

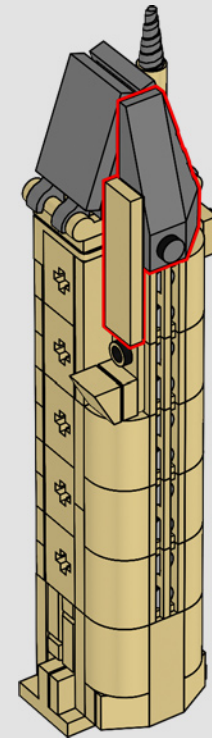
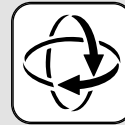

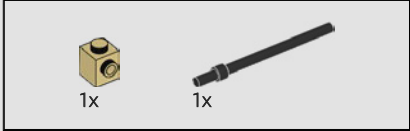
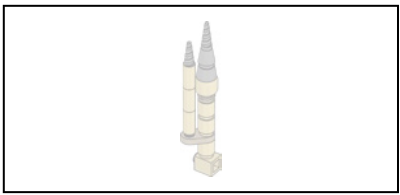

563

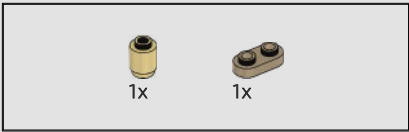

564



565







566

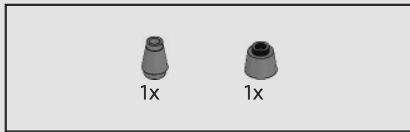

567

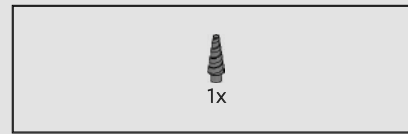
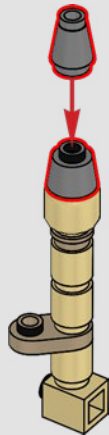

568

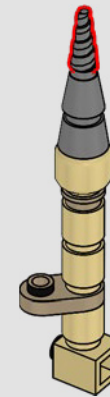

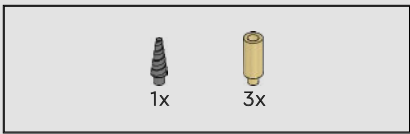

569

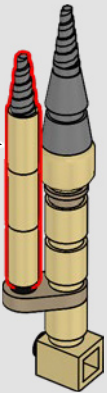
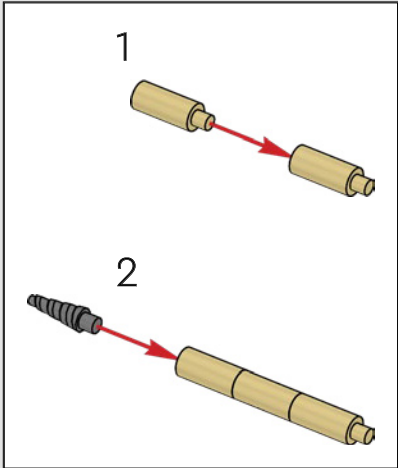

570

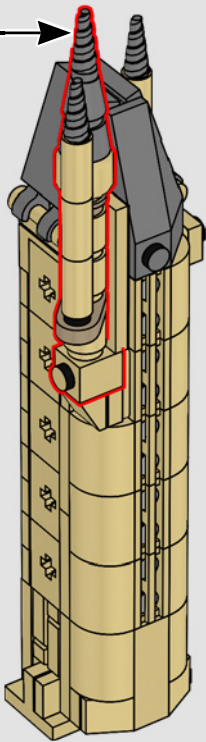

571

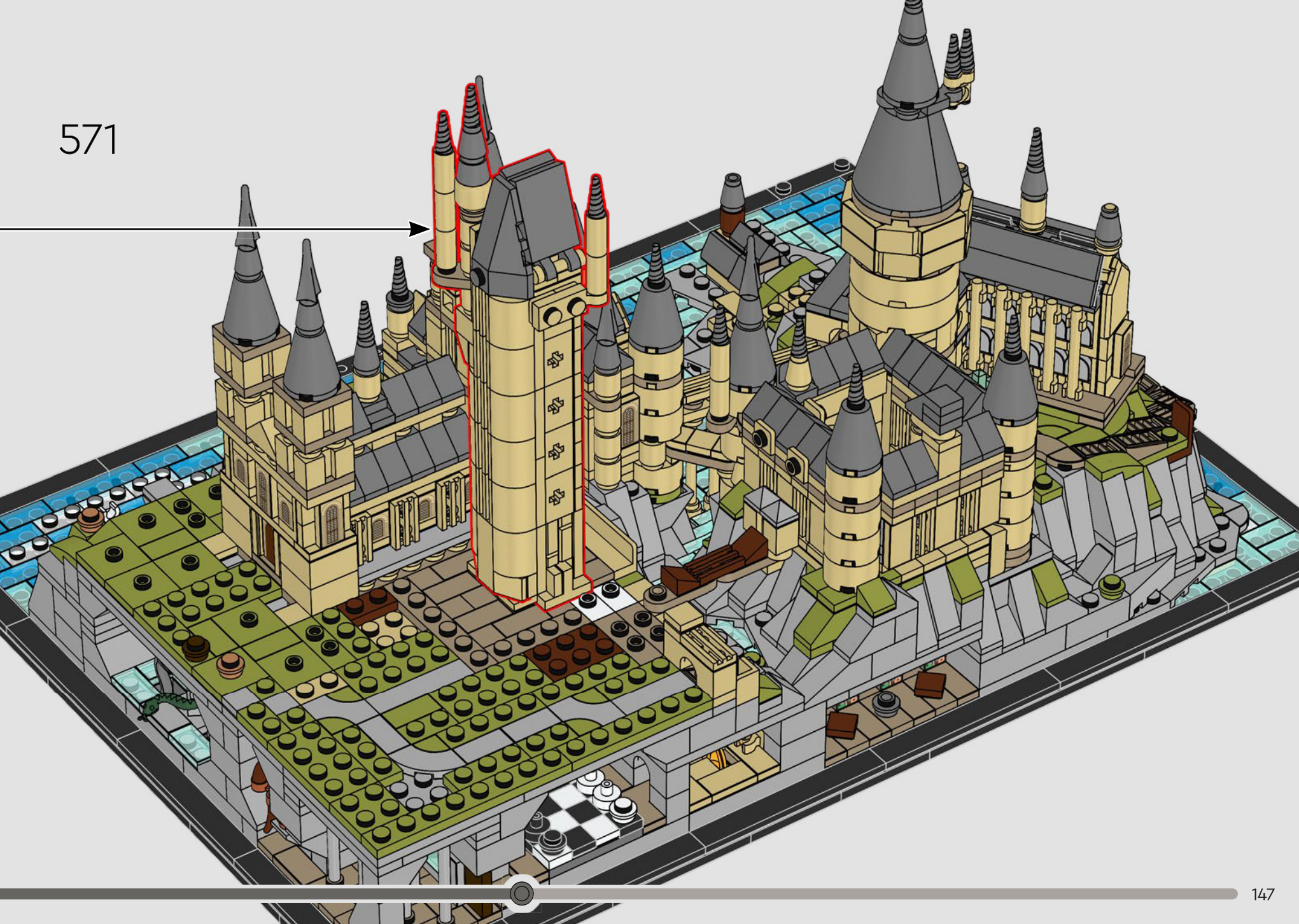

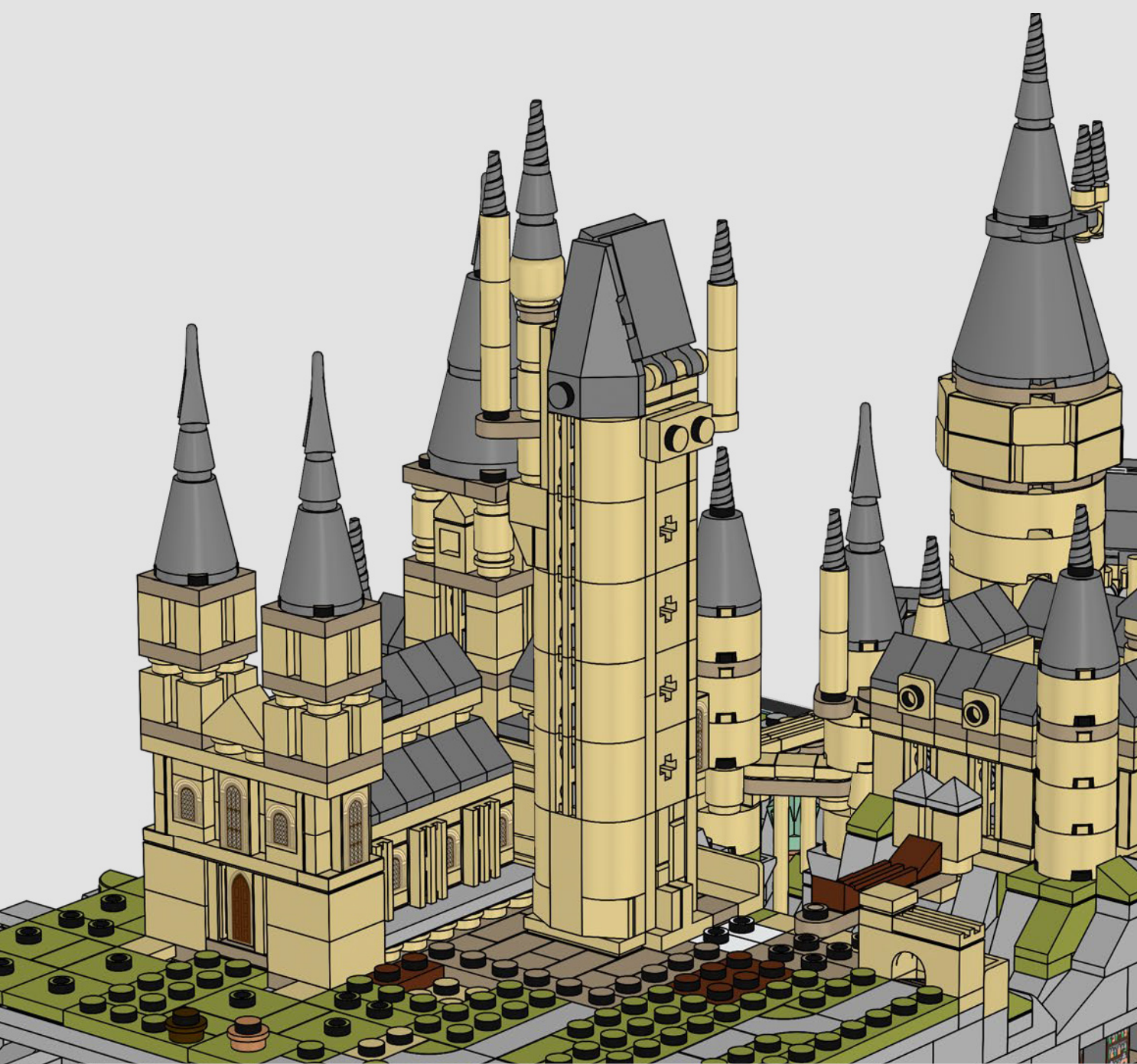

Man könnte vielleicht meinen, dass der Hauptturm der höchste Punkt in Schloss Hogwarts™ sein müsste. Tatsächlich ist dies jedoch der Astronomieturm.





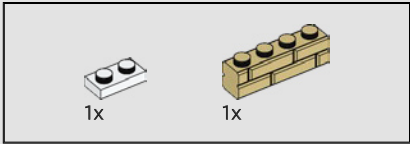
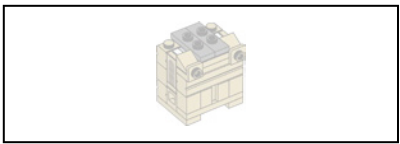

572

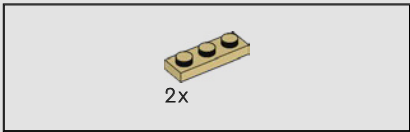
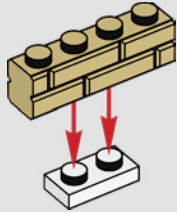

573

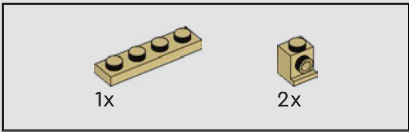
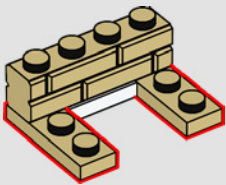

574

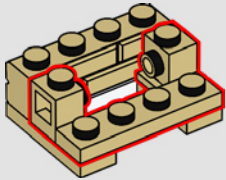

575

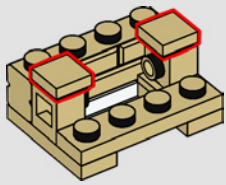

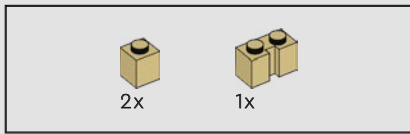

576

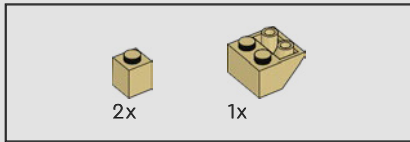
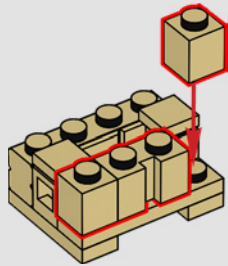

577

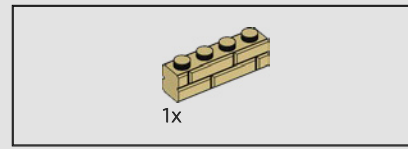
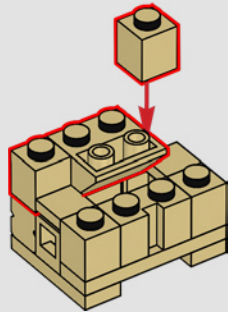

578

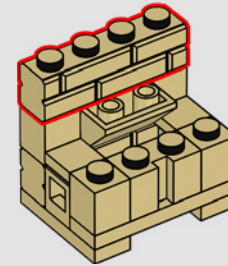

579

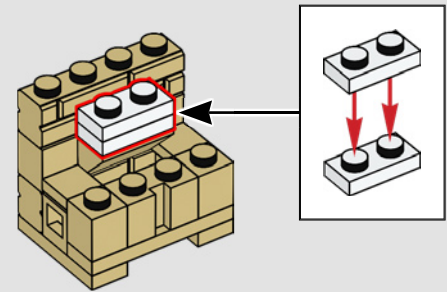

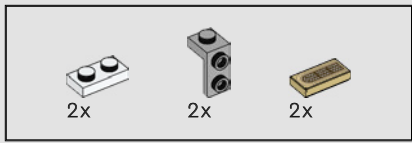

580

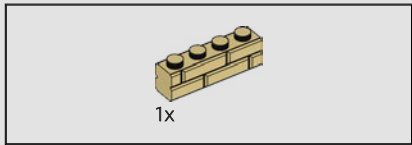
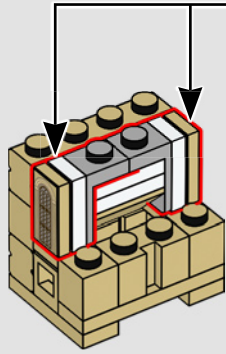
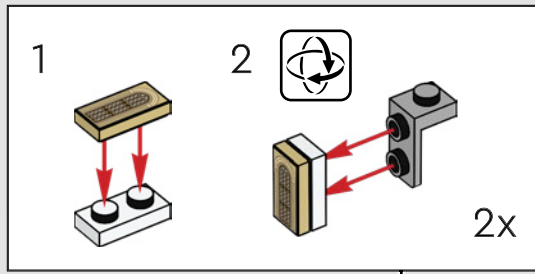

581

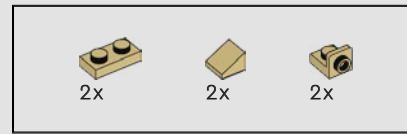
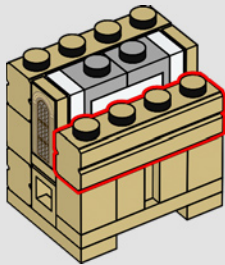

582

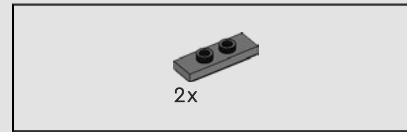
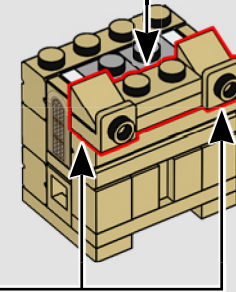
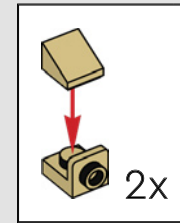
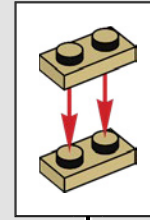

583

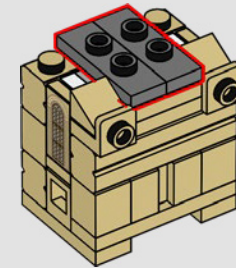



584

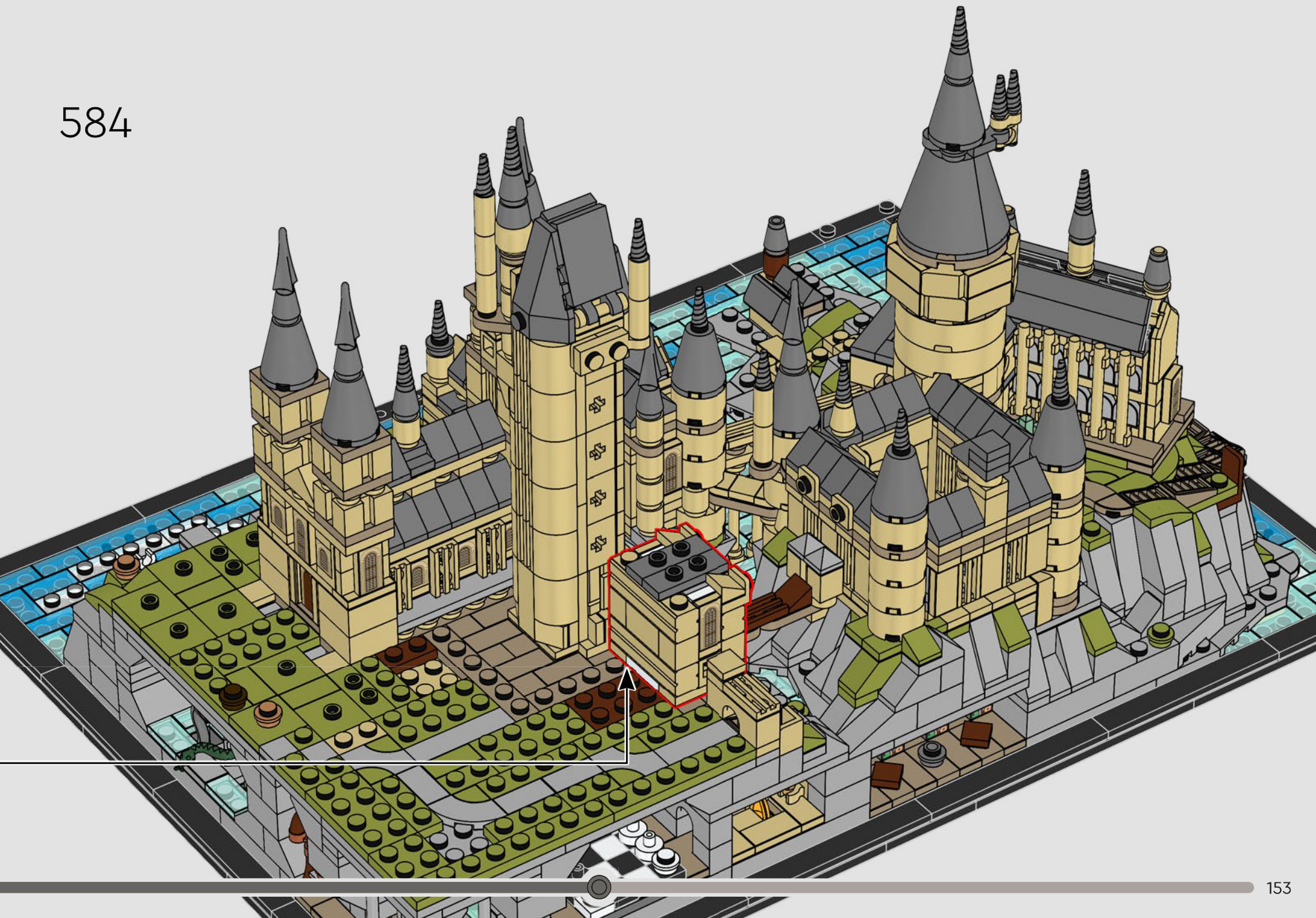

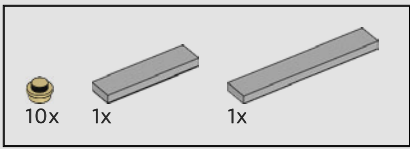

585

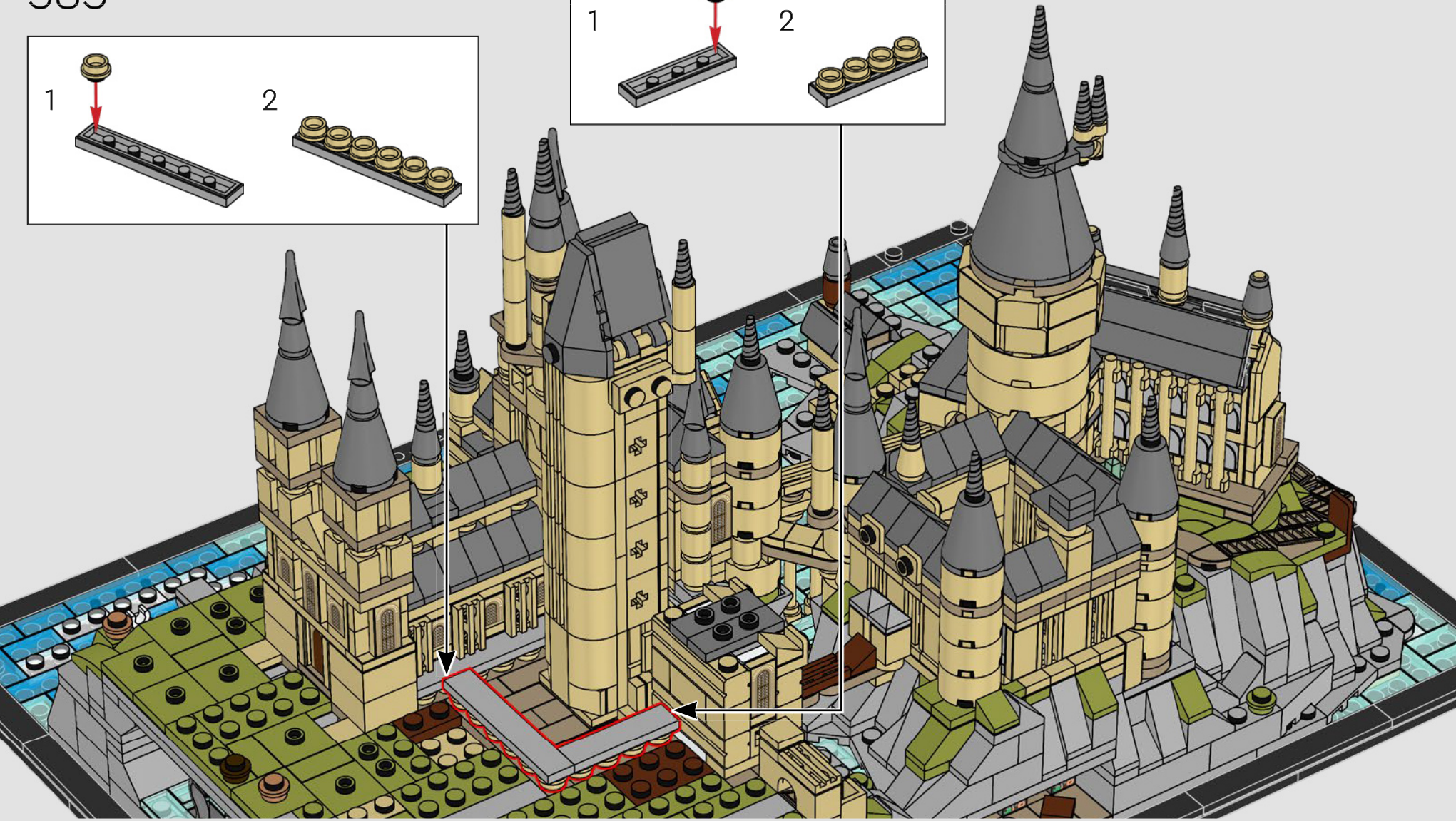
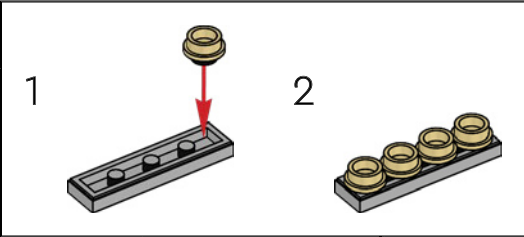
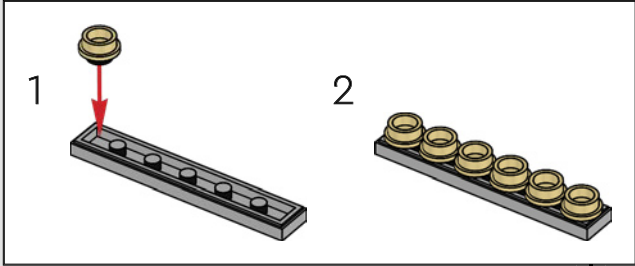

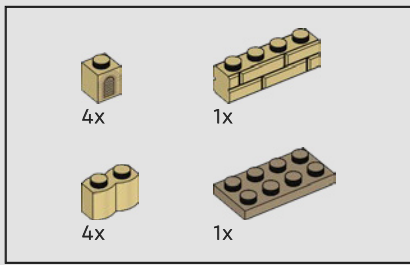

586

1

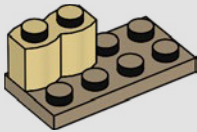

2

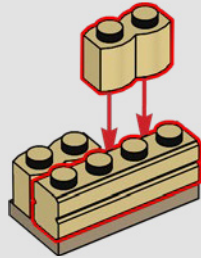

3

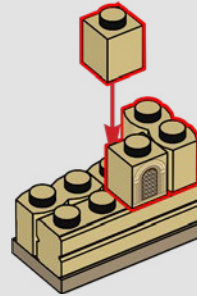

4

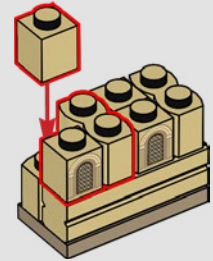





587



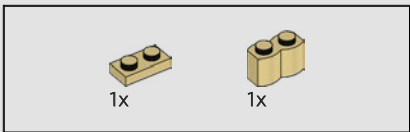

588

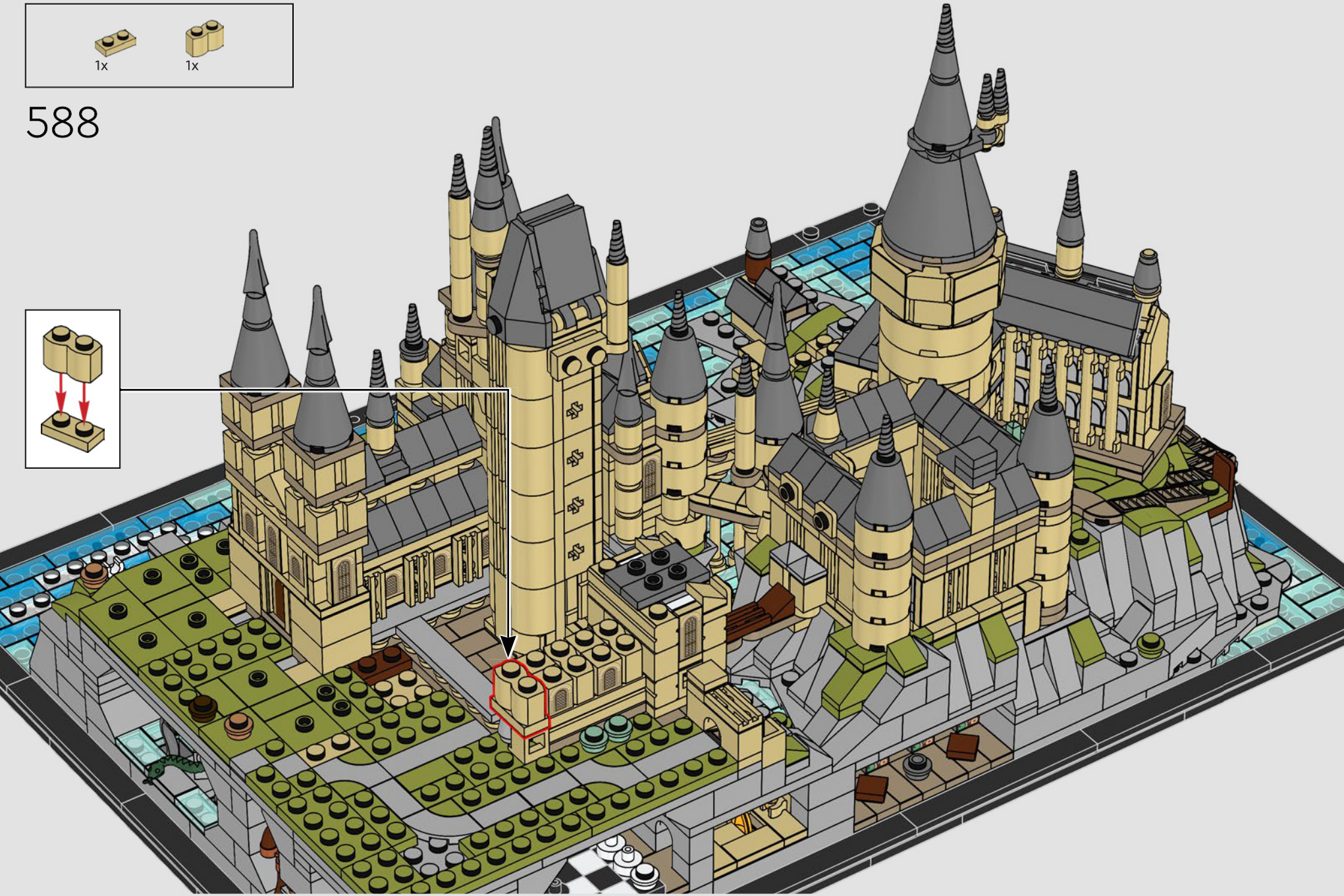
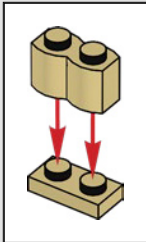

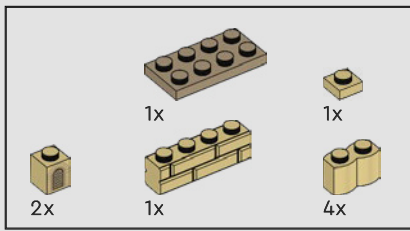

589

1

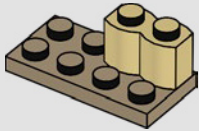

2

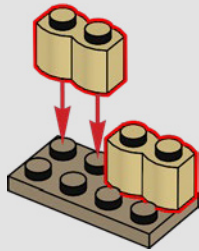

3

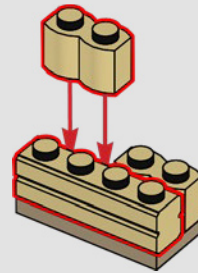

4

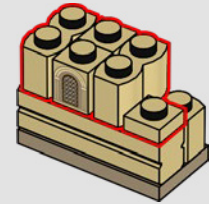

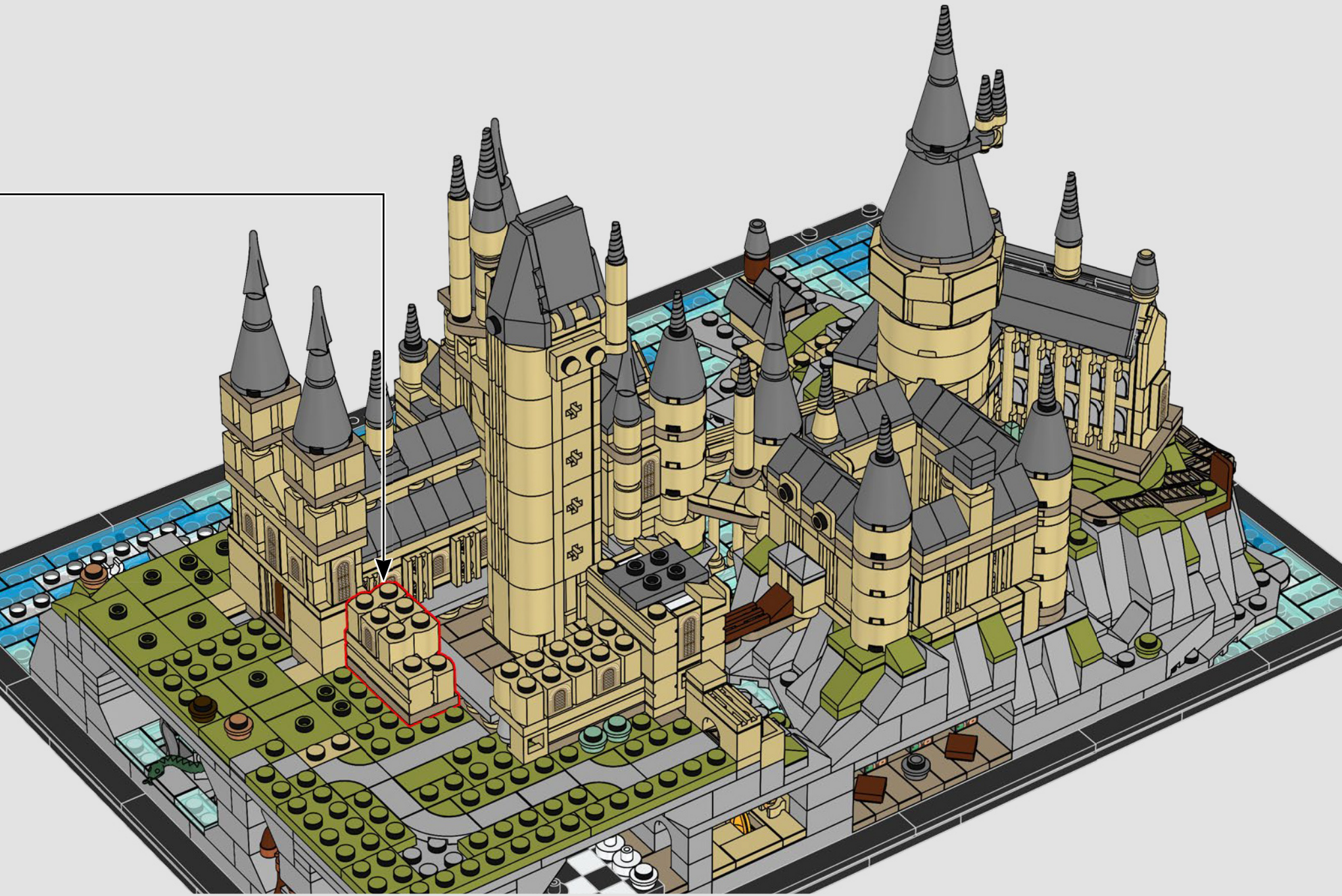



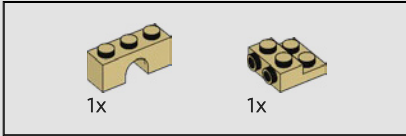
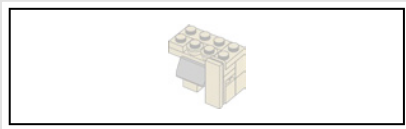

590

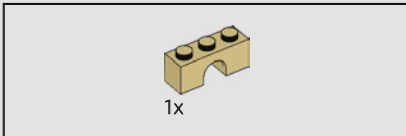
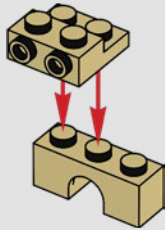

591

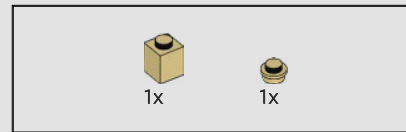
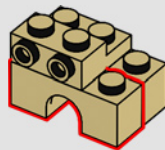

592

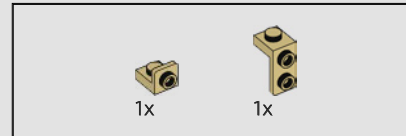
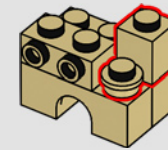

593

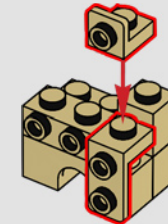

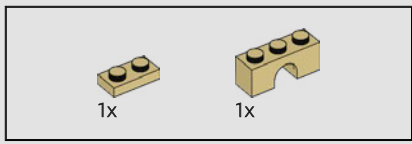

594

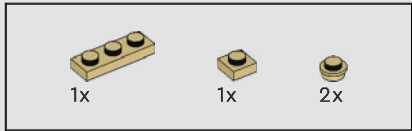
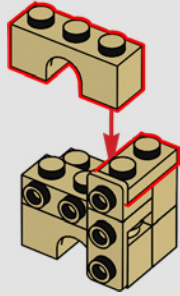

595

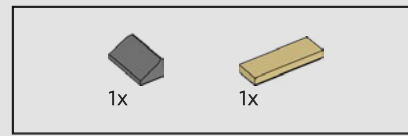
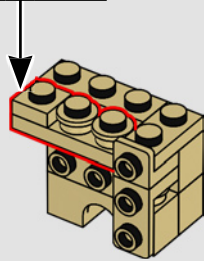
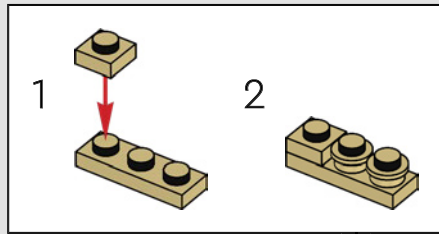

596

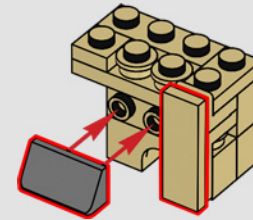

597



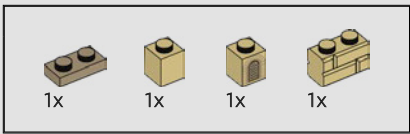

598

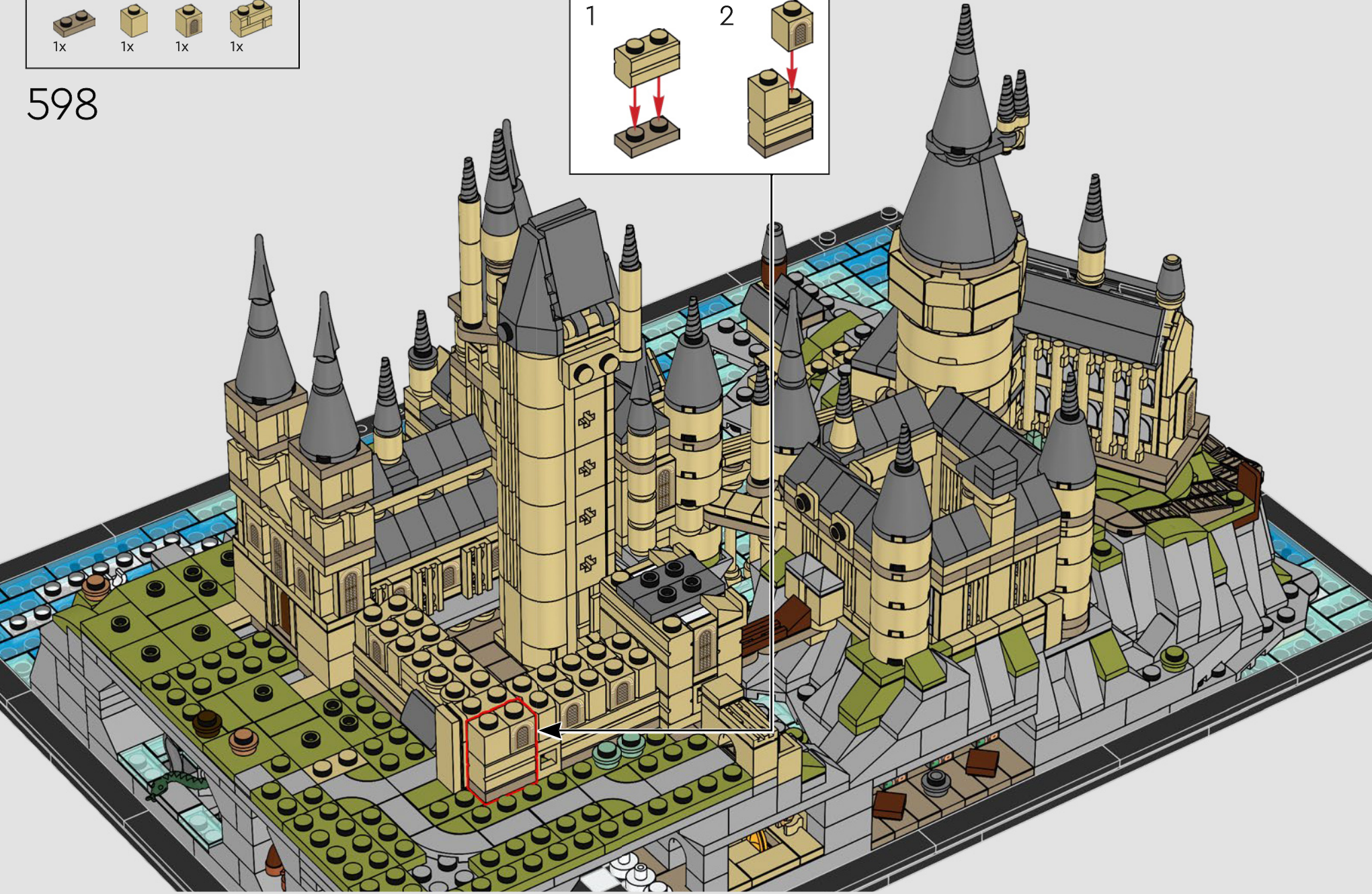
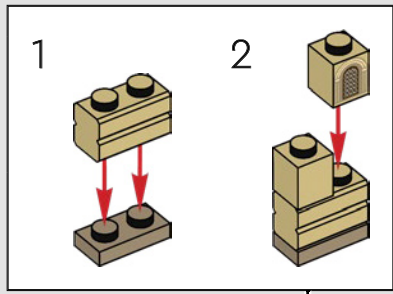

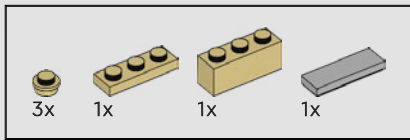

599

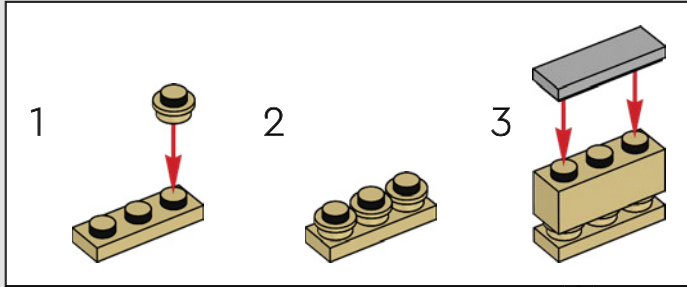

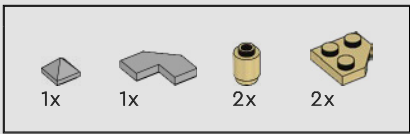

600

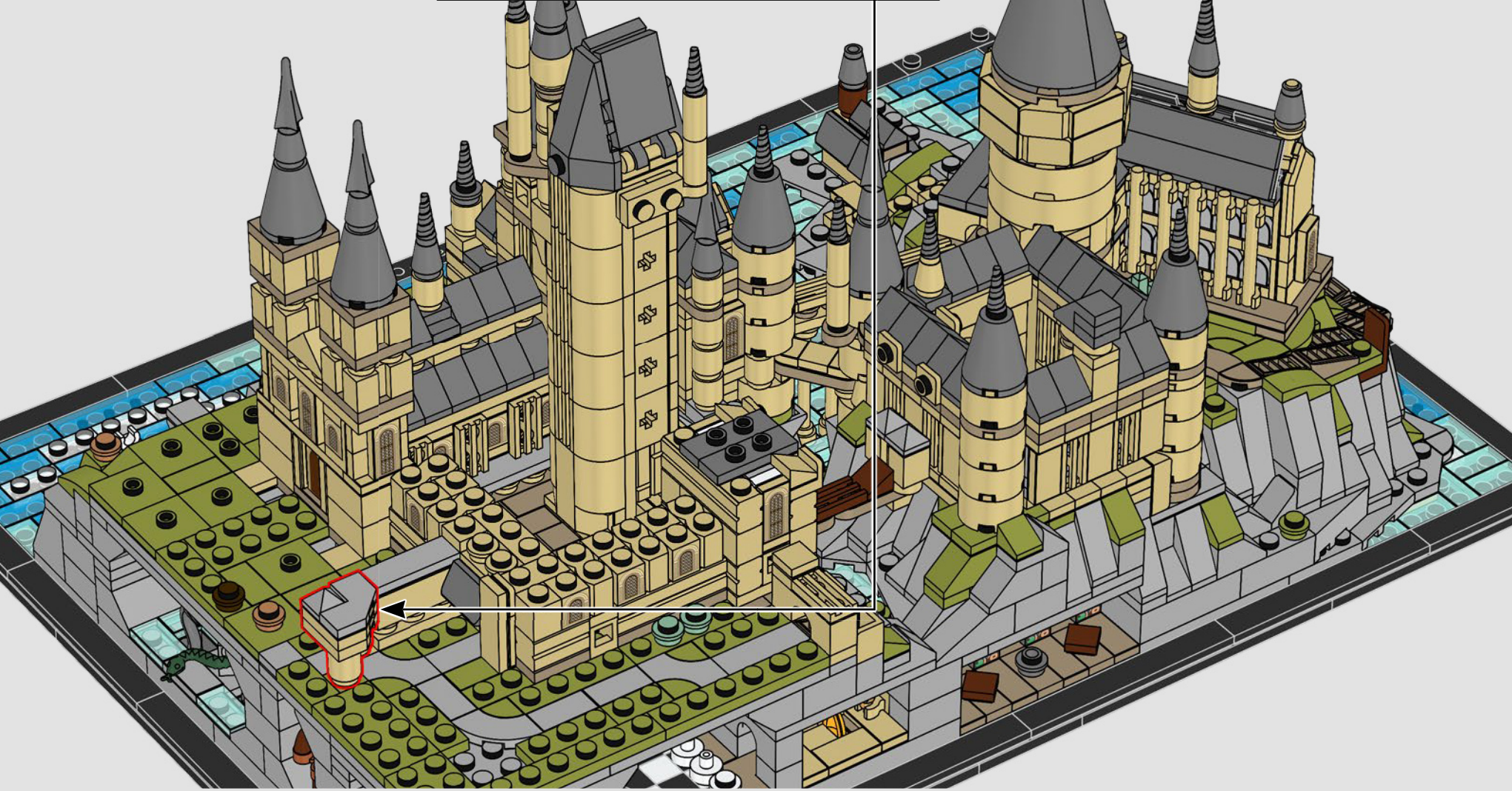
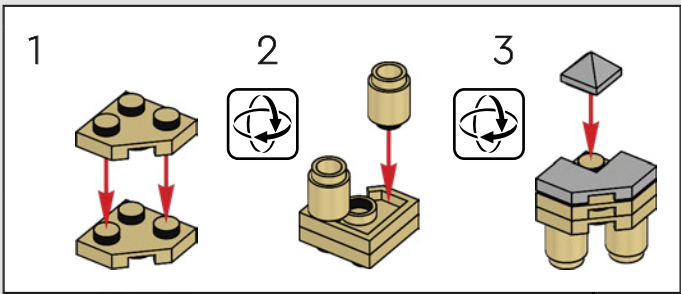

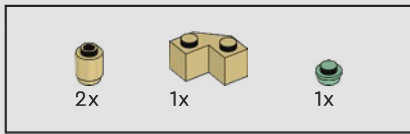

601

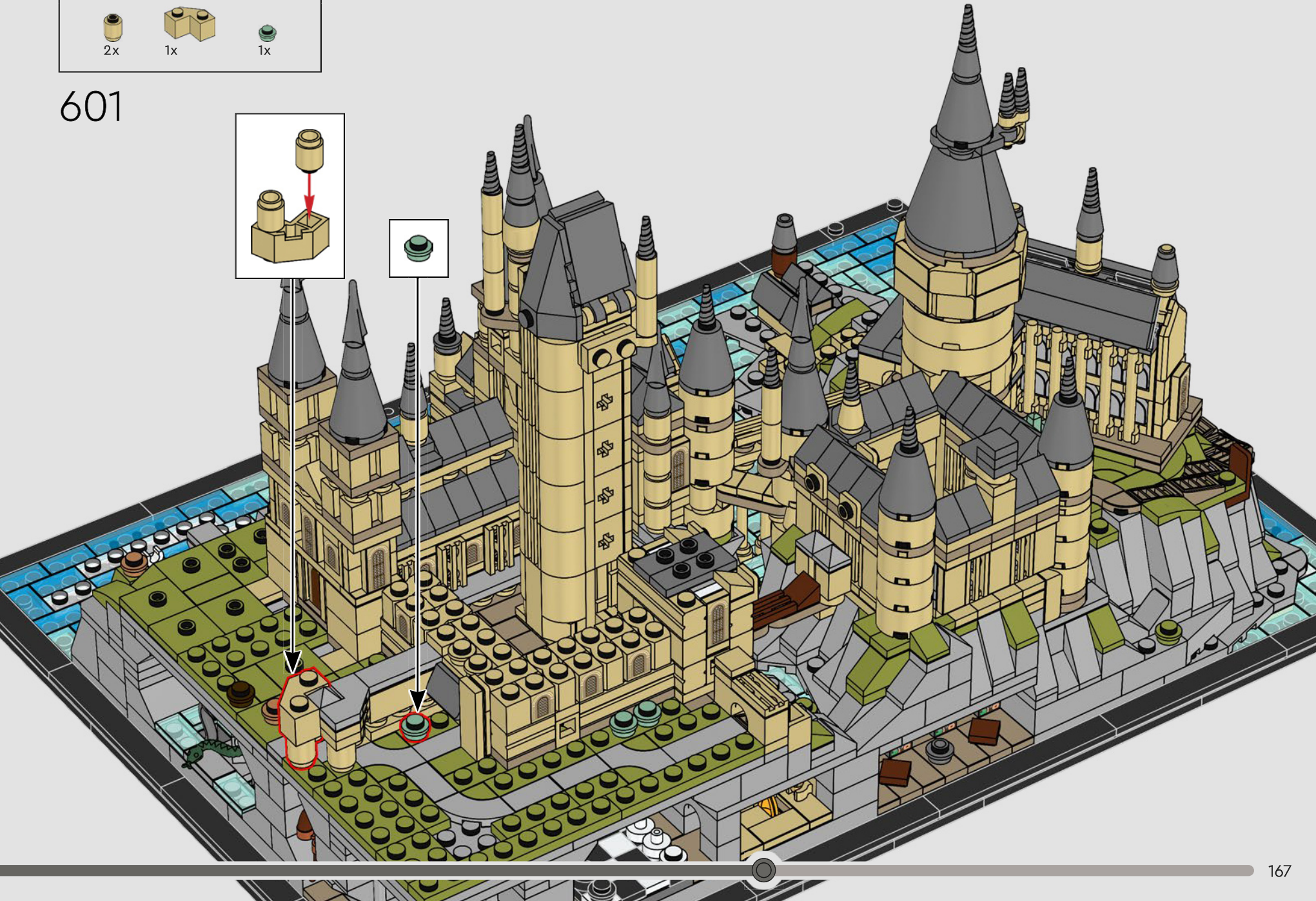
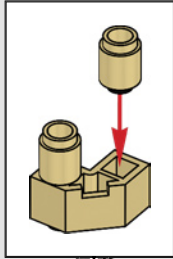





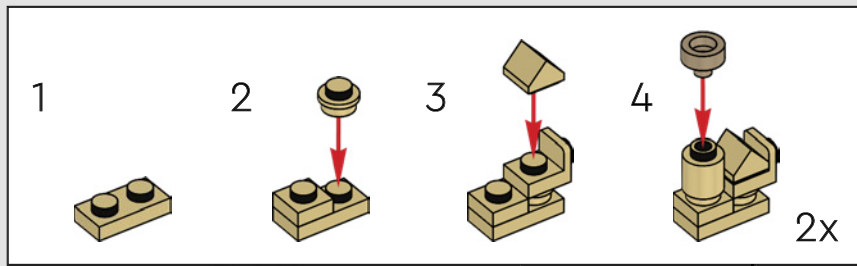
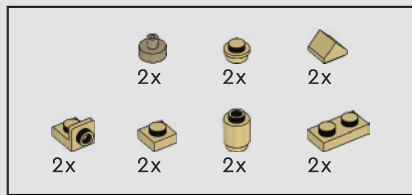

602

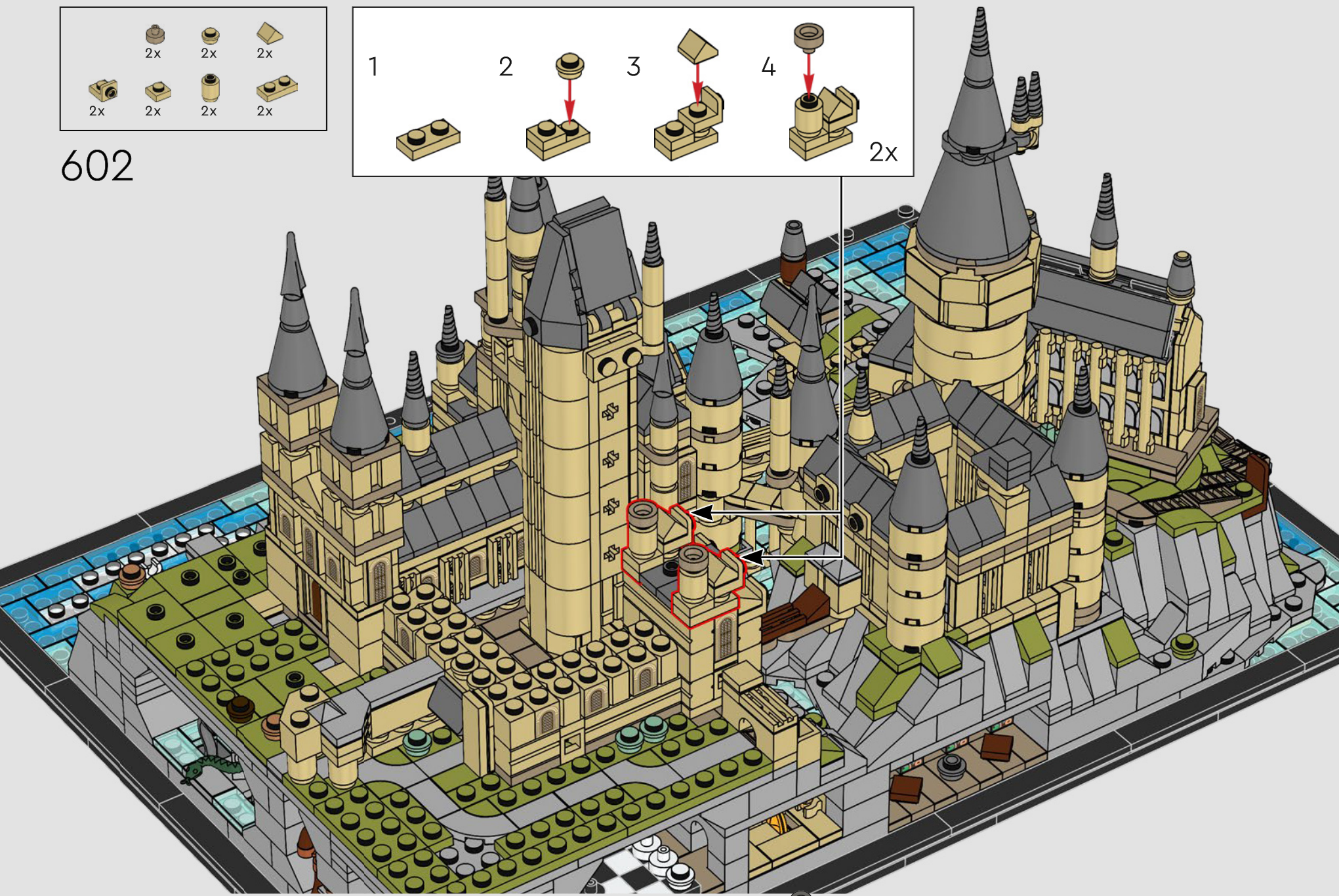

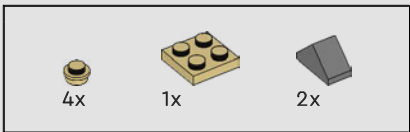

603

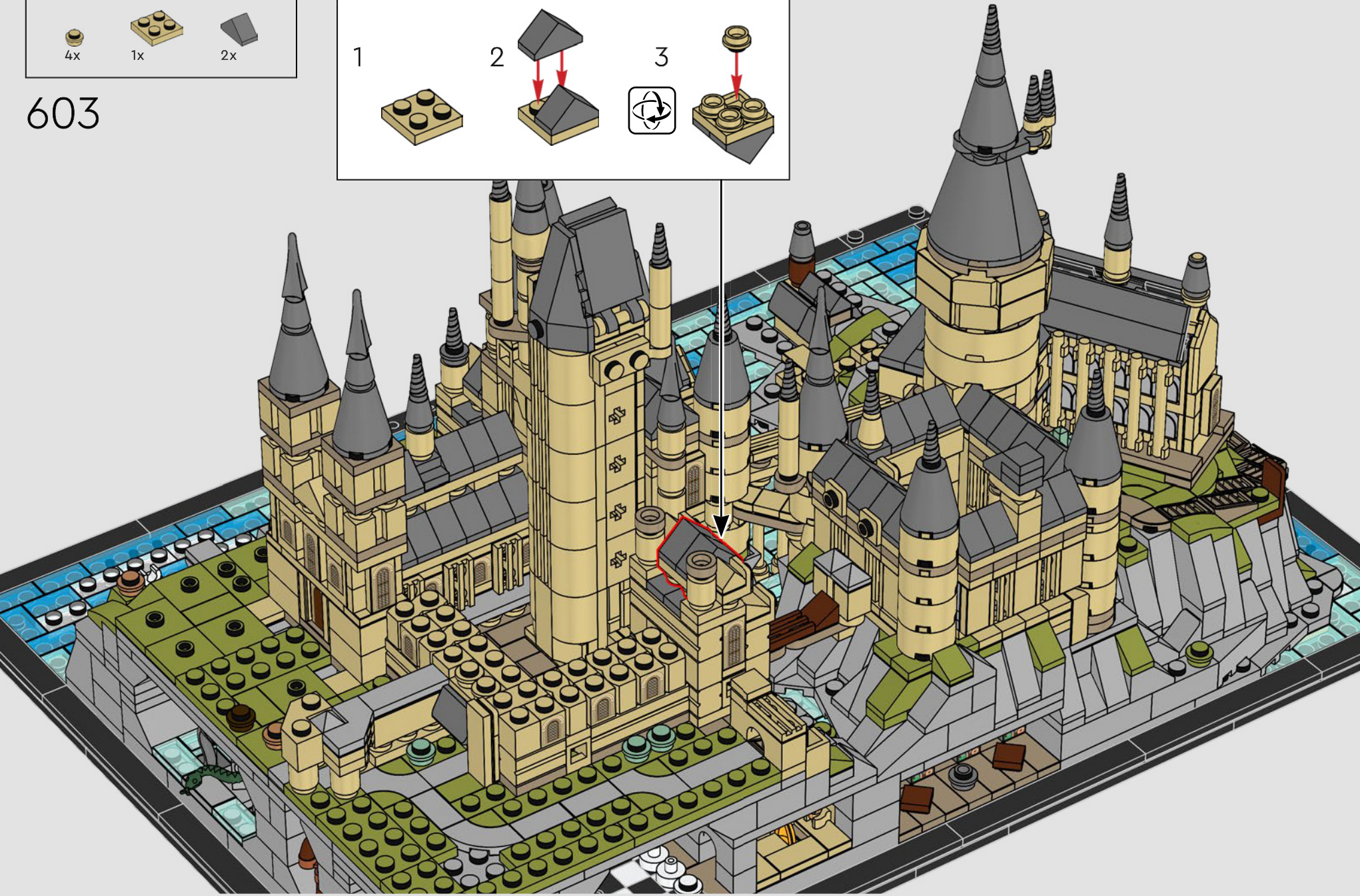
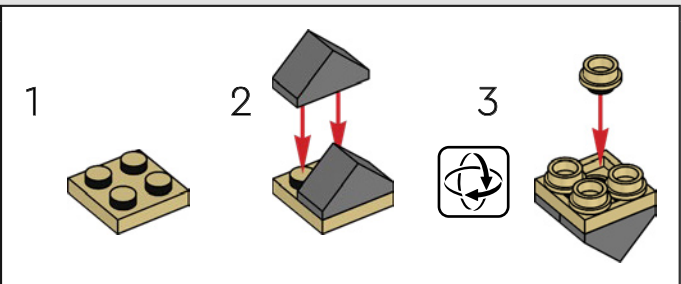

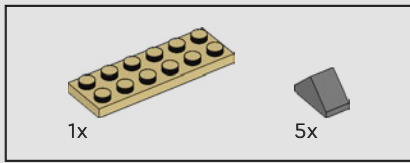

604

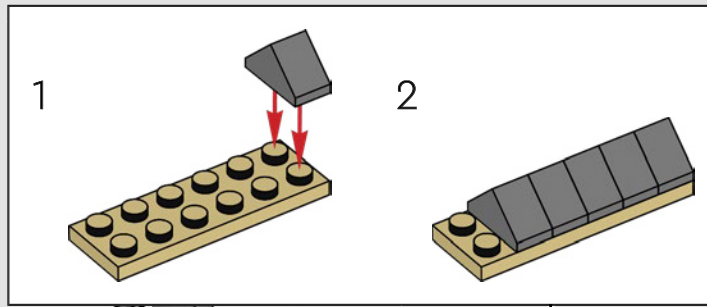

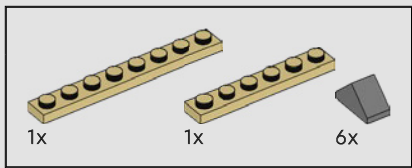

605

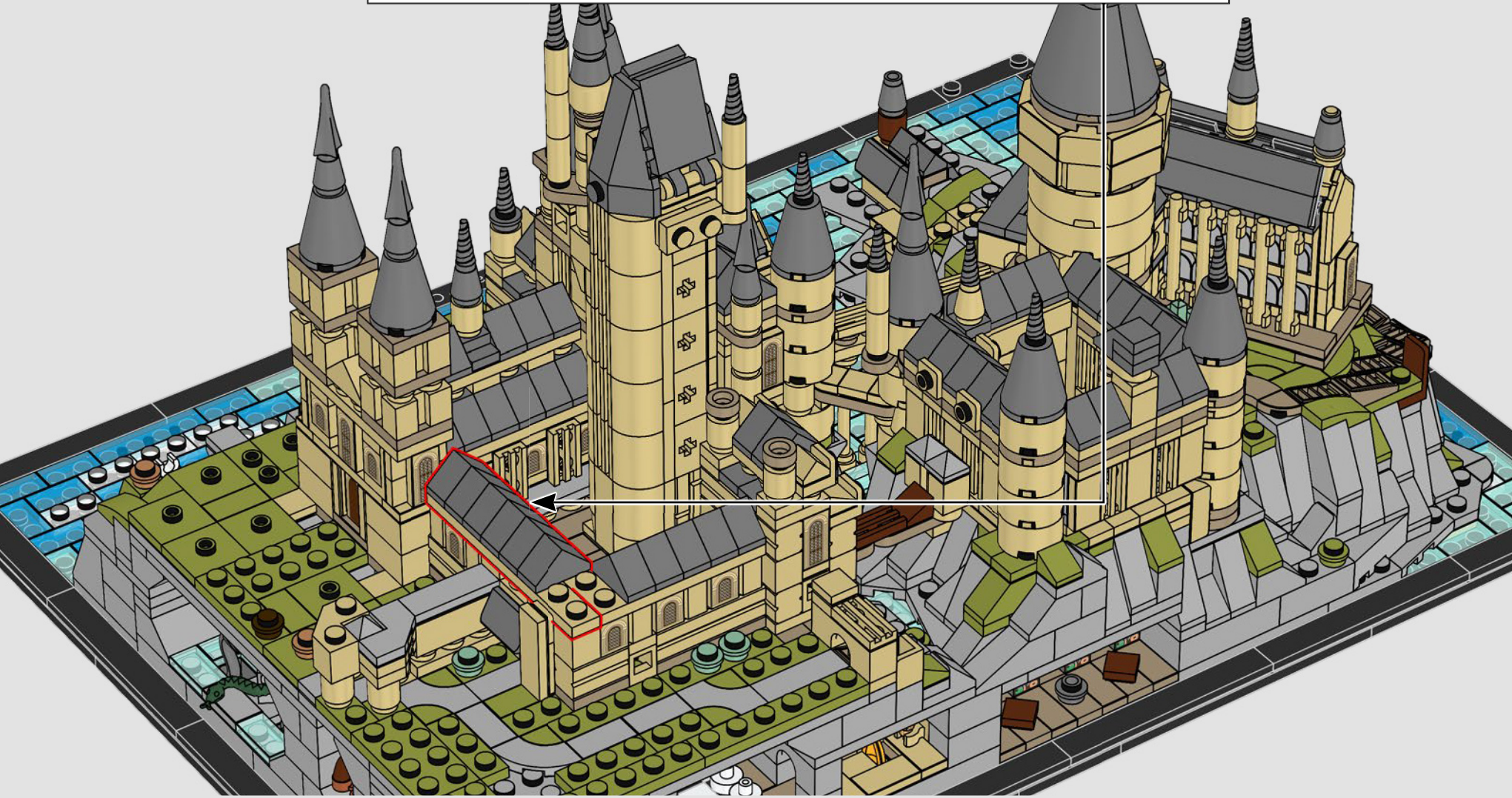
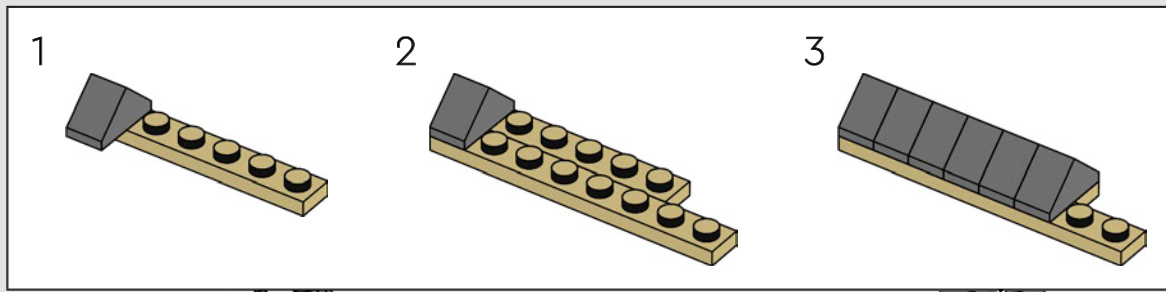

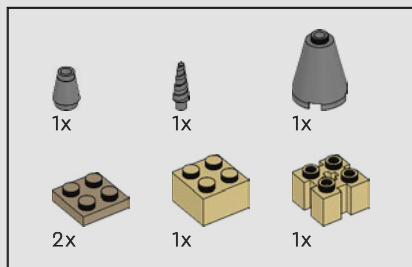

606

1

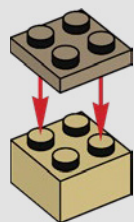

2

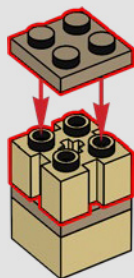

3

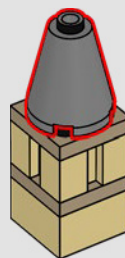

4

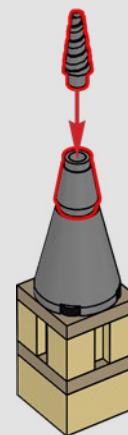



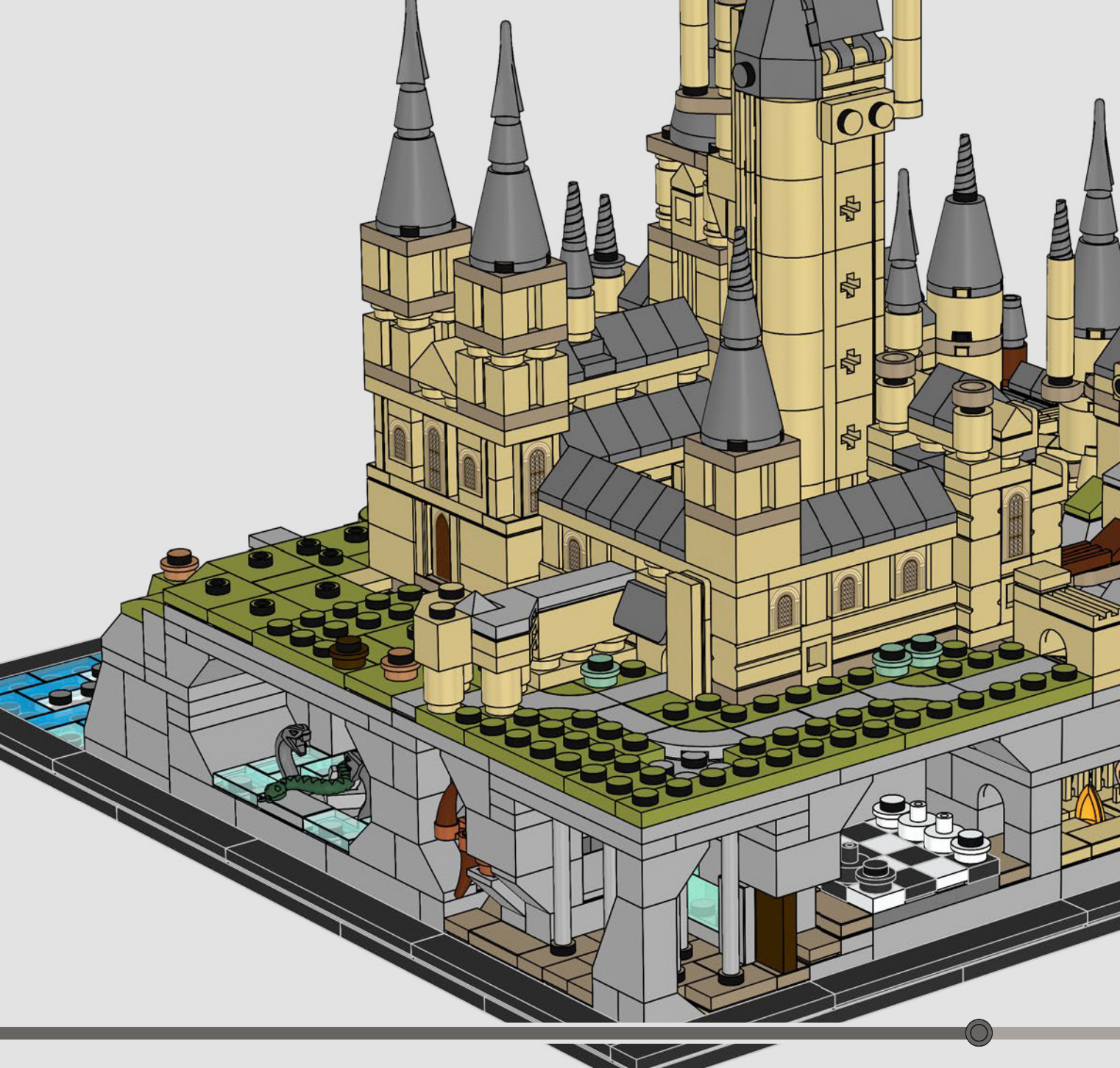

Hogwarts™ ist ein riesiges Schloss, in dem man sich leicht verlaufen kann. Aber wusstest du, dass sich im Schloss 142 Treppenhäuser befinden? Die Treppenhäuser verändern sich ständig und erschweren es einem zusätzlich, sich im Schloss zurechtzufinden.

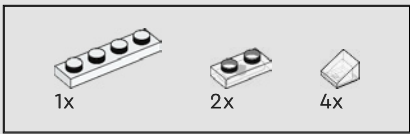

607

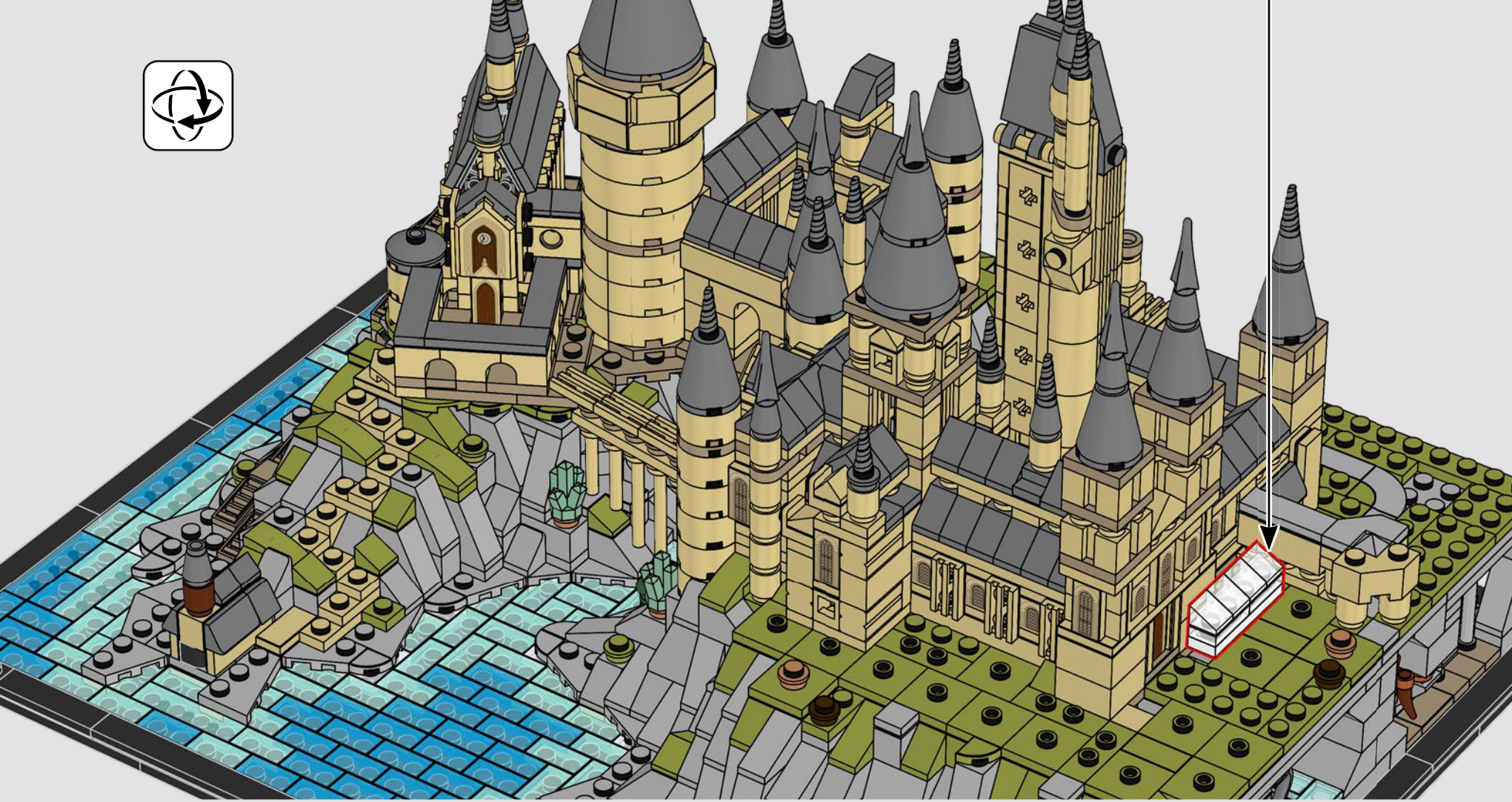
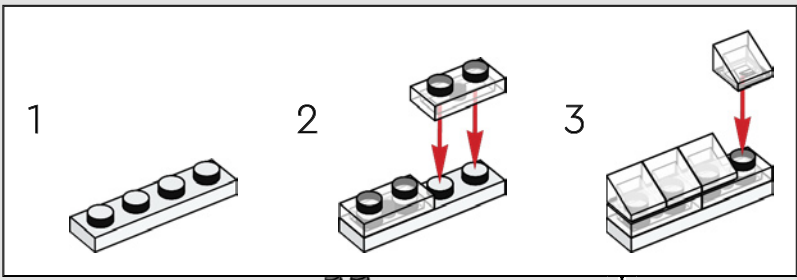



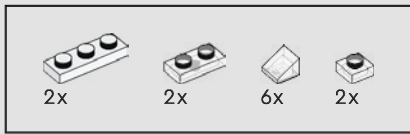

608

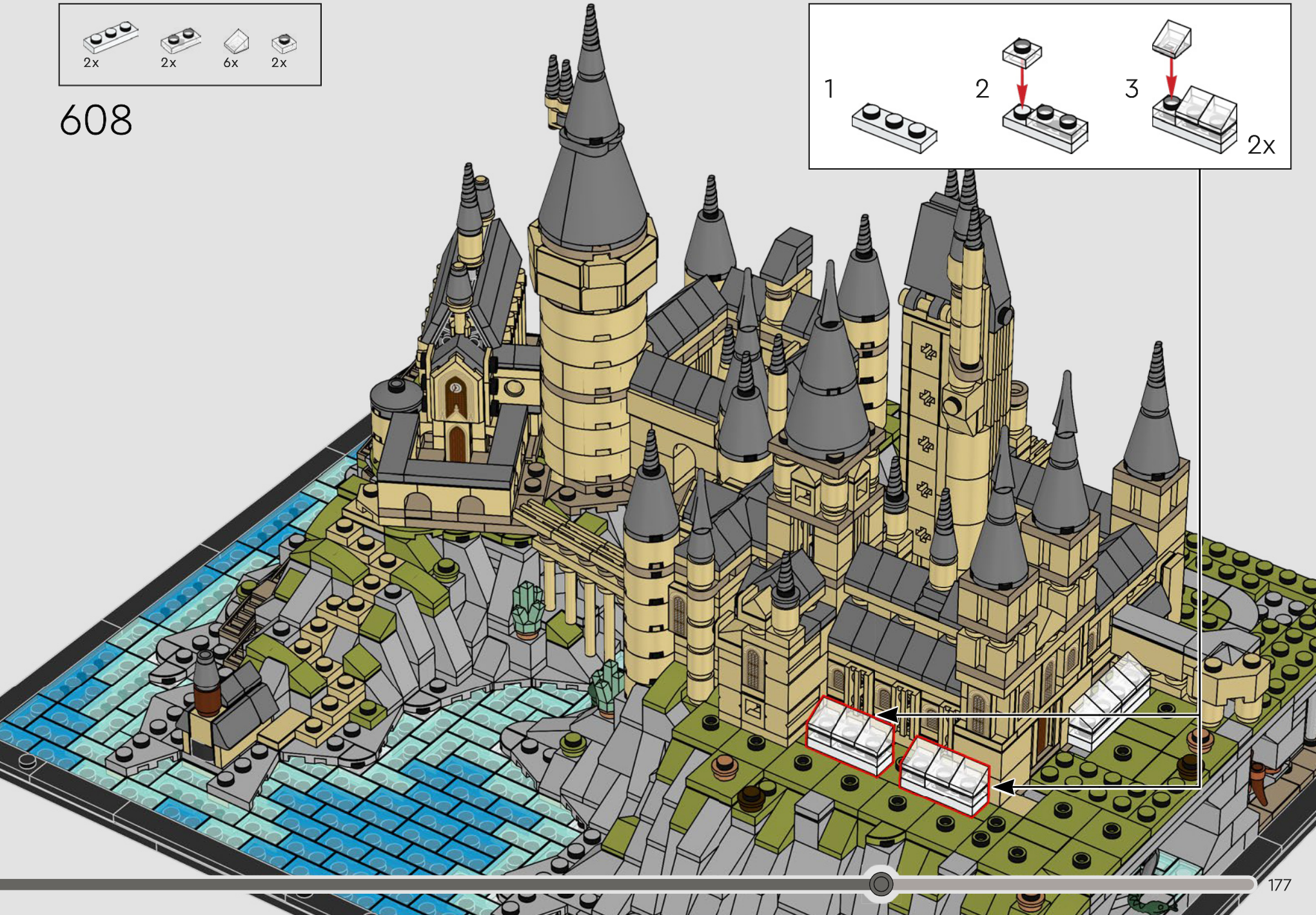
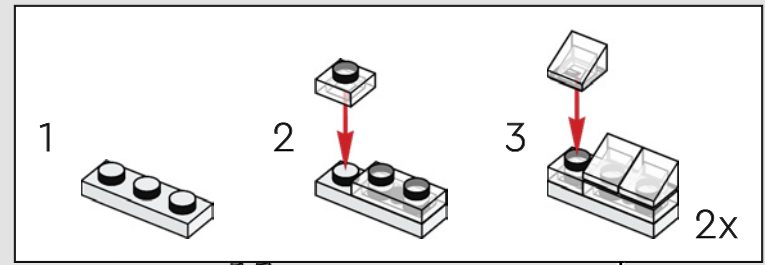



609

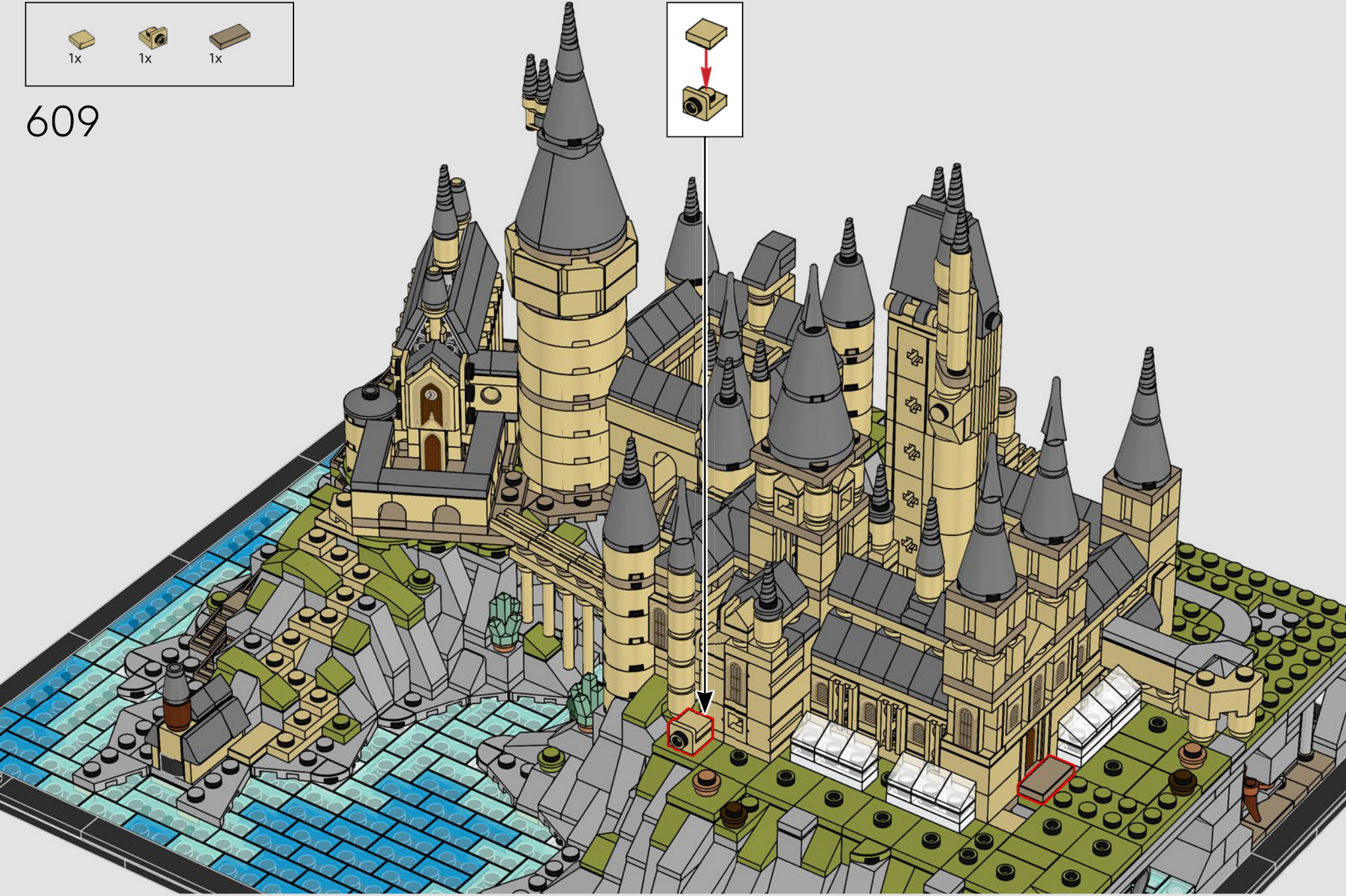
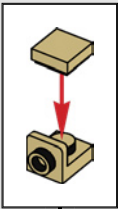



610

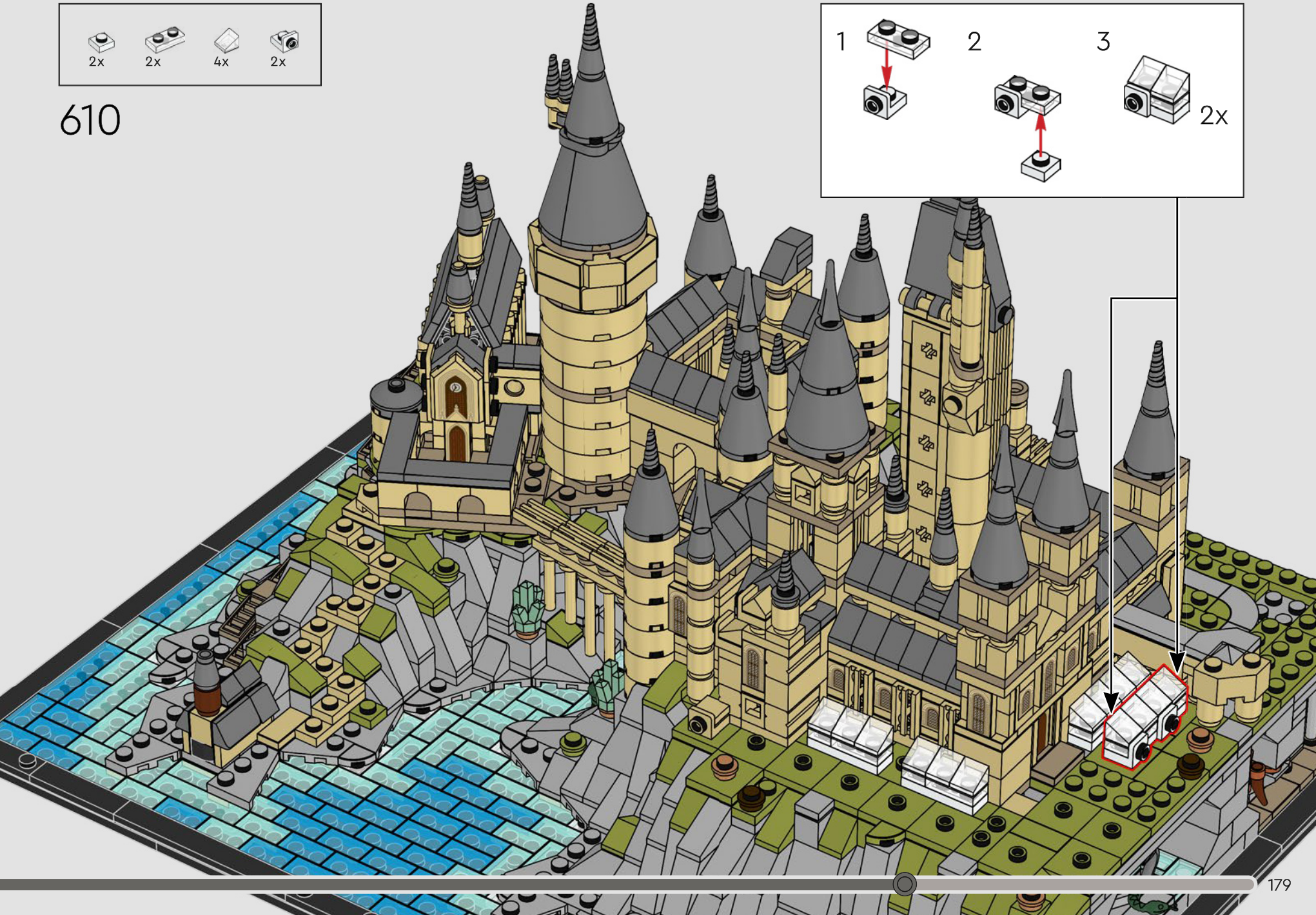
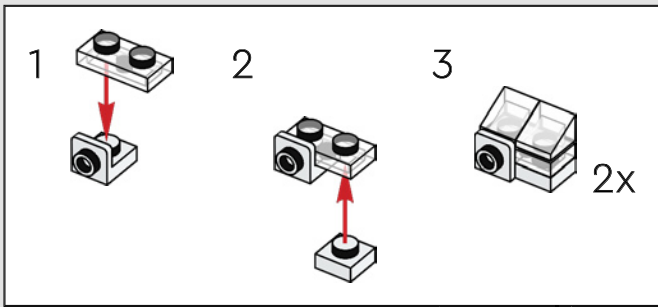

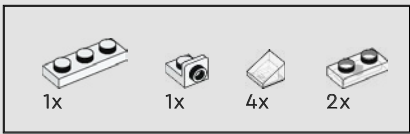

611

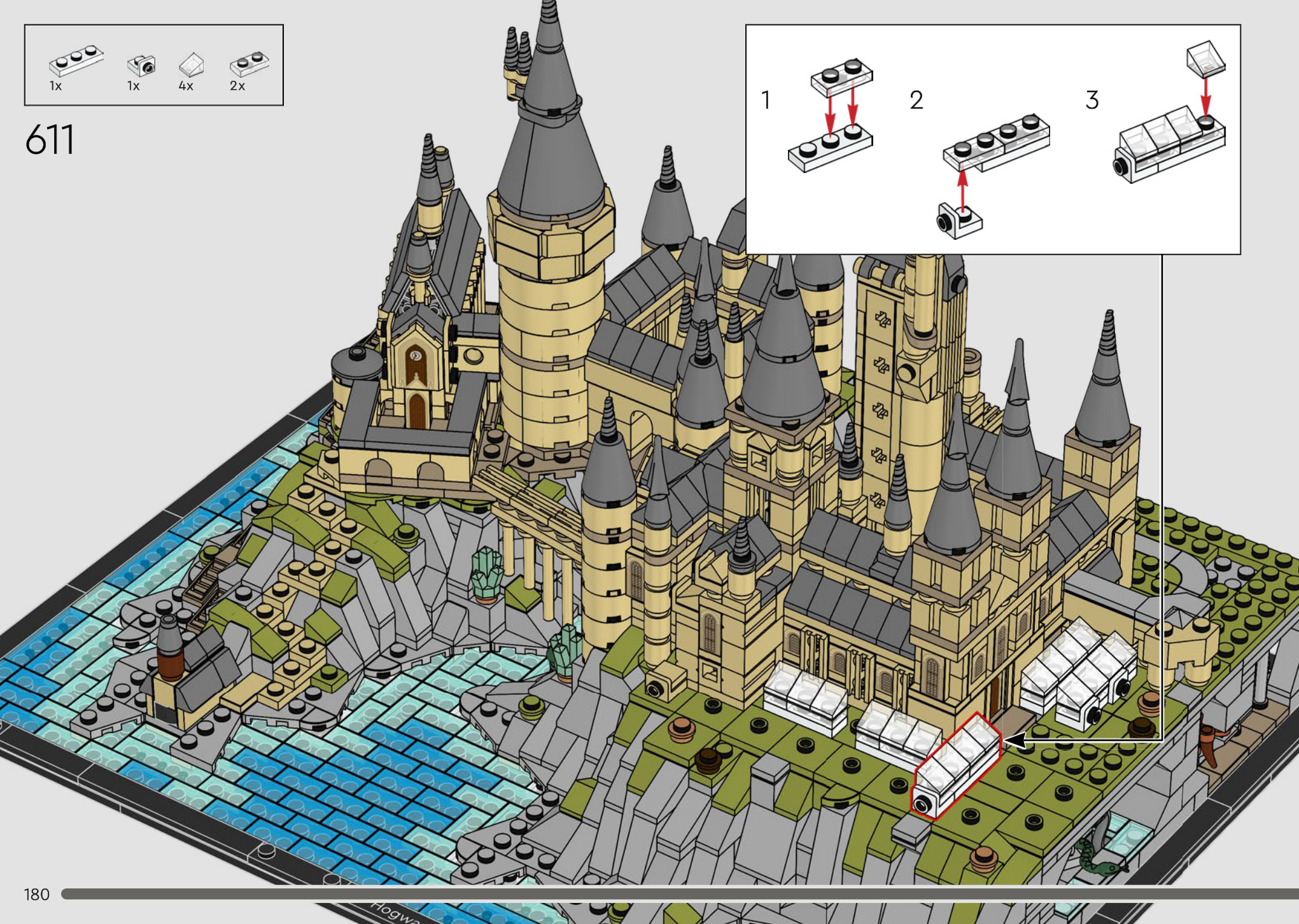
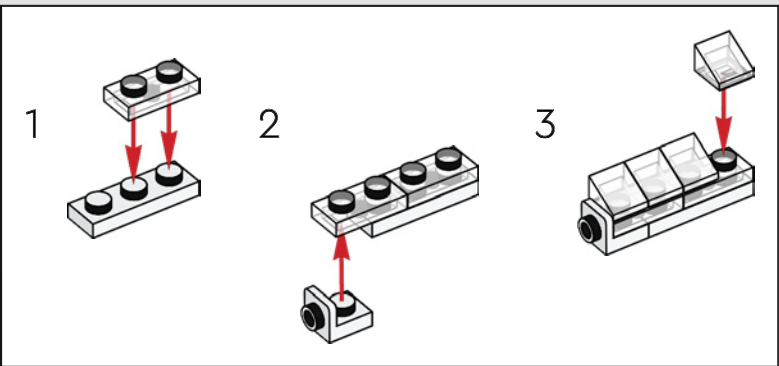

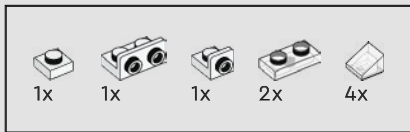

612

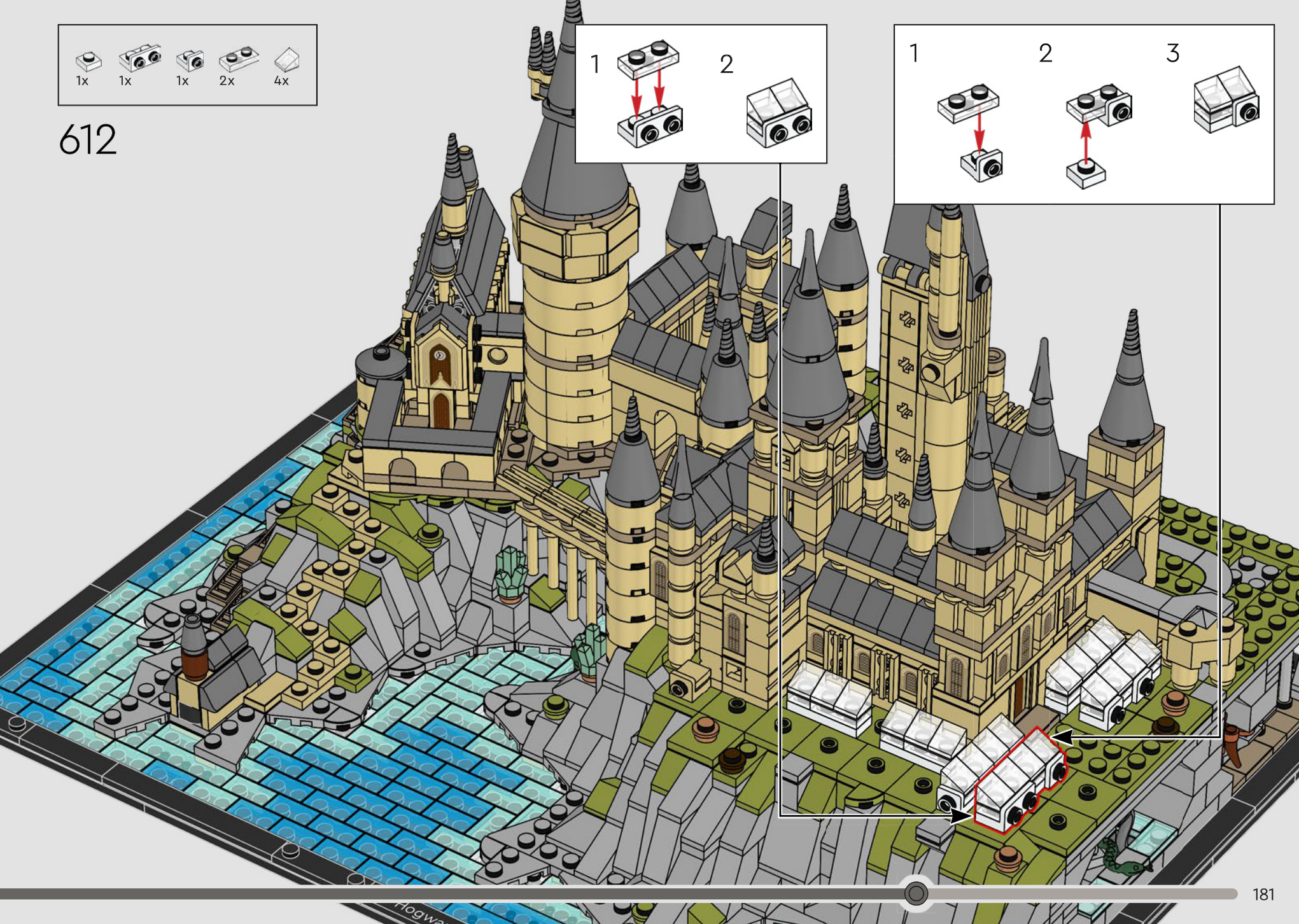
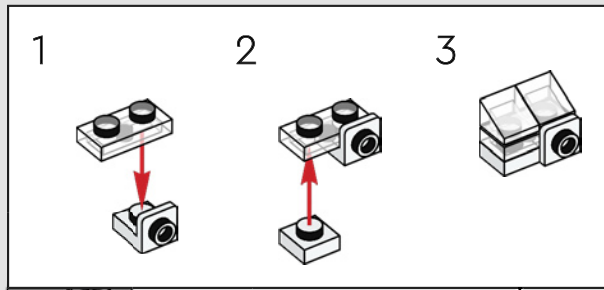
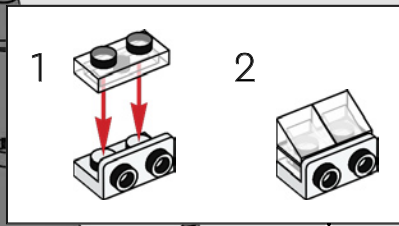

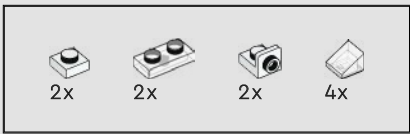

613

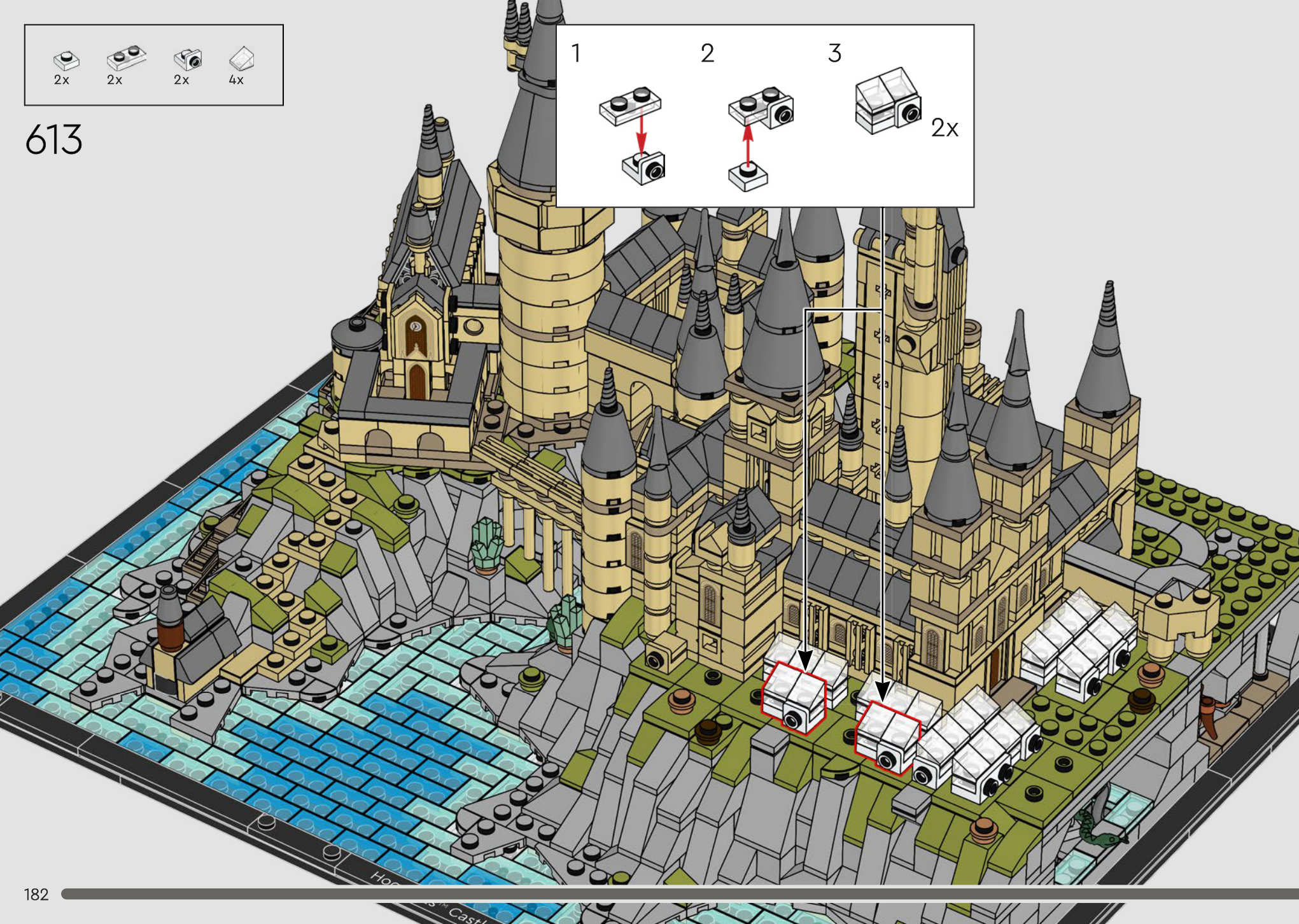
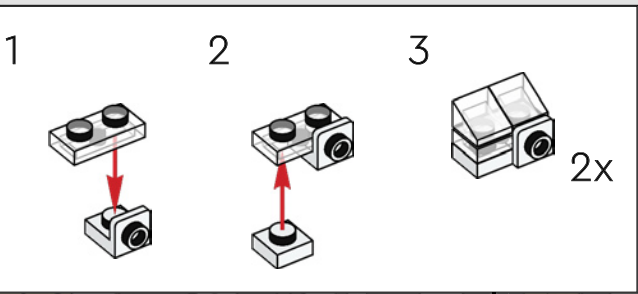



614

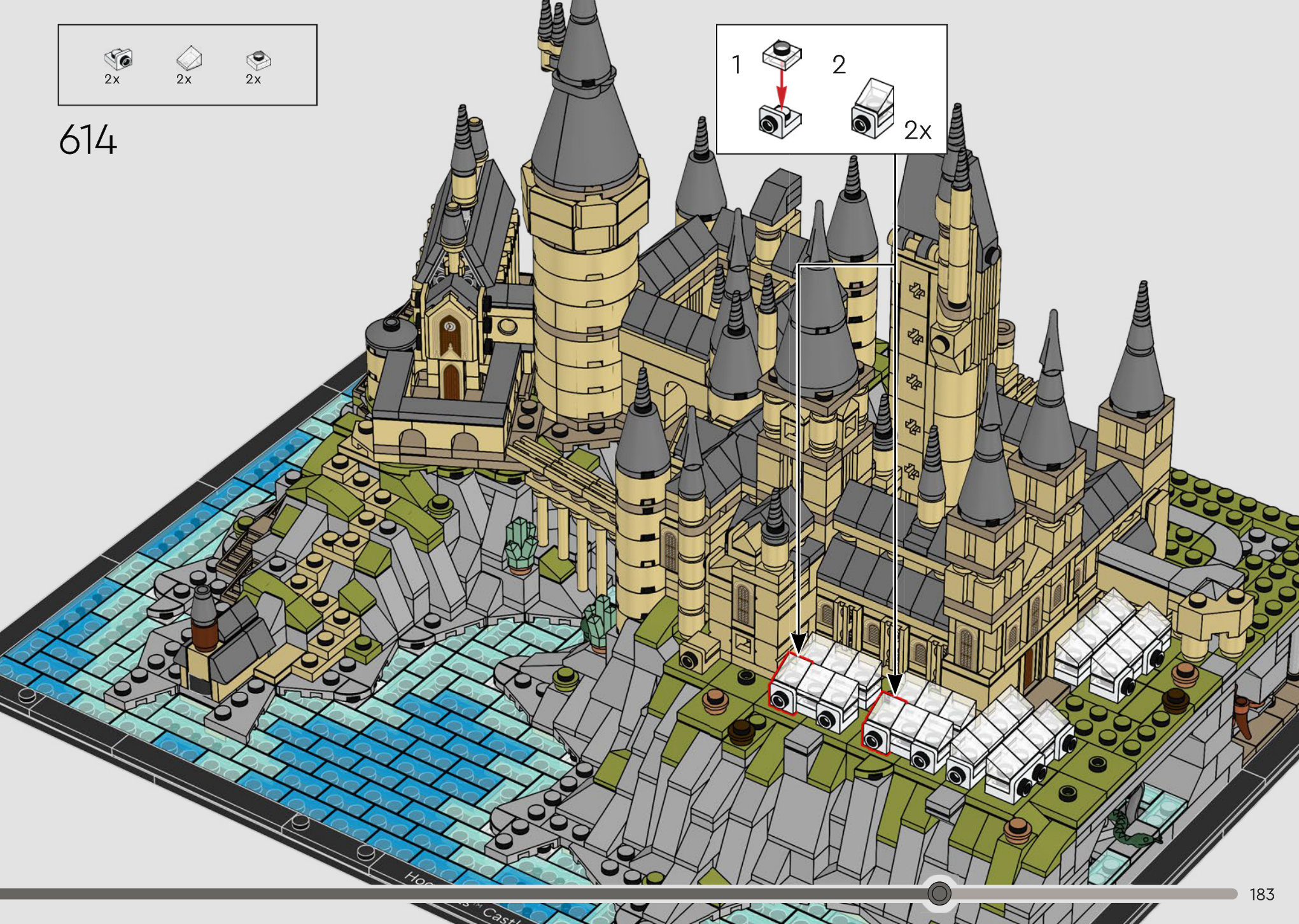
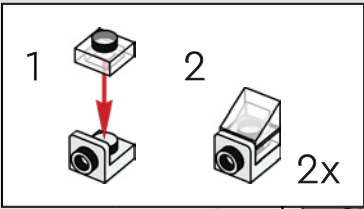

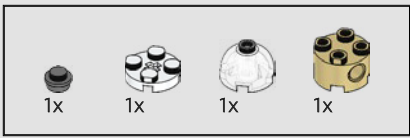

615

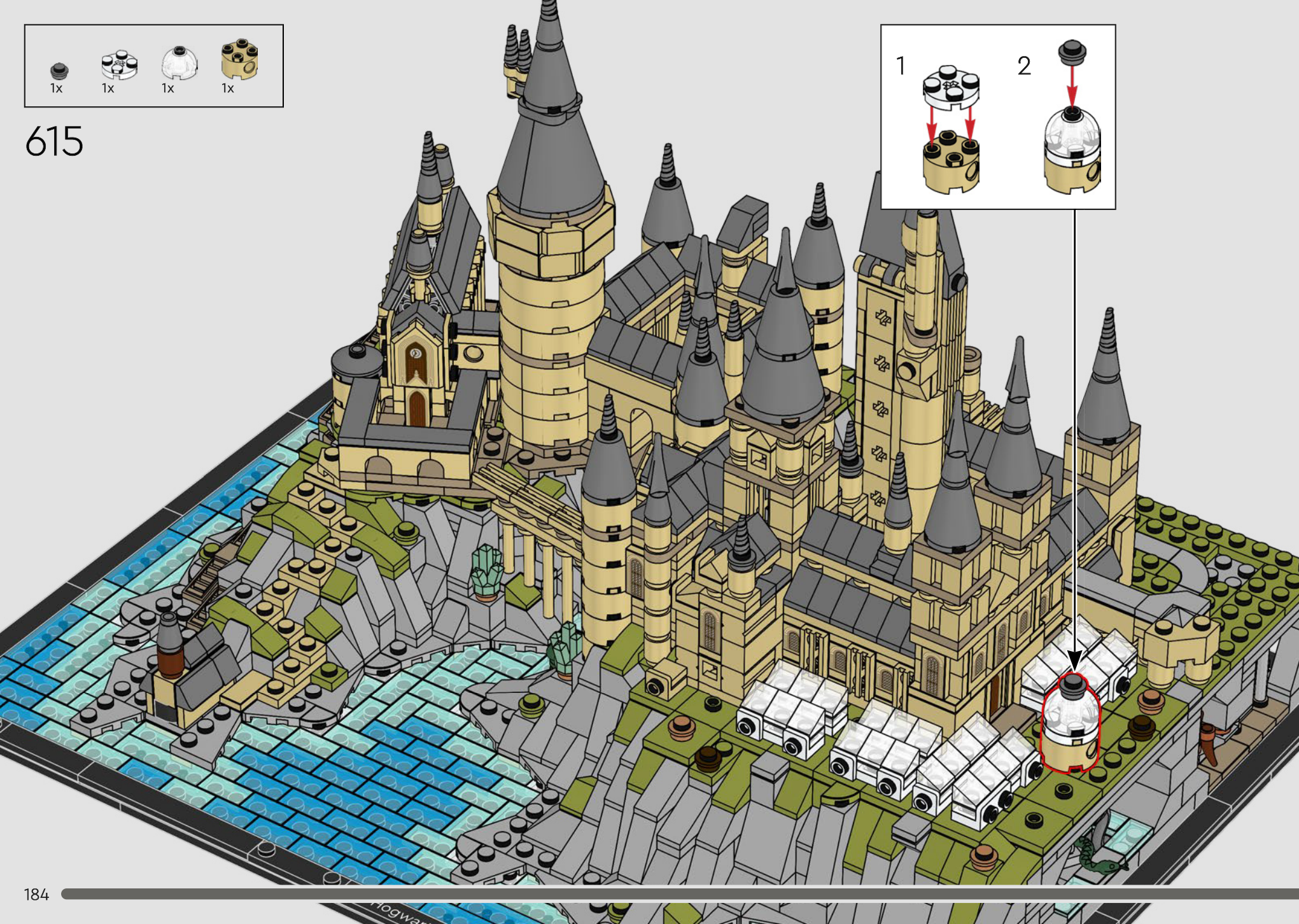
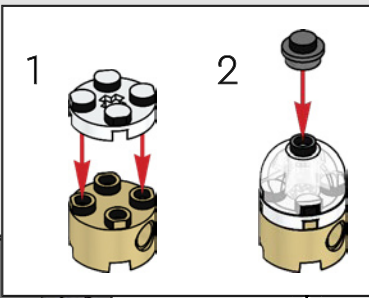



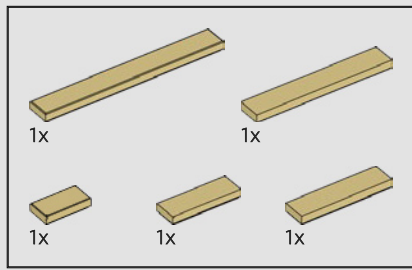

616

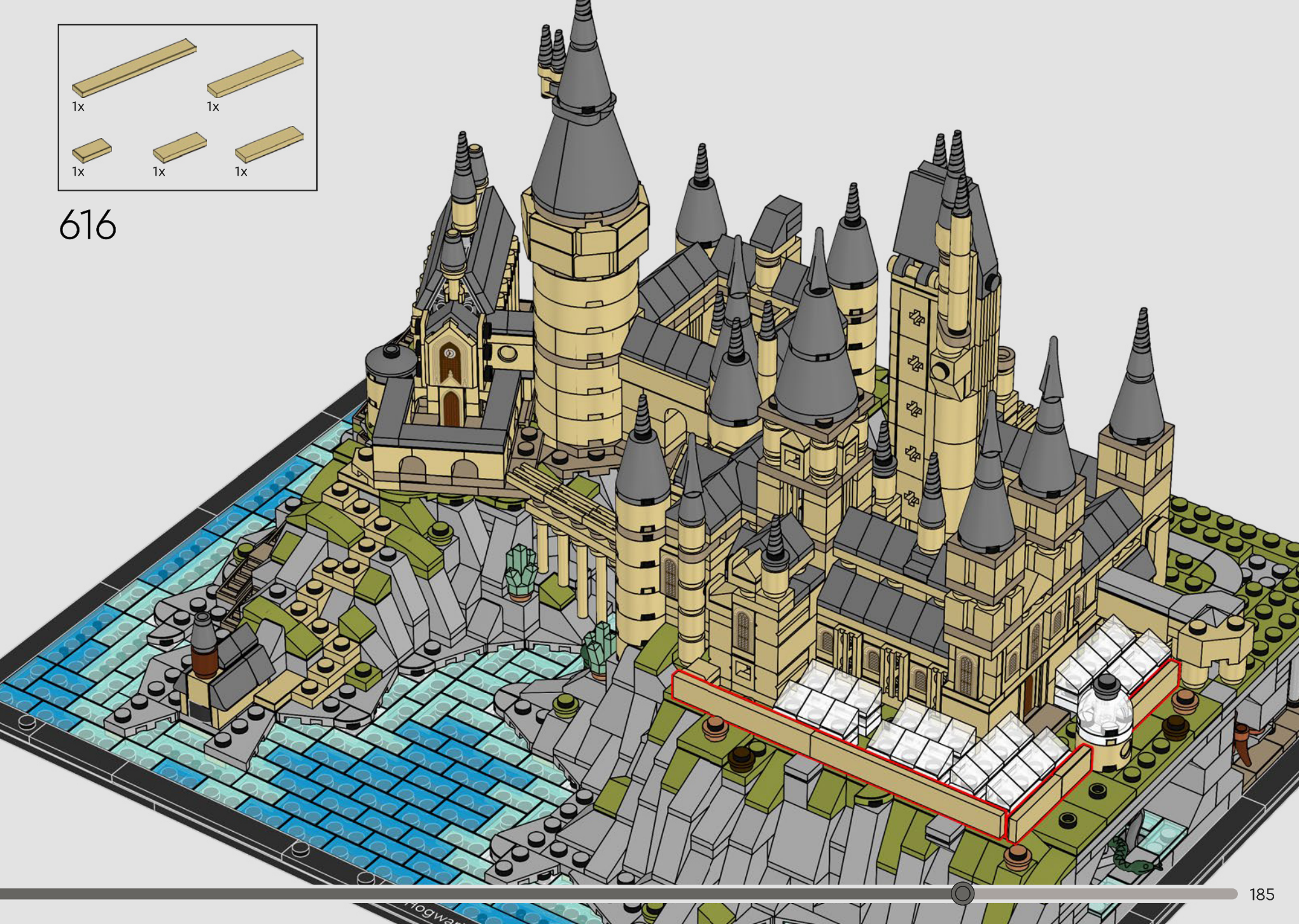

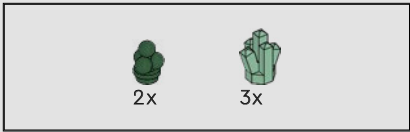

617

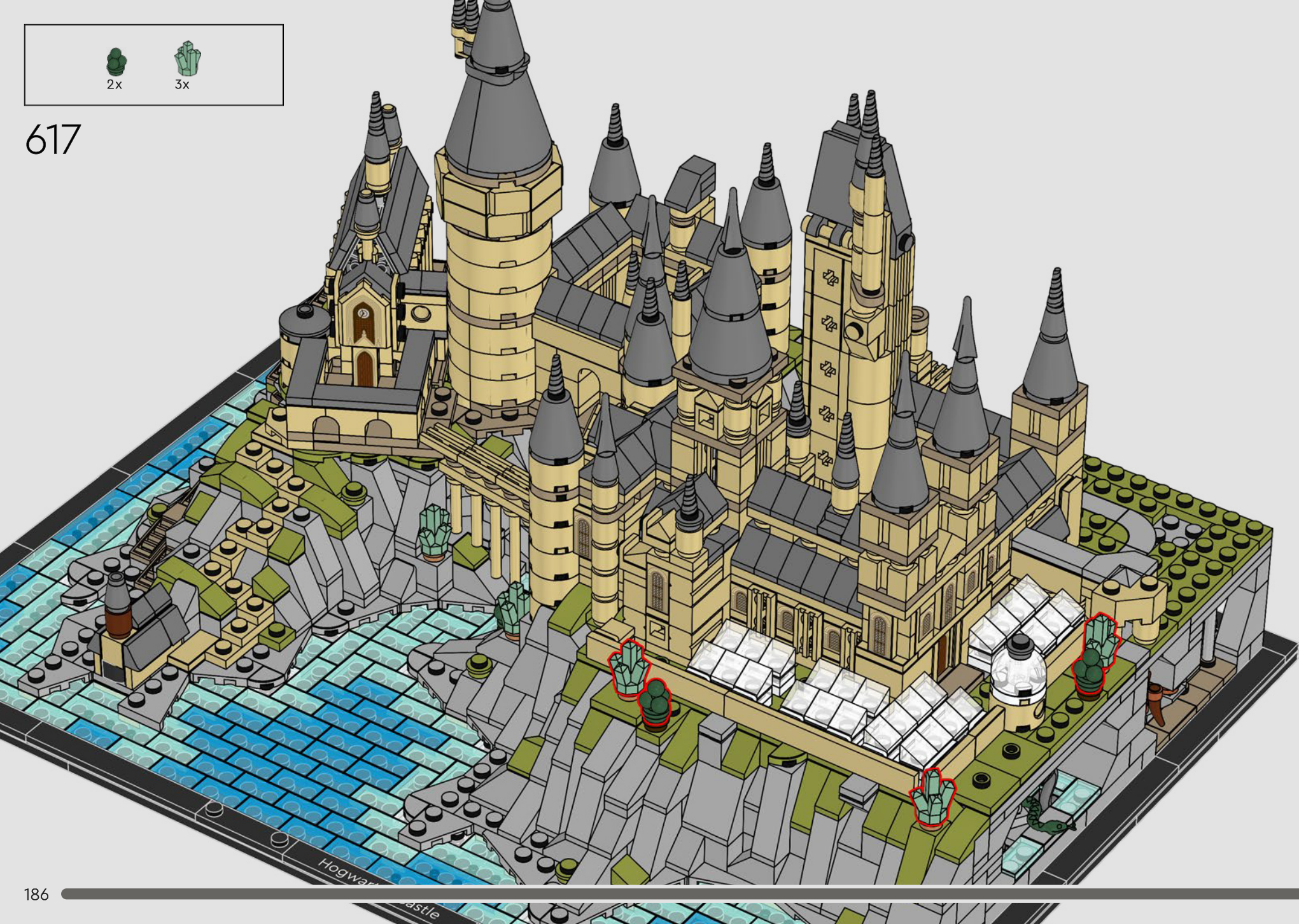

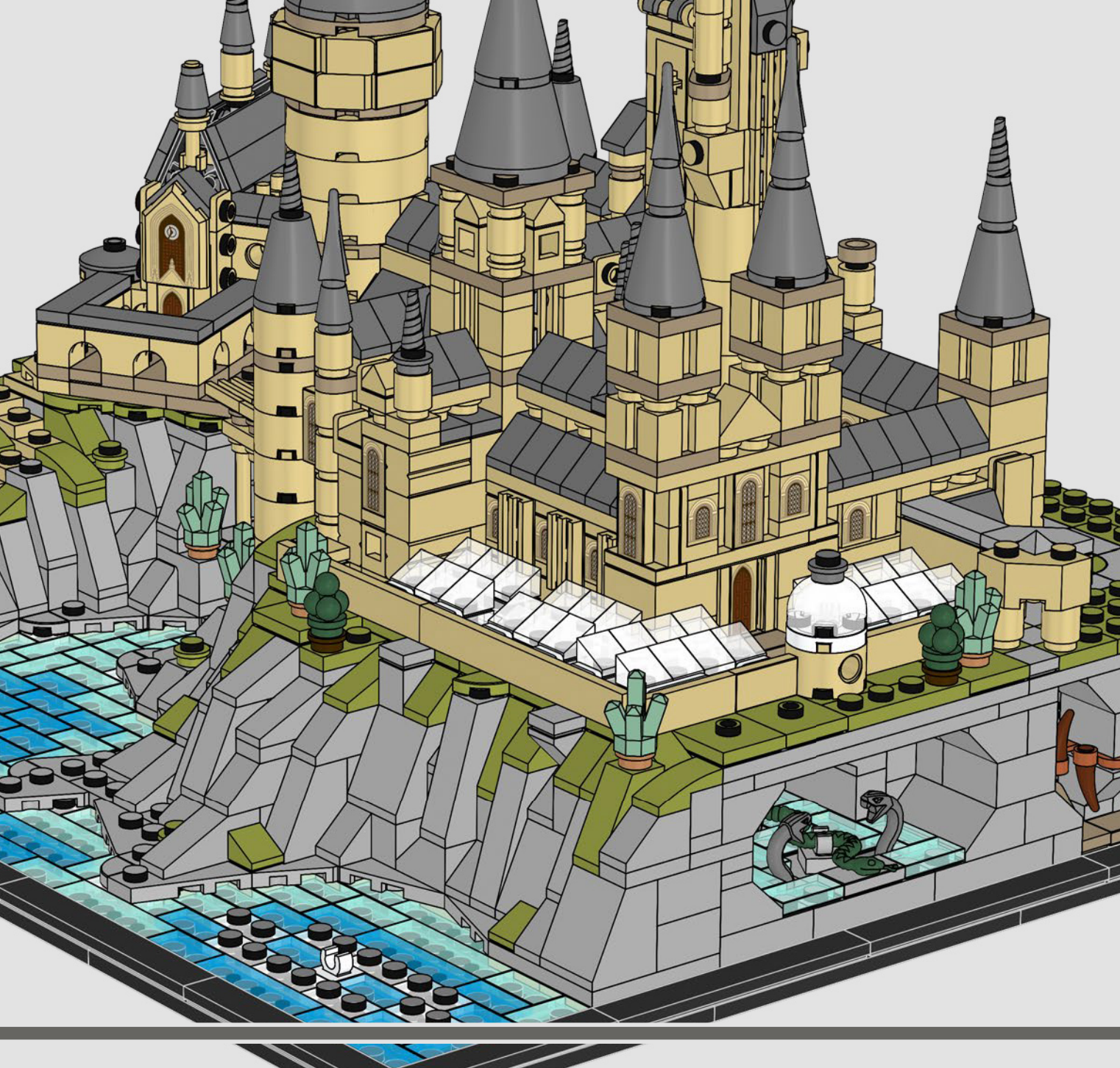

In den Gewächshäusern unterrichtet Professor Sprout, die Fachlehrerin für Kräuterkunde in Hogwarts™, die Schülerinnen und Schüler im sicheren Umgang und Gebrauch der magischen Pflanzen. Wenn jetzt bitte alle ihren Gehörschutz benutzen würden ...



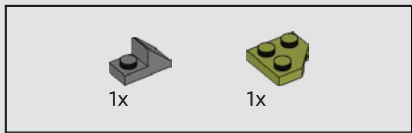

618

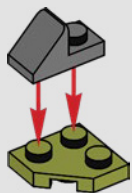

619

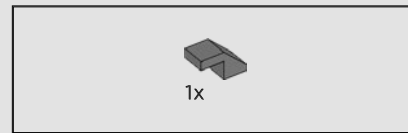
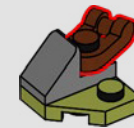

620

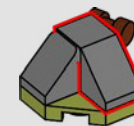

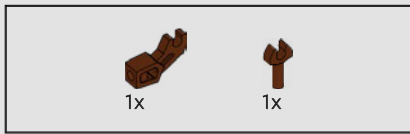

621

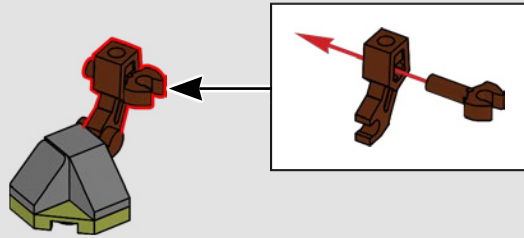

622



623

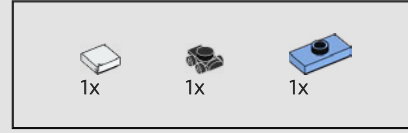
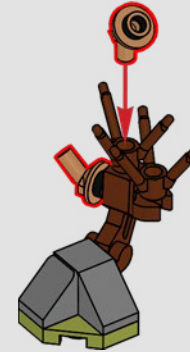

624

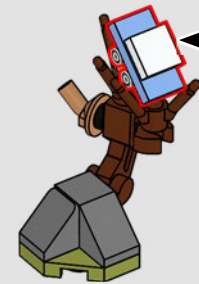
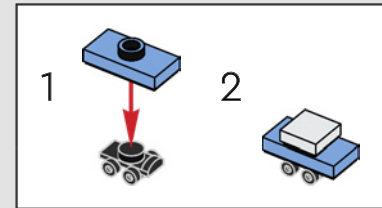



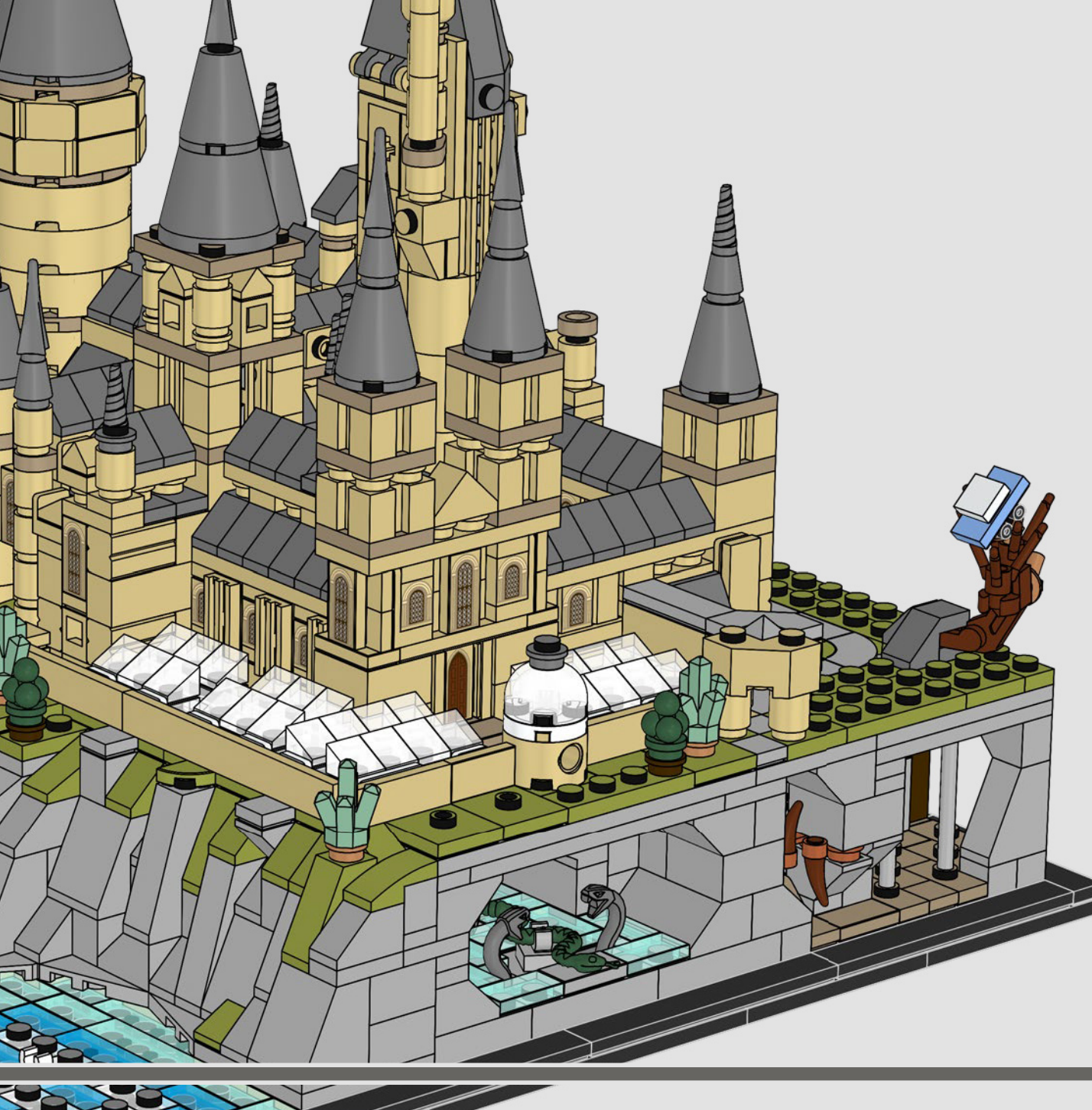

Die Peitschende Weide™ wurde gepflanzt, um Professor Lupin einen sicheren Fluchtweg zu bieten, wenn er sich bei Vollmond in einen Werwolf verwandelt. In dem Baum verbirgt sich ein Geheimtunnel zur Heulenden Hütte, in der Lupin bleiben konnte, bis er wieder Menschengestalt angenommen hatte.



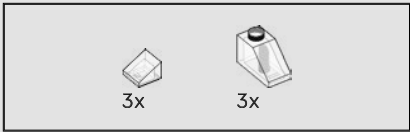

626

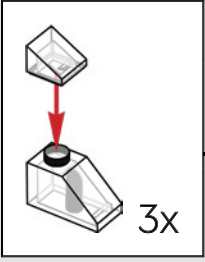
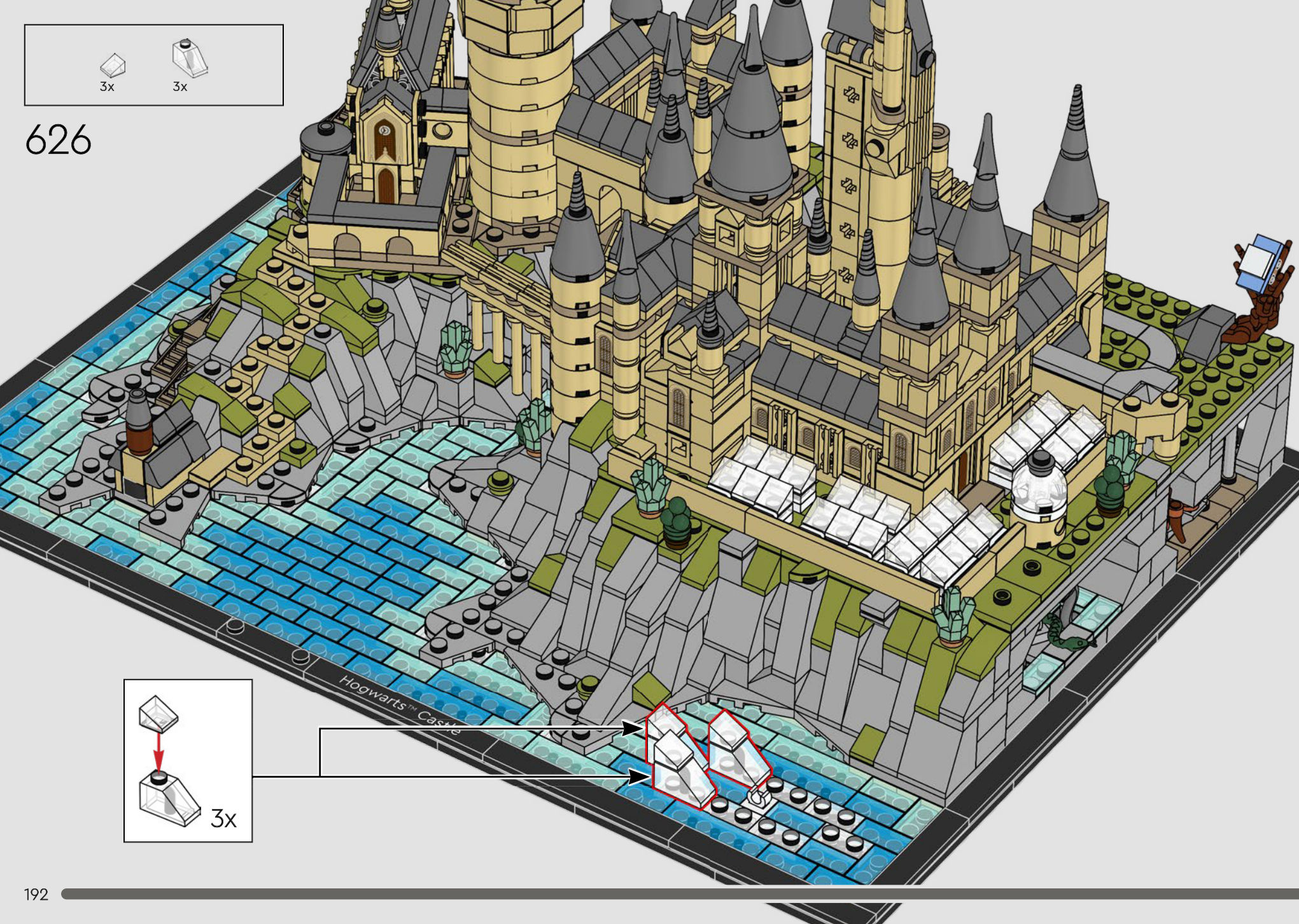





627

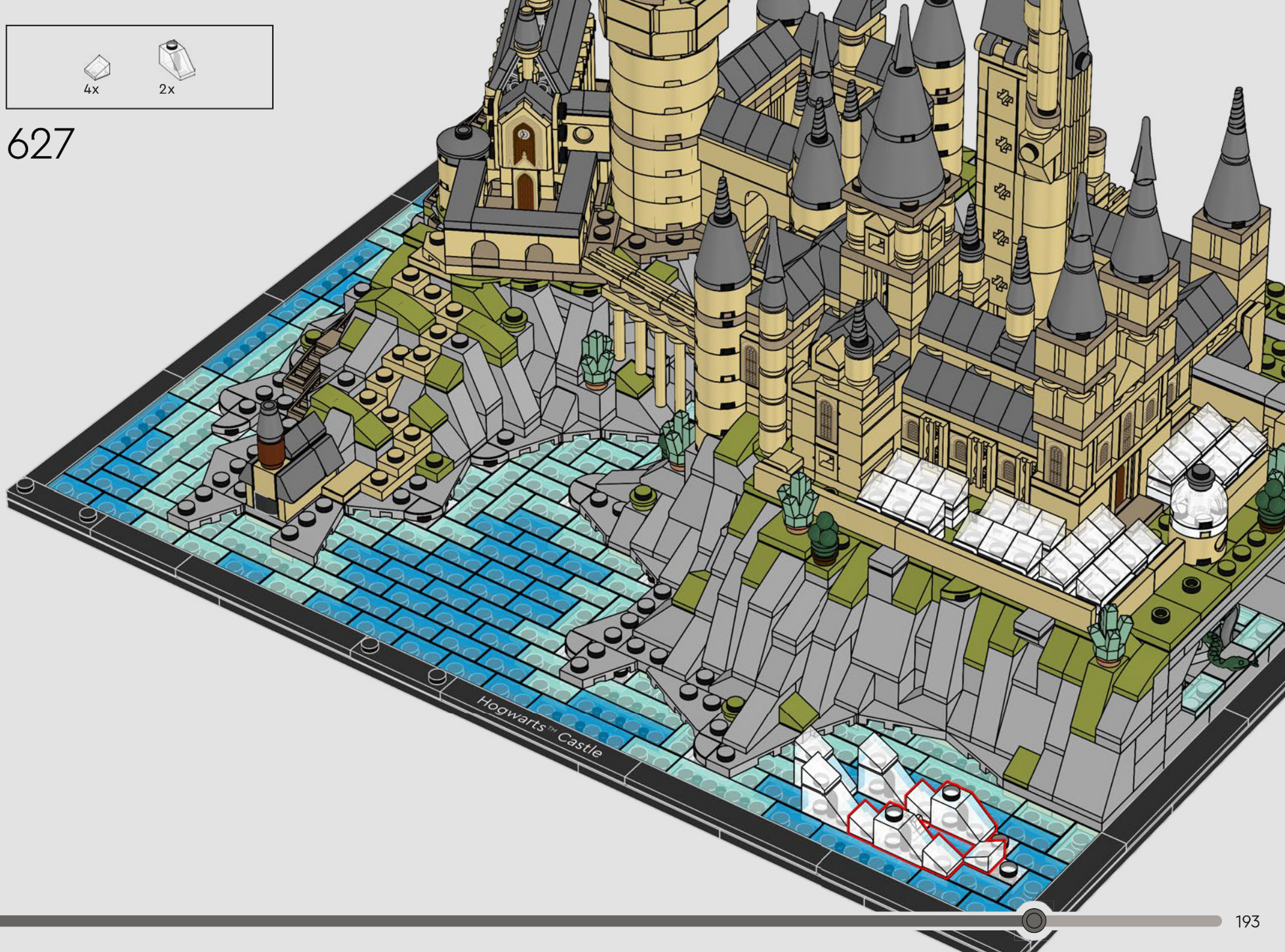

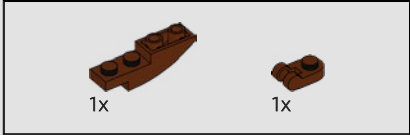
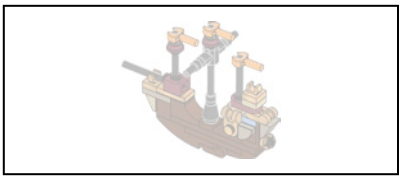

628

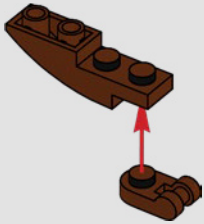

629

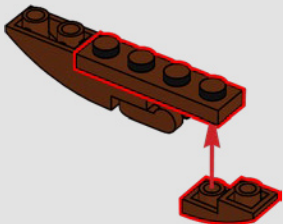

630

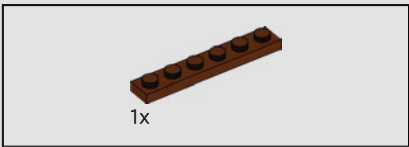
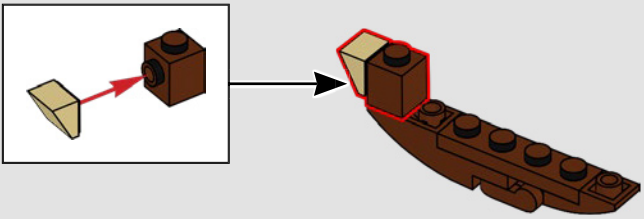

631

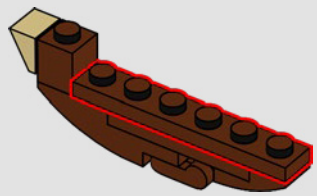

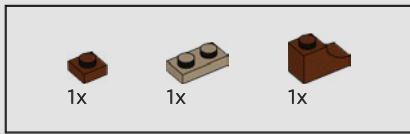

632

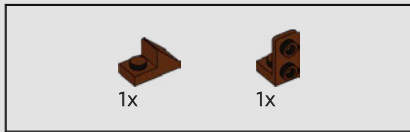
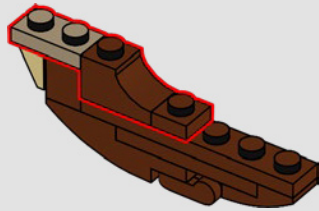

633

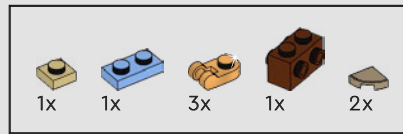
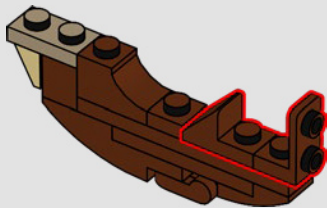

634

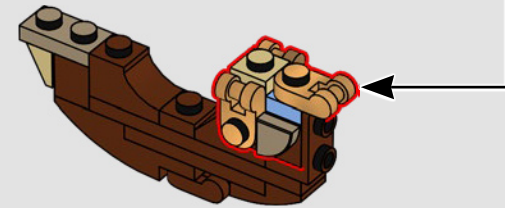
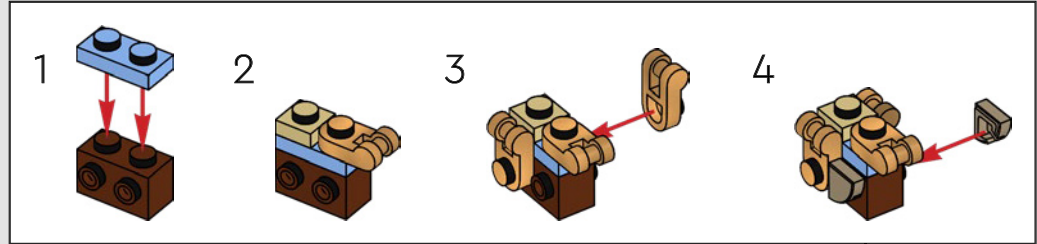



635

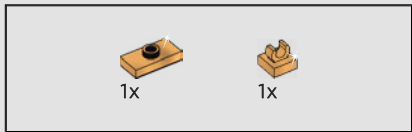
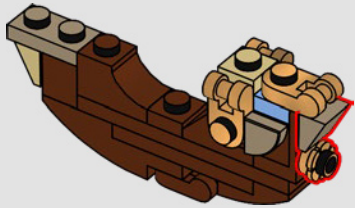

636

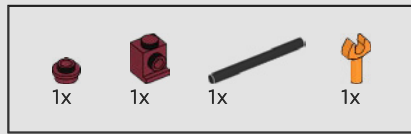
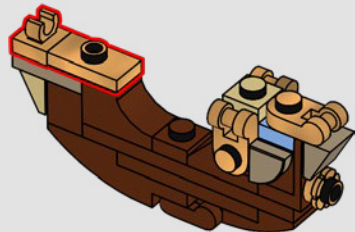

637

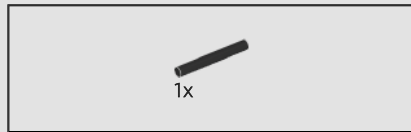
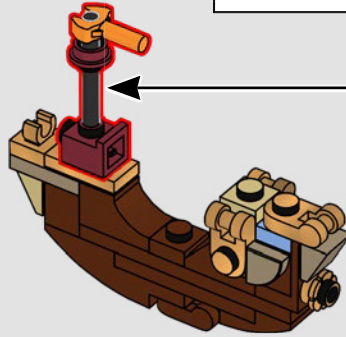
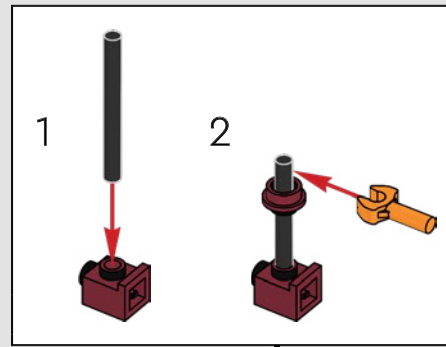

638

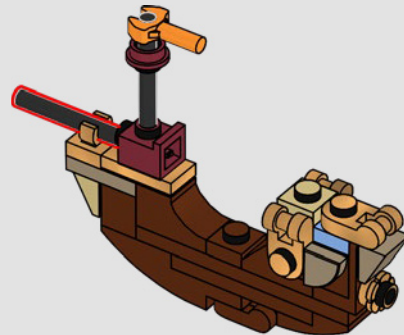

Das magische Durmstrang-Schiff wurde für Reisen zwischen dem Durmstrang-Institut und Schloss Hogwarts™ benutzt, um am Trimagischen Turnier teilzunehmen. Doch hast du dich jemals gefragt, wie das Schiff von der Nordsee in den Großen See gelangen konnte?

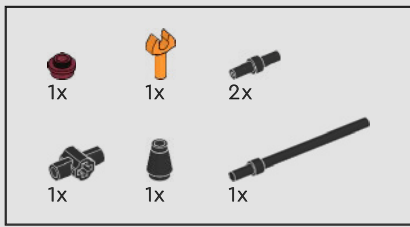

639

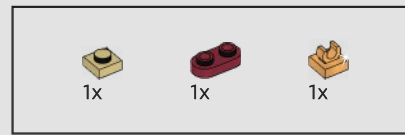
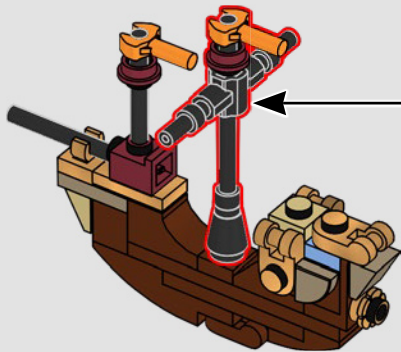
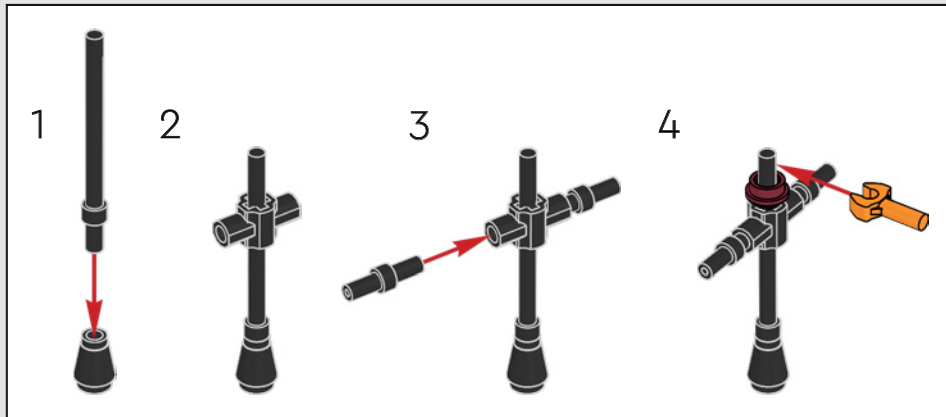

640

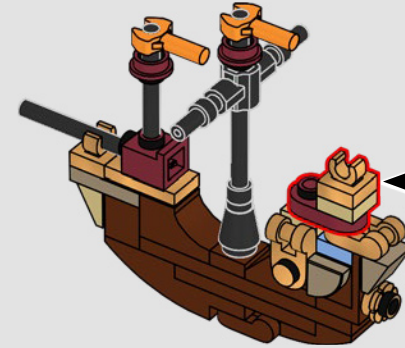
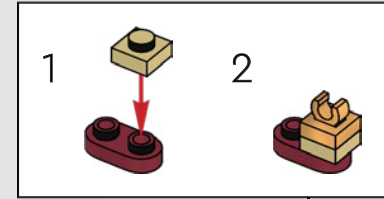

641

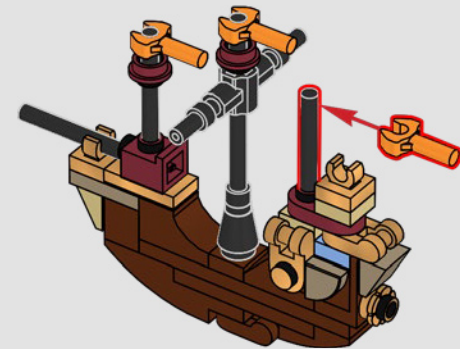



Hogwarts™ Castle

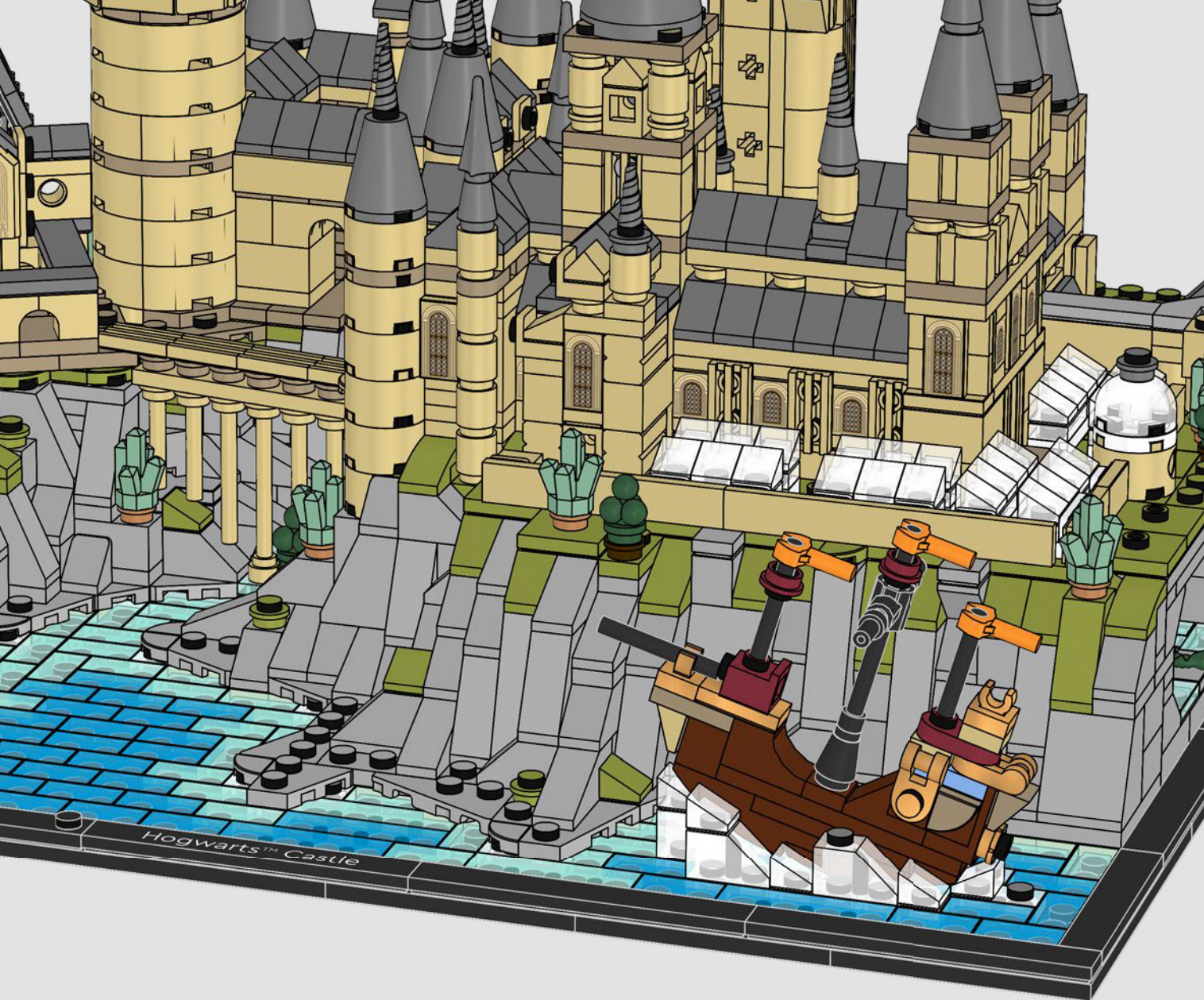

Das Durmstrang-Schiff hat es durch eine magische Abkürzung in den See geschafft, die wie von Zauberhand zwischen dem See und anderen Gewässern geschaffen wurde!

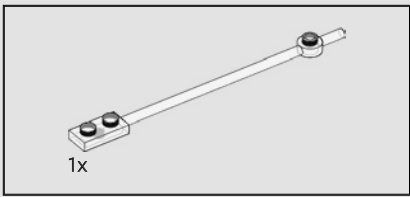

643









647

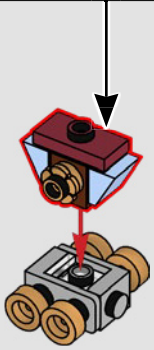
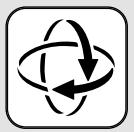
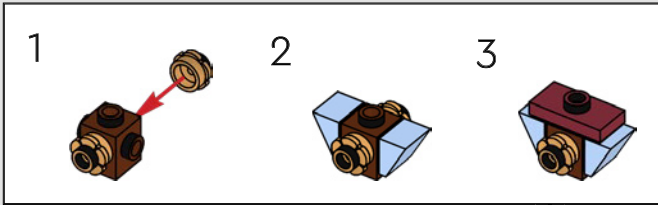

648

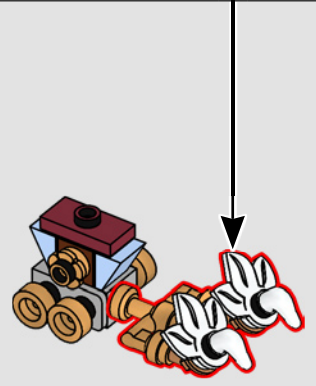
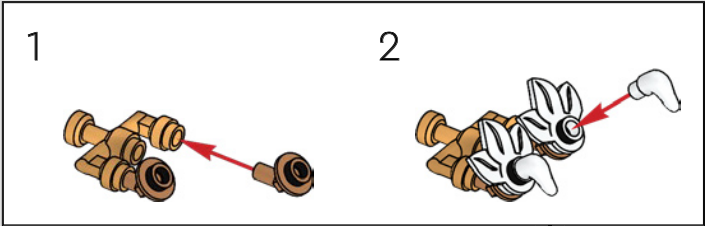

649

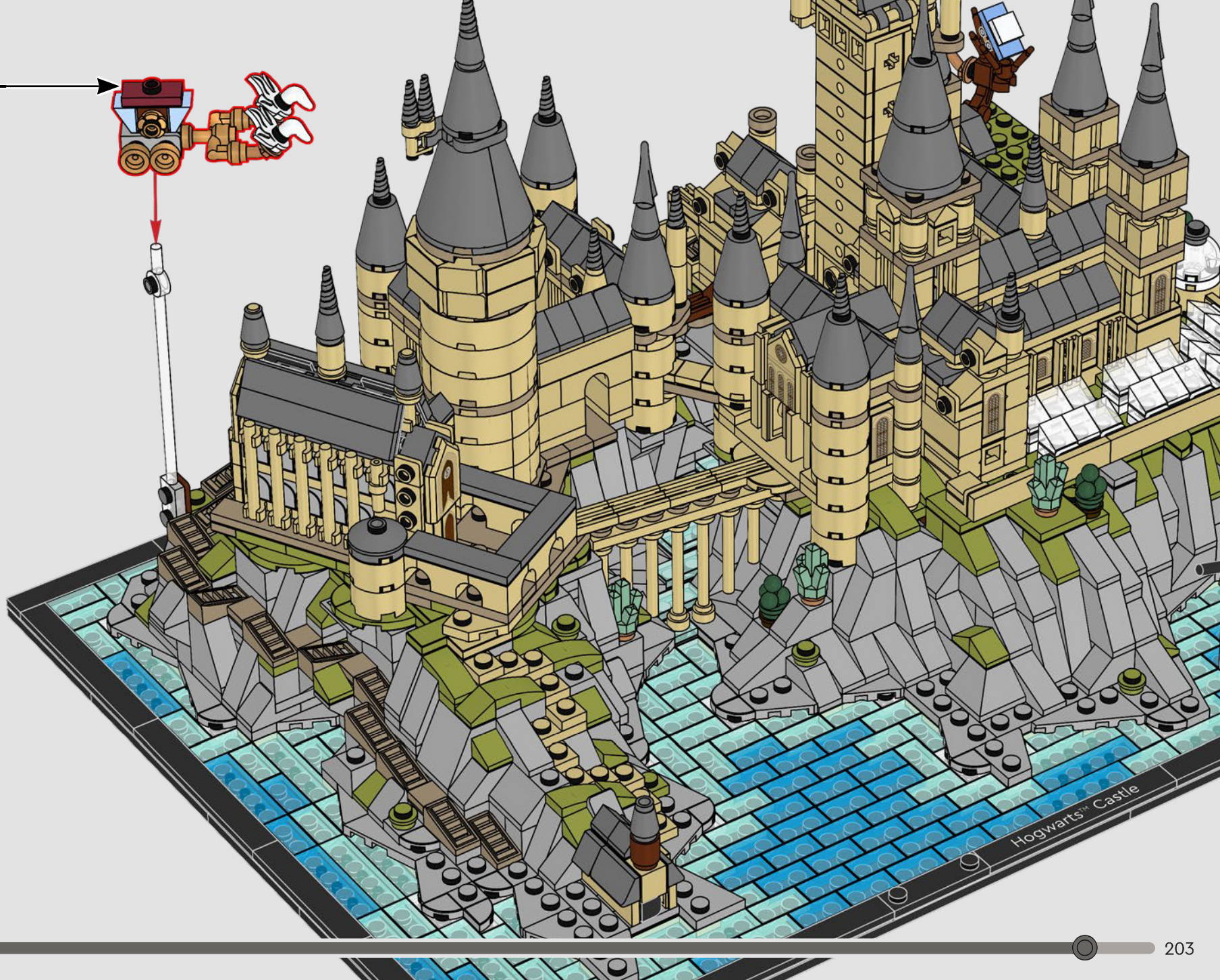

Hogwarts™ Castle

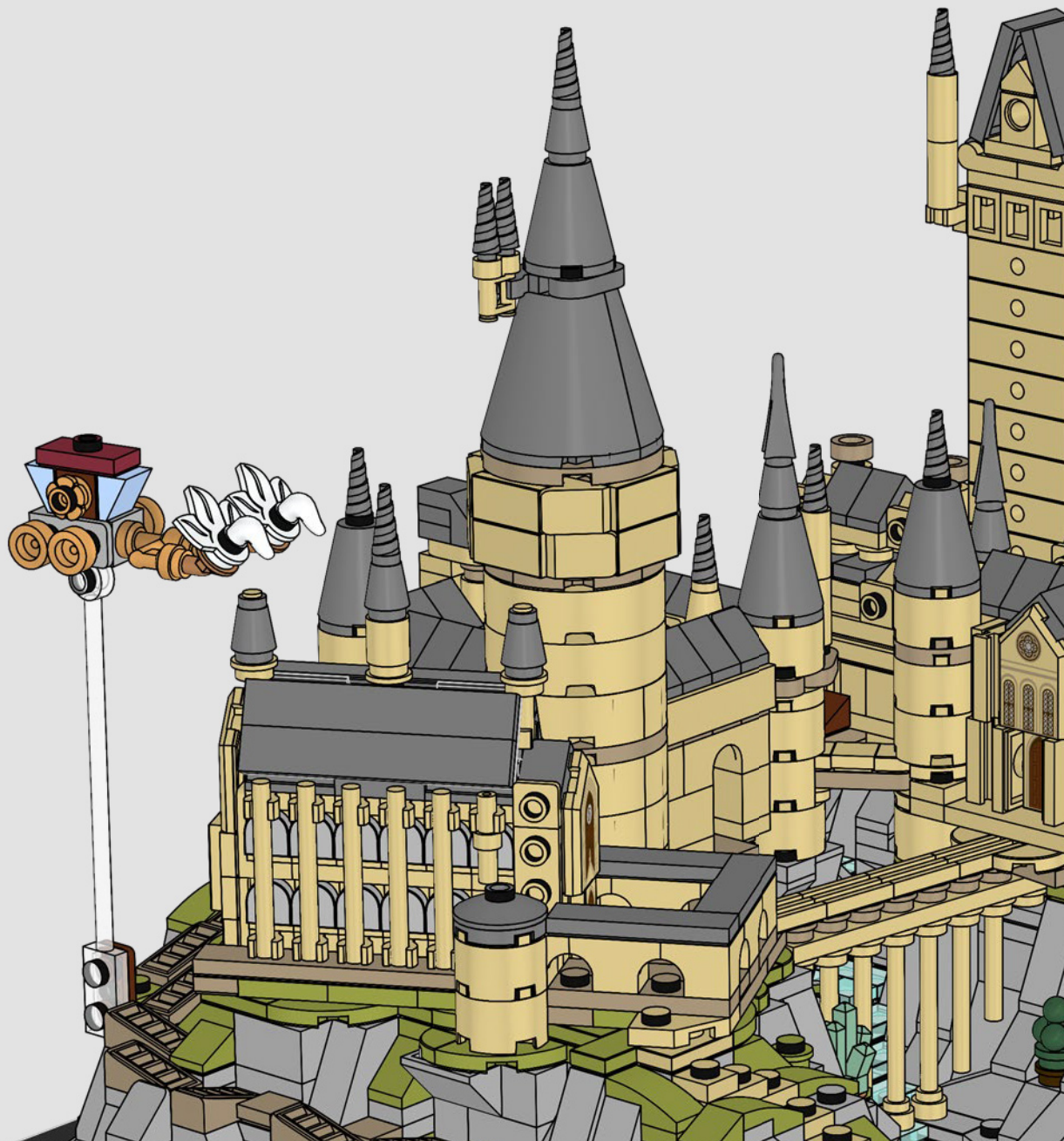

Der Pegasus an  
Beauxbatons' Kutsche  
wird mit weißen  
LEGO® Hörnern und  
Blättern gebaut.  
Siehst du die Zügel?  
Das sind eigentlich  
auf magische Weise  
umfunktionierte  
Kerzenhalter!

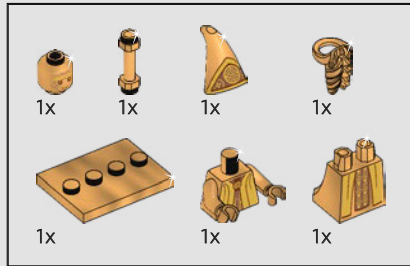

650

1

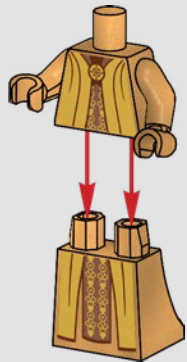

2

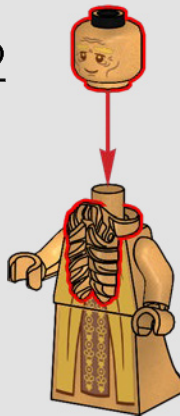

3

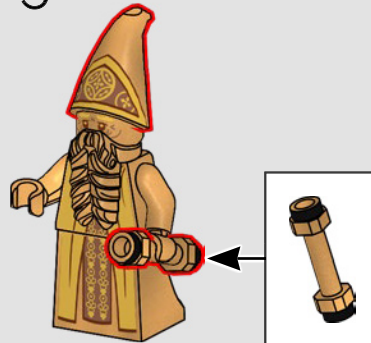

4



Die Minifigur, die den Architekten von Schloss Hogwarts™ darstellt, wurde mit einem neuen Bartelement eigens für dieses Set erschaffen. Und in seinen Händen hält er ein Modell von Hogwarts sowie einen zusammengerollten Bauplan.

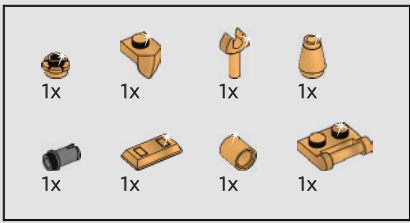

651

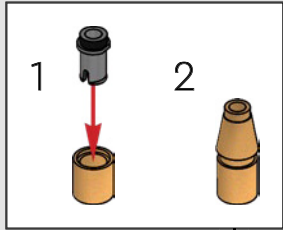

1

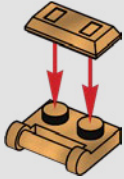

2

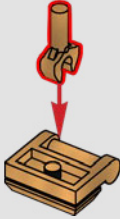

3

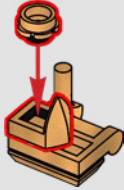

4





Der Architekt von Schloss Hogwarts™ war Ende des 10. Jahrhunderts, Anfang des 11. Jahrhunderts tätig. Über sein Leben oder seine sonstigen Werke ist nicht viel bekannt.







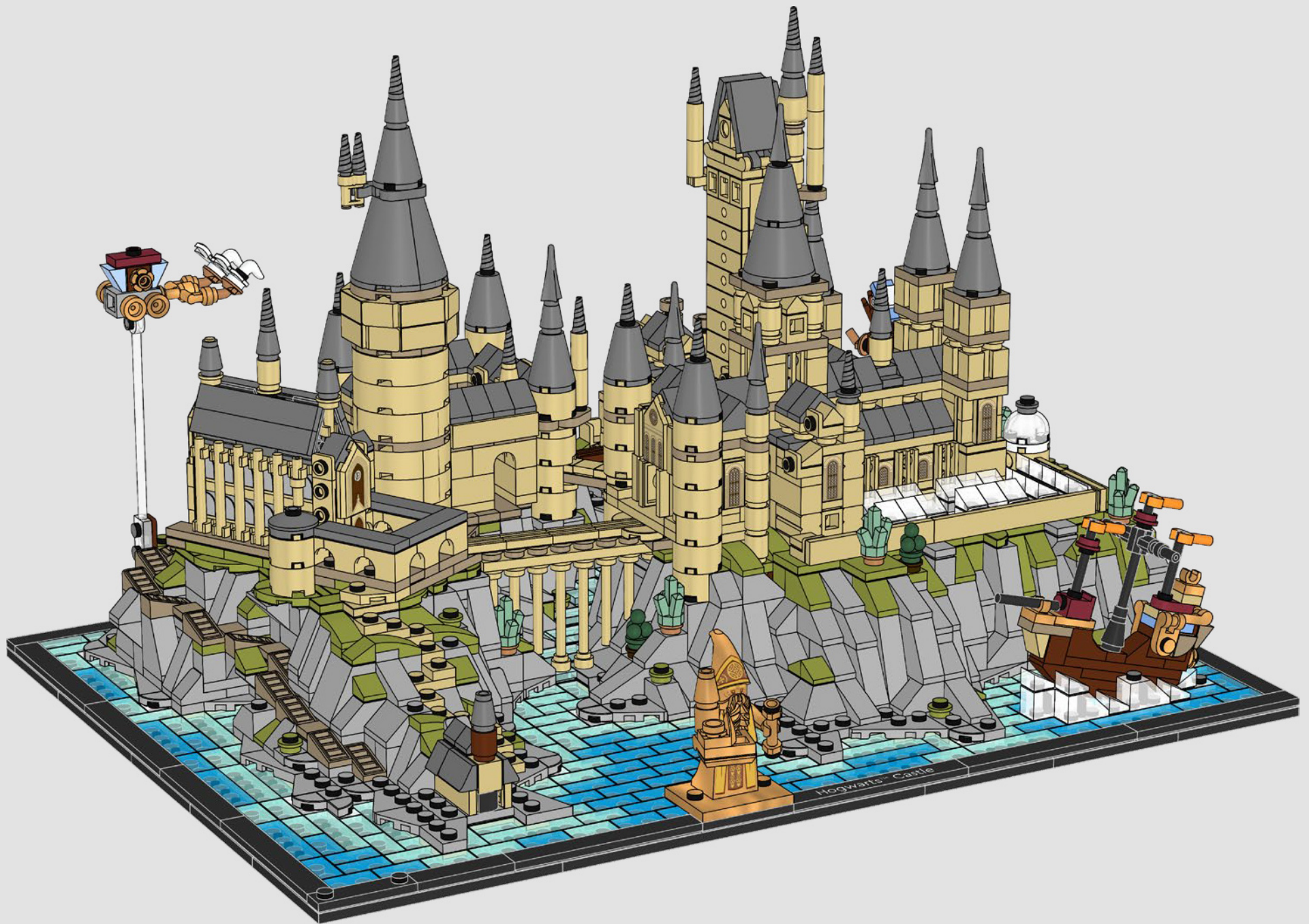

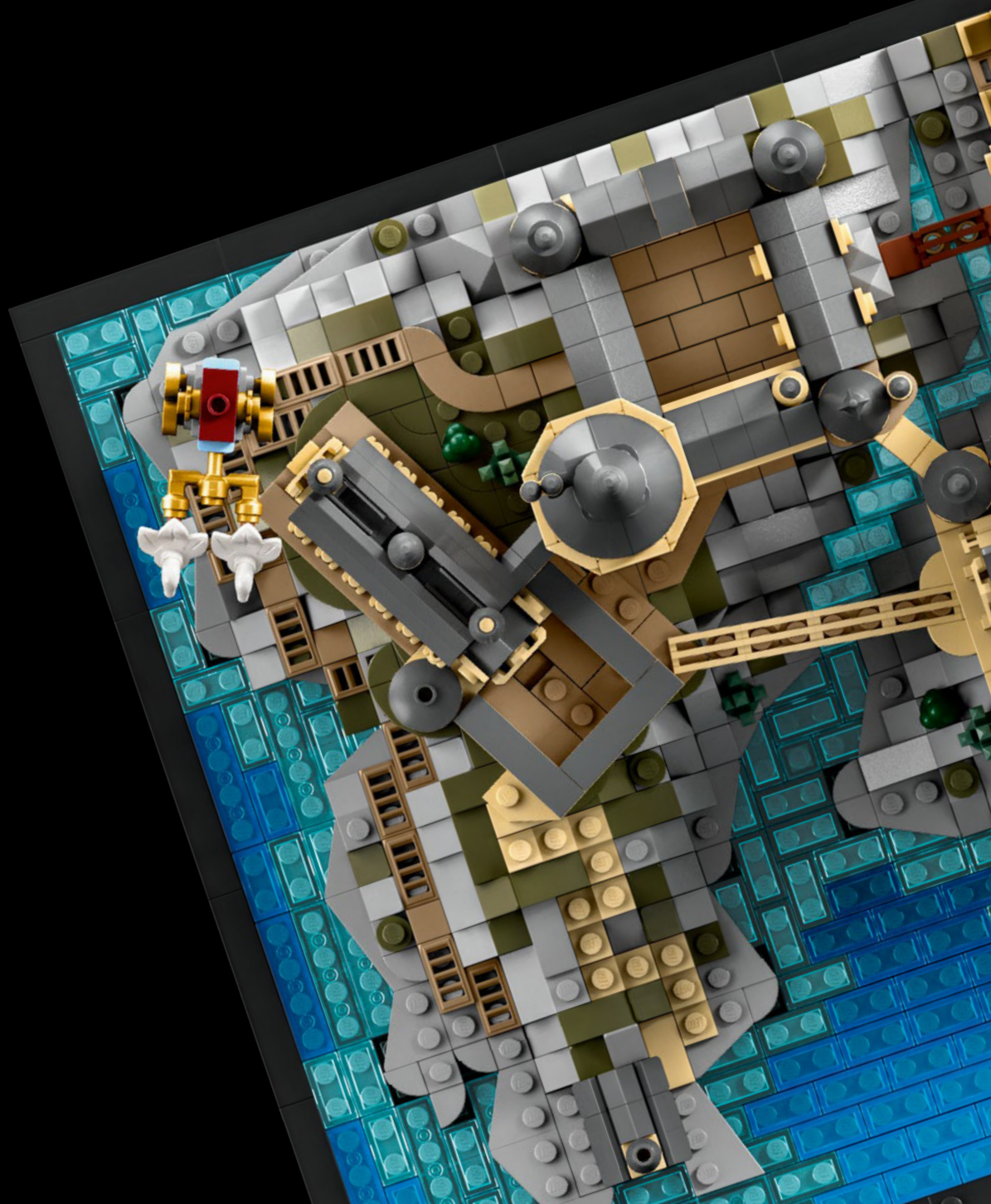

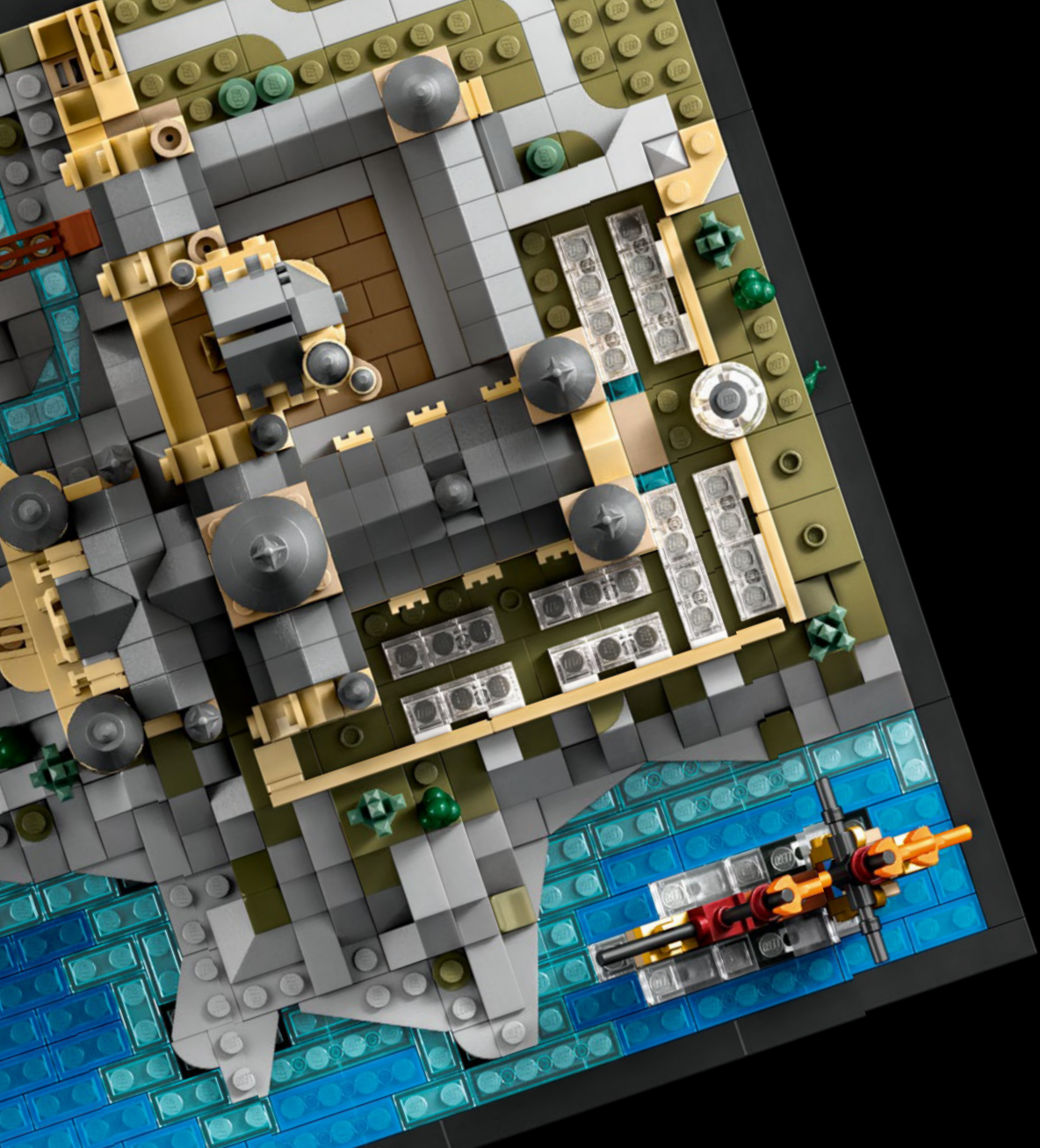

Hogwarts™ Castle



- 2x 614101
- 2x 6186681
- 2x 6328195
- 5x 307001
- 9x 302401
- 1x 6348055
- 8x 6242241
- 2x 4111971
- 2x 6382783
- 1x 6044691
- 1x 403201
- 1x 4667575
- 7x 302301
- 1x 6070698
- 3x 362301
- 11x 6195371
- 1x 4550745
- 1x 246501
- 3x 300201
- 2x 371001
- 2x 300101
- 1x 6222425
- 1x 366601
- 7x 6454936
- 27x 4117070
- 3x 4529237
- 63x 4161734
- 11x 6443061
- 2x 6353196
- 1x 4569547
- 1x 6167923
- 1x 4213568
- 1x 6454440
- 30x 4118793
- 9x 6230284
- 41x 4159553
- 16x 4125253
- 10x 4516055
- 8x 6232135
- 2x 4612603
- 3x 6145570
- 2x 4579260
- 2x 4179771
- 4x 6175968
- 17x 6365720
- 3x 6374151
- 1x 6374192
- 1x 4213568
- 1x 4224793
- 1x 6360037
- 1x 6454941
- 2x 6212758
- 5x 6351413
- 2x 6408047
- 1x 6447501
- 1x 6262018
- 1x 4624086
- 2x 4140562
- 20x 4125220
- 1x 6232037
- 9x 4218749
- 3x 6357613
- 6x 6236425
- 40x 4113917
- 34x 4114026
- 9x 6148262
- 43x 6092587
- 36x 4124456
- 10x 6455327
- 3x 6236914
- 8x 6069165
- 4x 4109995
- 1x 6024495
- 1x 6214334
- 2x 4159279
- 5x 6236423
- 1x 6445058
- 3x 6236425
- 10x 6391523
- 9x 6219794
- 2x 6103001
- 1x 4205107
- 7x 6174925
- 1x 6313611
- 1x 6117975
- 1x 6249809
- 2x 6253003
- 4x 4160483
- 1x 6374166
- 2x 4217562
- 5x 6443062
- 2x 4124455
- 6x 4114077
- 6x 4114306
- 2x 6221467
- 5x 6454937
- 16x 4114084
- 4x 4185177
- 1x 4188866
- 1x 6148265
- 12x 6055868
- 1x 6469454
- 1x 6458487
- 1x 6454439
- 11x 4121921
- 6x 6131896
- 2x 4162465
- 7x 4618651
- 1x 6058093
- 4x 6211966
- 9x 6410762
- 1x 6245271
- 1x 4543858
- 12x 6116614
- 9x 4118790
- 4x 4159739
- 2x 6175367
- 10x 4113233
- 5x 6232136
- 7x 6257600
- 5x 4550324
- 23x 6352222
- 2x 4113916
- 1x 6213676
- 2x 6294592
- 4x 6115031
- 2x 6454935
- 10x 4114309
- 1x 6351905
- 7x 4124067
- 6x 4112982
- 1x 4157277
- 3x 4243824
- 1x 6383728
- 7x 4113993
- 2x 4181134
- 4x 4114324
- 2x 4159774
- 1x 4544139
- 4x 4114001
- 4x 4113988
- 1x 6075179
- 1x 4624185
- 2x 447721
- 2x 611121
- 4x 614121
- 2x 362221
- 1x 302121
- 5x 371021
- 2x 6372124
- 4x 6315780
- 1x 6347604
- 5x 242023
- 5x 301023
- 2x 366623
- 17x 614124
- 6x 362224
- 3x 362324
- 1x 4188313
- 1x 6457333
- 1x 6350055
- 1x 6454443
- 3x 6212377
- 1x 6207933
- 1x 6092594
- 1x 6326425
- 1x 6454437
- 1x 4585493
- 1x 6378168
- 4x 6209691
- 1x 4529247
- 1x 6186672
- 1x 6453281
- 1x 6454435
- 1x 6256803
- 2x 6262138
- 1x 6415995
- 1x 6083975

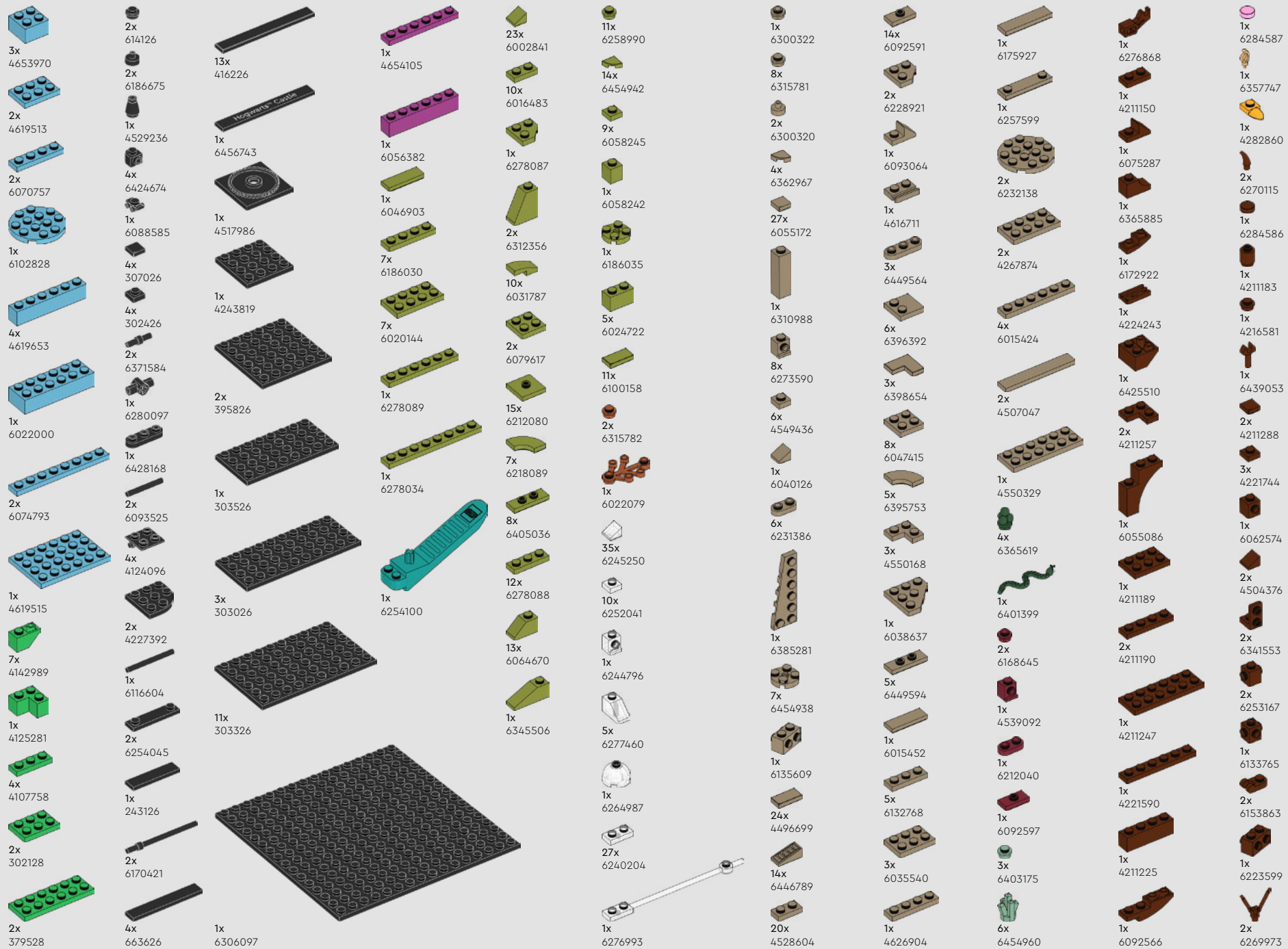

- 1x 4210763
- 2x 6168776
- 4x 4211066
- 2x 6331866
- 3x 4211094
- 1x 6126083
- 1x 6201630
- 10x 6092666
- 1x 6115080
- 1x 4211010
- 2x 6174938
- 17x 6445056
- 6x 6269969
- 15x 4529240
- 2x 6331689
- 1x 4210867
- 2x 4211100
- 8x 4210719
- 1x 4243831
- 1x 6186635
- 2x 4211103
- 3x 6231765
- 2x 4210633
- 1x 6431826
- 3x 6395635
- 4x 6454438
- 1x 4211098
- 5x 6343852
- 4x 4210651
- 4x 6262021
- 2x 4504378
- 2x 6234583
- 2x 6235153
- 7x 6167641
- 4x 6400315
- 51x 6251289
- 8x 6252050
- 1x 4179825
- 1x 6092601
- 1x 6221607
- 1x 6296892
- 45x 4226221
- 3x 4567887
- 14x 4211135
- 1x 4211088
- 3x 6069164
- 2x 6092572
- 3x 4211053
- 1x 4211105
- 1x 4529241
- 1x 6284071
- 3x 6448793
- 21x 6250597
- 1x 6455328
- 5x 4521921
- 23x 4211389
- 5x 6362975
- 12x 6176433
- 3x 6345639
- 2x 6433942
- 12x 6163478
- 6x 4211415
- 2x 4211489
- 1x 4526932
- 9x 4211394
- 1x 6420741
- 6x 4211791
- 5x 4211794
- 1x 6234738
- 18x 4211399
- 1x 6225242
- 46x 4211614
- 1x 6347715
- 3x 6258381
- 2x 4568637
- 2x 6075075
- 15x 4211488
- 2x 6211969
- 12x 4211428
- 7x 6116608
- 4x 6066097
- 5x 6186657
- 1x 4216248
- 3x 6308012
- 4x 6065824
- 1x 4651063
- 1x 6469440
- 1x 6269049
- 40x 4515374
- 12x 4211437
- 6x 4657459
- 2x 4211773
- 10x 4211445
- 13x 6093859
- 11x 4211494
- 46x 4211398
- 9x 4211414
- 2x 6170387
- 1x 4211564
- 2x 6123809
- 5x 4234535
- 8x 4211353
- 2x 4211410
- 1x 6163990
- 11x 4211396
- 2x 4211356
- 1x 6213378
- 13x 6435857
- 14x 4211349
- 11x 4211387
- 1x 4216250
- 3x 4211397
- 1x 6177078
- 1x 6126082
- 18x 4211429
- 8x 4211386
- 2x 6435930
- 1x 6306729
- 4x 6163477
- 1x 4645397
- 3x 4558169
- 1x 6075066
- 3x 4211438
- 2x 4211393
- 1x 4618874
- 2x 4243797
- 2x 4211549
- 1x 6015347
- 7x 4211385
- 2x 4211395
- 1x 6372029
- 1x 4211392
- 6x 4211404
- 1x 6037399
- 1x 4211474
- 3x 4251149
- 2x 4211521
- 2x 4211407
- 3x 6059033
- 3x 4211452
- 1x 4211795
- 2x 4211425
- 6x 4157103
- 3x 6439042
- 3x 4173805
- 16x 4121739
- 17x 4220634
- 23x 4164037
- 10x 6254256
- 85x 6251295
- 3x 6343877
- 11x 6252049
- 1x 4211522
- 1x 4211402
- 1x 4211405

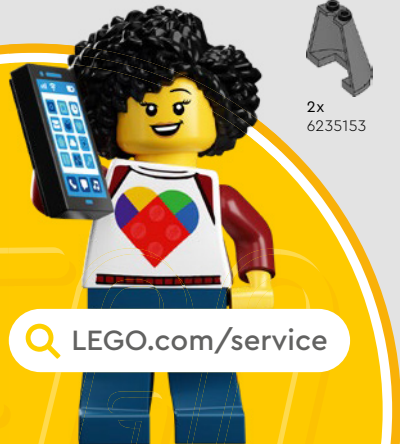

 [LEGO.com/service](https://www.LEGO.com/service)



# YOU COULD WIN



## YOU COULD WIN

Your feedback will help shape the future development of this product series.

Visit:

## DU KÖNNTEST GEWINNEN

Dein Feedback trägt zur Weiterentwicklung dieser Produktreihe bei.

Geh auf:

## VOUS POURRIEZ GAGNER

Vos commentaires nous aideront à concevoir les futurs produits de cette gamme.

Visitez :

## POTRESTI VINCERE TU

La tua opinione ci aiuterà a migliorare la creazione futura di questa linea di prodotti.

Visita:

## PUEDES GANAR

Tu opinión contribuirá al futuro de esta serie de productos.

Visita:

## 轻松获奖

您的反馈将有助于我们在今后改进本产品系列。

请访问:

---

[LEGO.com/productfeedback](https://LEGO.com/productfeedback)

---

You also have the chance to win a LEGO® set.

Terms and conditions apply.\*

Außerdem hast du die Chance, ein LEGO® Set zu gewinnen.

Es gelten die Teilnahmebedingungen.\*

Vous pourriez également gagner un ensemble LEGO®.

Des conditions s'appliquent.\*

Hai anche la possibilità di vincere un set LEGO®.

Termini e condizioni sono applicabili.\*

También tienes la oportunidad de ganar un set LEGO®.

Aplican términos y condiciones.\*

您还有机会赢取乐高®套装。

条款和条件适用。\*

\*[LEGO.com/productfeedback-terms](https://LEGO.com/productfeedback-terms)

# II

LEGO and the LEGO logo are trademarks of the LEGO Group. ©2023 The LEGO Group.

WIZARDING WORLD and all related trademarks, characters, names, and indicia are  
© & ™ Warner Bros. Entertainment Inc. Publishing Rights © JKR. (s23)