

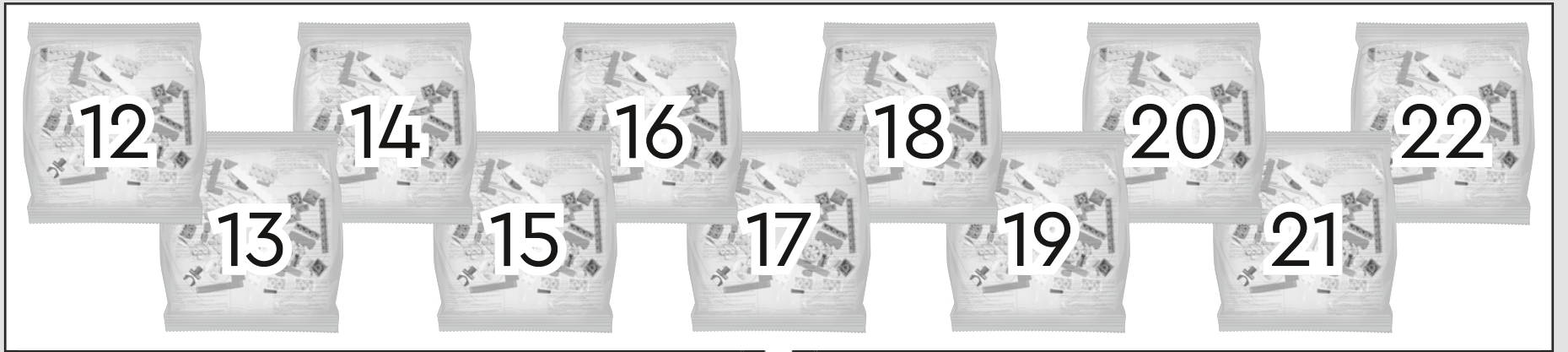

Harry Potter



WIZARDING  
WORLD





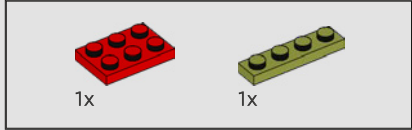
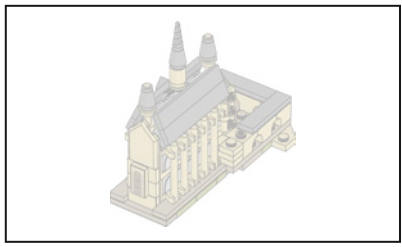

309

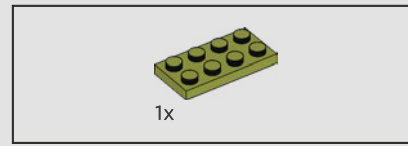
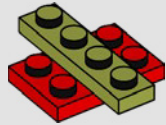

310

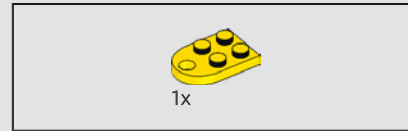
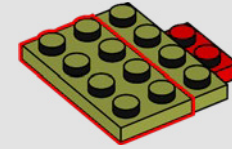

311

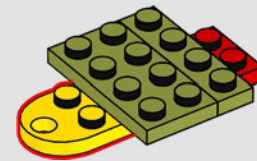

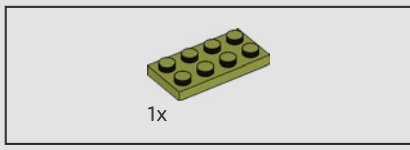

312

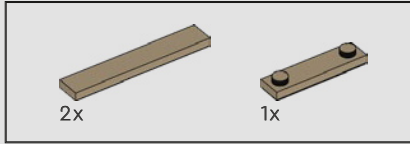
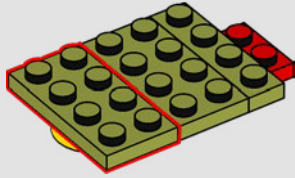

313

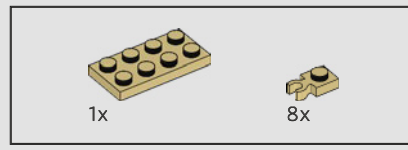
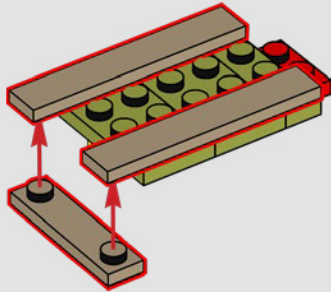

314

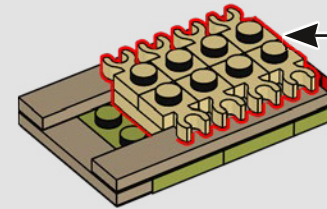
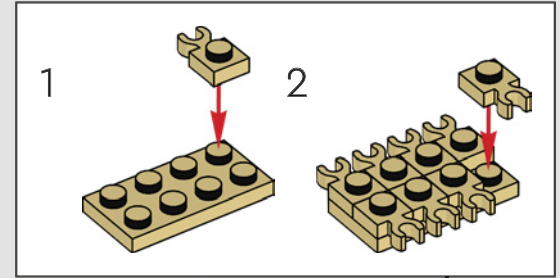

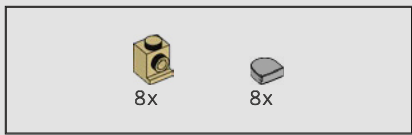

315

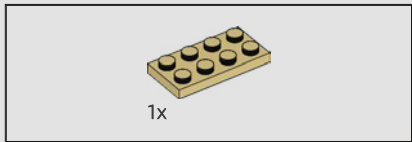
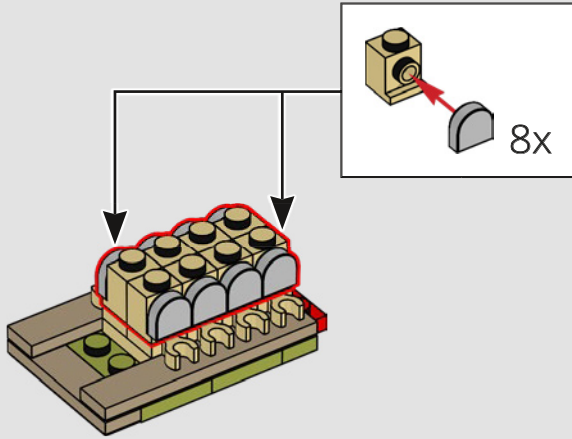

316

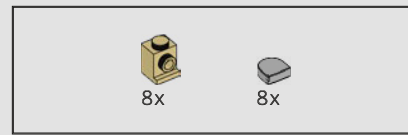
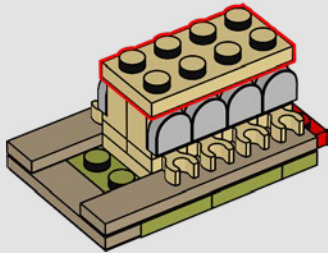

317

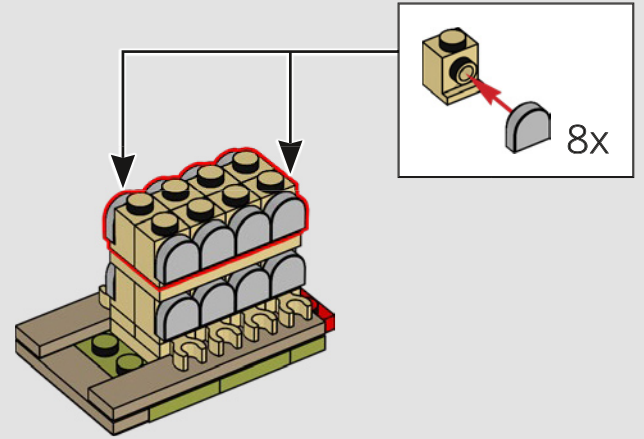

318

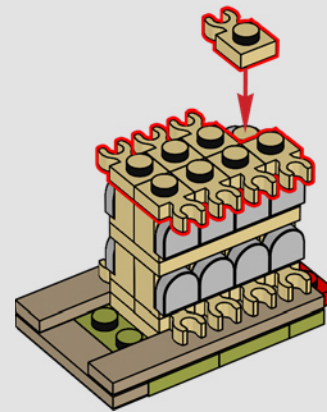

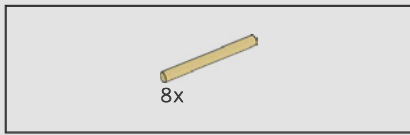

319

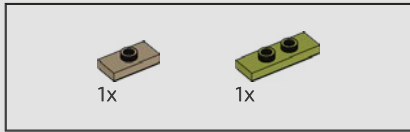
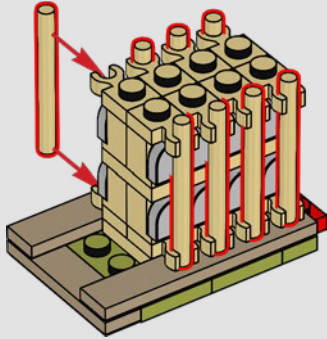

320

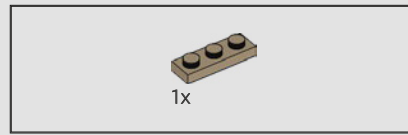
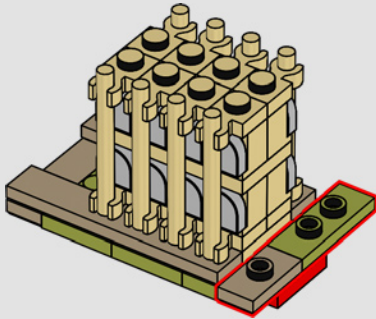

321

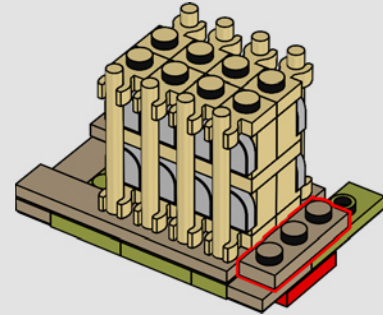

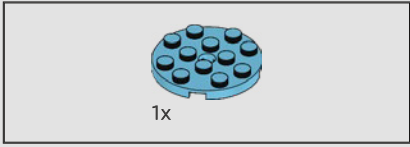
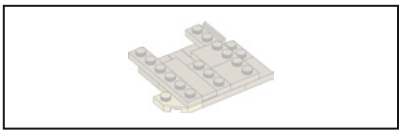

322

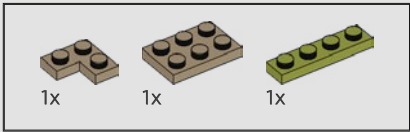
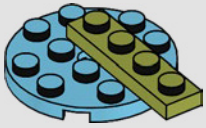

323

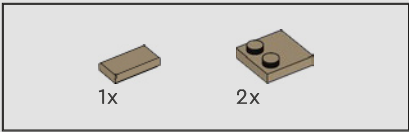
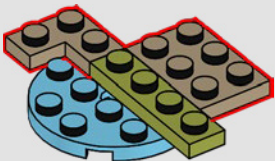

324

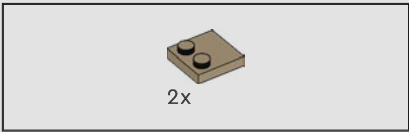
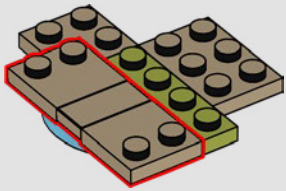

325

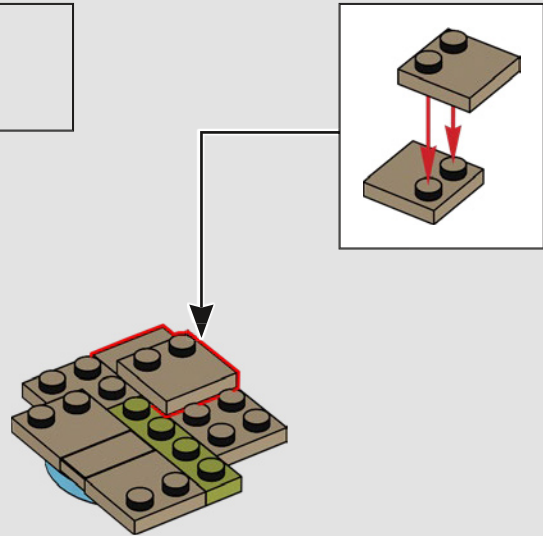



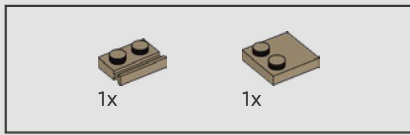

326

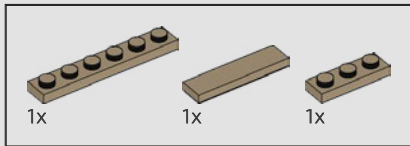
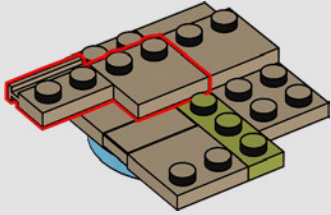

327

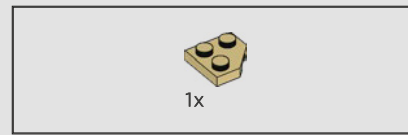
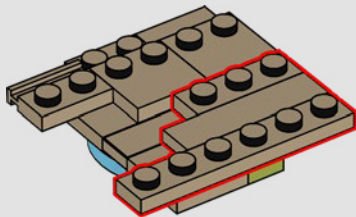

328

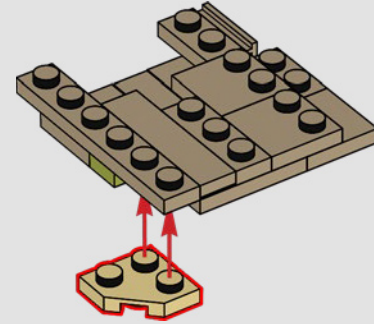

329

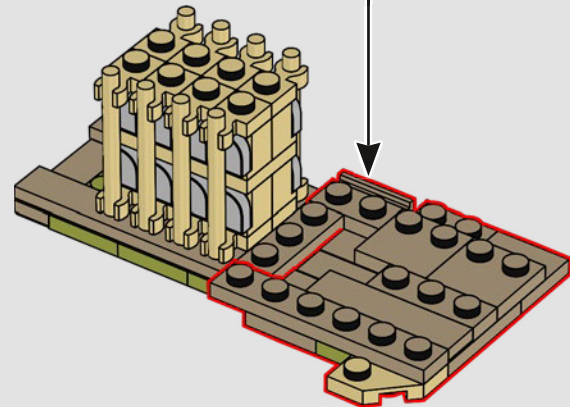



330

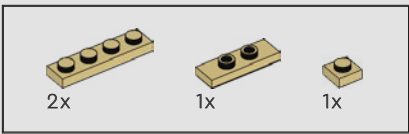
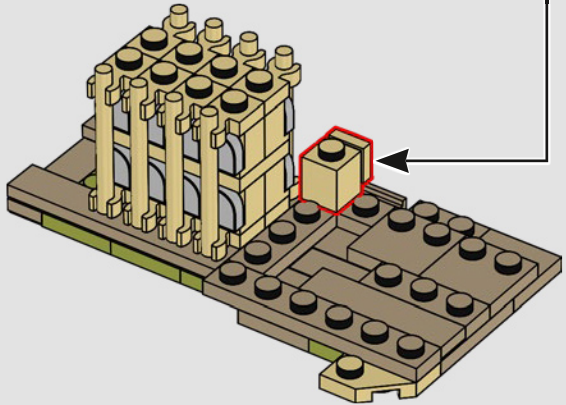
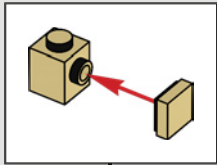

331

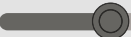
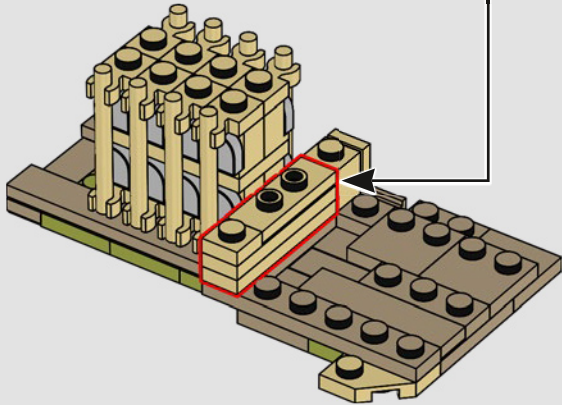
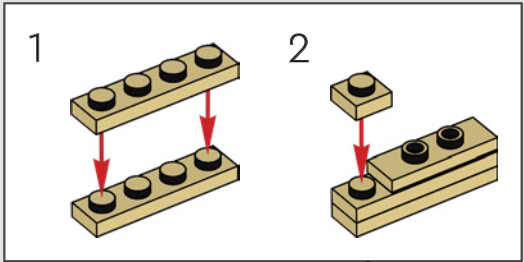

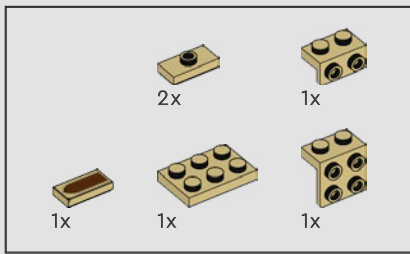

332

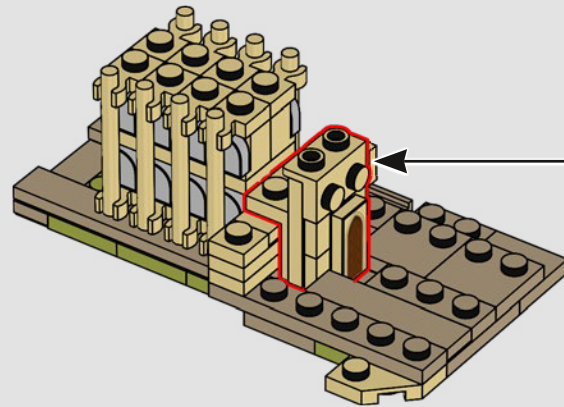
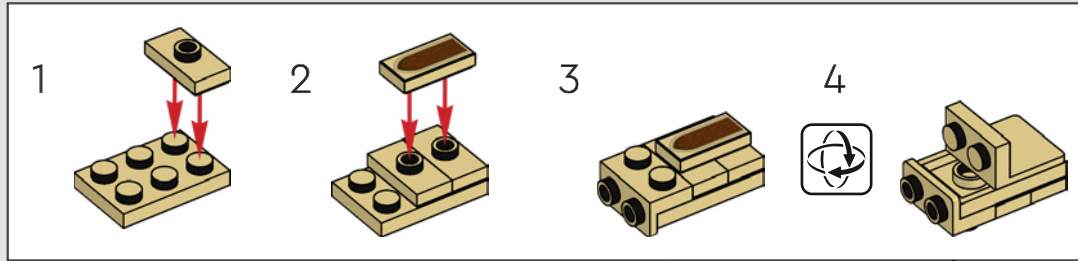



333

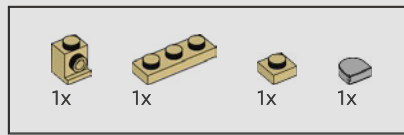
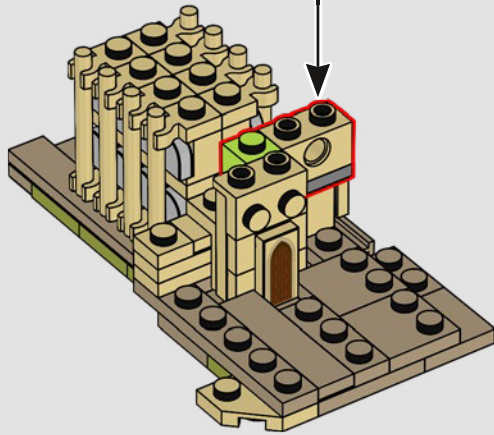
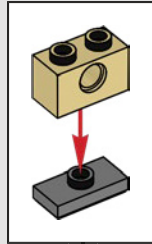

334

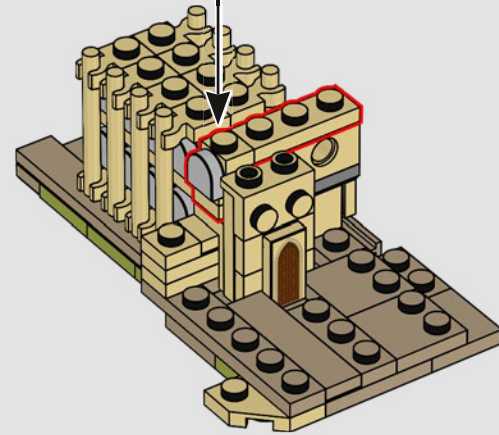
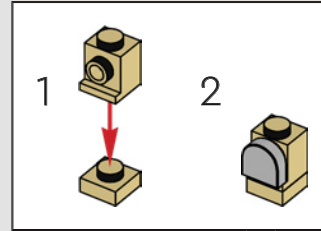



335

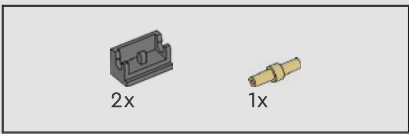
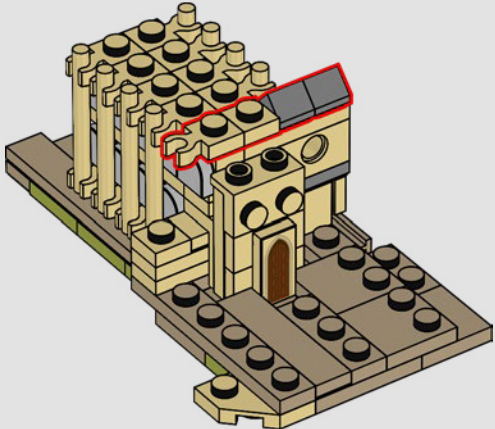

336

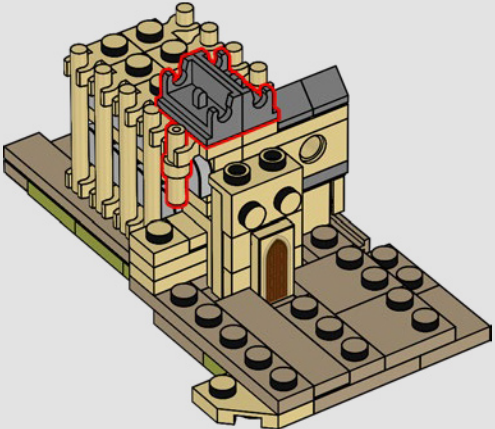

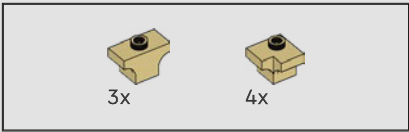

337

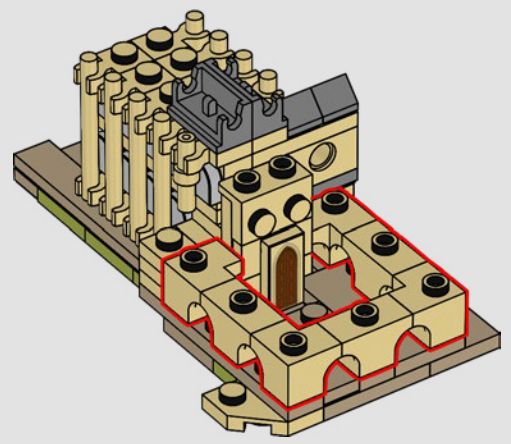

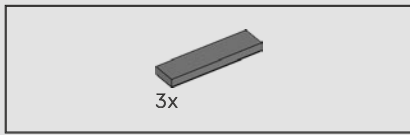

338

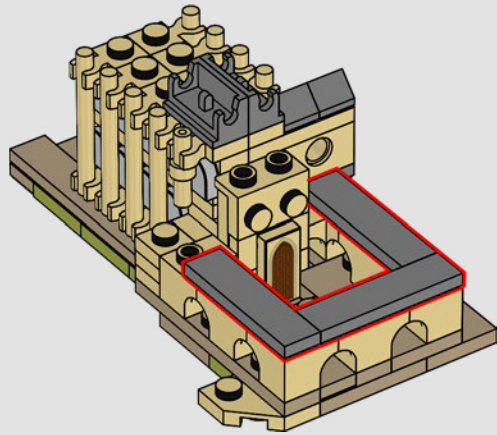

339

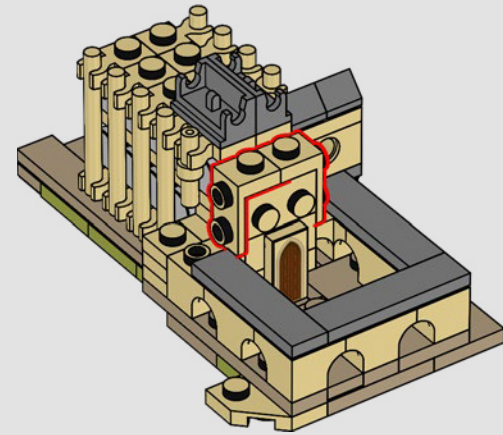



340

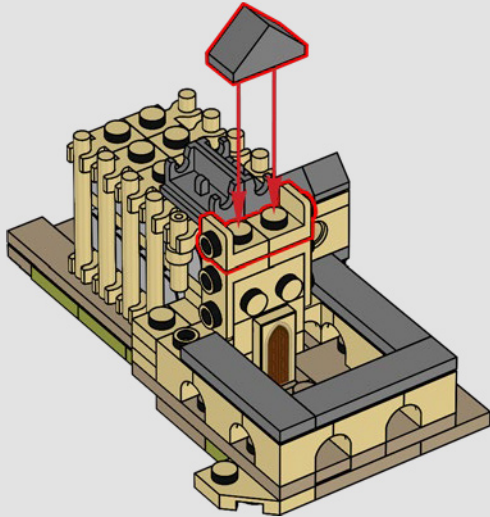

341

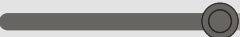
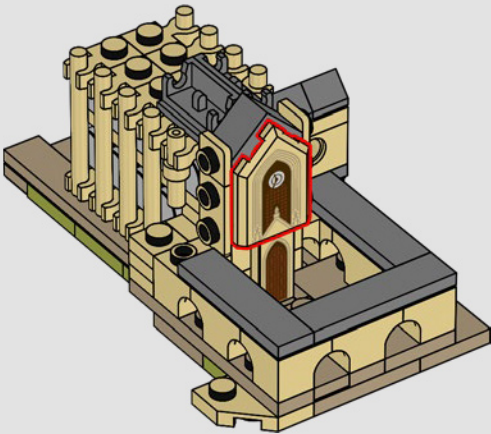



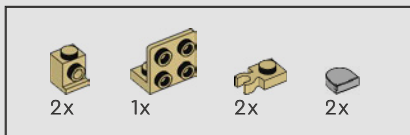

342

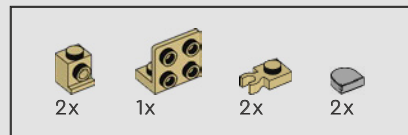
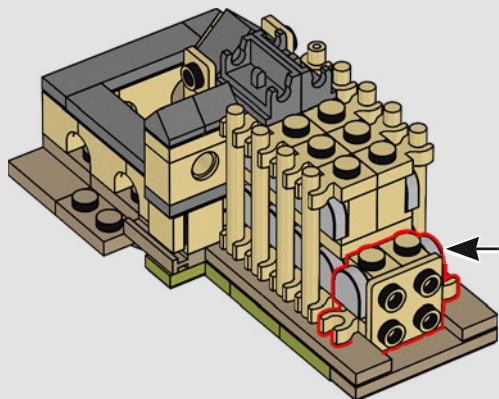
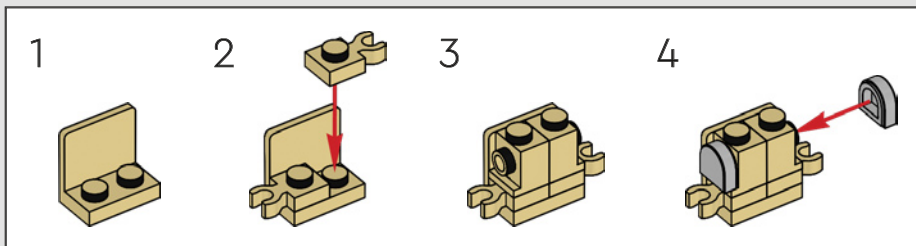

343

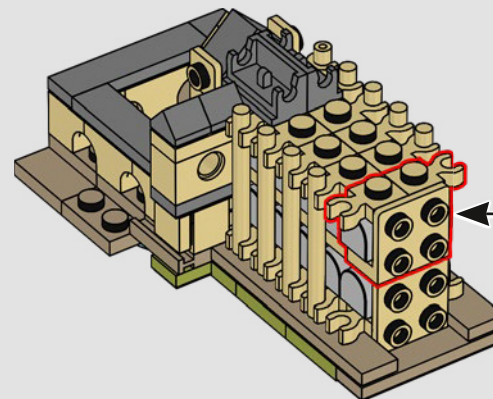
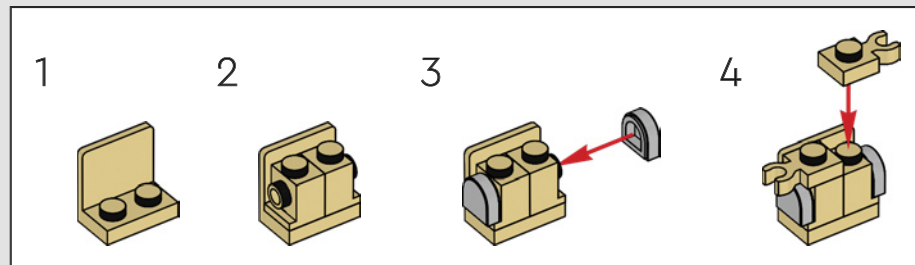

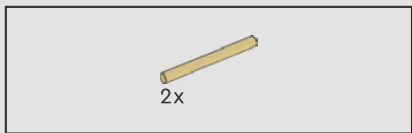

344

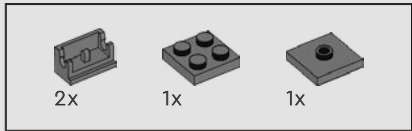
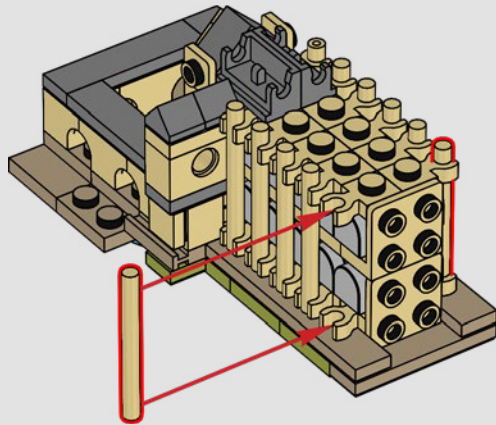

345

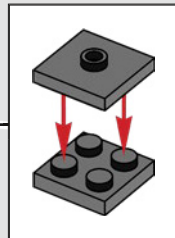
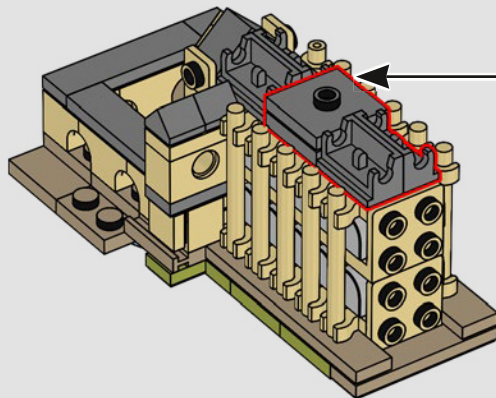

346

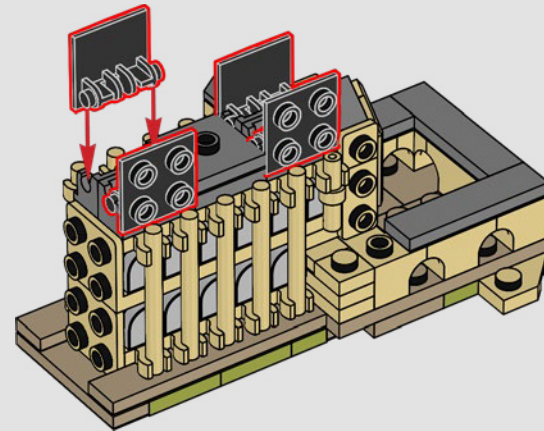

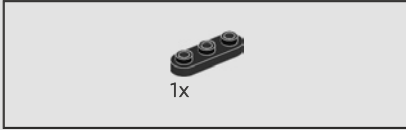
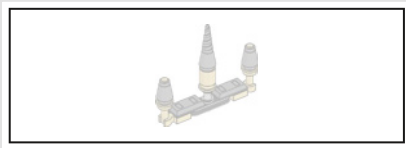

1x

347

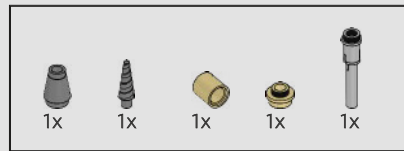

348

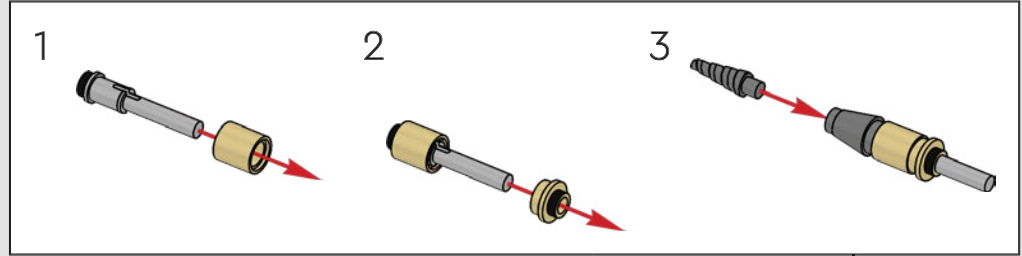



349

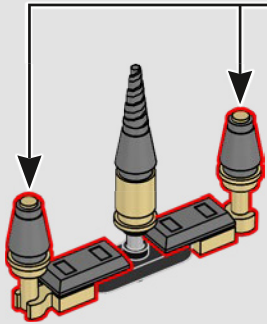
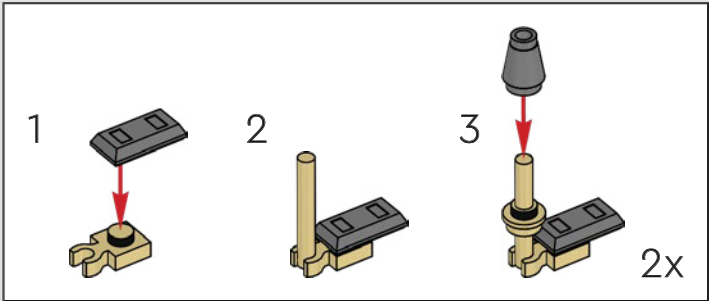

350

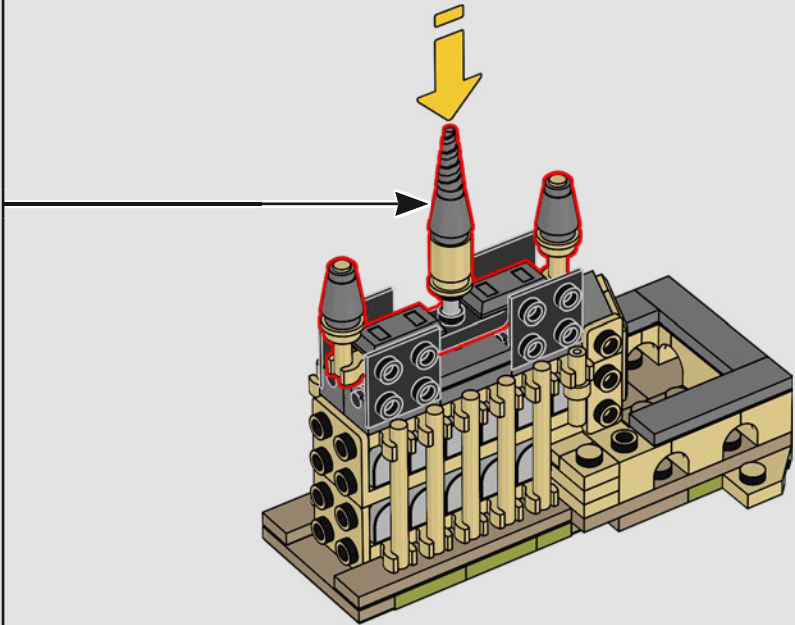

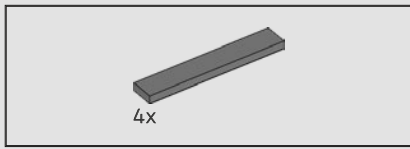

351

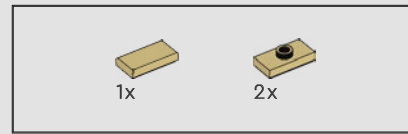
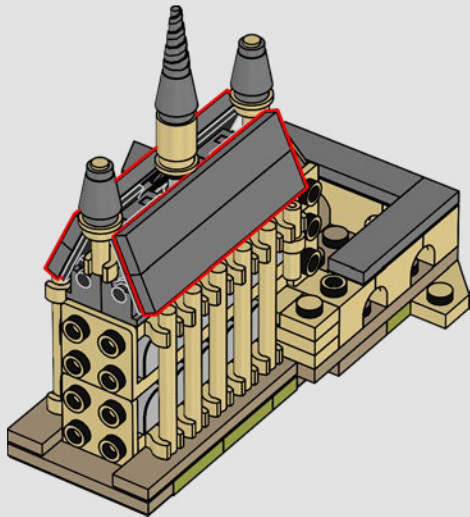

352

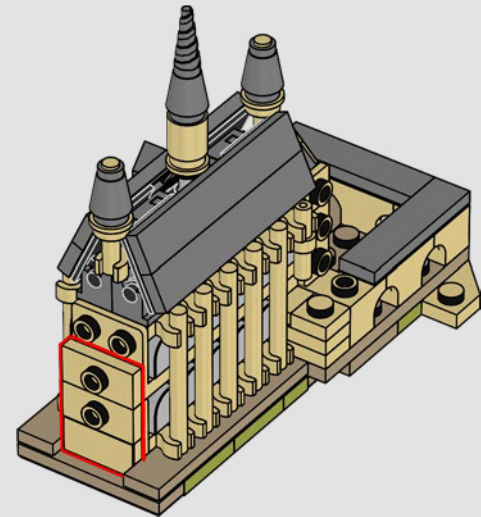

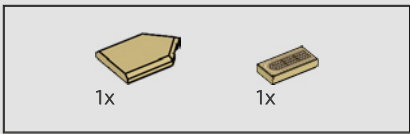

353

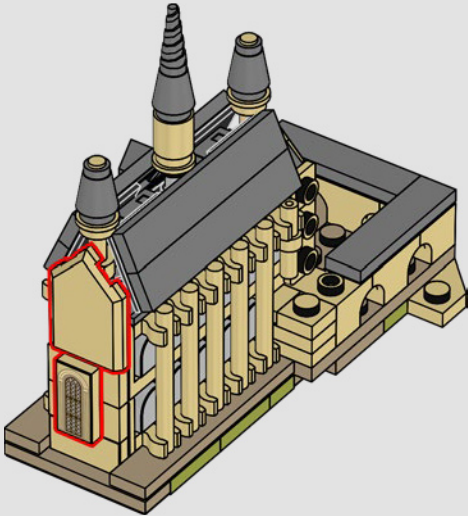

The ceiling in the Great Hall can be enchanted to mimic the night sky.

354

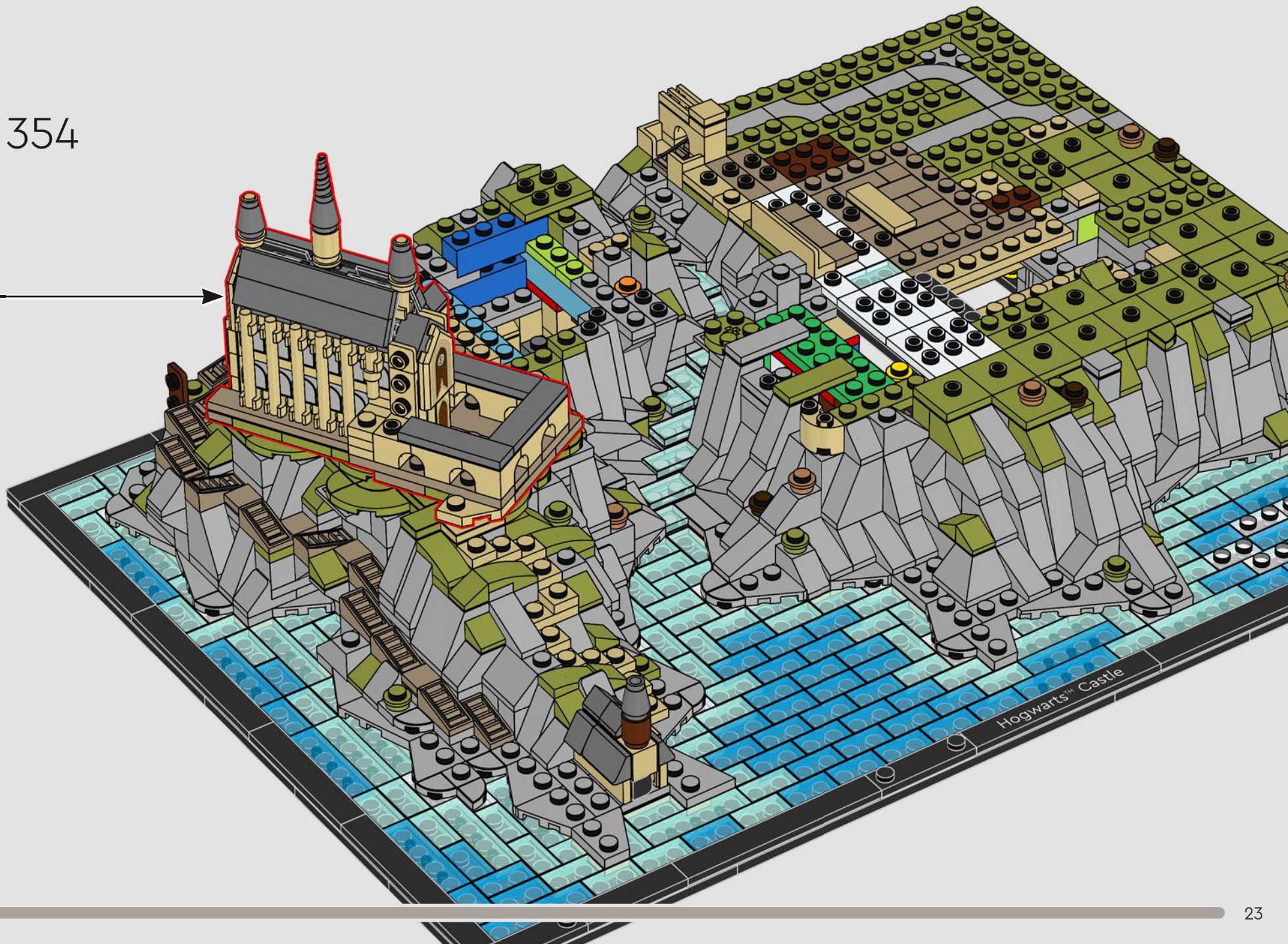

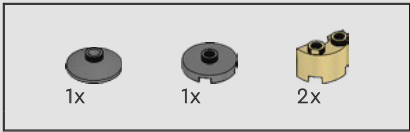

355

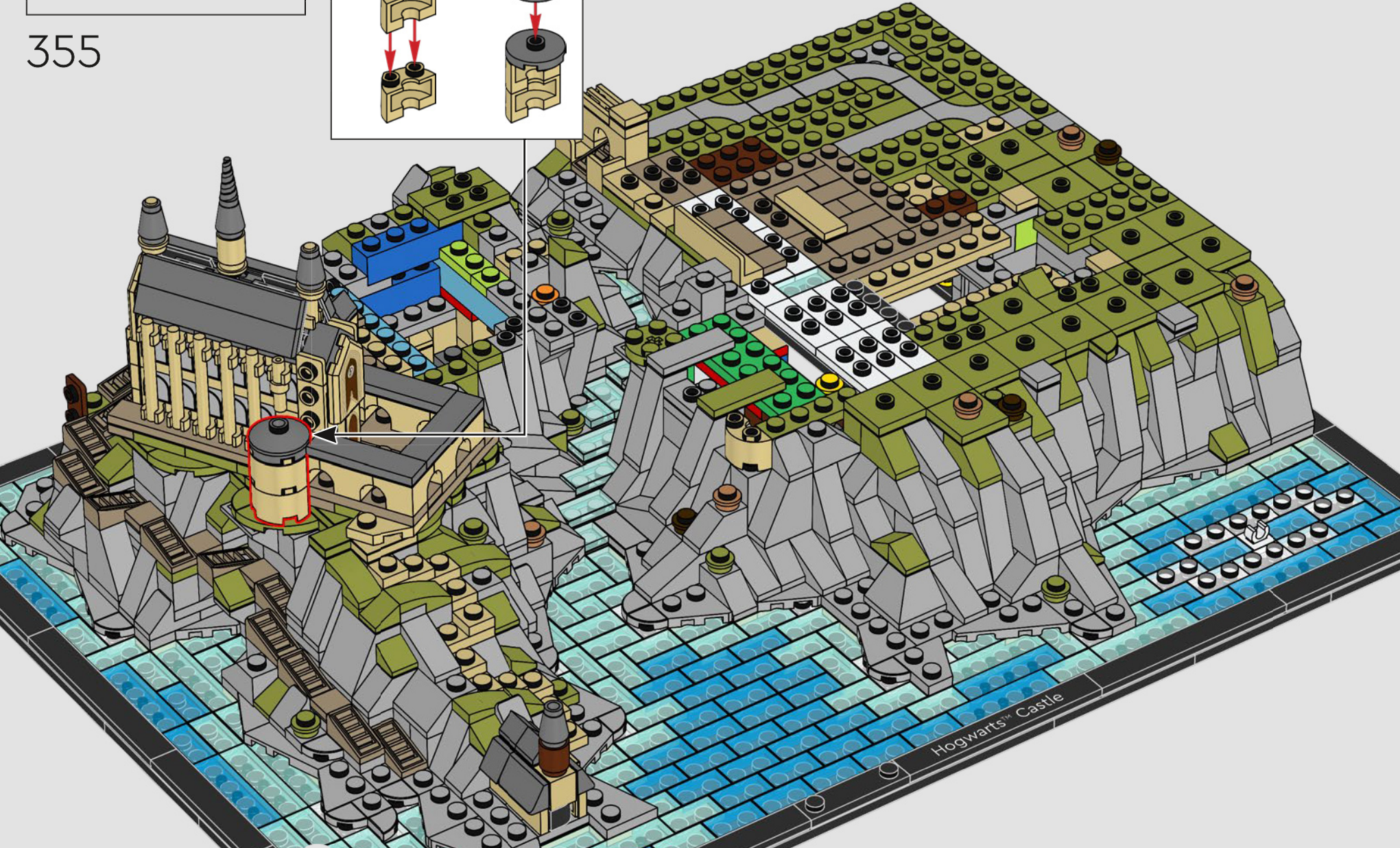
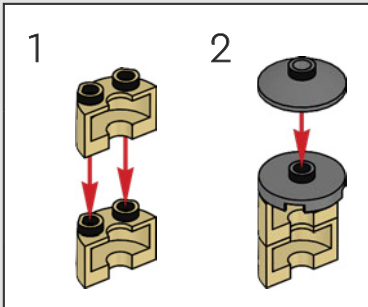



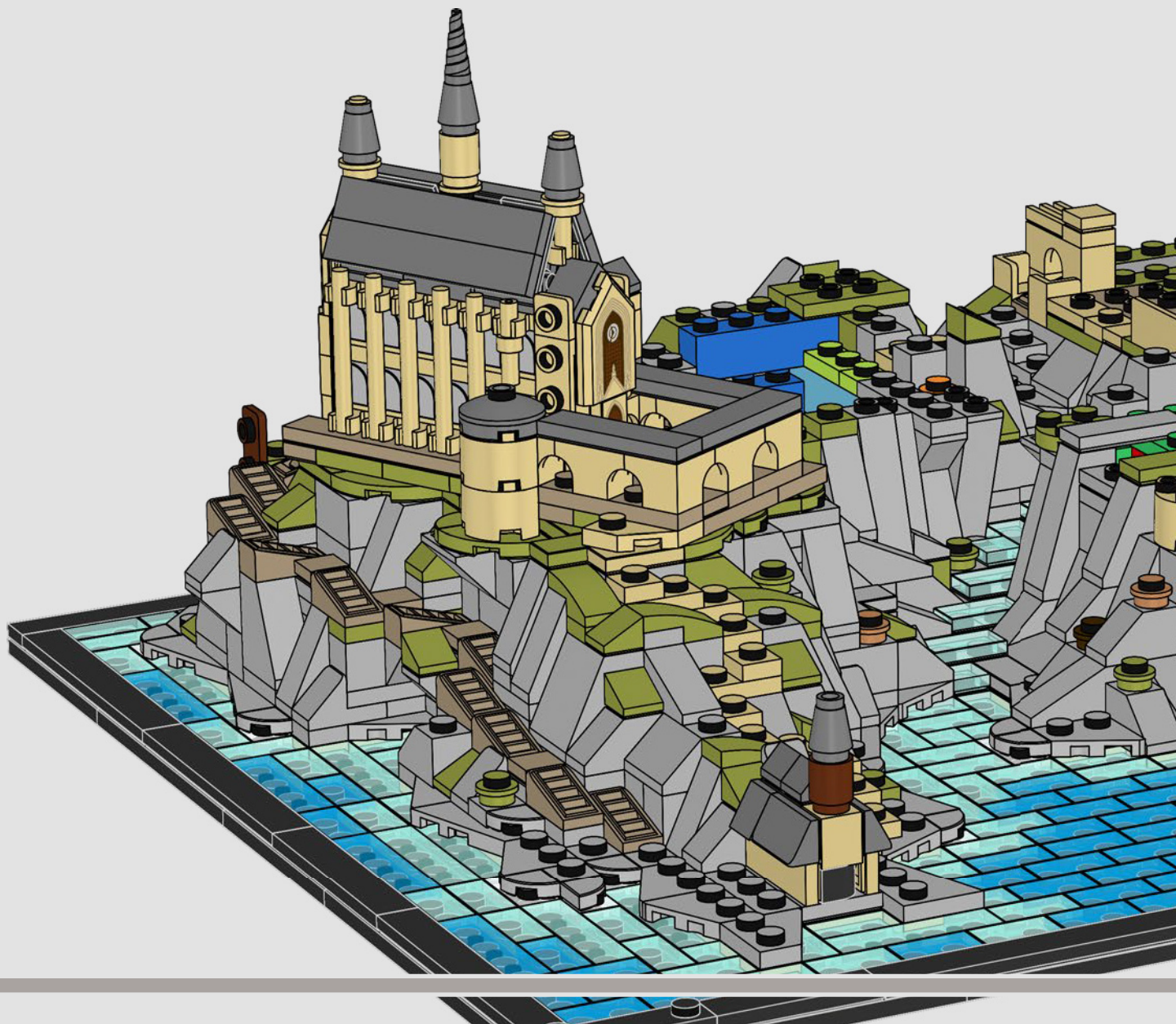

Immediately after arriving at Hogwarts™, first-year students are shown to the Great Hall where The Sorting Hat™ determines which house will be their home away from home.



356



The trees are built with LEGO® crystal and ice cream elements (and a little magic).

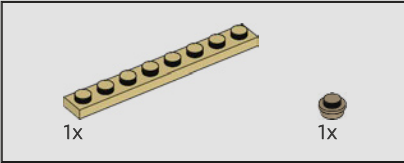
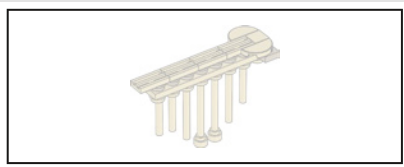

357

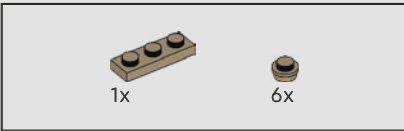
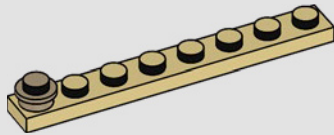

358

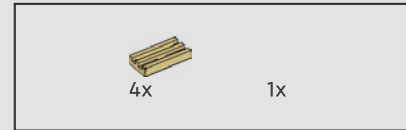
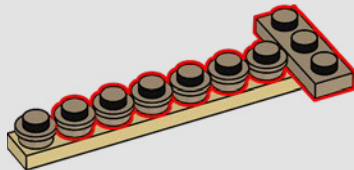

359

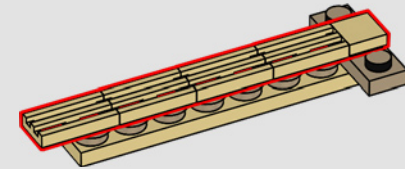

360

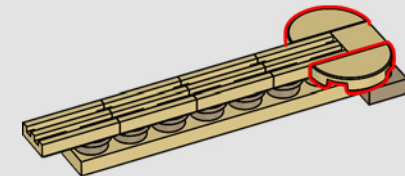

8x

361

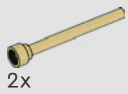
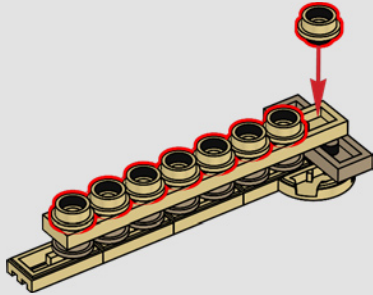

2x

362

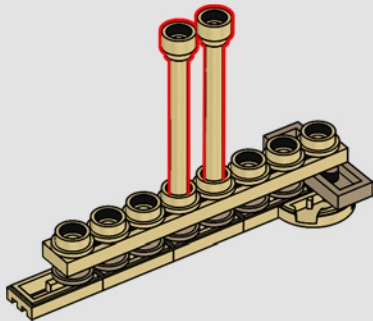

2x

3x

363

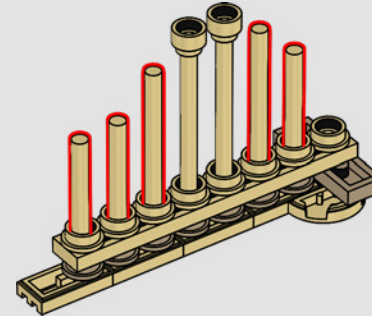

364



Hogwarts™ Castle

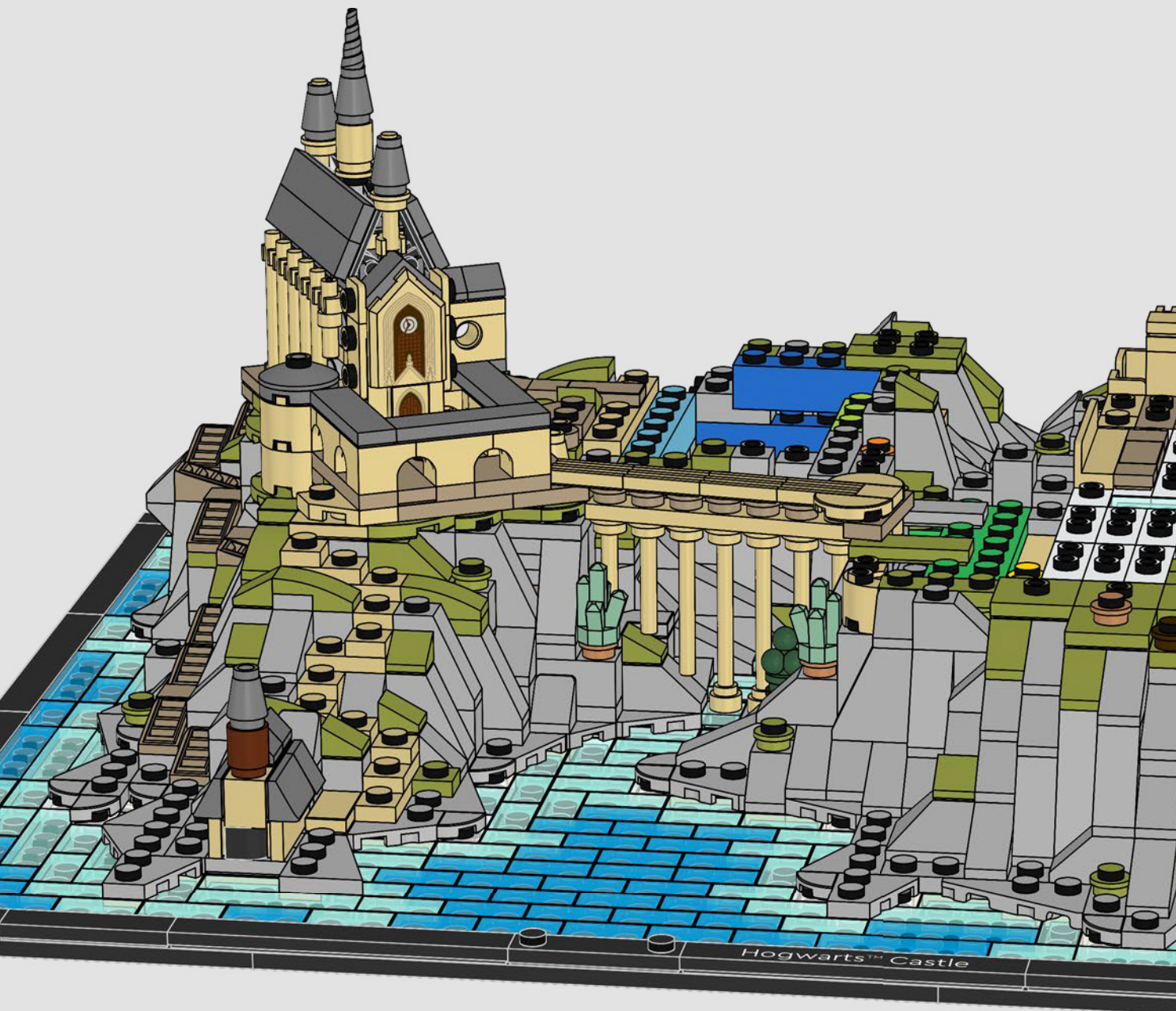

The Viaduct Bridge is not only iconic to the Hogwarts™ silhouette, but is also a central location during the Battle of Hogwarts: when Professor McGonagall™ enchants the suits of armour to do their duty to the school by protecting everyone inside, they head towards the bridge. It is also the setting for a key moment during the First Task of the Triwizard Tournament, when the Hungarian Horntail soars underneath it to chase Harry.





365







2x

366

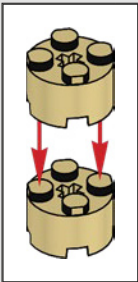
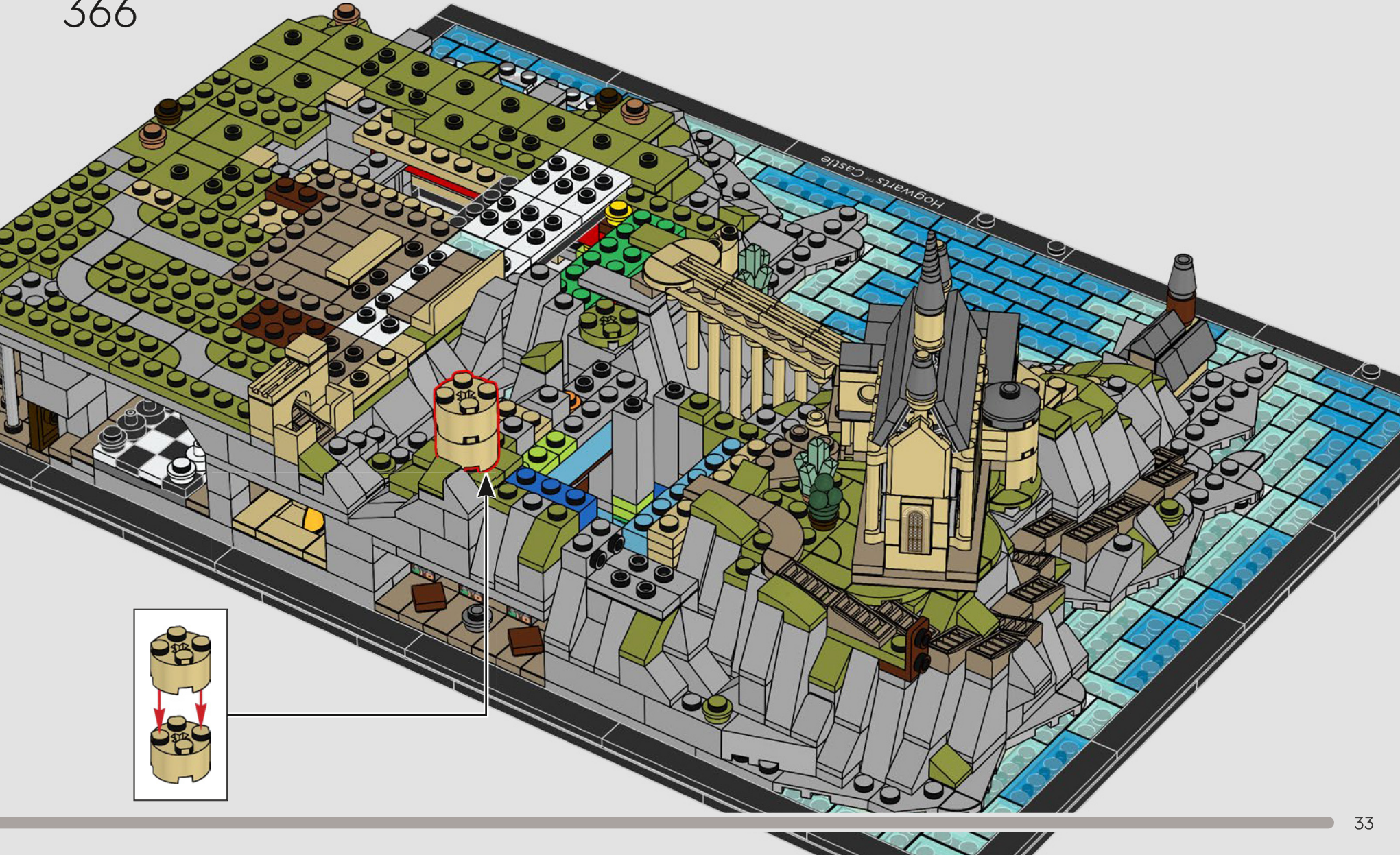

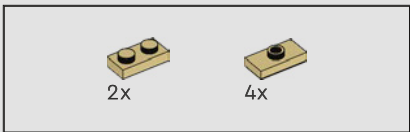

367

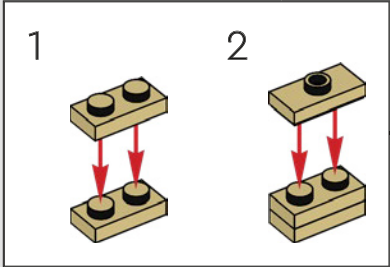
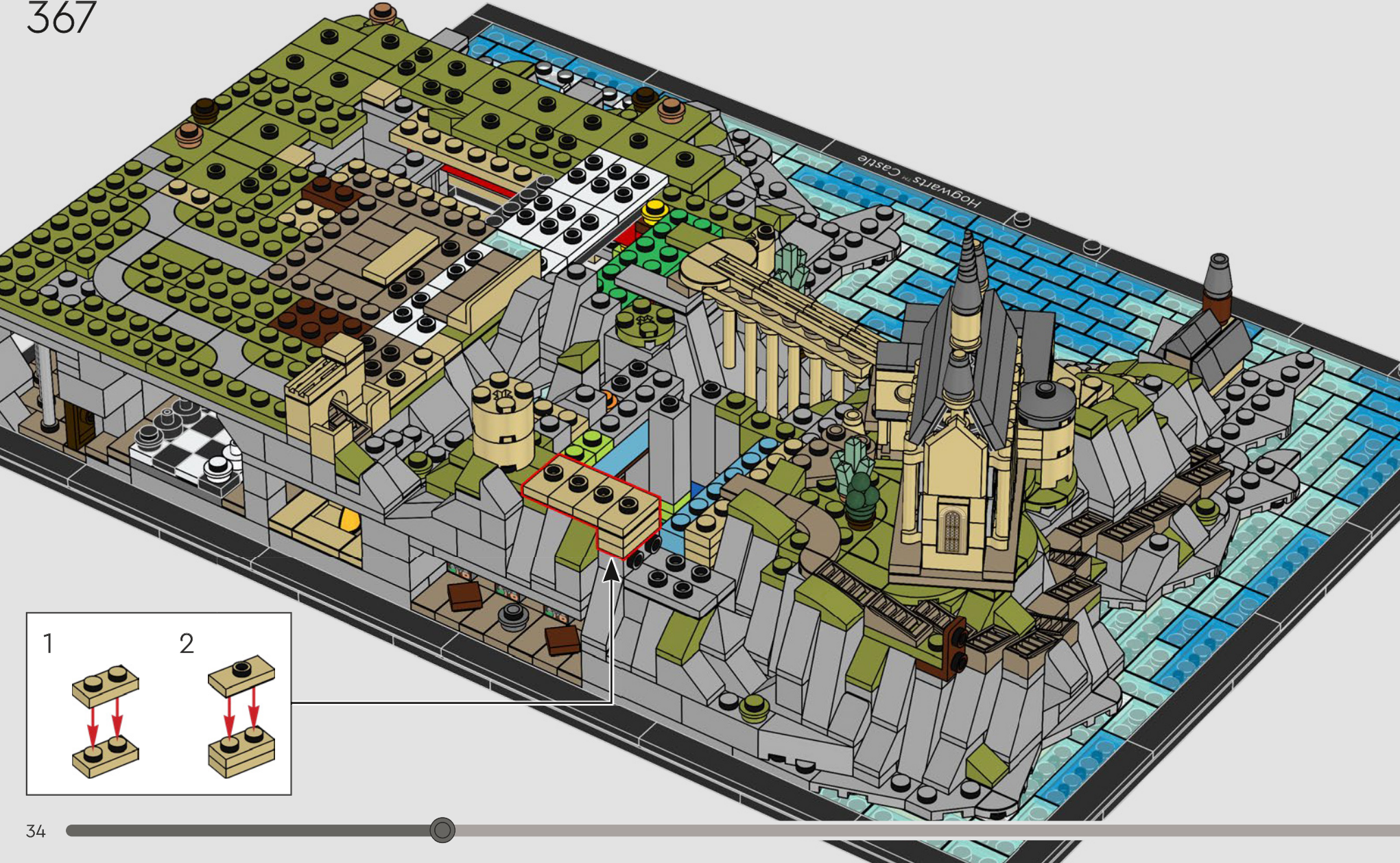

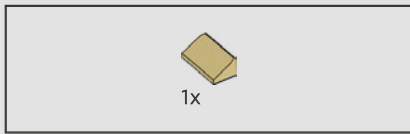

368

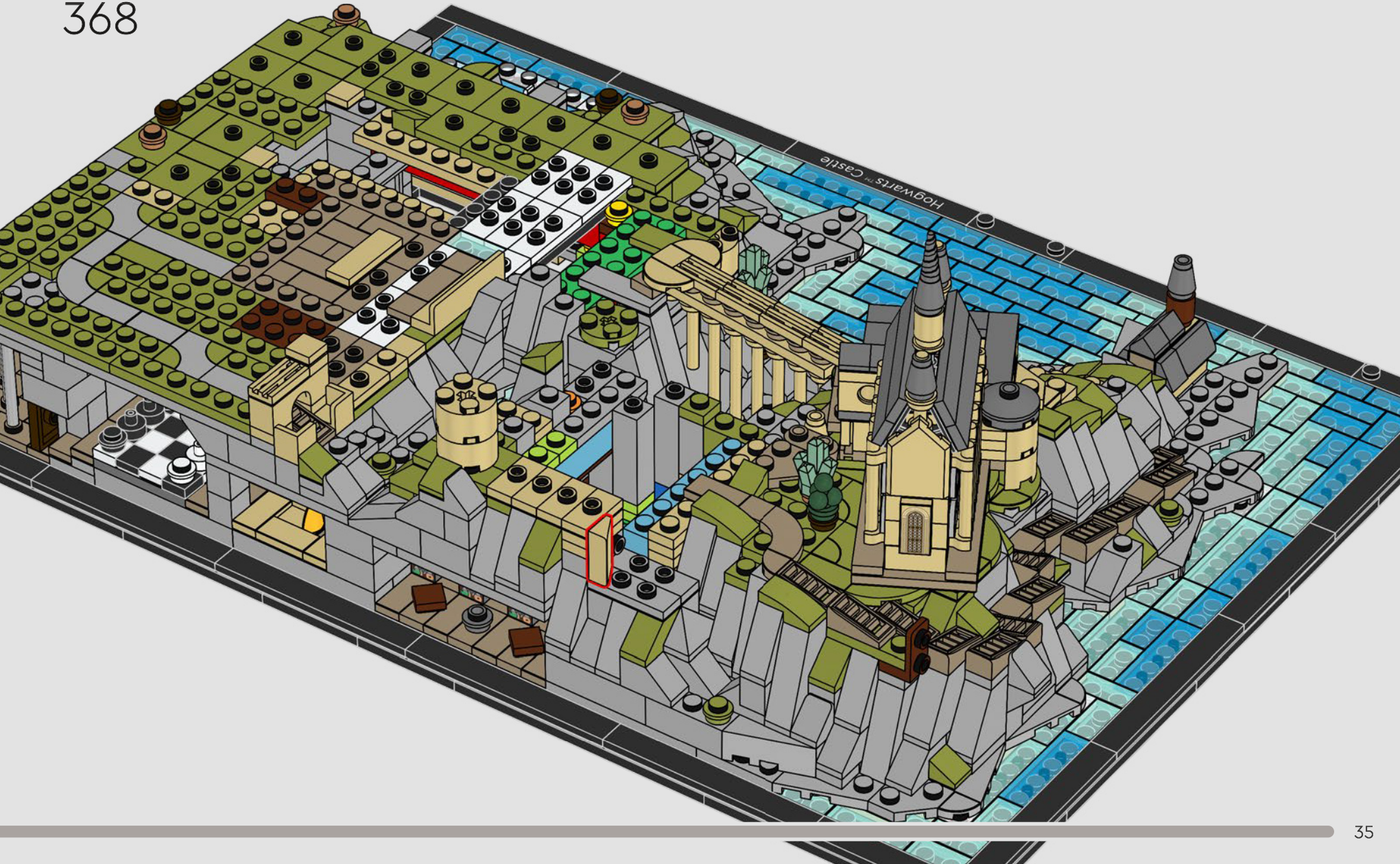

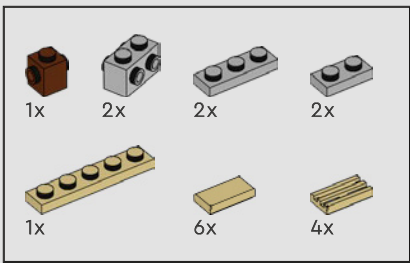

369

1

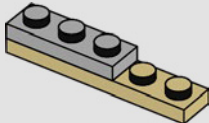

2

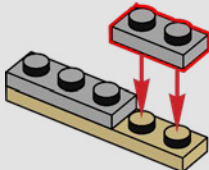

3

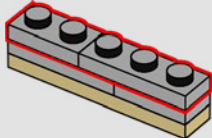

4

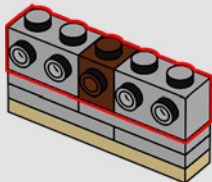

5

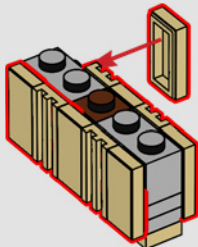

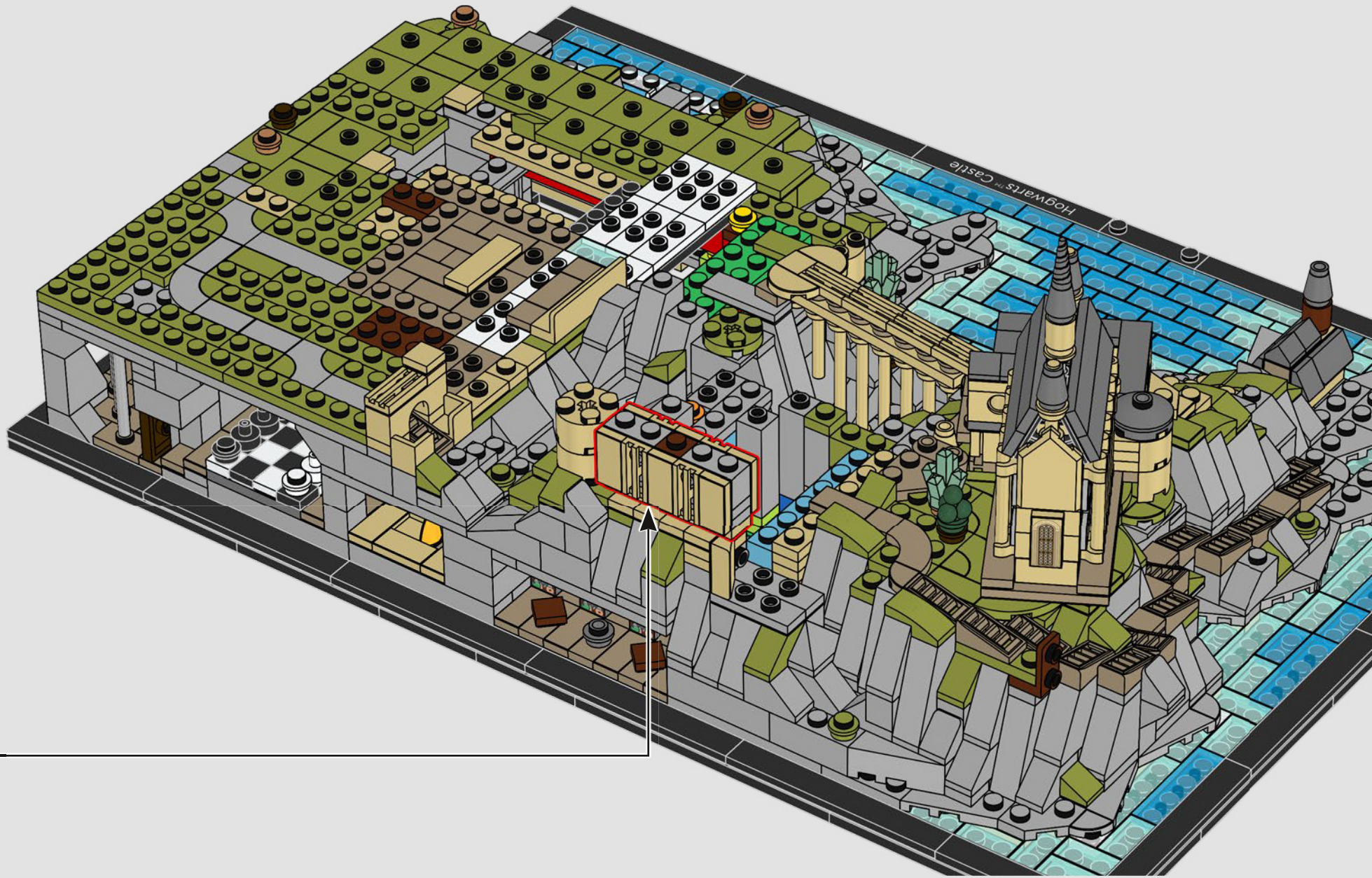

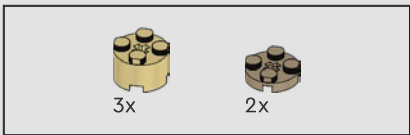

370

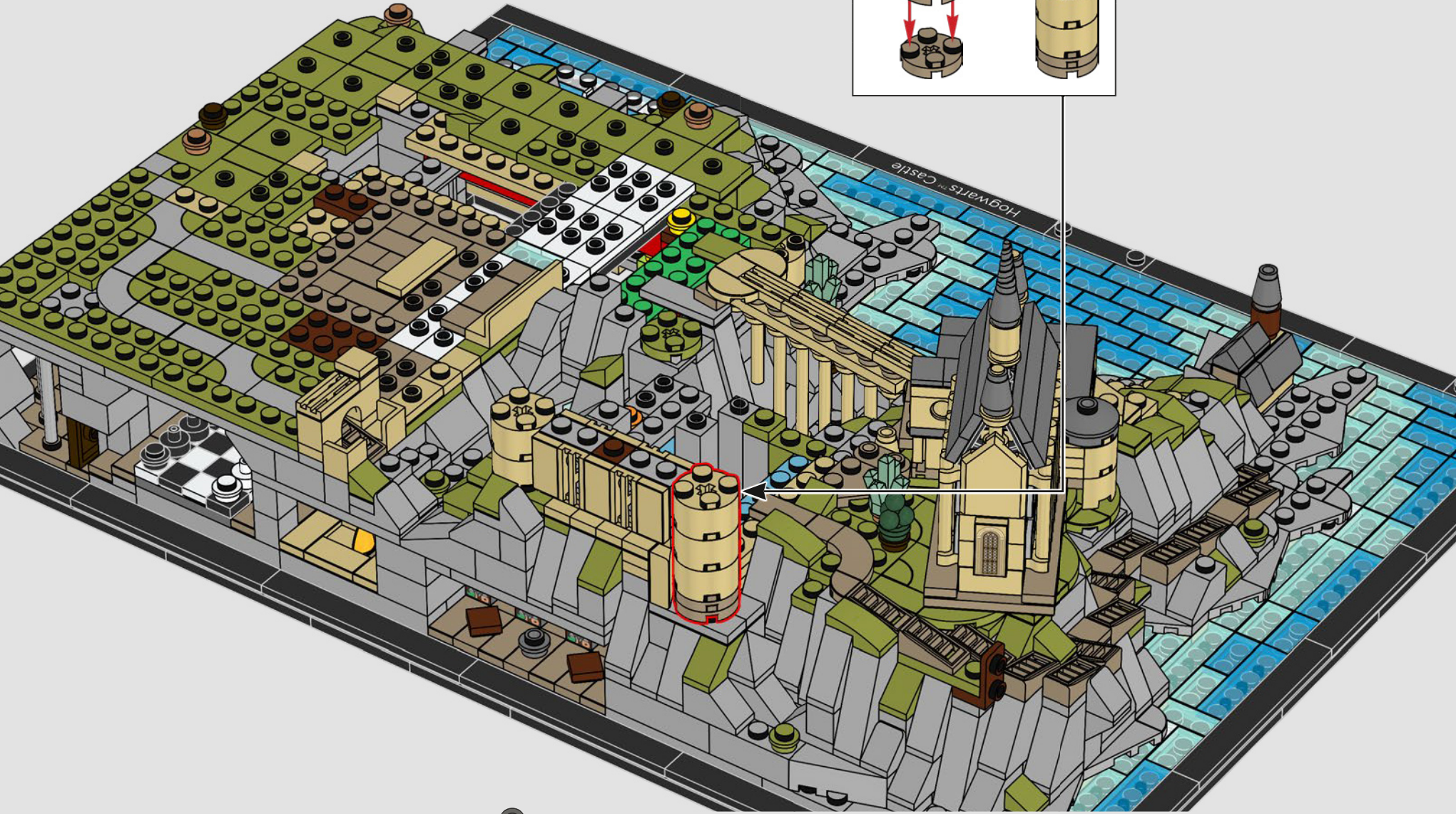
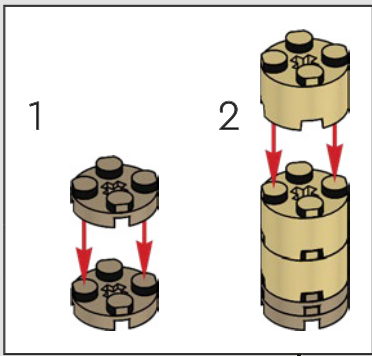

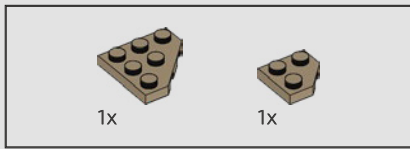

371

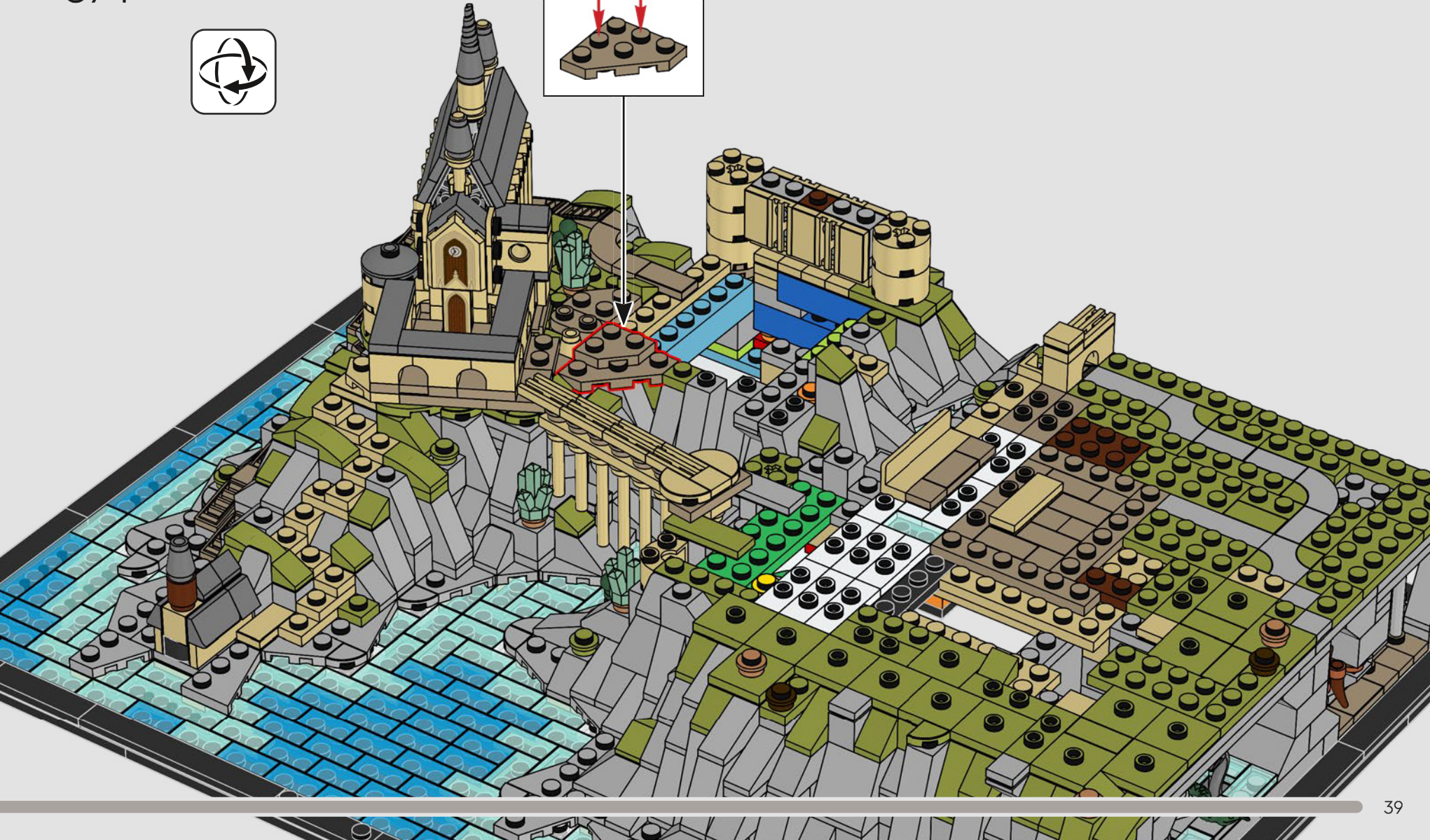
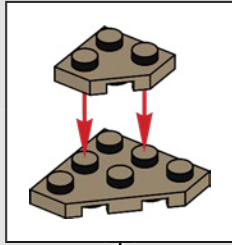

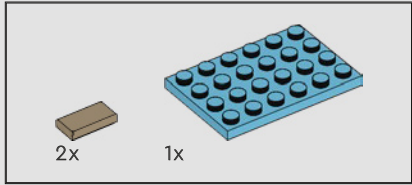
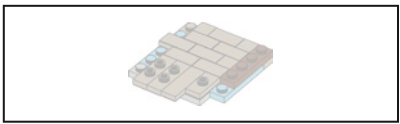

372

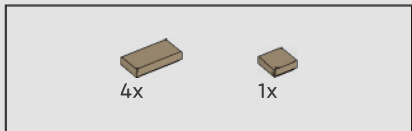
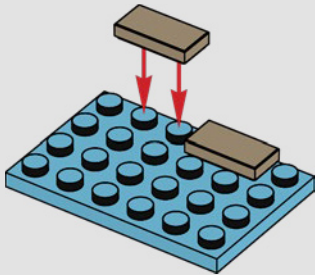

373

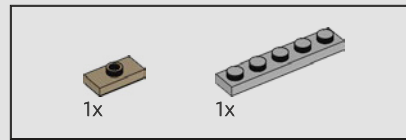
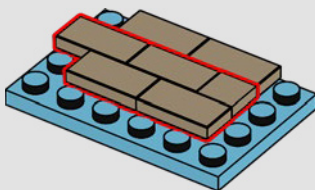

374

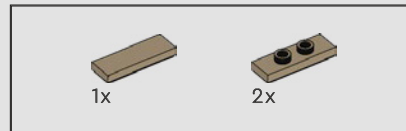
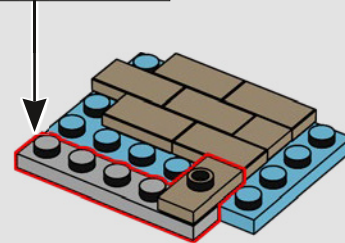
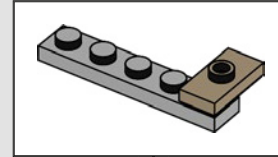

375

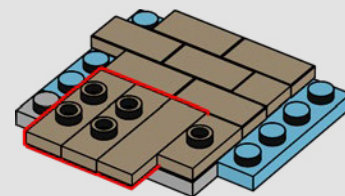



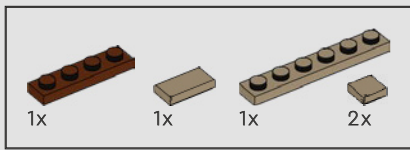

376

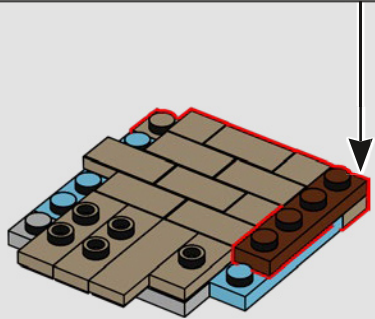
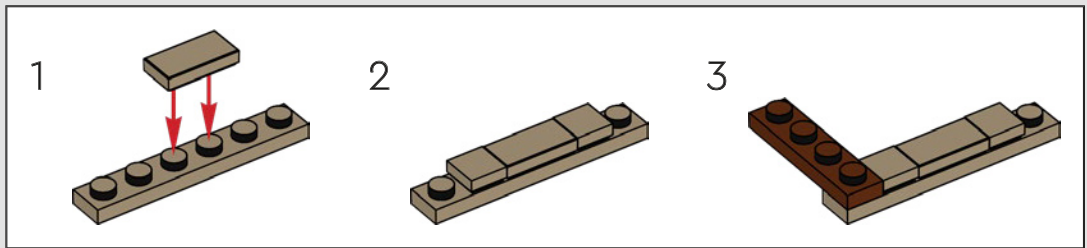

377



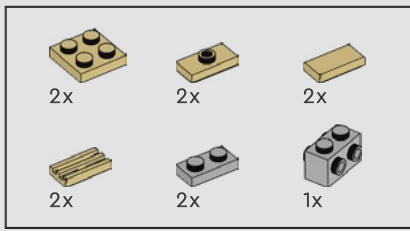

378

1

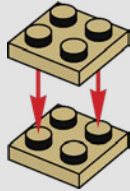

2

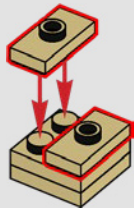

3

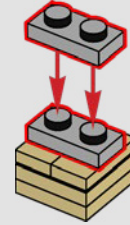

4

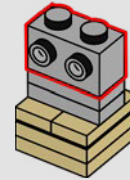

5

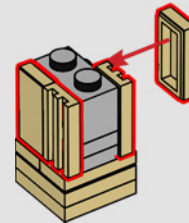



Hogwarts™ Castle

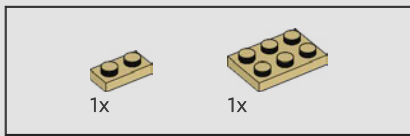

379

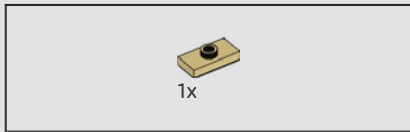
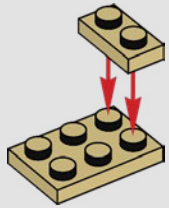

380

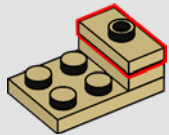

381

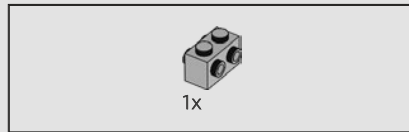
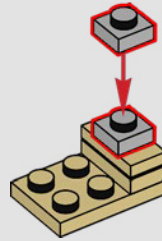

382

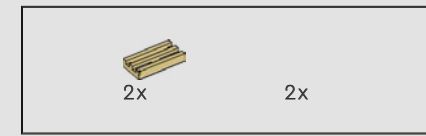
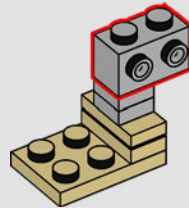

383

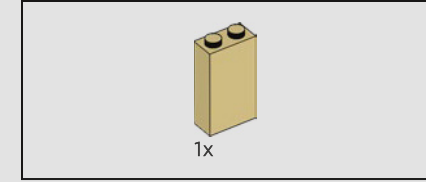
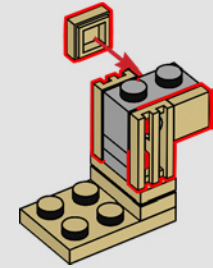

384

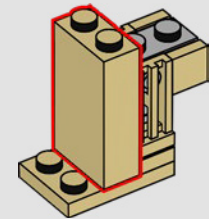

385

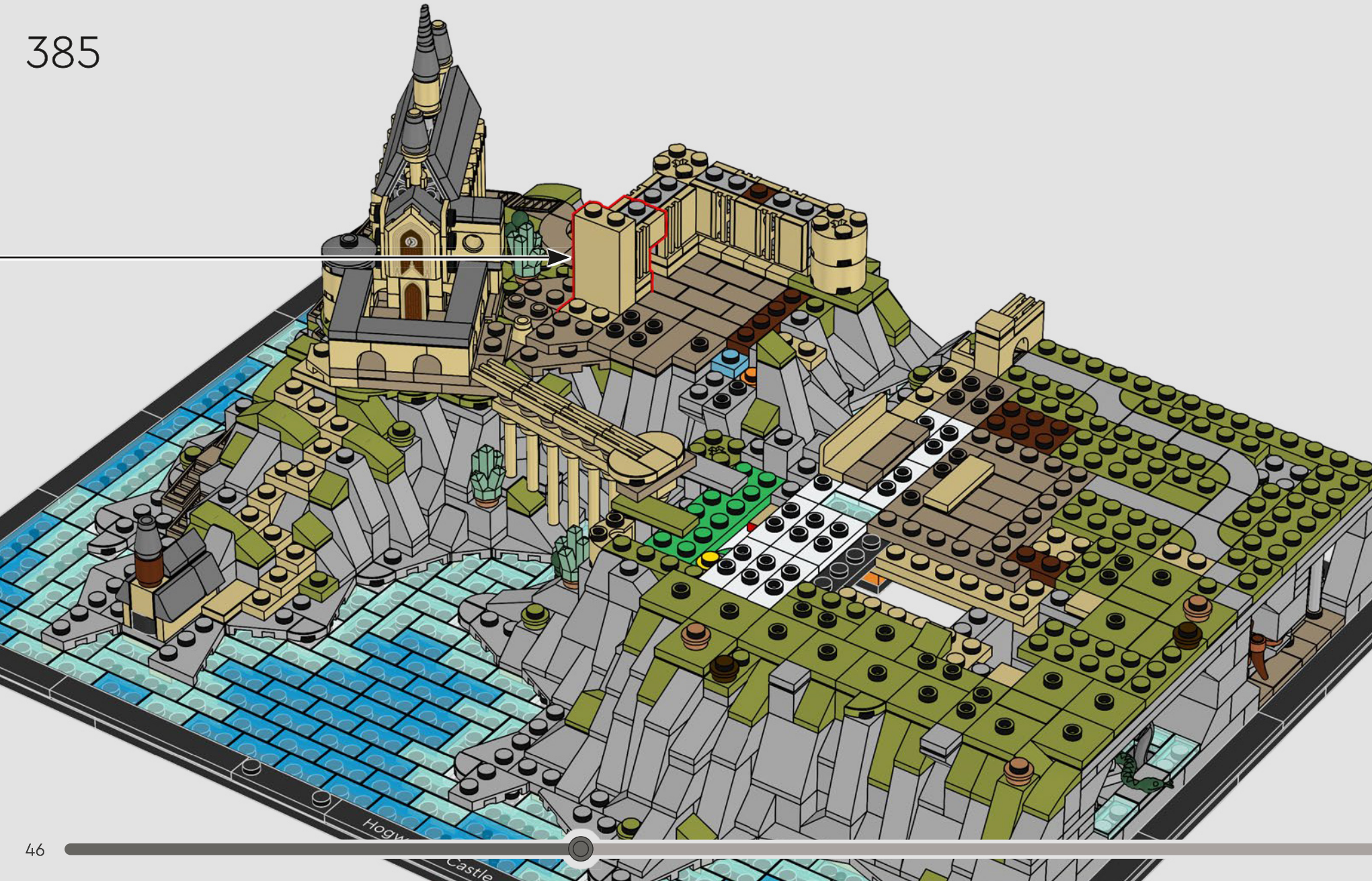

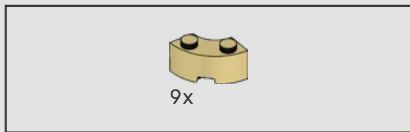

386

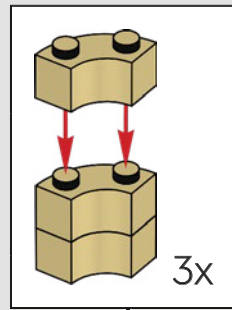

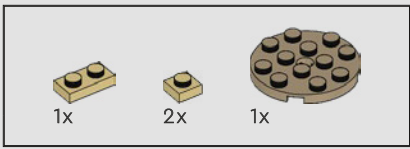

387

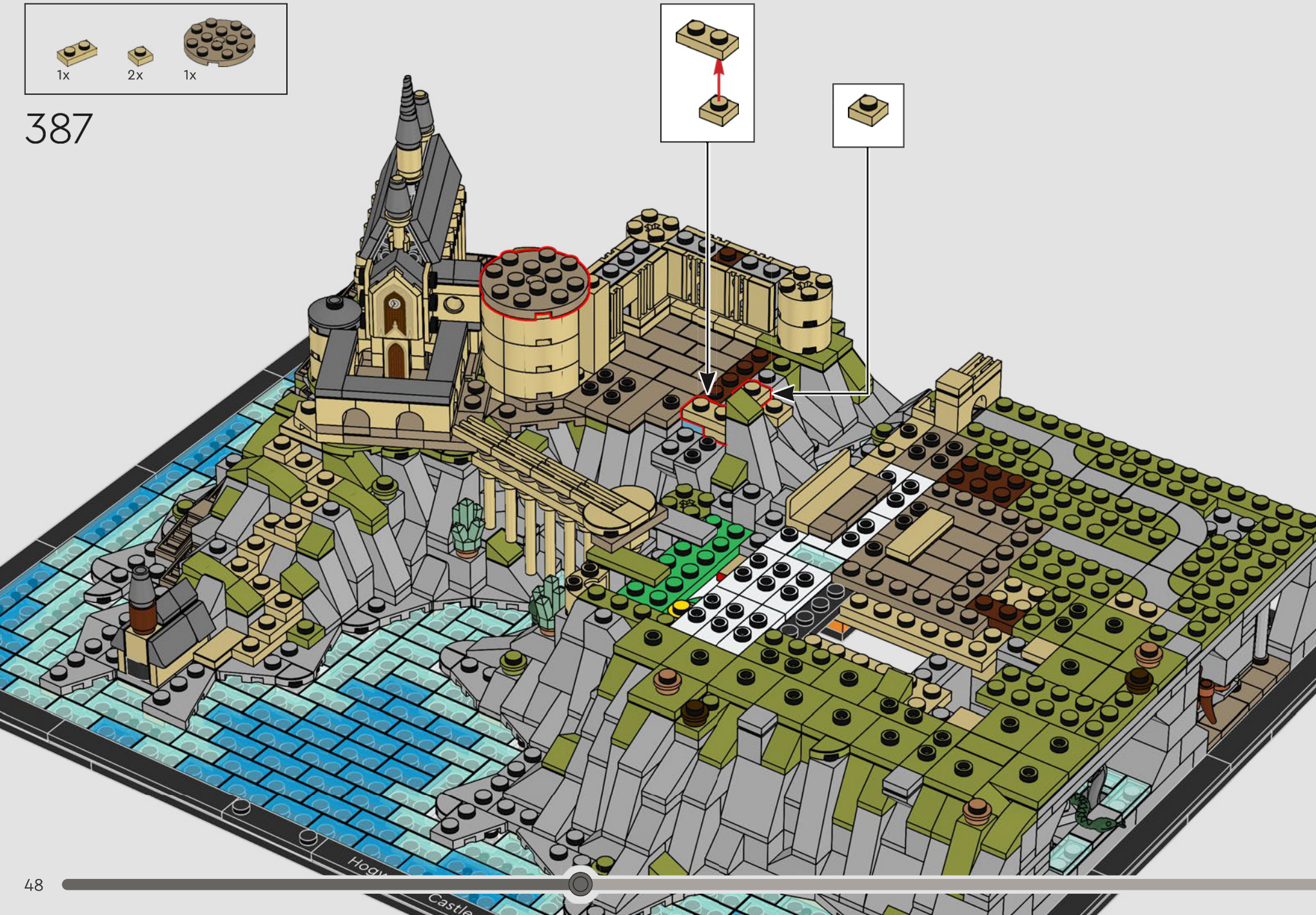
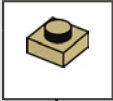
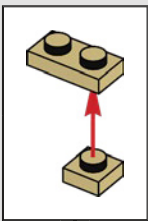



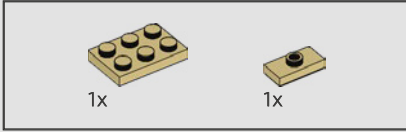
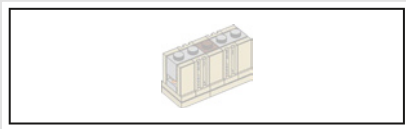

388

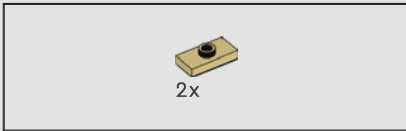
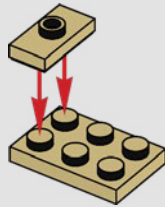

389

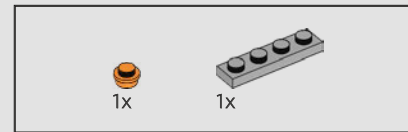
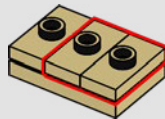

390

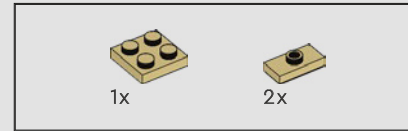
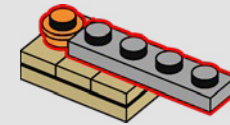

391

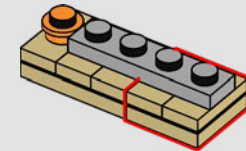
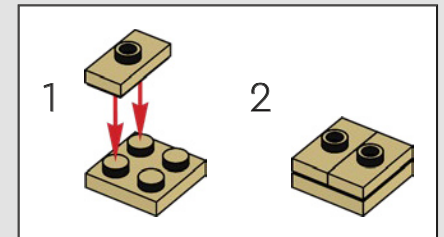

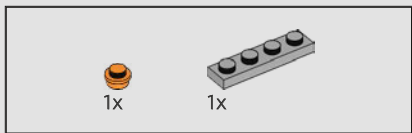

392

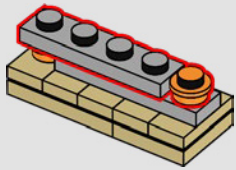

393

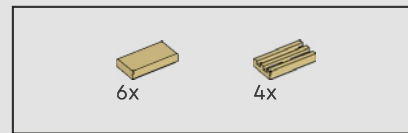
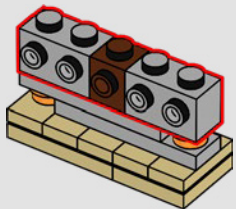

394

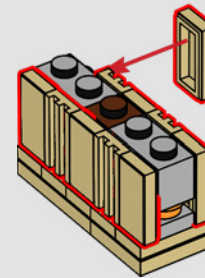

395

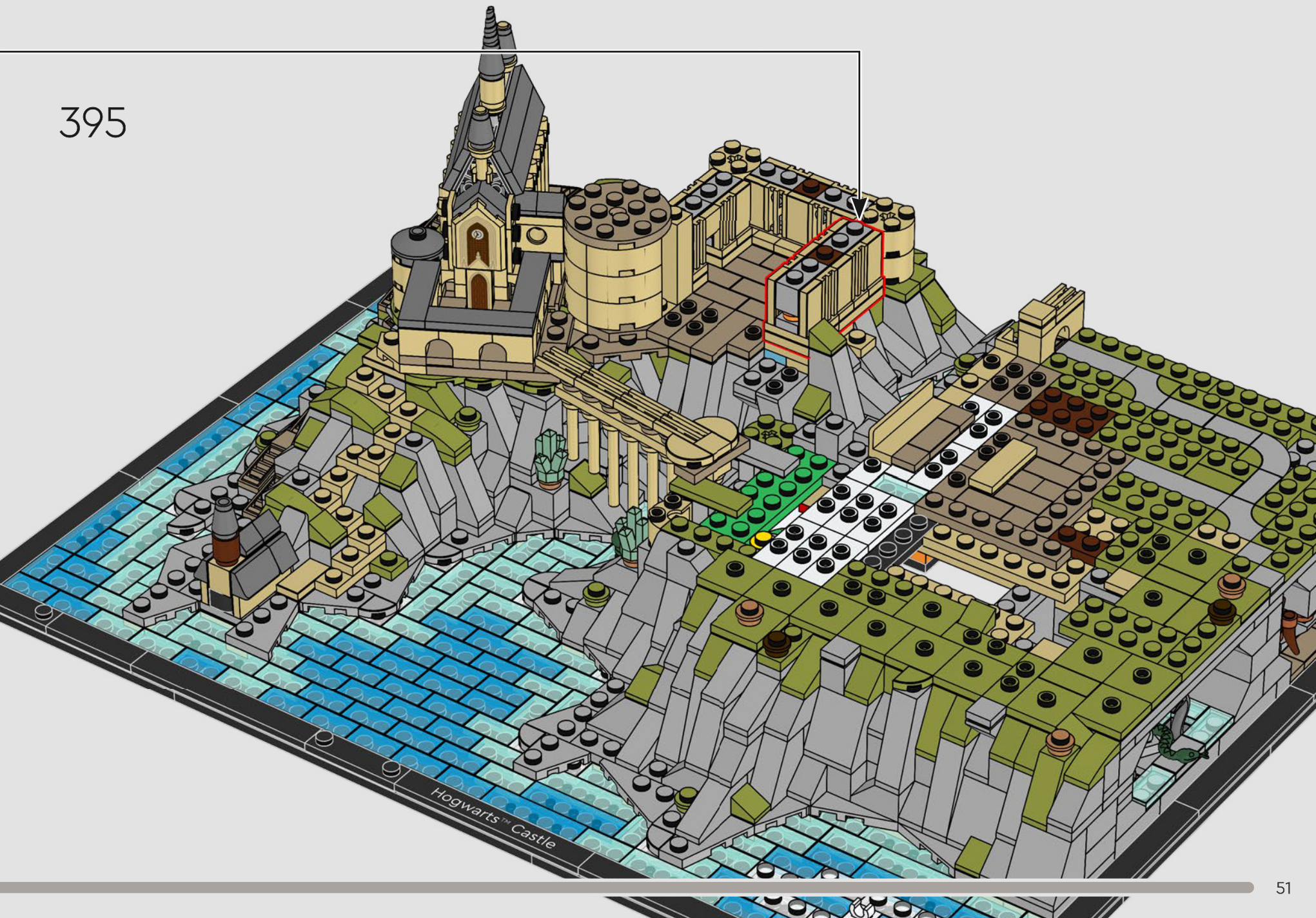

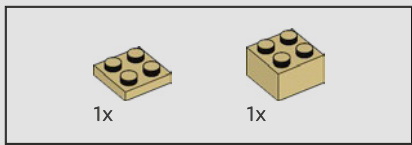

396

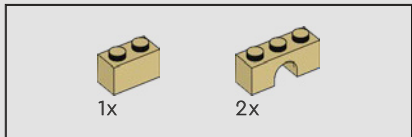
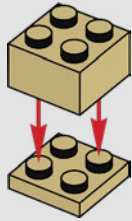

397

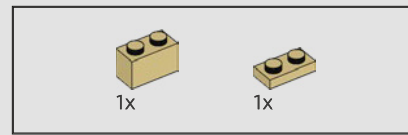
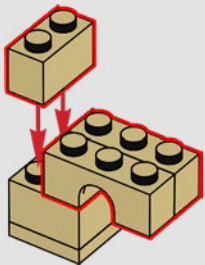

398

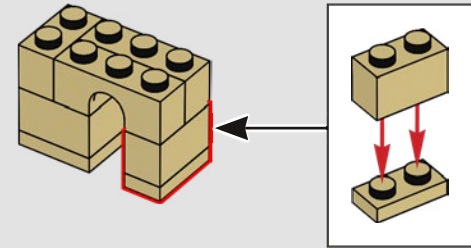

399

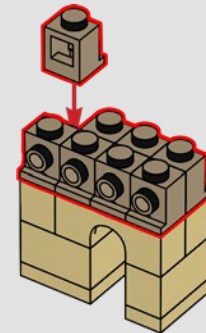

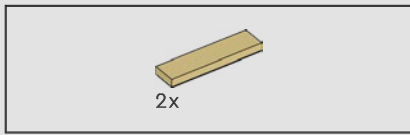

400

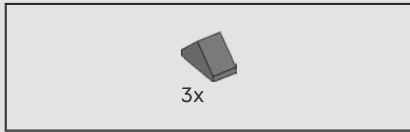
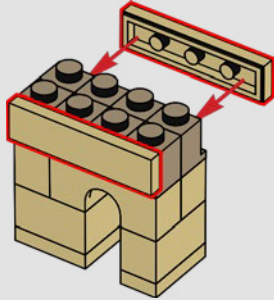

401

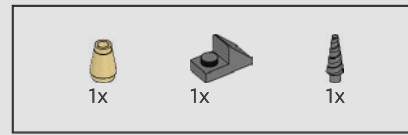
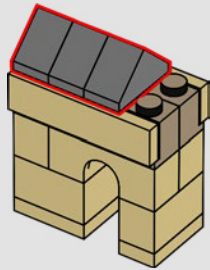

402

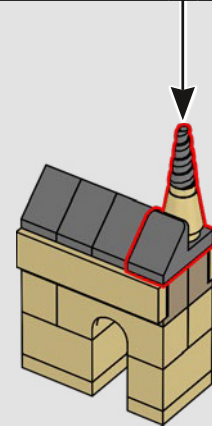
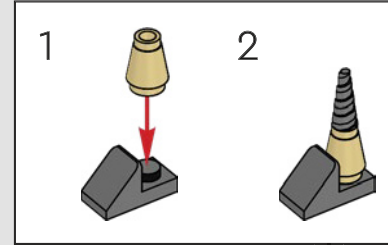

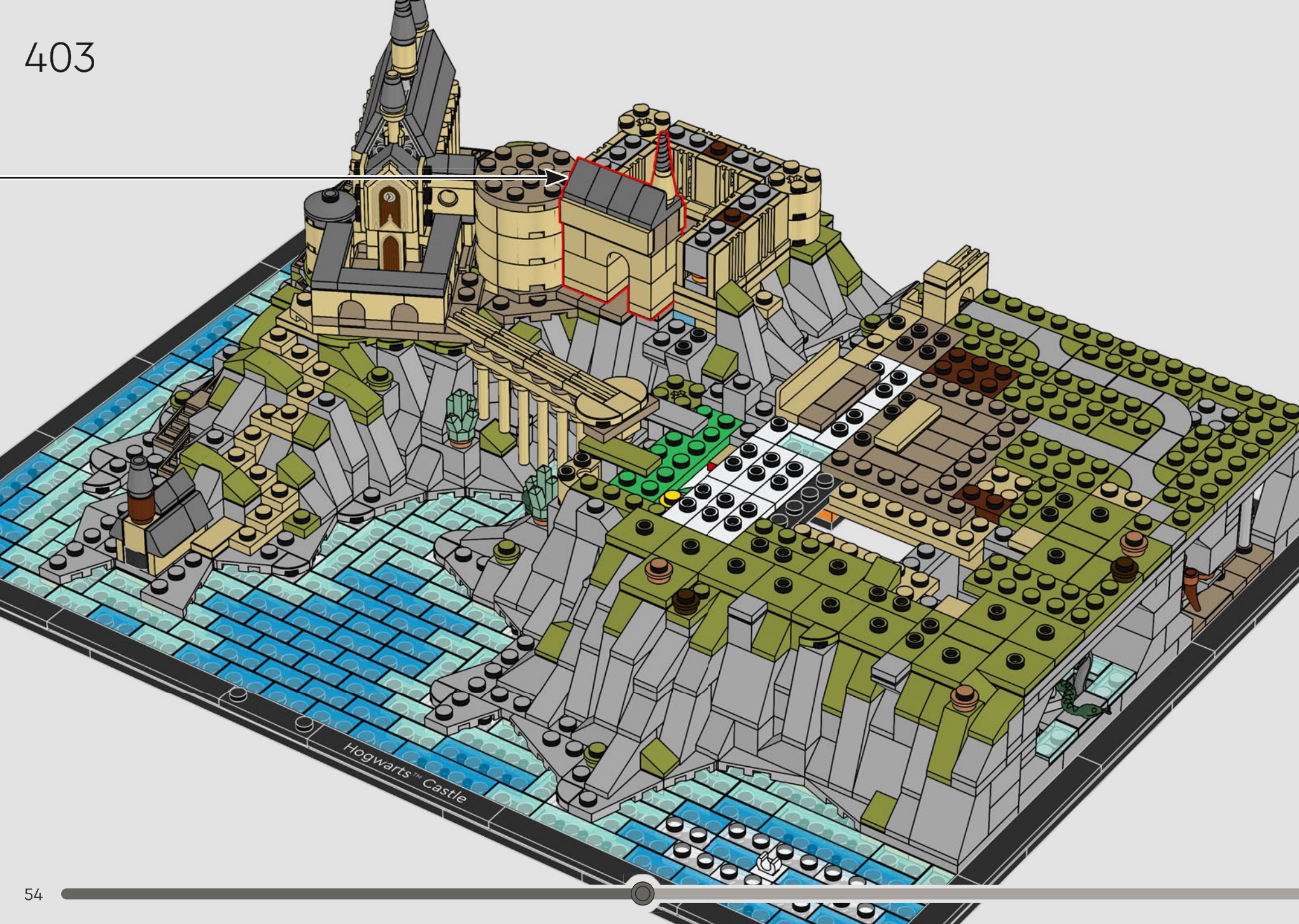

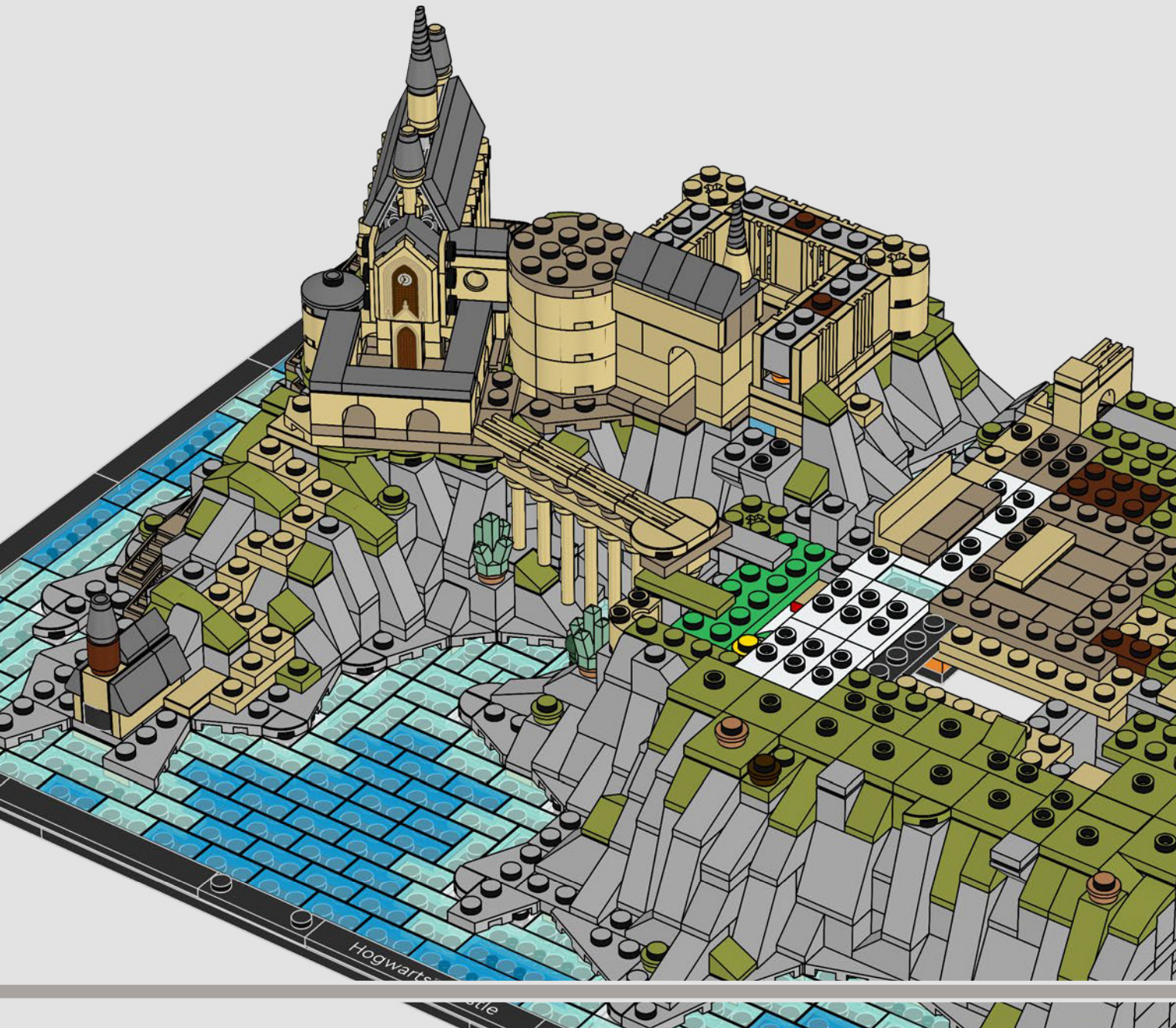

The Quad Courtyard is an outdoor meeting space for students nestled near the Clock Tower.

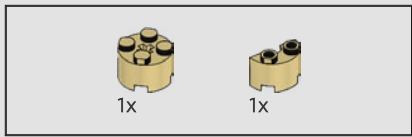

404

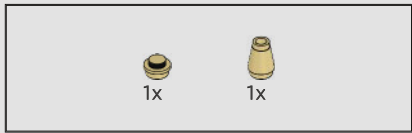
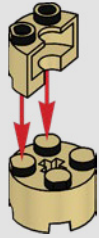

405

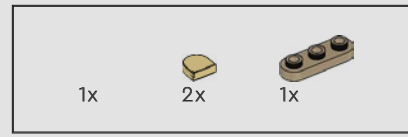
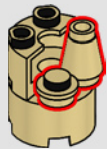

406

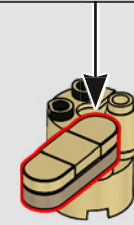
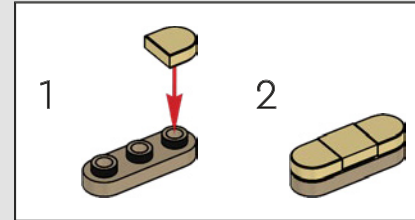

407

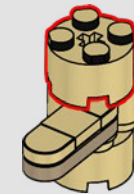



408

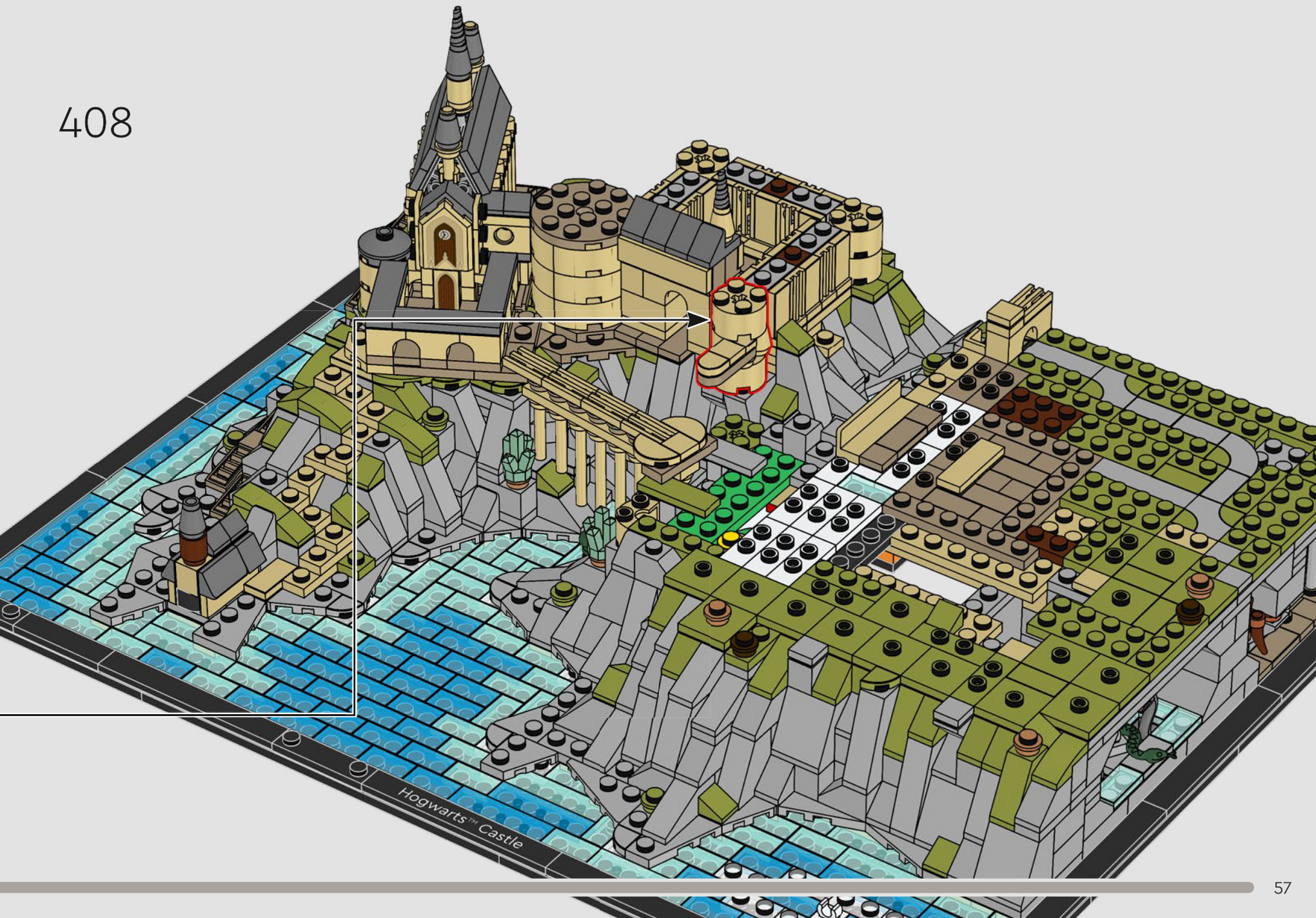





409





410

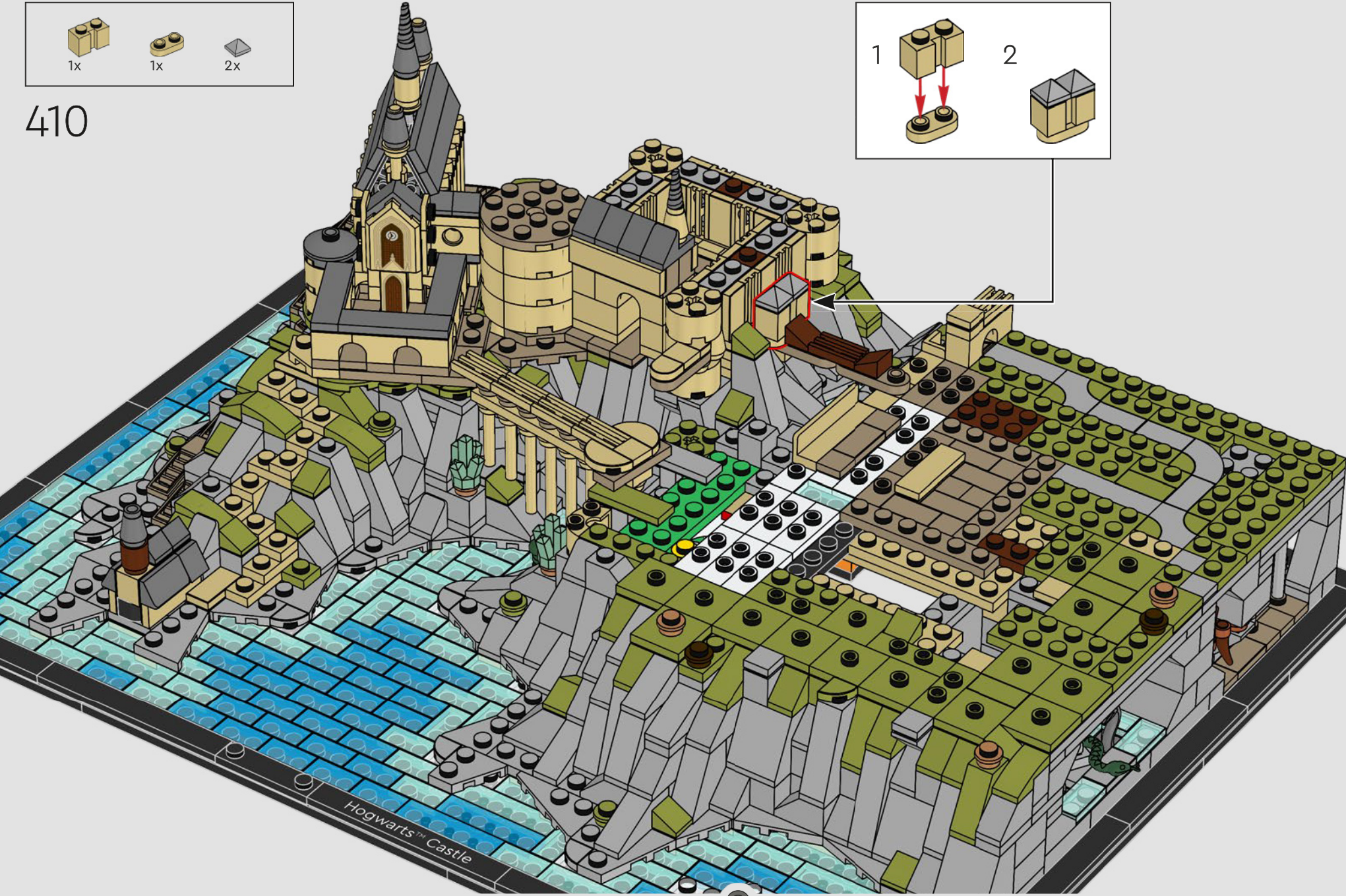
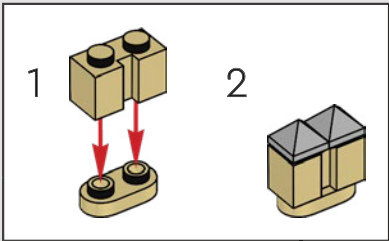

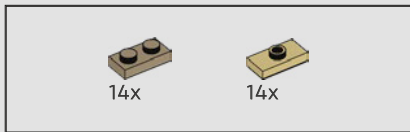

411

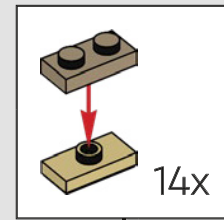

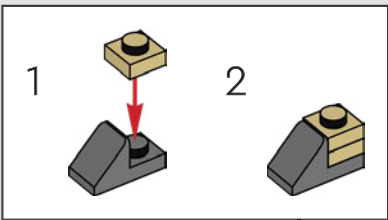
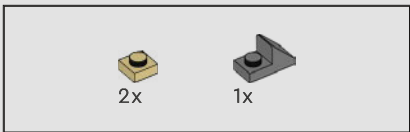

412

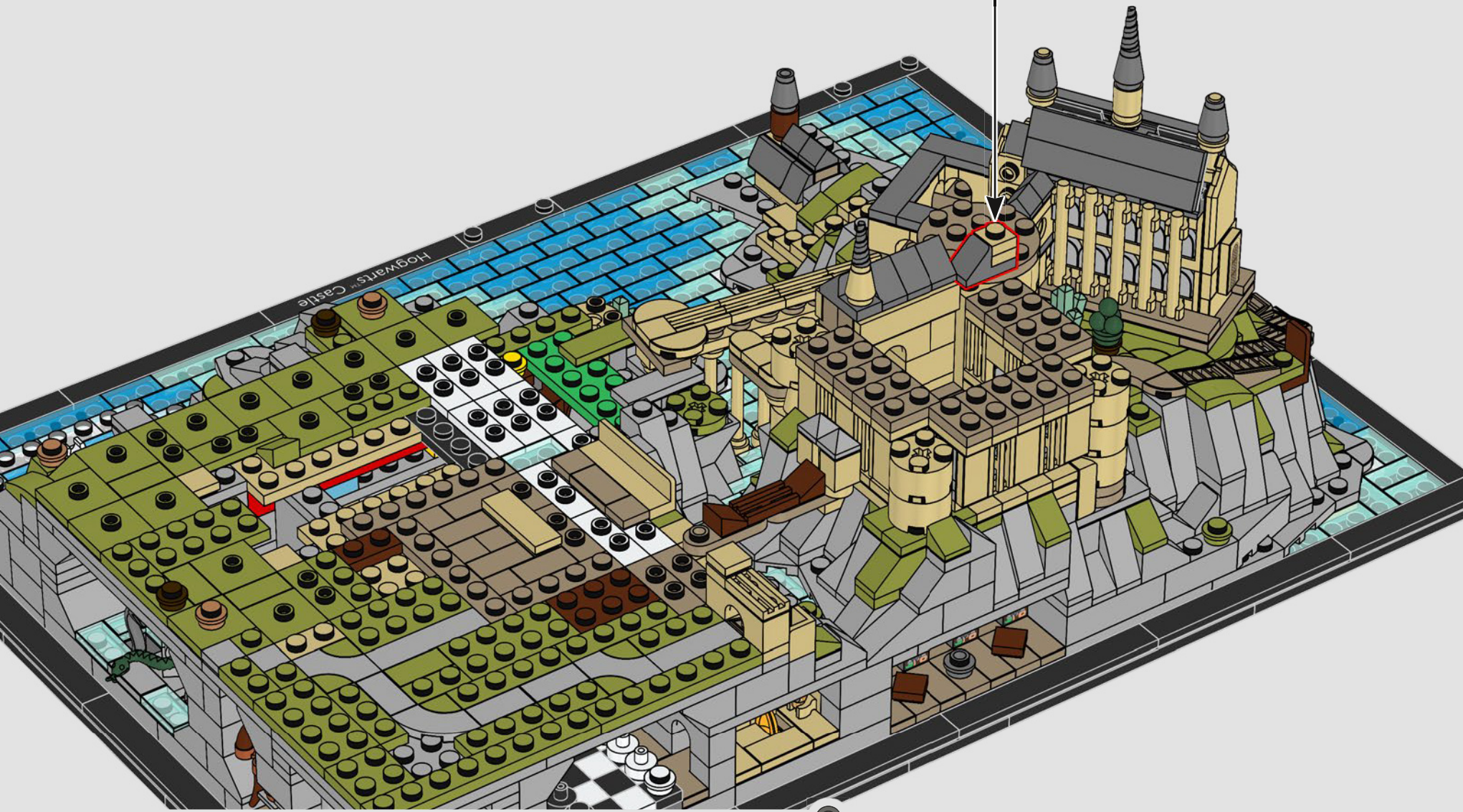

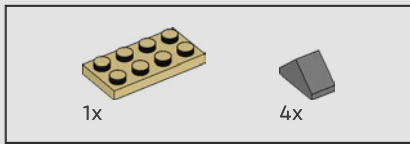

413

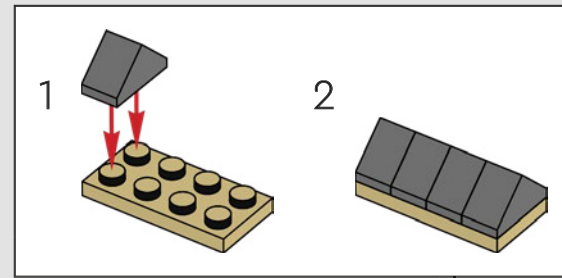

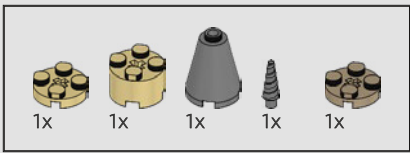

414

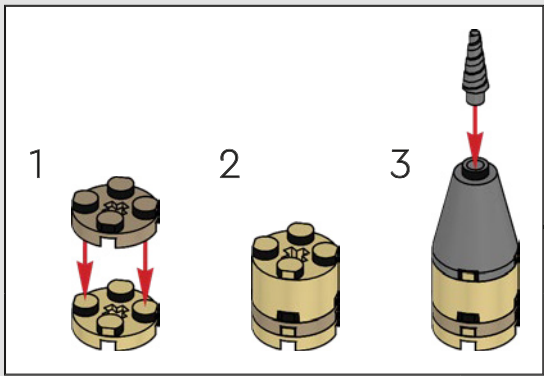



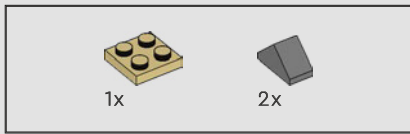

415

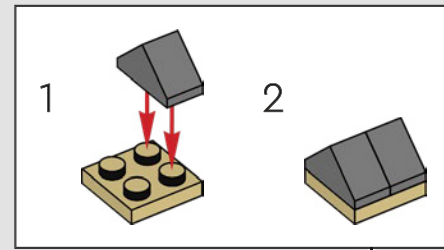

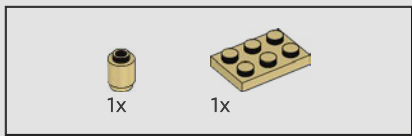

416

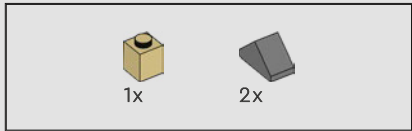
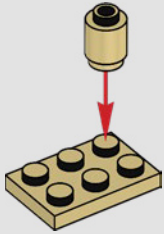

417

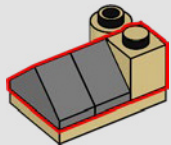

418

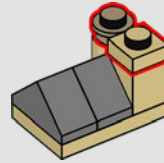

419

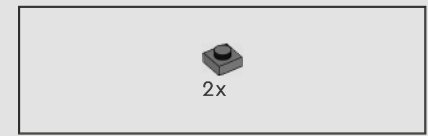
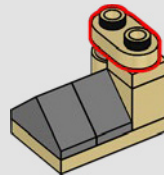

420

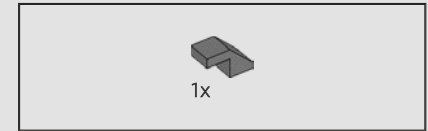
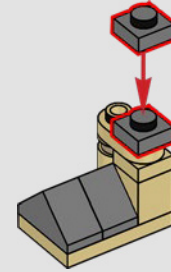

421

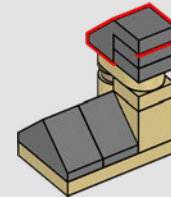

422

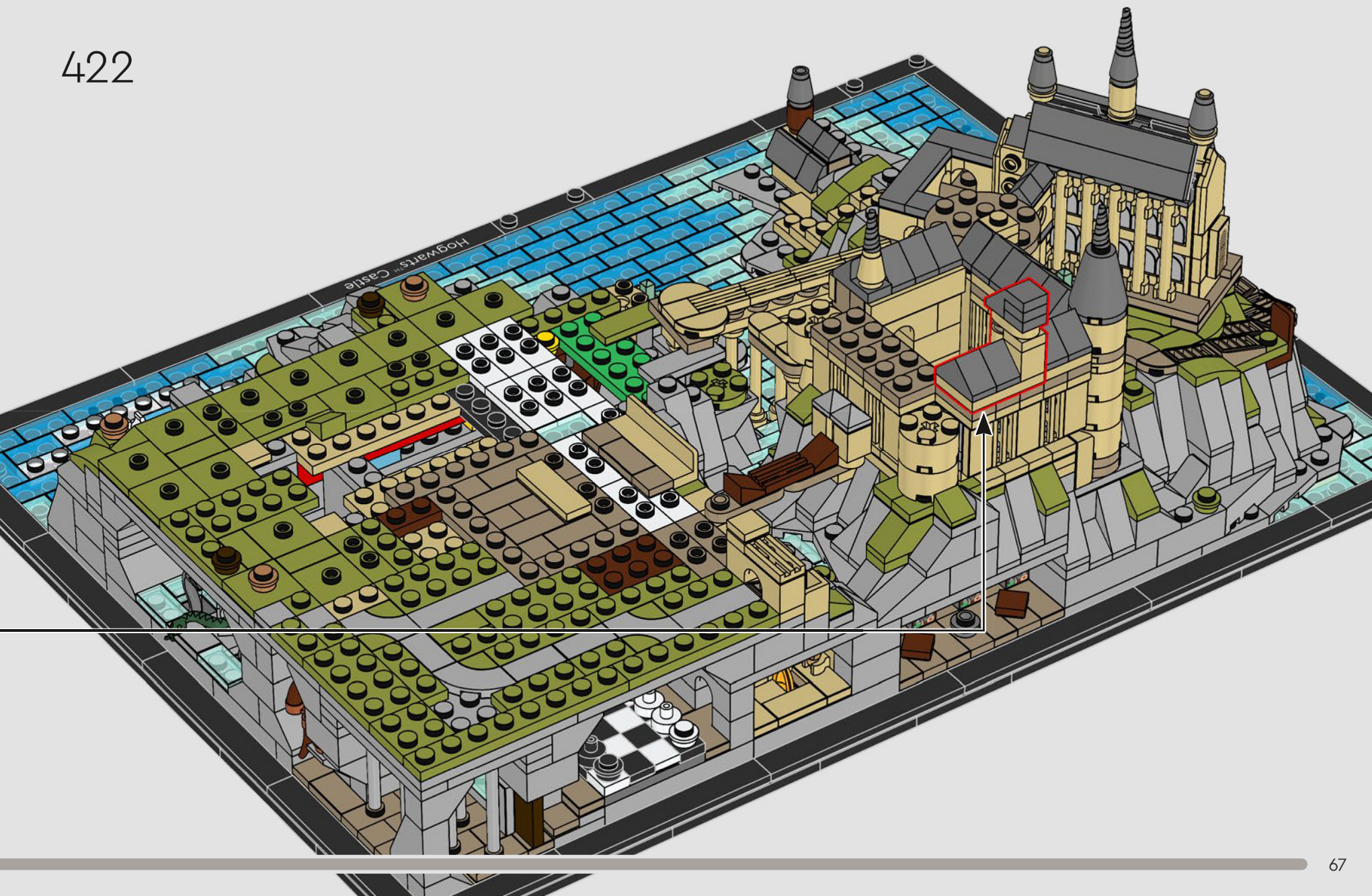

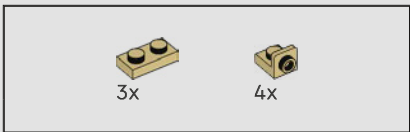

423



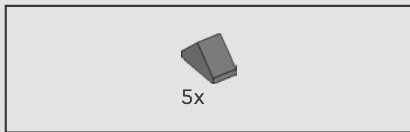

424



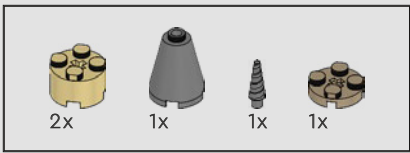

425

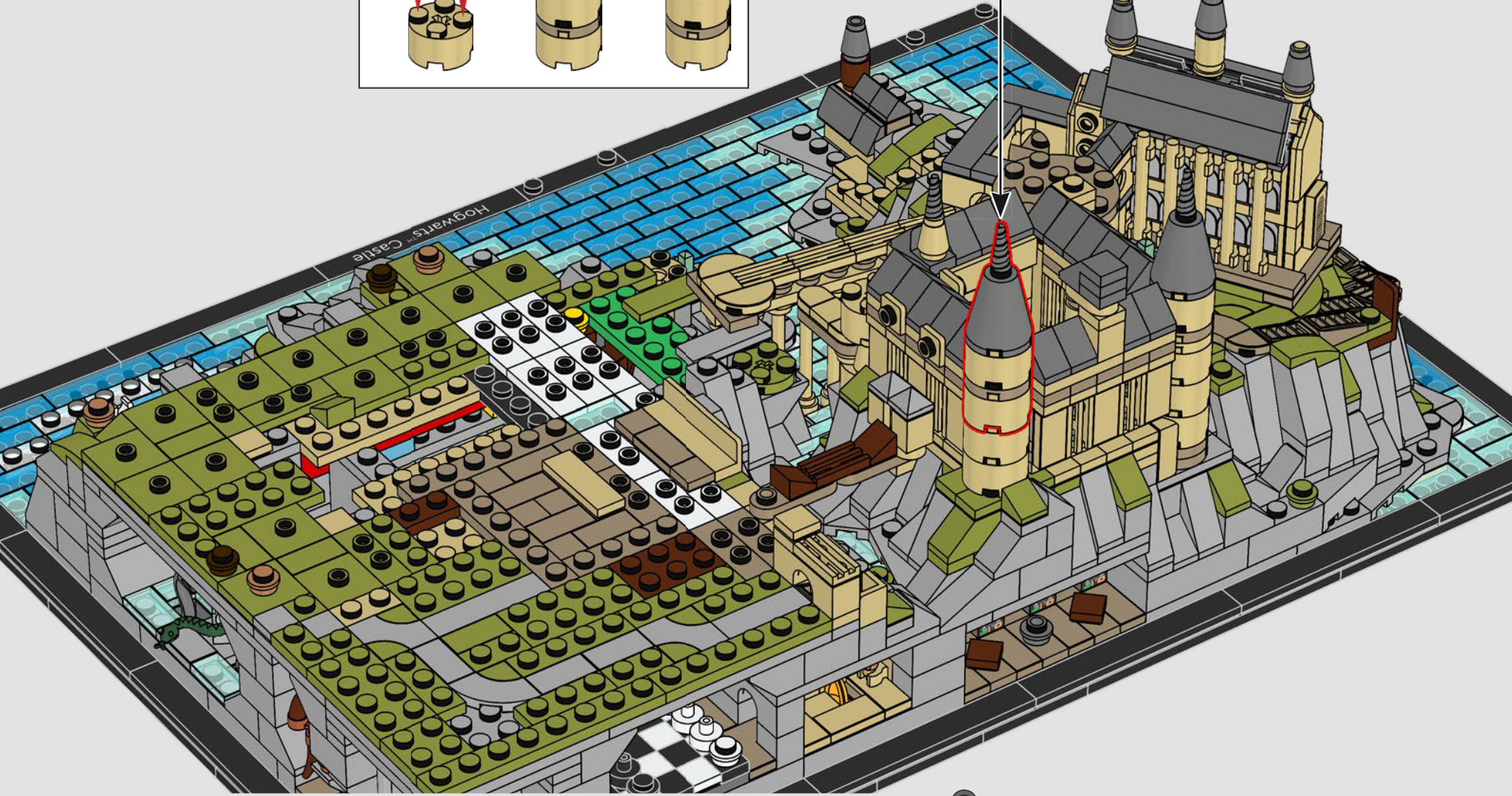
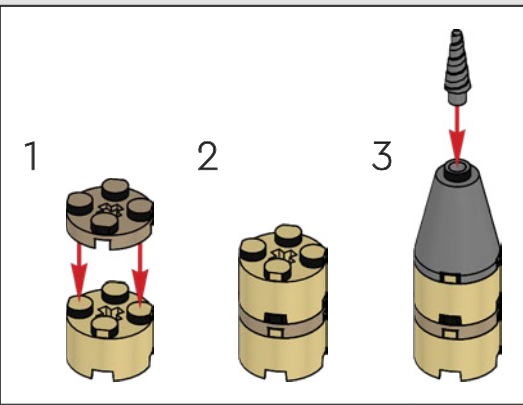

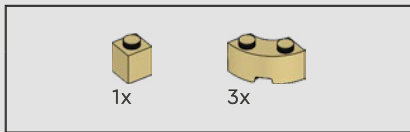

426

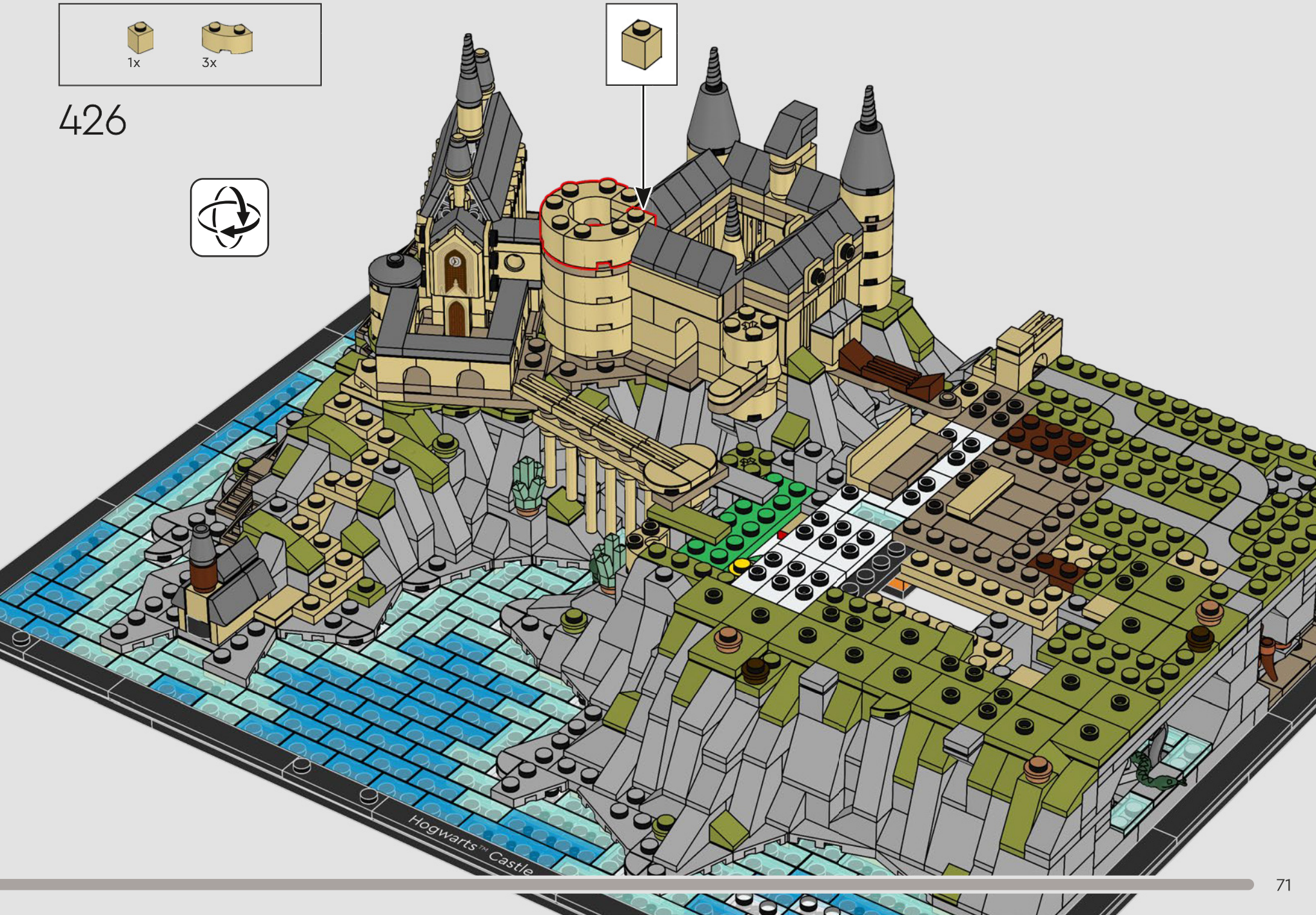
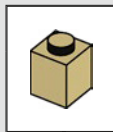

Hogwarts™ Castle

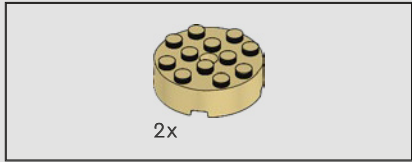
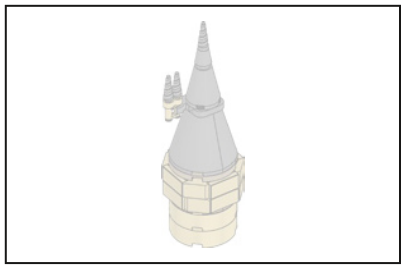

427

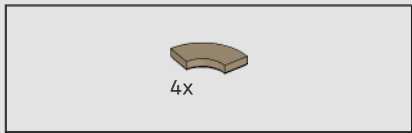
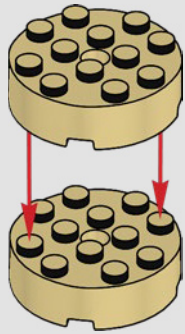

428

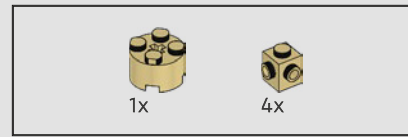
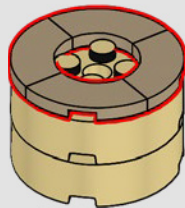

429

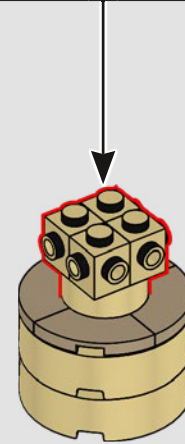
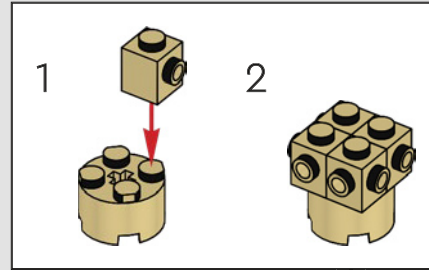



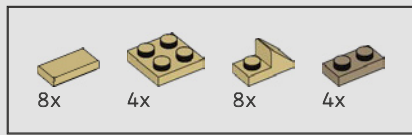

430

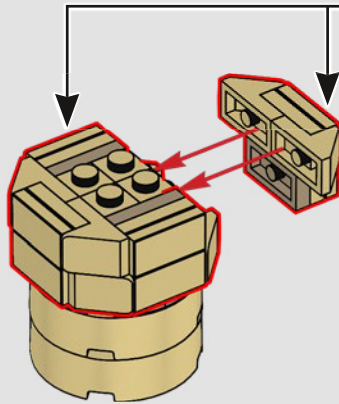
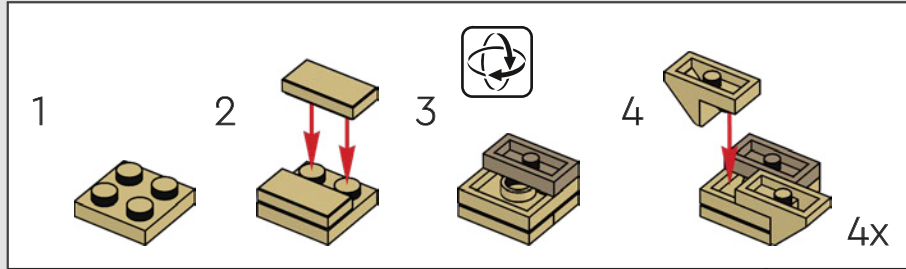

431

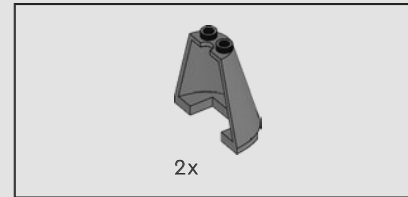
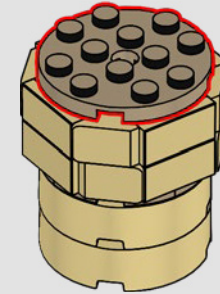

432

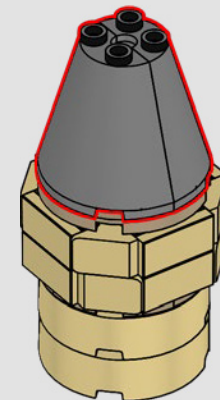

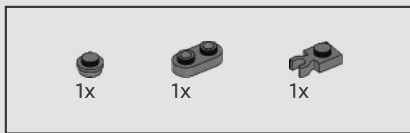

433

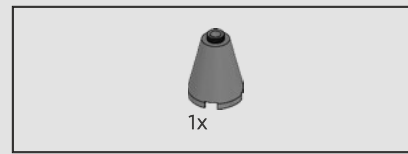
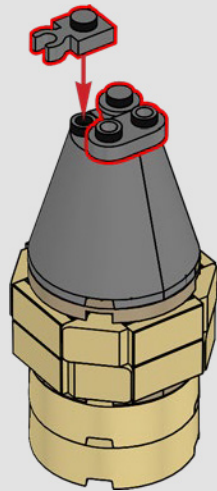

434

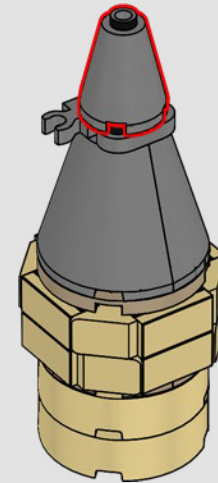

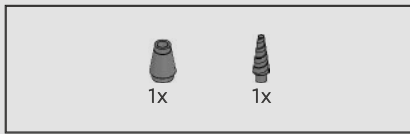

435

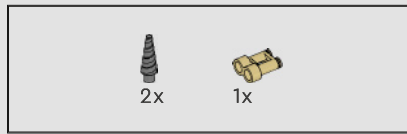
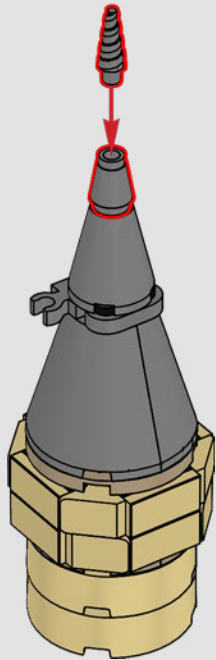

436

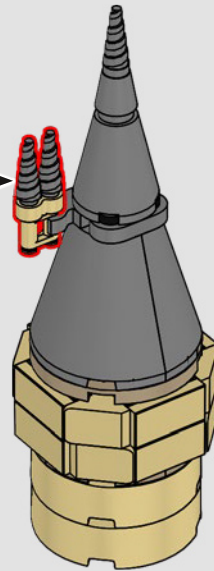
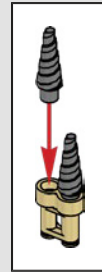

The office of Albus Dumbledore™, the small towers on the main tower, is built with a LEGO® telescope element.

437

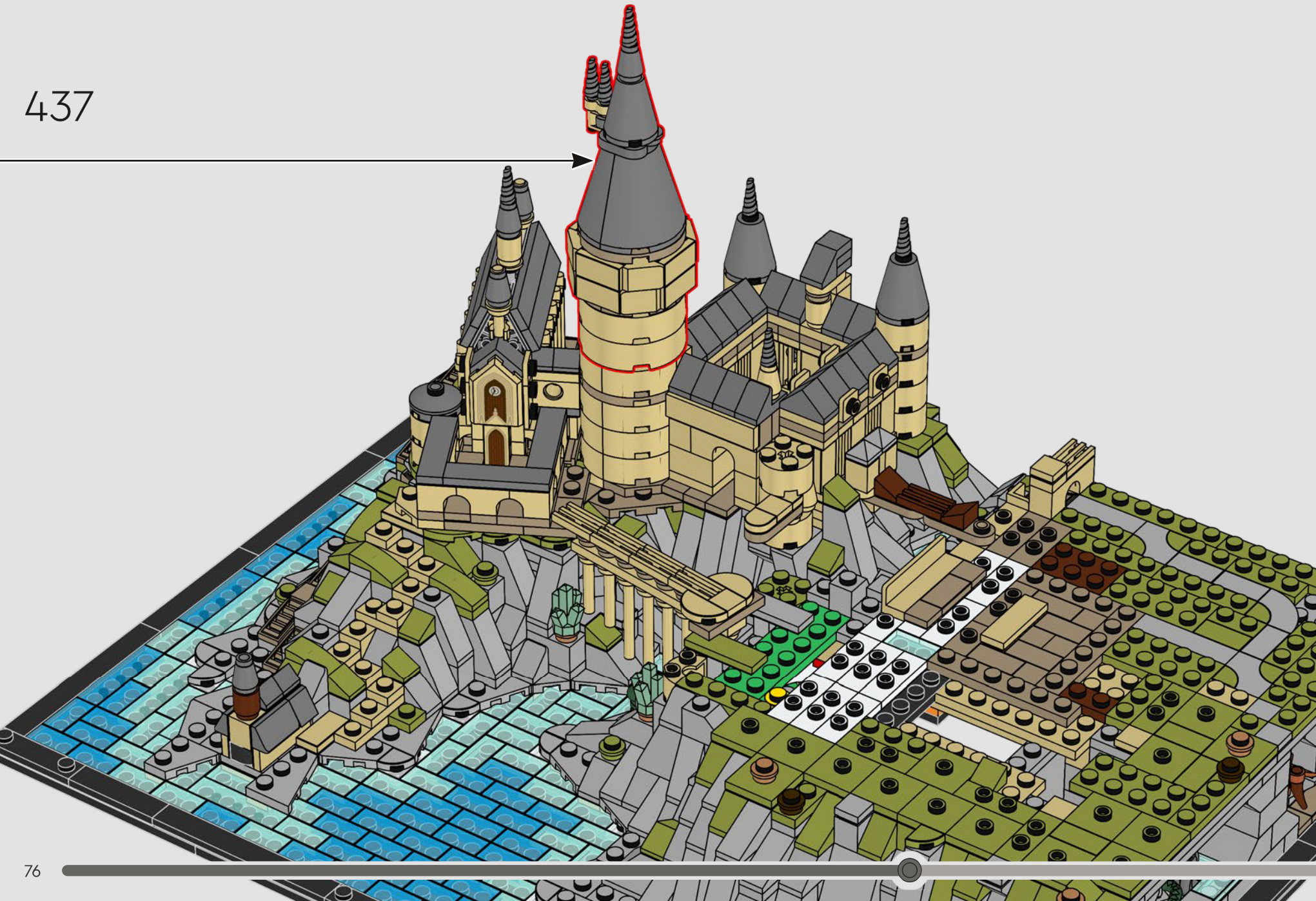



438

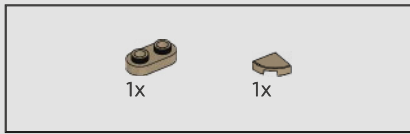
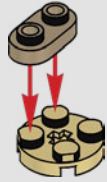

439

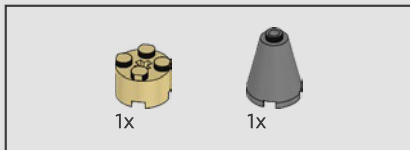

440

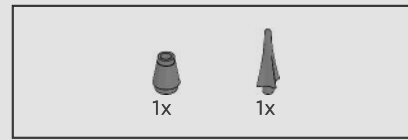
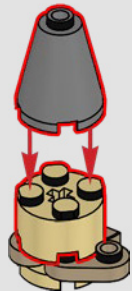

441

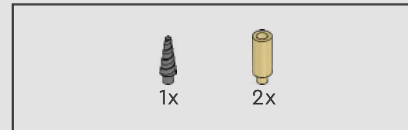
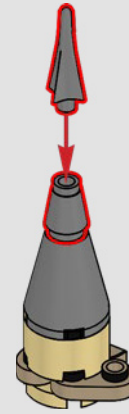

442

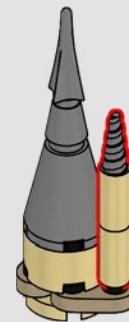
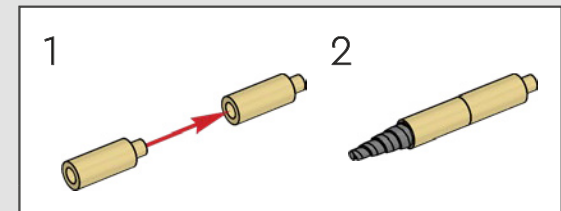

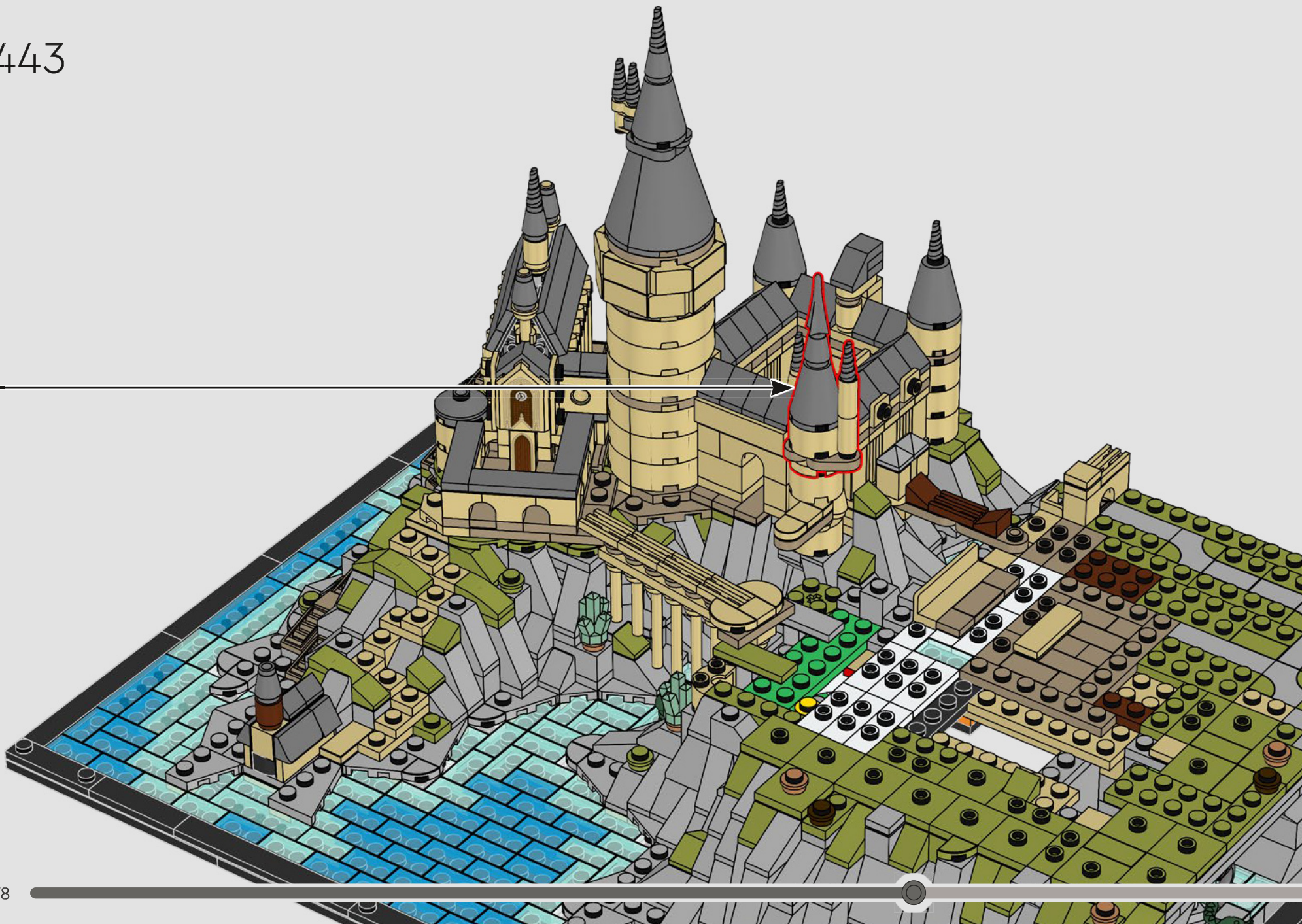



You wouldn't think the sprouting towers on the Headmaster's Tower could be an architecturally sustainable structure – but of course, at Hogwarts™ everything is possible!





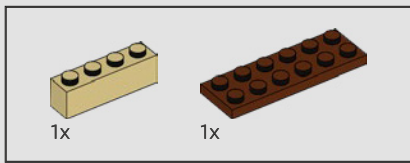

444

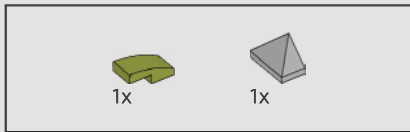
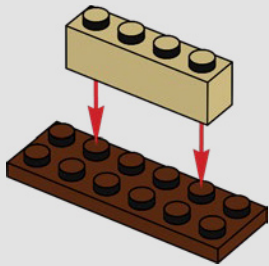

445

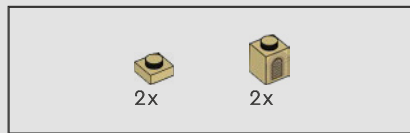
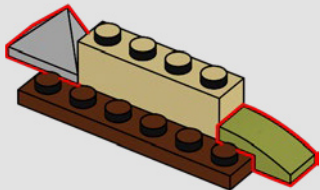

446

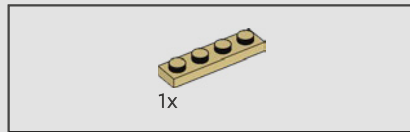
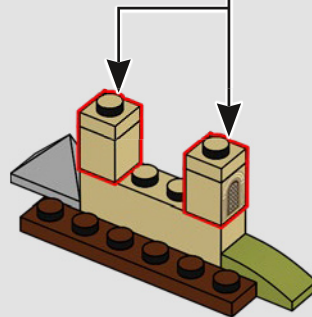
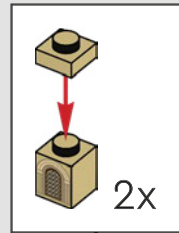

447

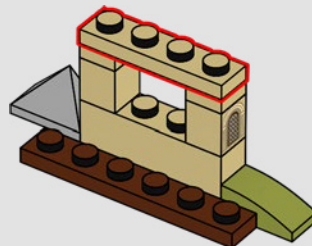

448

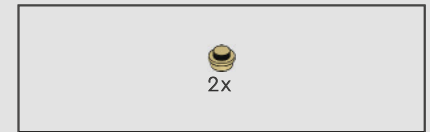
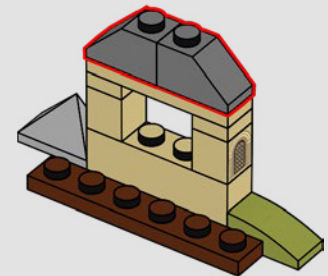

449

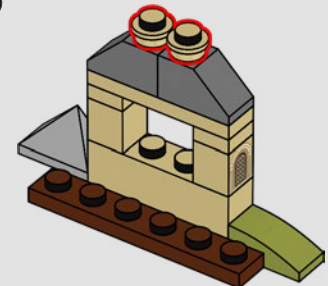

450

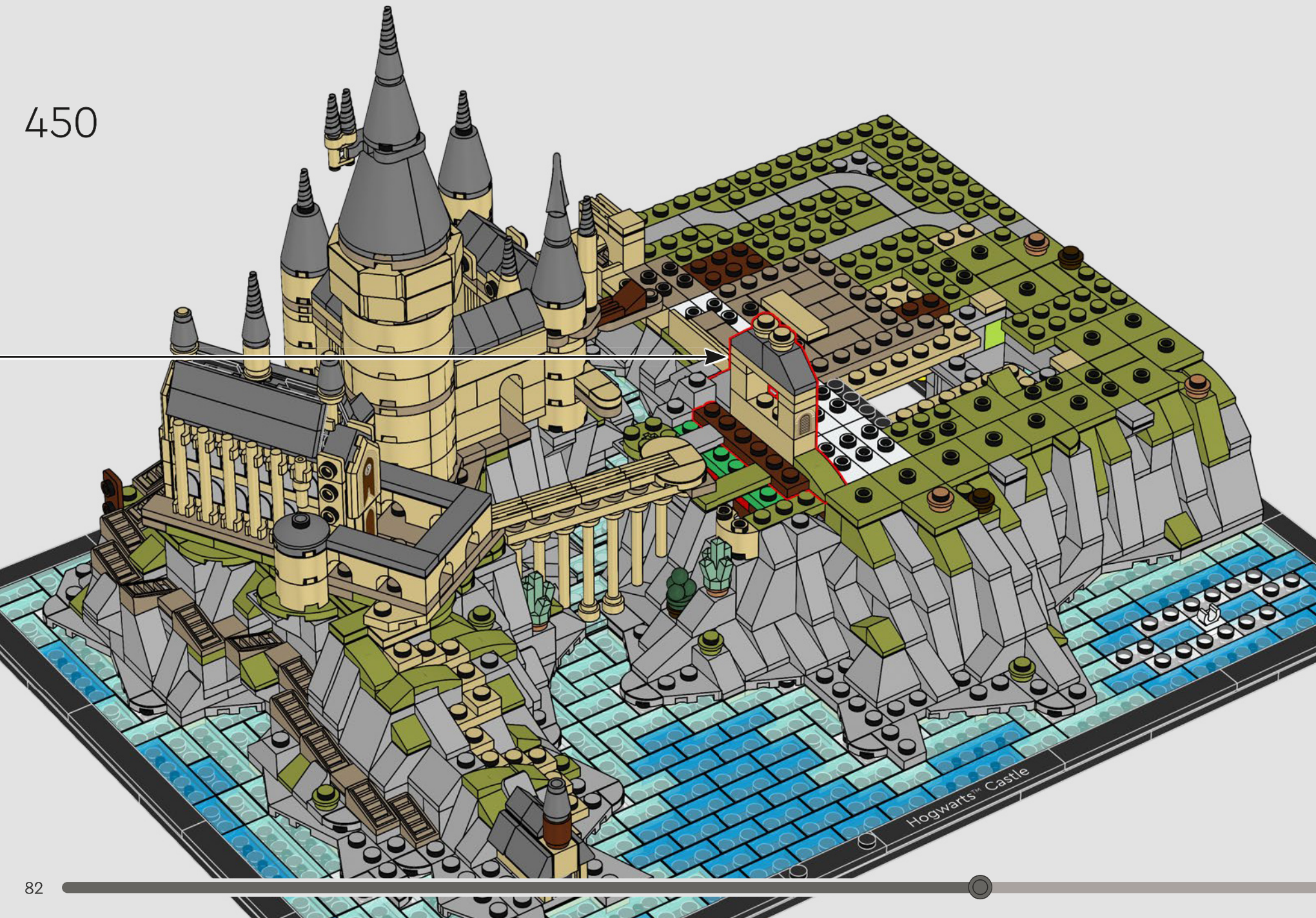

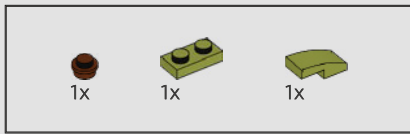

451

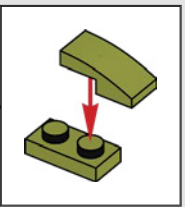
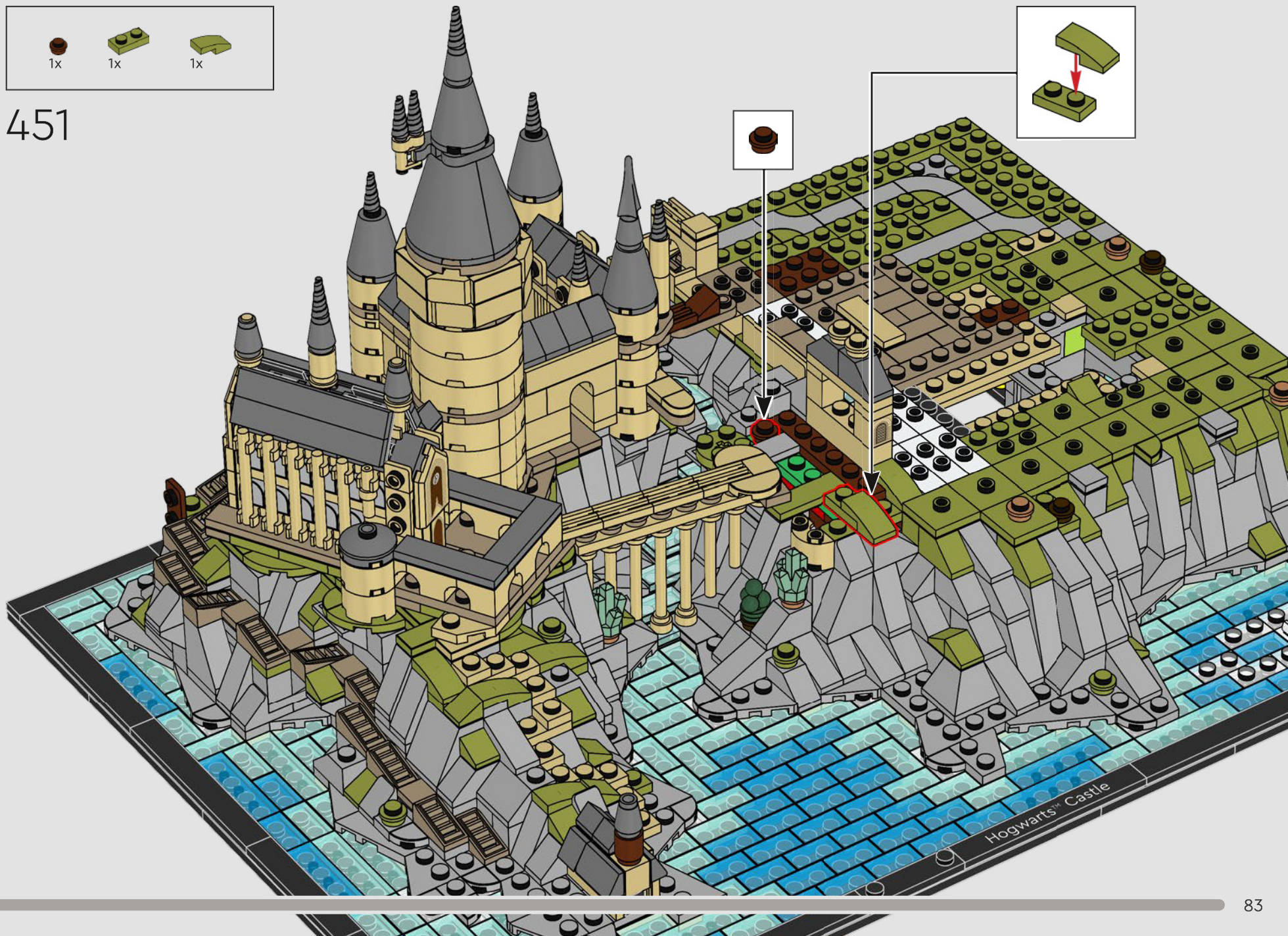

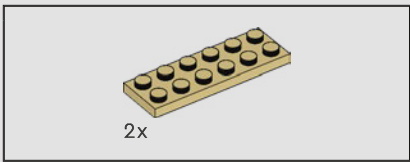

452

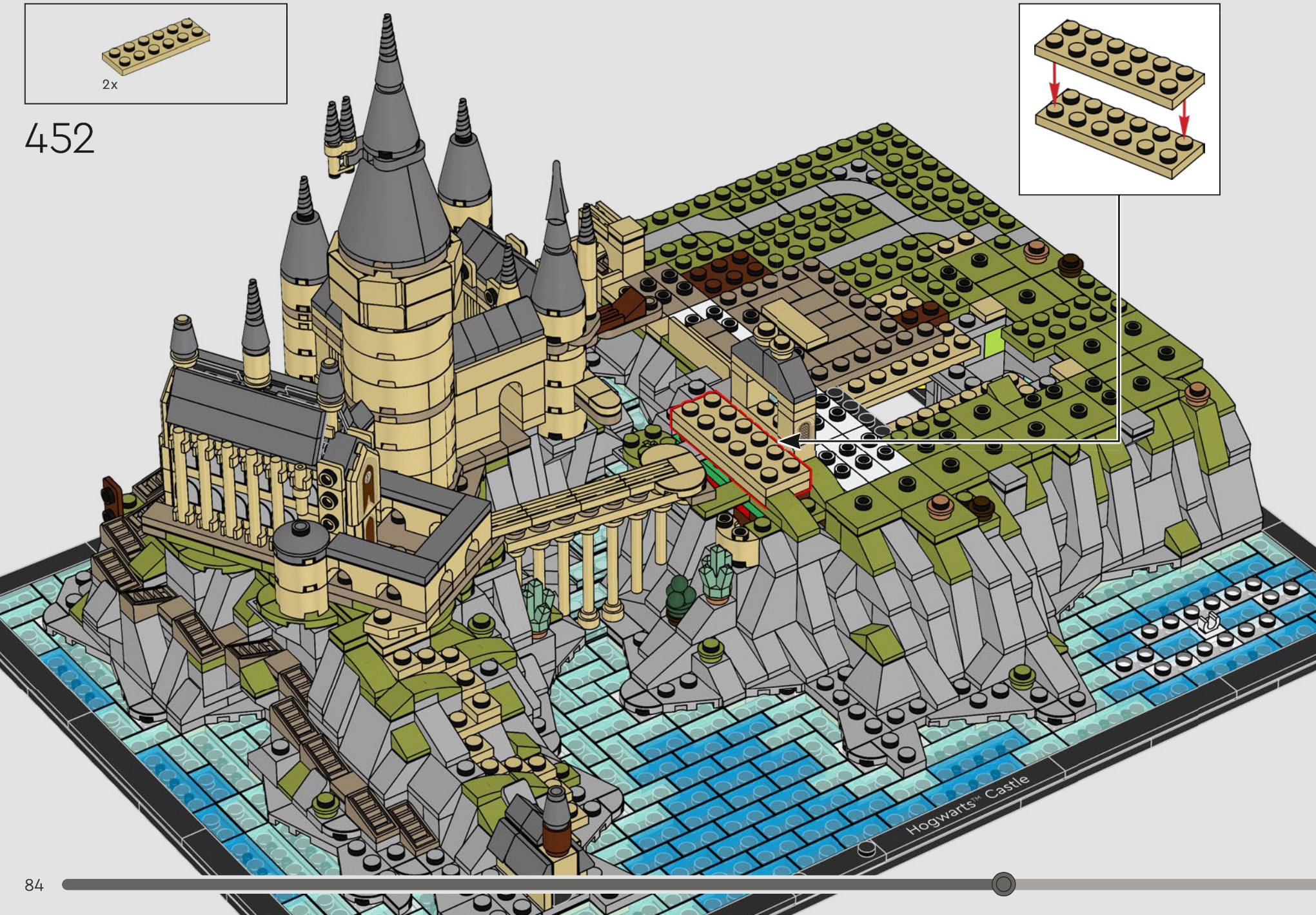
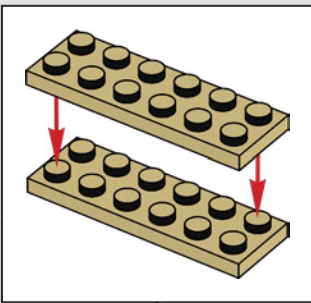



453

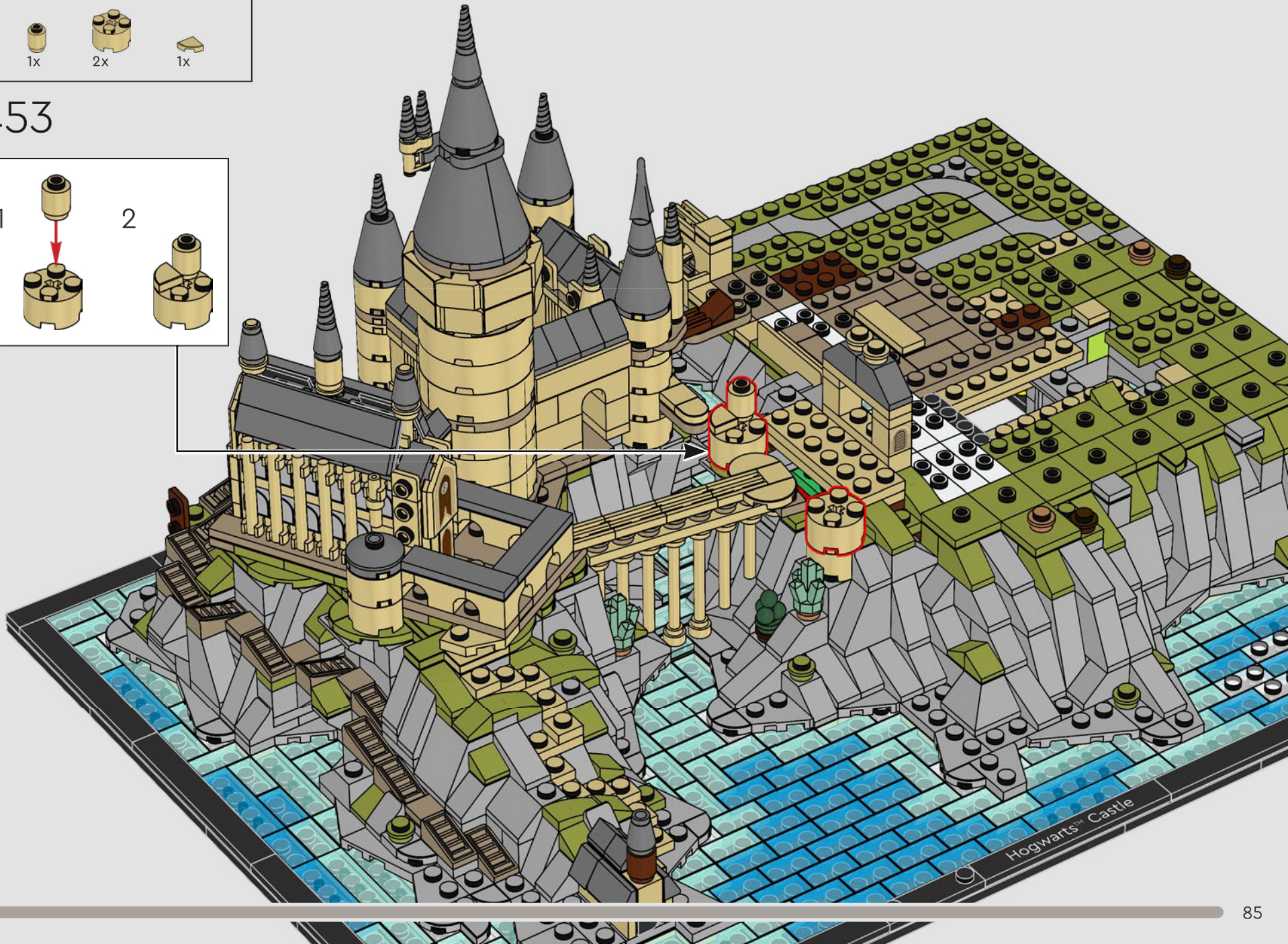
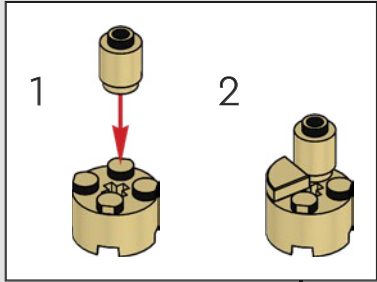



3x

454

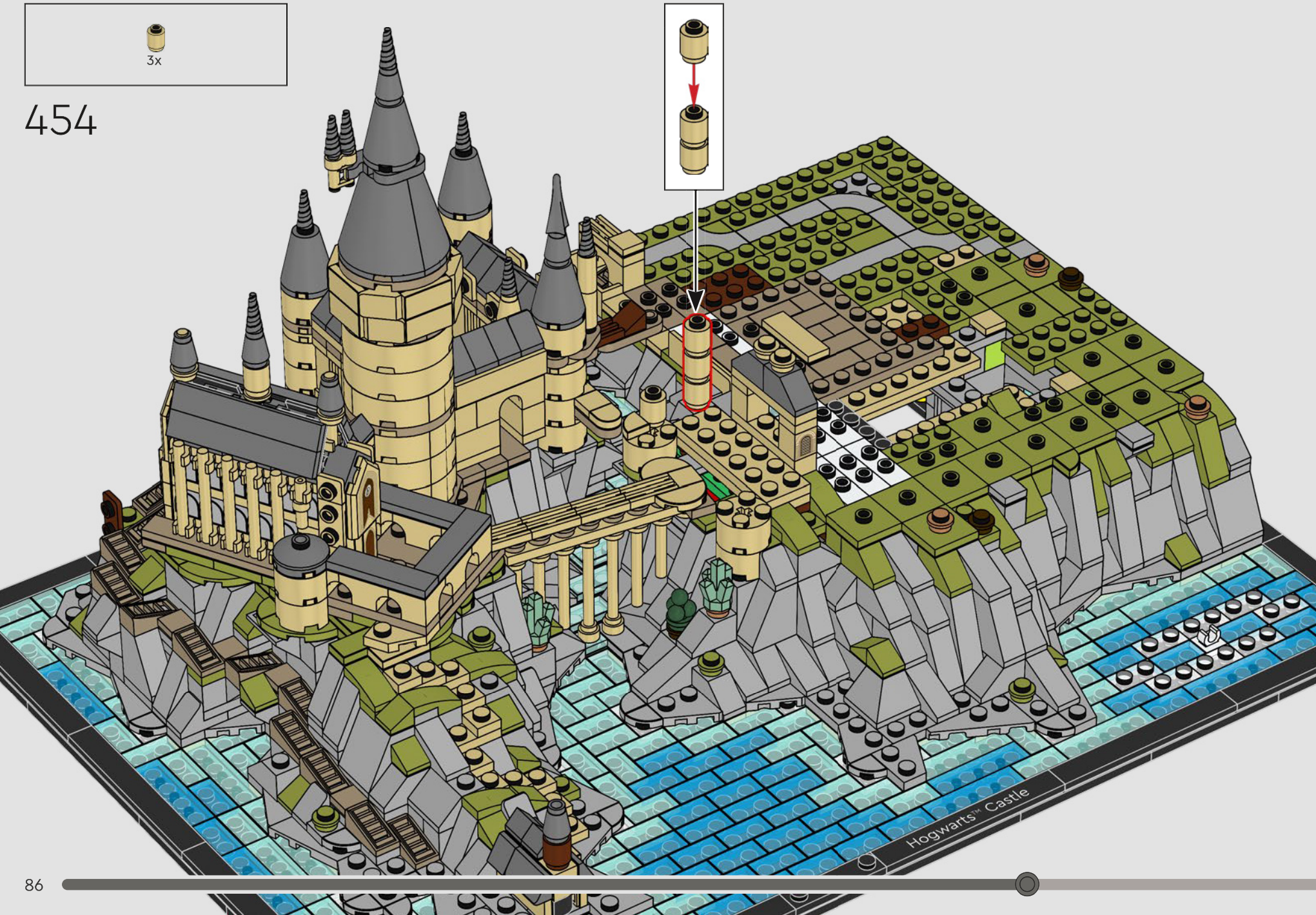
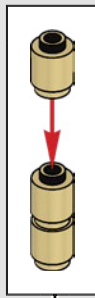

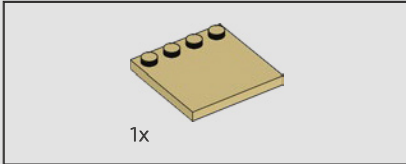
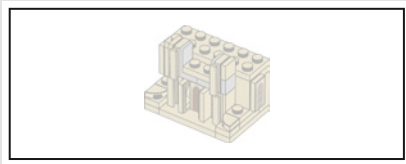

455

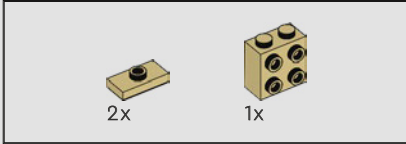
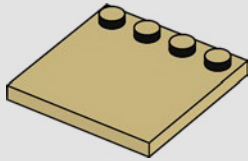

456

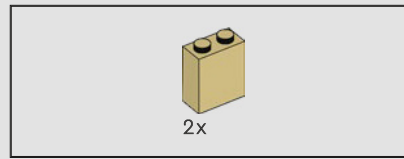
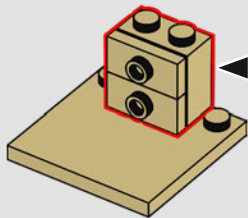
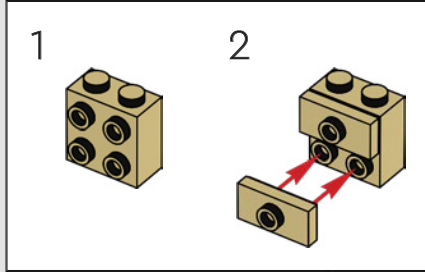

457

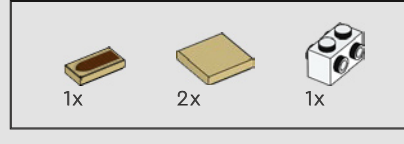
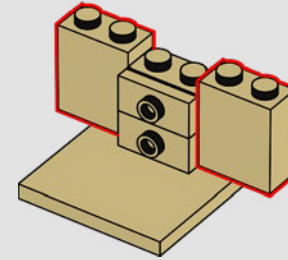

458

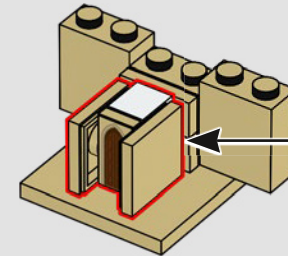
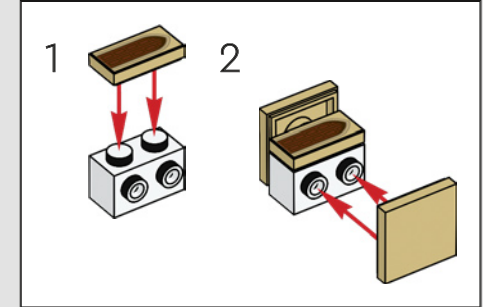

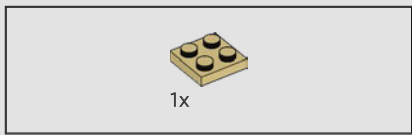

459

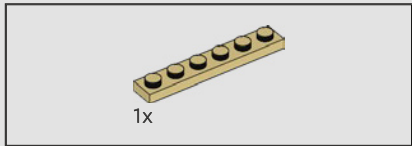
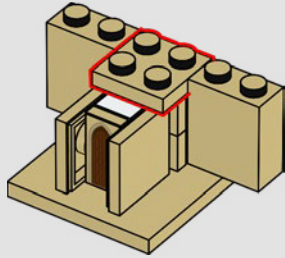

460

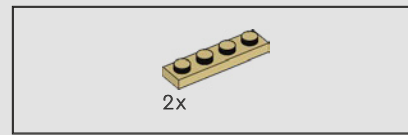
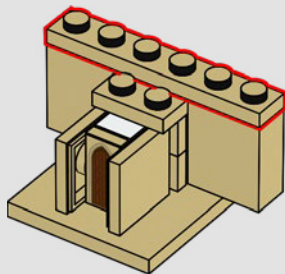

461

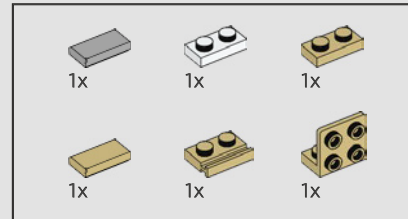
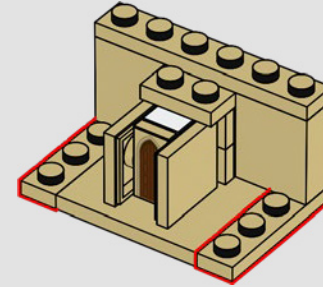

462

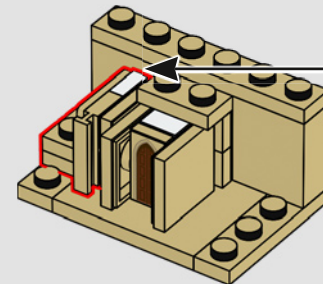
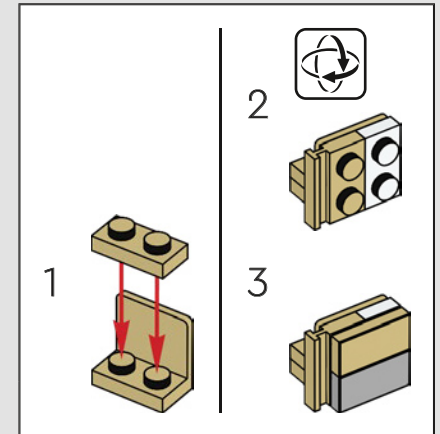



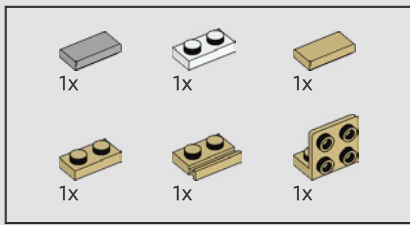

463

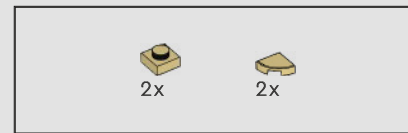
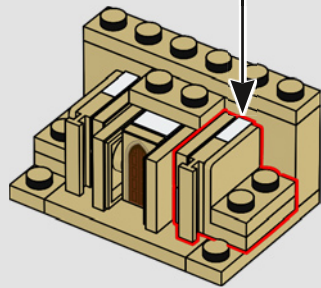
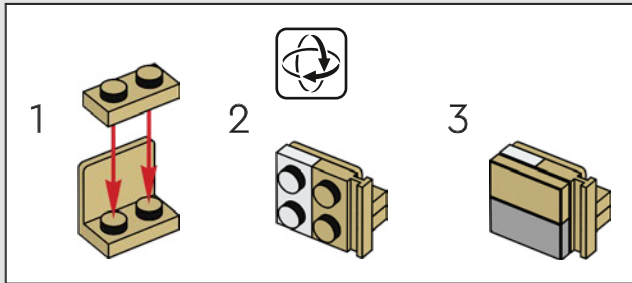

464

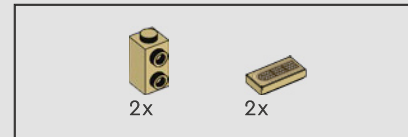
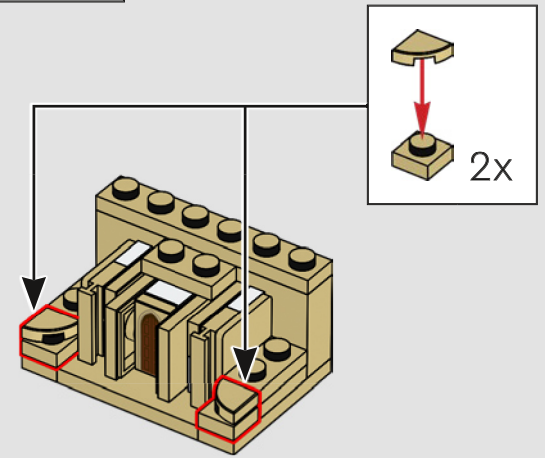

465

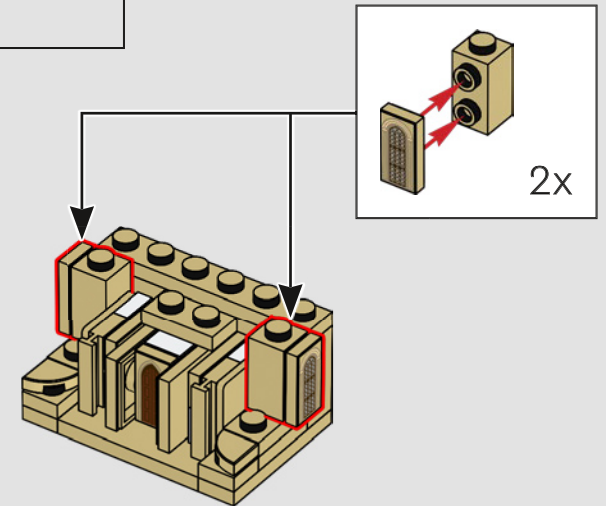

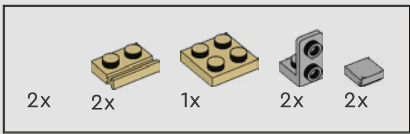

466

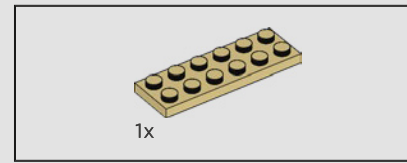
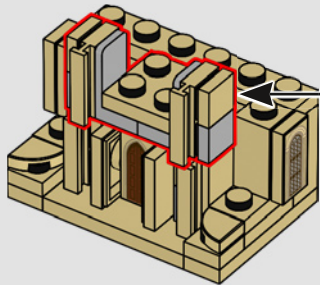
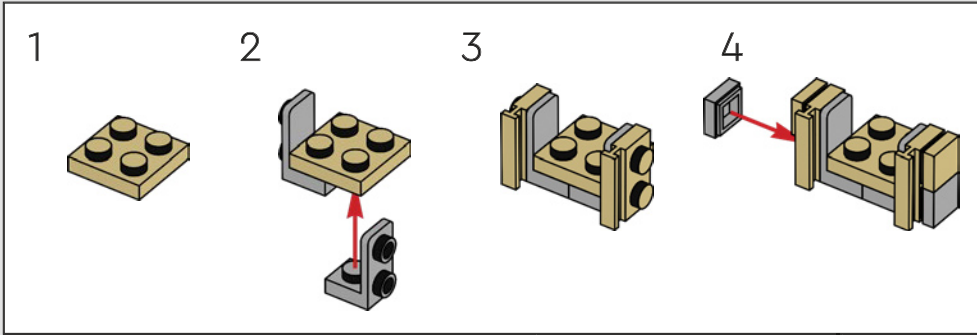

467

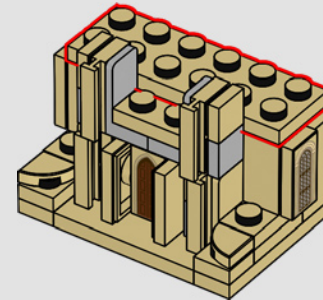

468

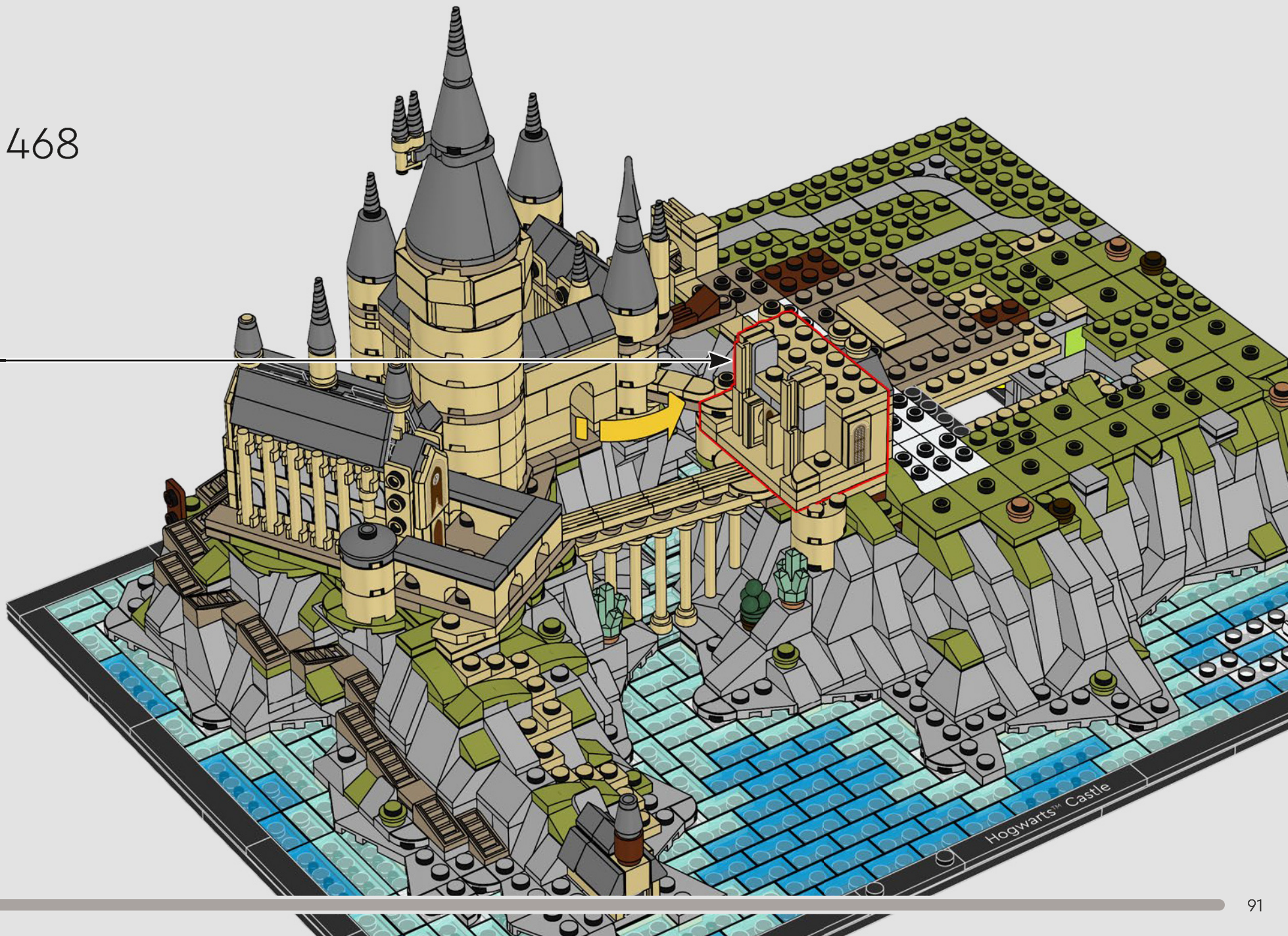

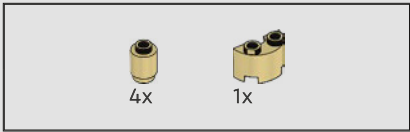

469

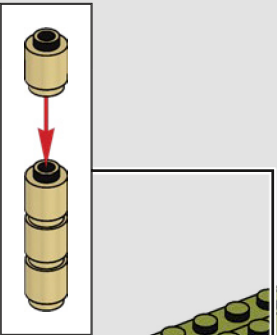

Hogwarts™ Castle



470

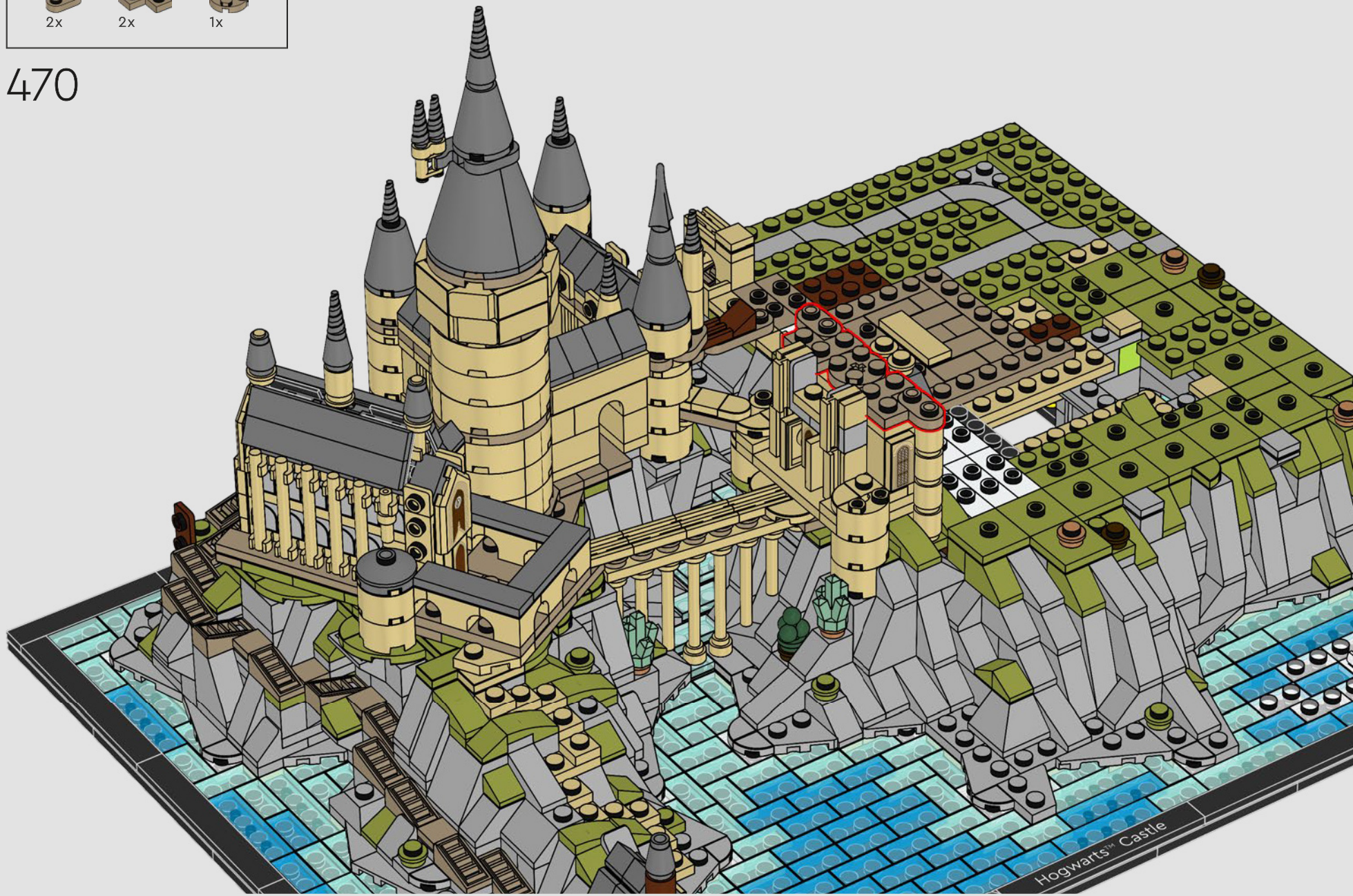

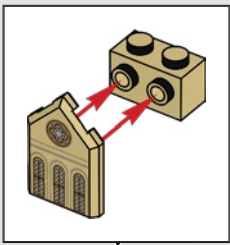
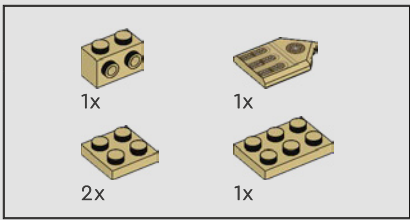

471

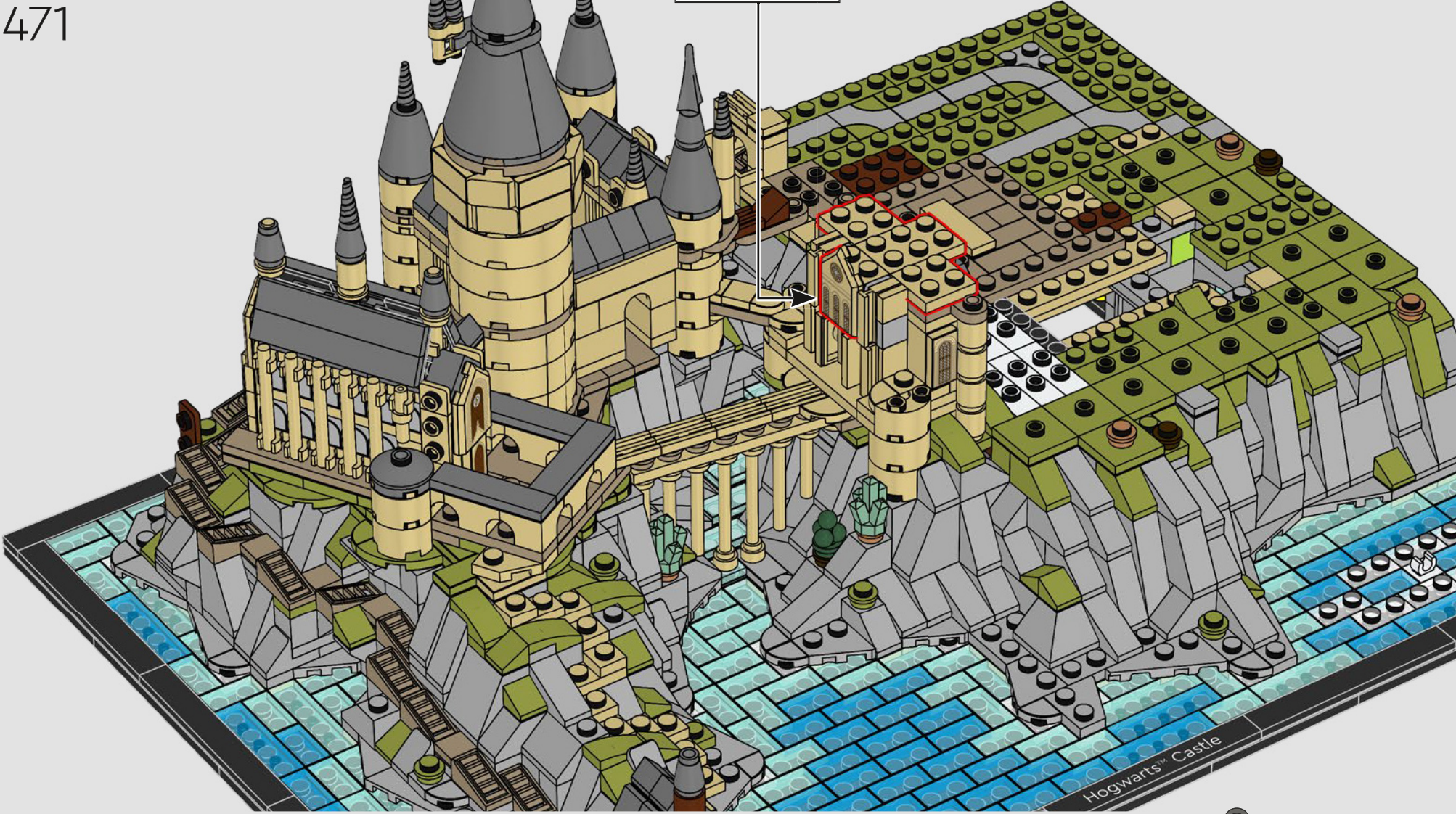

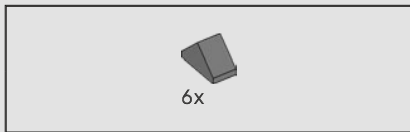

472

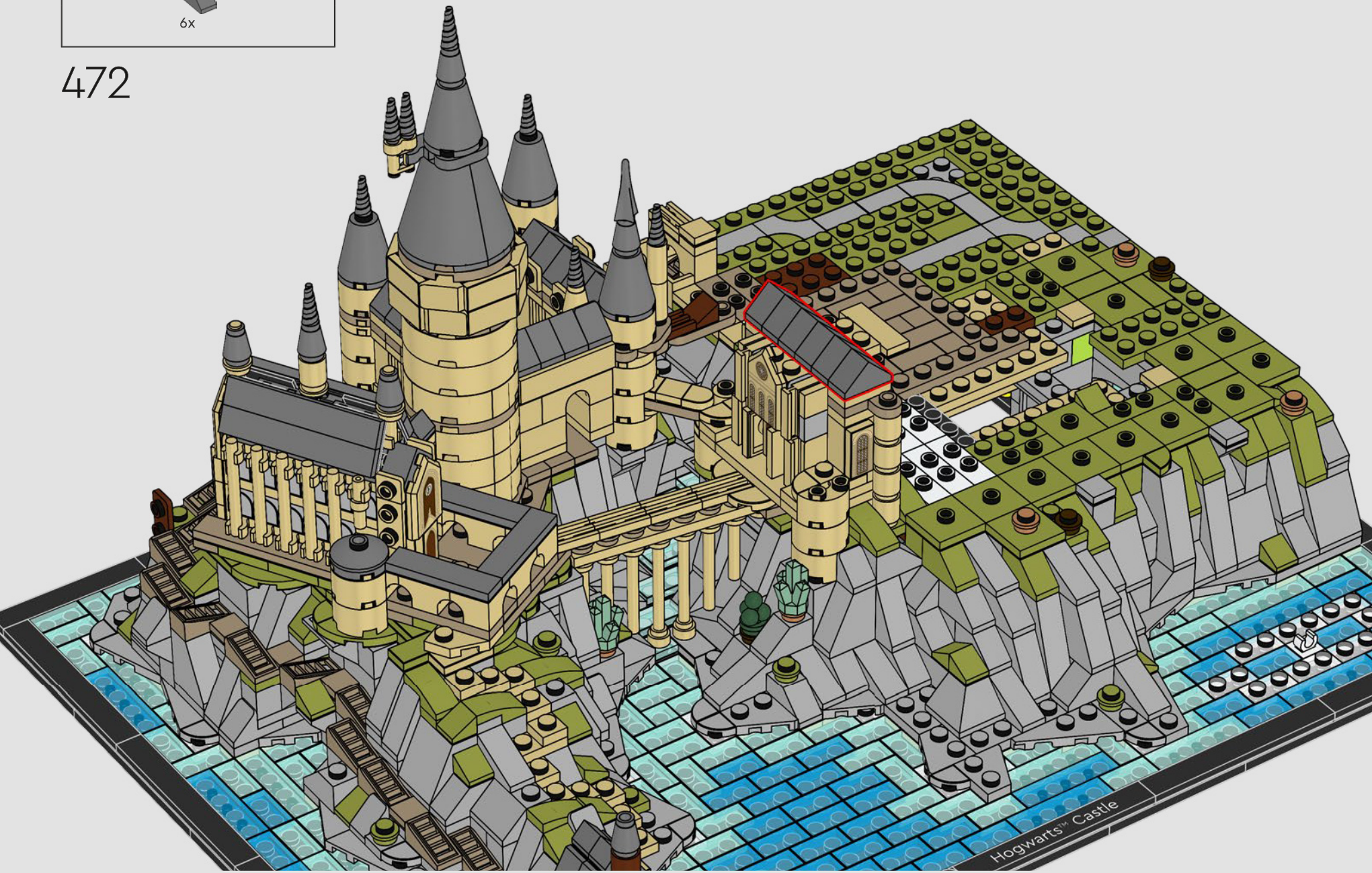

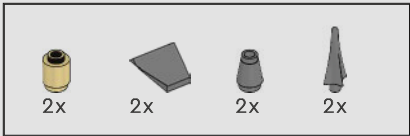

473

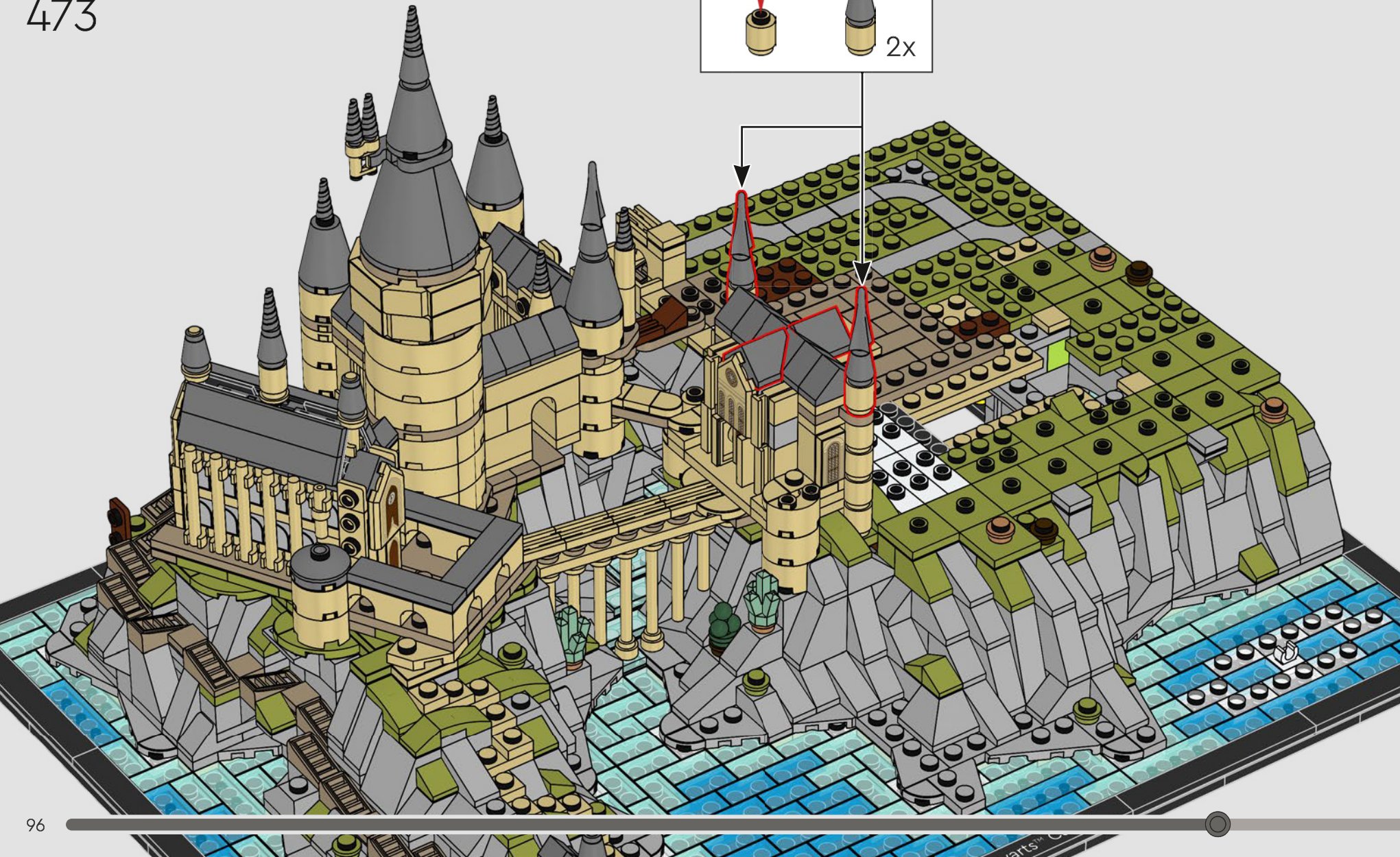
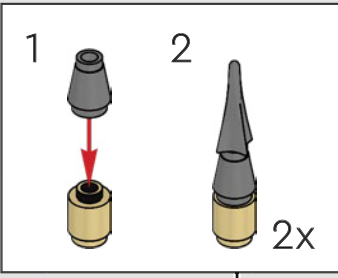



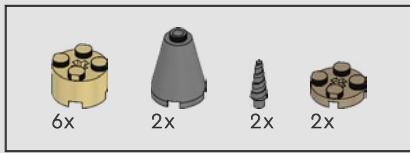

474

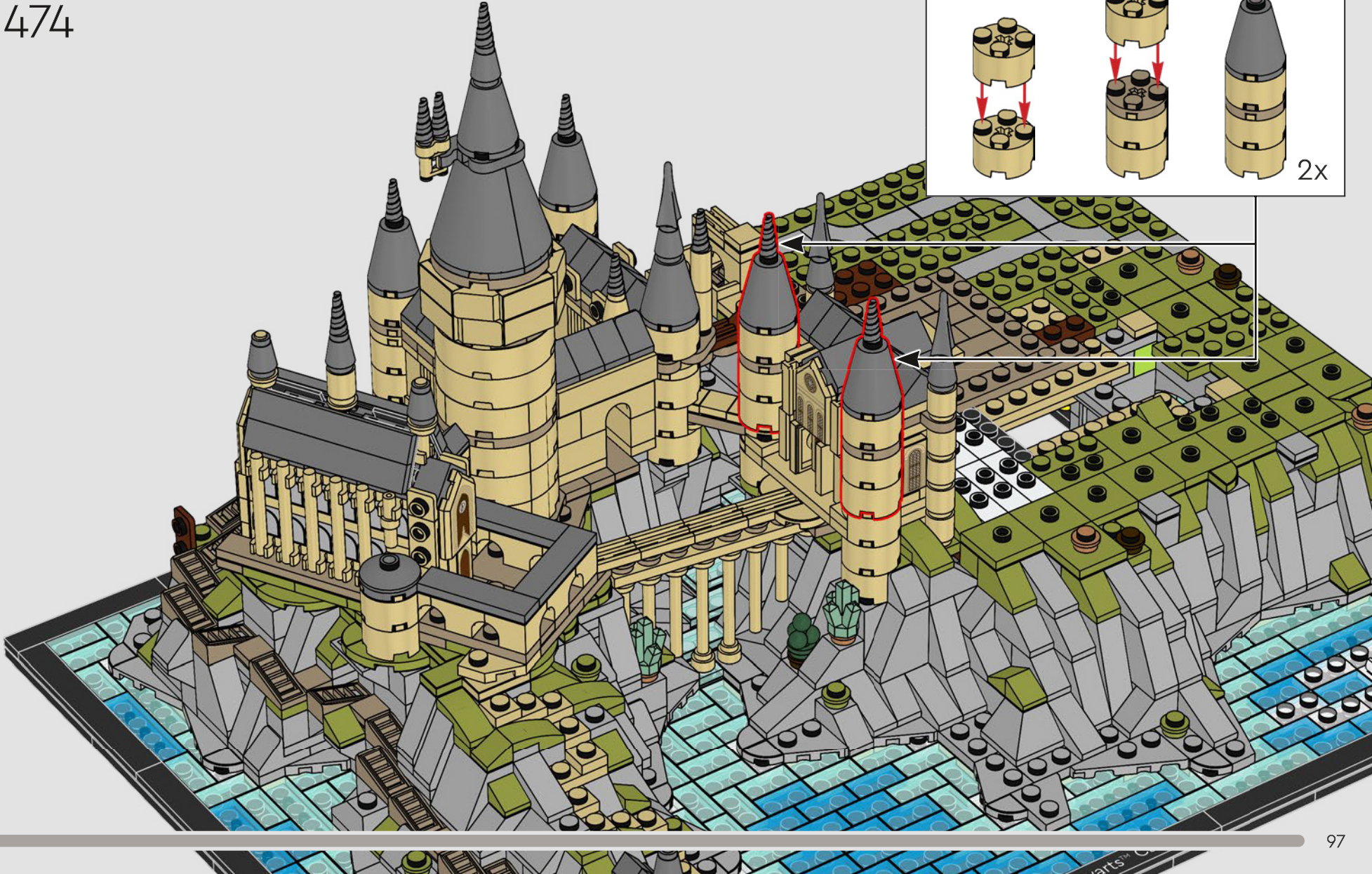
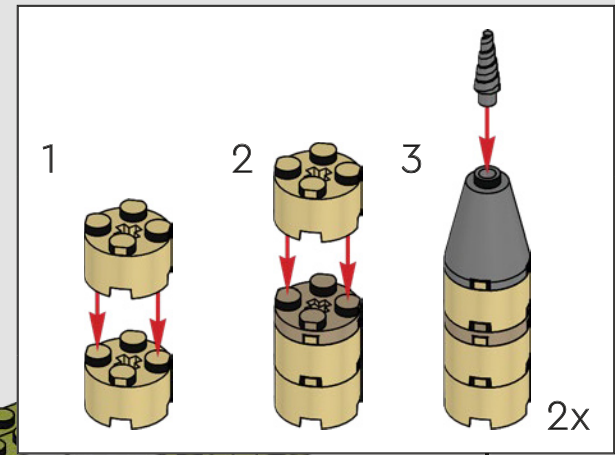

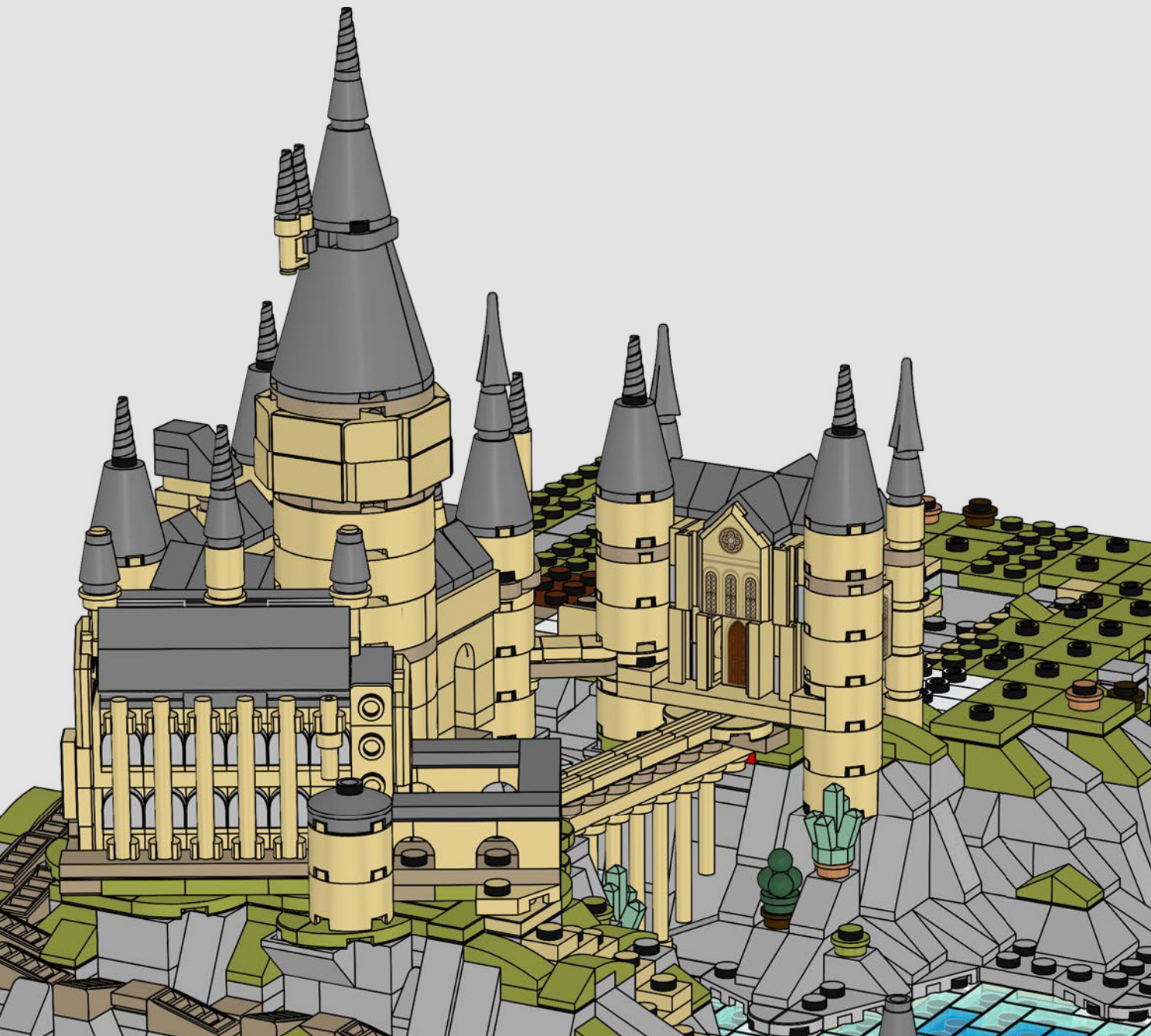

The girls' lavatories are located in this part of the castle. Maybe Moaning Myrtle™ will stop by as you build. Just watch out for trolls.





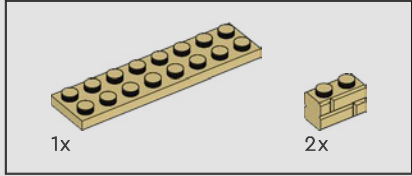
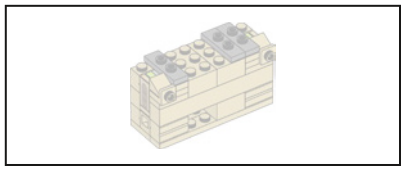

475

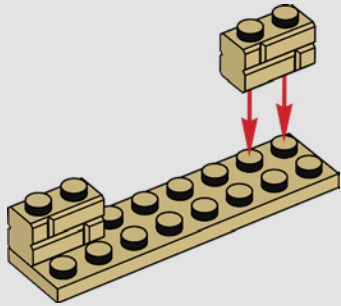

476

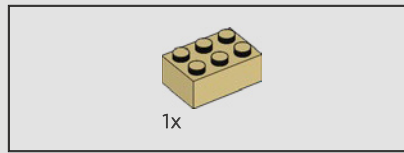
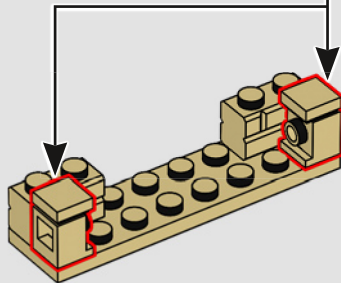
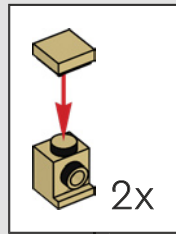

477

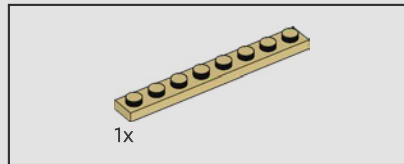
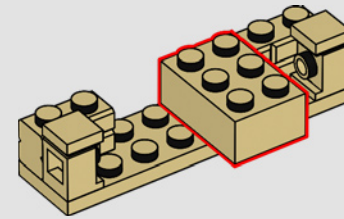

478

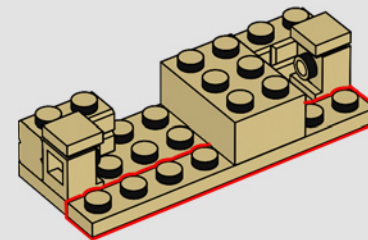

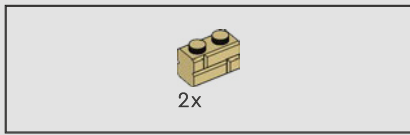

479

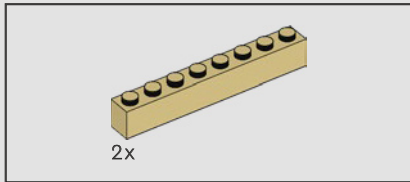
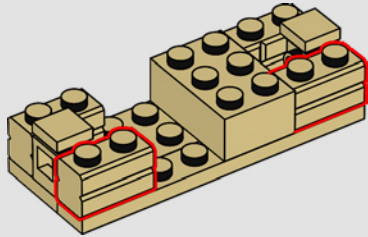

480

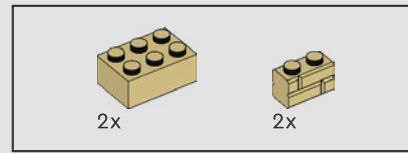
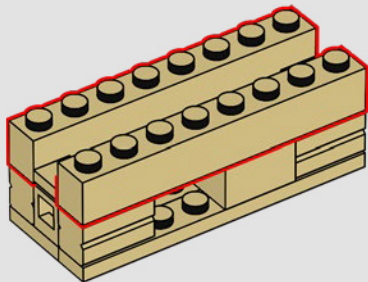

481

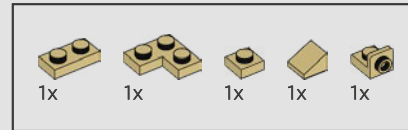
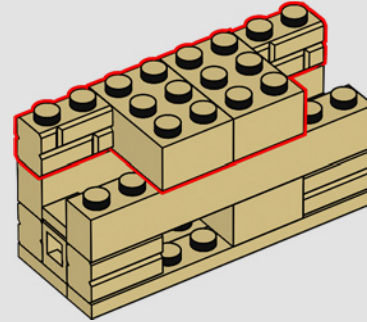

482

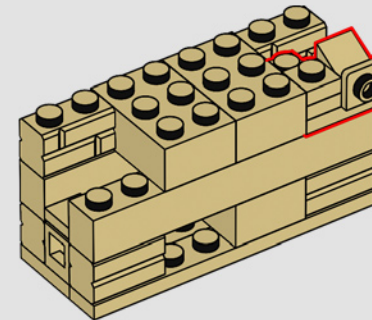
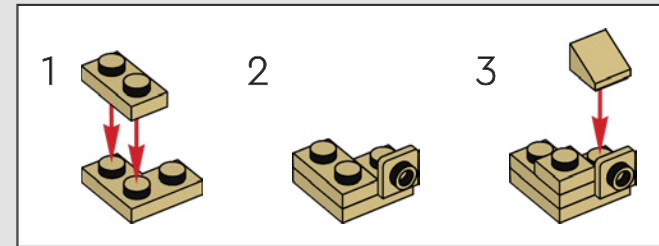

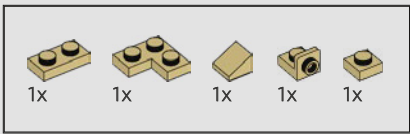

483

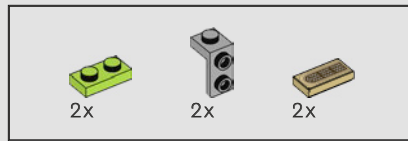
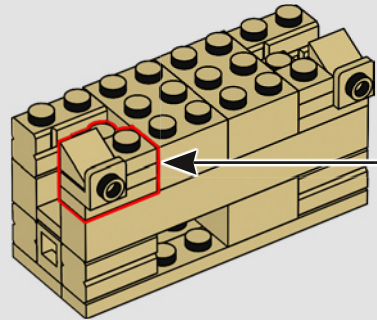
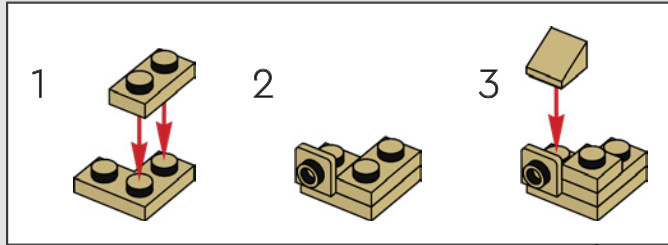

484

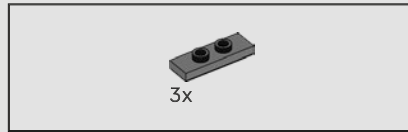
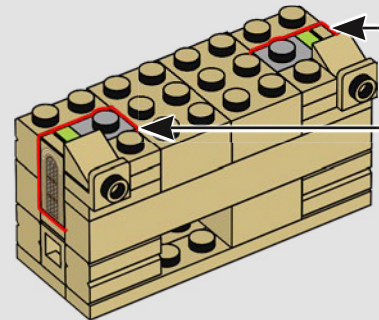
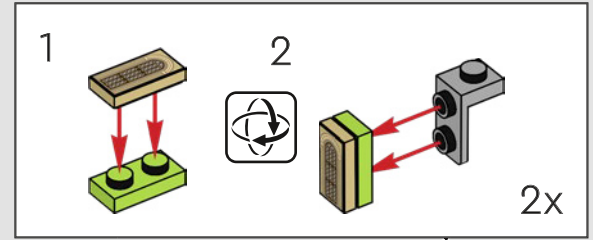

485

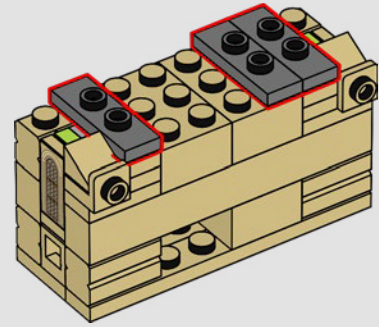

486



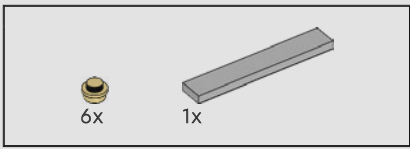

487

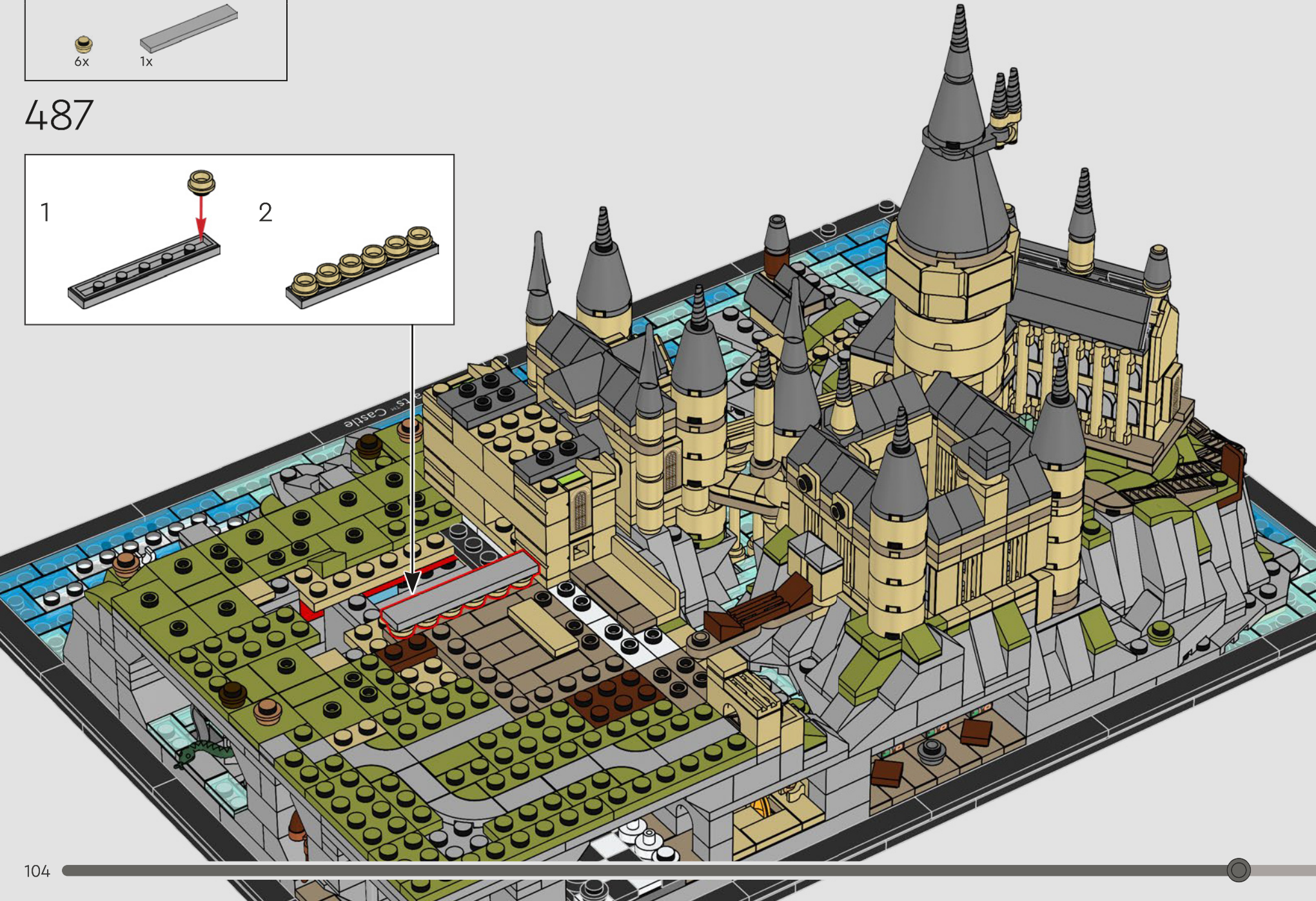
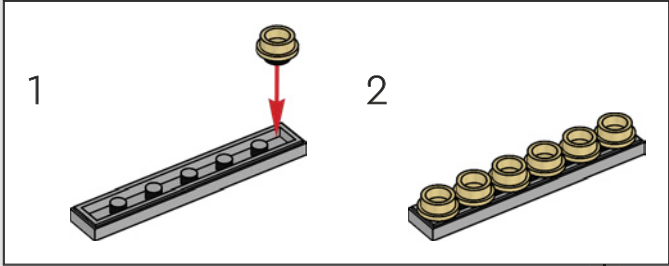



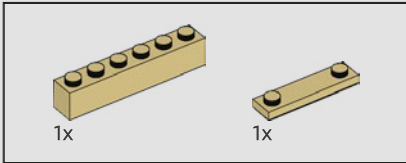
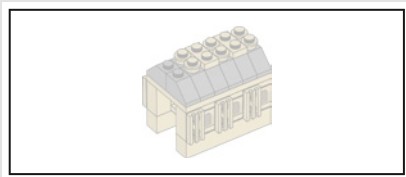

488

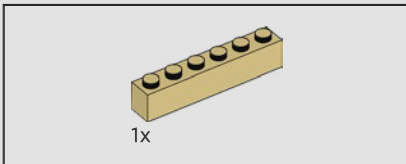
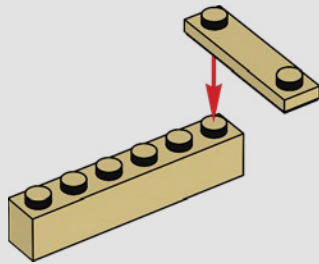

489

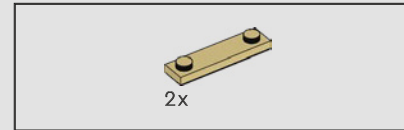
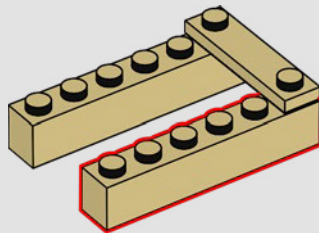

490

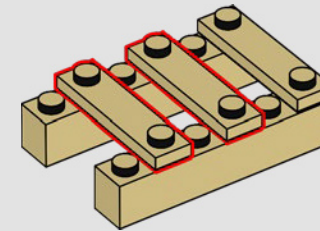

491

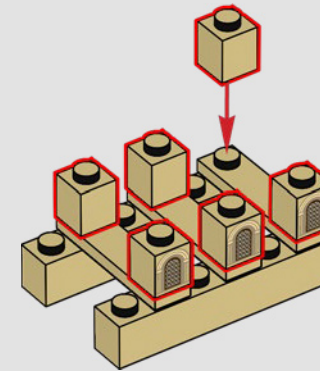

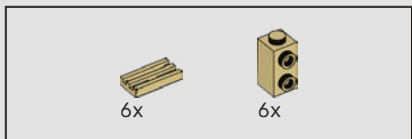

492

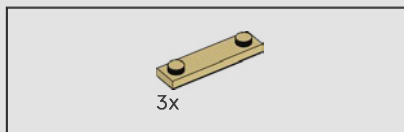
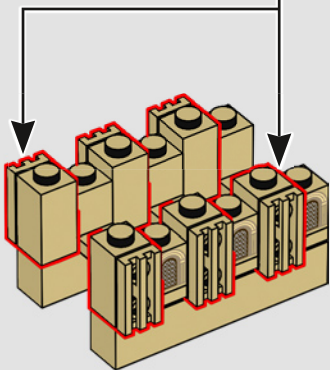
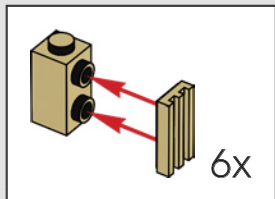

493

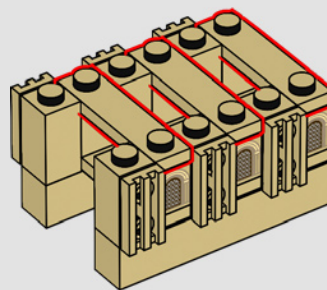

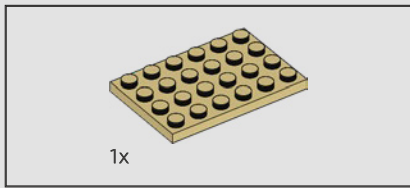

494

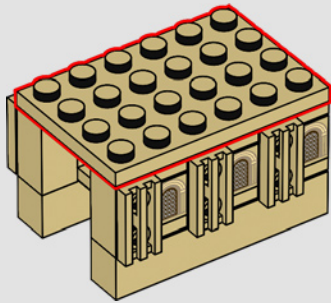

495

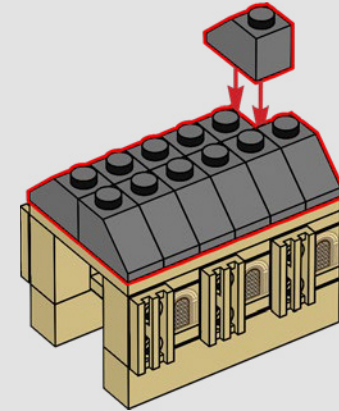

496

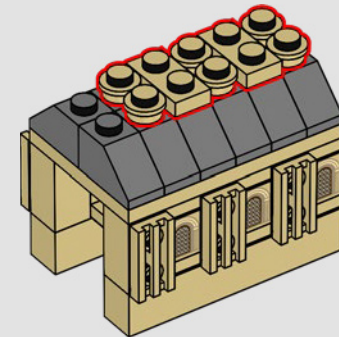

497

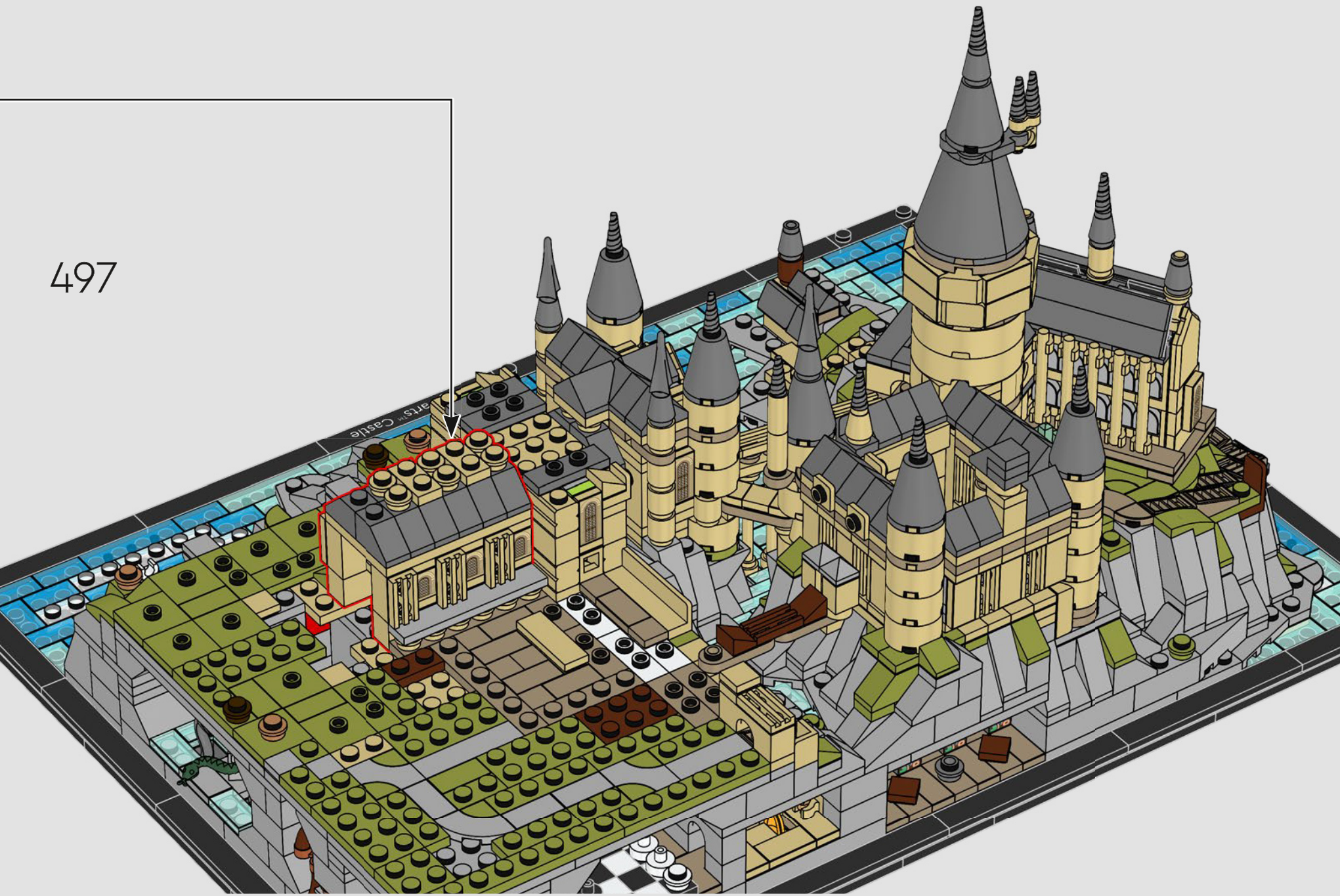

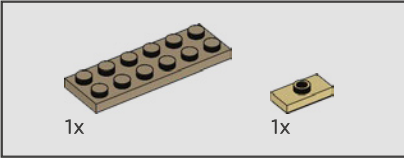
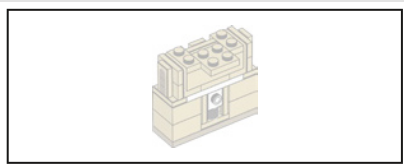

498

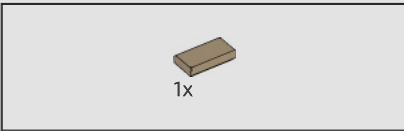
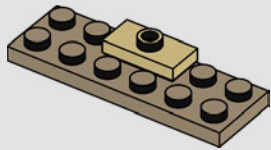

499

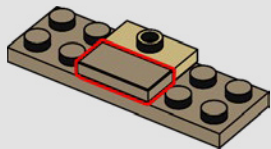

500

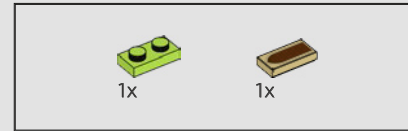
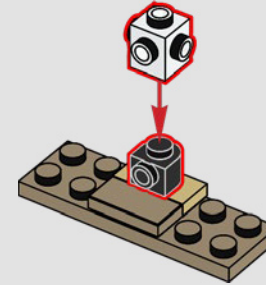

501

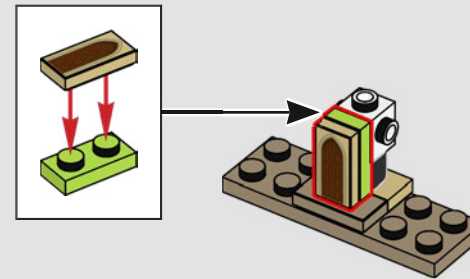

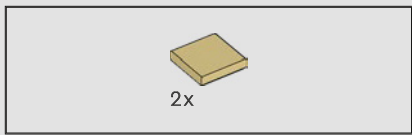

502

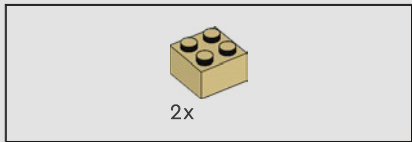
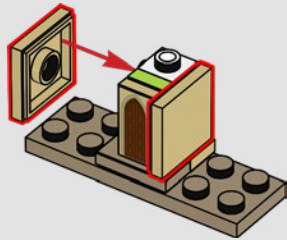

503

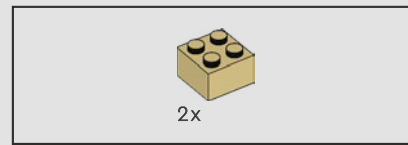
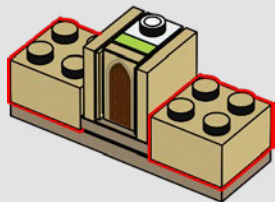

504

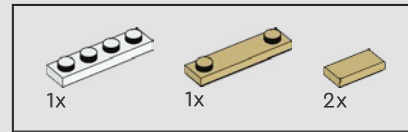
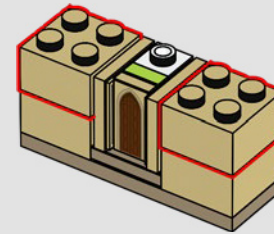

505

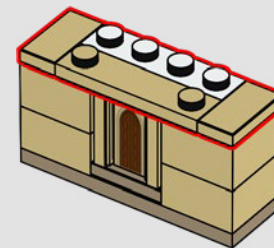

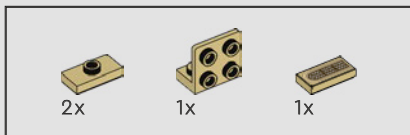

506

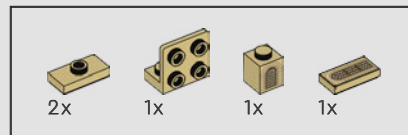
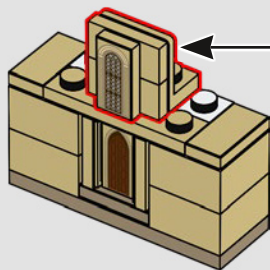
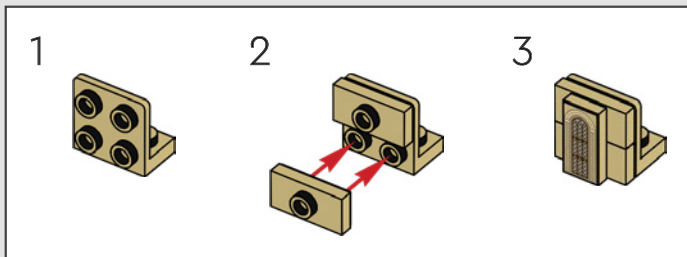

507

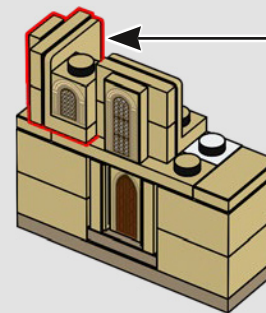
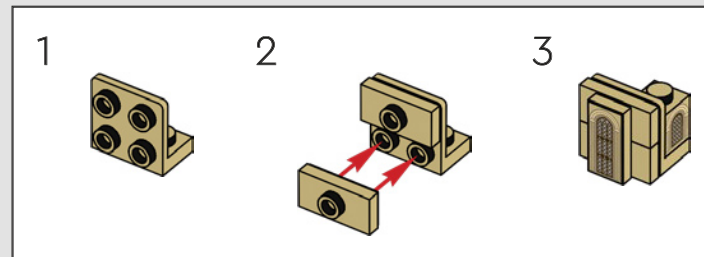

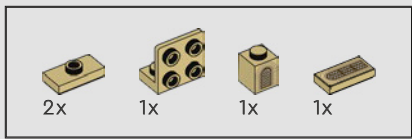

508

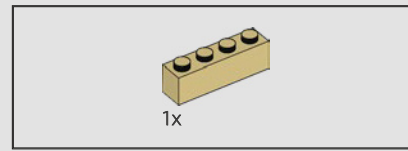
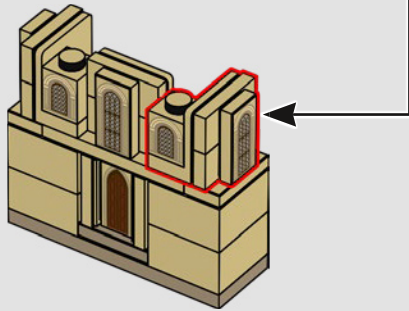
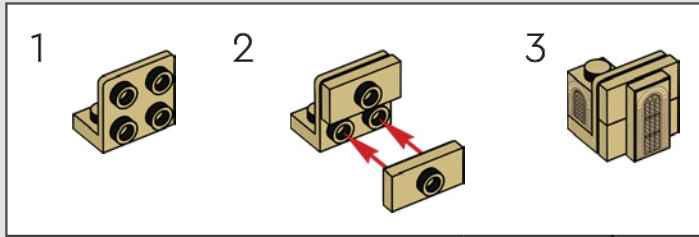

509

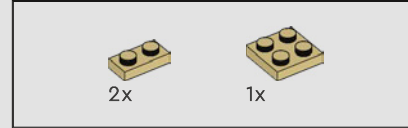
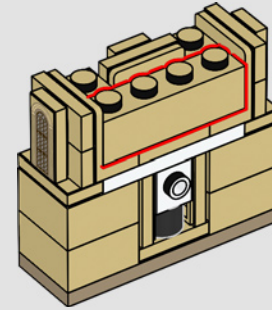

510

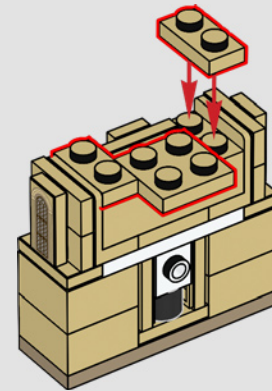



511





2x



2x



2x



2x



2x



2x



2x



2x



2x

512

1

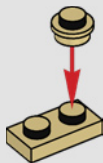

2

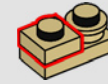

3

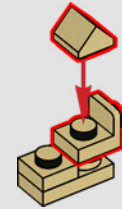

4

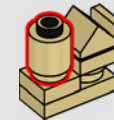

5

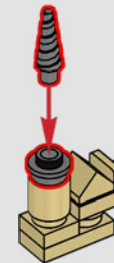

2x



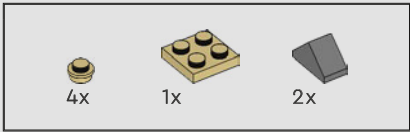

513

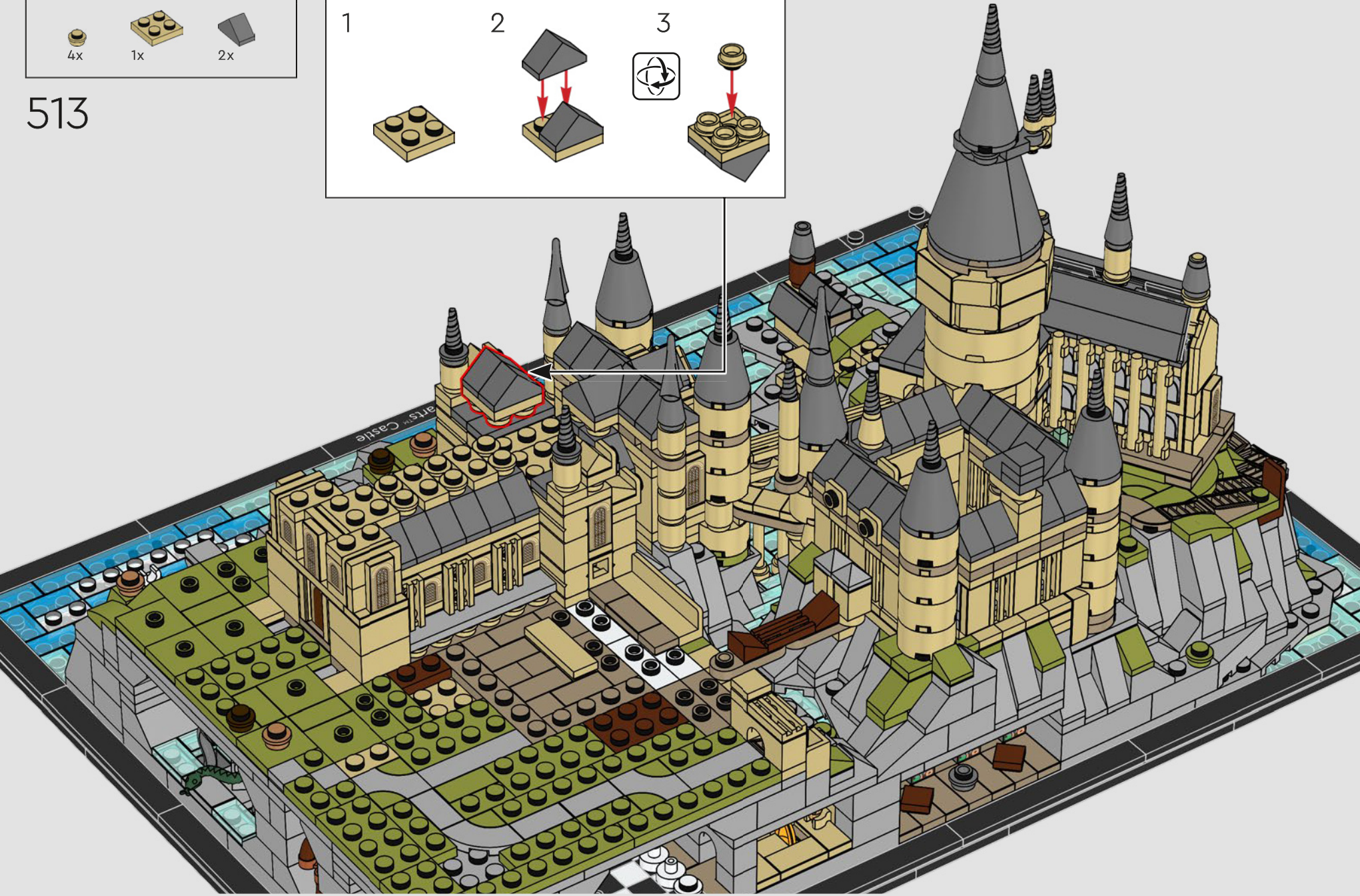
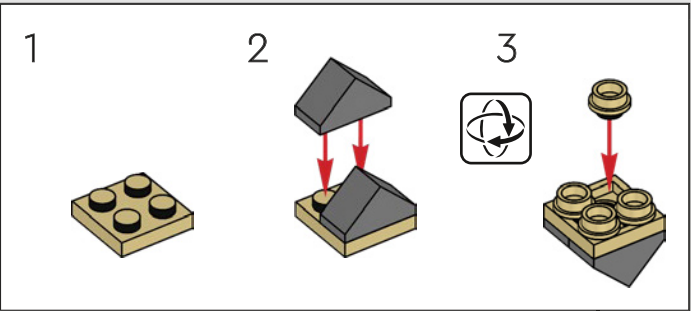

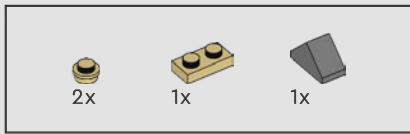

514

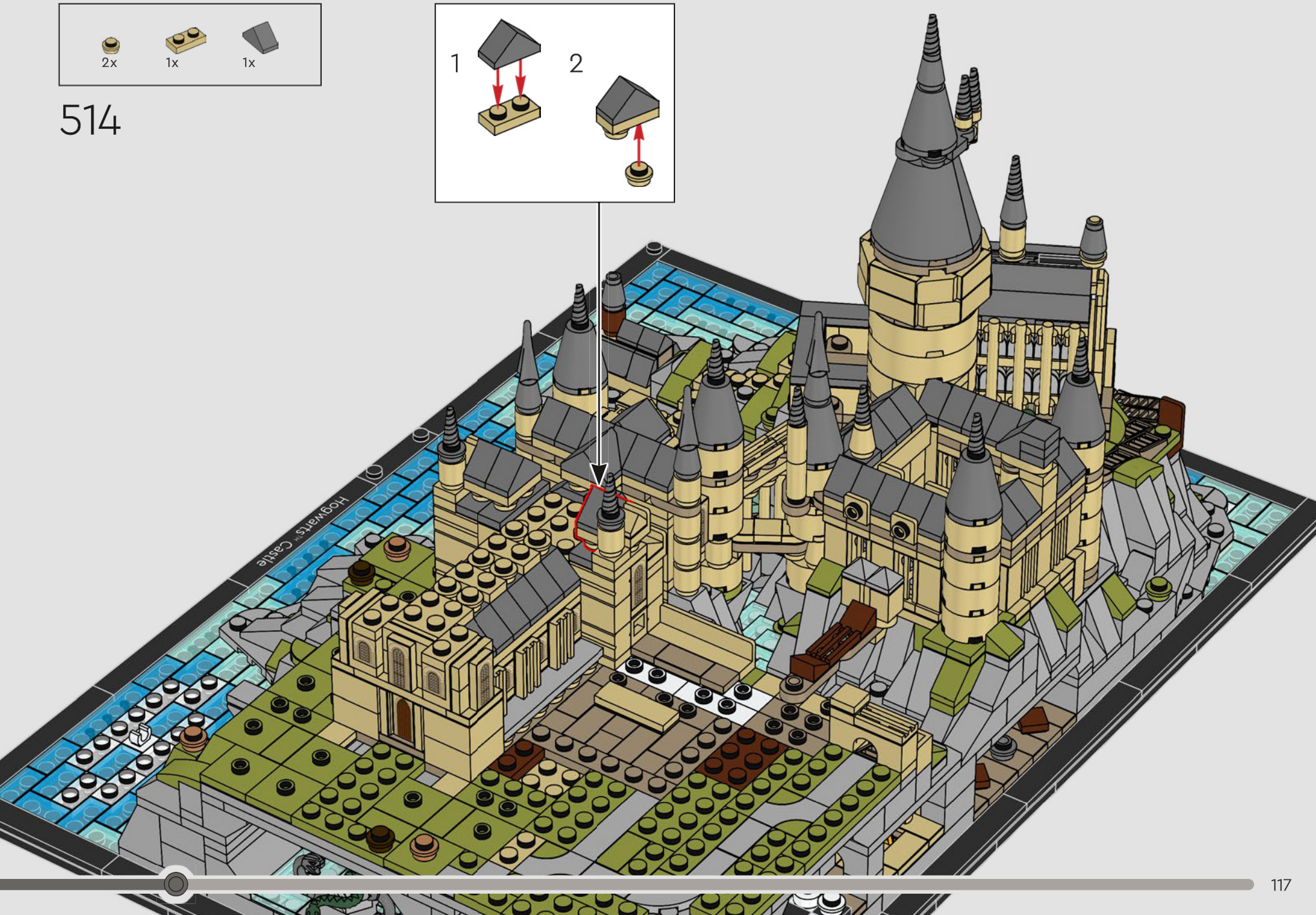
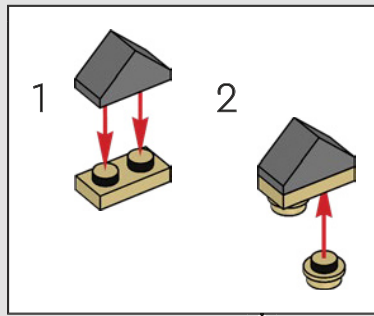

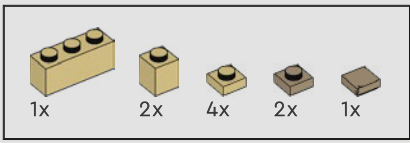

515

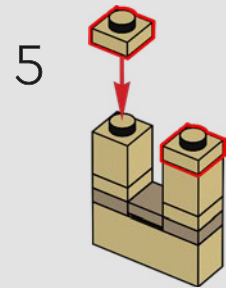
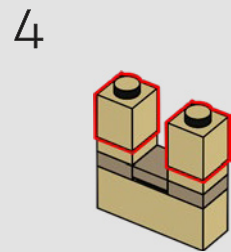
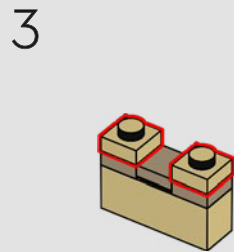
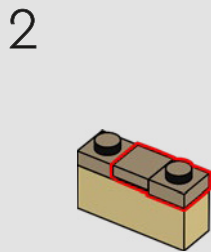
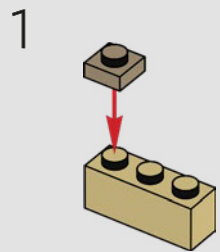

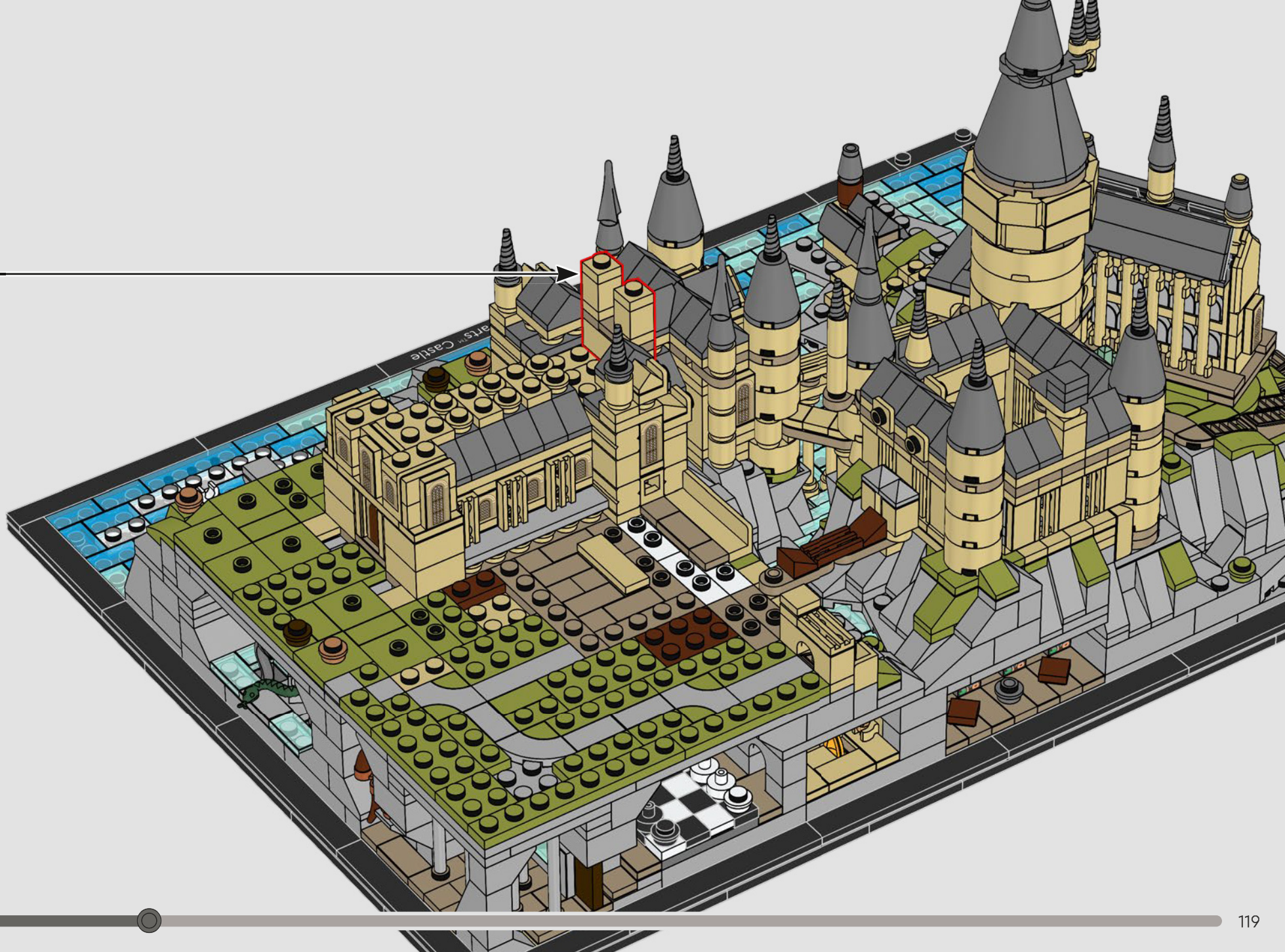

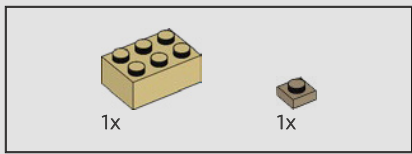

516

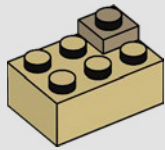

517

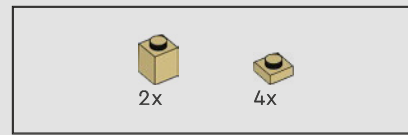
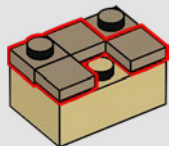

518

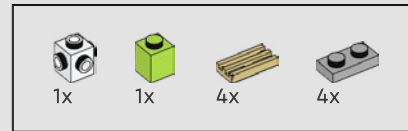
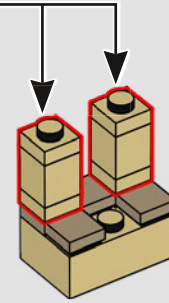
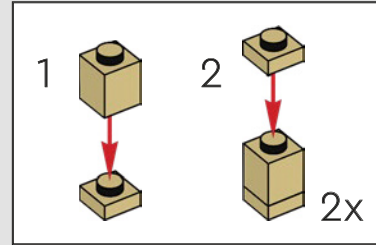

519

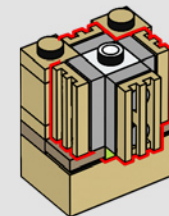
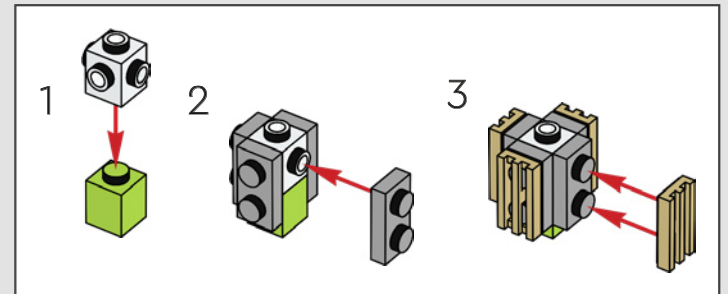



520

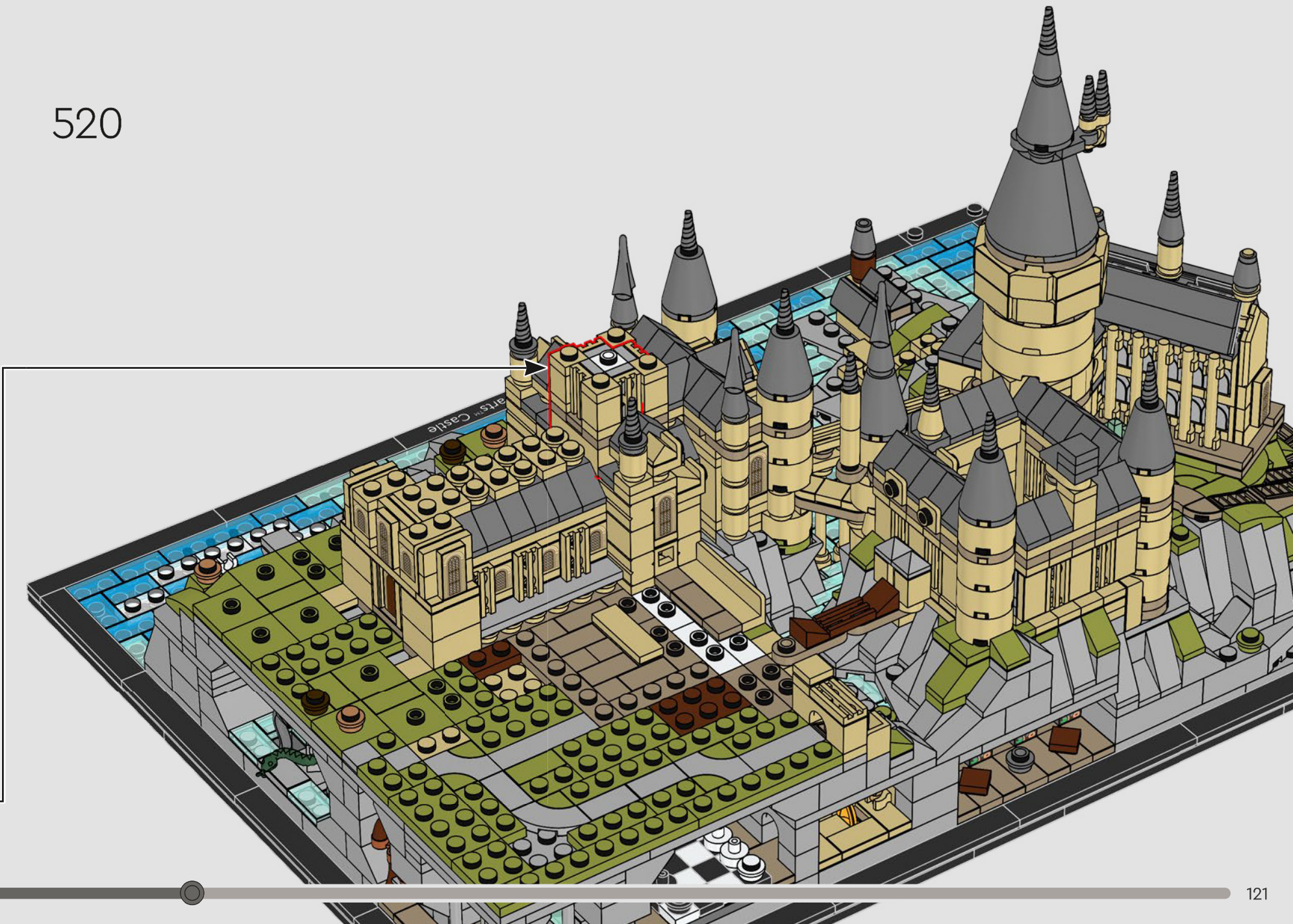

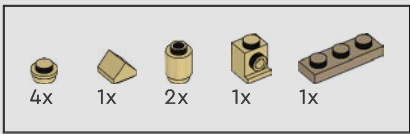

521

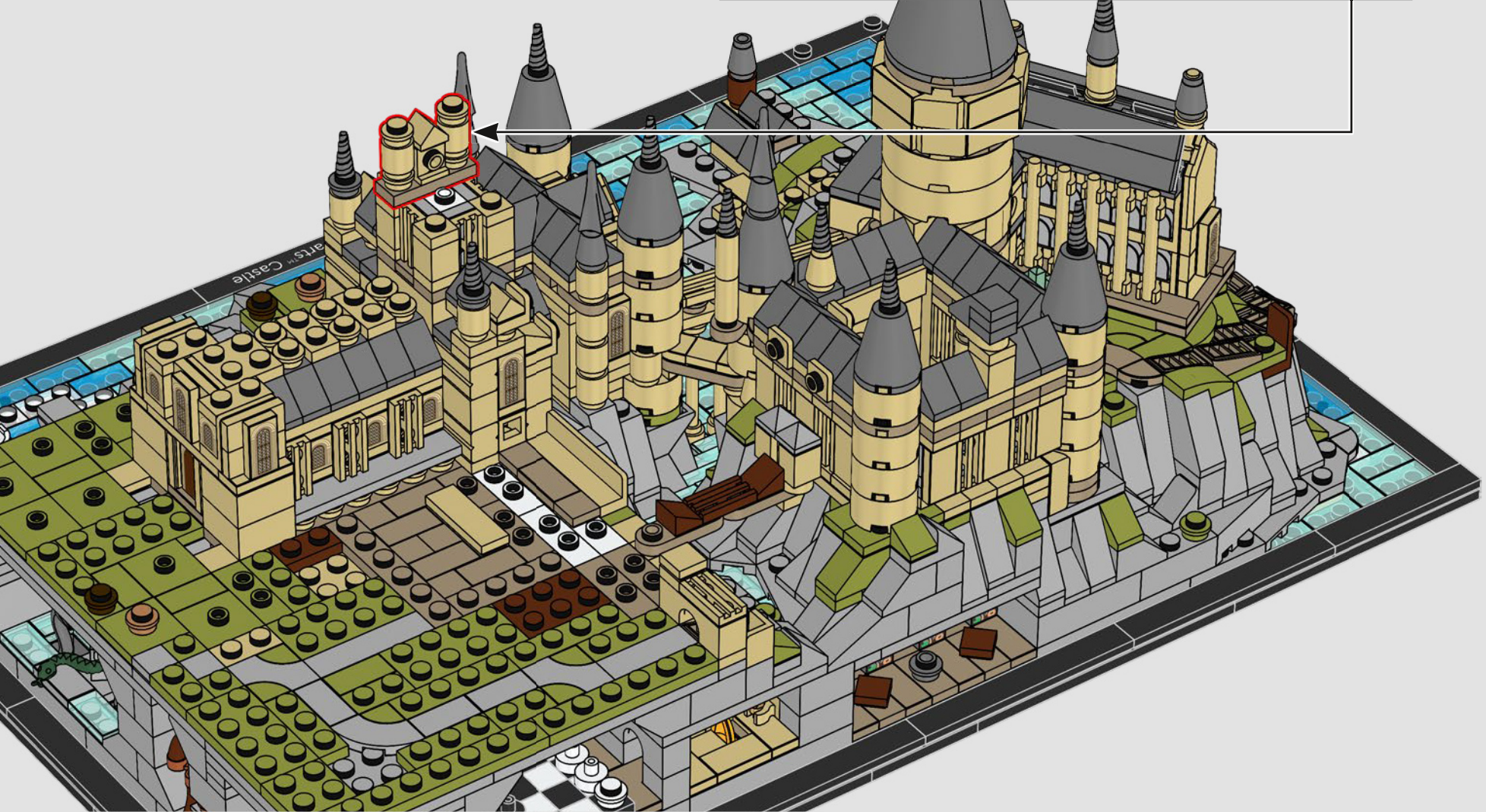
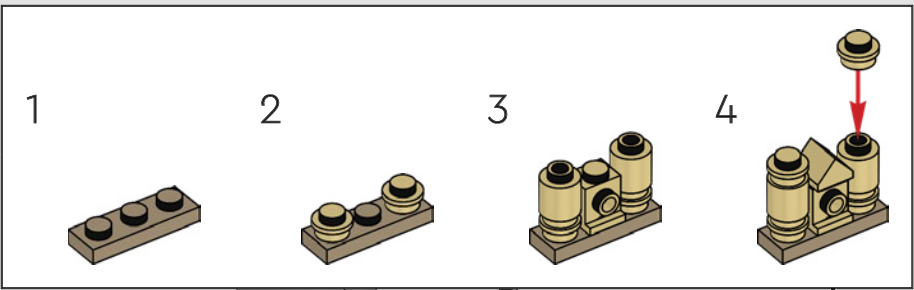

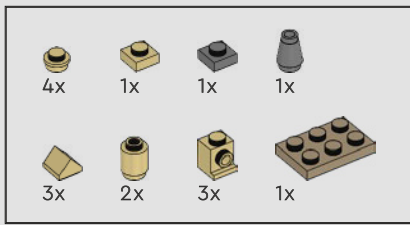

522

1

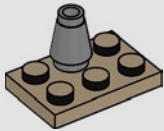

2

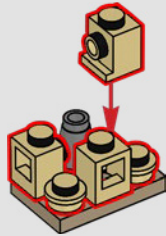

3

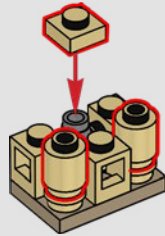

4

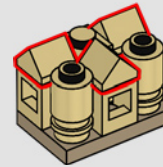

5

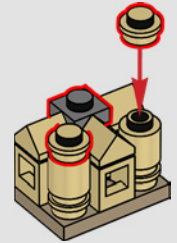

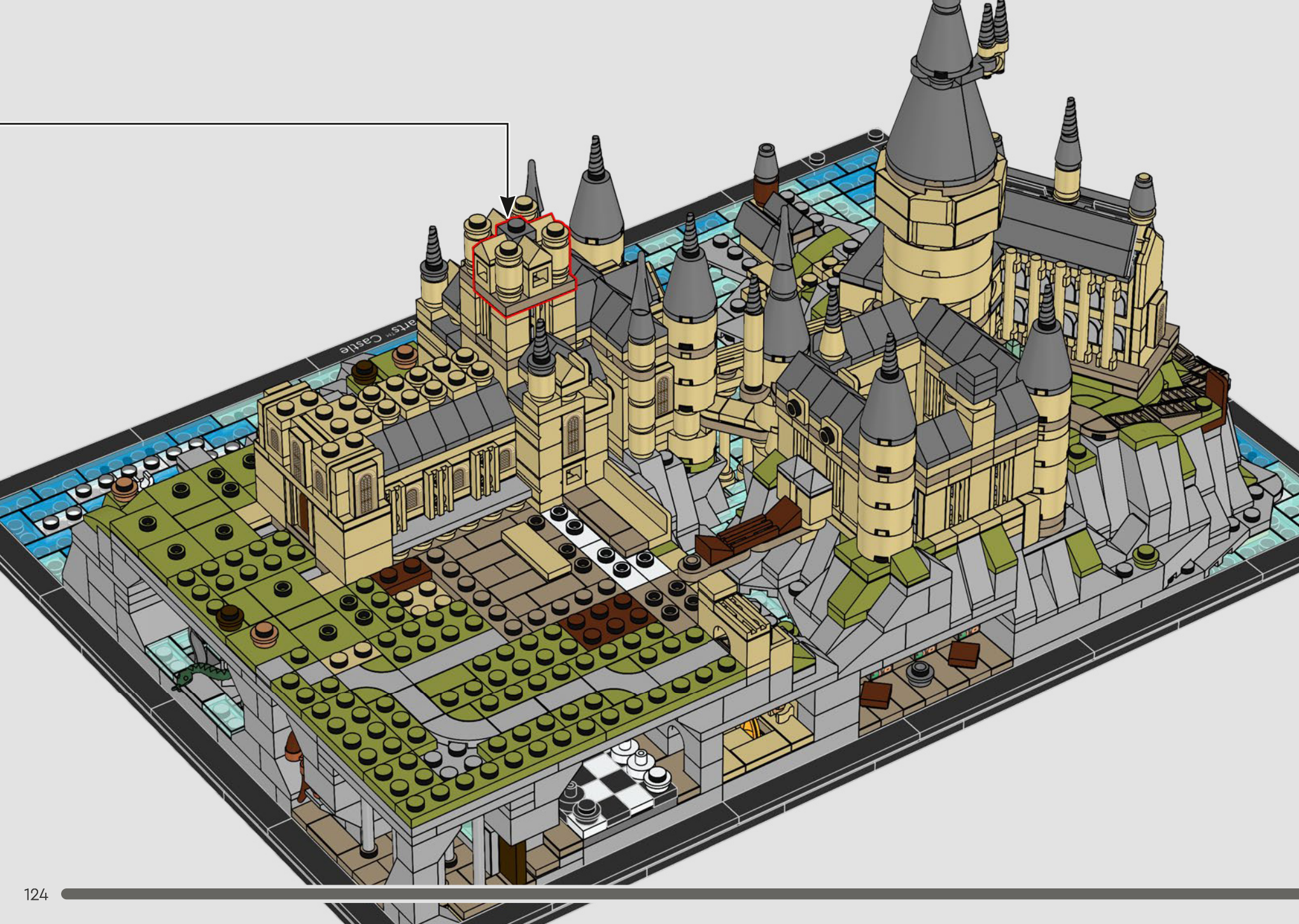

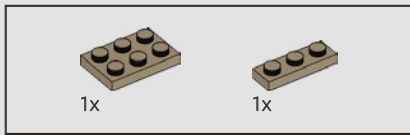

523



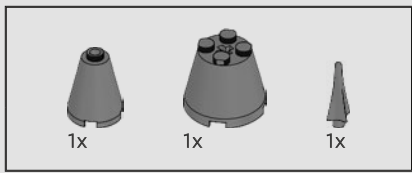

524

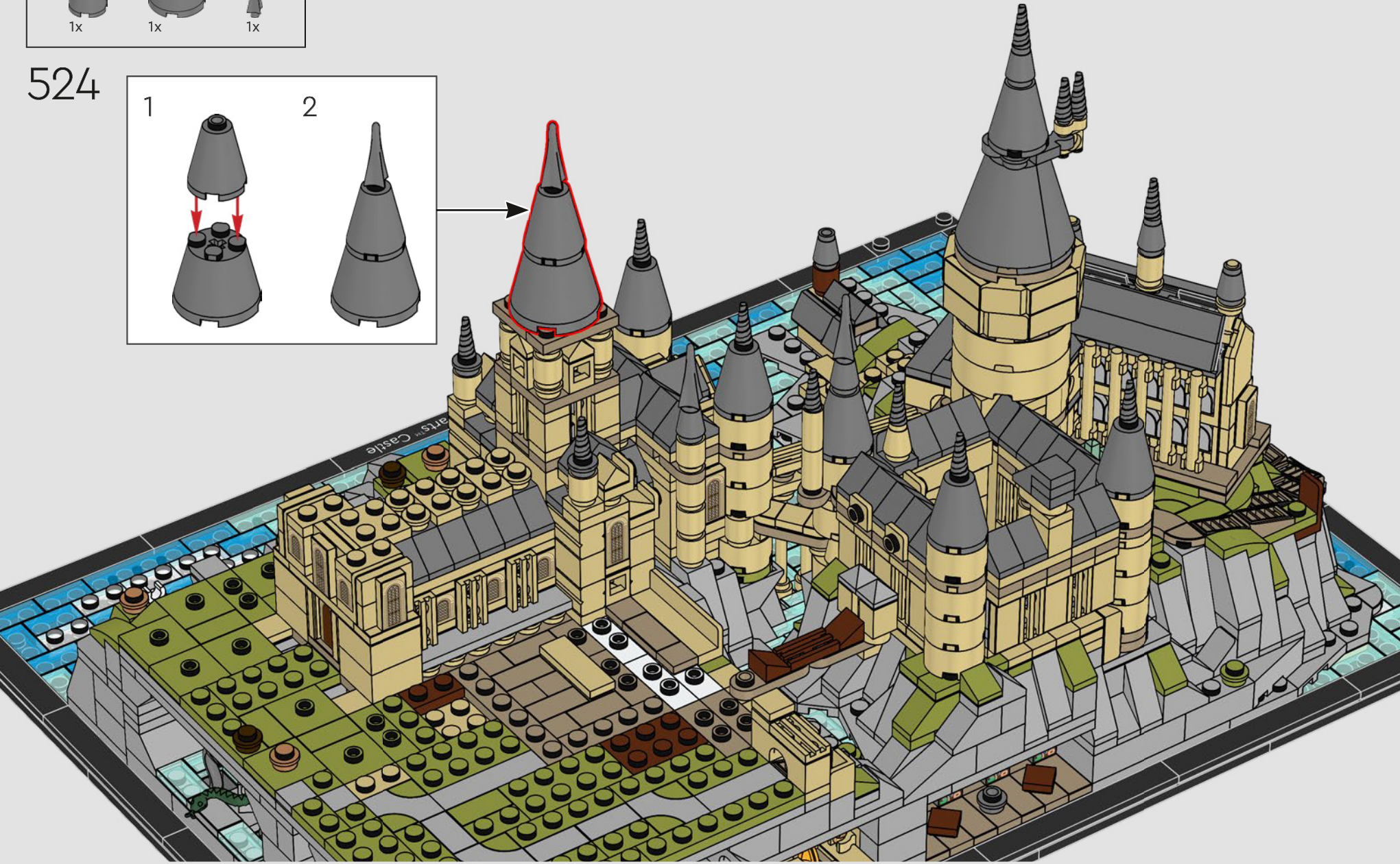
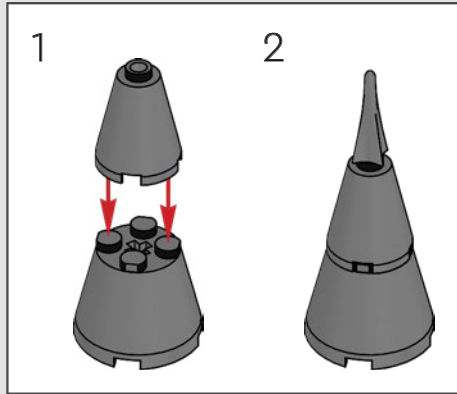

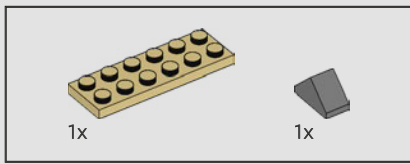

525

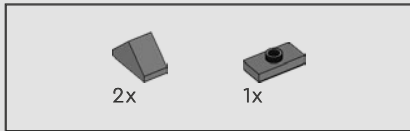
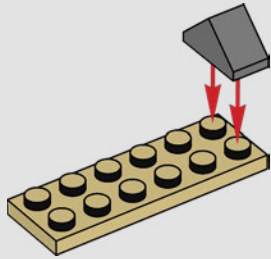

526

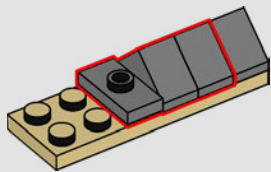

527

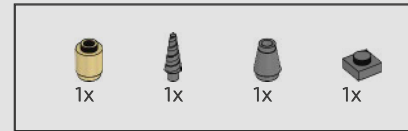
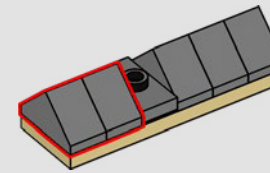

528

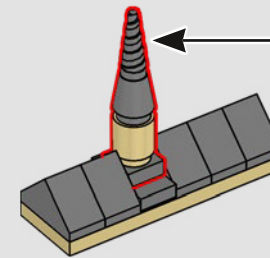
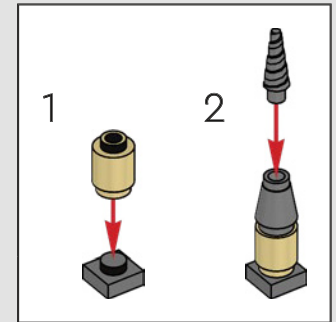

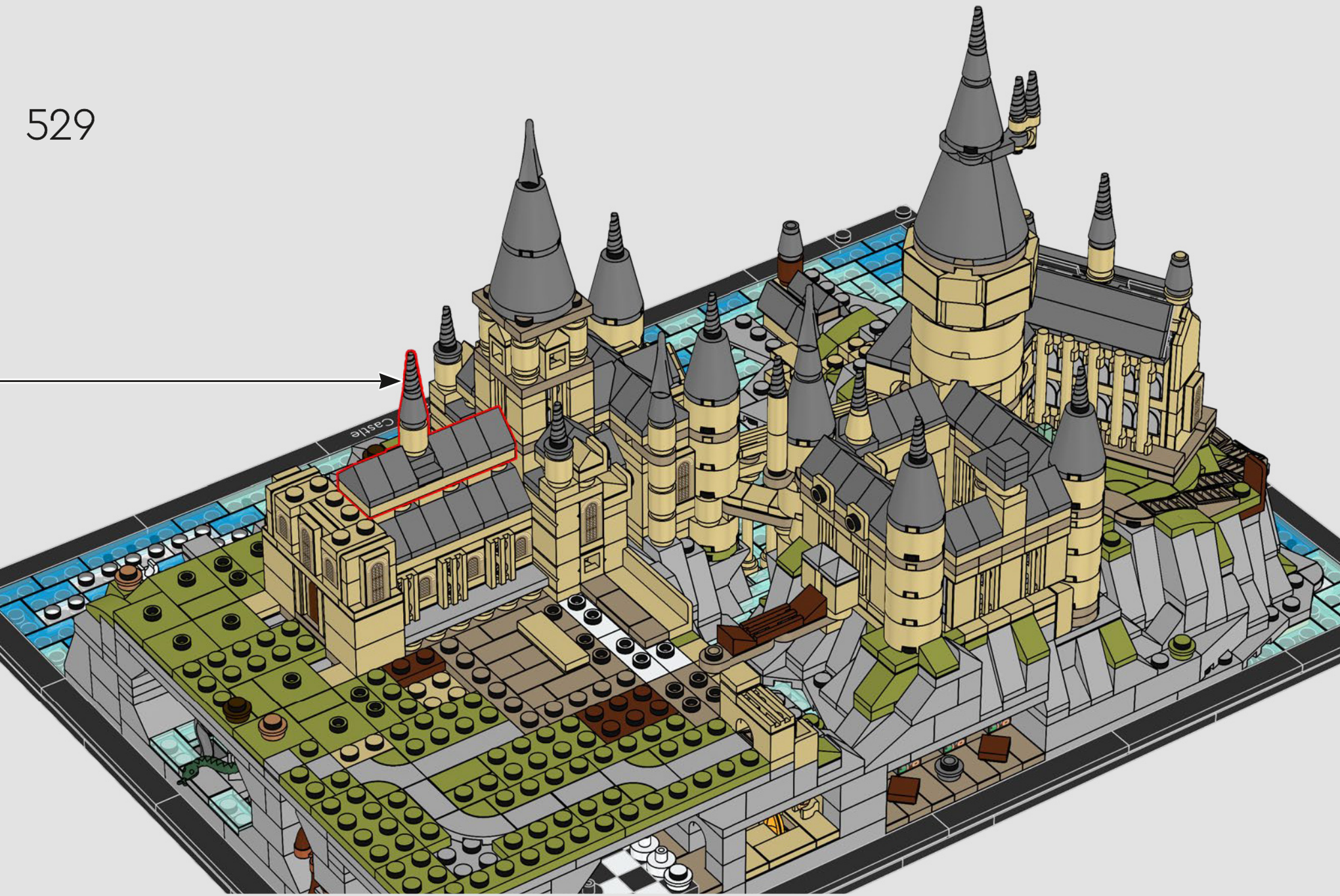



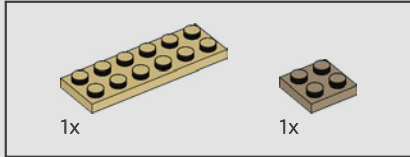
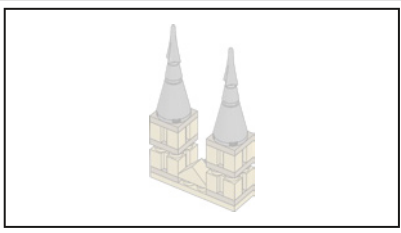

530

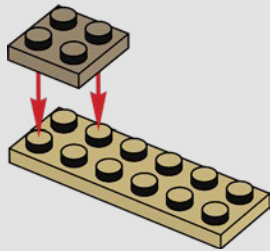

531

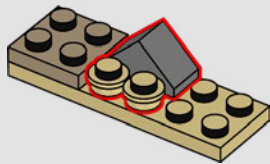

532

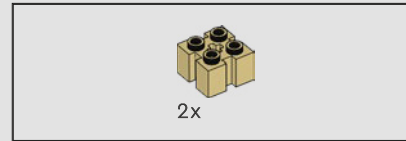
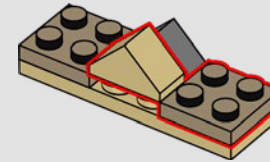

533

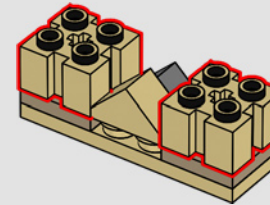



8x

534

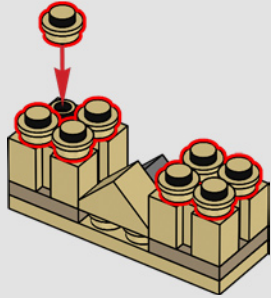

2x

535

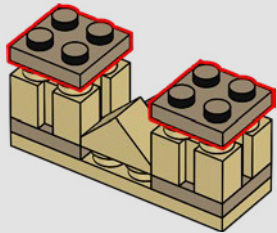

2x

536

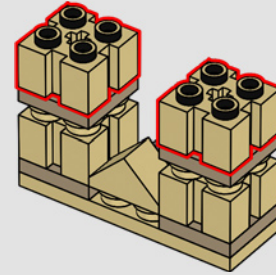

2x

537

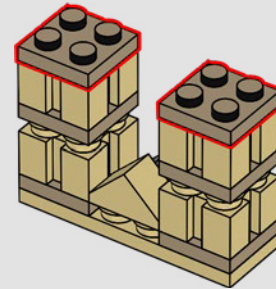

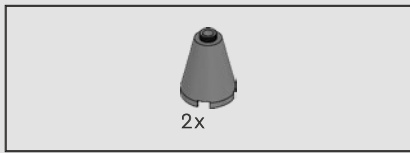

538

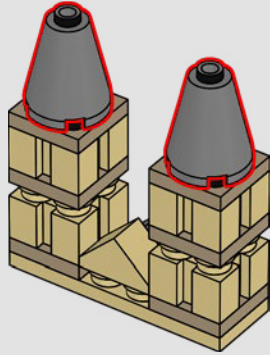

539

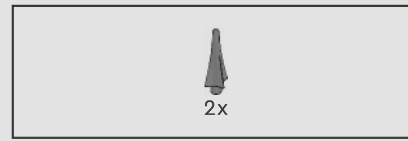
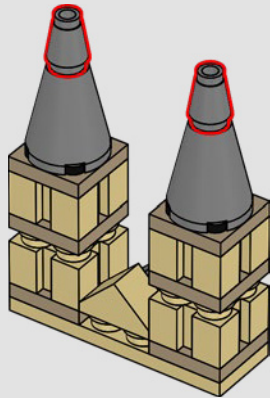

540

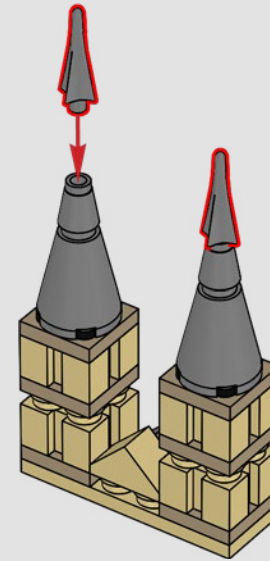



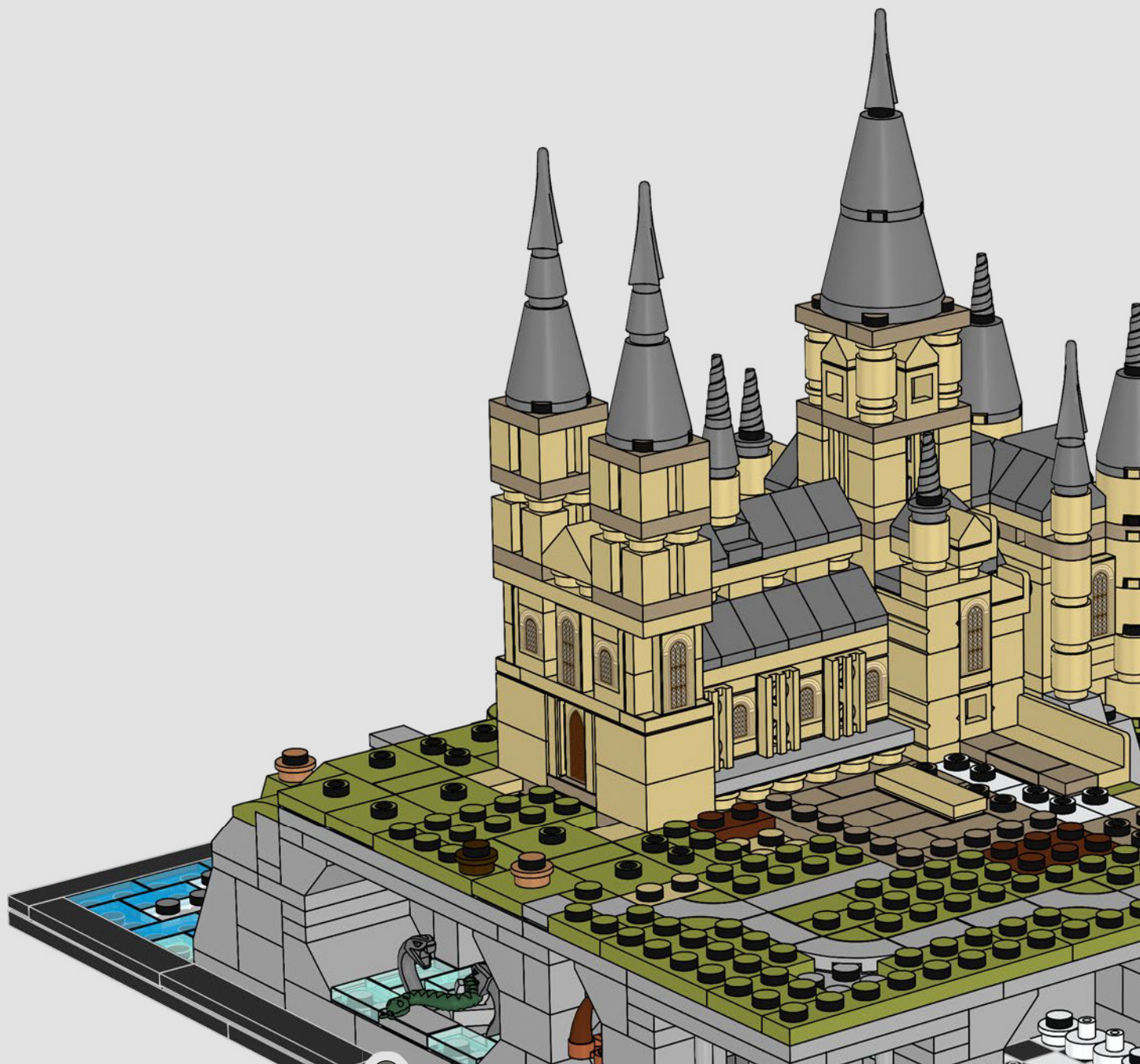

No matter what a Hogwarts™ student's favourite subjects are, they will likely spend a great deal of their time in the East Wing, where many of the classrooms are located.



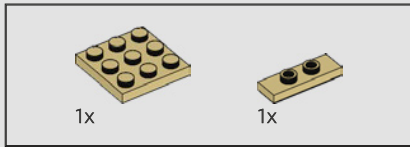
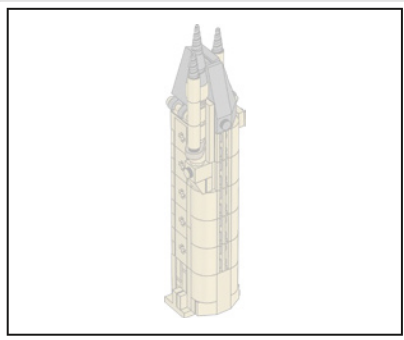

542

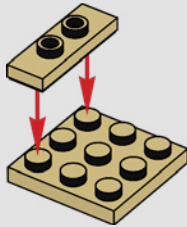

543

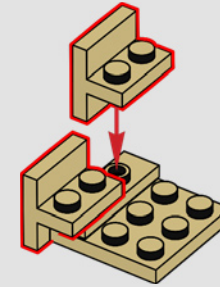

544

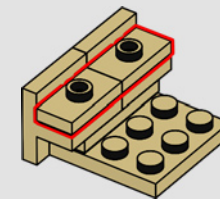



2x

545

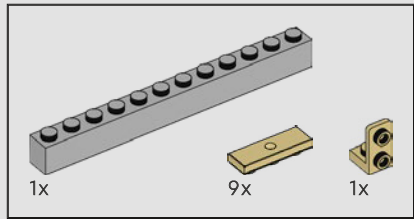
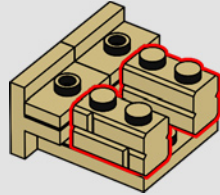

546

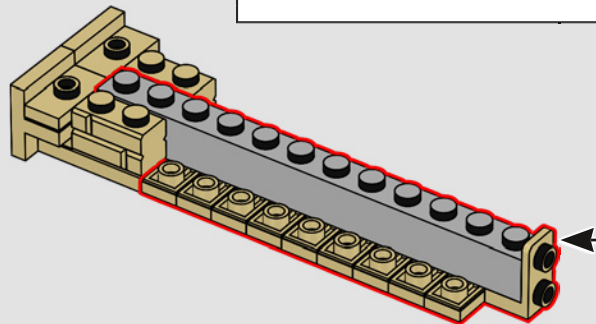
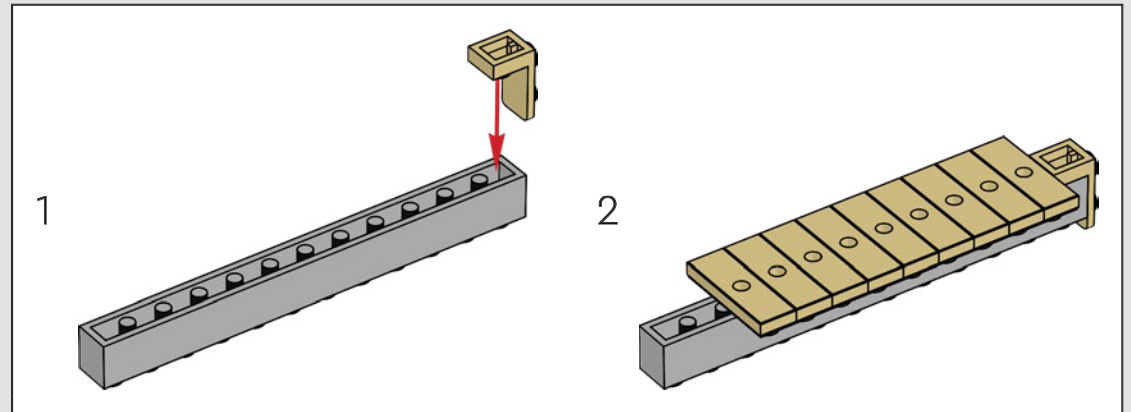



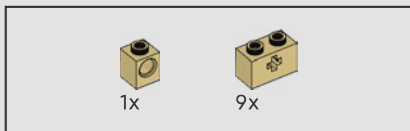

547

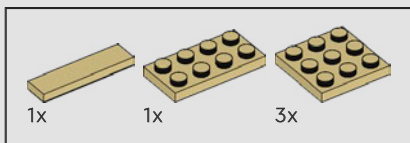
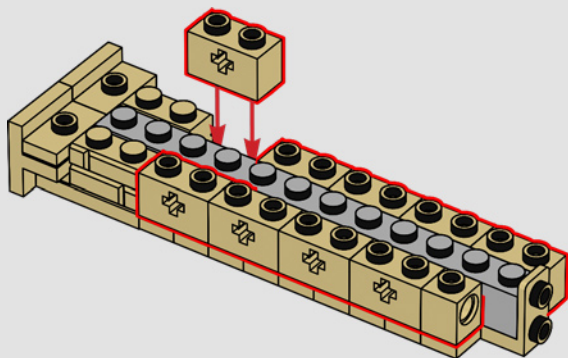

548

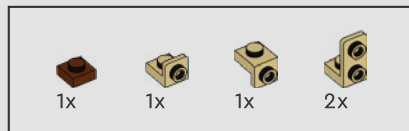
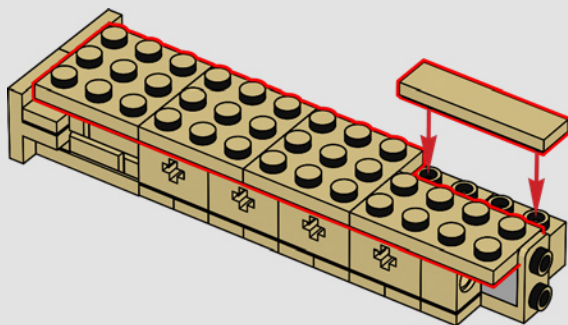

549

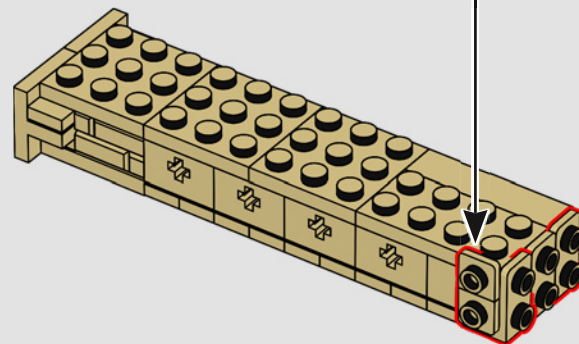
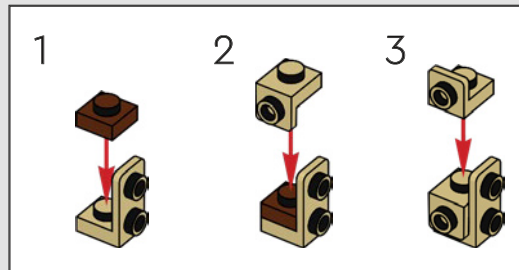

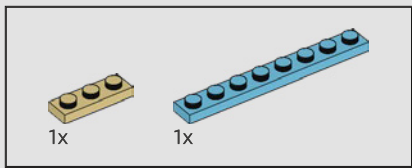

550

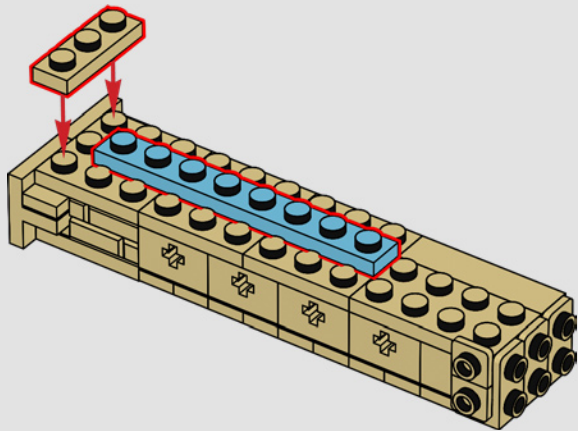

551

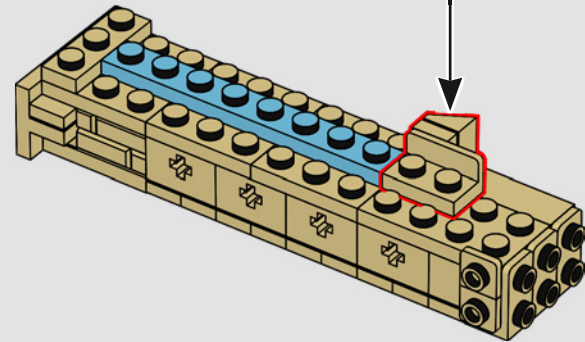
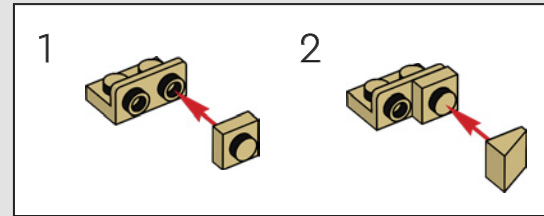

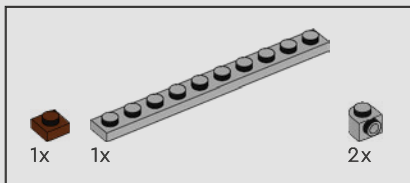

552

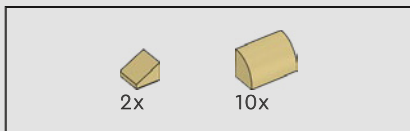
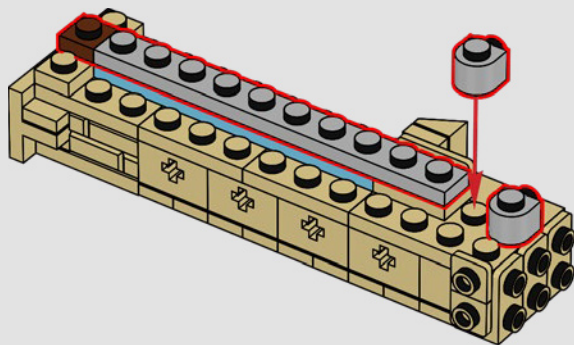

553

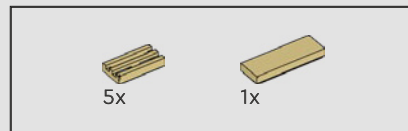
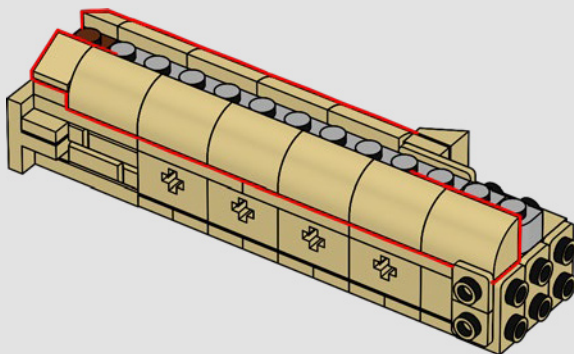

554

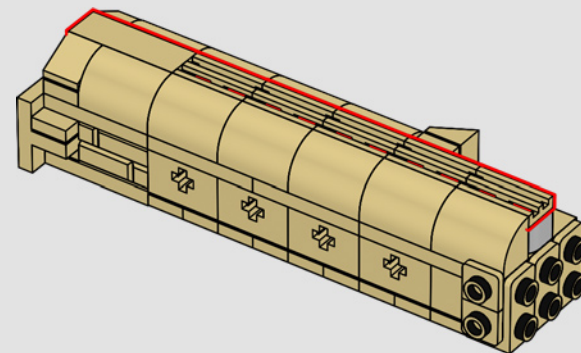



1x

555

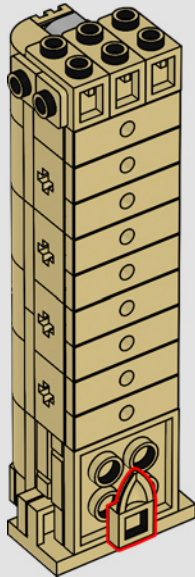

2x

556

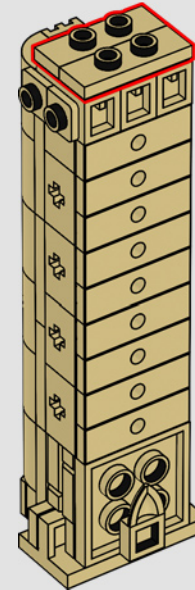

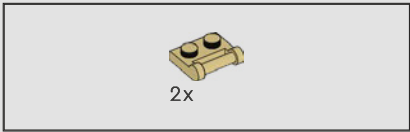

557

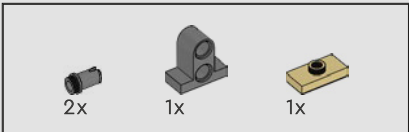
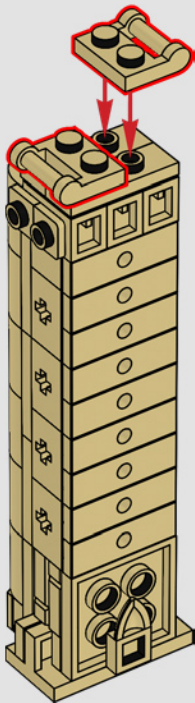

558

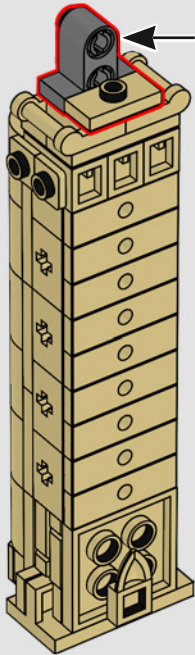
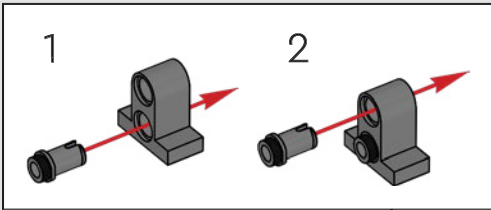



559

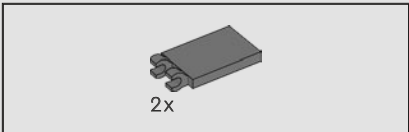

560

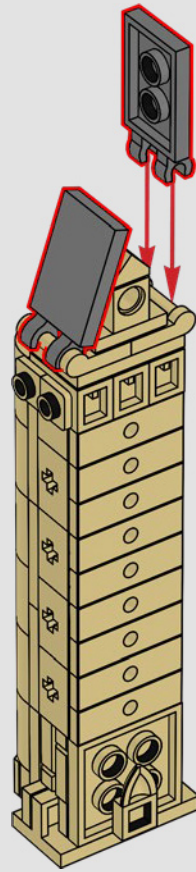



561

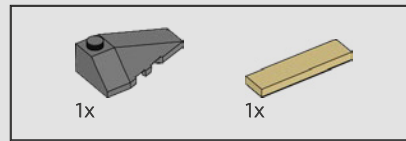
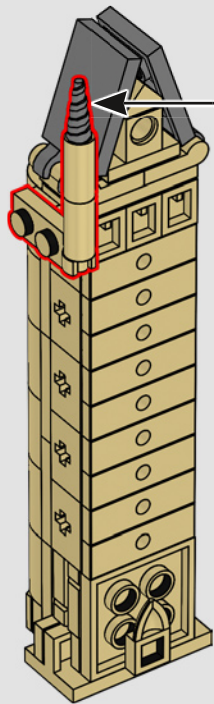
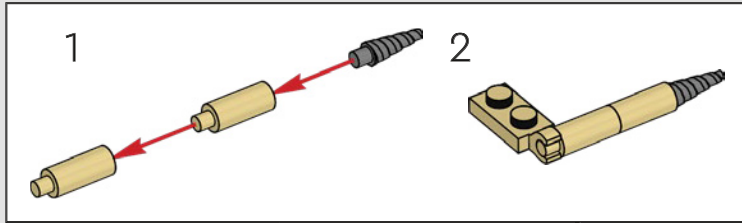

562

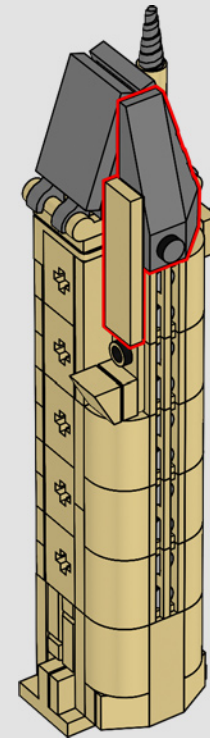

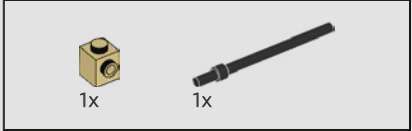
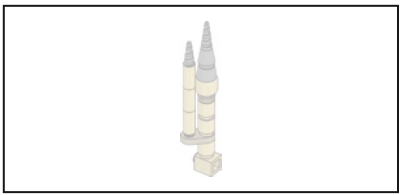

563

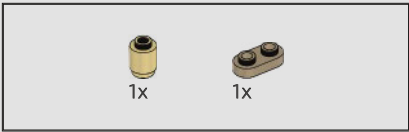
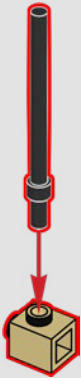

564



565







566

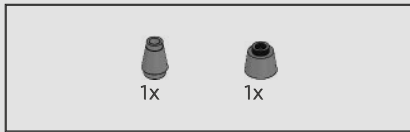

567

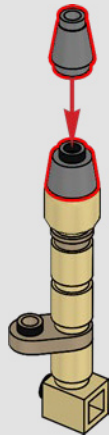

568

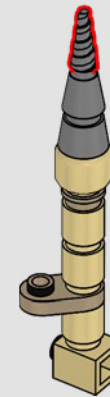

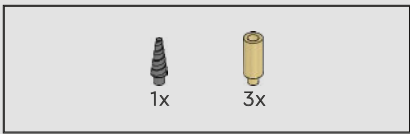

569

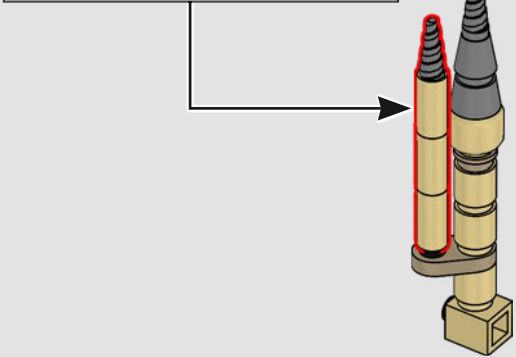
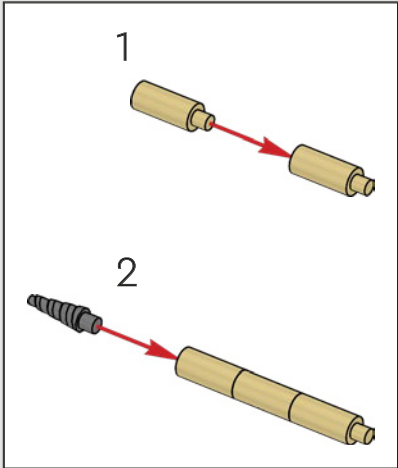

570

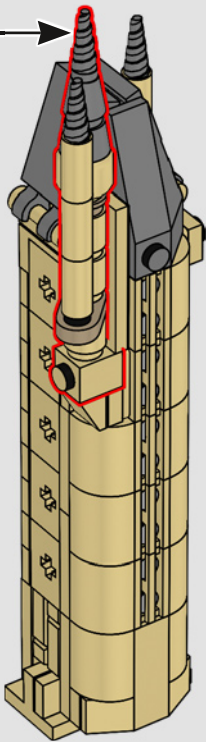

571

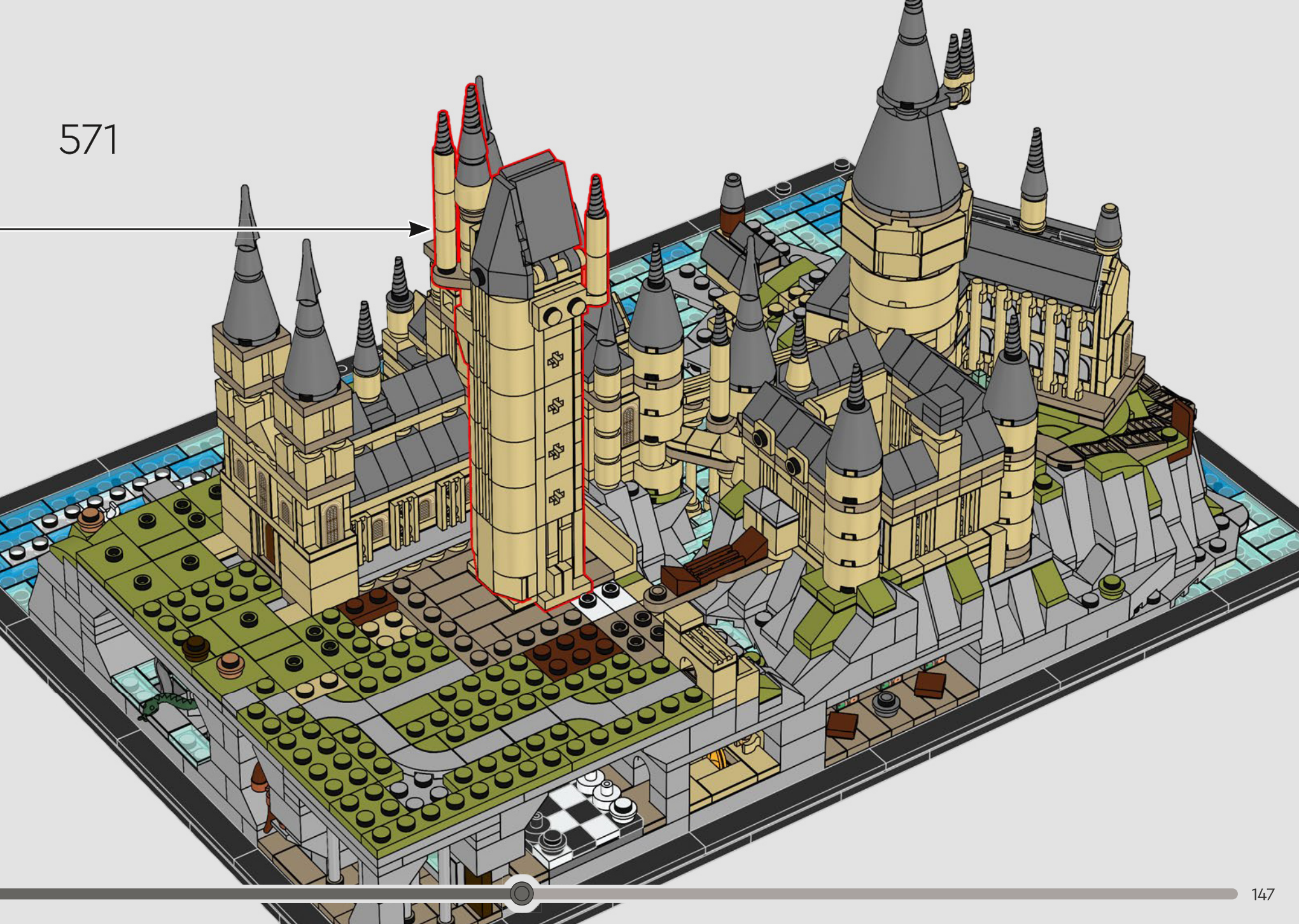

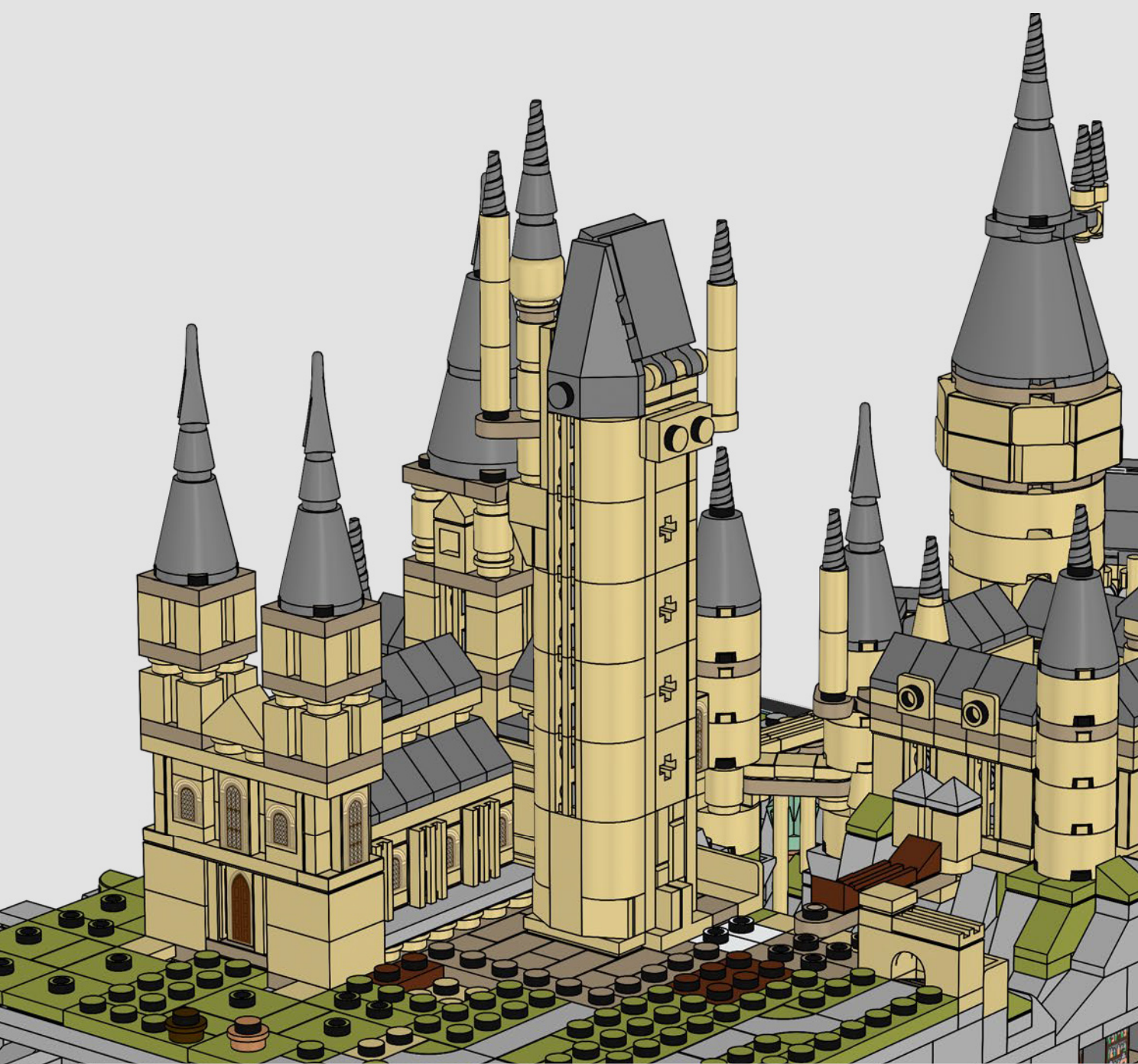

You might think the main tower would be the tallest point of the Hogwarts™ castle – but it is actually the Astronomy Tower.



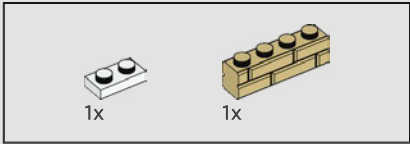
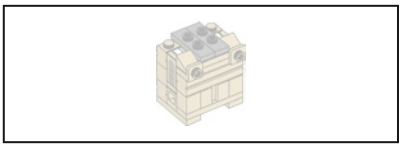

572

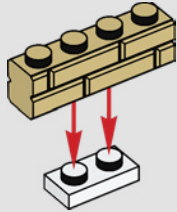

573

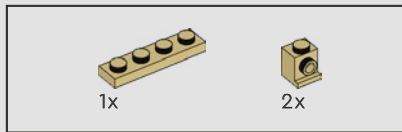
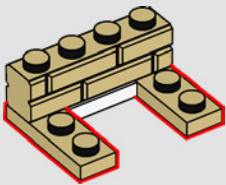

574

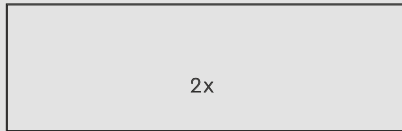
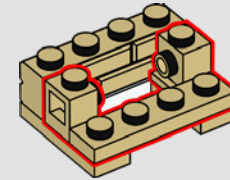

575

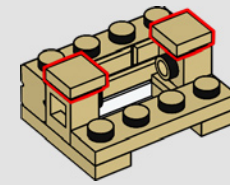

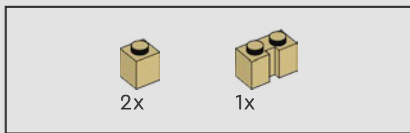

576

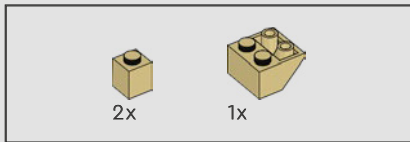
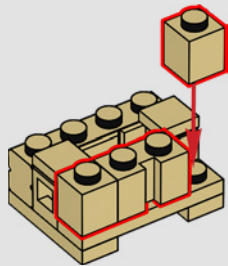

577

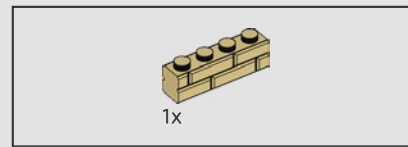
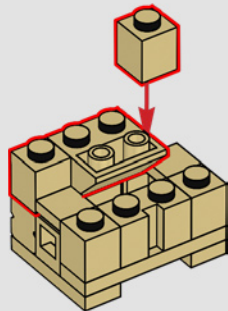

578

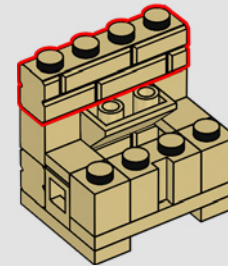

579

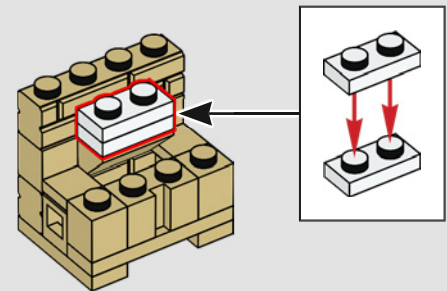

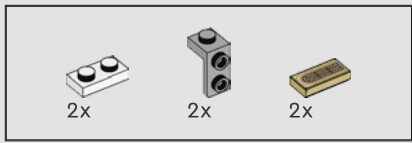

580

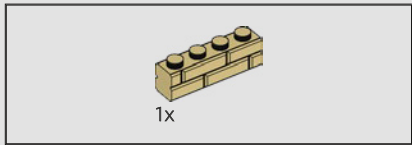
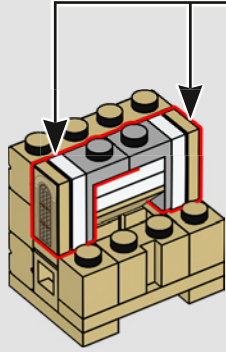
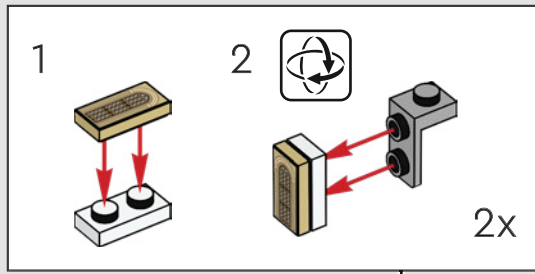

581

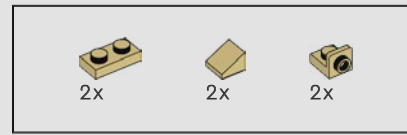
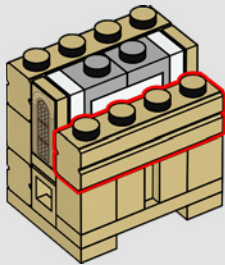

582

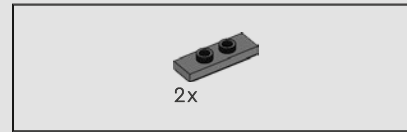
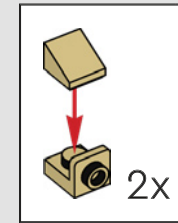
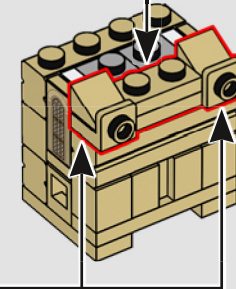
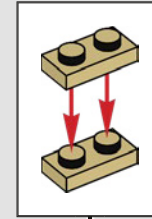

583

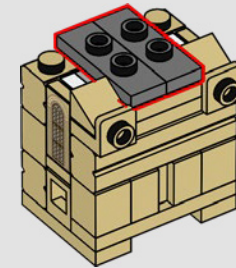



584

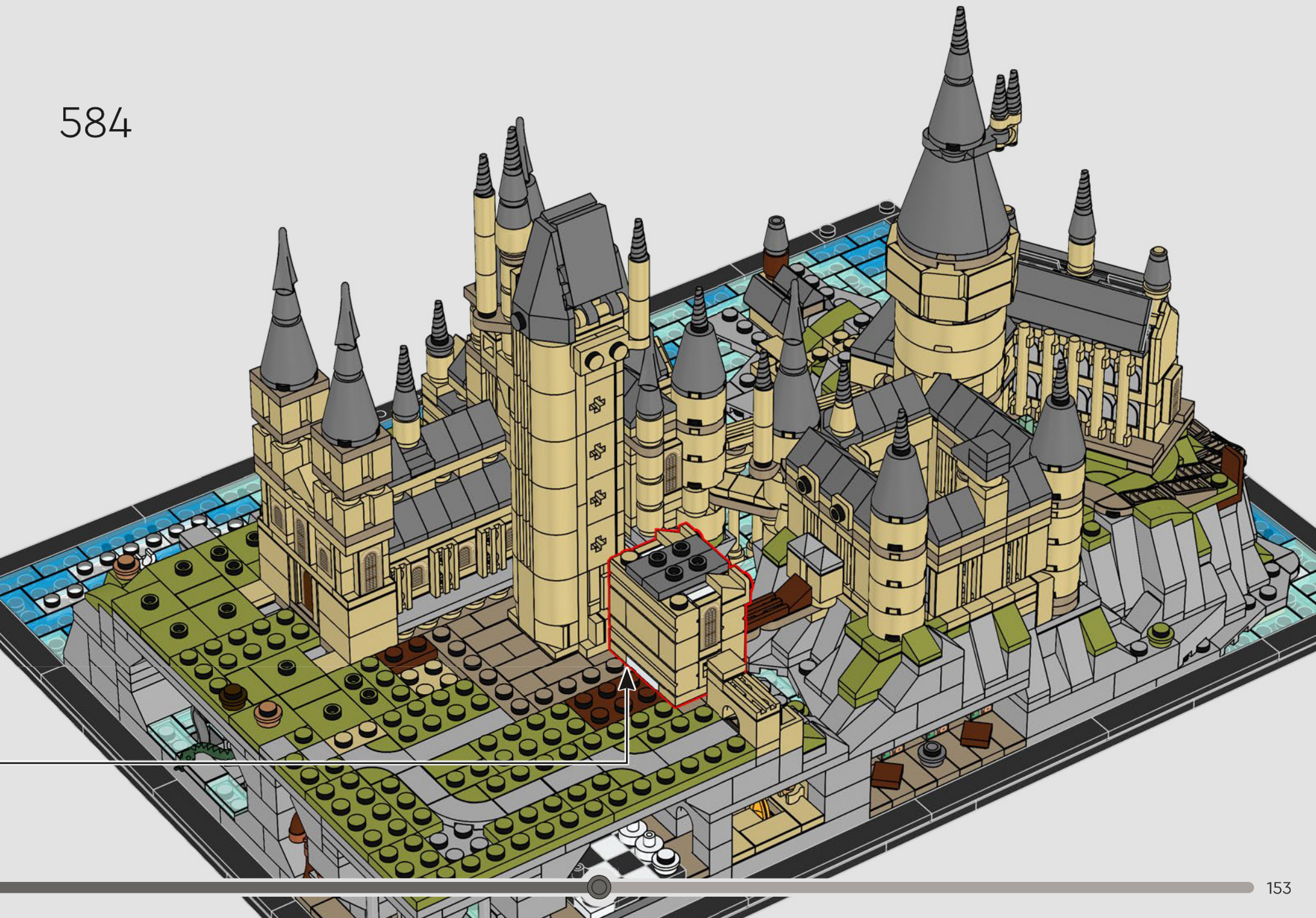

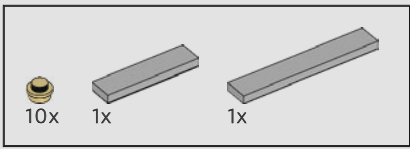

585

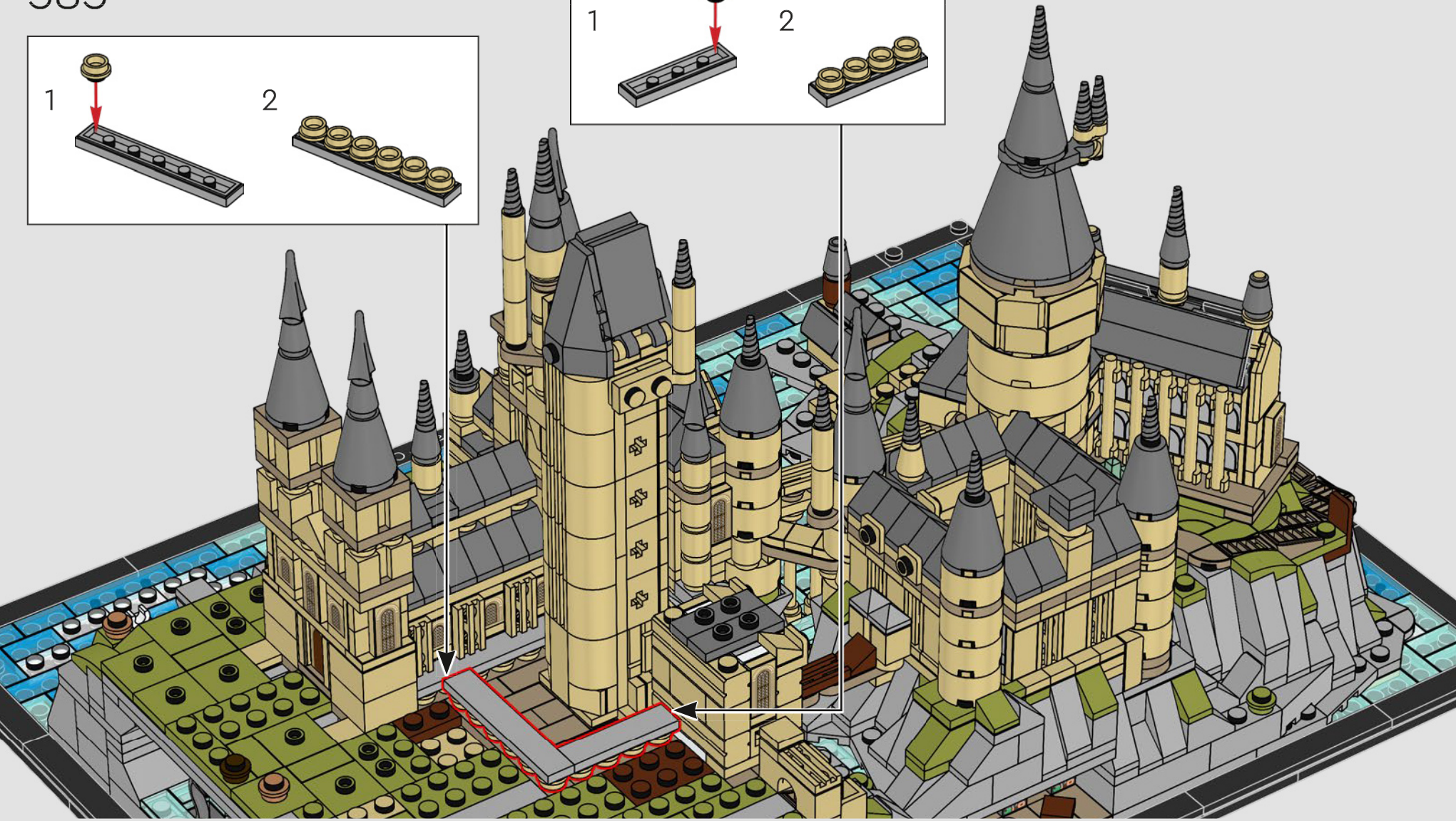
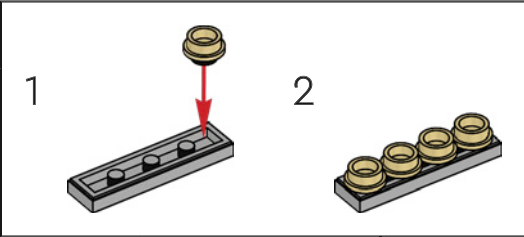
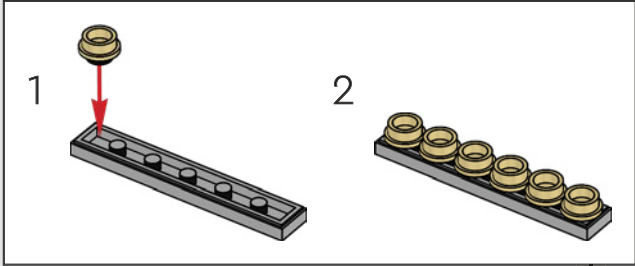

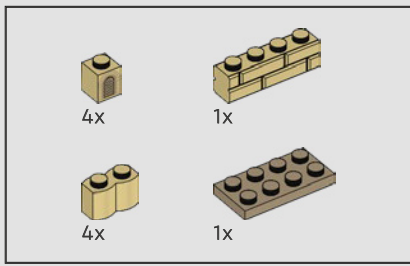

586

1

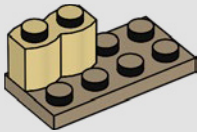

2

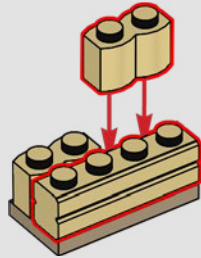

3

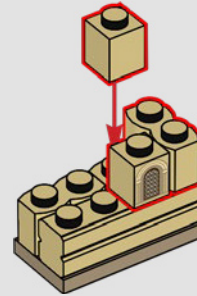

4

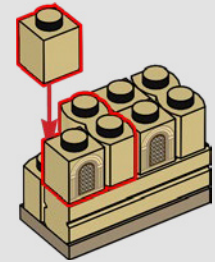





587



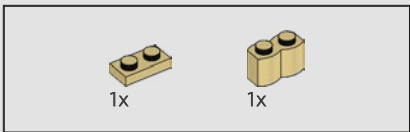

588

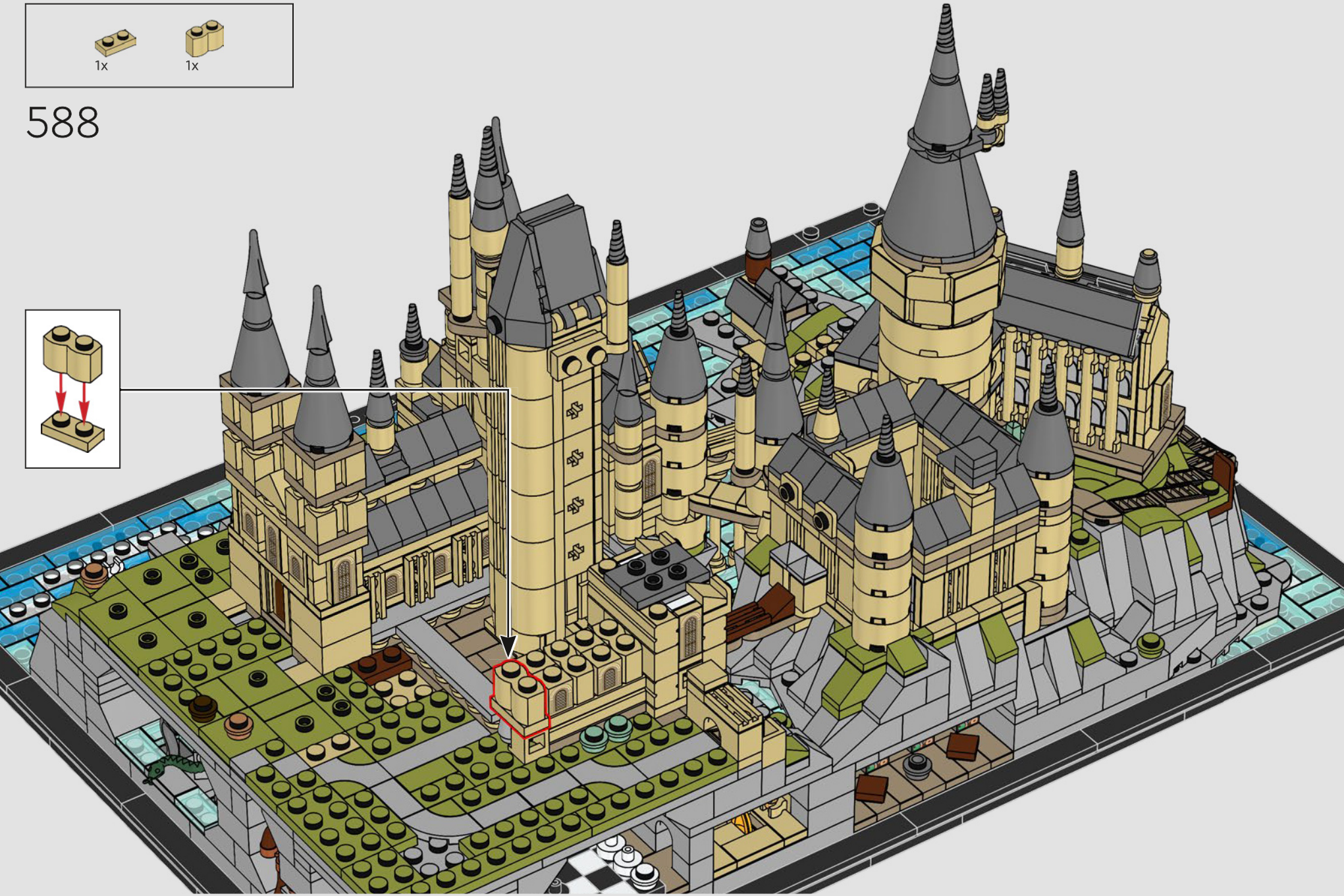
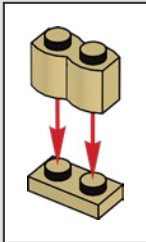

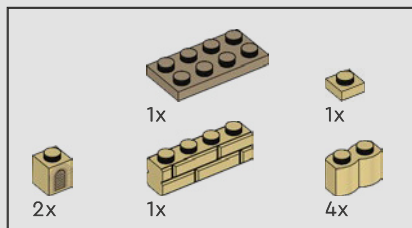

589

1

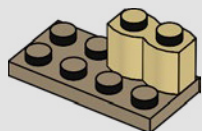

2

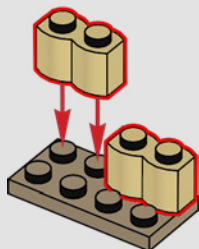

3

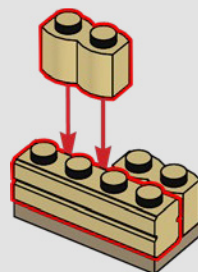

4

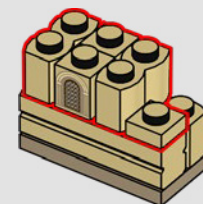

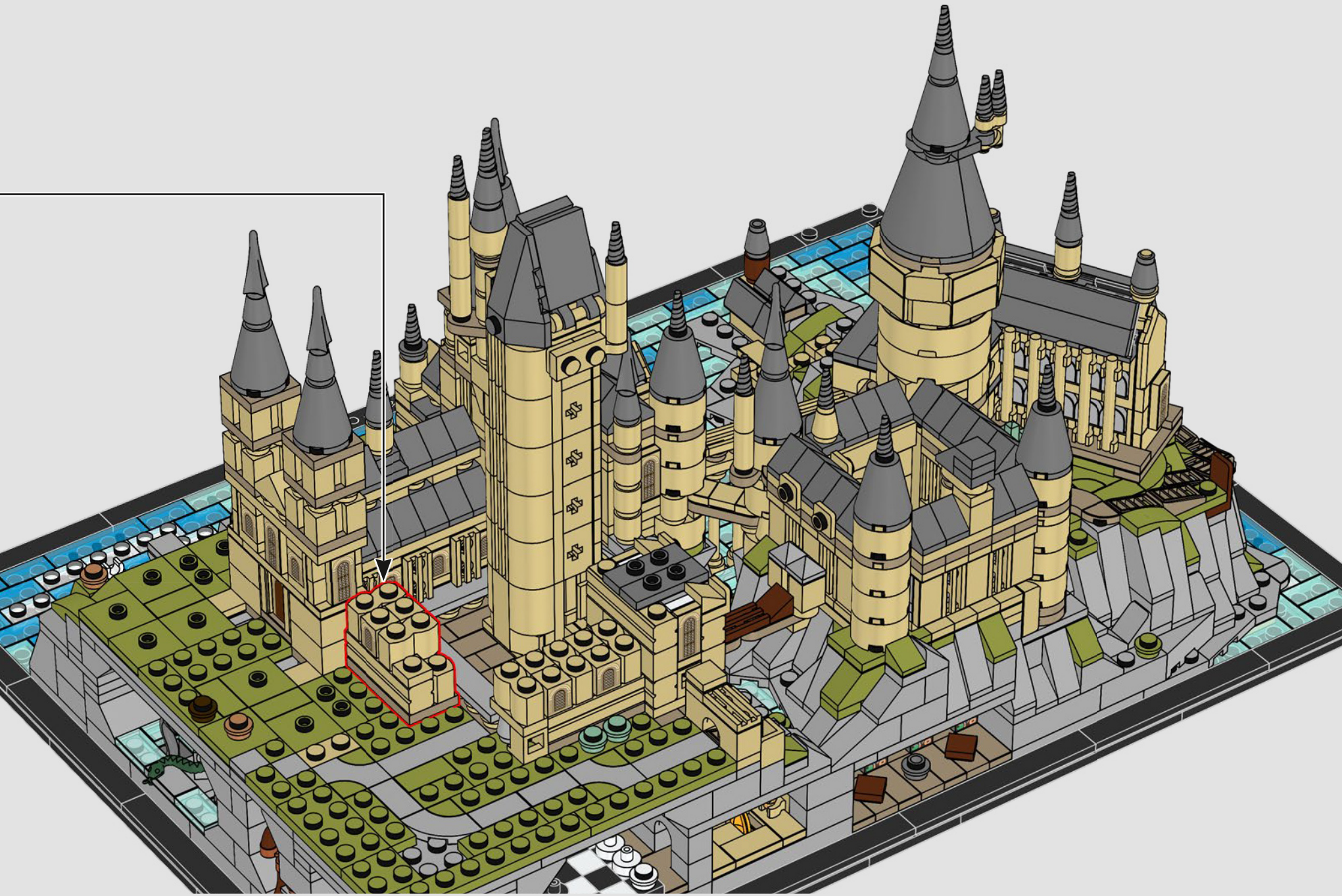



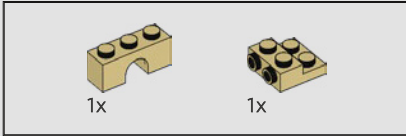
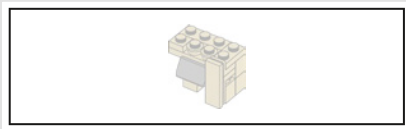

590

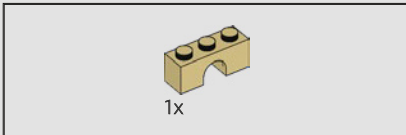
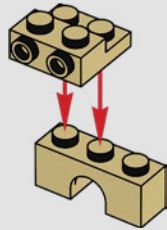

591

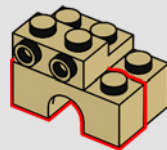

592

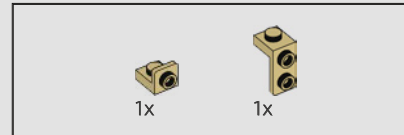
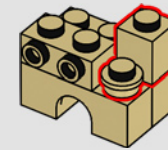

593

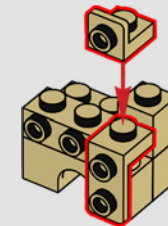

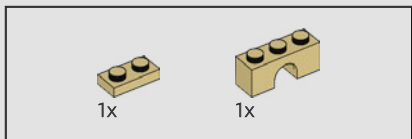

594

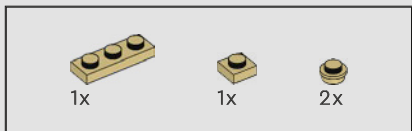
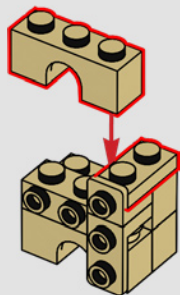

595

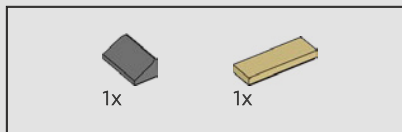
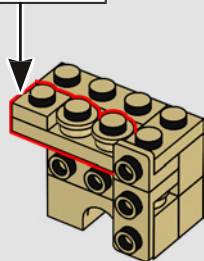
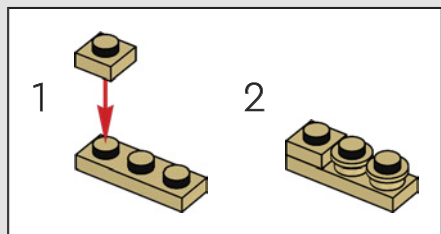

596

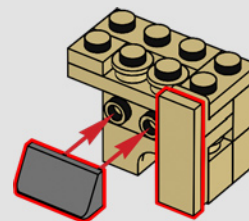

597



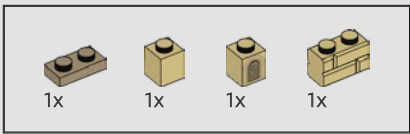

598

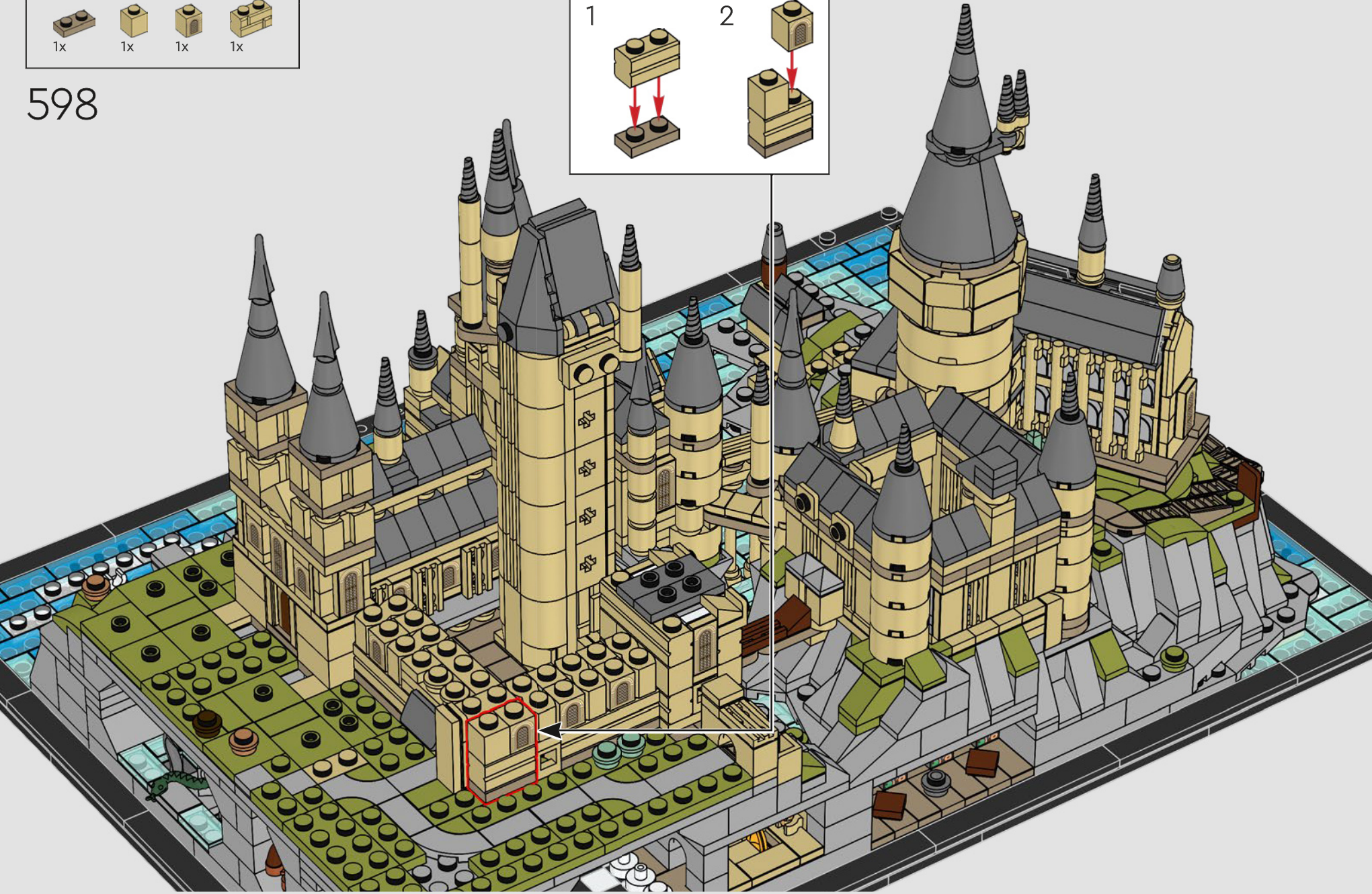
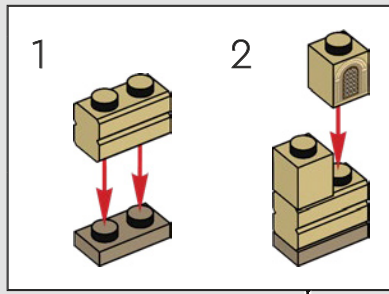

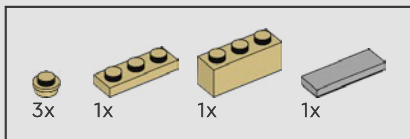

599

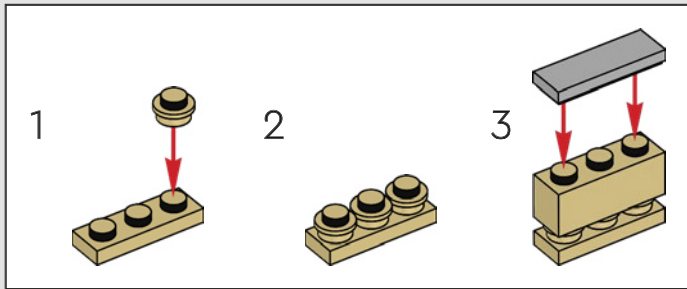

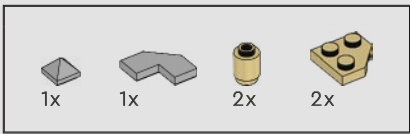

600

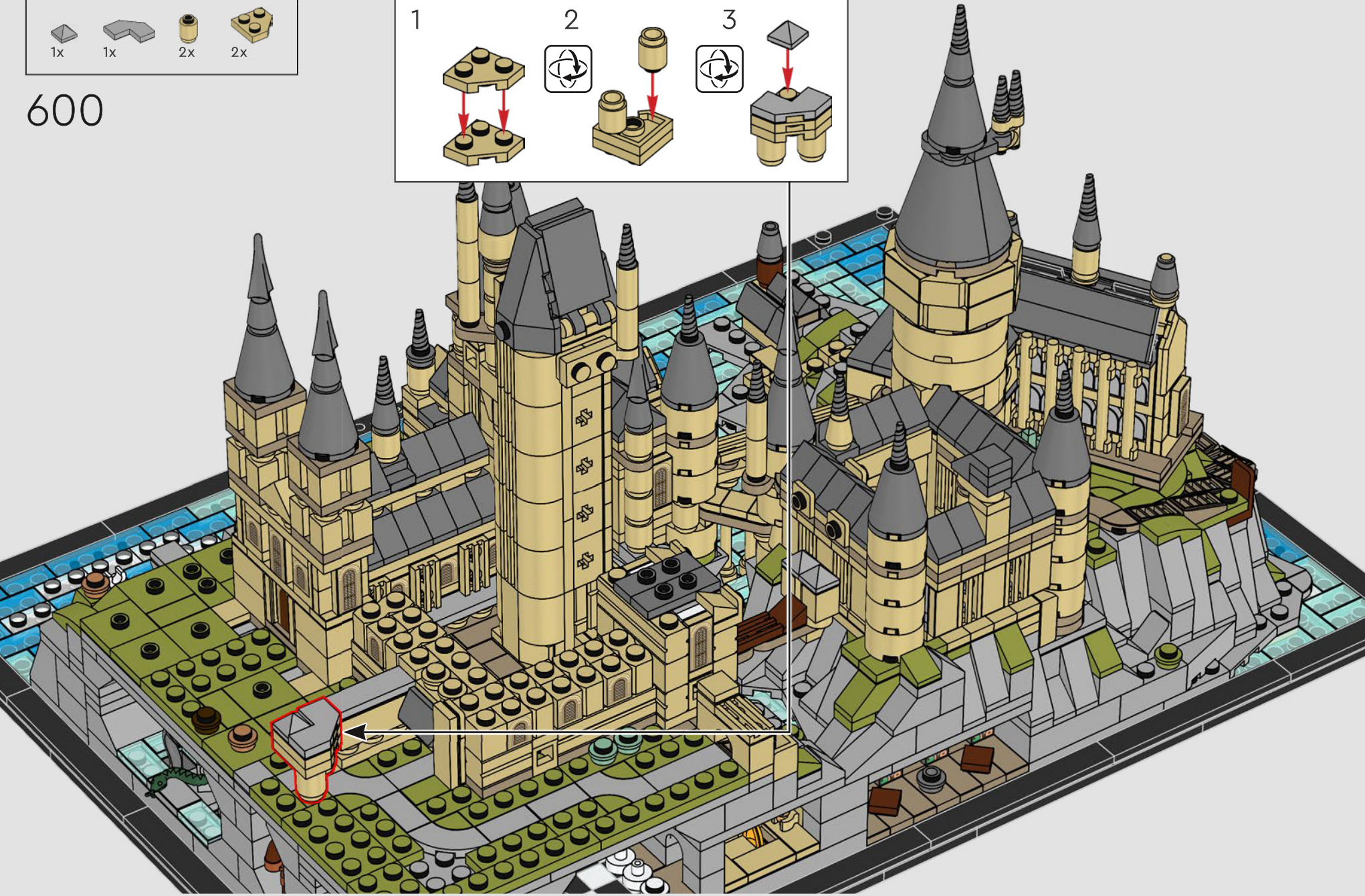
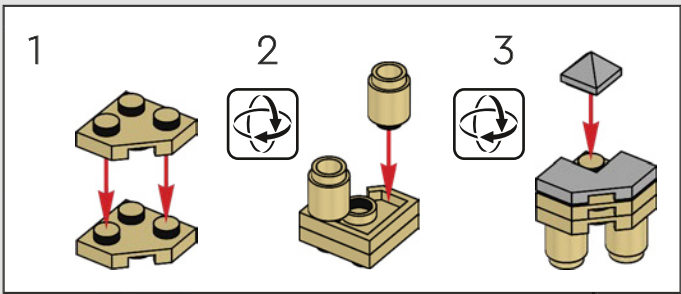

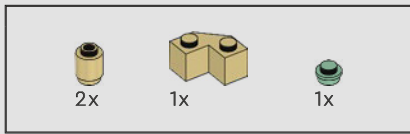

601

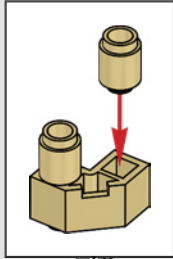





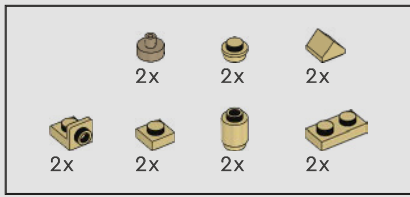

602

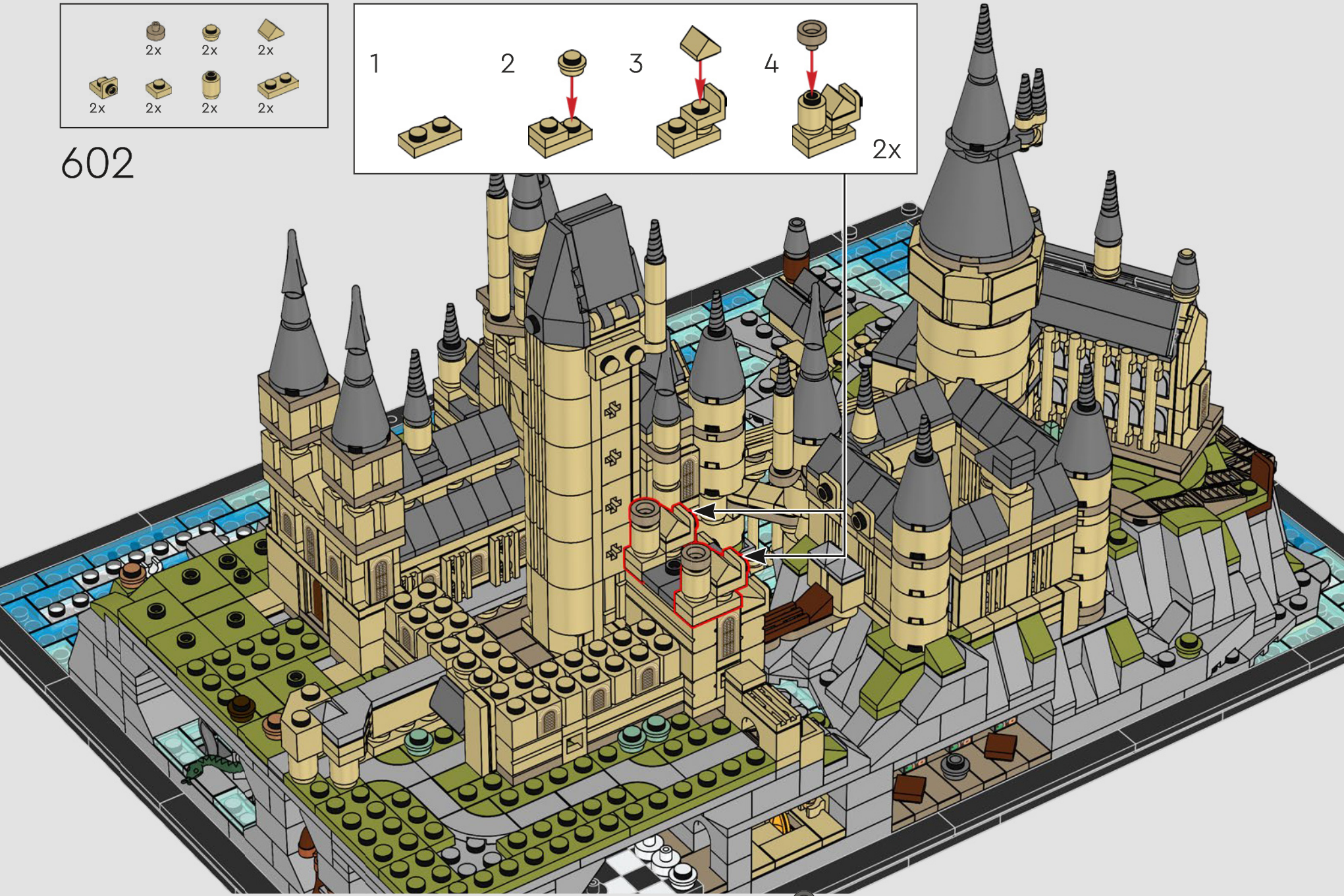
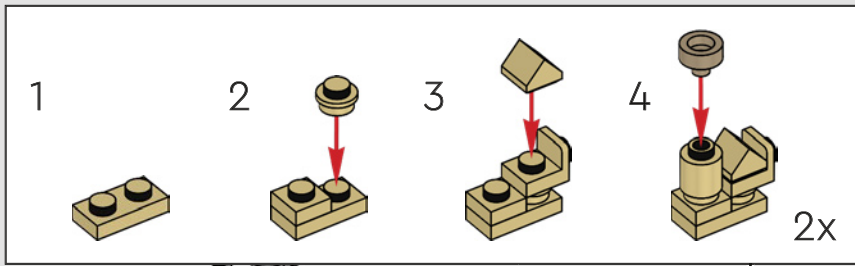

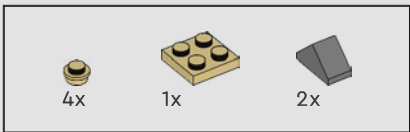

603

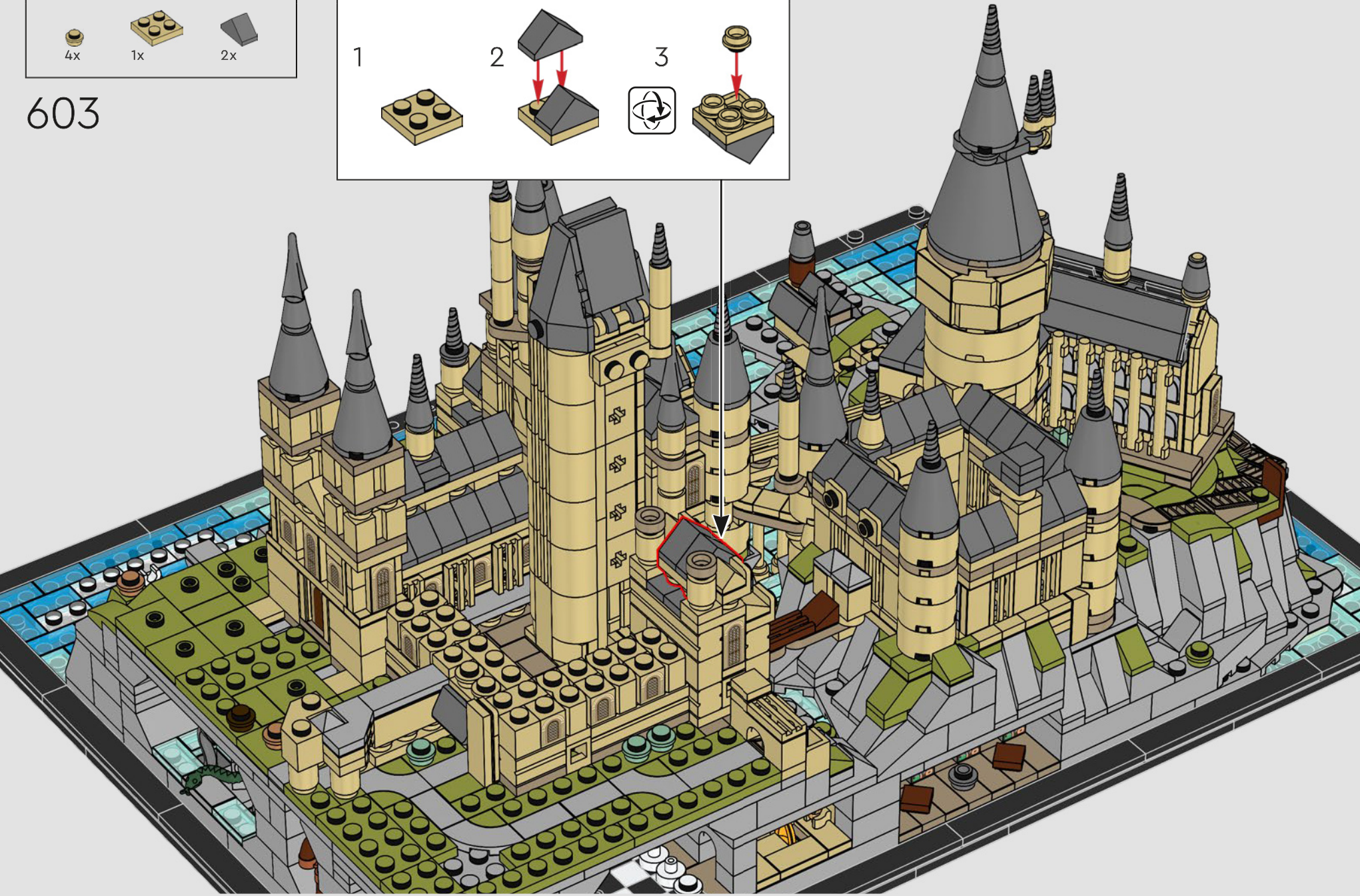
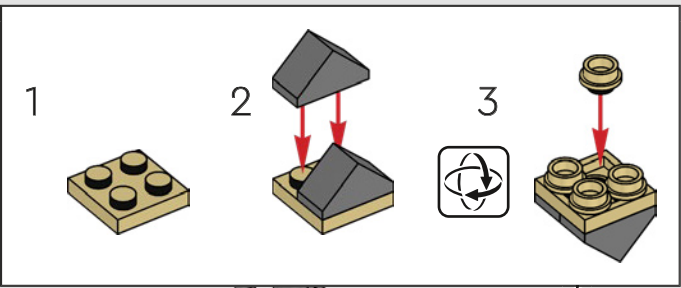

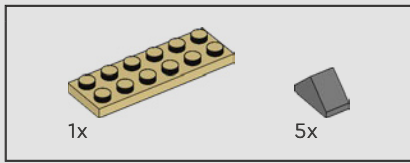

604

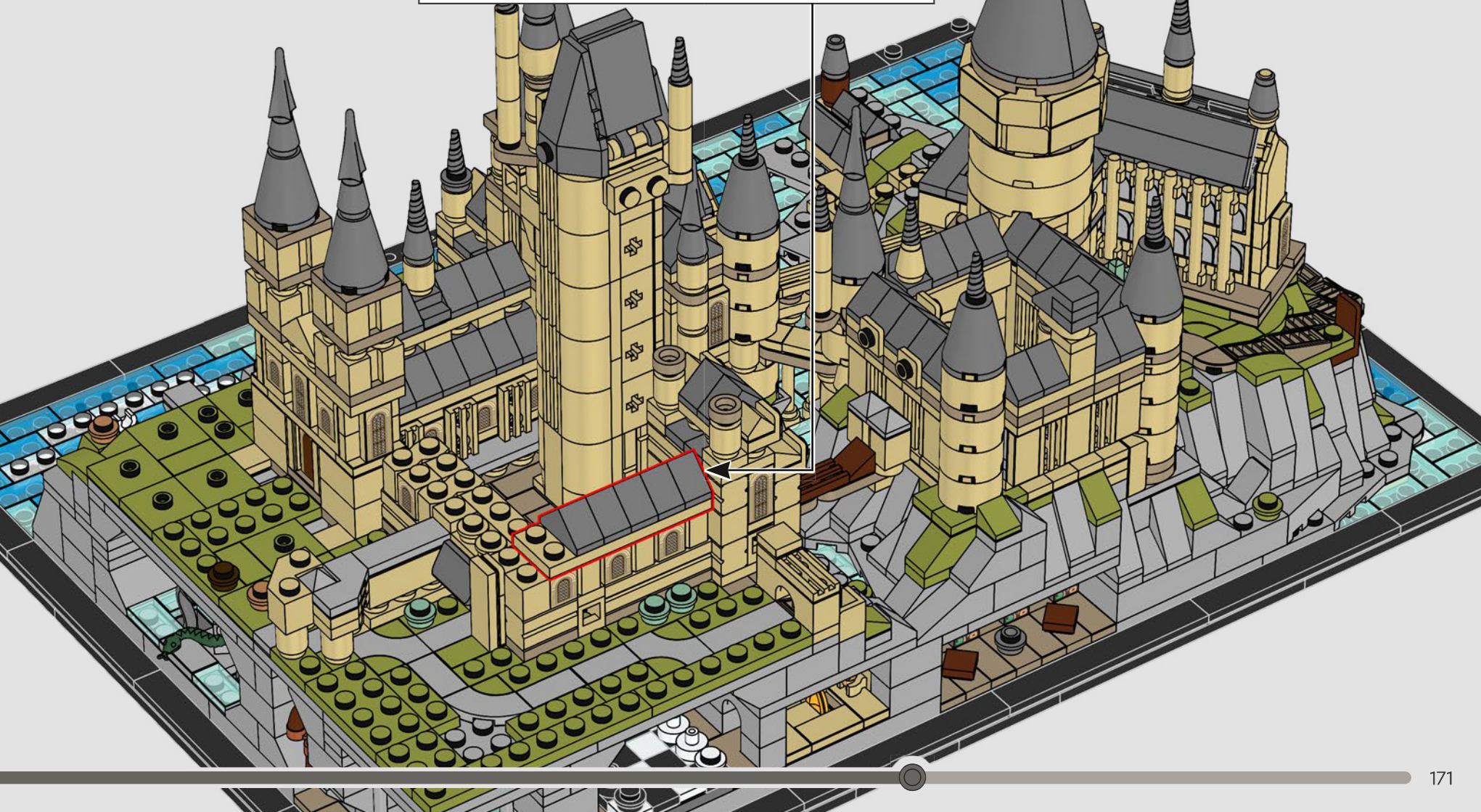
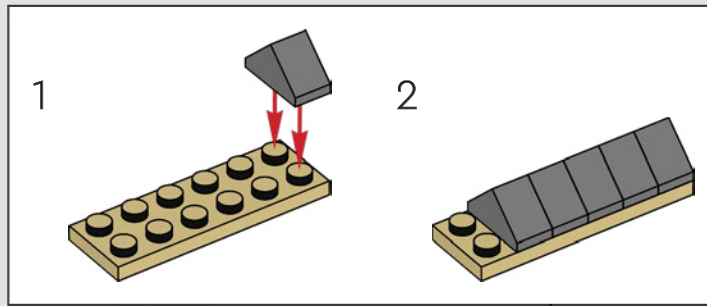

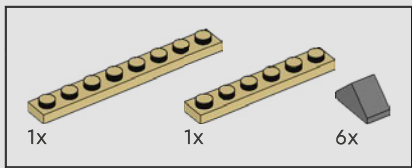

605

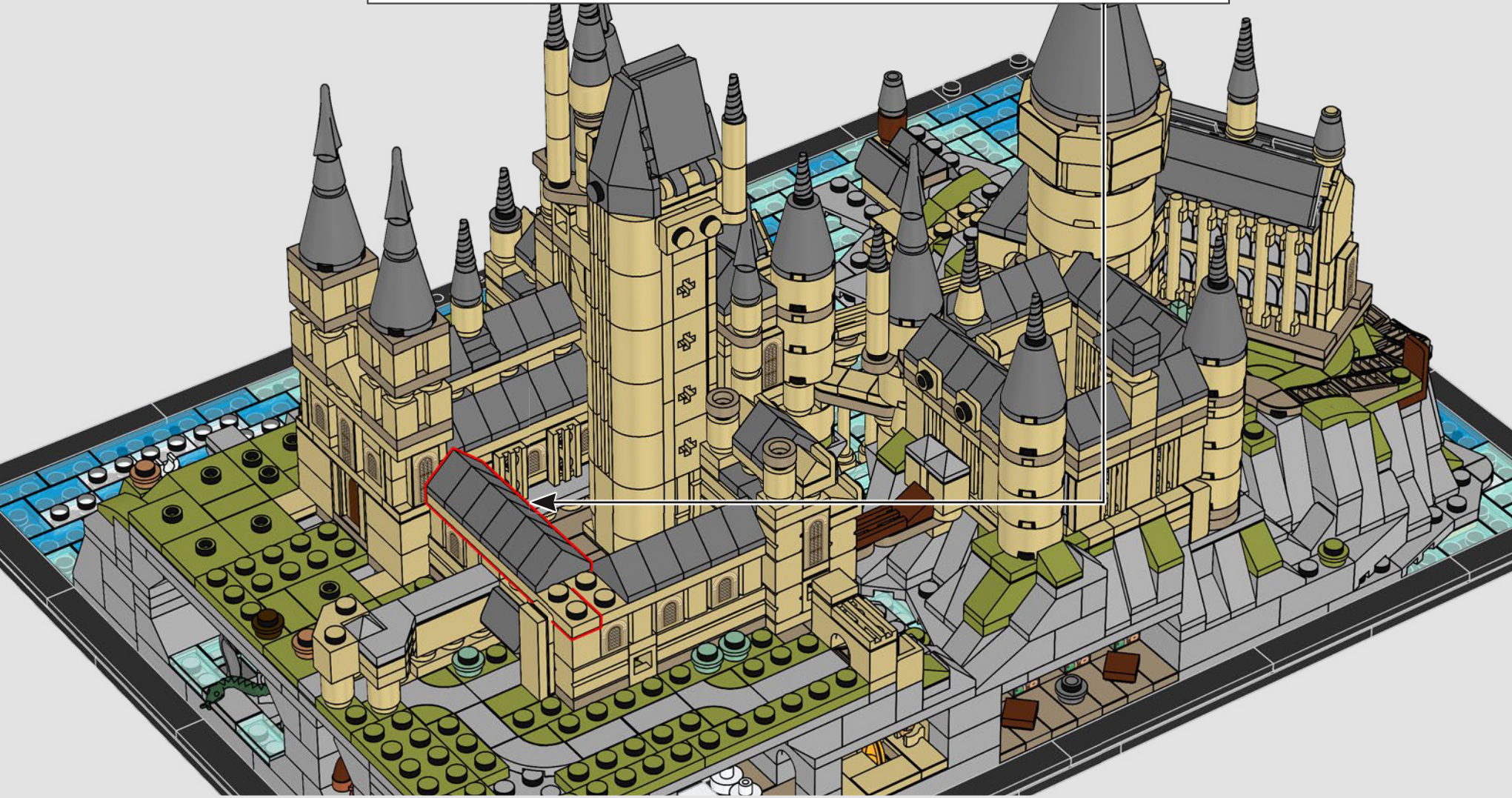
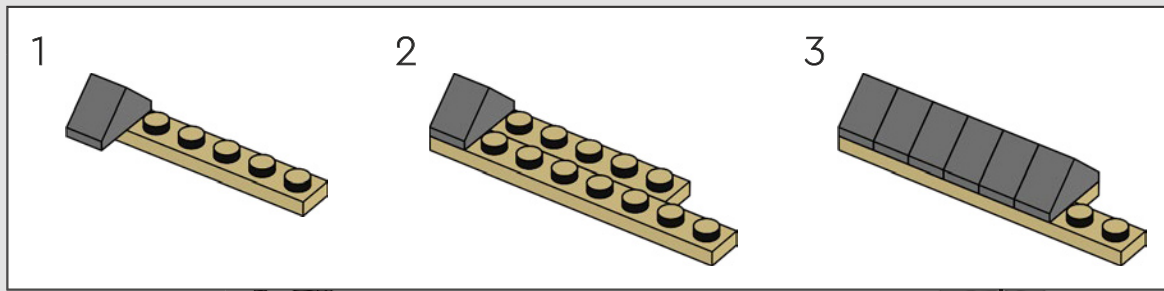

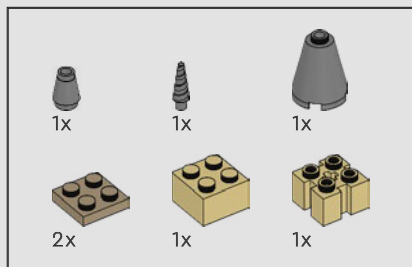

606

1

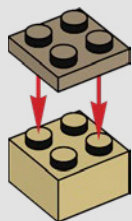

2

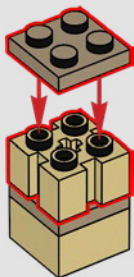

3

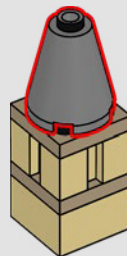

4

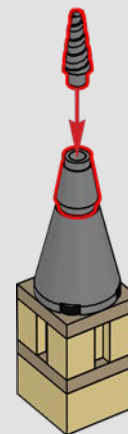





Hogwarts™ is a huge castle, where it can be tricky to find your way. But did you know that the castle has 142 staircases? With the staircases constantly changing, it doesn't make it easier finding your way around.

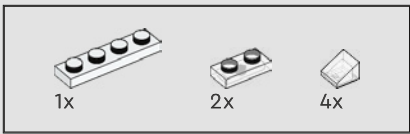

607

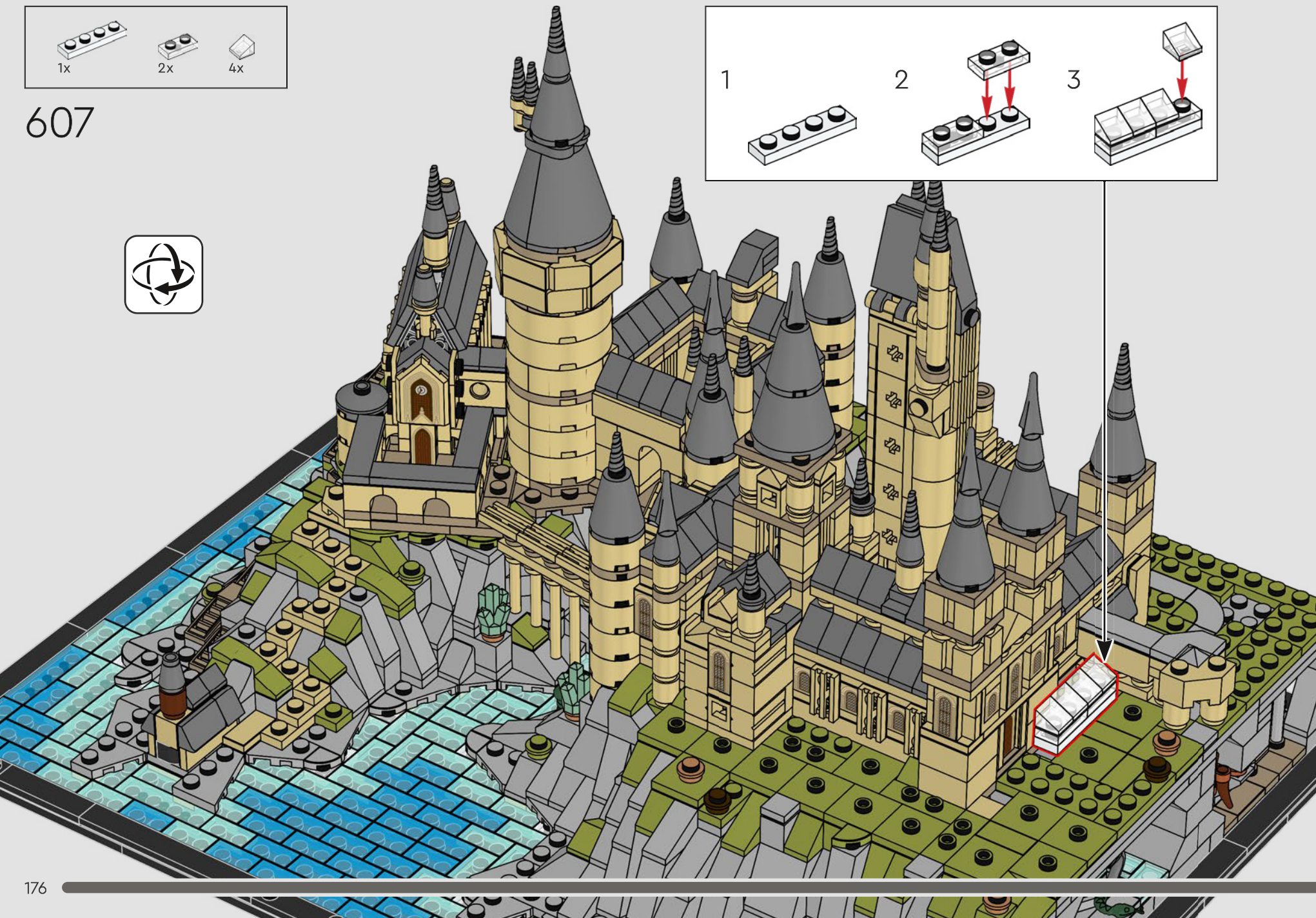
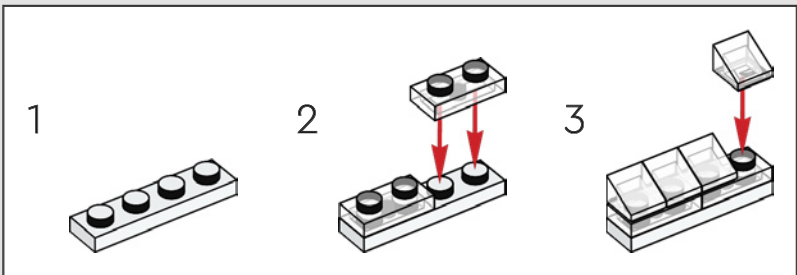



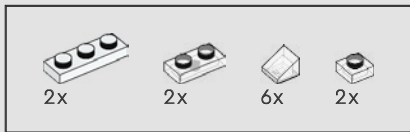

608

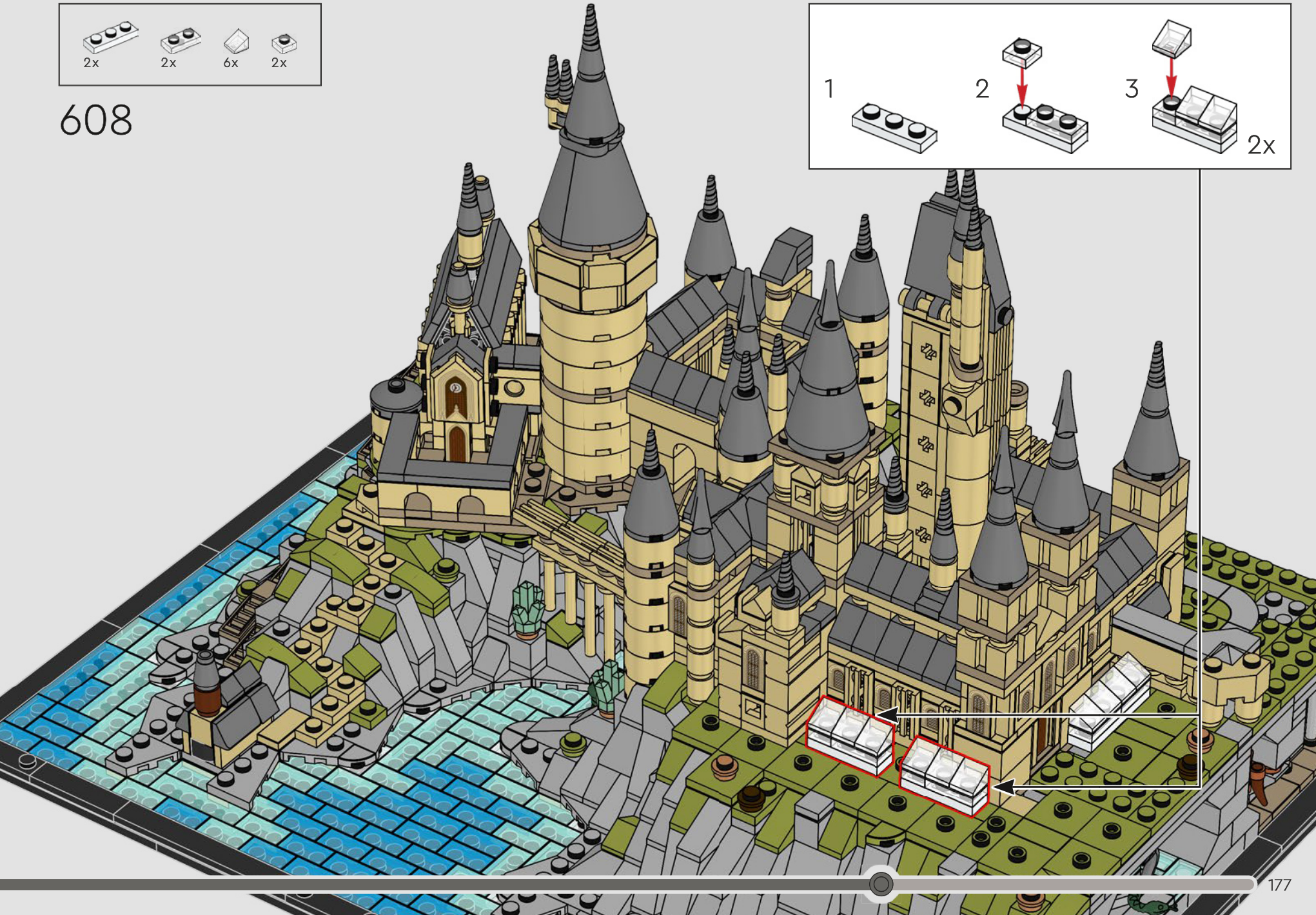
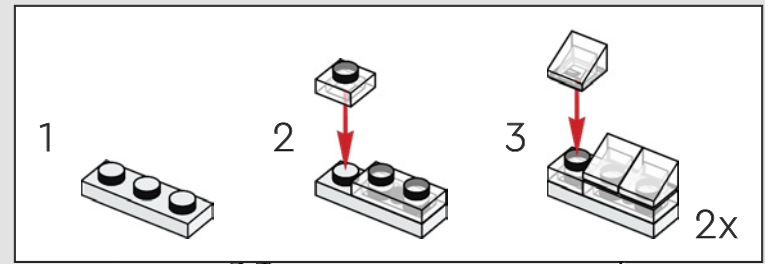

- 1x 
- 1x 

609

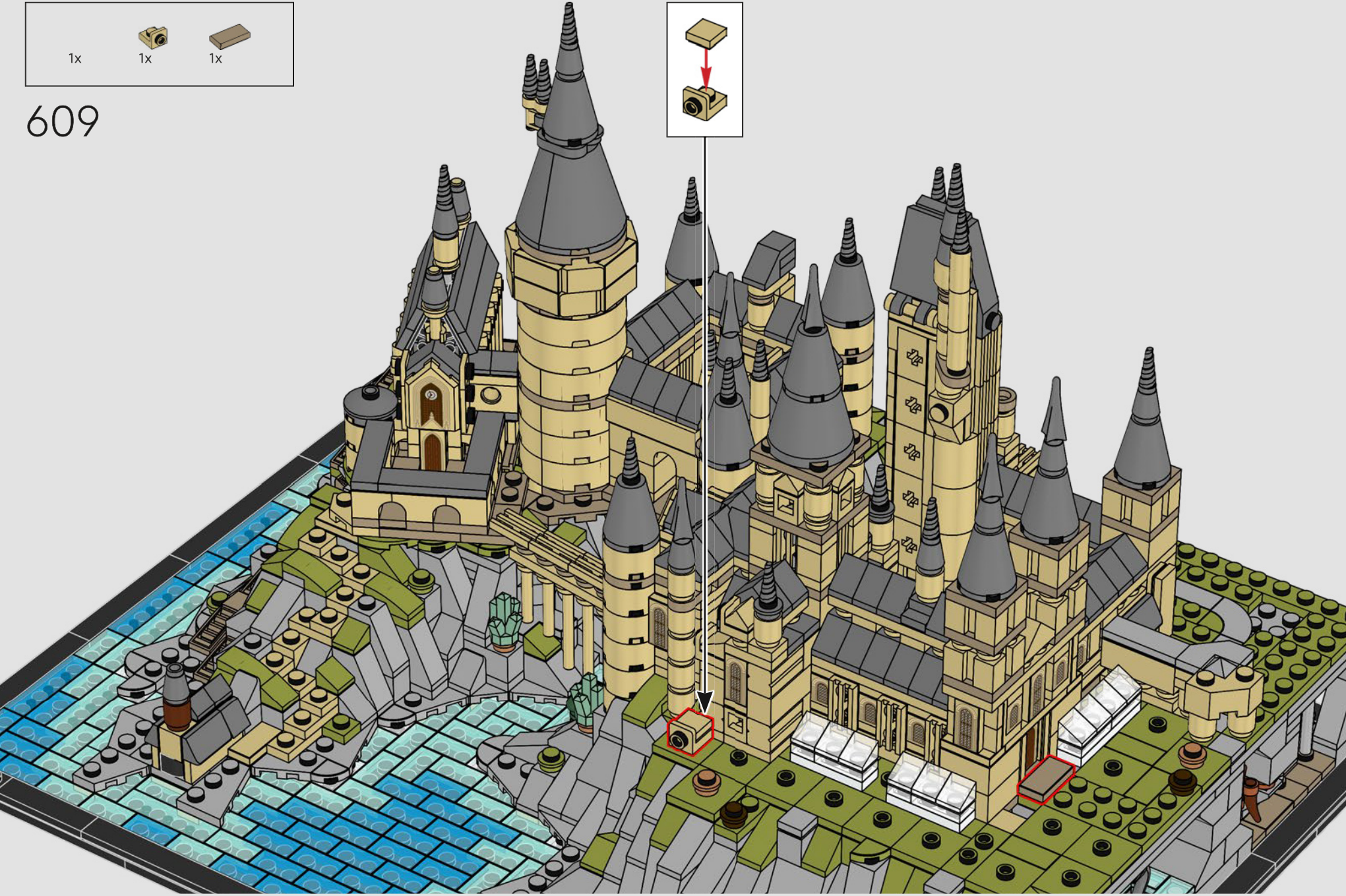
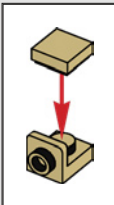



610

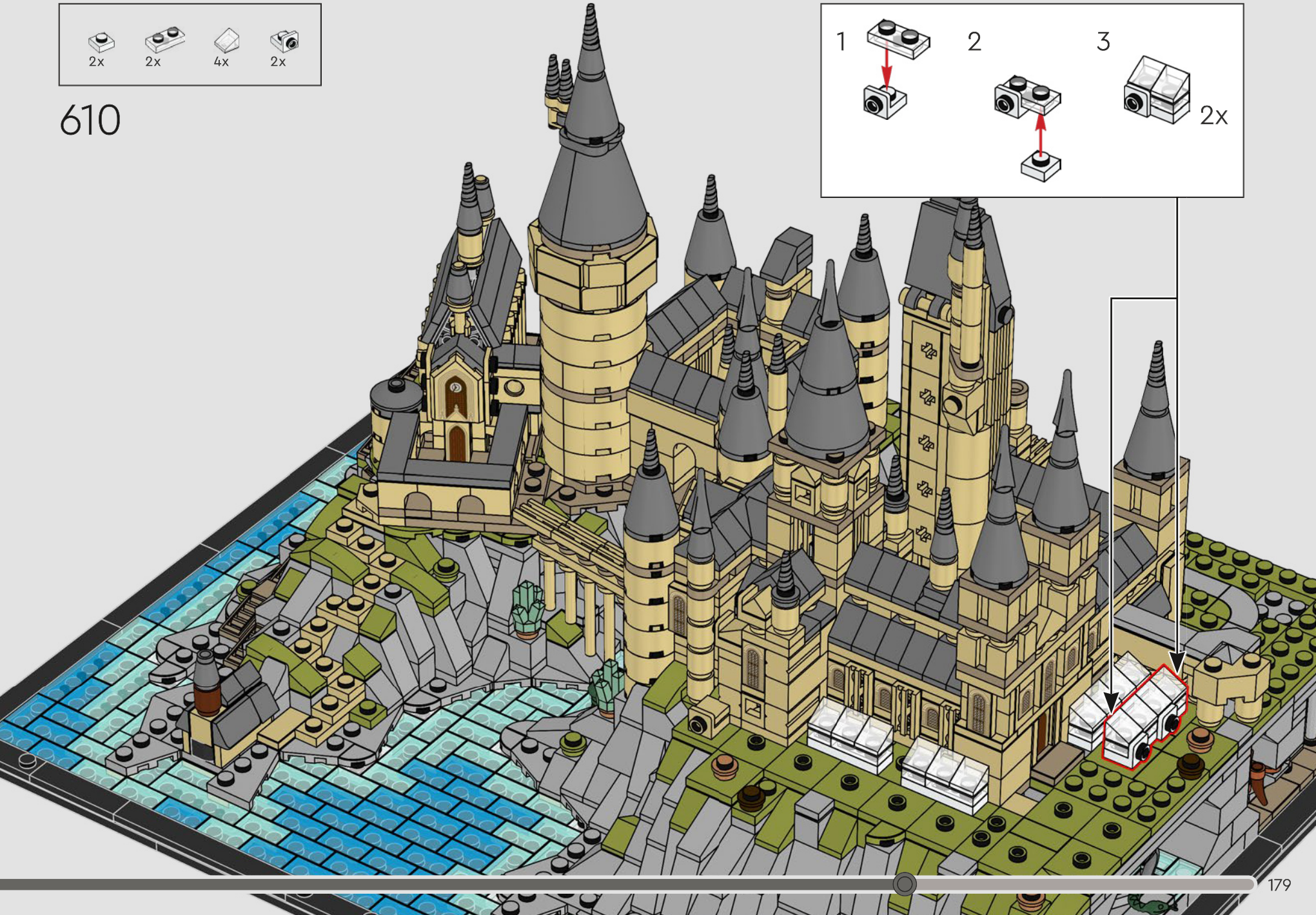
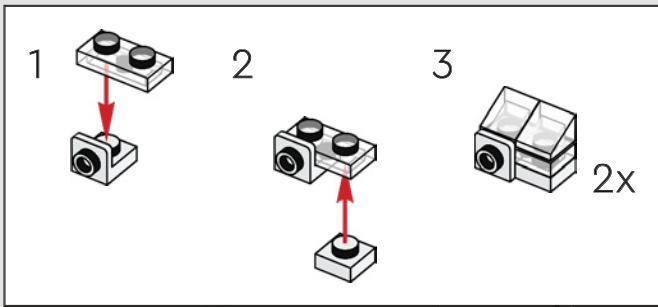

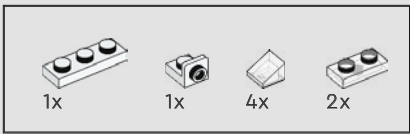

611

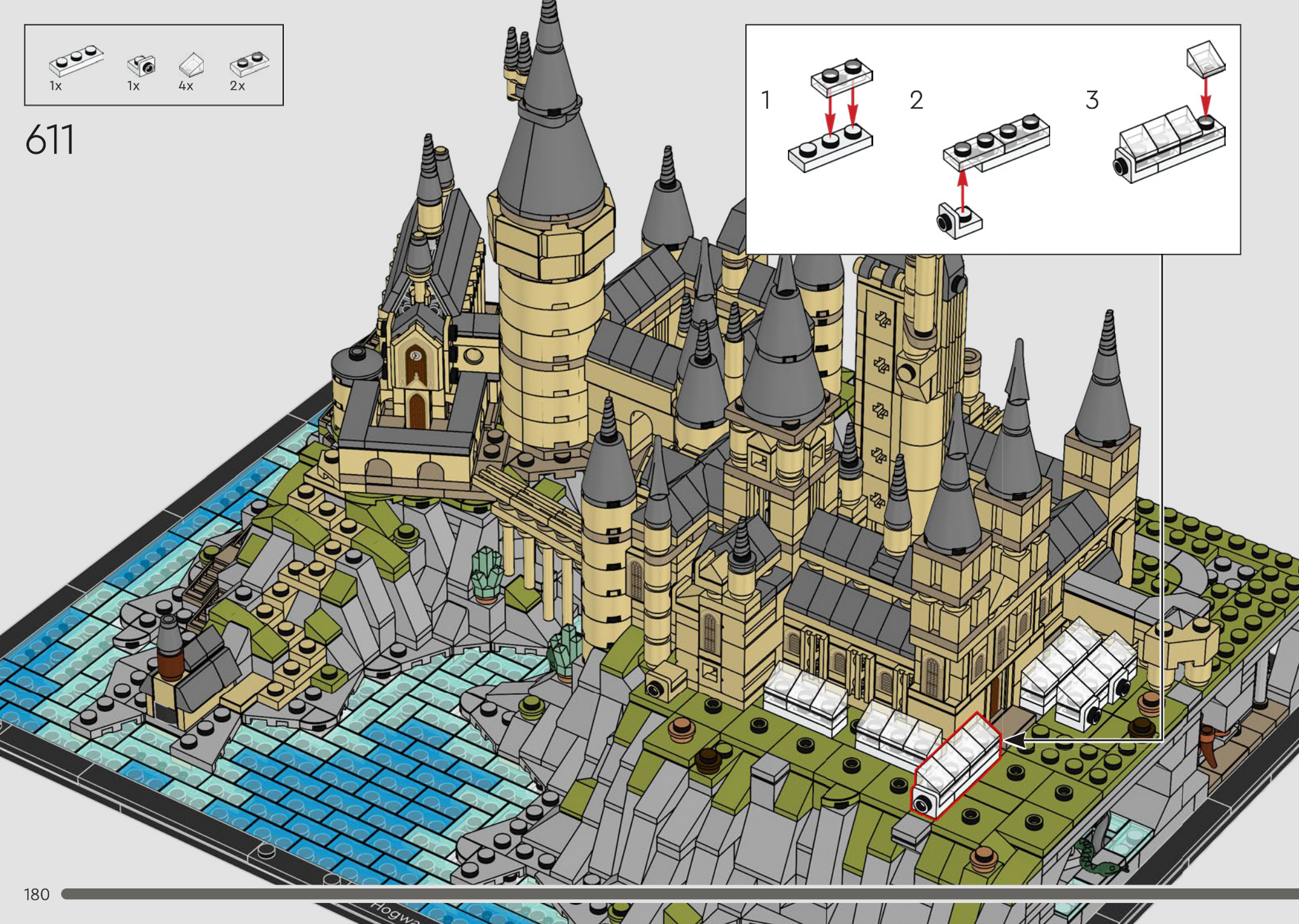
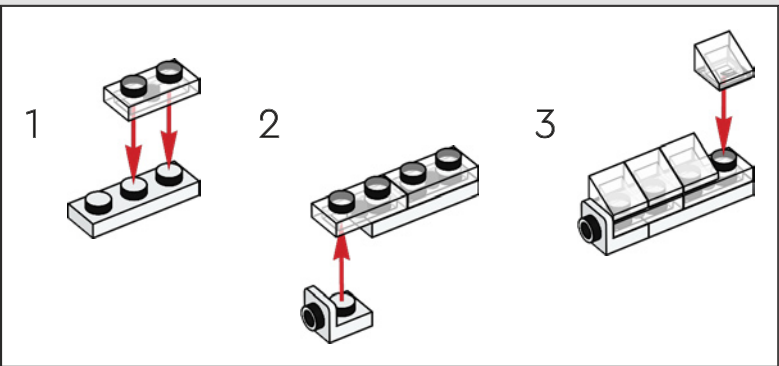

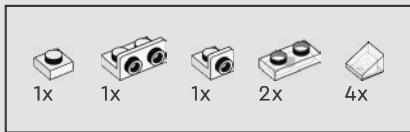

612

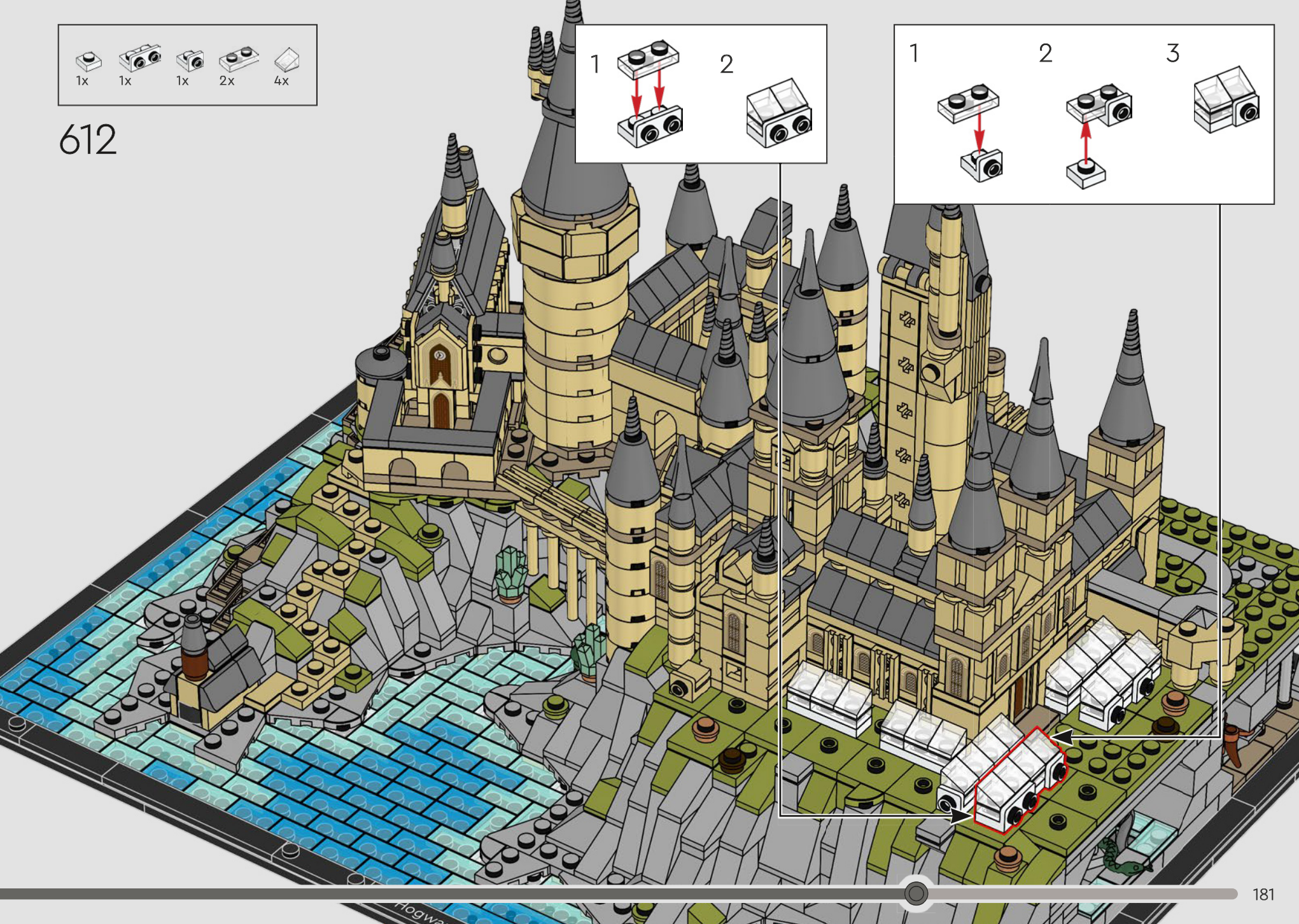
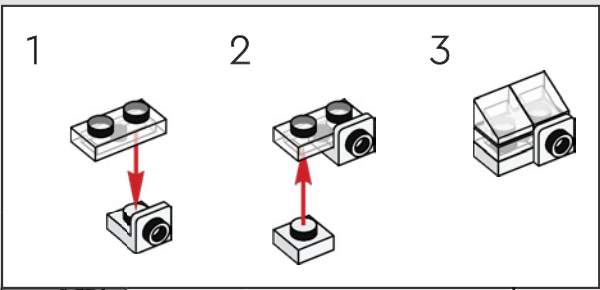
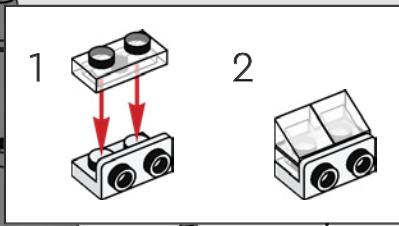

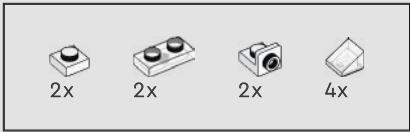



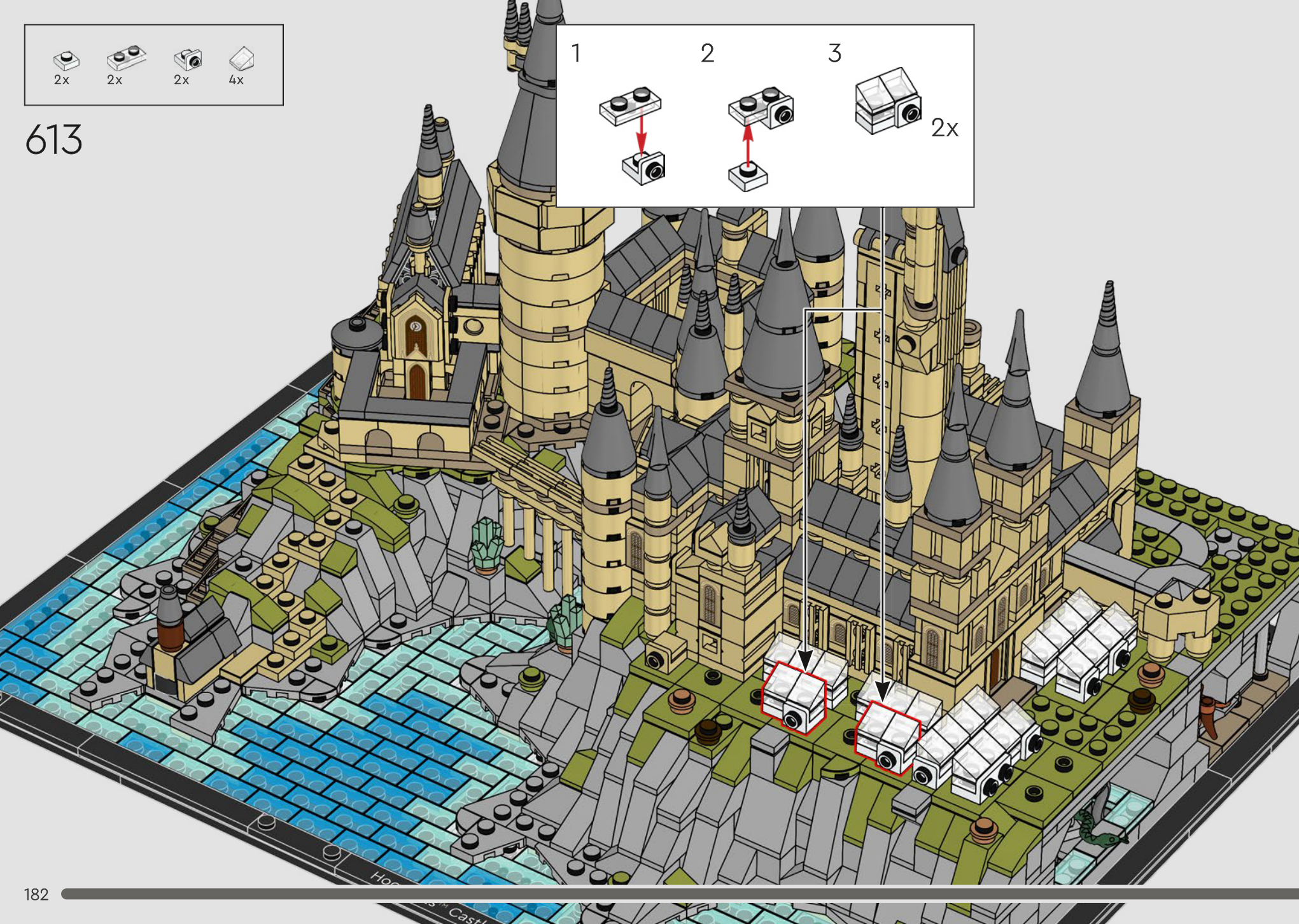
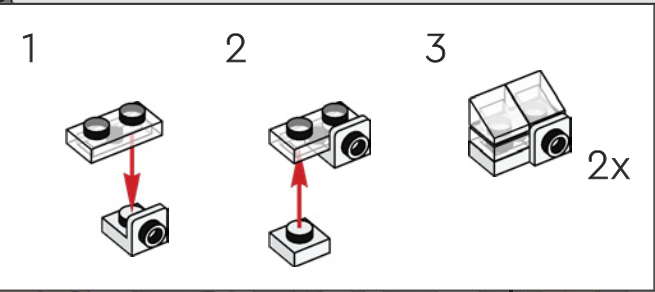

613



2x  2x  2x 

614

1  2  2x 



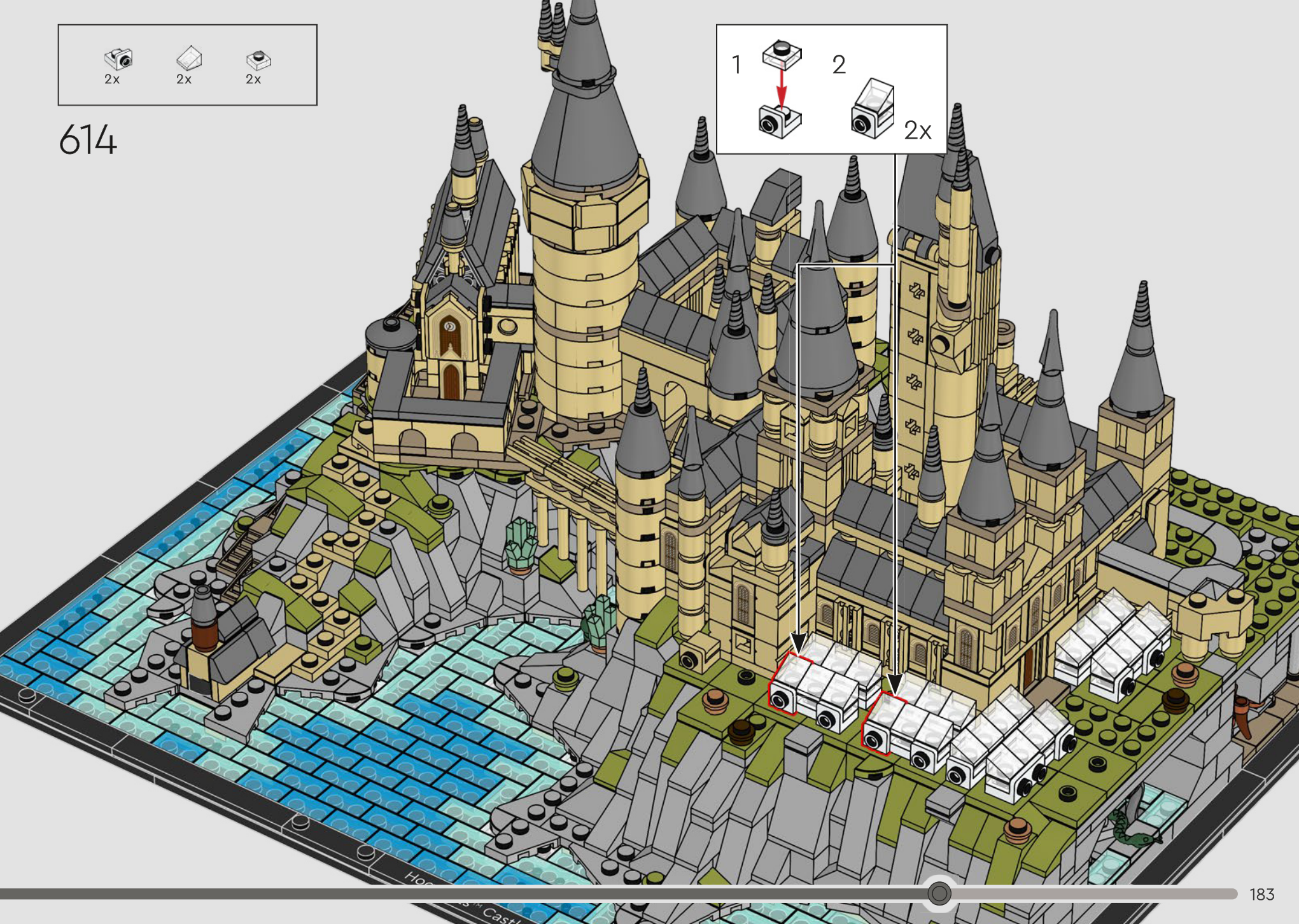

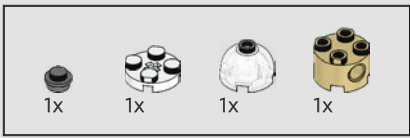

615

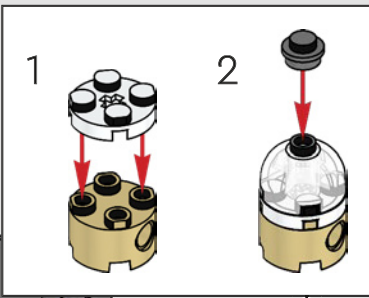



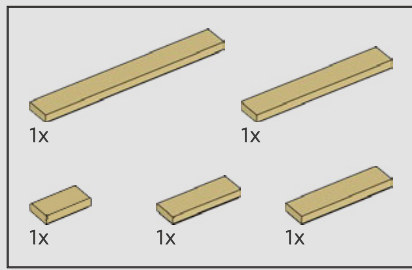

616

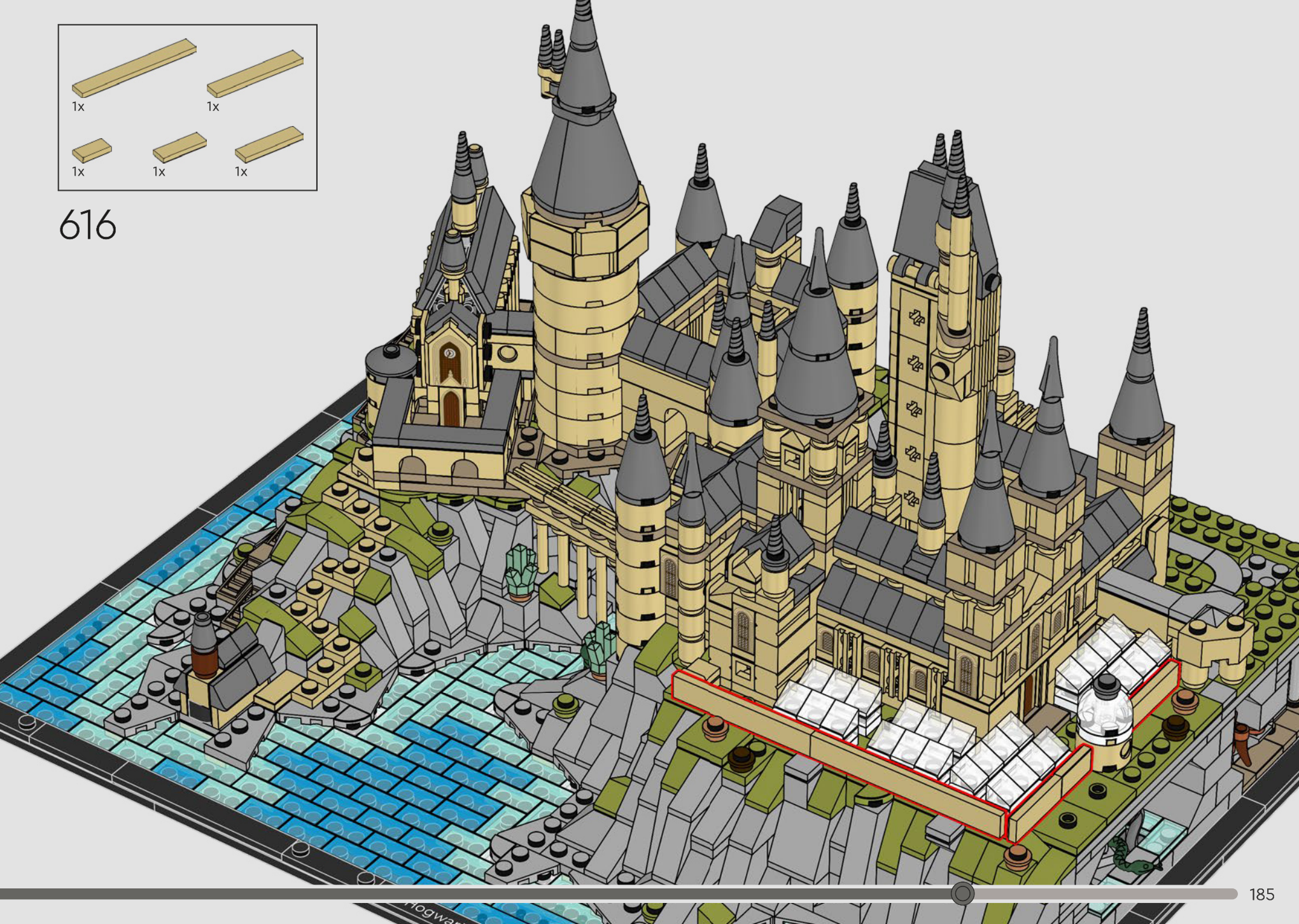

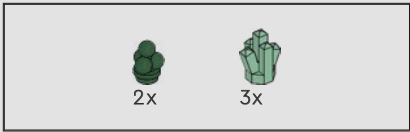

617

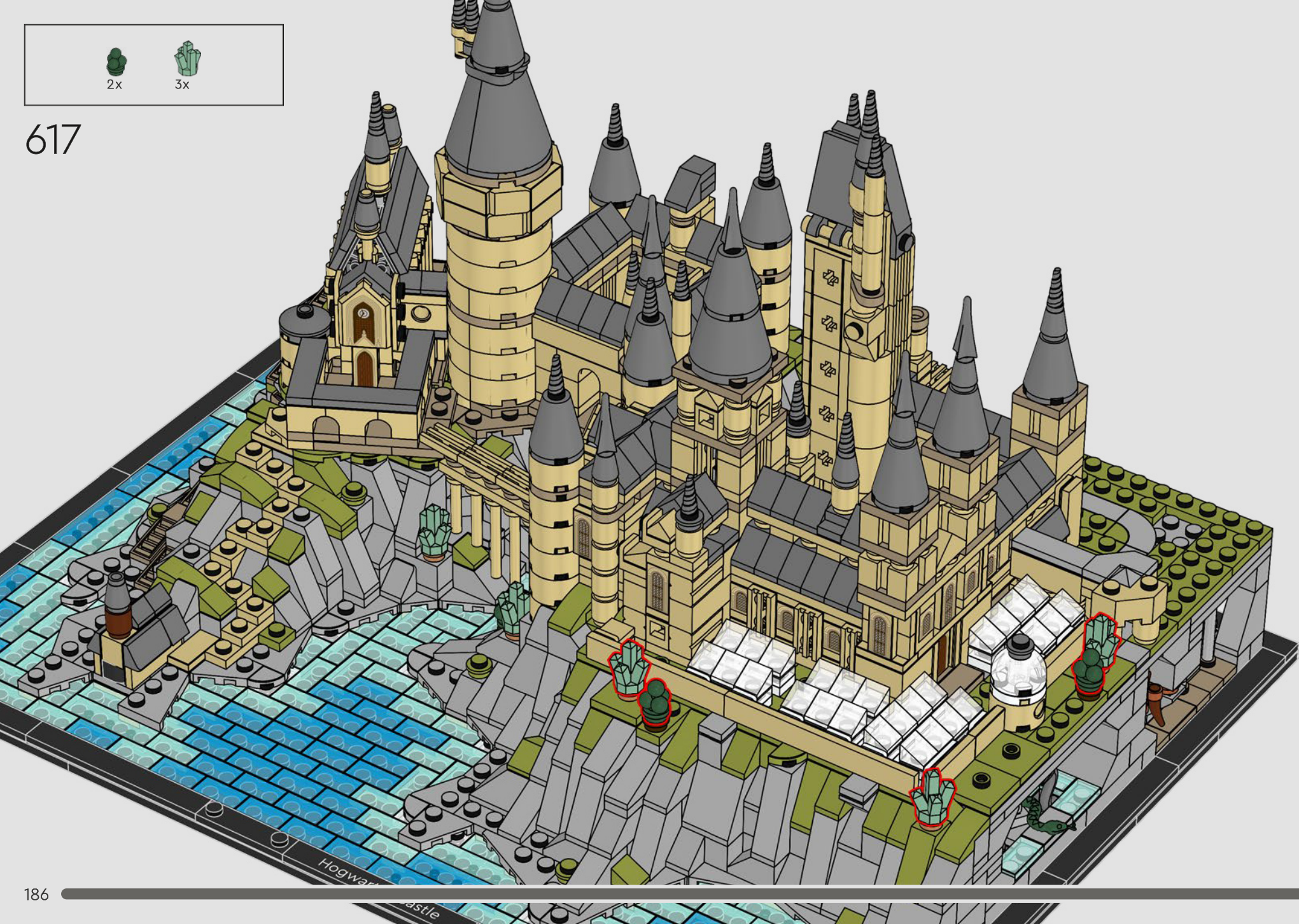

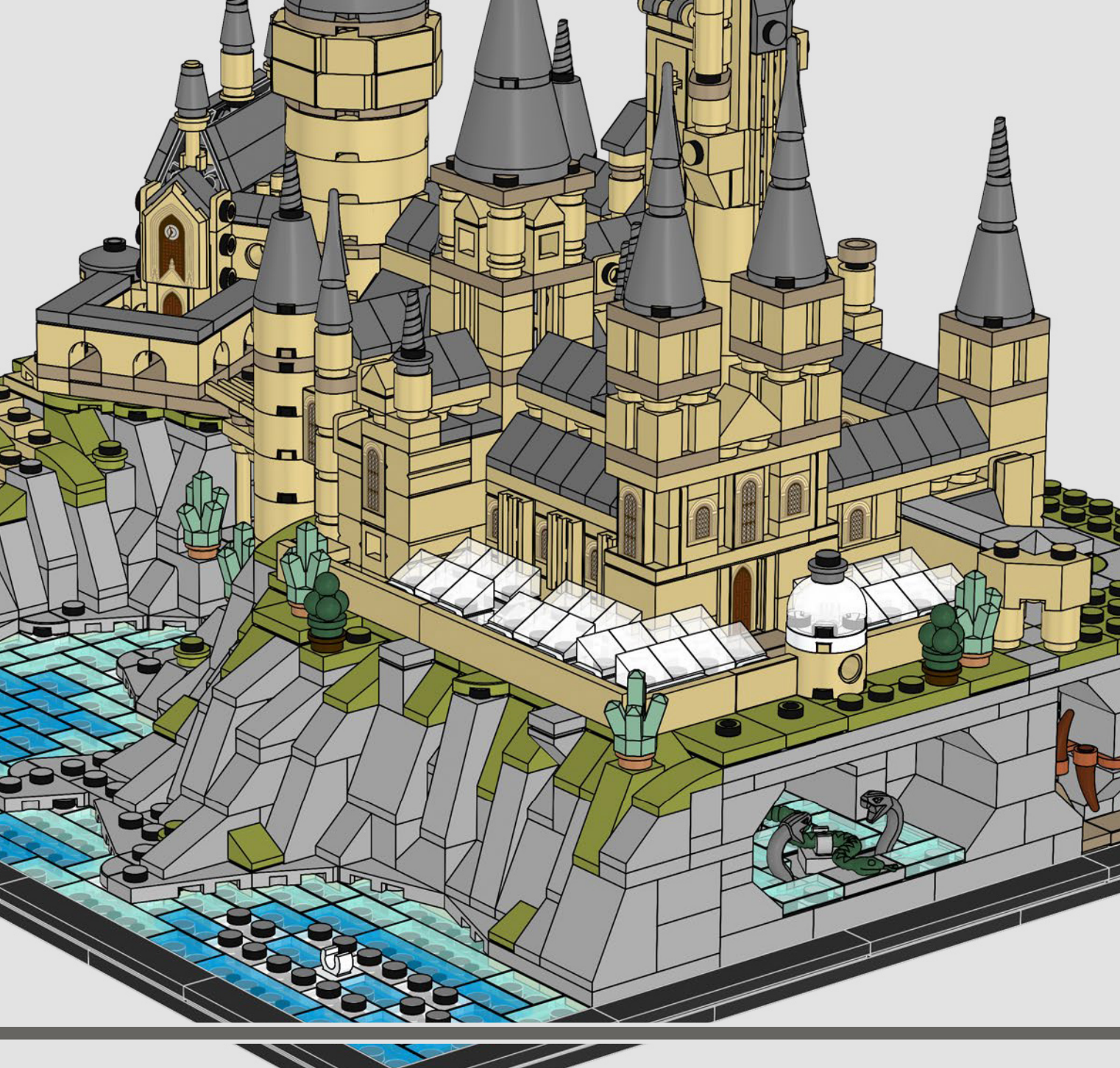

The greenhouses are where Professor Sprout, Head of the Hogwarts™ Herbology department, guides students safely through the care and use of magical plants. Now, if only everyone would use their earmuffs...



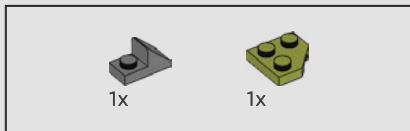

618

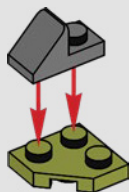

619

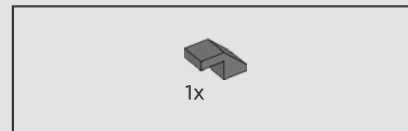
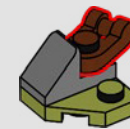

620

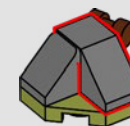

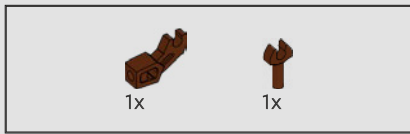

621

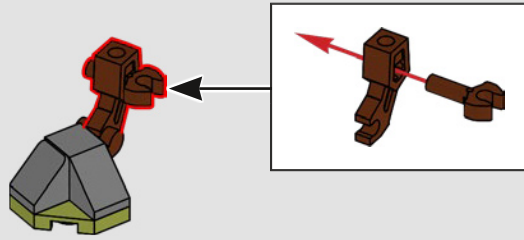

622



623

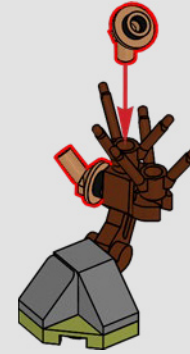

624

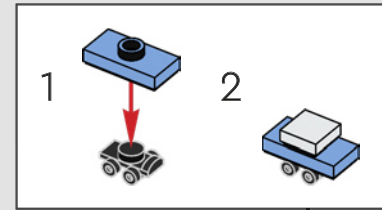



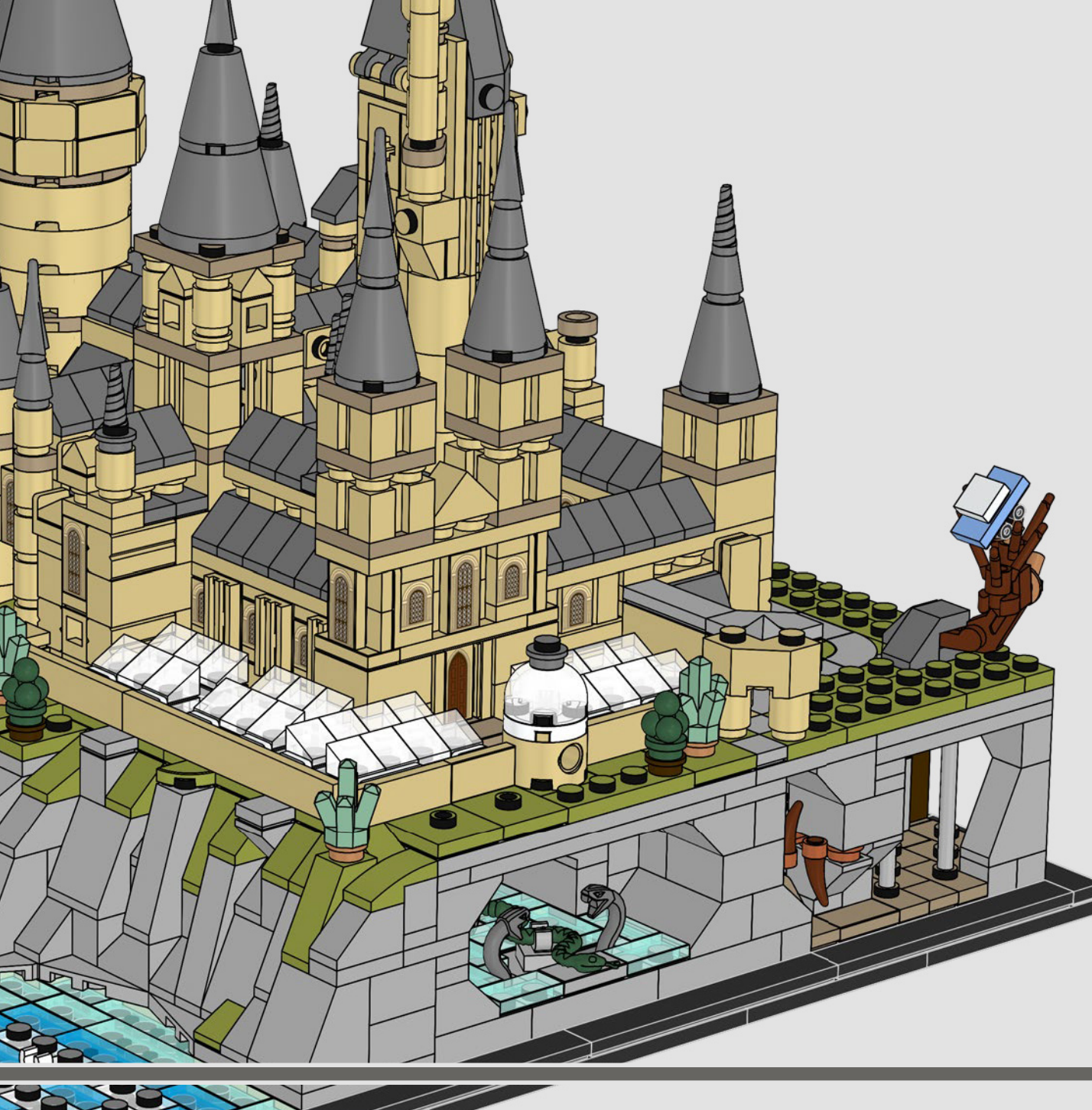

The Whomping Willow™ was planted to give Professor Lupin a safe escape during his full-moon werewolf episodes. It hides a secret tunnel leading to the Shrieking Shack where Lupin would stay until he transformed back into human form.





626

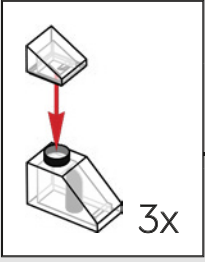
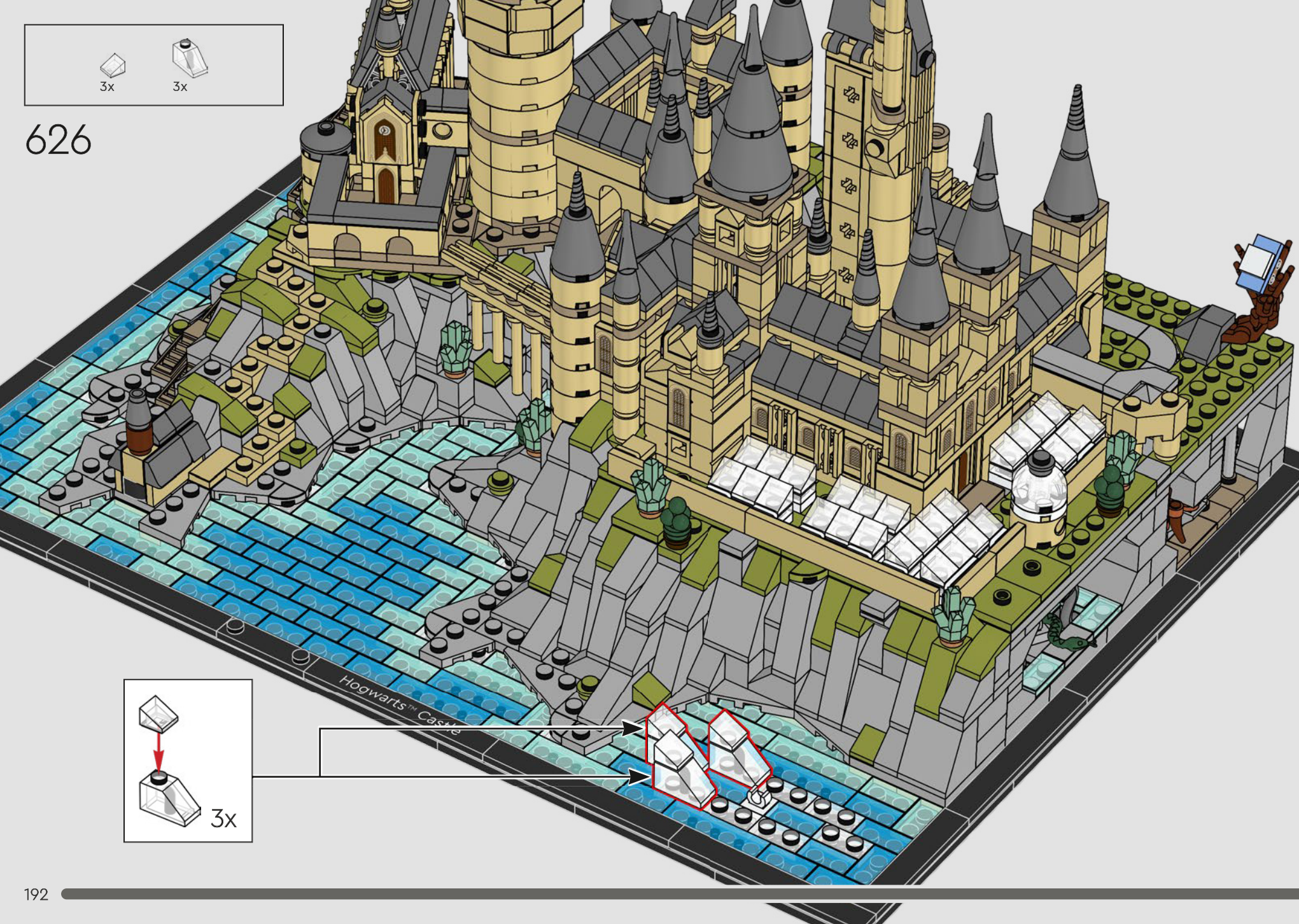





627

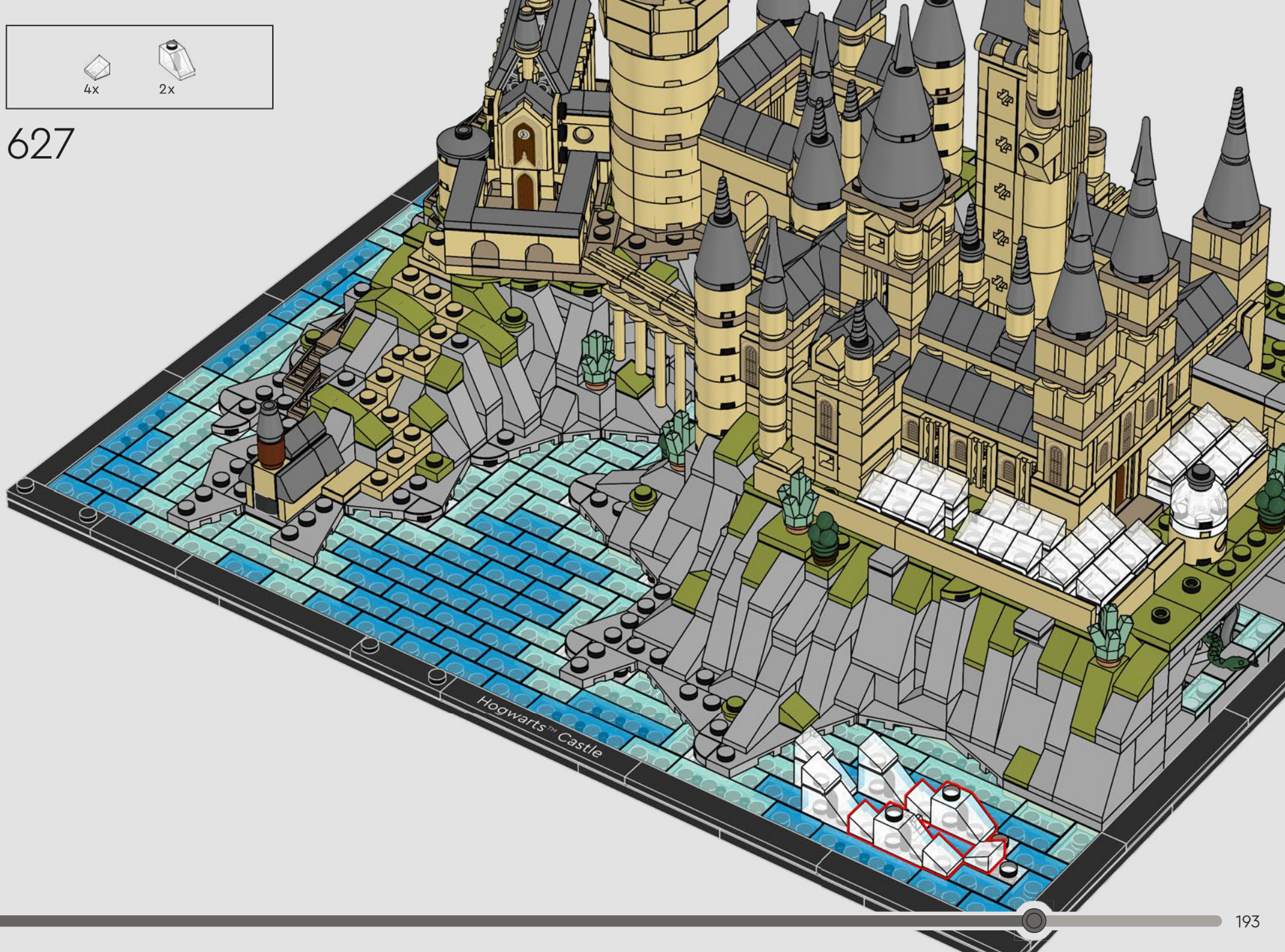

Hogwarts™ Castle

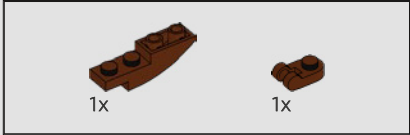
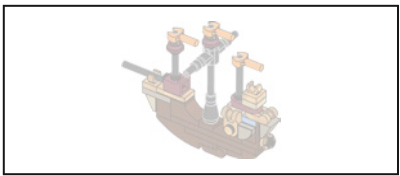

628

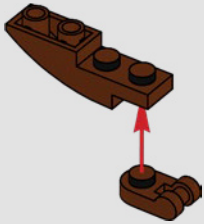

629

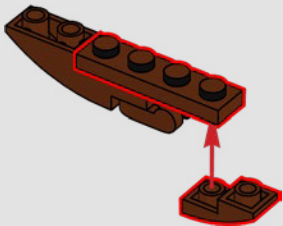

630

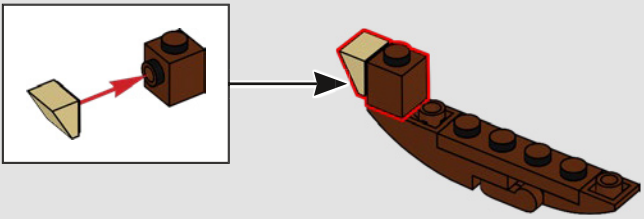

631

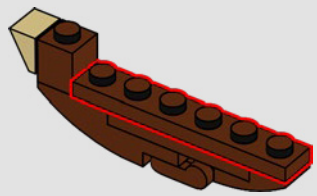

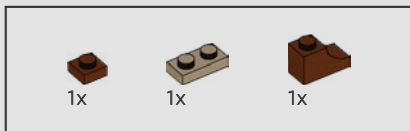

632

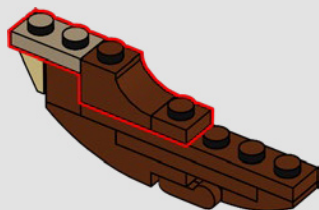

633

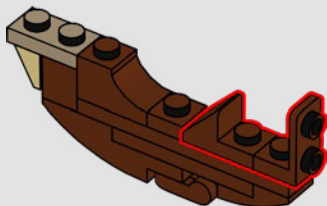

634

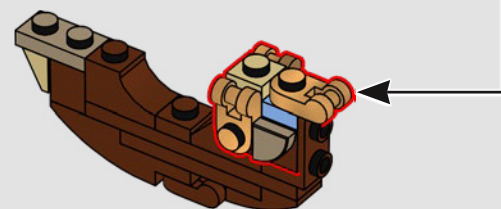
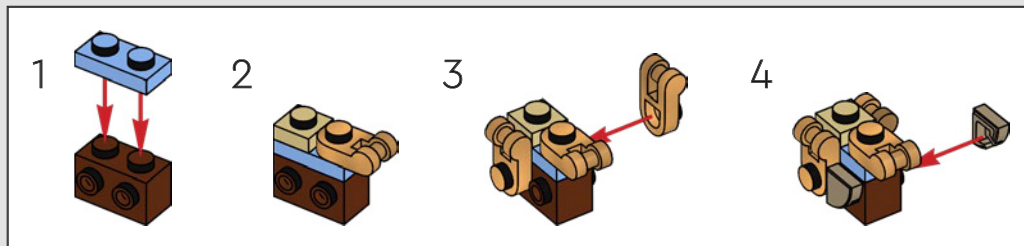



635

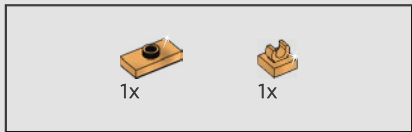
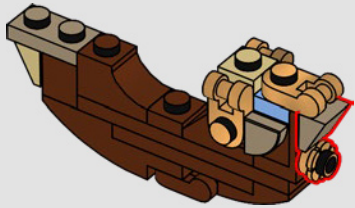

636

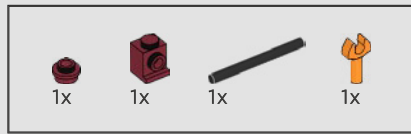
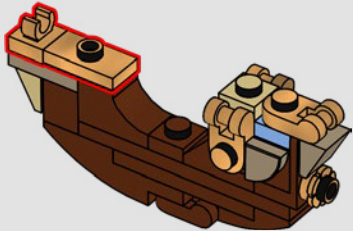

637

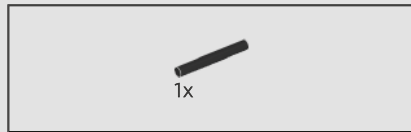
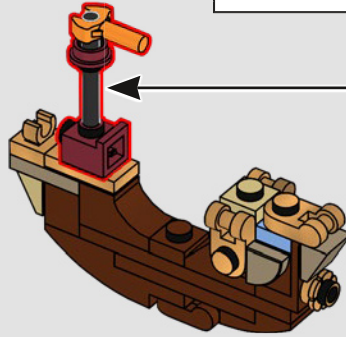
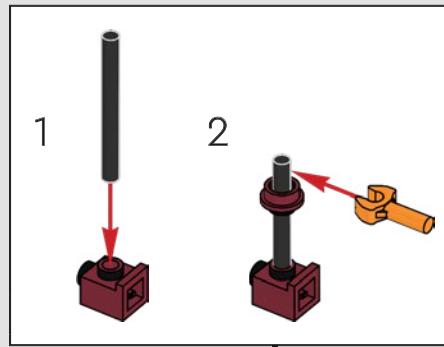

638

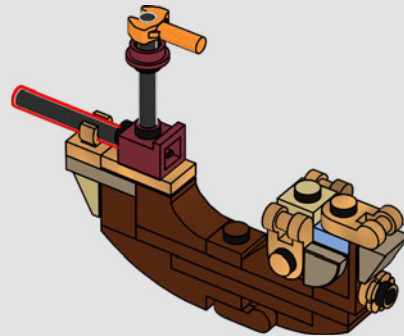

The magical Durmstrang Ship was used to travel between the Durmstrang Institute and Hogwarts™ for the Triwizard Tournament. But have you ever wondered how the ship got from the North Sea into the Black Lake?



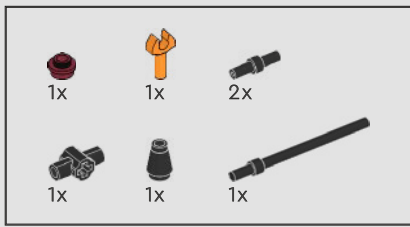

639

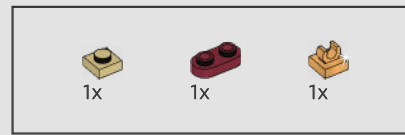
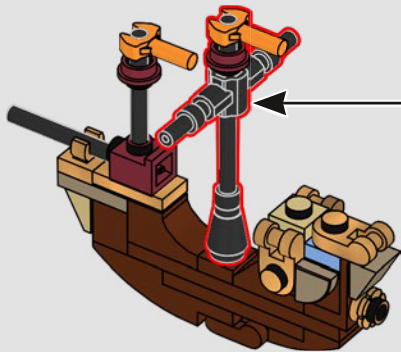
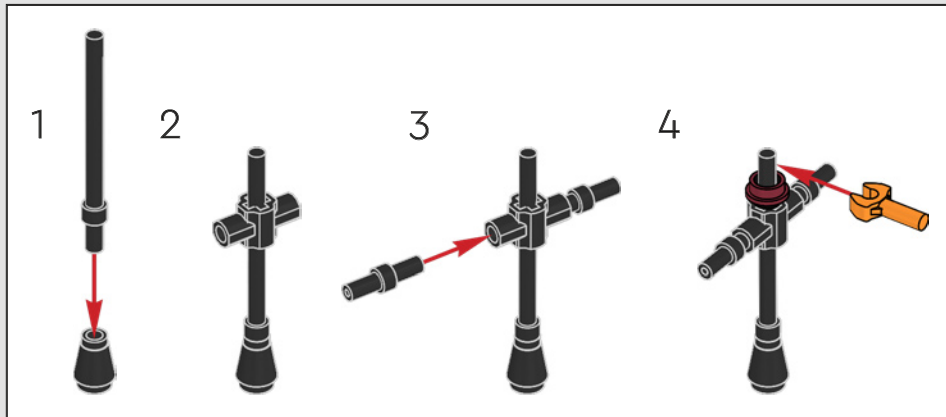

640

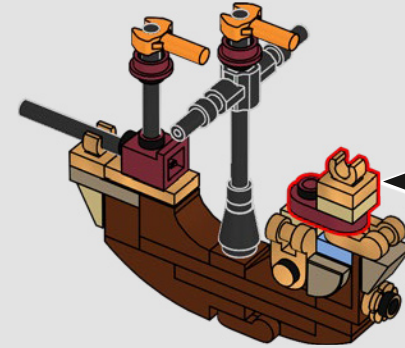
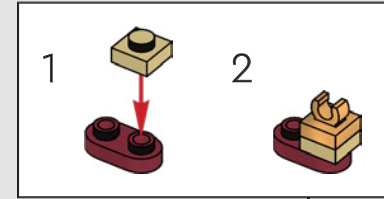

641

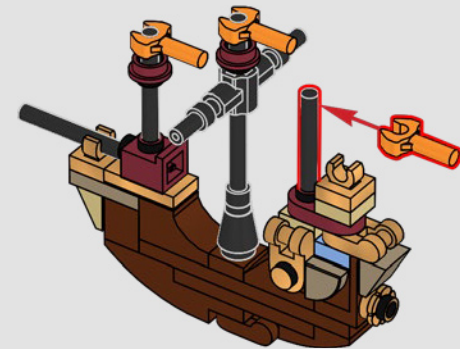



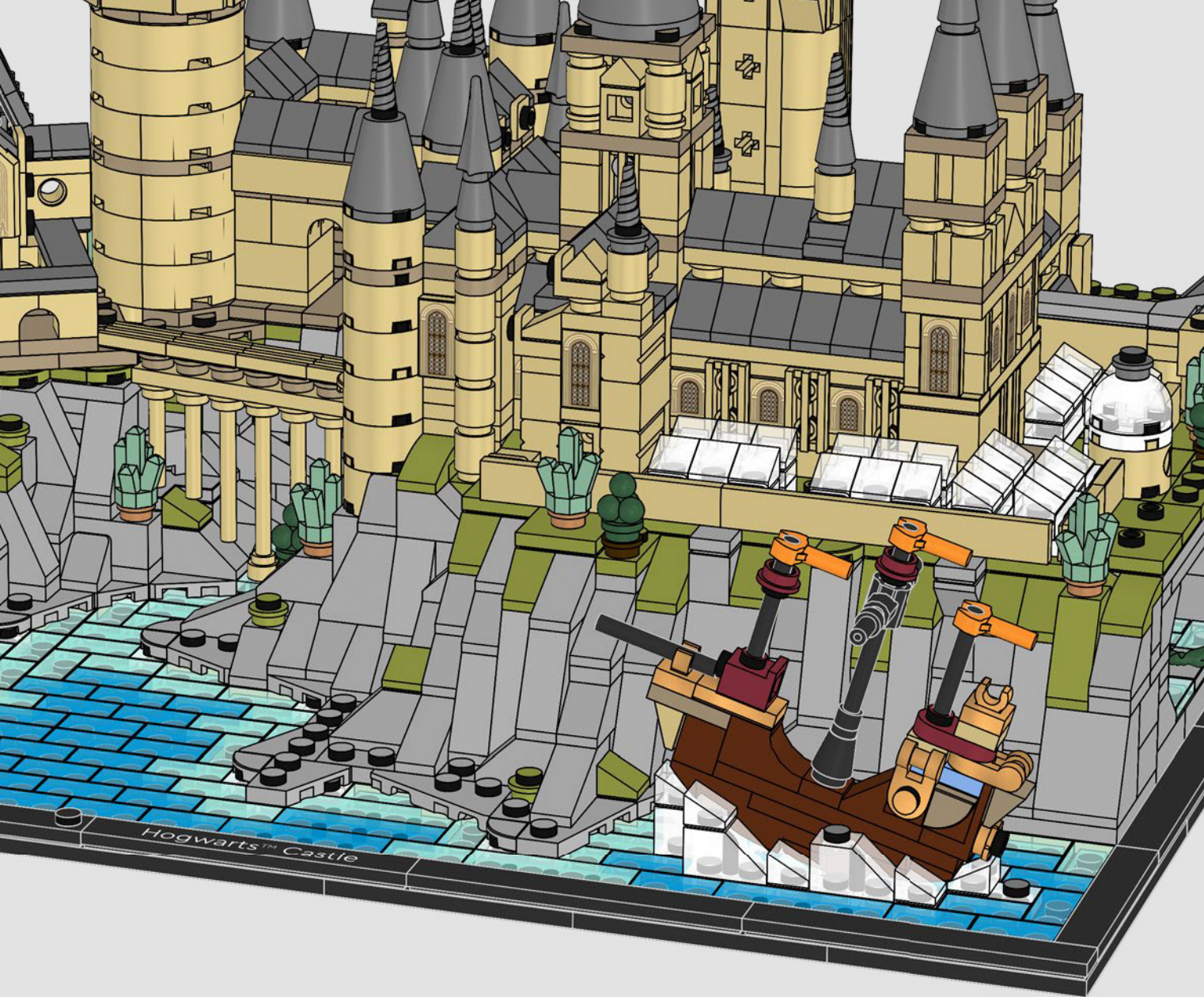

The Durmstrang Ship arrived in the lake through a magical shortcut created between the lake and other bodies of water – truly magical!

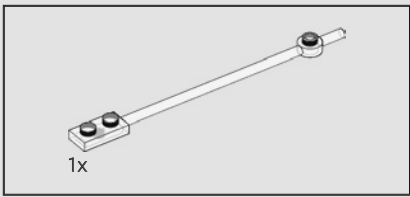

643









647

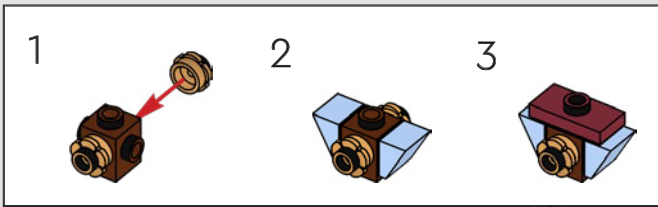

648

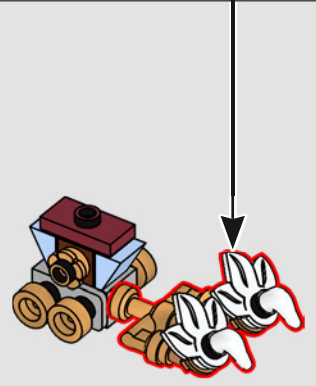
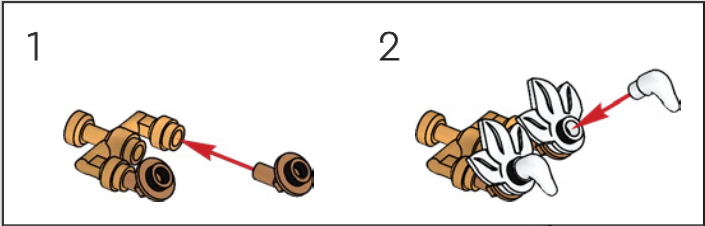

649

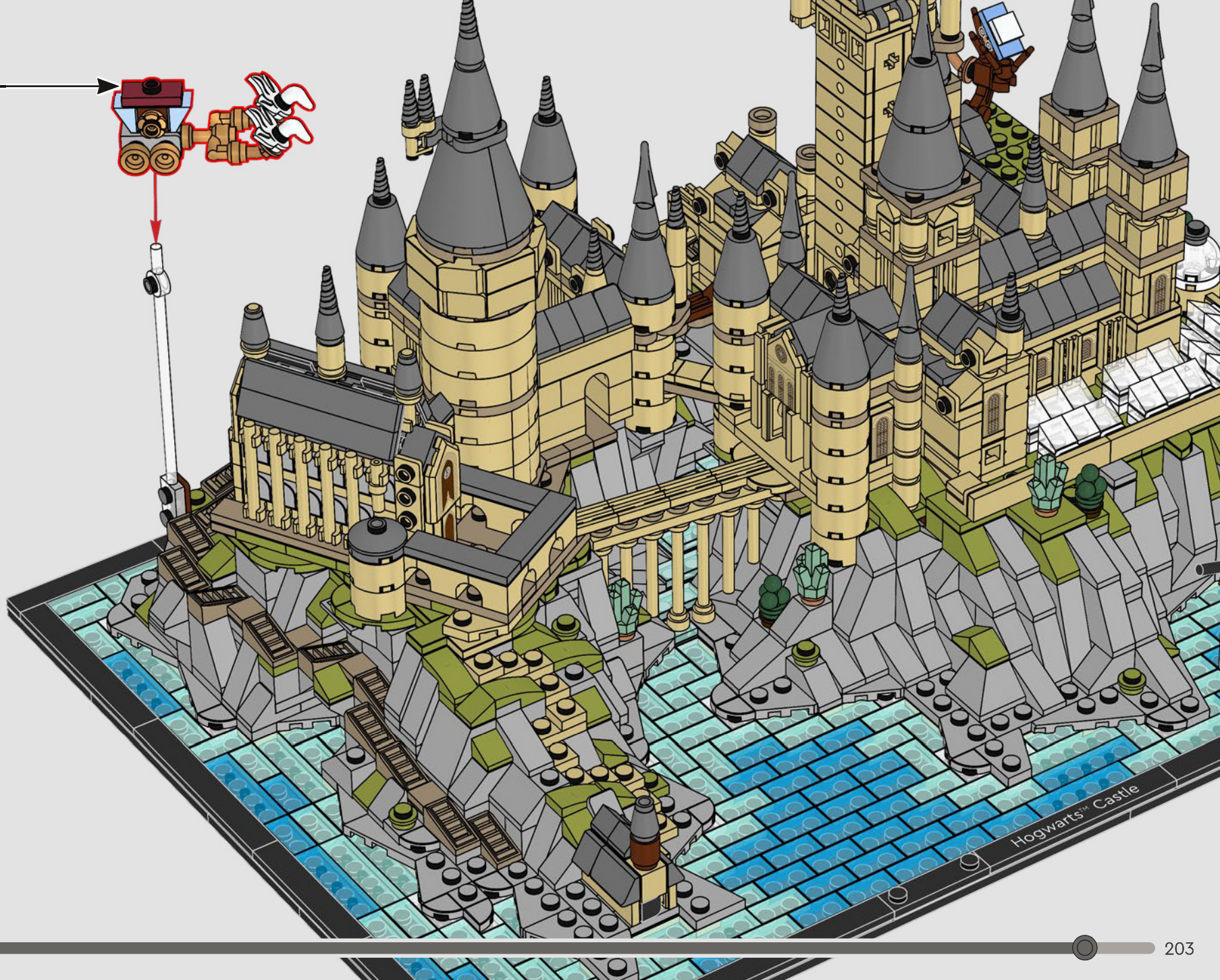

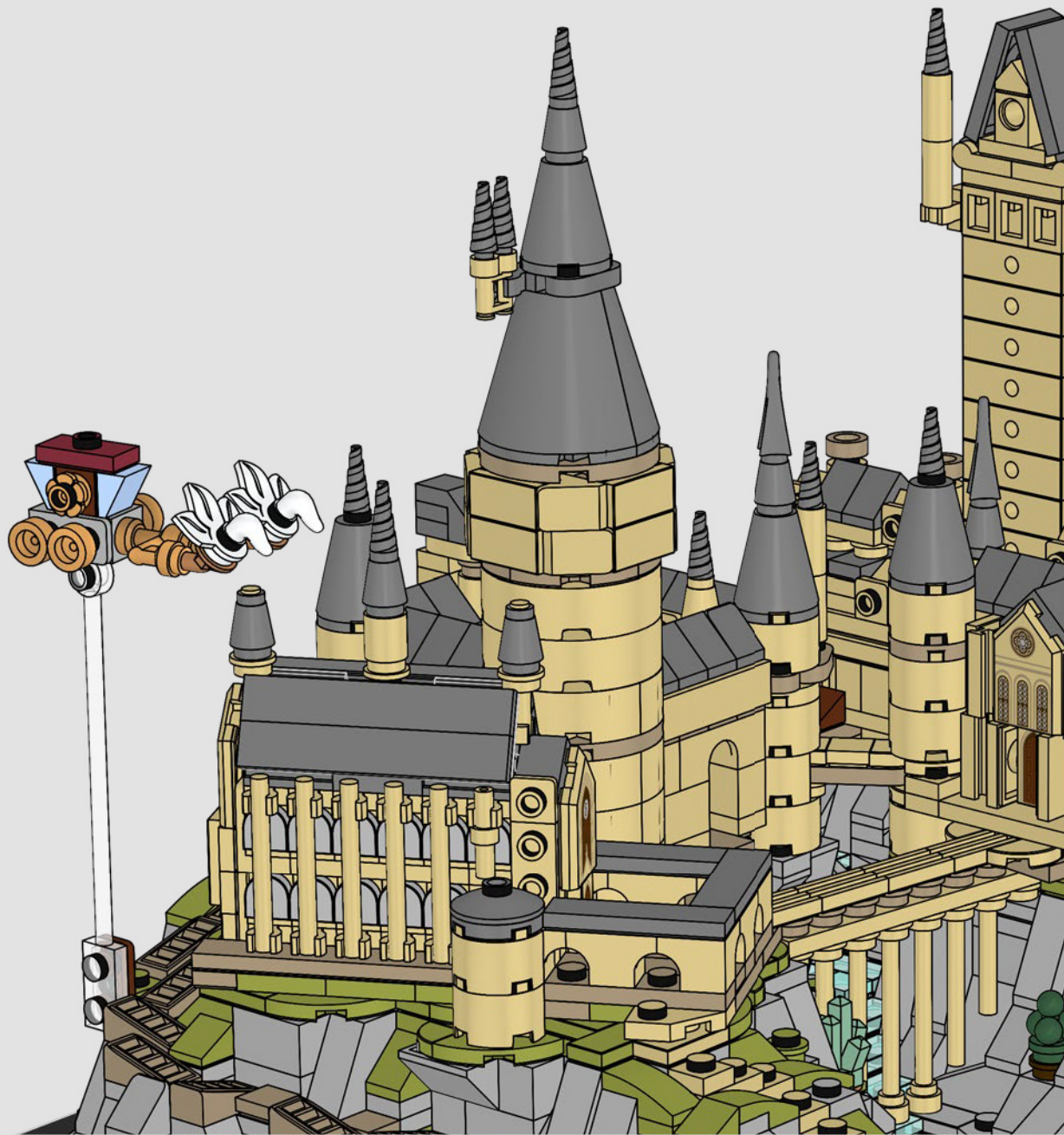

The Pegasus of the Beauxbatons' Carriage is built with white LEGO® horn and leaf elements. Notice the reins? They are actually a magically transformed candleholder!

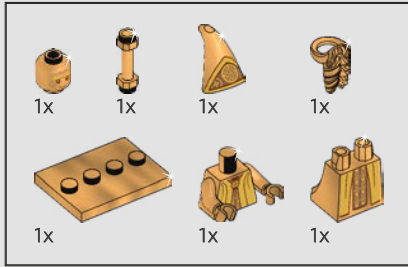

650

1

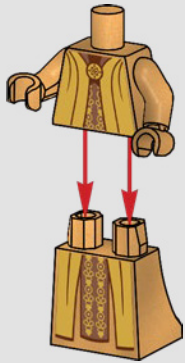

2

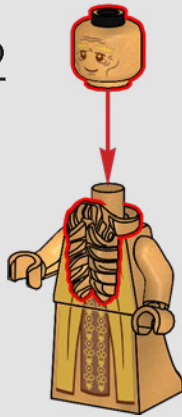

3

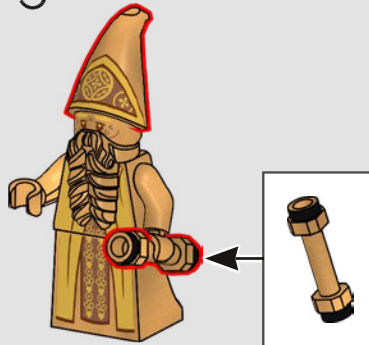

4



The Architect of Hogwarts™ Castle minifigure was created exclusively for this set, with a new beard element, and a Hogwarts model and blueprint scroll in his hand.

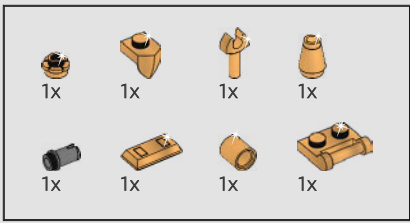

651

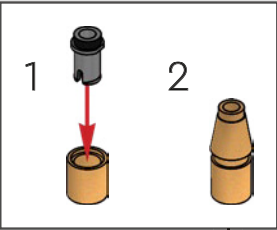

1

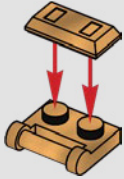

2

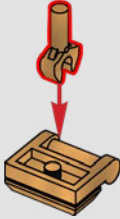

3

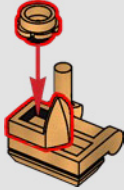

4





The Architect of  
Hogwarts™ Castle was  
active in the years  
around the turn of the  
tenth century. Not  
much is known about  
his life or other works.





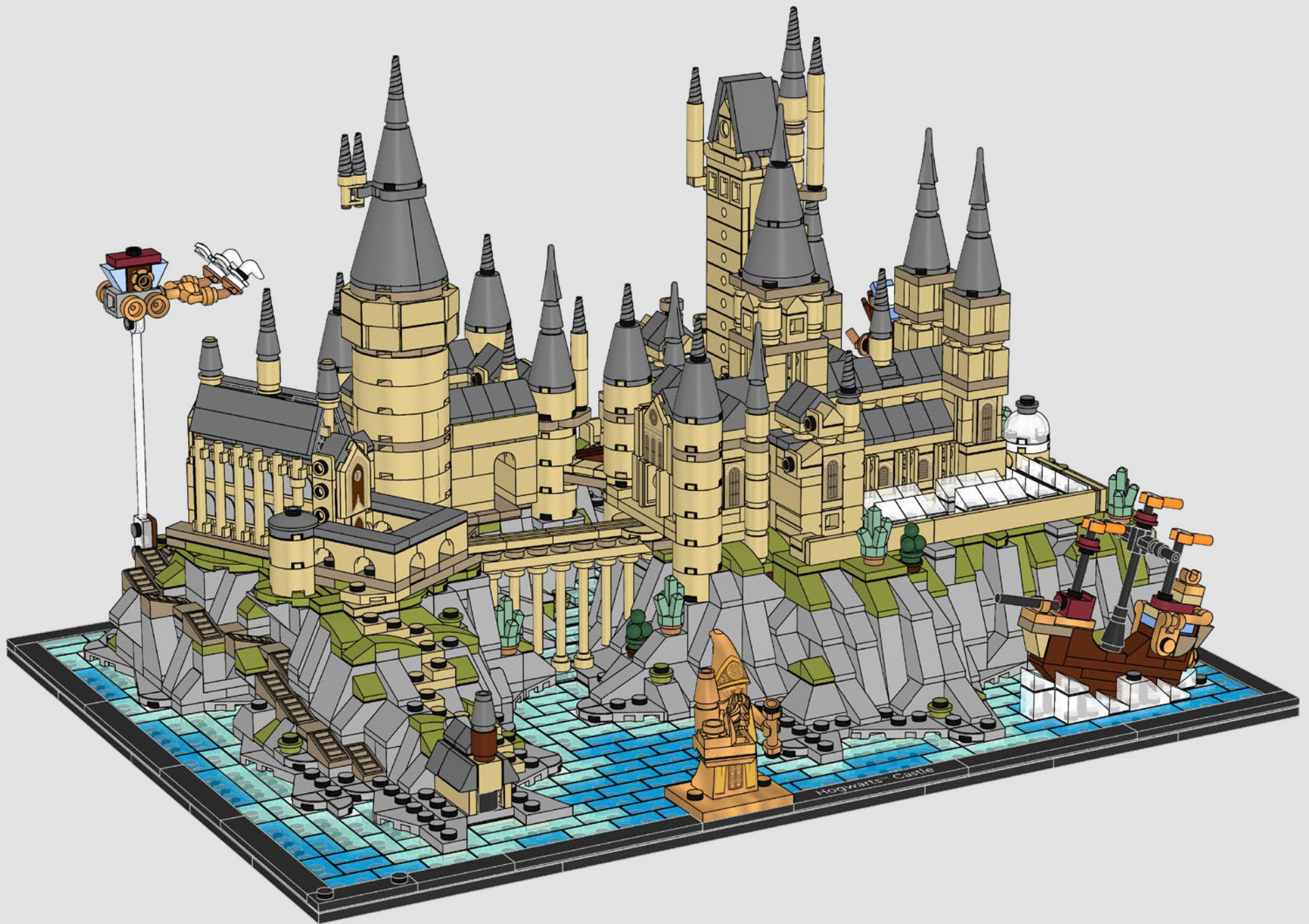



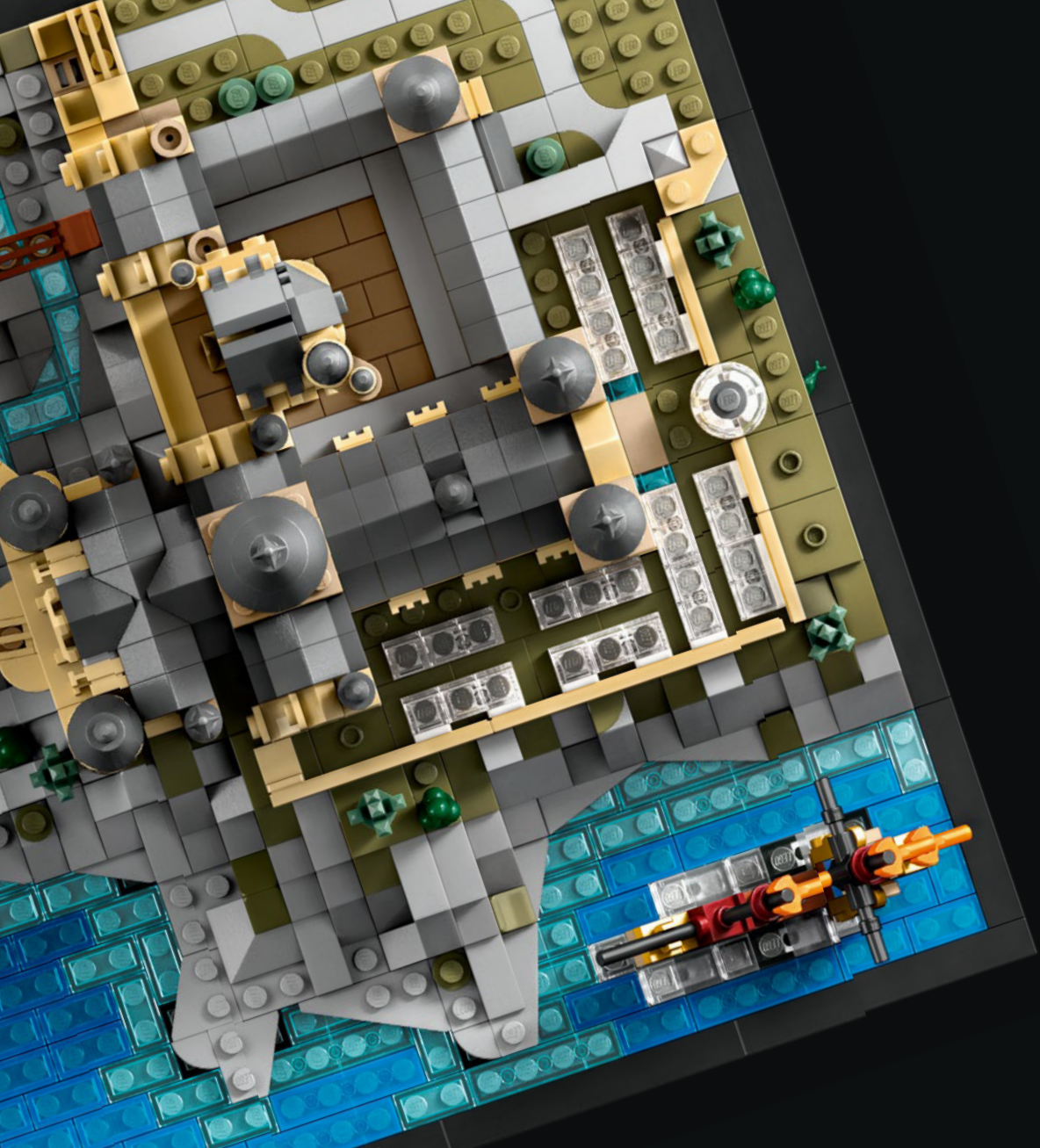

Hogwarts™ Castle



2x 614101		1x 246501	19x 4113915	1x 6374192	6x 6236425	3x 6455326	6x 4114077	7x 4618651	23x 6352222	7x 4113993	4x 614121	1x 6454443
2x 6186681		3x 300201	20x 6454440	1x 4213568	40x 4113917	10x 6391523	6x 4114306	2x 4113916	2x 4113916	2x 4181134	2x 362221	3x 6212377
2x 6328195		2x 371001	30x 4118793	1x 4224793	34x 4114026	9x 6219794	2x 6221467	1x 6058093	1x 6213676	4x 4114324	1x 302121	1x 6207933
5x 307001		2x 300101	9x 6230284	1x 6360037	9x 6148262	2x 6103001	5x 6454937	4x 6211966	2x 6294592	4x 4114324	1x 302121	1x 6092594
9x 302401		2x 300101	41x 4159553	1x 6454941	43x 6092587	1x 4205107	16x 4114084	9x 6410762	4x 6115031	2x 4159774	5x 371021	1x 6092594
1x 6348055		1x 6222425	16x 4125253	2x 6212758	36x 4124456	7x 6174925	4x 4185177	1x 6245271	4x 6115031	2x 4159774	2x 6372124	1x 6326425
8x 6242241		1x 6222425	10x 4516055	5x 6351413	10x 6455327	1x 6313611	1x 4188866	1x 4543858	2x 6454935	1x 4544139	4x 6315780	1x 6454437
2x 4111971		1x 366601	8x 6232135	2x 6408047	3x 6236914	7x 6174925	4x 4185177	2x 6454935	1x 4544139	1x 4544139	1x 6347604	1x 6454437
2x 6382783		7x 6454936	2x 4612603	1x 6447501	8x 6069165	1x 6117975	1x 618265	12x 6116614	10x 4114309	4x 4114001	5x 242023	1x 4585493
1x 6044691		27x 4117070	3x 6145570	1x 6262018	4x 4109995	1x 6249809	1x 618265	9x 4118790	1x 6351905	4x 4114001	5x 301023	1x 6378168
1x 403201		3x 4529237	2x 4579260	1x 4624086	1x 6024495	2x 6253003	12x 6055868	1x 6351905	7x 4124067	4x 4113988	2x 366623	4x 6209691
1x 4667575		63x 4161734	2x 4140562	1x 4624086	1x 6024495	2x 6253003	1x 6469454	4x 4159739	4x 4124067	4x 4113988	17x 614124	1x 4529247
7x 302301		11x 6443061	2x 4579260	3x 6145570	1x 6024495	4x 4160483	1x 6458487	2x 6175367	2x 4112982	1x 6075179	2x 366623	1x 6186672
1x 6070698		2x 4179771	20x 4125220	3x 6145570	1x 6214334	1x 6374166	1x 6458487	10x 4113233	2x 4112982	1x 6075179	17x 614124	1x 6453281
3x 362301		4x 6175968	2x 4179771	2x 4179771	1x 6214334	1x 6374166	1x 6454439	10x 4113233	2x 4112982	1x 6075179	6x 362224	1x 6454435
11x 6195371		17x 6365720	4x 6175968	2x 4179771	1x 6214334	2x 6374166	1x 6454439	5x 6232136	1x 4157277	1x 4624185	3x 362324	1x 6256803
1x 4550745		1x 4569547	2x 6353196	1x 6232037	2x 4159279	2x 4217562	11x 4121921	7x 6257600	3x 4243824	2x 447721	1x 4188313	1x 6262138
		1x 6167923	17x 6365720	9x 4218749	5x 6236423	5x 6443062	6x 6131896	1x 4157277	1x 4157277	2x 447721	1x 6457333	1x 6415995
		3x 6374151	3x 6357613	3x 6357613	1x 6445058	2x 4124455	2x 4124455	5x 4550324	3x 6383728	2x 611121	1x 6350055	1x 6083975

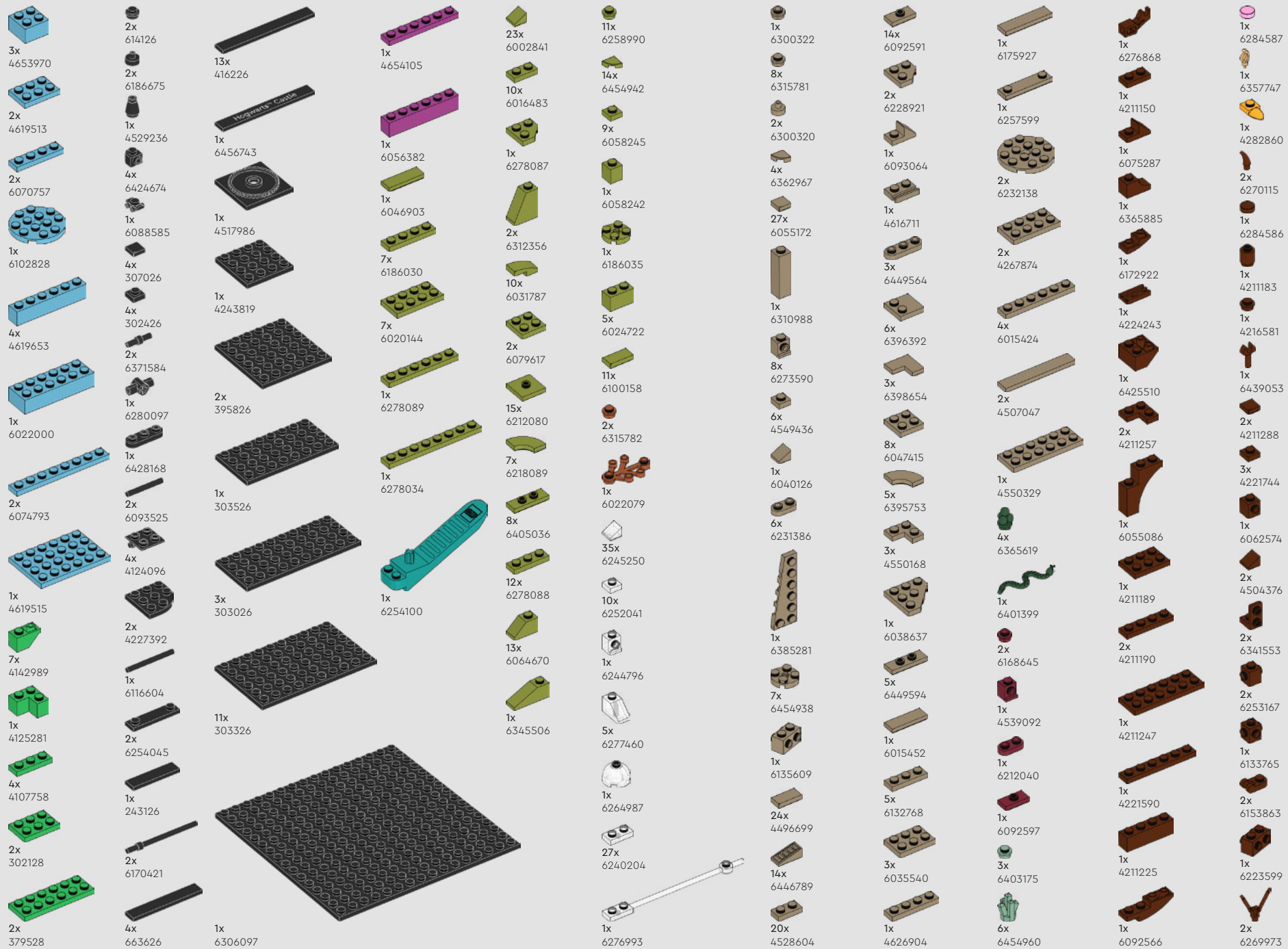

- 1x 4210763
- 2x 6168776
- 4x 4211066
- 2x 6331866
- 3x 4211094
- 1x 6126083
- 1x 6201630
- 10x 6092666
- 1x 6115080
- 1x 4211010
- 2x 6174938
- 17x 6445056
- 6x 6269969
- 15x 4529240
- 2x 6331689
- 1x 4210867
- 2x 4211100
- 8x 4210719
- 1x 4243831
- 1x 6186635
- 2x 4211103
- 3x 6231765
- 2x 4210633
- 1x 6431826
- 3x 6395635
- 4x 6454438
- 1x 4211098
- 5x 6343852
- 4x 4210651
- 4x 6262021
- 2x 4504378
- 2x 6234583
- 2x 6235153
- 7x 6167641
- 4x 6400315
- 51x 6251289
- 8x 6252050
- 1x 4179825
- 1x 6092601
- 1x 6221607
- 1x 6296892
- 45x 4226221
- 3x 4567887
- 14x 4211135
- 1x 4211088
- 3x 6069164
- 2x 6092572
- 3x 4211053
- 1x 4526932
- 9x 4211394
- 1x 4529241
- 1x 6284071
- 3x 6448793
- 21x 6250597
- 1x 6455328
- 5x 4521921
- 23x 4211389
- 5x 6362975
- 12x 6176433
- 3x 6345639
- 2x 6433942
- 12x 6163478
- 6x 4211415
- 2x 4211489
- 1x 4526932
- 9x 4211394
- 1x 6420741
- 6x 4211791
- 5x 4211794
- 1x 6234738
- 18x 4211399
- 1x 6225242
- 46x 4211614
- 1x 6347715
- 3x 6258381
- 2x 4568637
- 2x 6075075
- 15x 4211488
- 2x 6211969
- 12x 4211428
- 7x 6116608
- 4x 6066097
- 5x 6186657
- 1x 4216248
- 3x 6308012
- 4x 6065824
- 1x 4651063
- 1x 6469440
- 1x 6269049
- 40x 4515374
- 12x 4211437
- 6x 4657459
- 2x 6211773
- 10x 4211445
- 13x 6093859
- 11x 4211494
- 46x 4211398
- 9x 4211414
- 2x 6170387
- 1x 4211564
- 2x 6123809
- 5x 4234535
- 8x 4211353
- 2x 4211410
- 1x 6163990
- 11x 4211396
- 2x 4211356
- 1x 6213378
- 13x 6435857
- 14x 4211349
- 11x 4211387
- 1x 4216250
- 3x 4211397
- 1x 6177078
- 1x 6126082
- 18x 4211429
- 8x 4211386
- 2x 6435930
- 1x 6306729
- 4x 6163477
- 1x 4645397
- 3x 4558169
- 1x 6075066
- 3x 4211438
- 2x 4211393
- 1x 4618874
- 2x 4243797
- 2x 4211549
- 1x 6015347
- 7x 4211385
- 2x 4211395
- 1x 6372029
- 1x 4211392
- 6x 4211404
- 1x 6037399
- 1x 4211474
- 3x 4251149
- 2x 4211521
- 2x 4211407
- 3x 6059033
- 3x 4211452
- 1x 4211795
- 2x 4211425
- 6x 4157103
- 3x 6439042
- 3x 4173805
- 16x 4121739
- 17x 4220634
- 23x 4164037
- 10x 6254256
- 85x 6251295
- 3x 6343877
- 11x 6252049
- 1x 4211522
- 1x 4211402
- 1x 4211405



 [LEGO.com/service](https://www.LEGO.com/service)



# YOU COULD WIN



## YOU COULD WIN

Your feedback will help shape the future development of this product series.

Visit:

## DU KÖNNTEST GEWINNEN

Dein Feedback trägt zur Weiterentwicklung dieser Produktreihe bei.

Geh auf:

## VOUS POURRIEZ GAGNER

Vos commentaires nous aideront à concevoir les futurs produits de cette gamme.

Visitez :

## POTRESTI VINCERE TU

La tua opinione ci aiuterà a migliorare la creazione futura di questa linea di prodotti.

Visita:

## PUEDES GANAR

Tu opinión contribuirá al futuro de esta serie de productos.

Visita:

## 轻松获奖

您的反馈将有助于我们在今后改进本产品系列。

请访问:

---

[LEGO.com/productfeedback](https://www.lego.com/productfeedback)

---

You also have the chance to win a LEGO® set.

Terms and conditions apply.\*

Außerdem hast du die Chance, ein LEGO® Set zu gewinnen.

Es gelten die Teilnahmebedingungen.\*

Vous pourriez également gagner un ensemble LEGO®.

Des conditions s'appliquent.\*

Hai anche la possibilità di vincere un set LEGO®.

Termini e condizioni sono applicabili.\*

También tienes la oportunidad de ganar un set LEGO®.

Aplican términos y condiciones.\*

您还有机会赢取乐高®套装。

条款和条件适用。\*

\*[LEGO.com/productfeedback-terms](https://www.lego.com/productfeedback-terms)

# II

LEGO and the LEGO logo are trademarks of the LEGO Group. ©2023 The LEGO Group. 6502946

WIZARDING WORLD and all related trademarks, characters, names, and indicia are  
© & ™ Warner Bros. Entertainment Inc. Publishing Rights © JKR. (s23)