

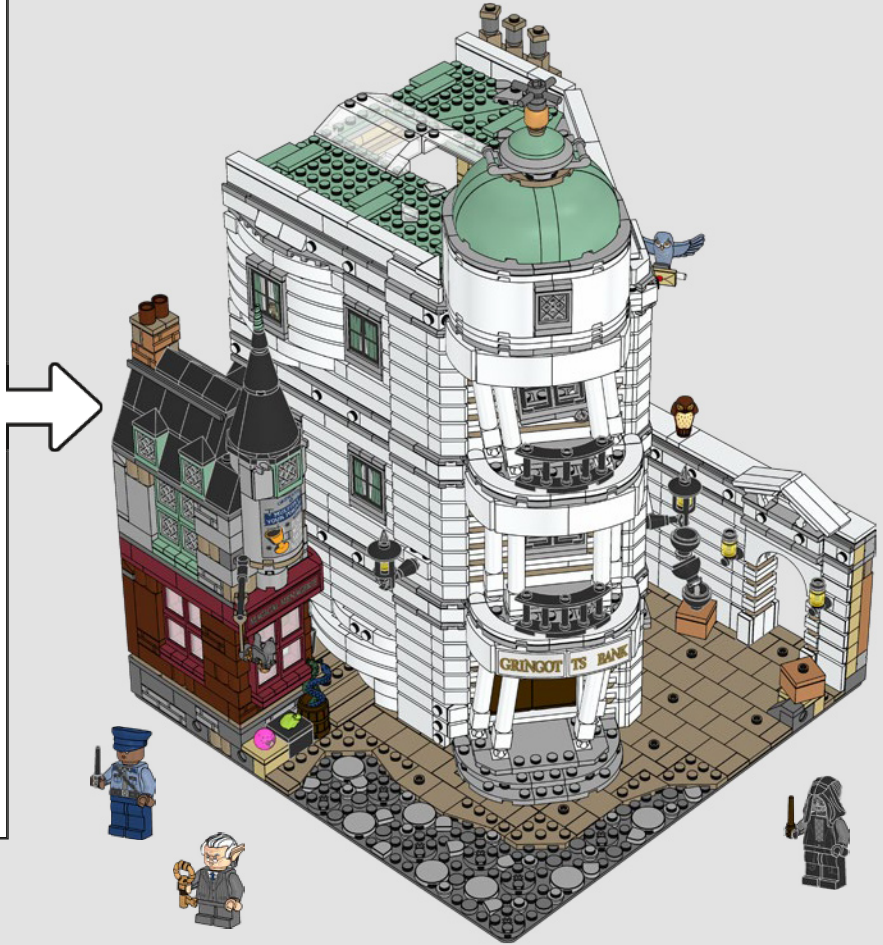

Harry Potter

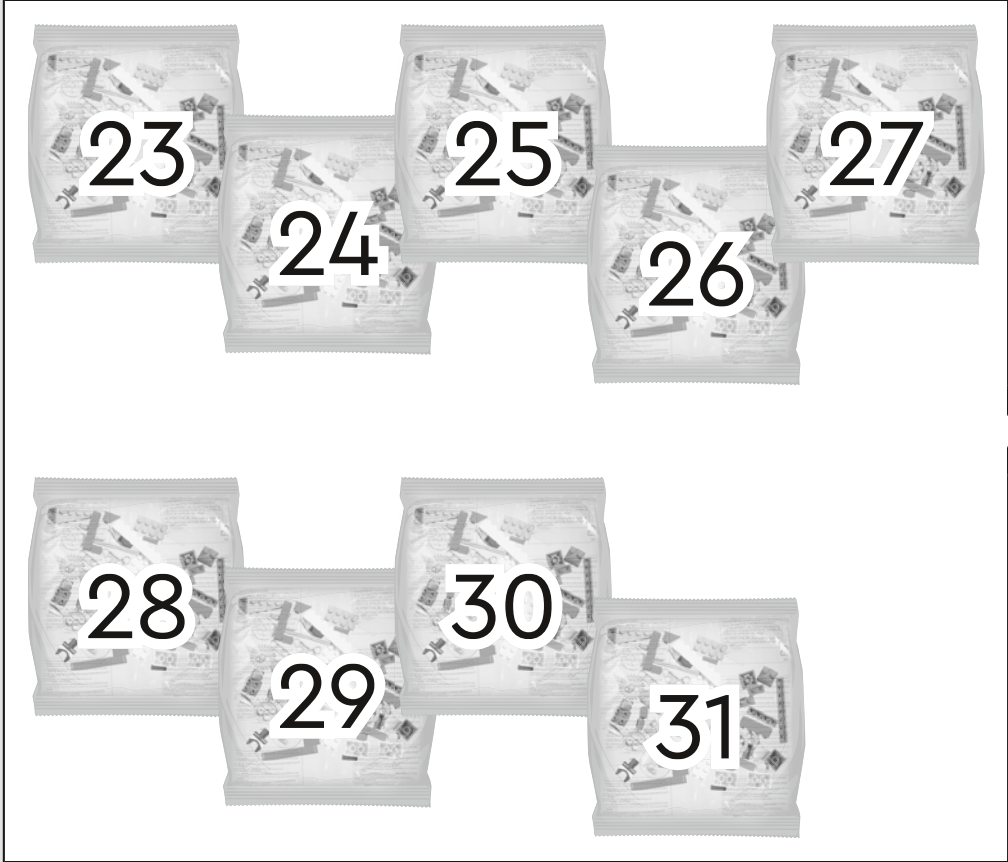

WIZARDING  
WORLD



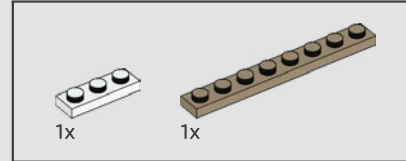
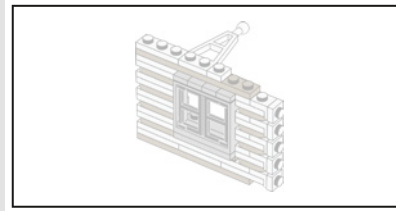

324

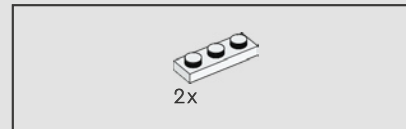
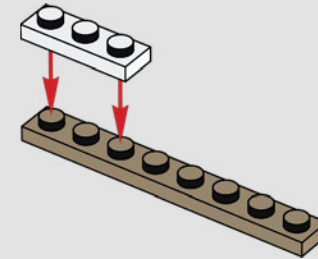

325

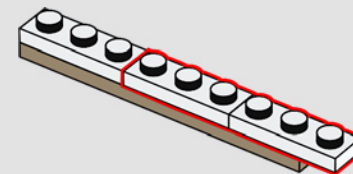

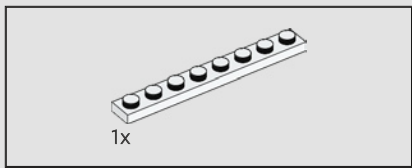

326

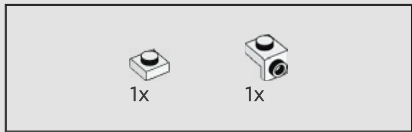
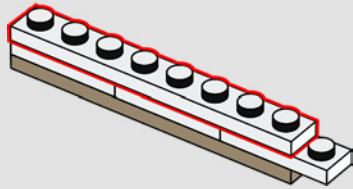

327

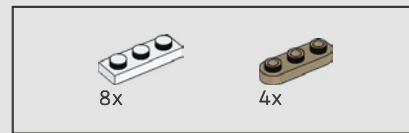
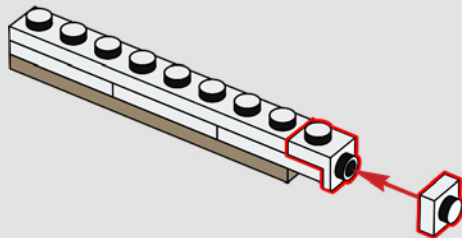

328

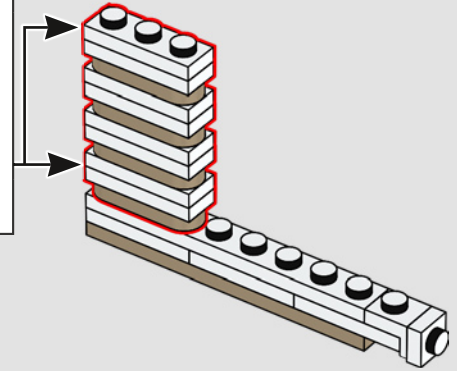
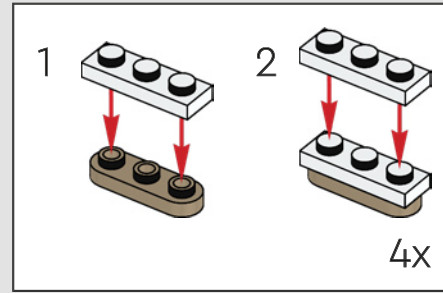

329

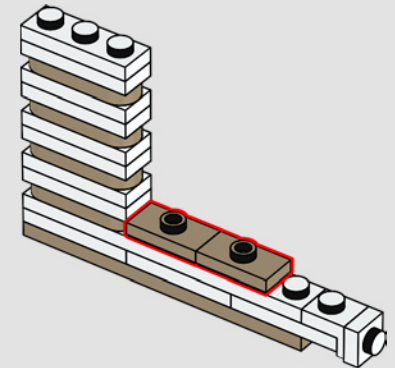

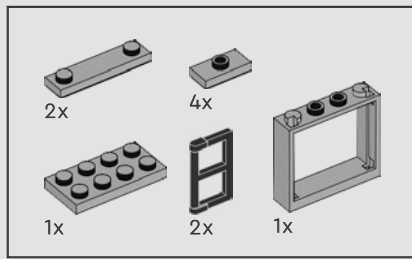

330

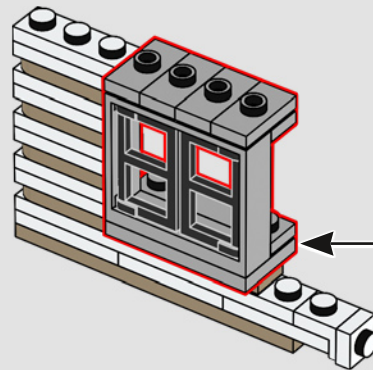
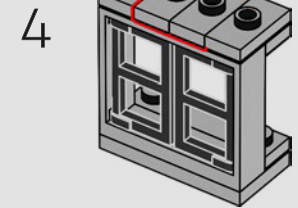
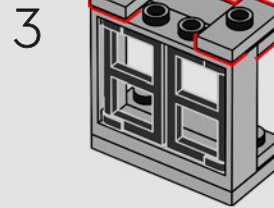
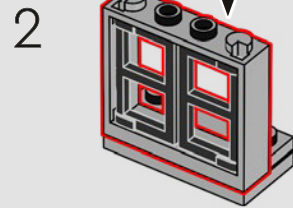
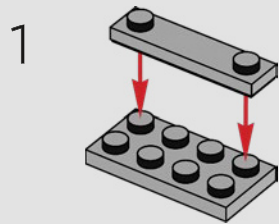

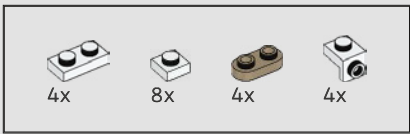

331

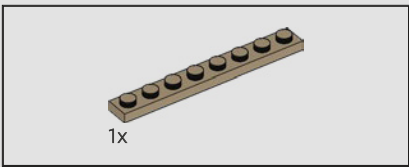
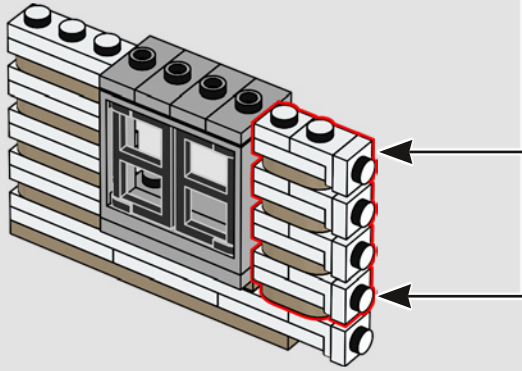
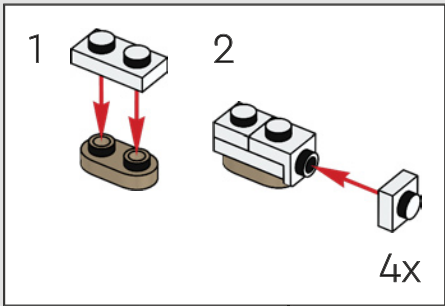

332

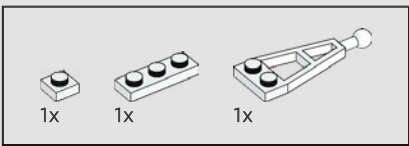
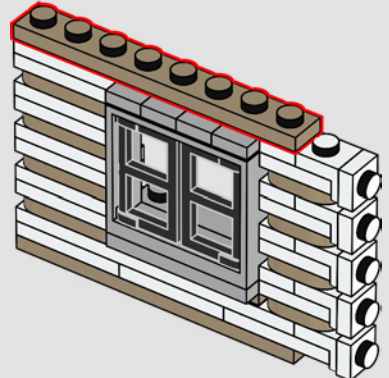

333

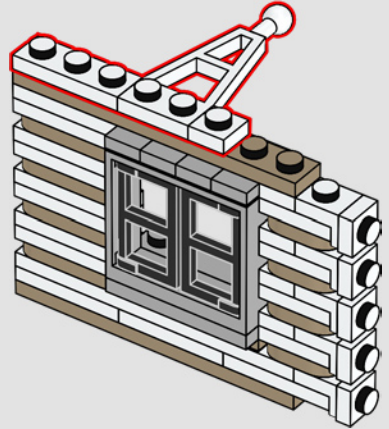

334

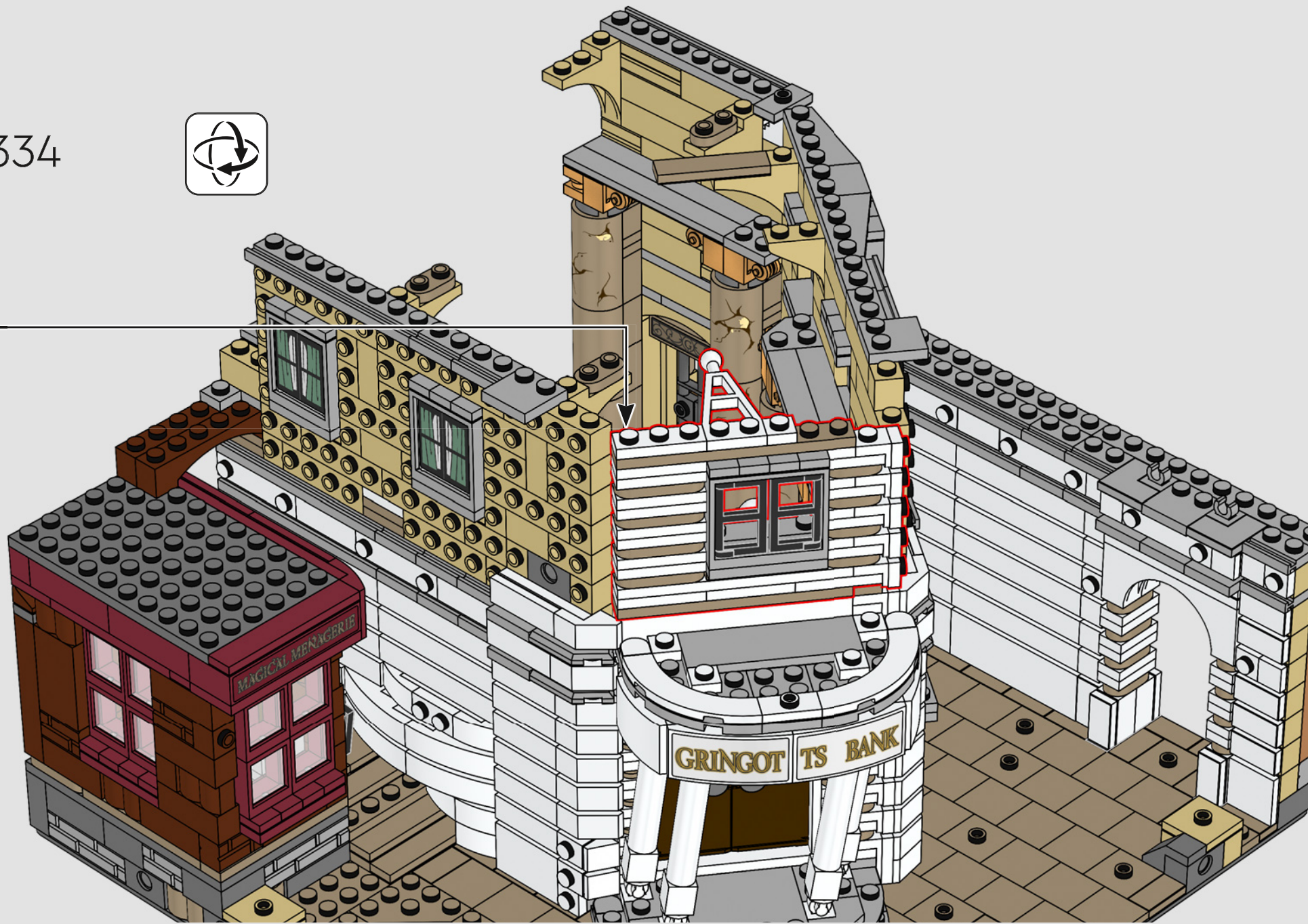

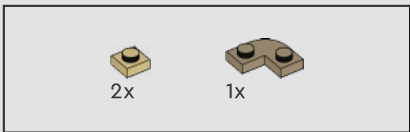

335

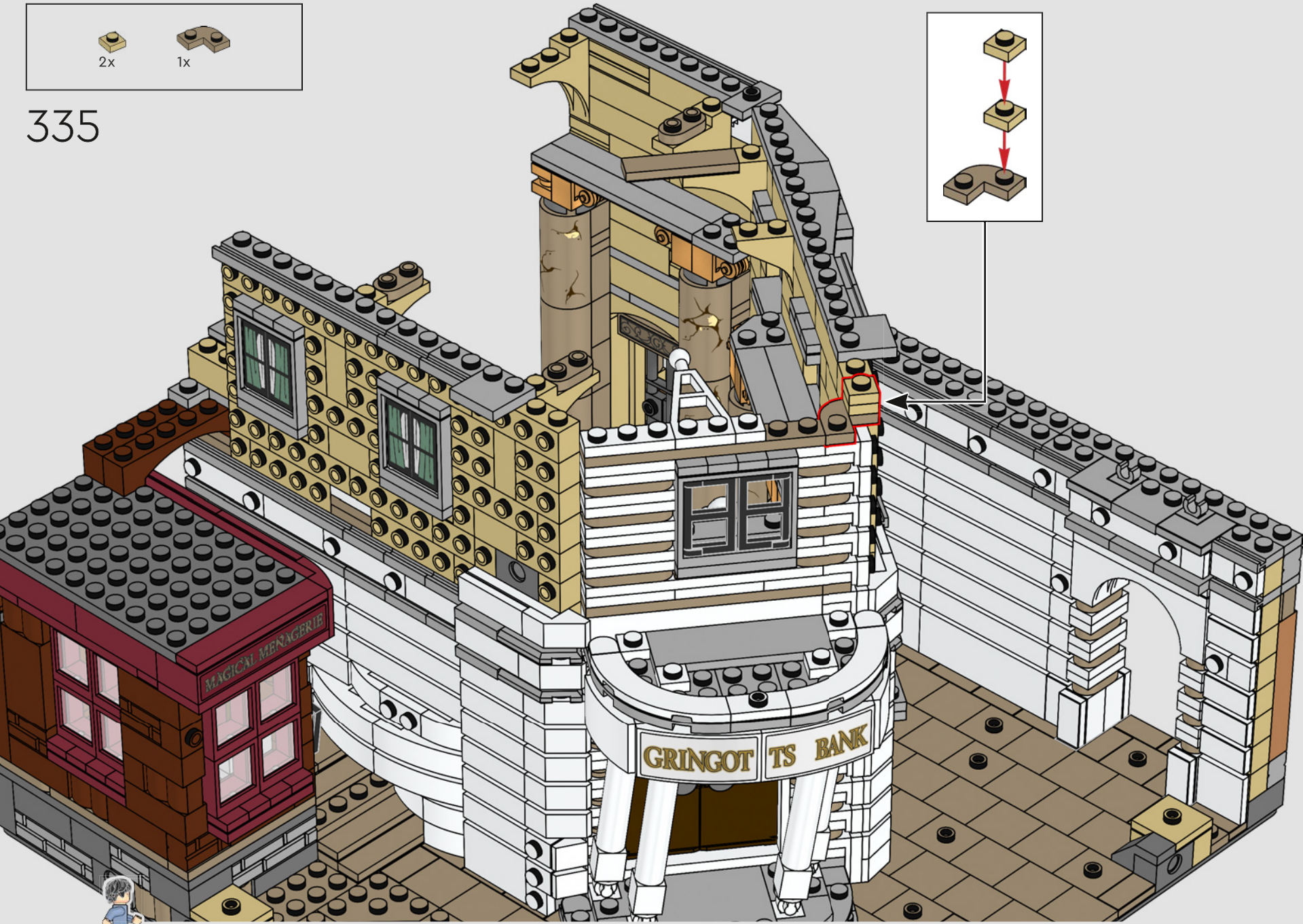
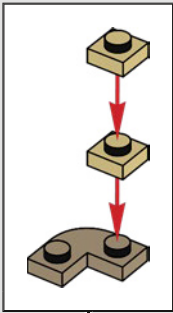



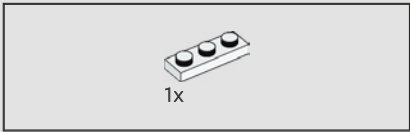

336



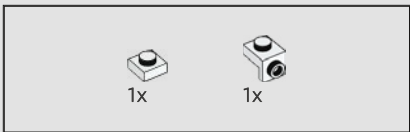

337

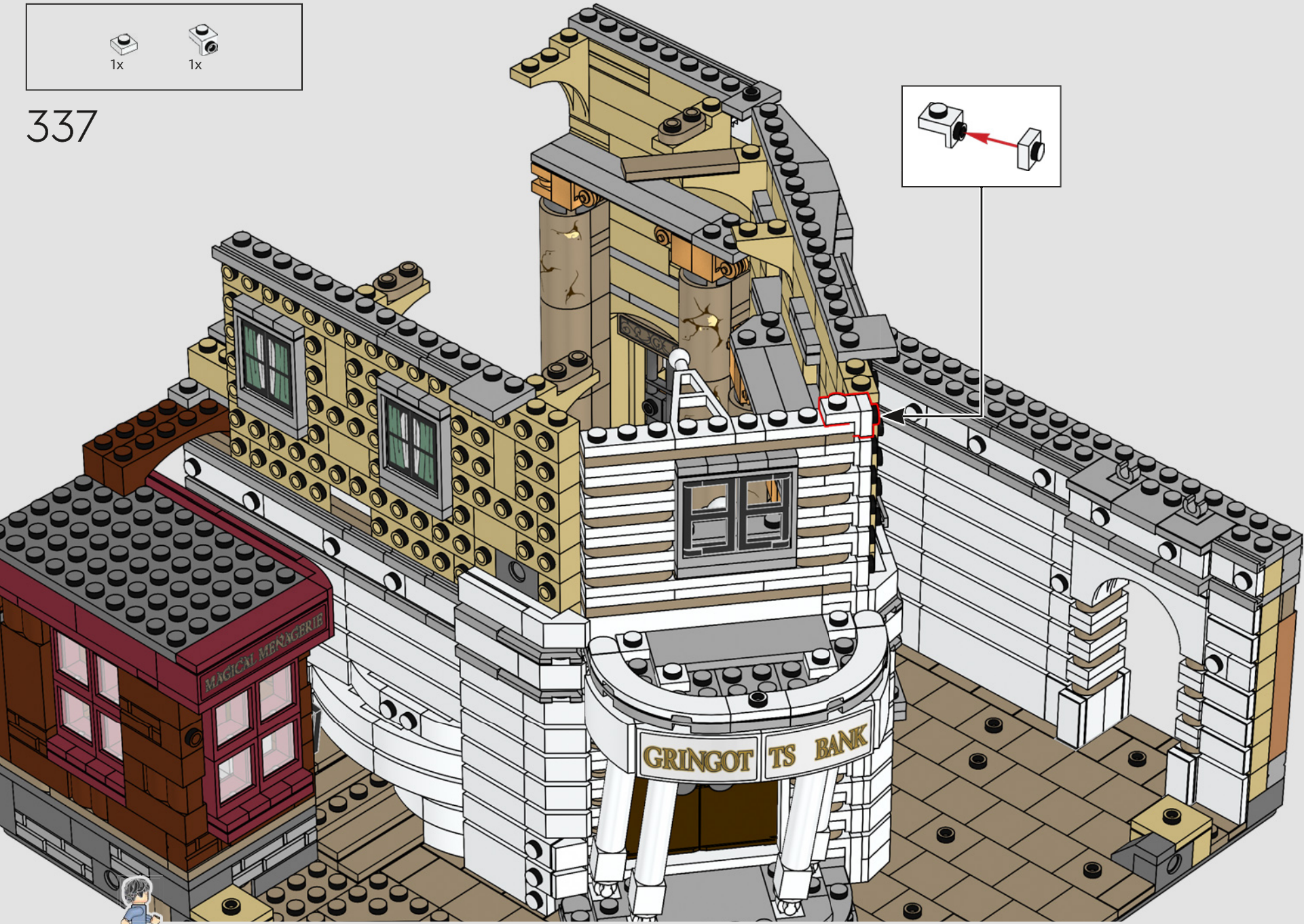
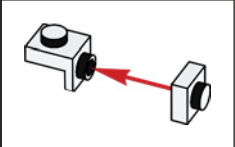

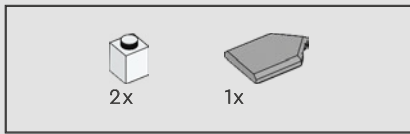

338



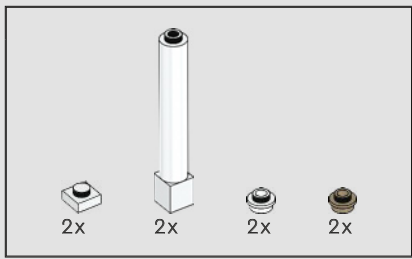

339

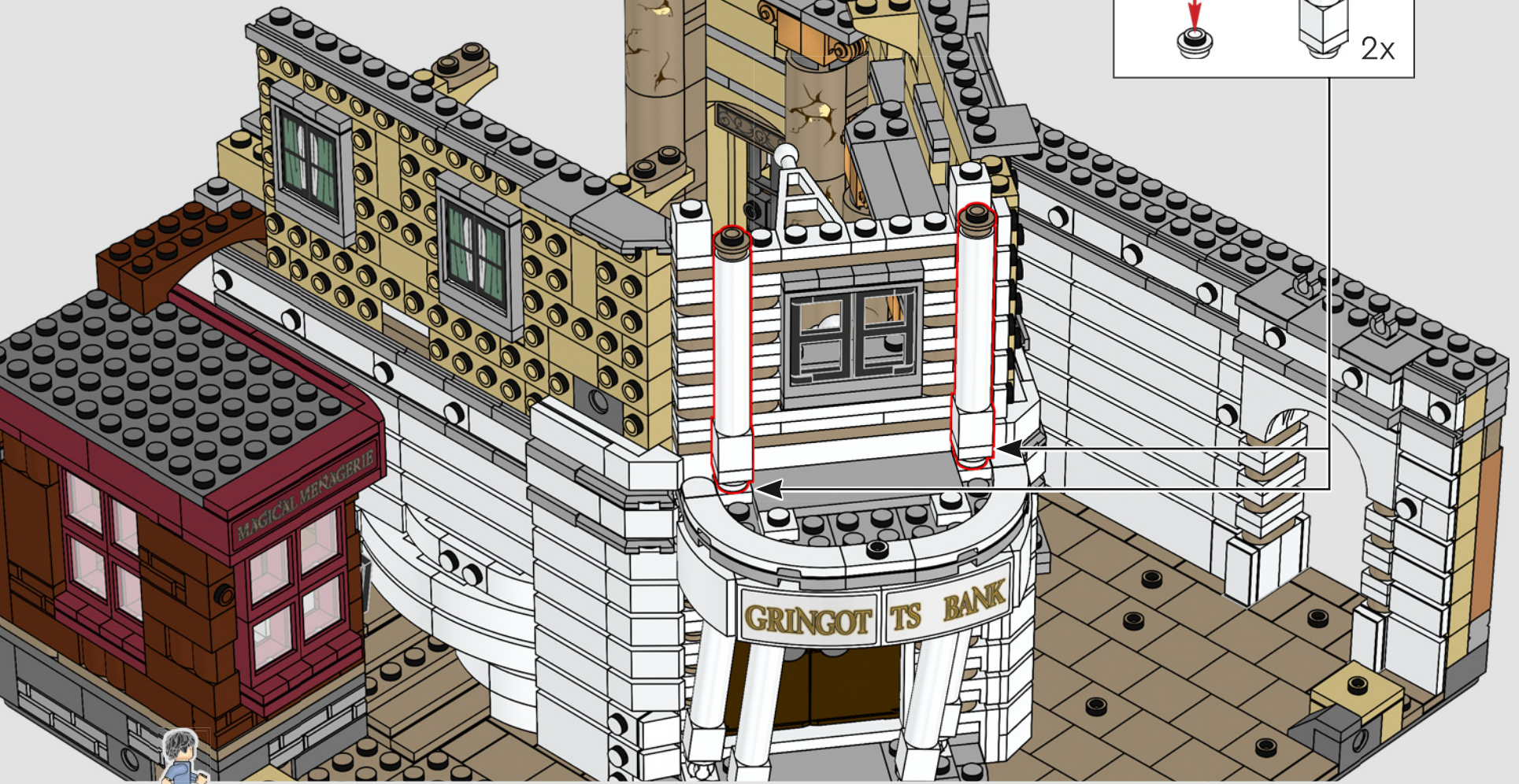
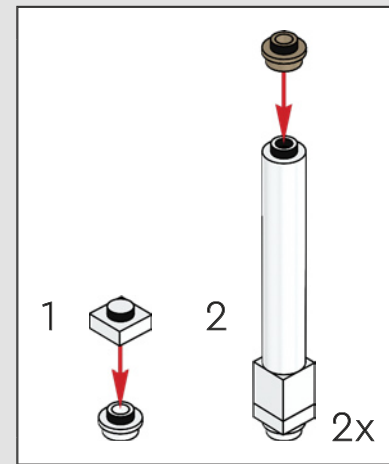

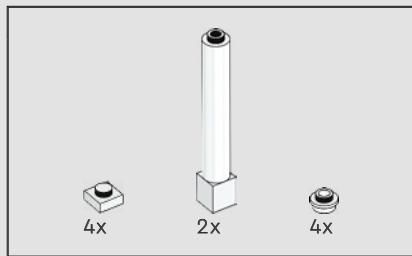

340

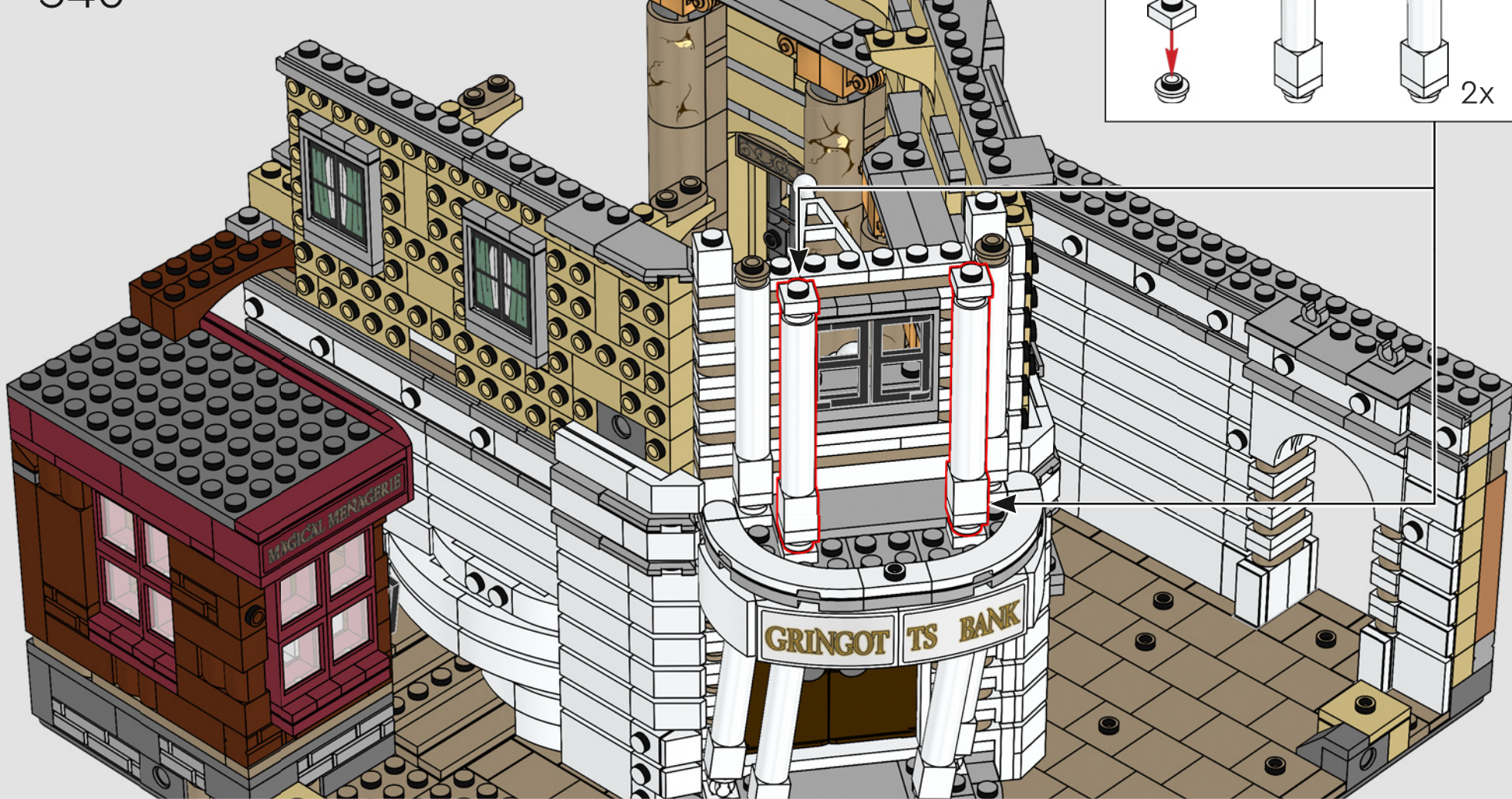
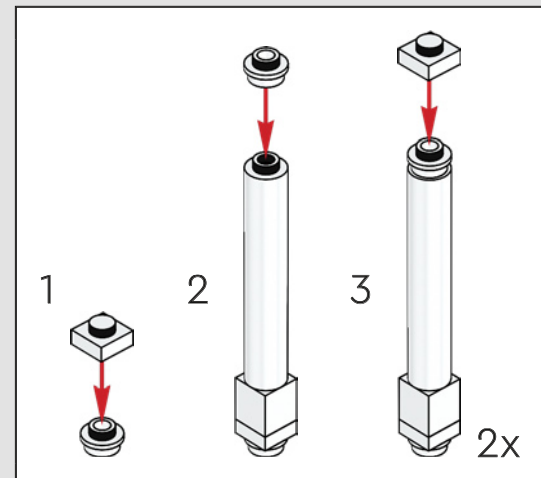

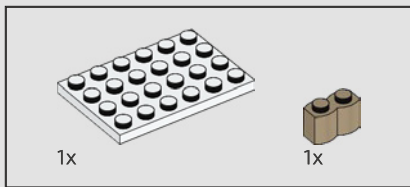

341

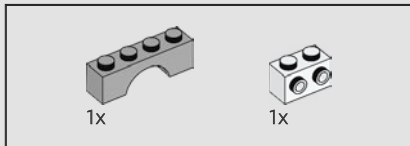
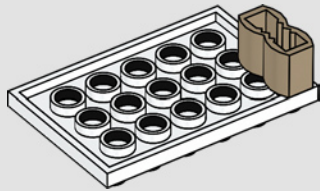

342

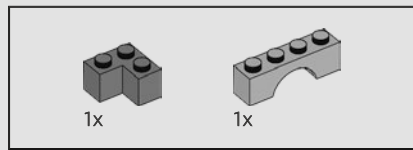
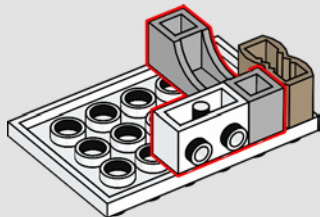

343

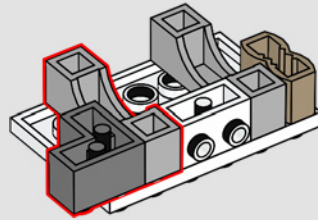

344

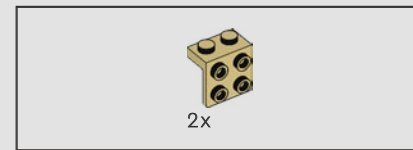
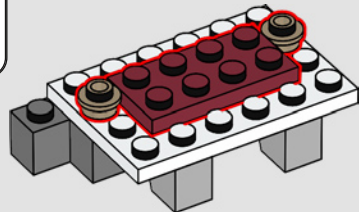

345

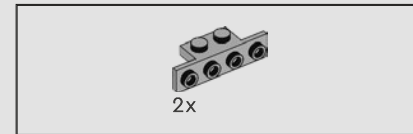
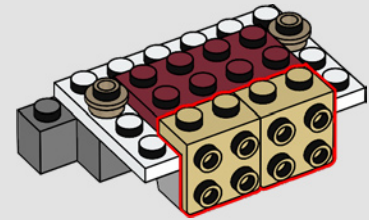

346

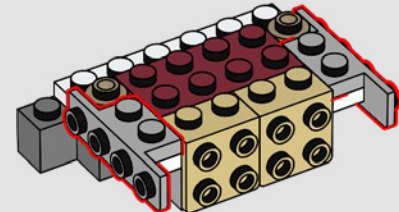

347

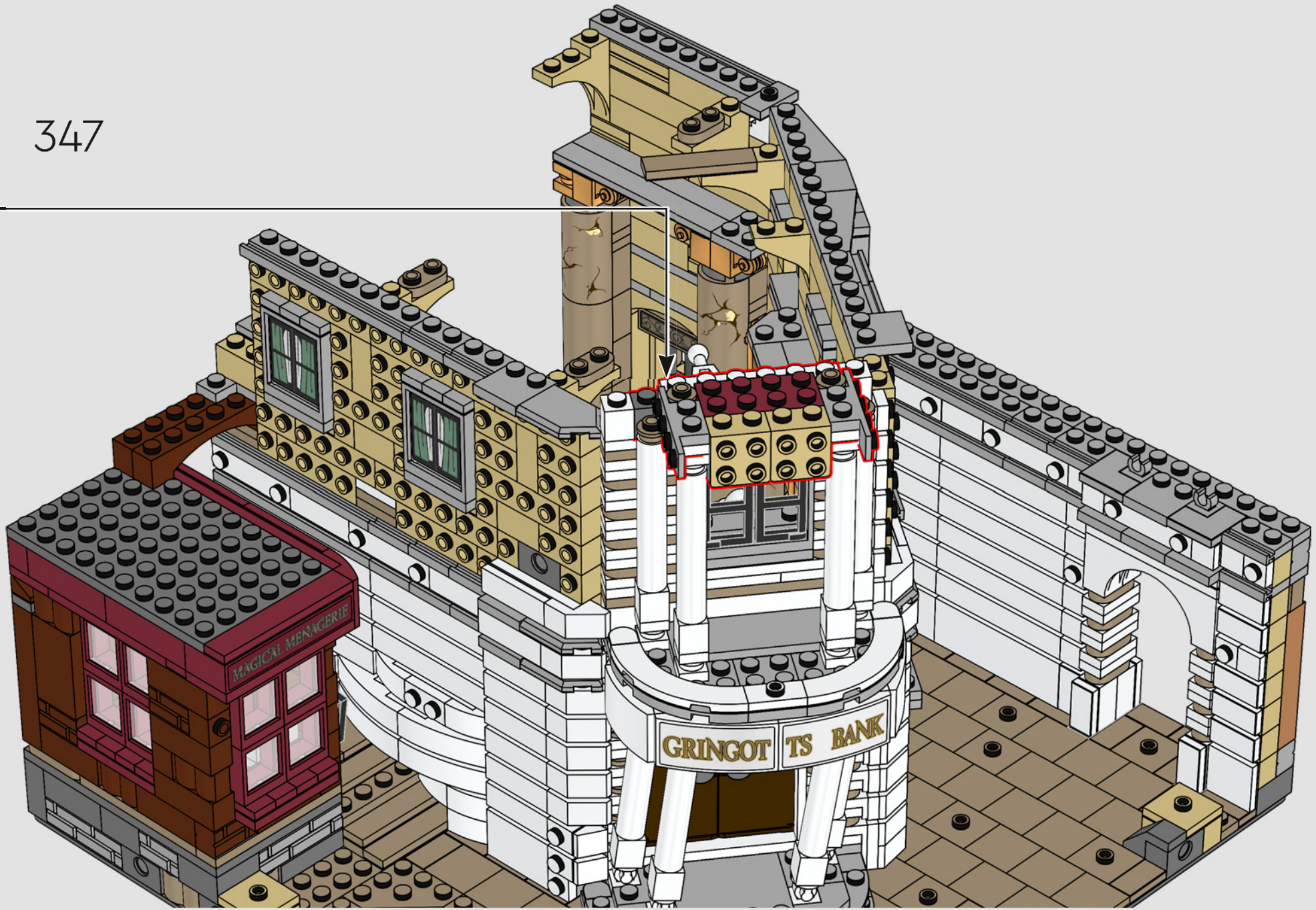

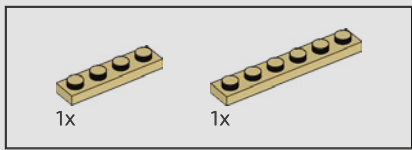

348

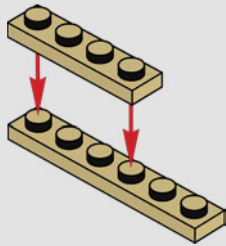

349

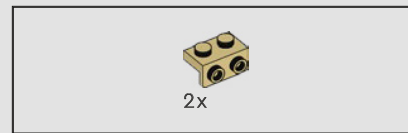
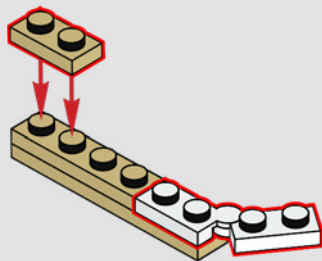

350

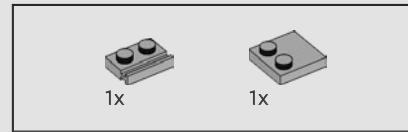
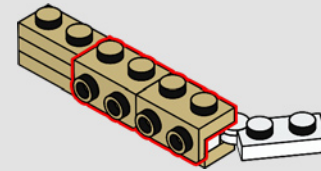

351

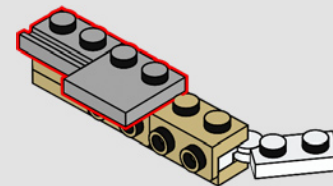



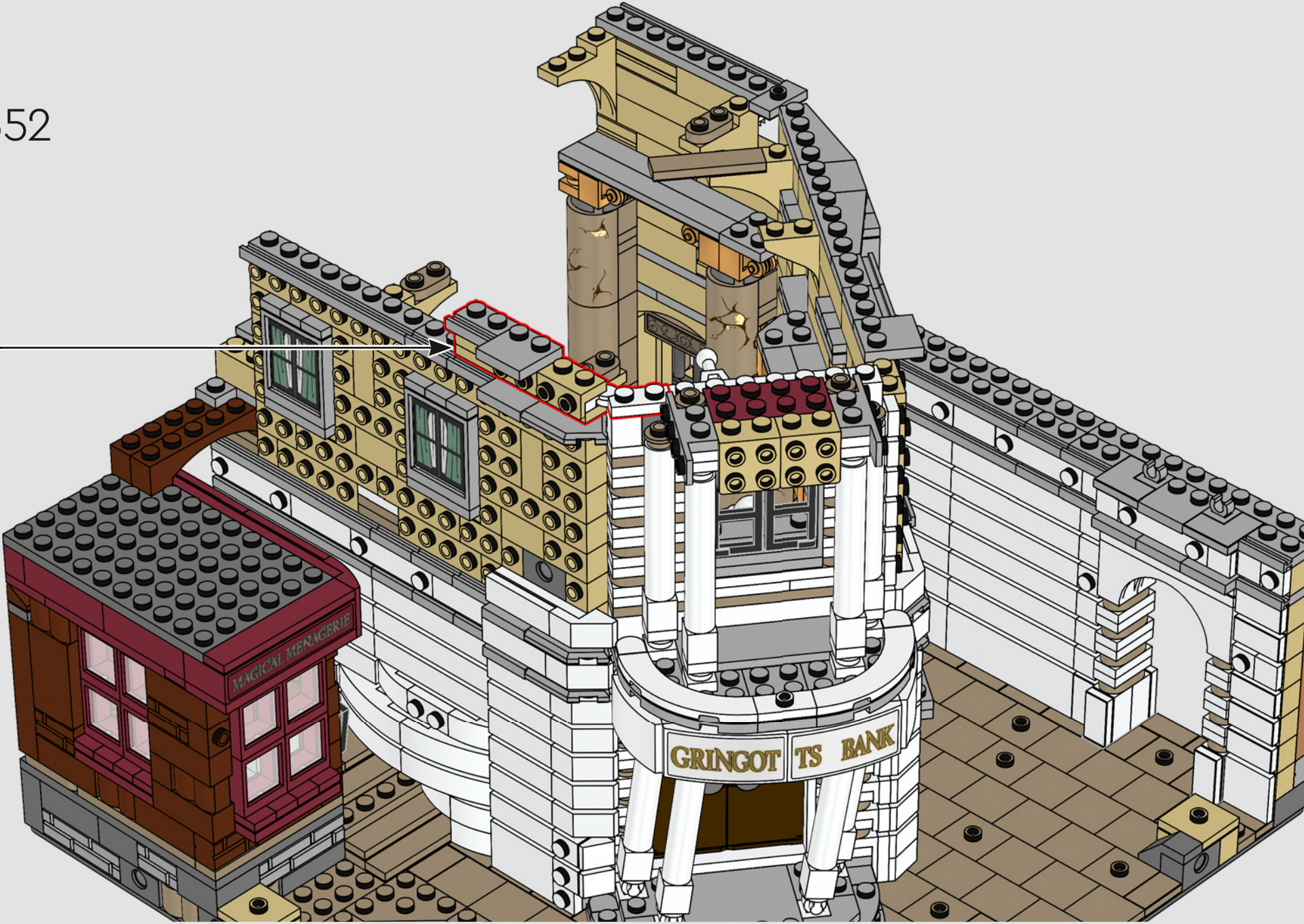

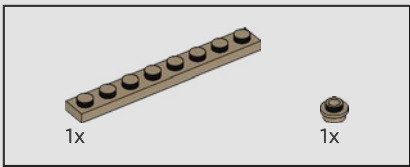

353

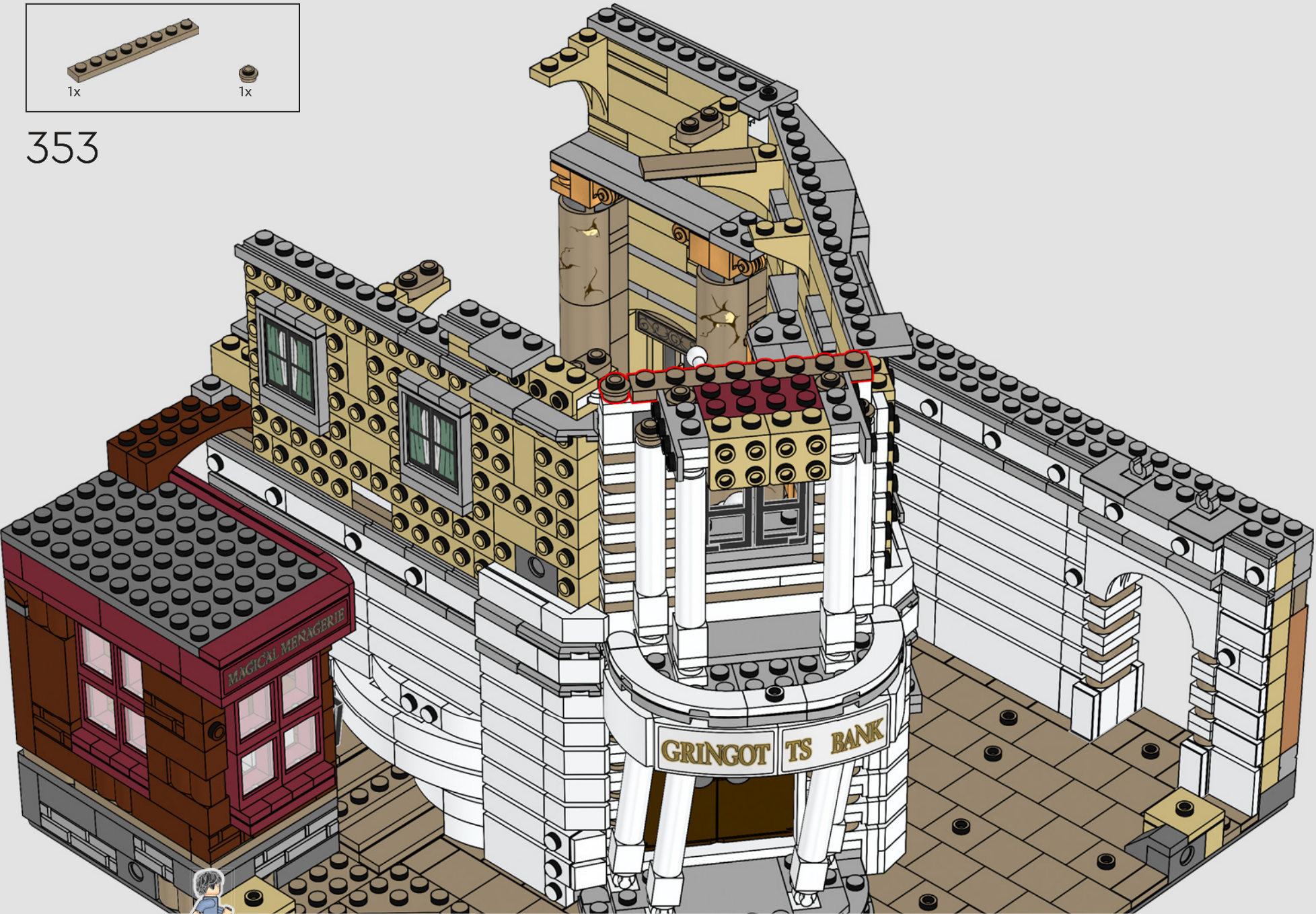

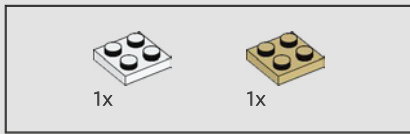

354

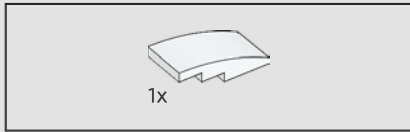
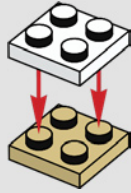

355

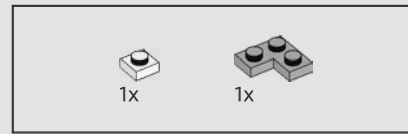
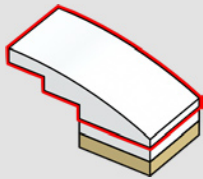

356

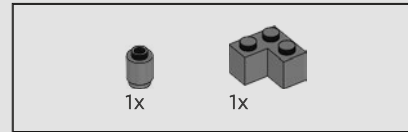
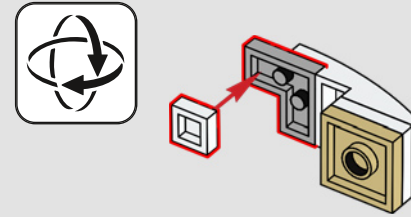

357

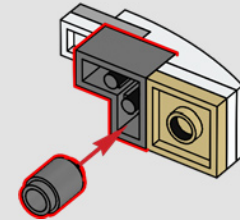

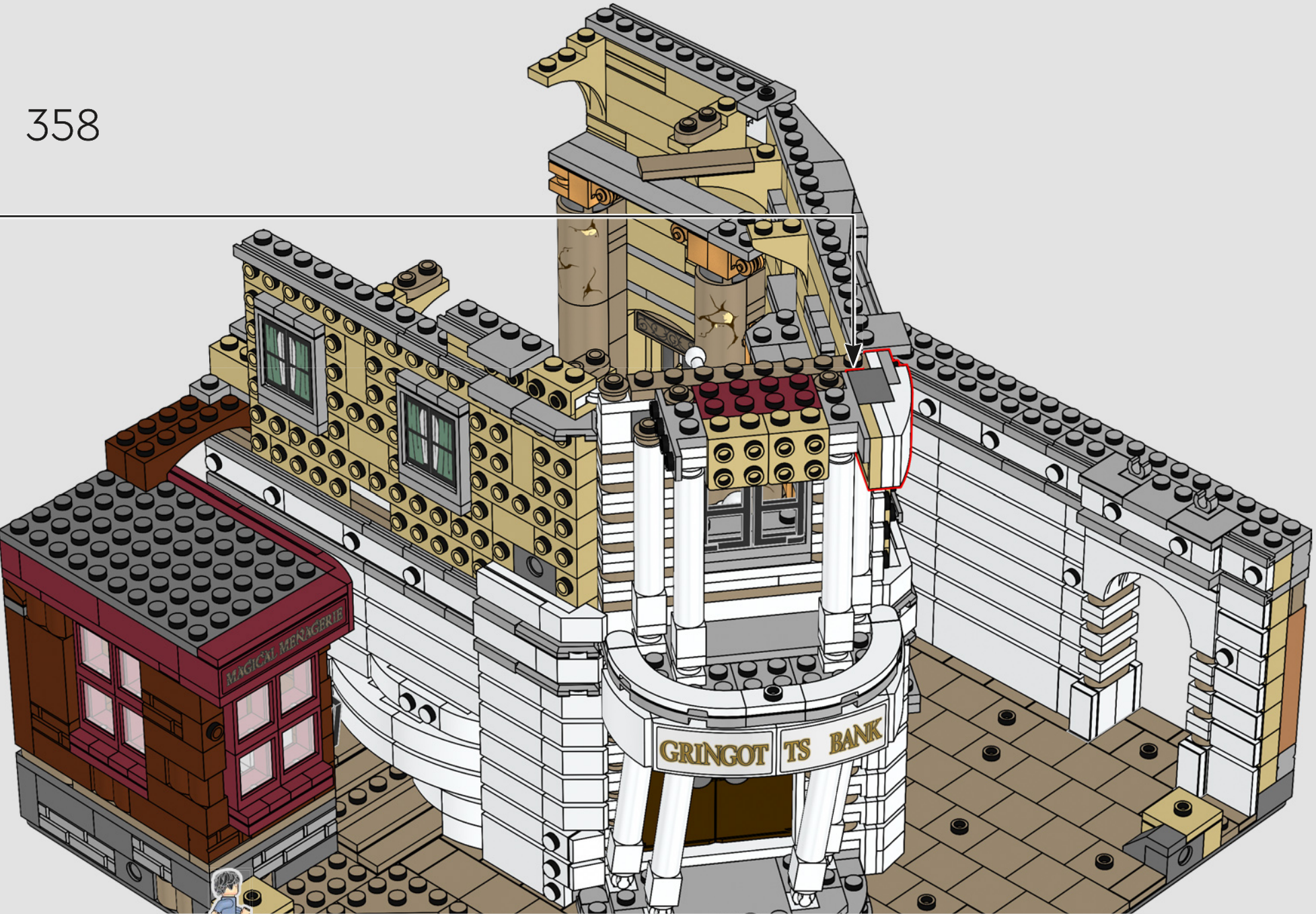

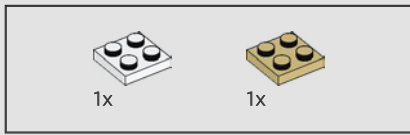

359

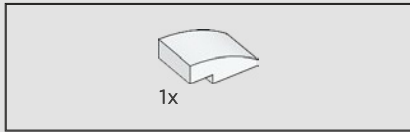
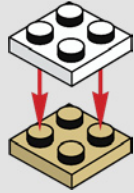

360

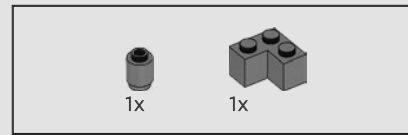
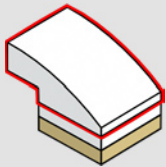

361

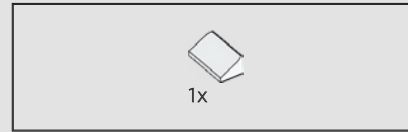
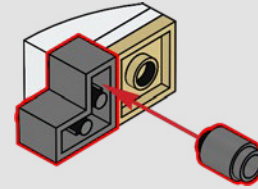
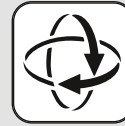

362

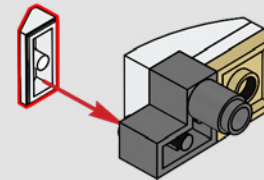

363

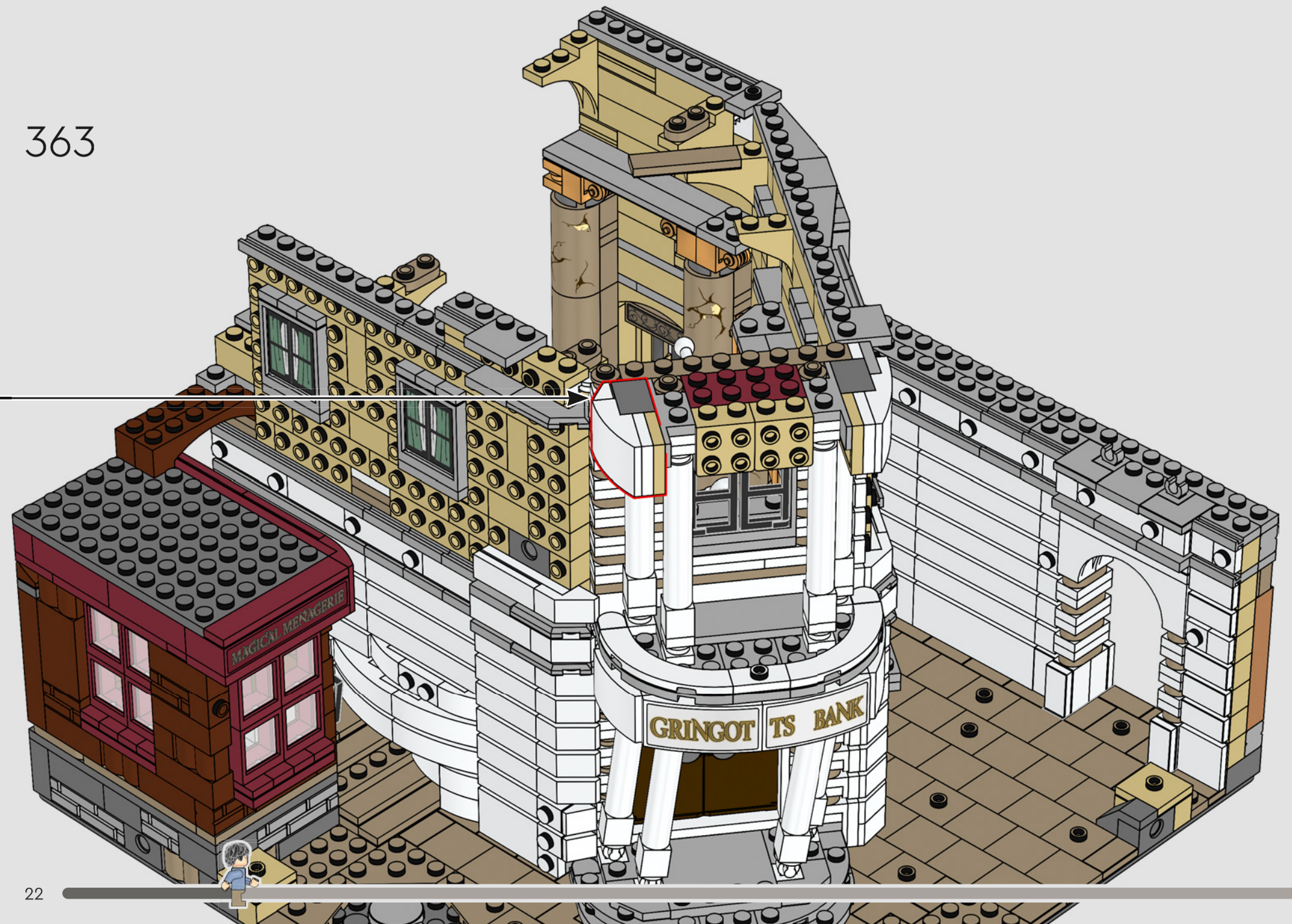

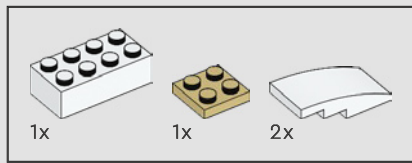

364

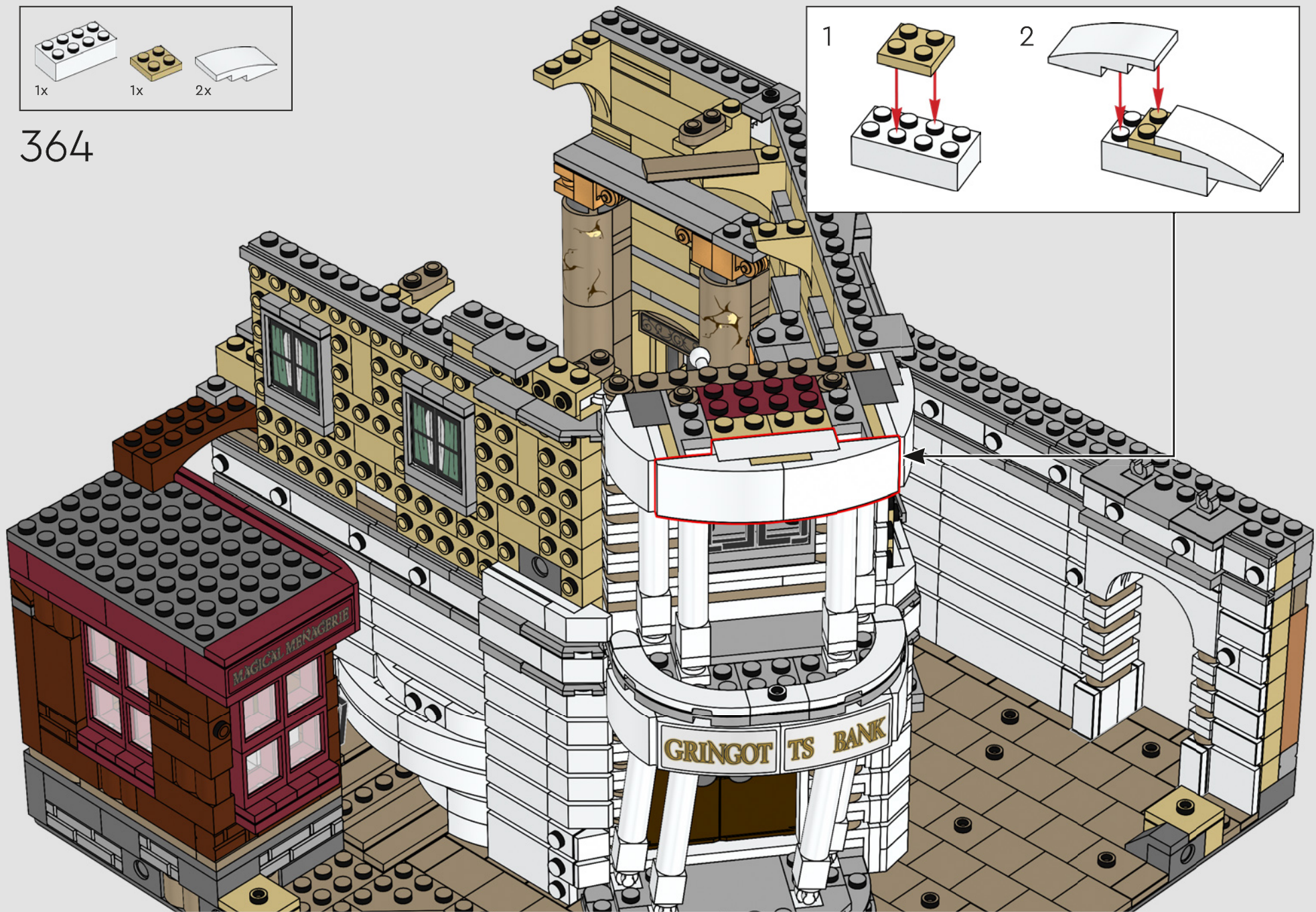
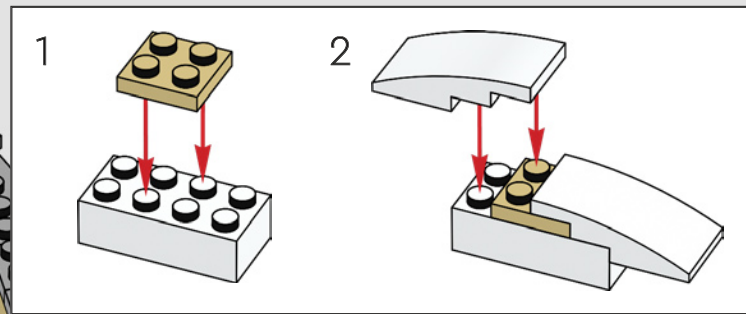

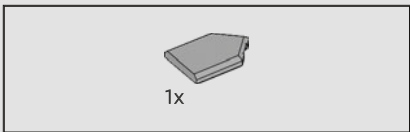

365

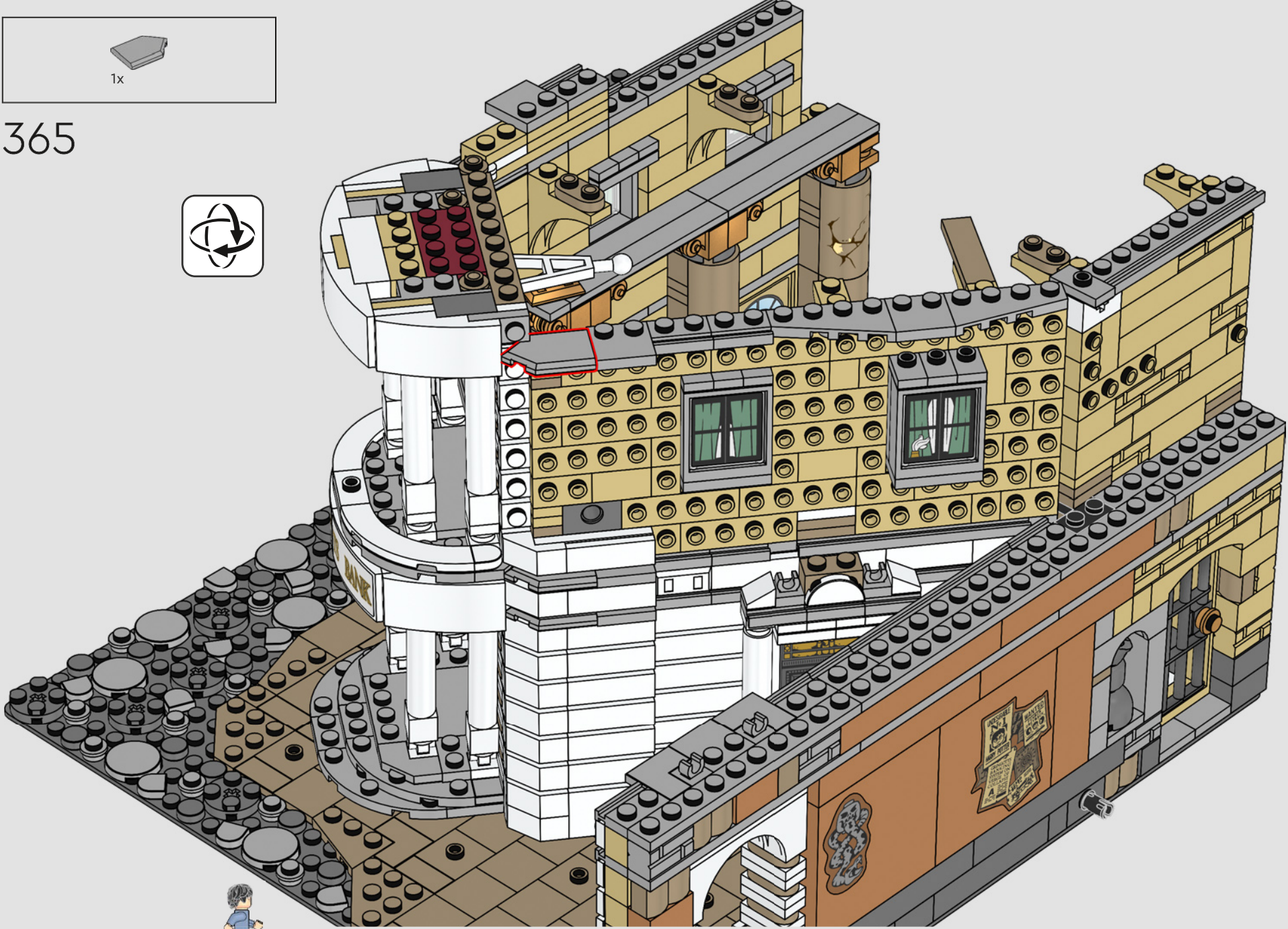



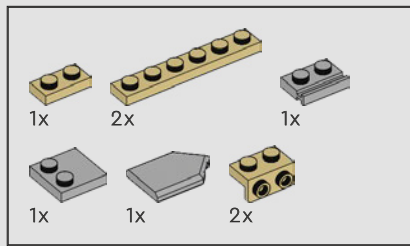

366

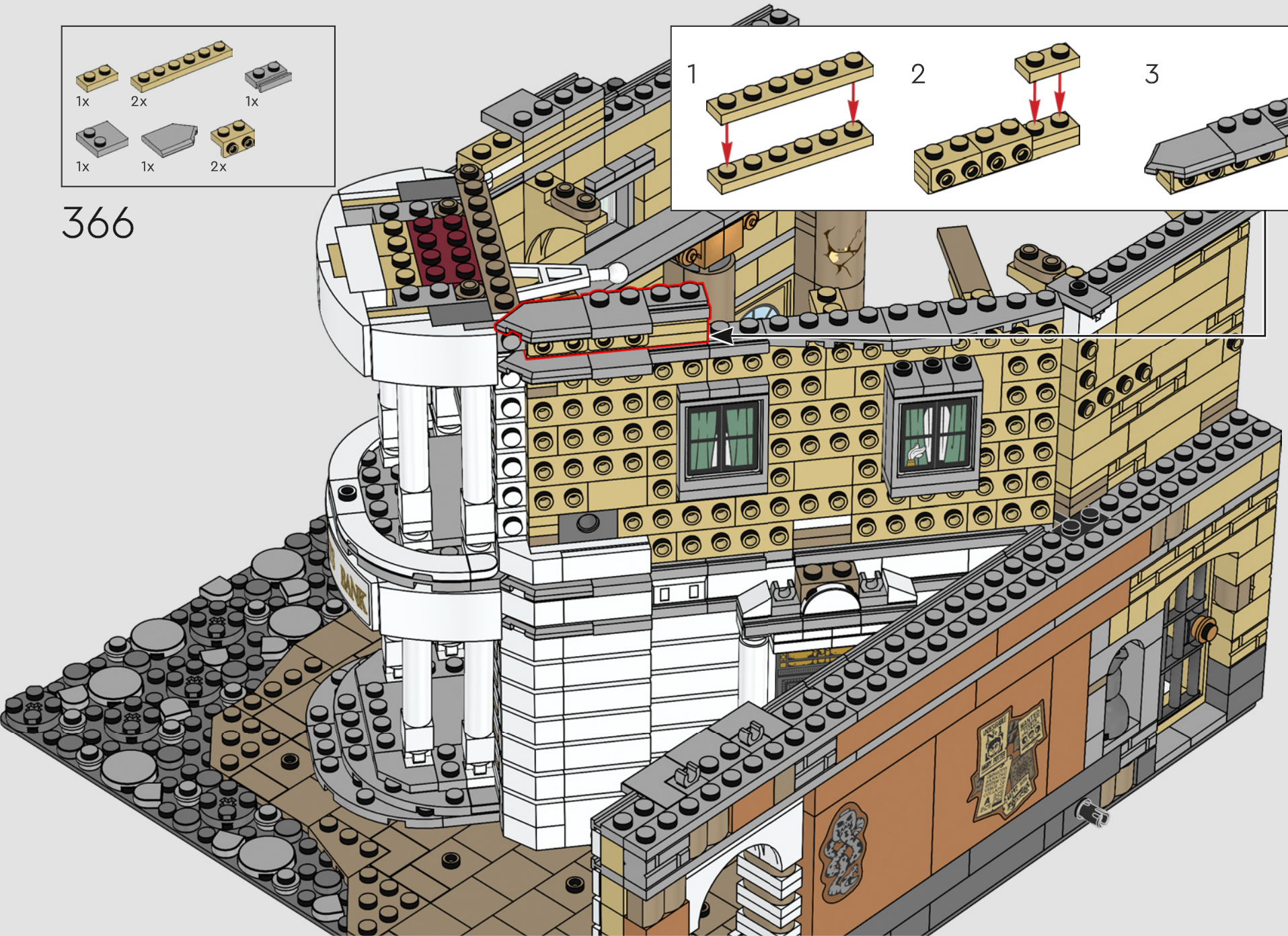
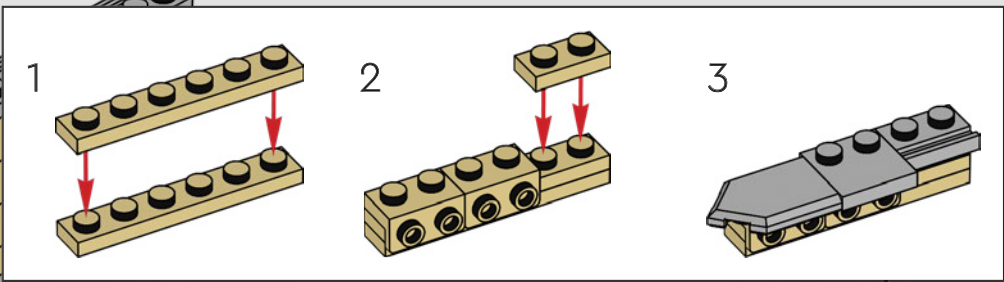

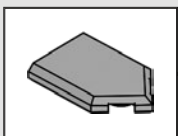
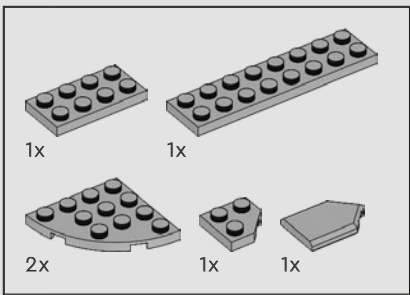

367

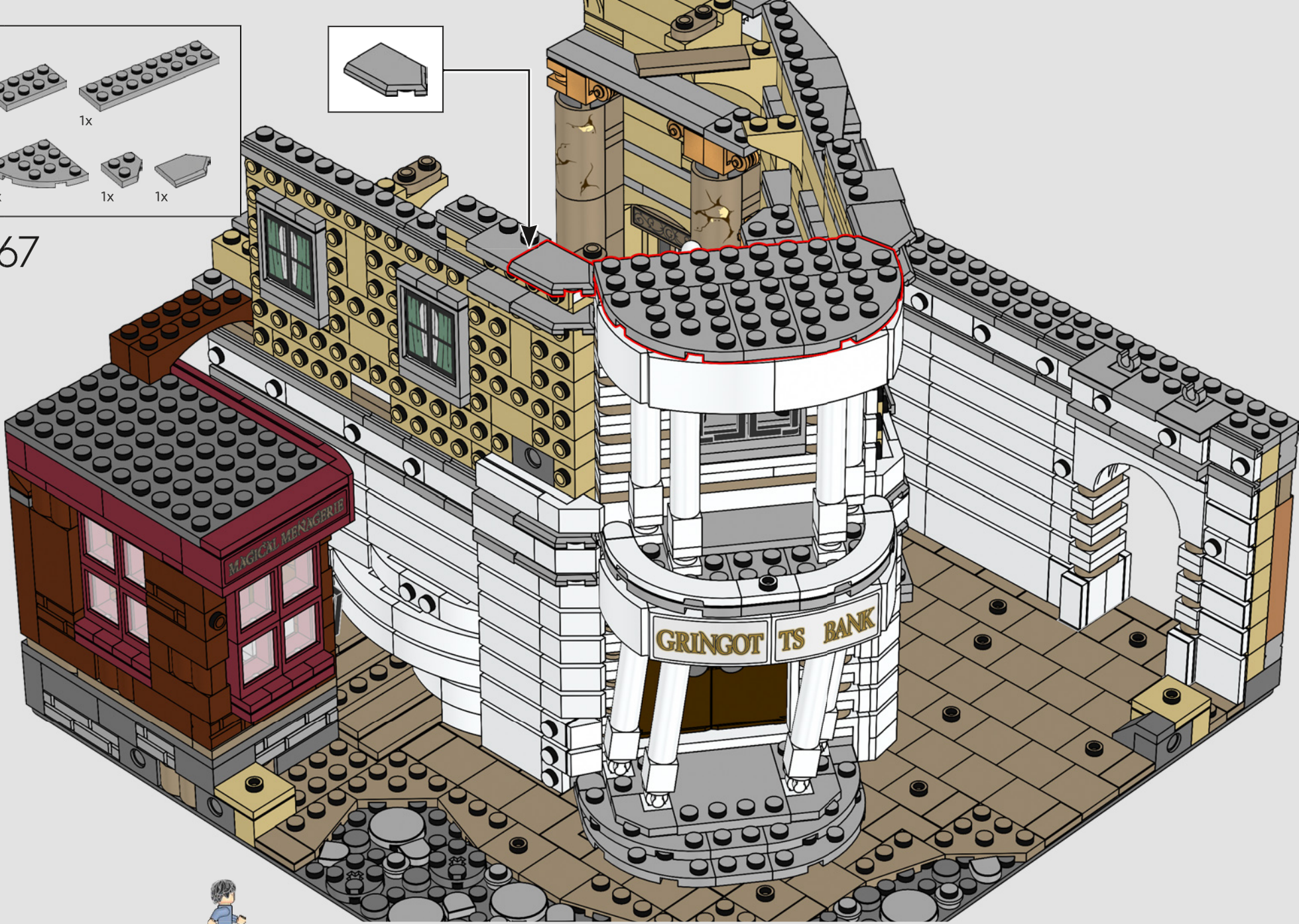

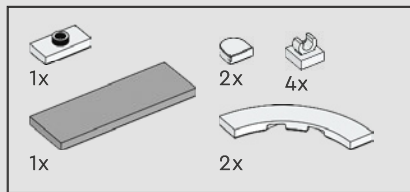

368

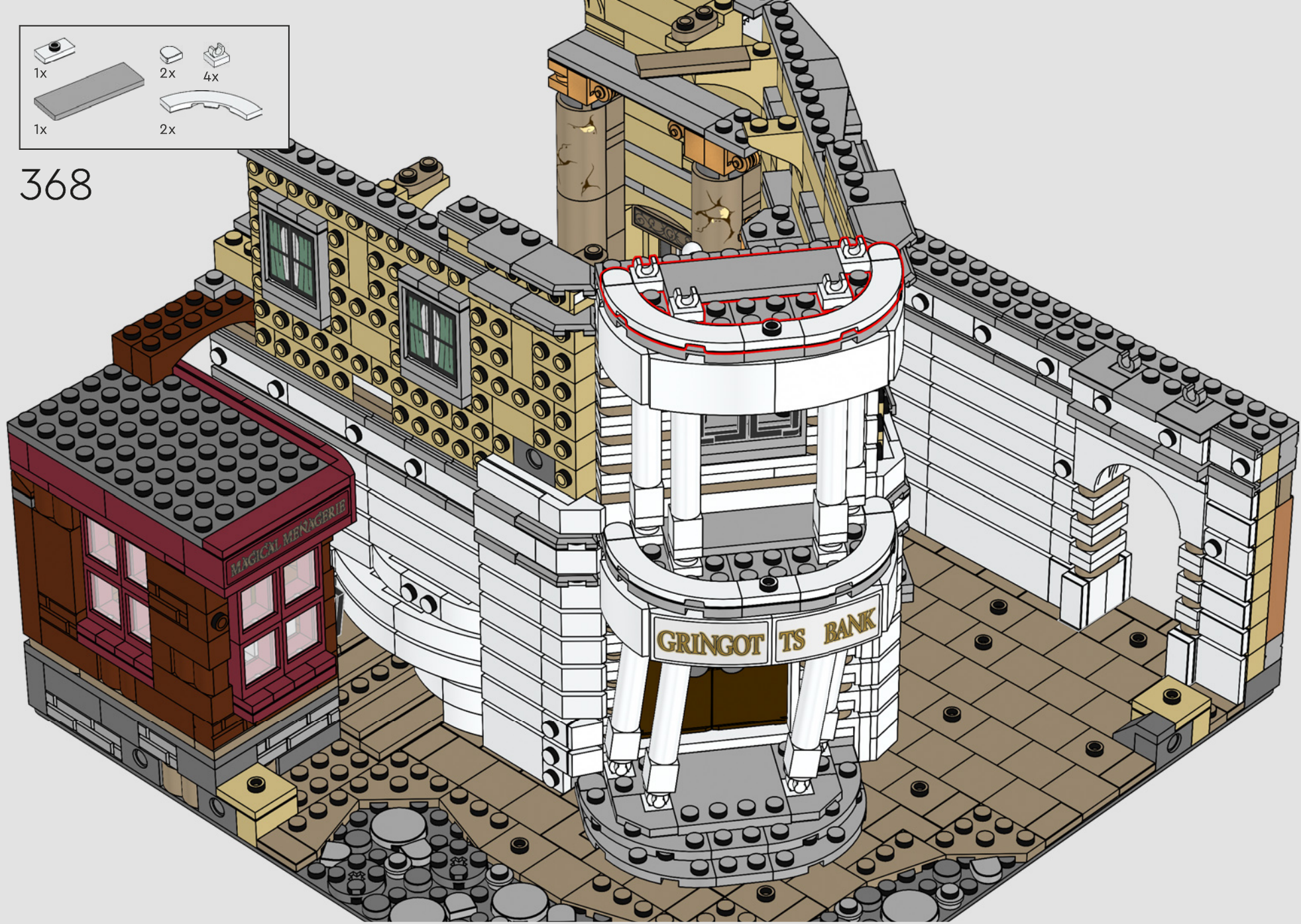

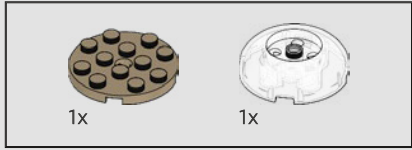

369

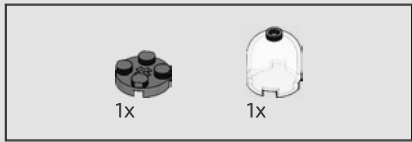
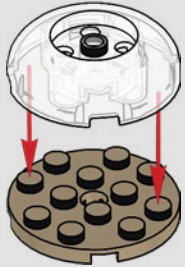

370

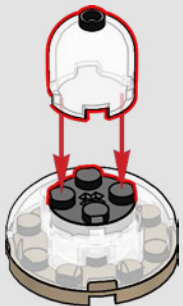

371

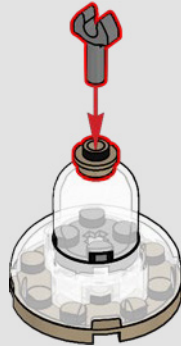

372

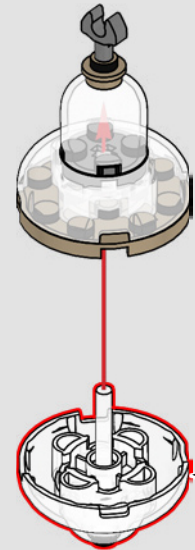
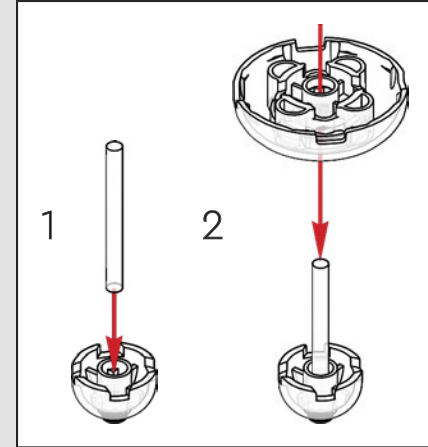

373

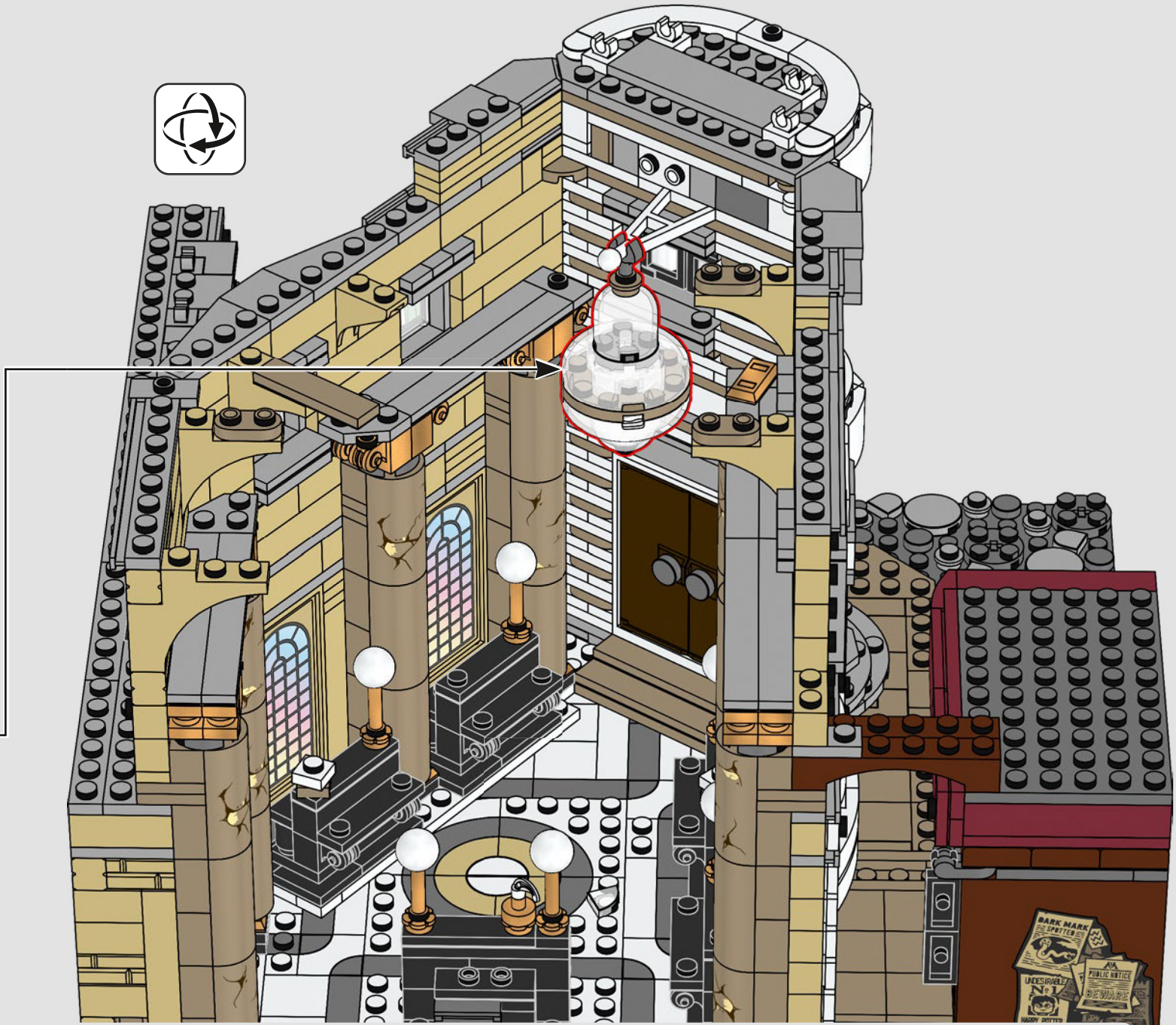

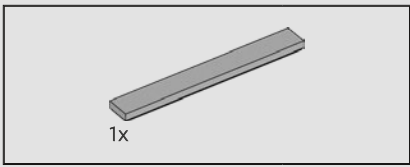

374

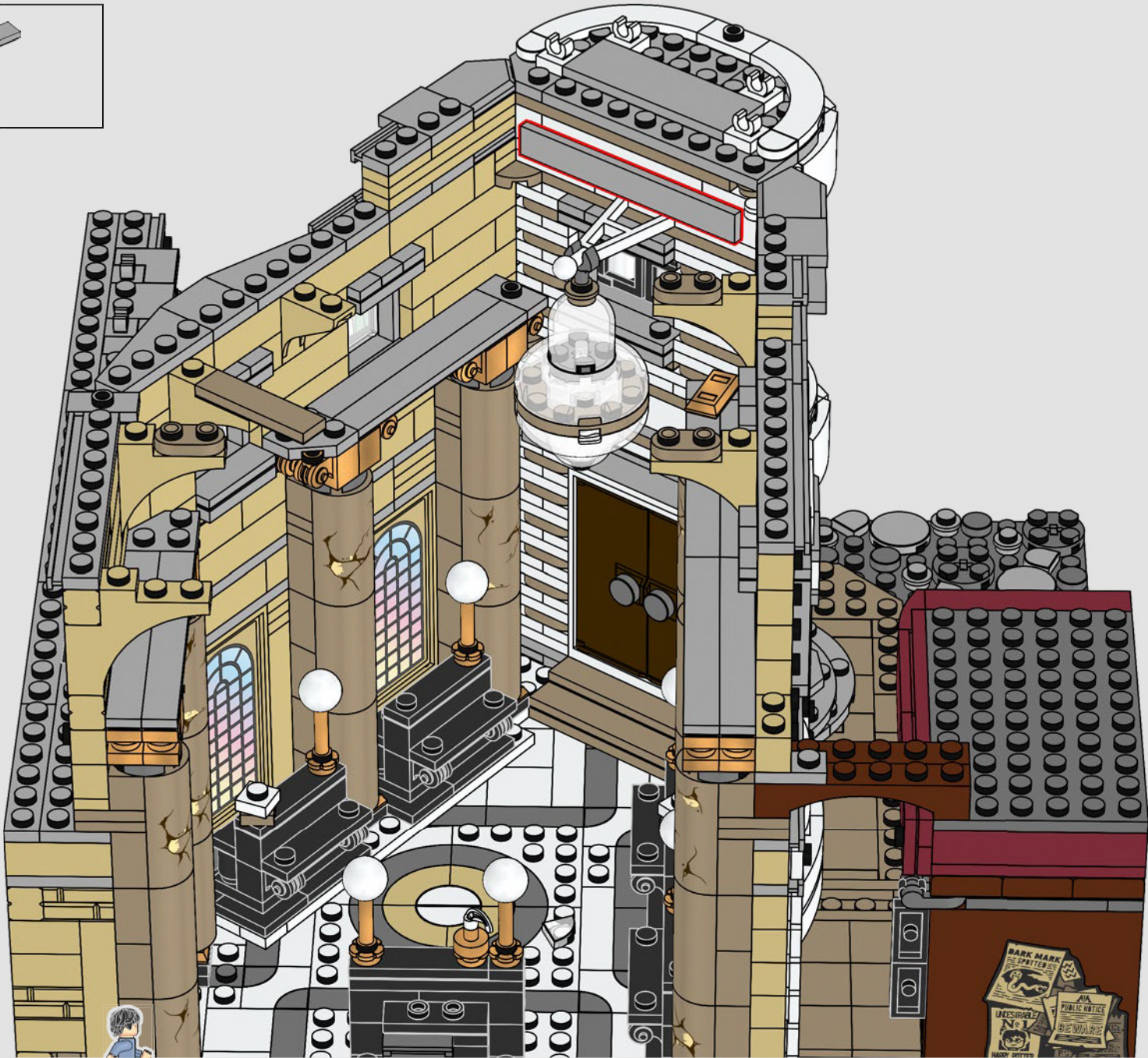

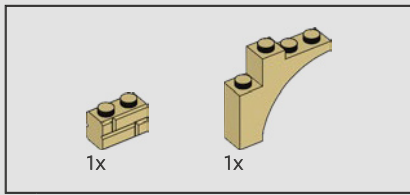

375

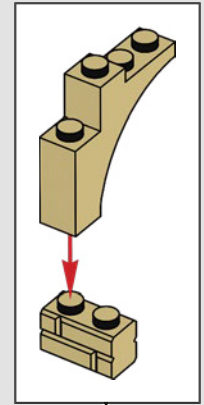
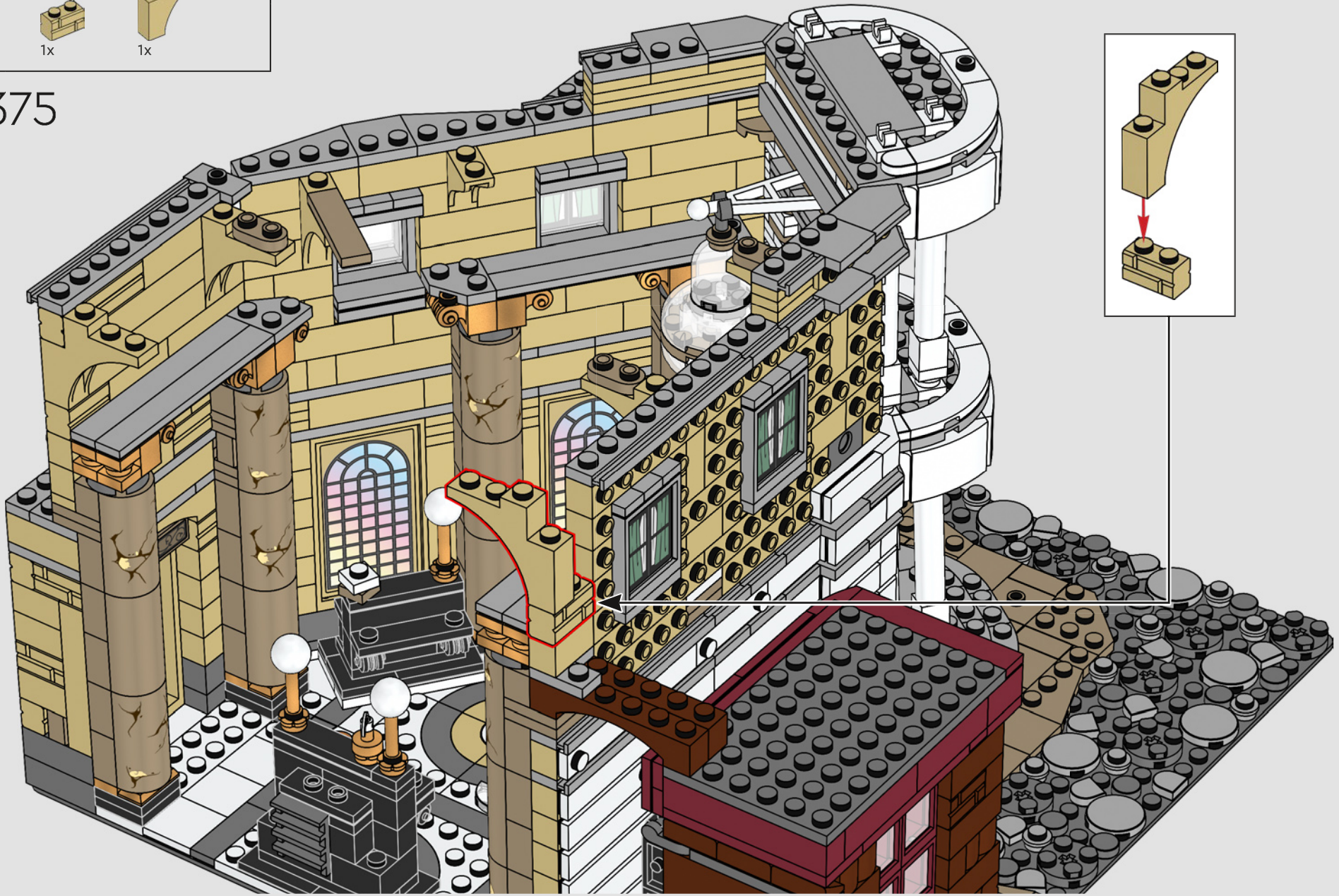

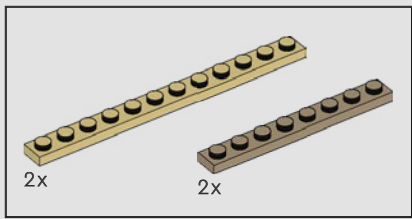

376

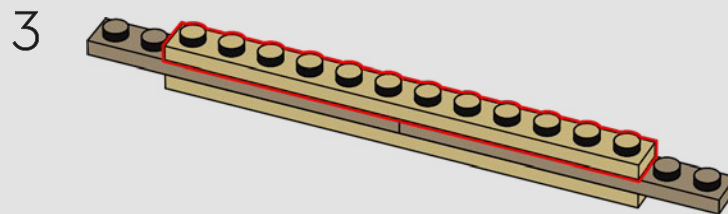
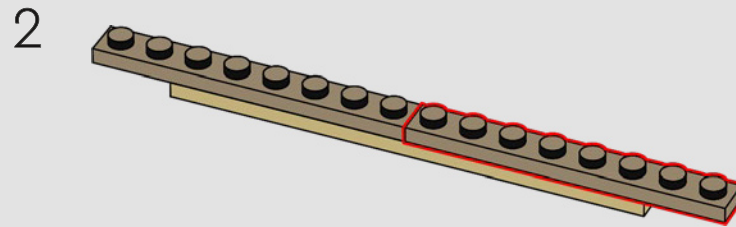
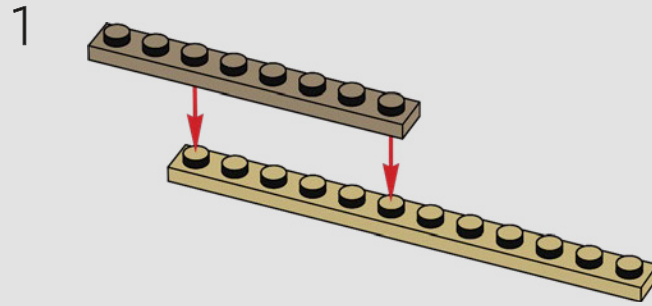



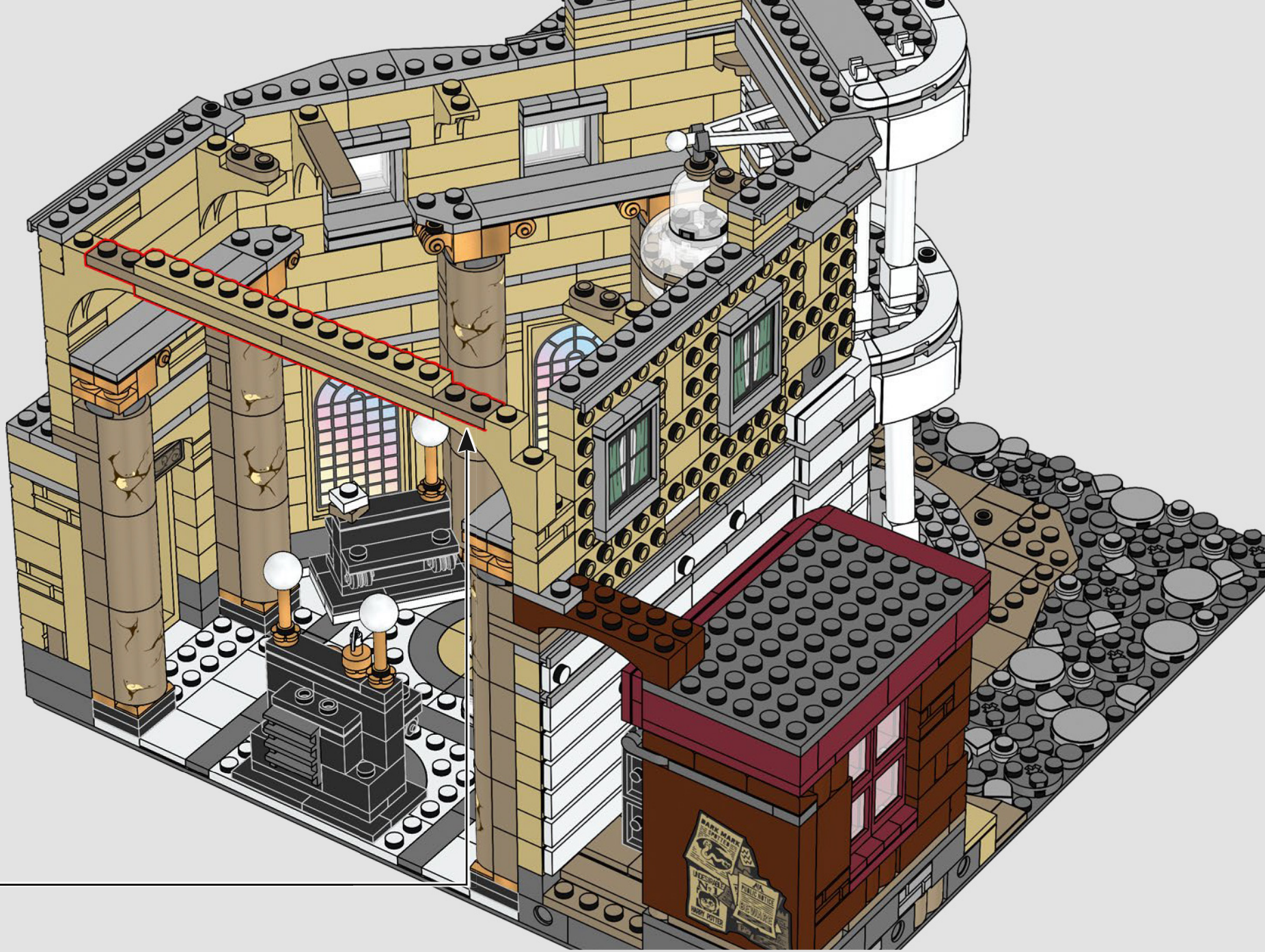

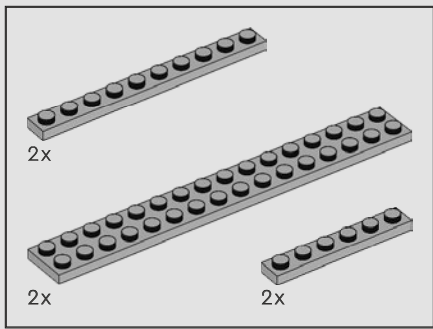

377

1

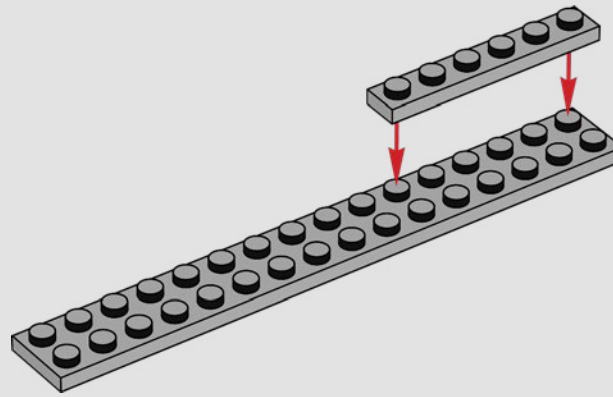

2

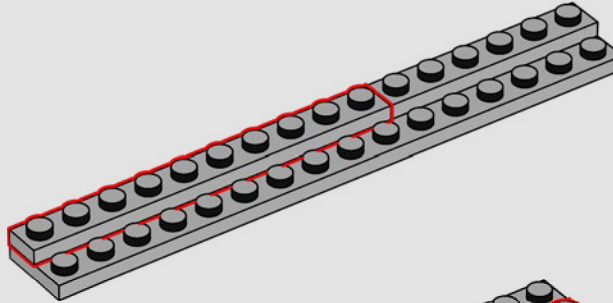

3

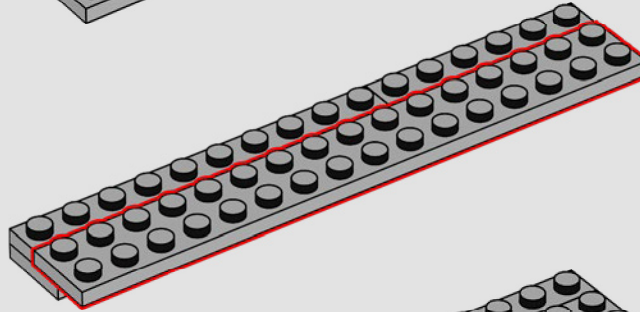

4

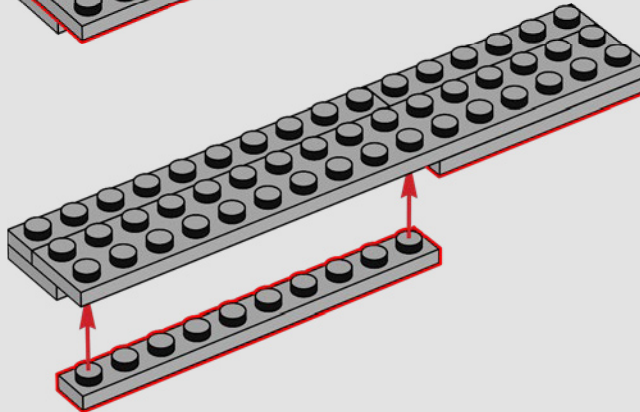

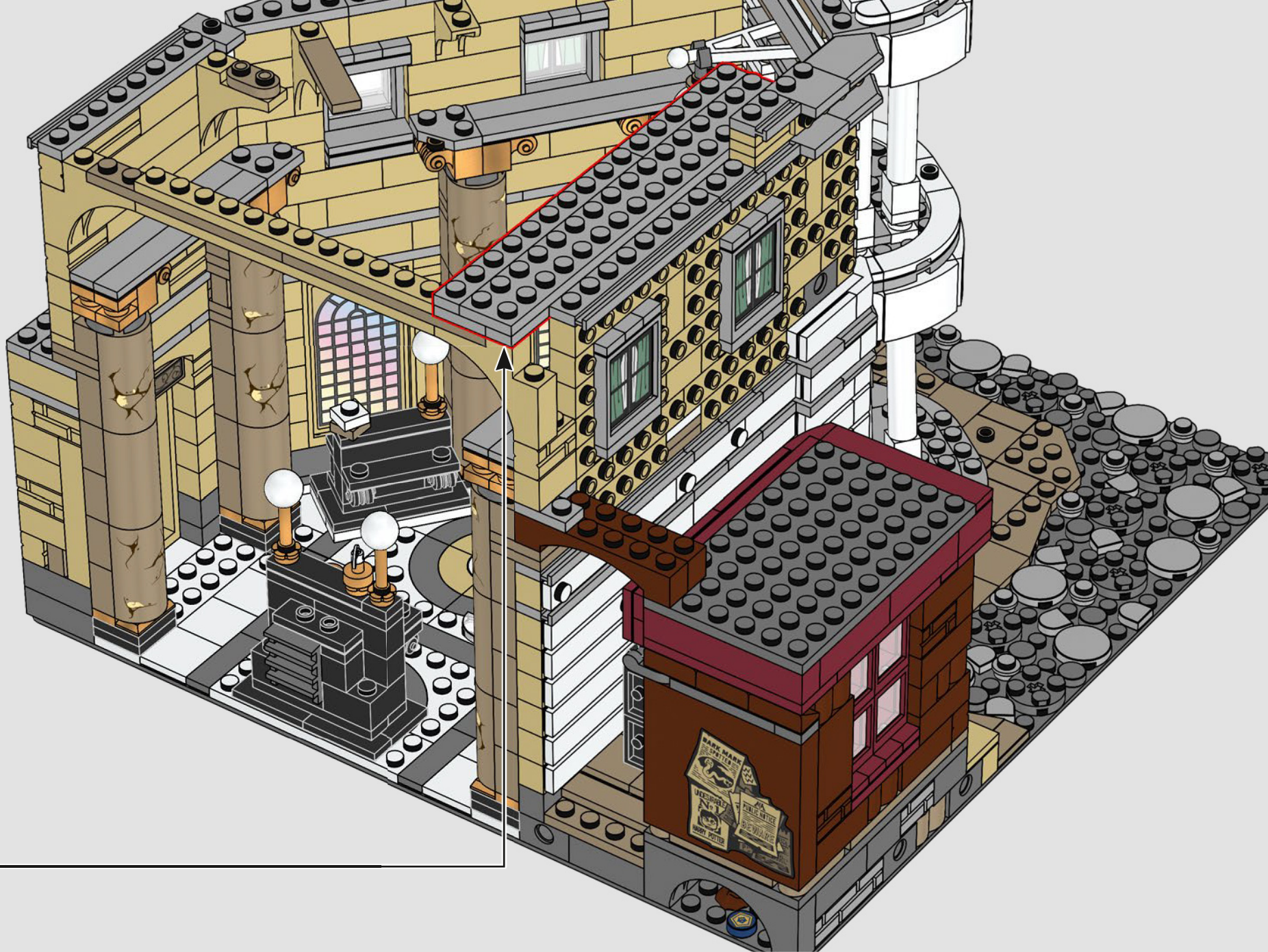

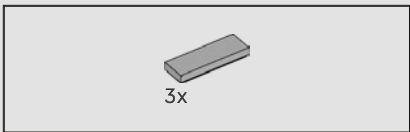

378

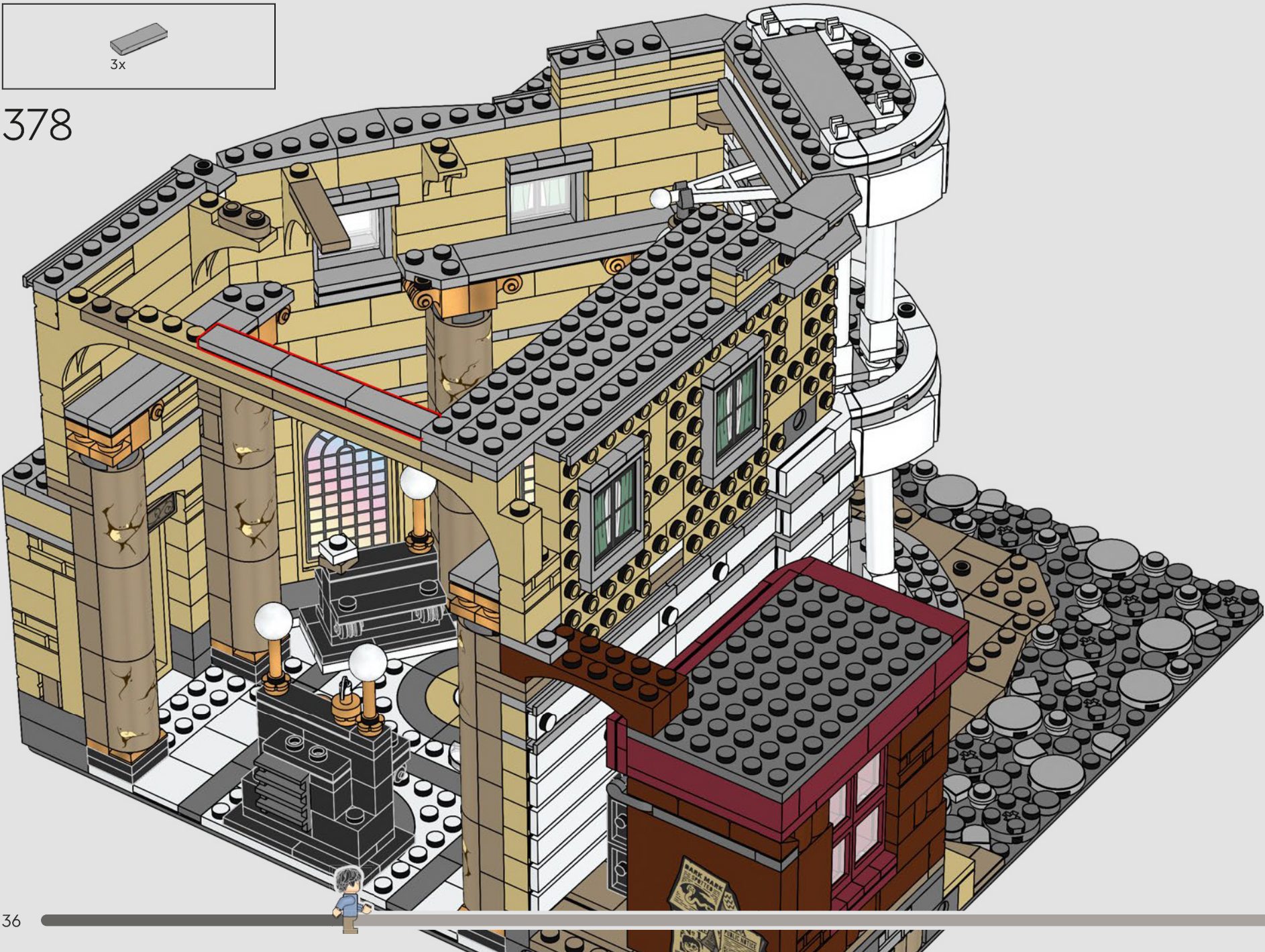

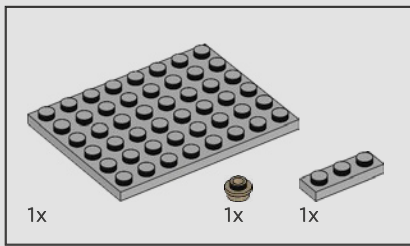

379

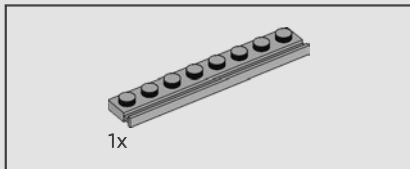
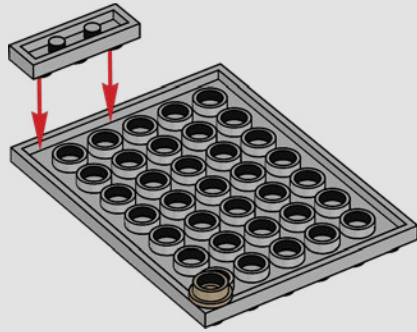

380

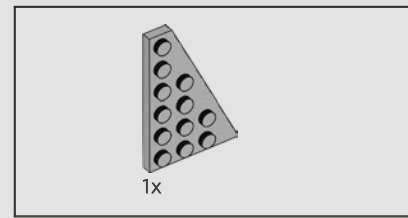
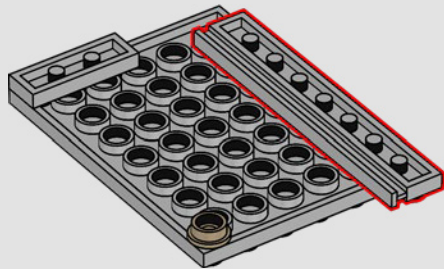

381

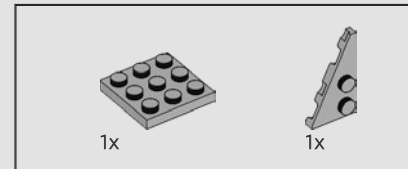
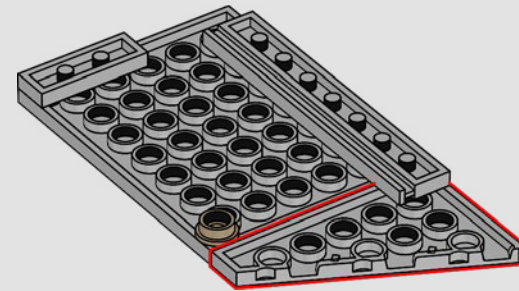

382

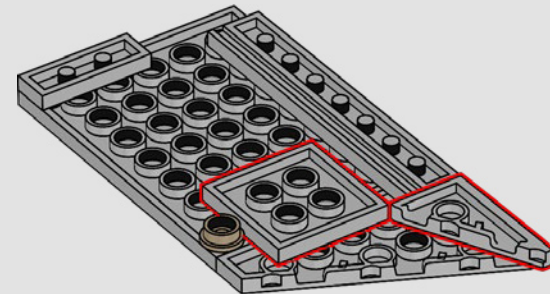

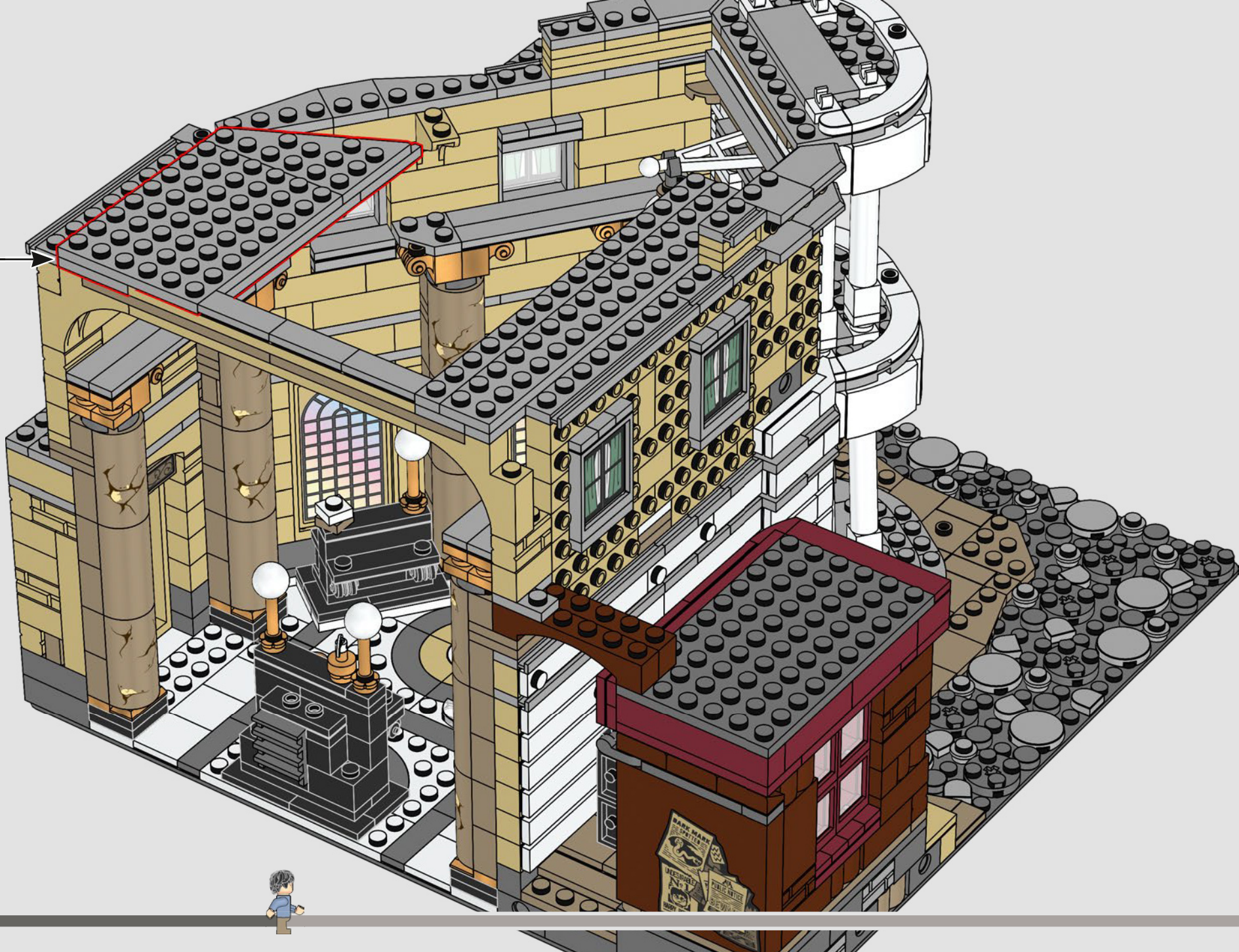

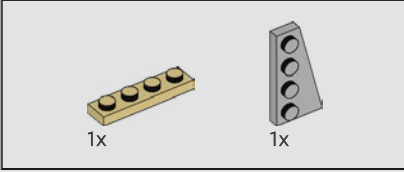
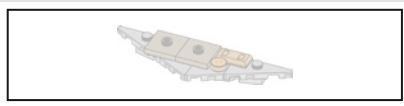

384

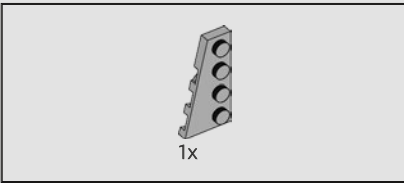
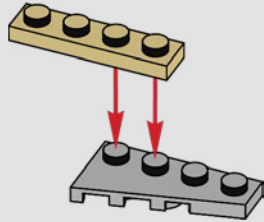

385

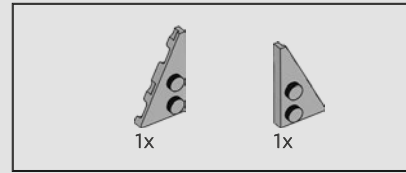
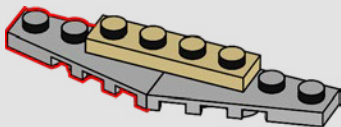

386

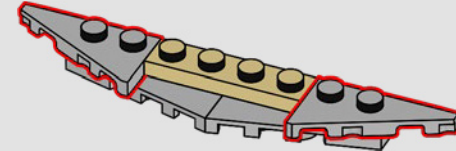

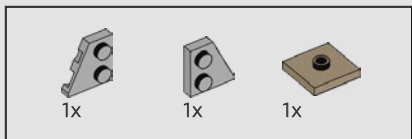

387

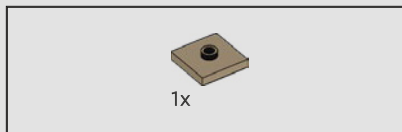
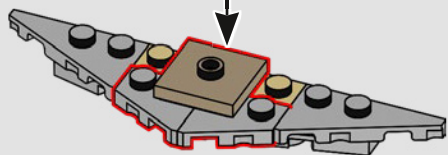
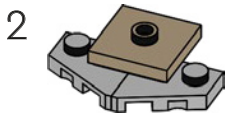
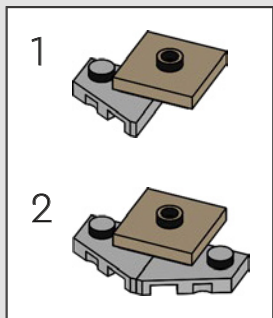

388

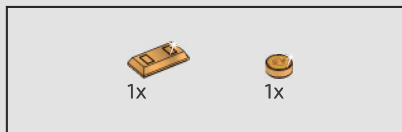
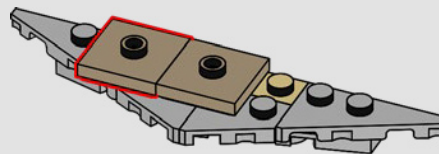

389

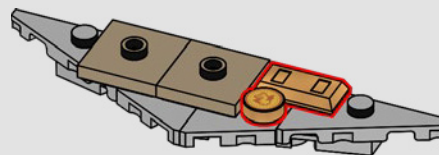



390

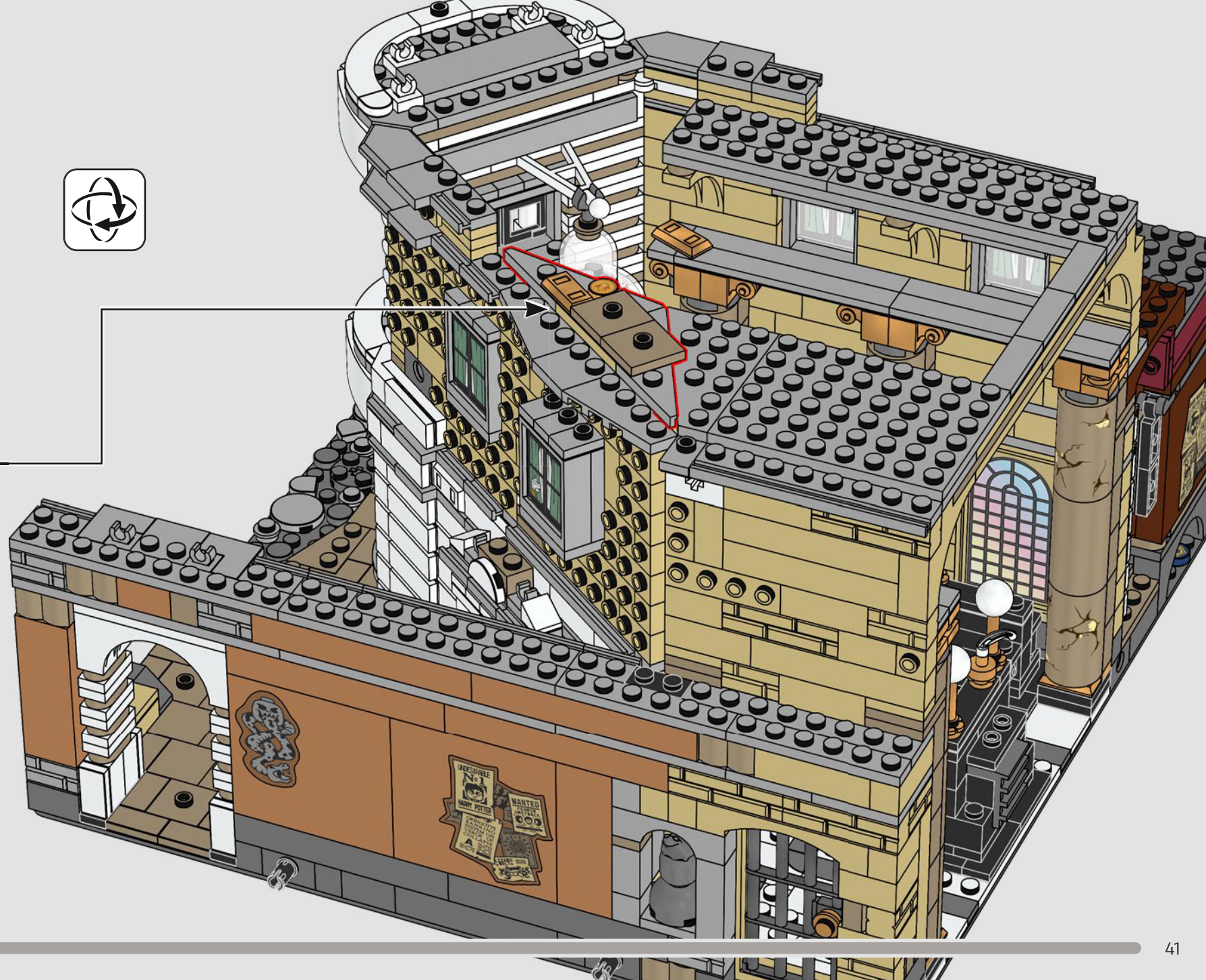

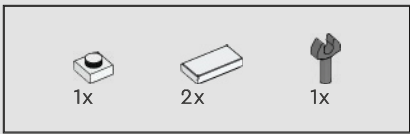

391

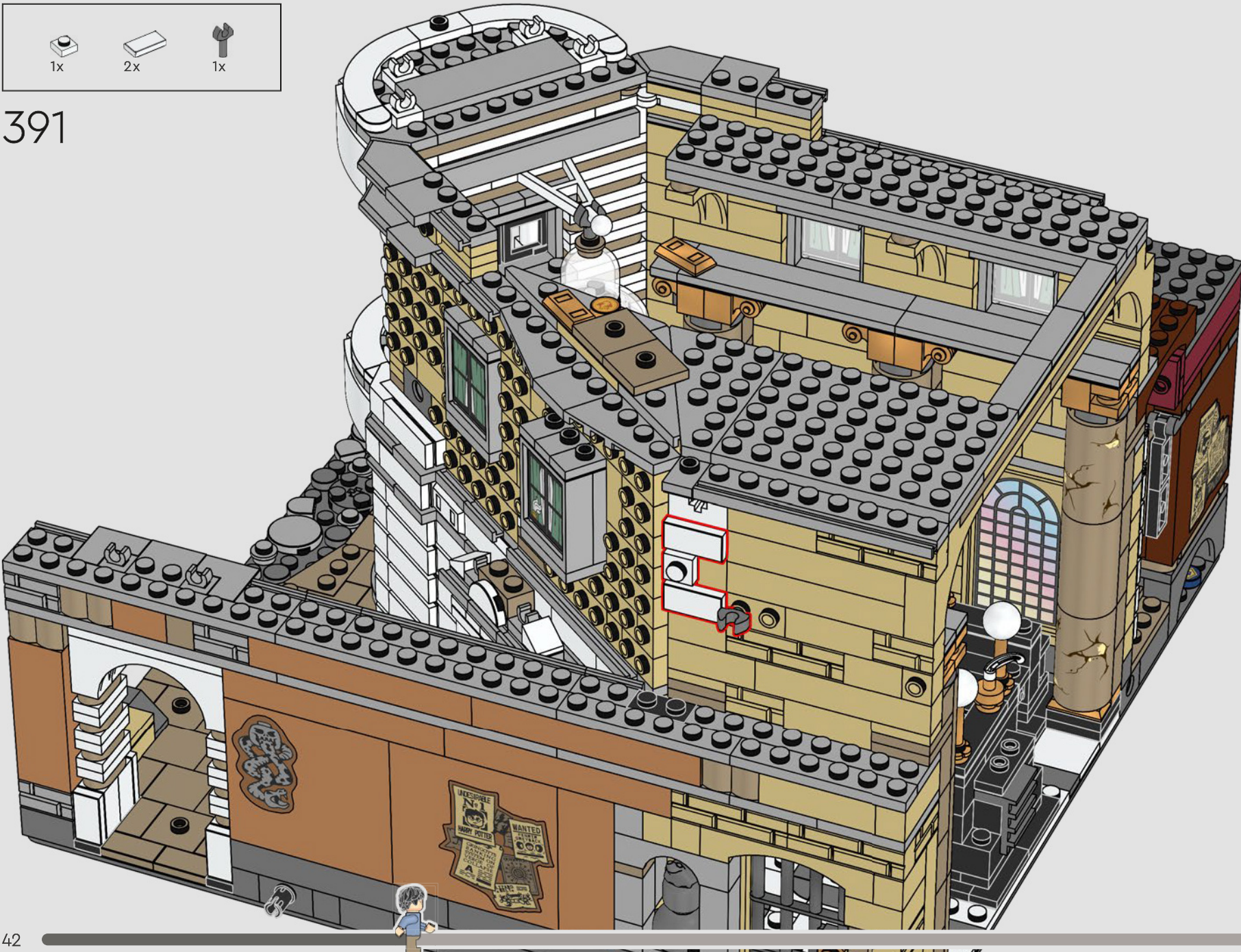



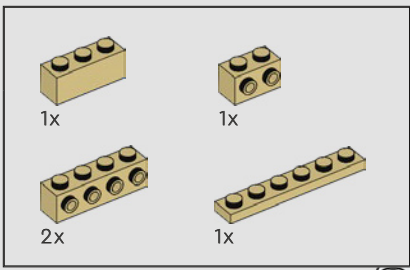

392

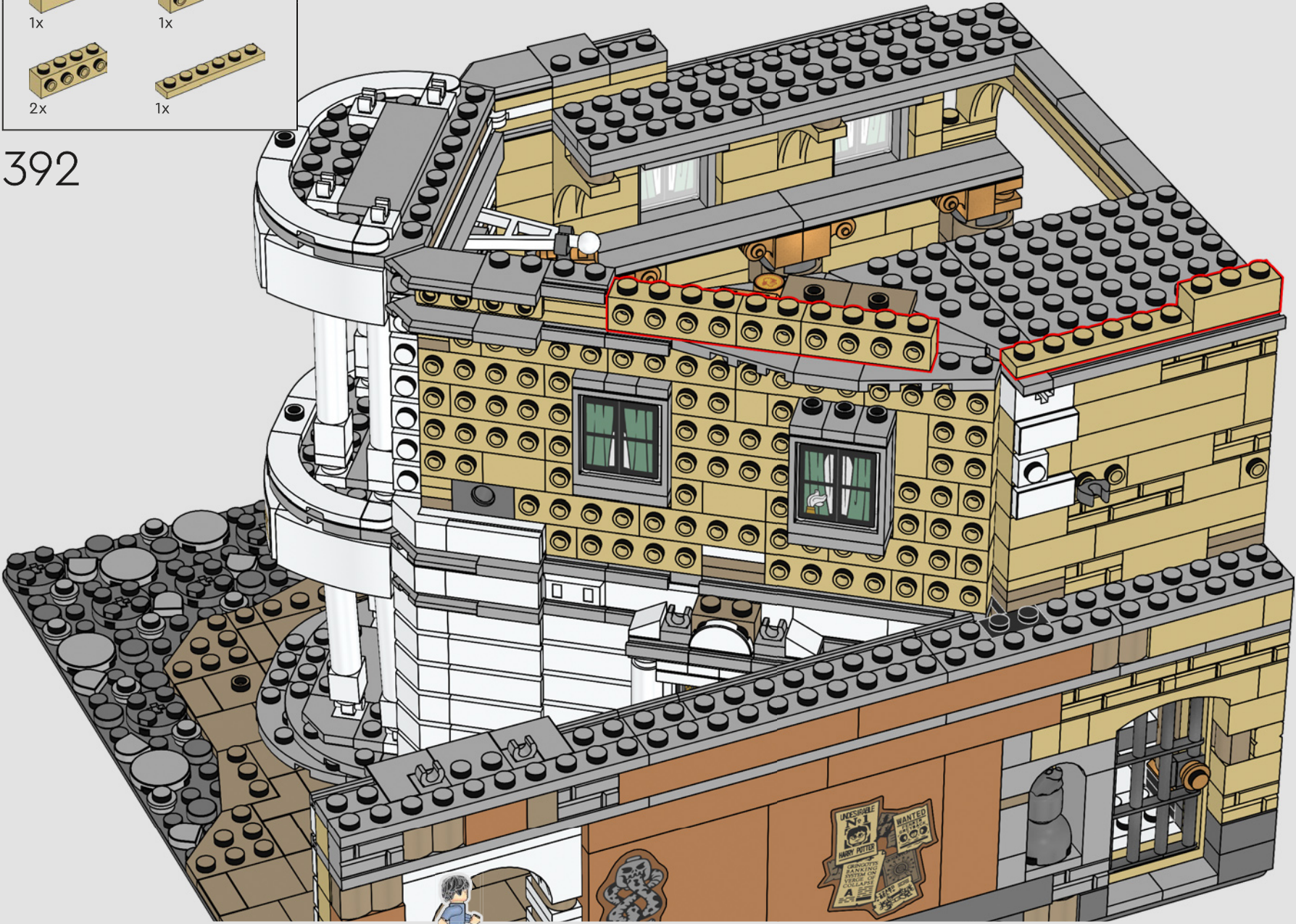

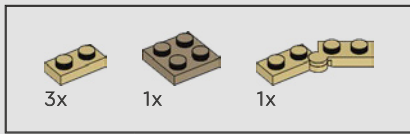

393

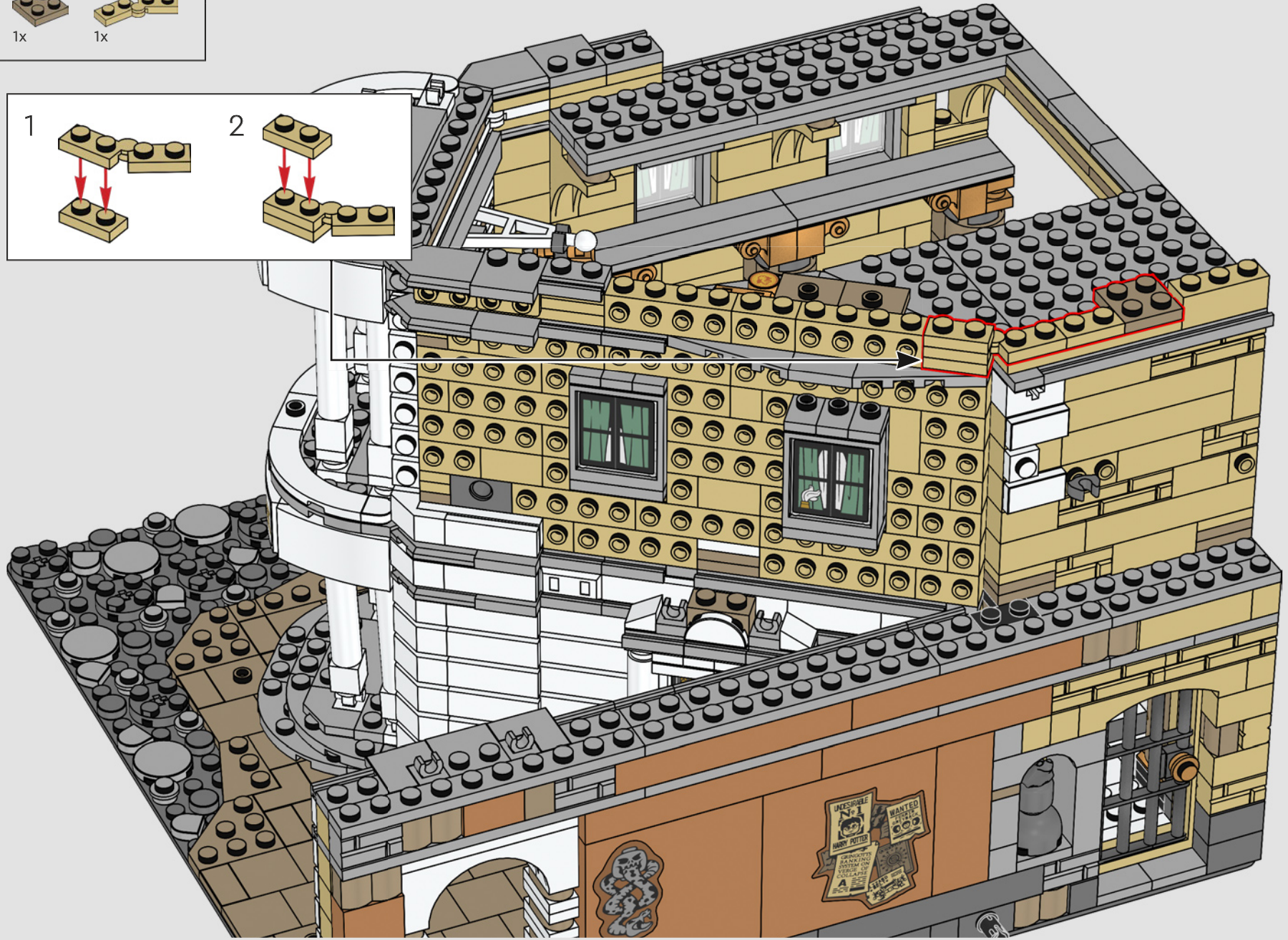
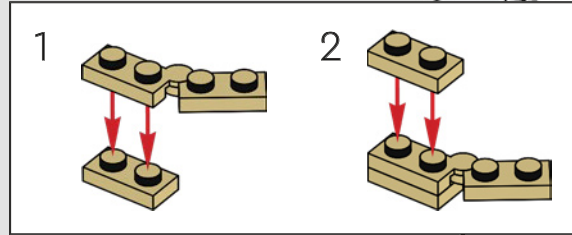

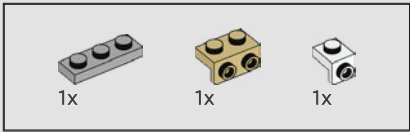

394

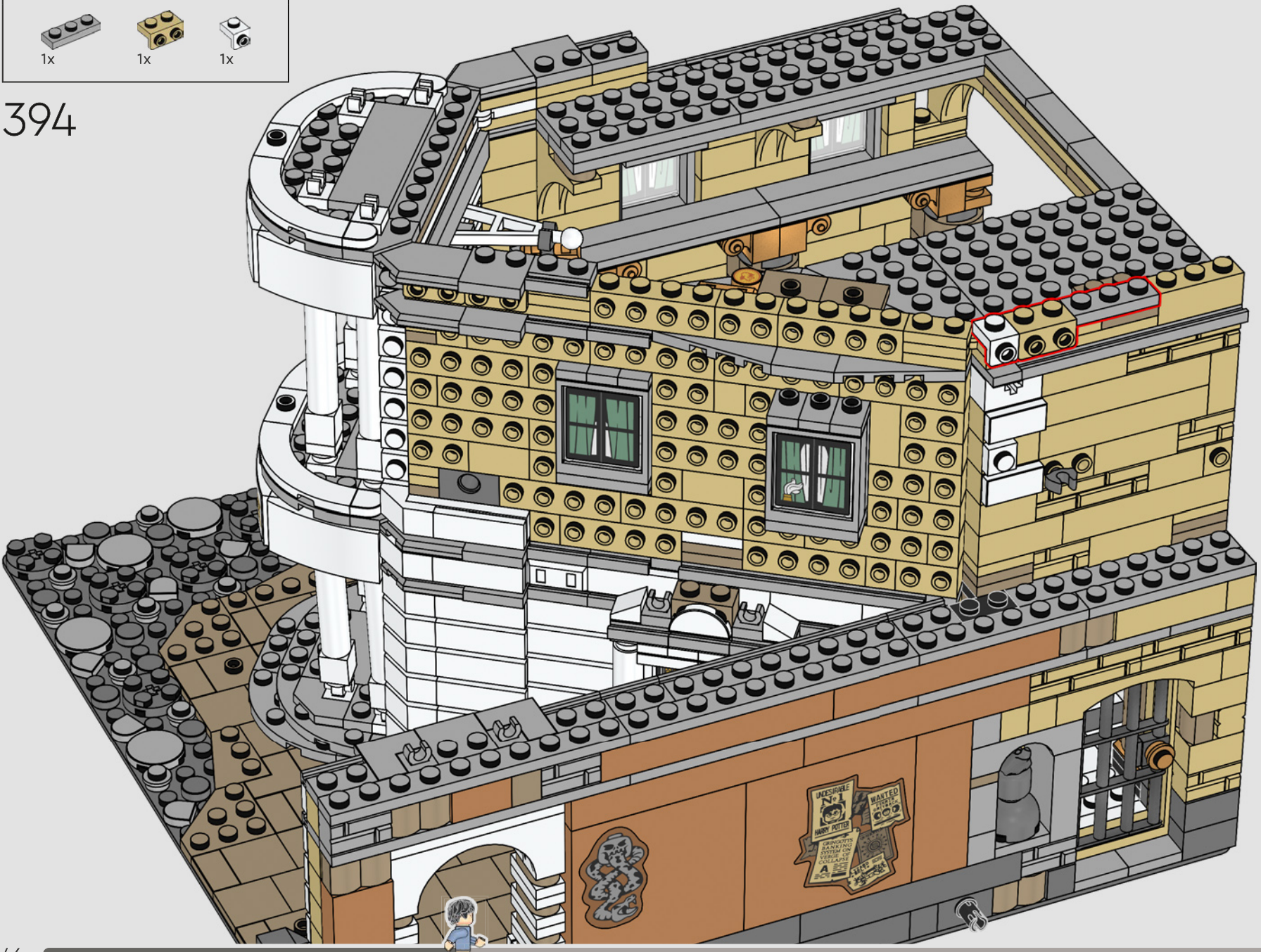

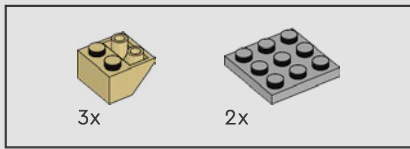

395

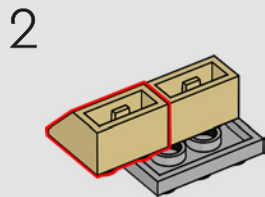
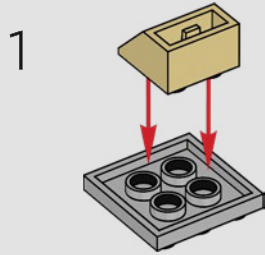

3

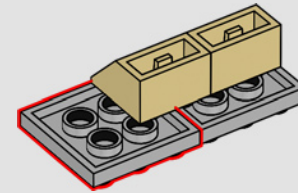

4

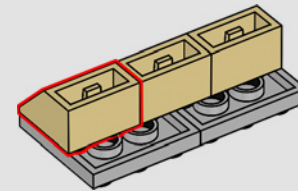

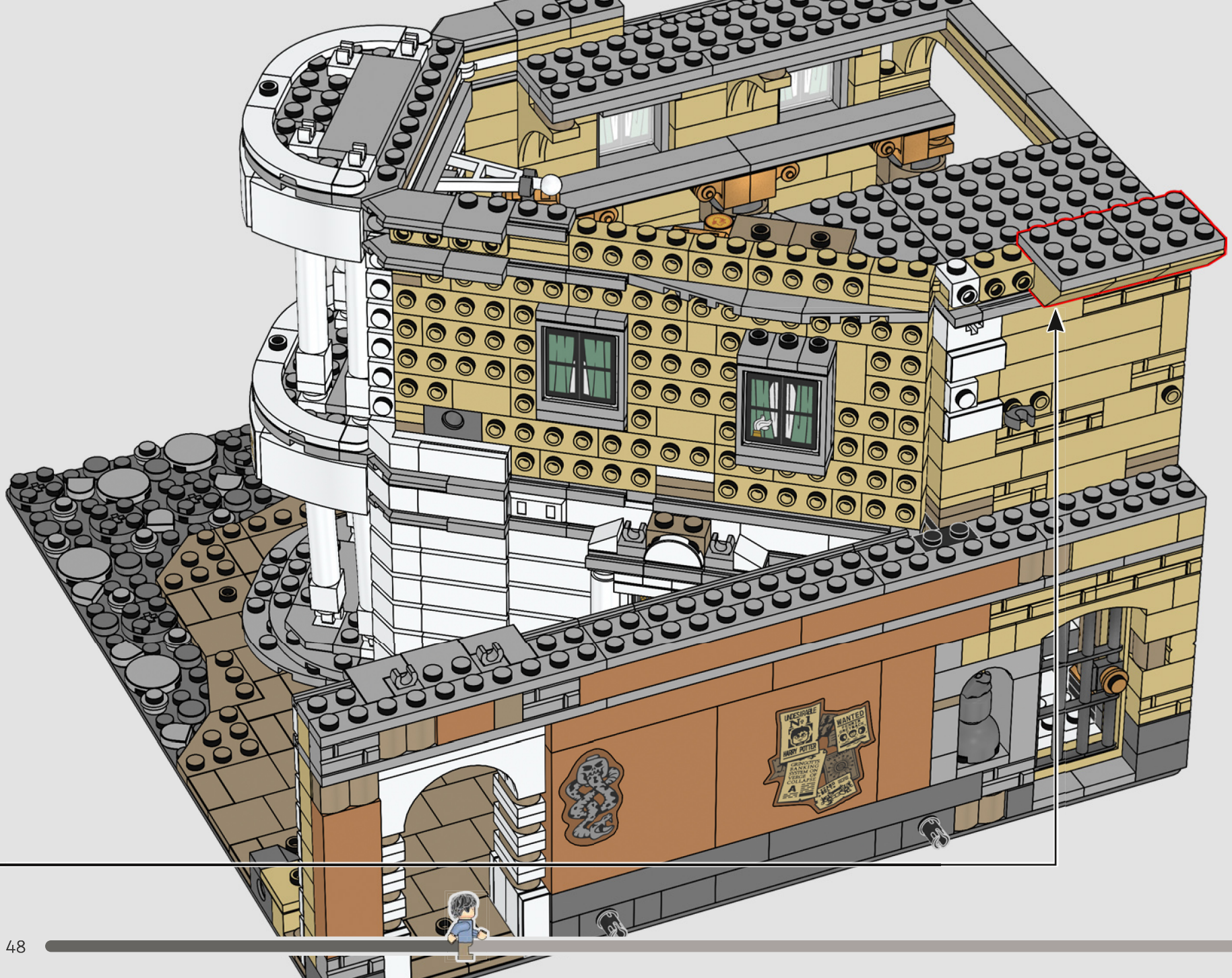



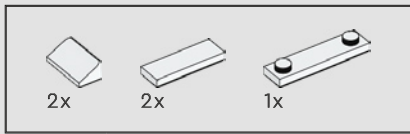

396

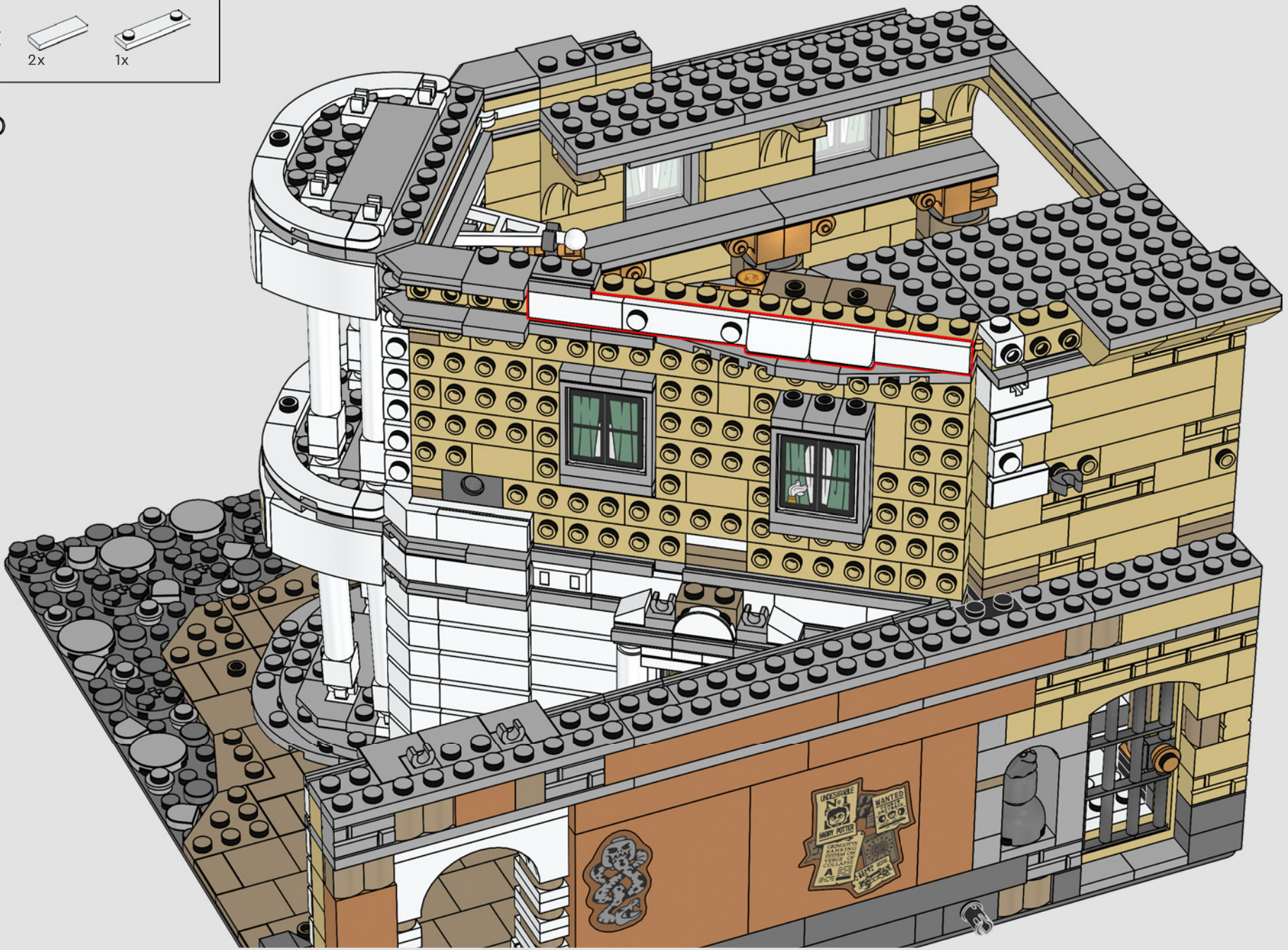

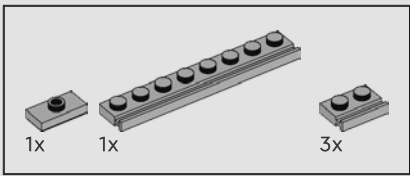

397

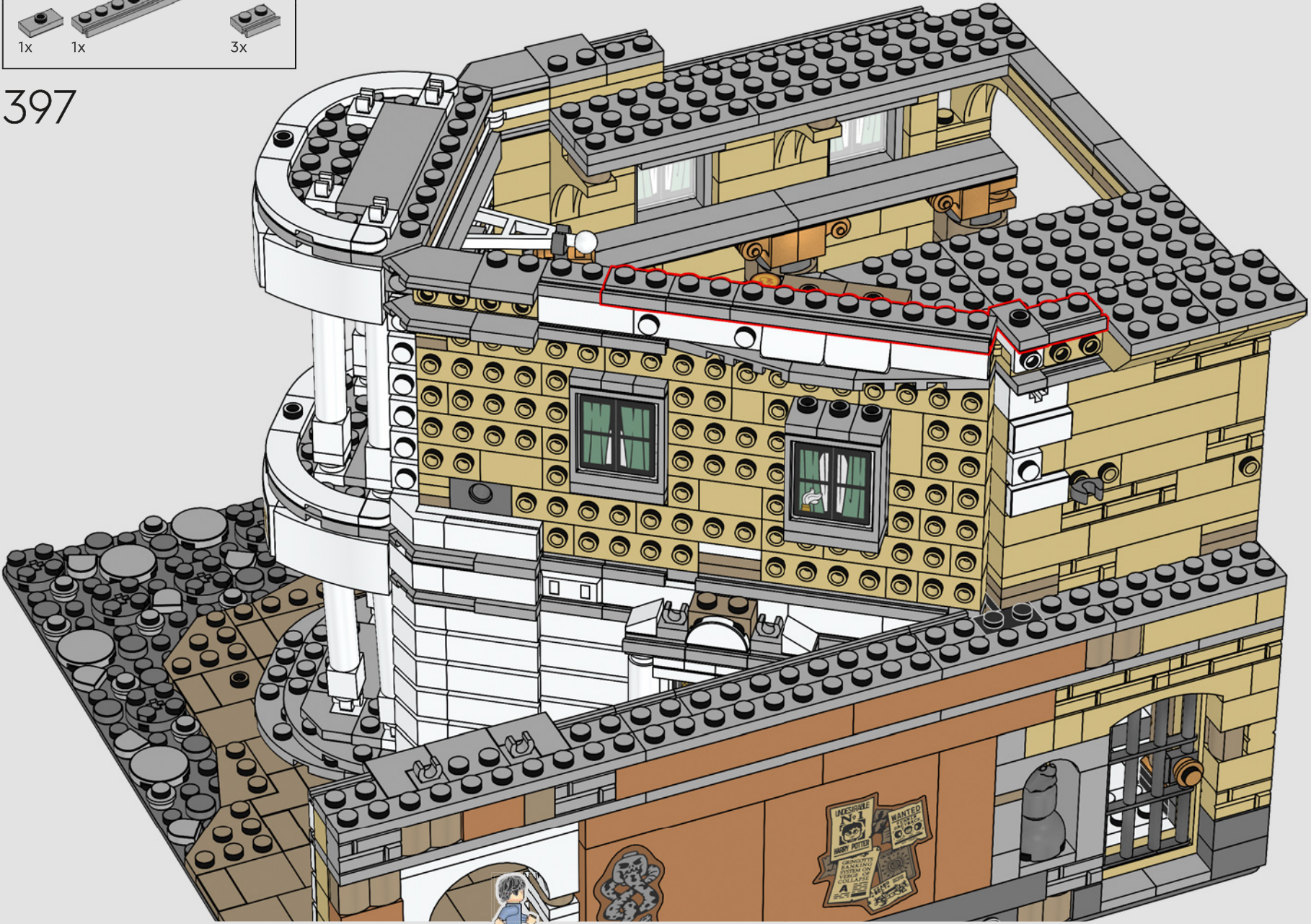

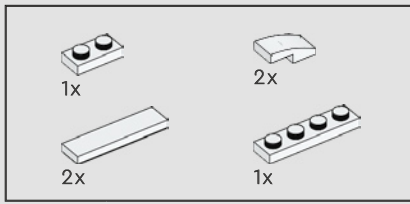

398

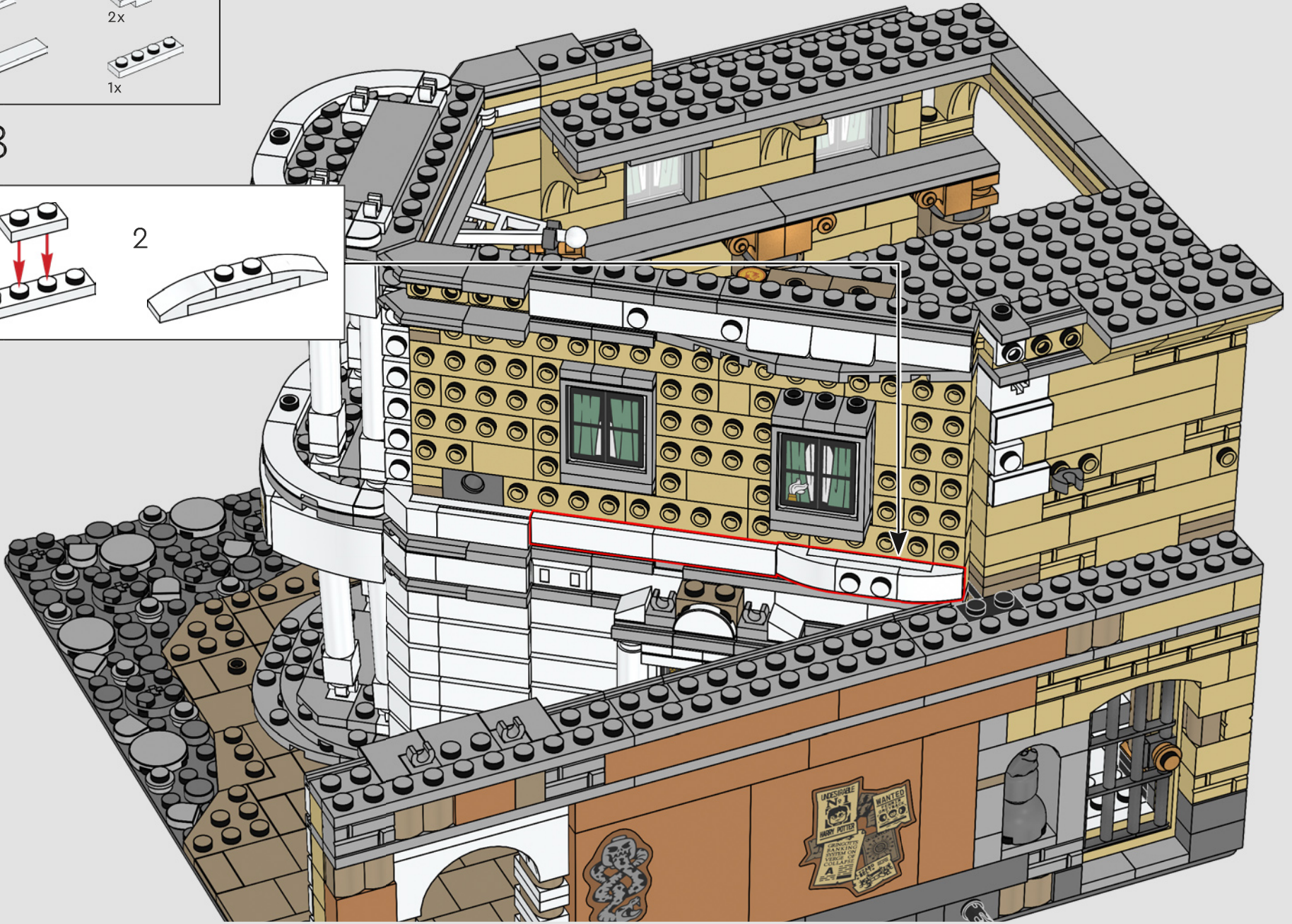
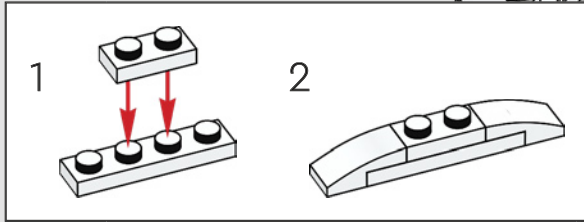

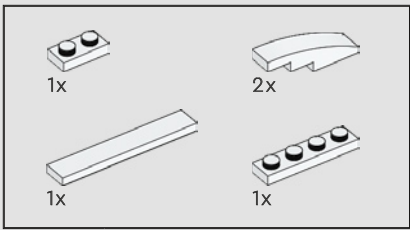

399

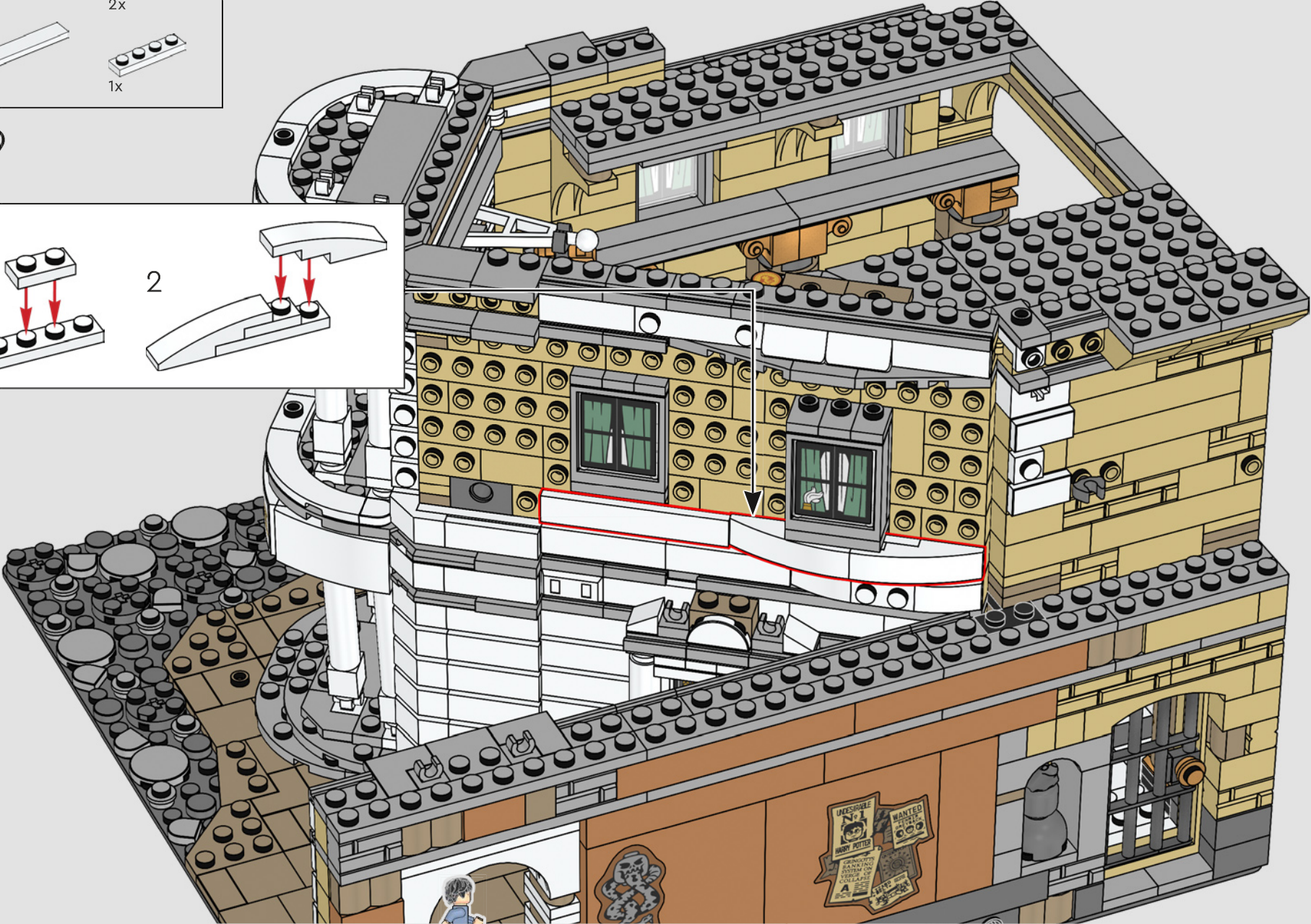
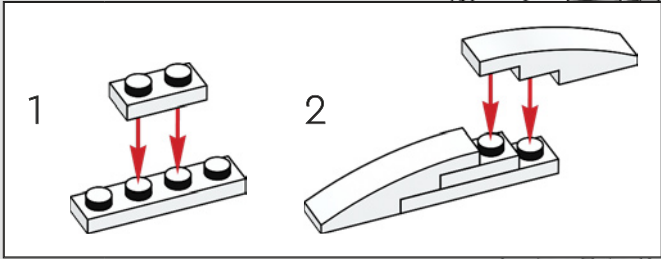

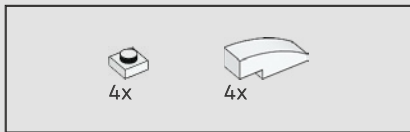

400

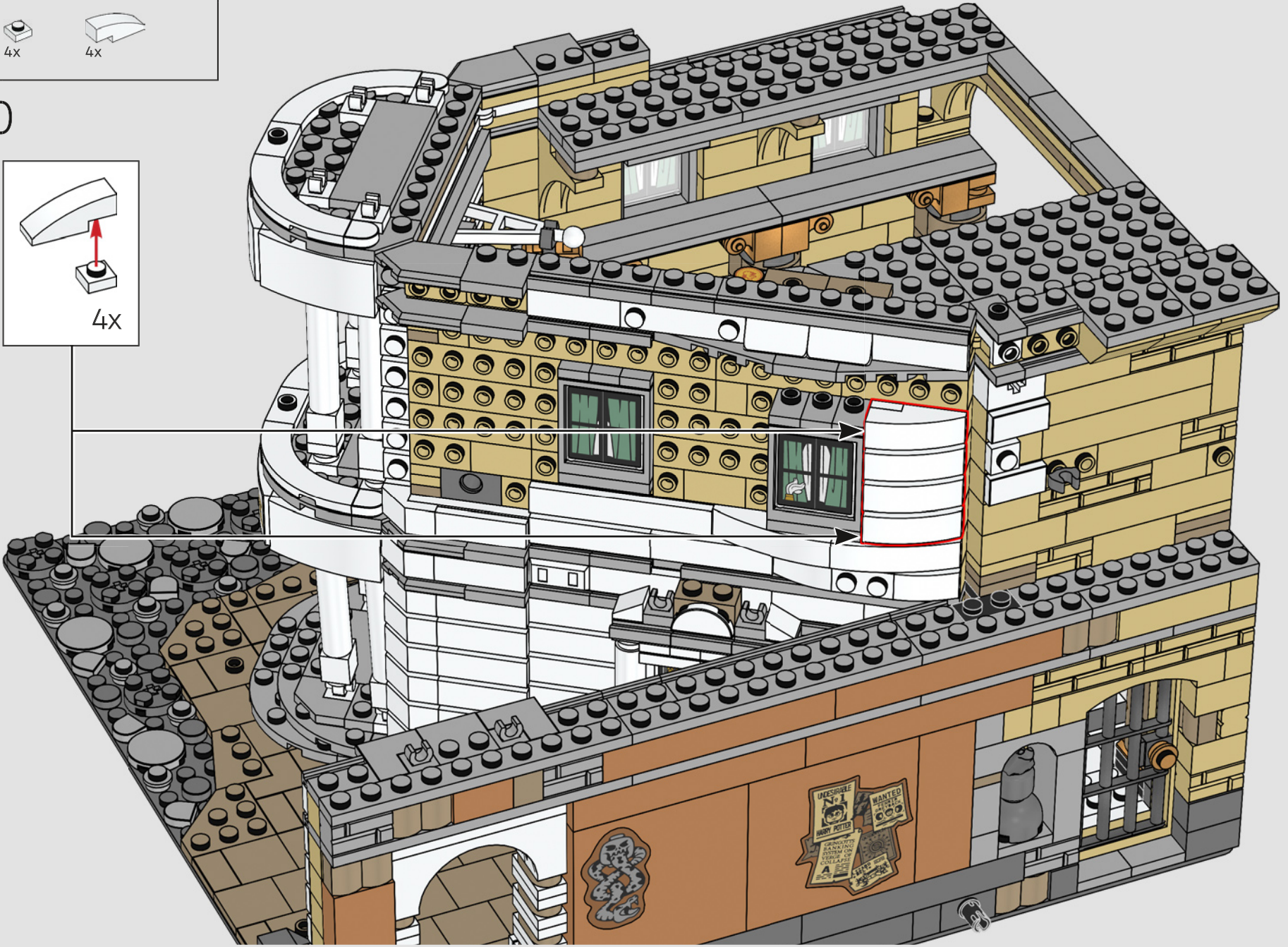
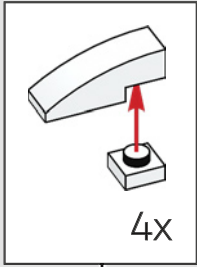

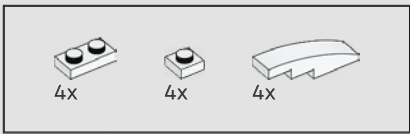



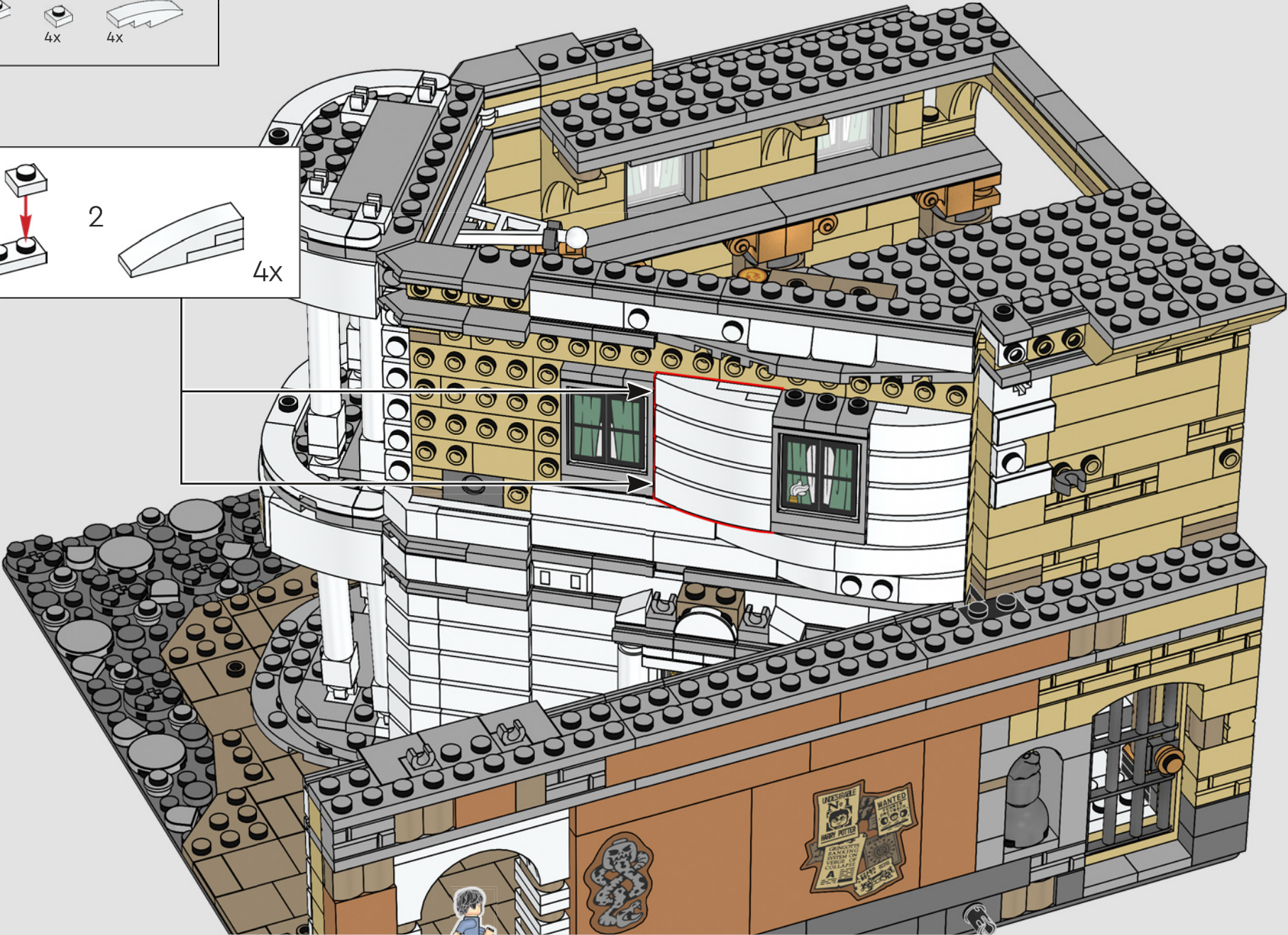
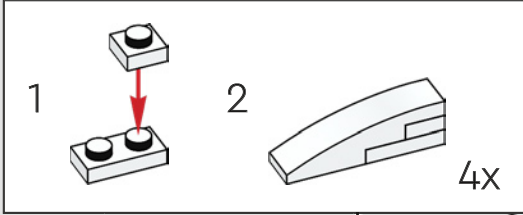

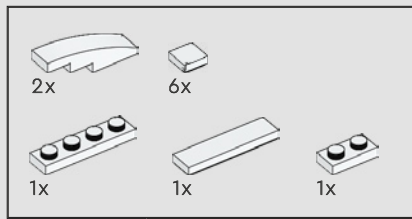
401



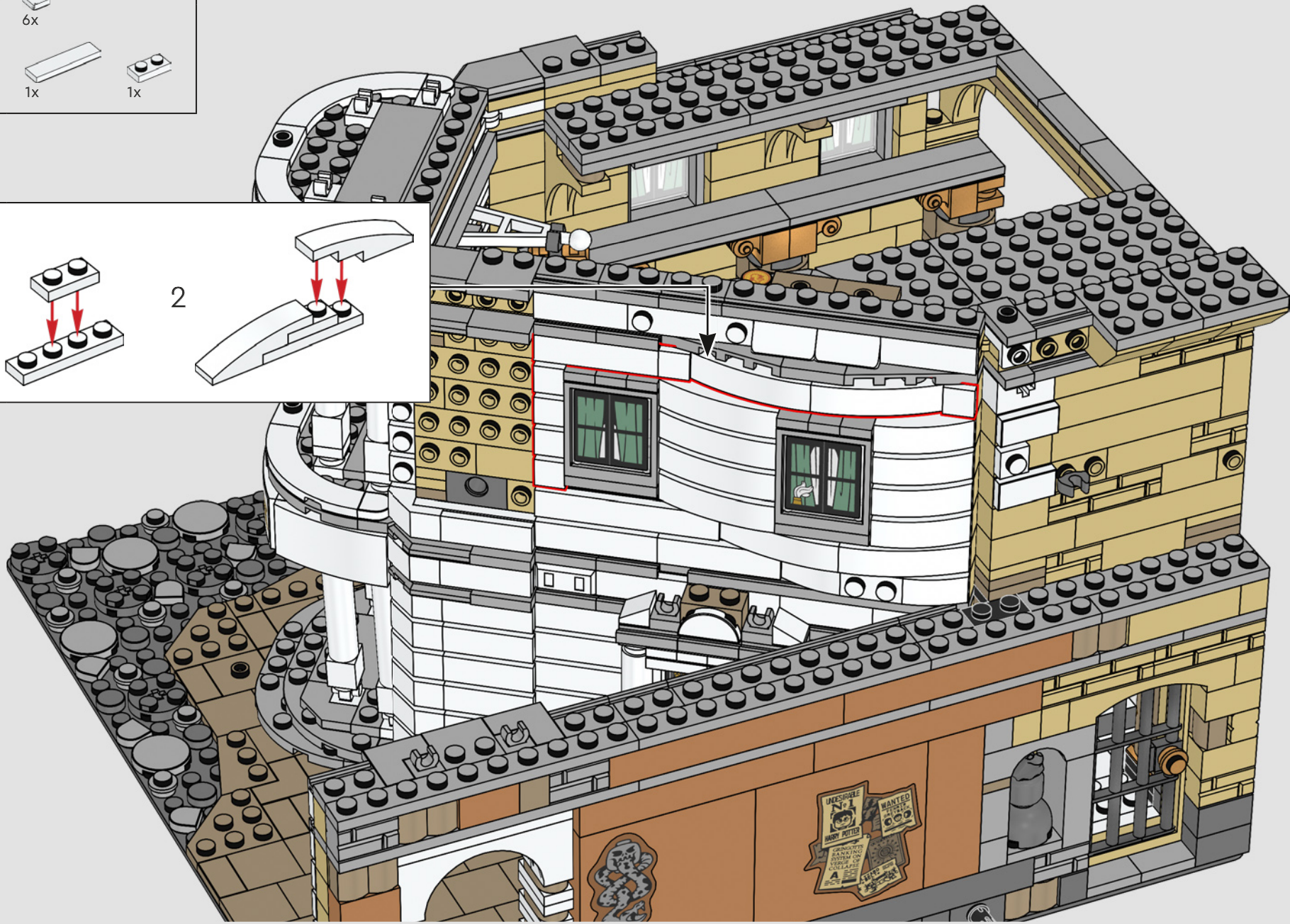
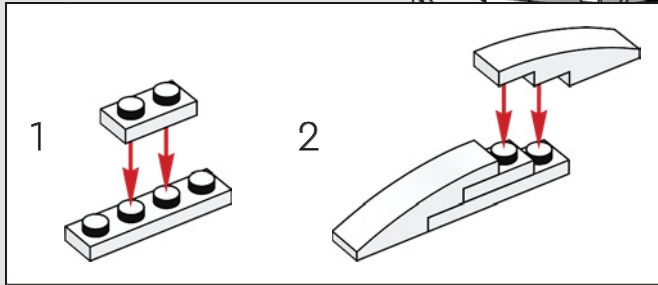

402



-   
 2x
-   
 1x
-   
 1x

403

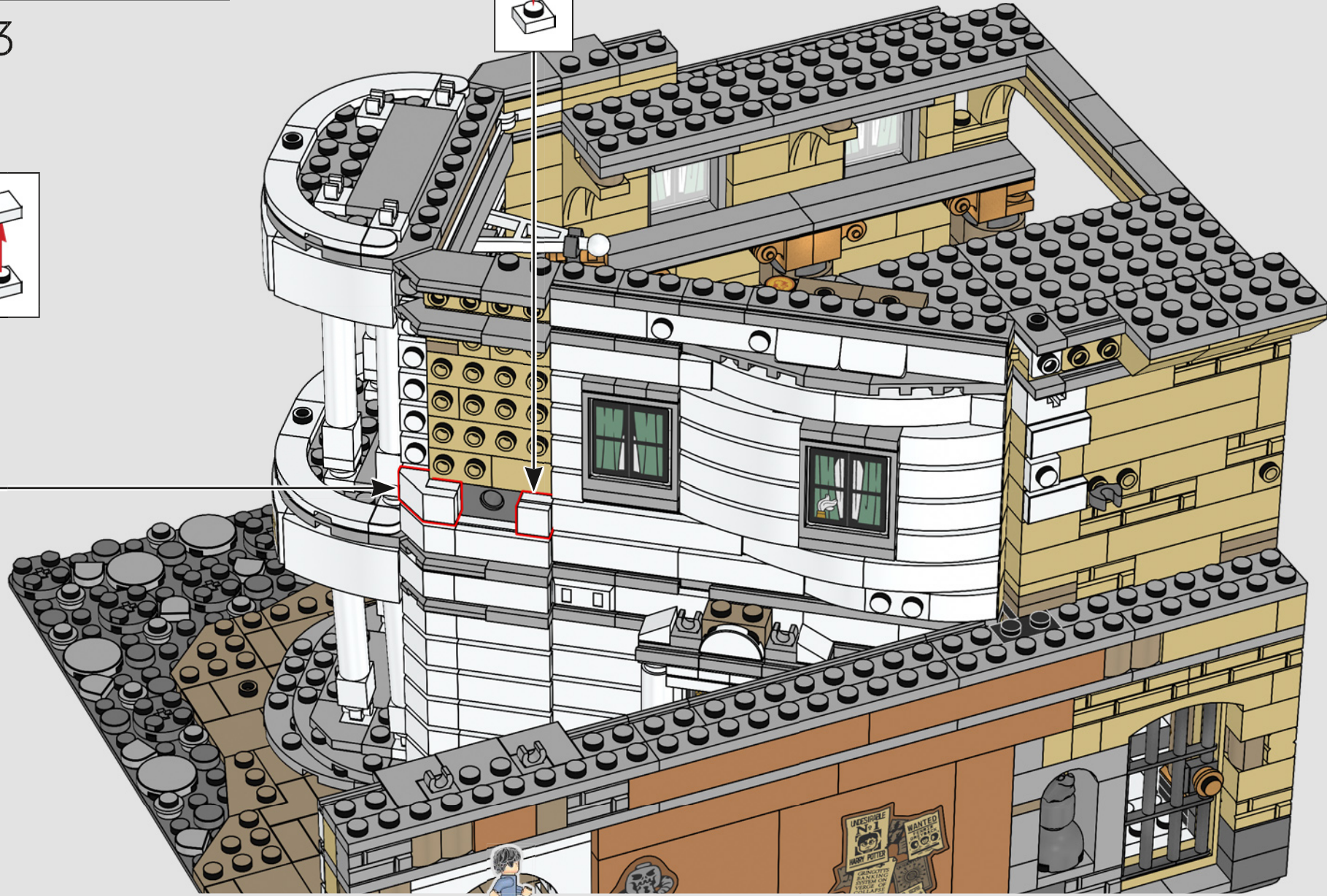
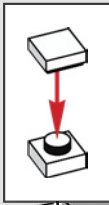
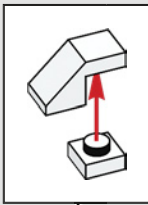



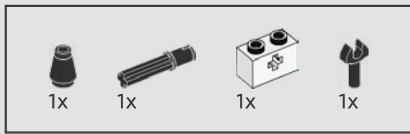

404

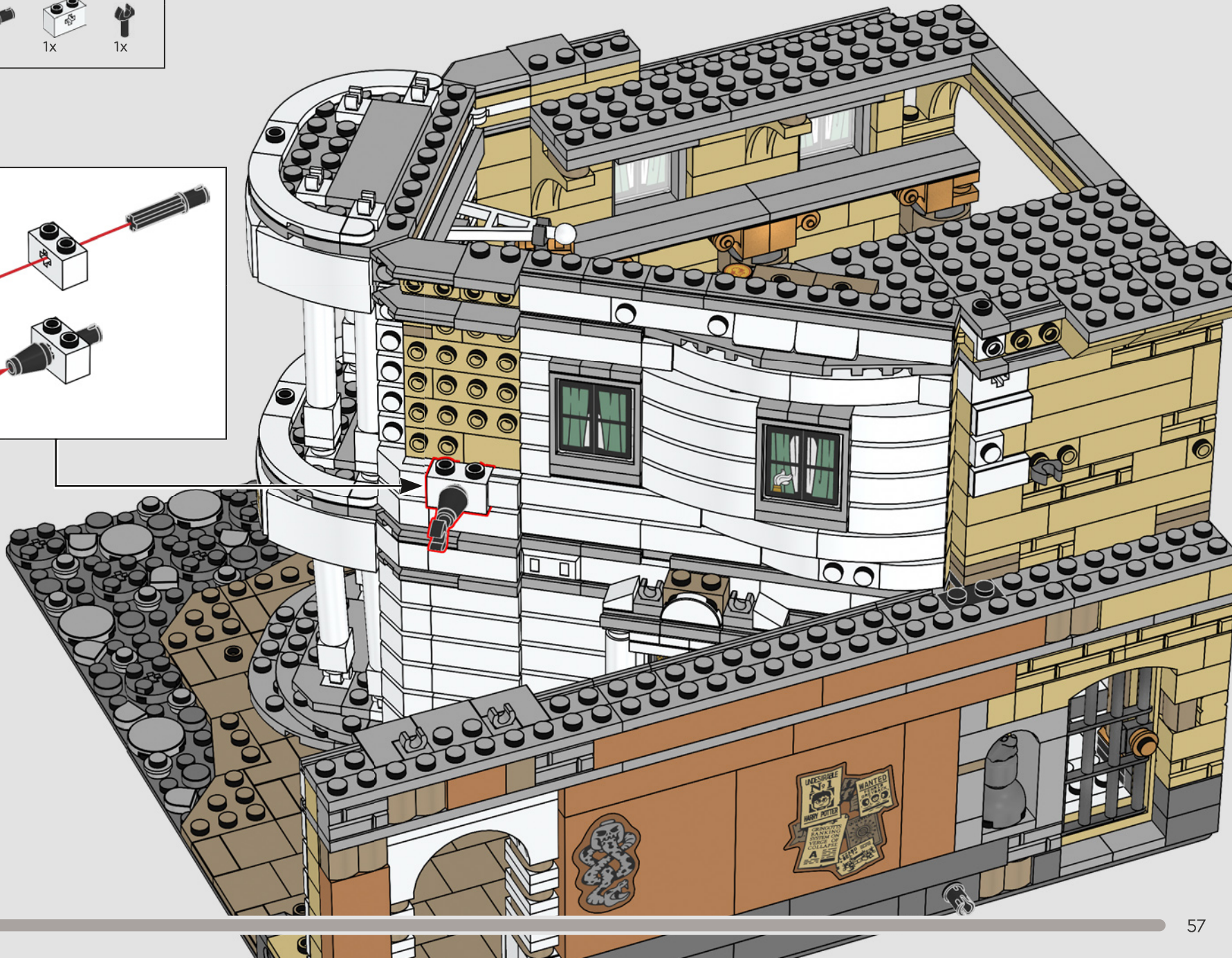
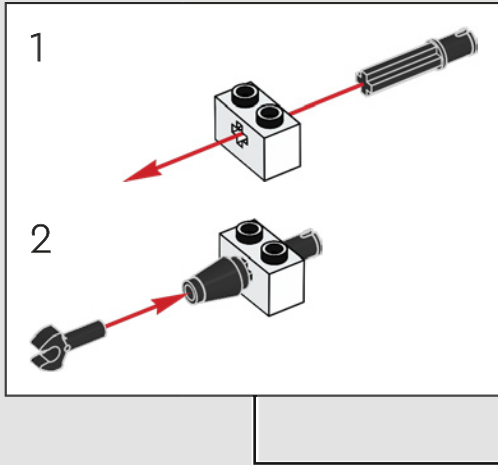

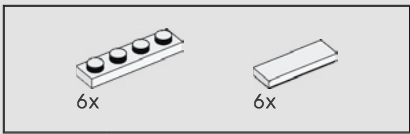

405

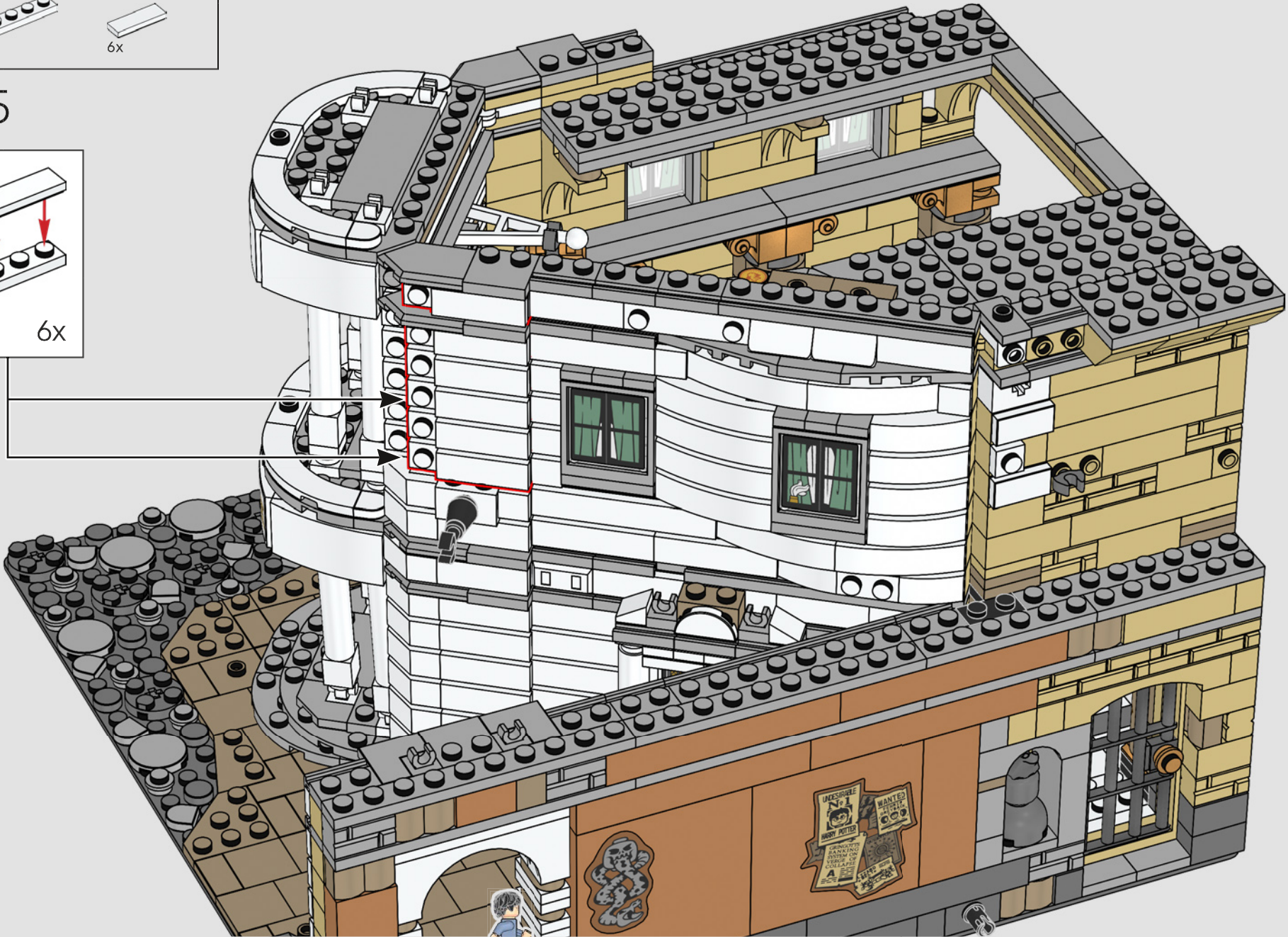
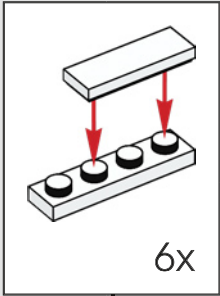



6x

406

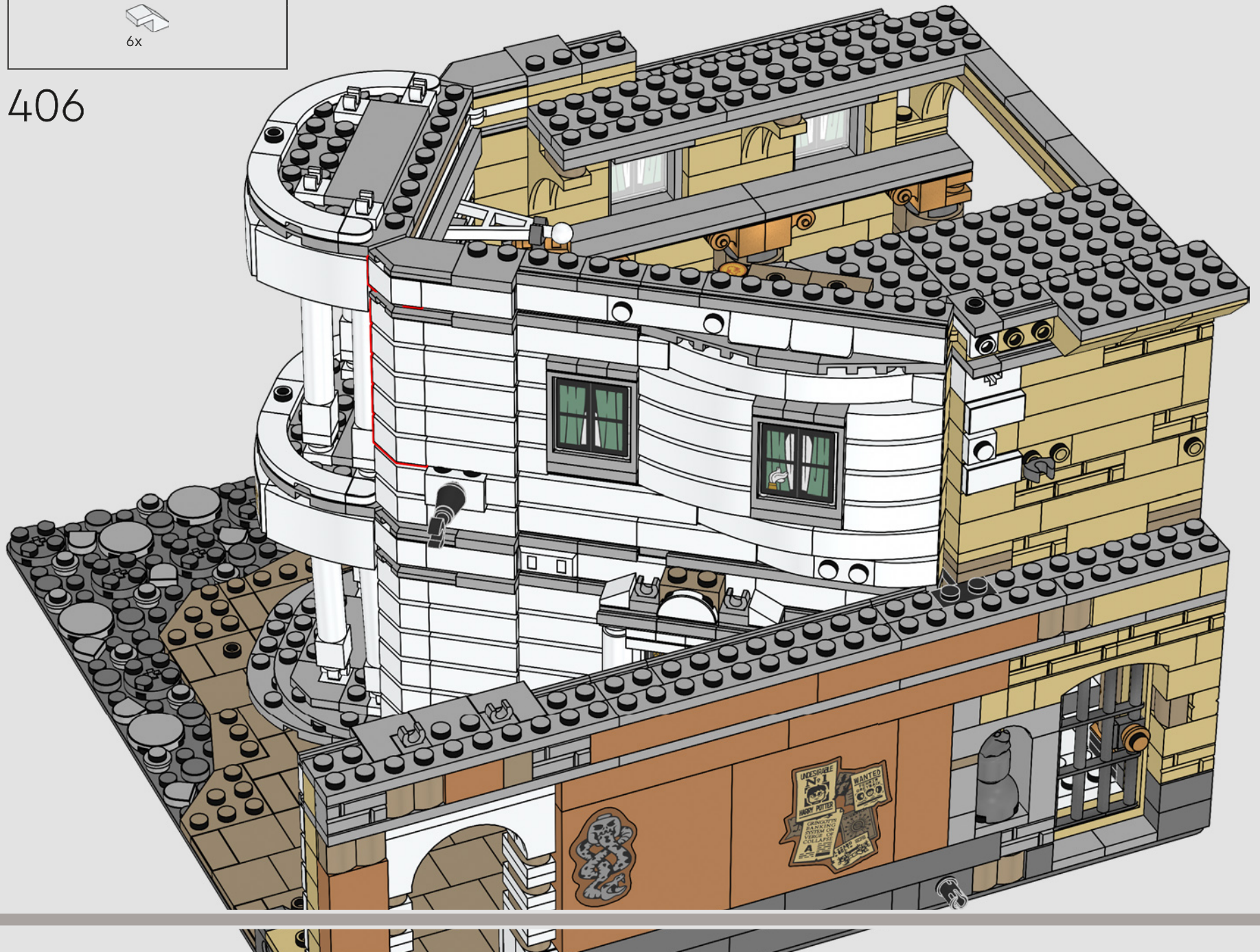

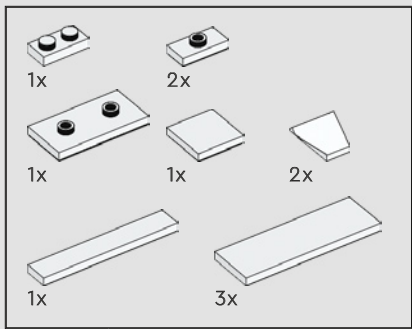

407

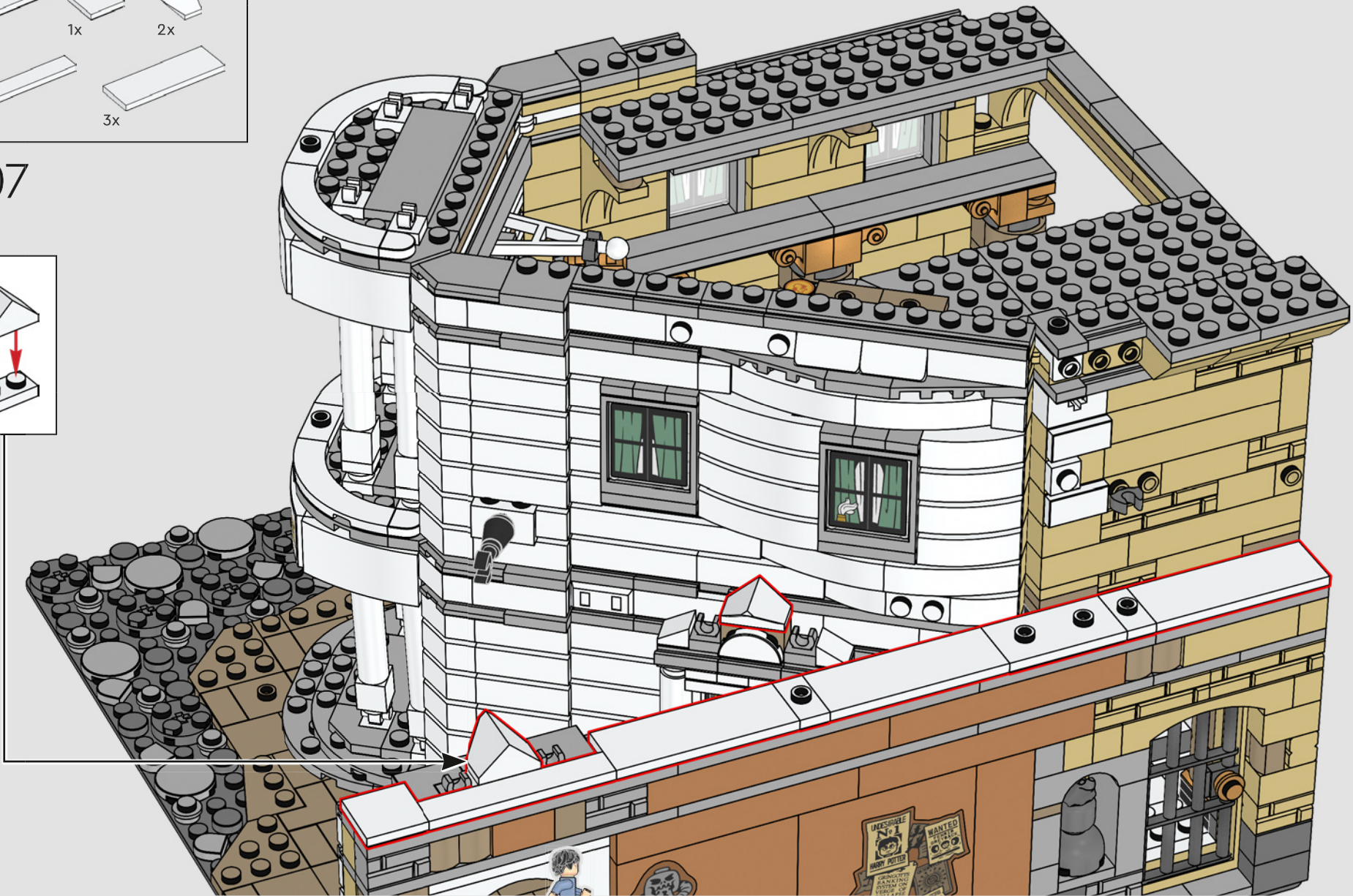
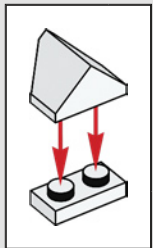

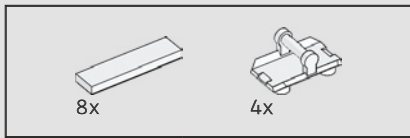

408

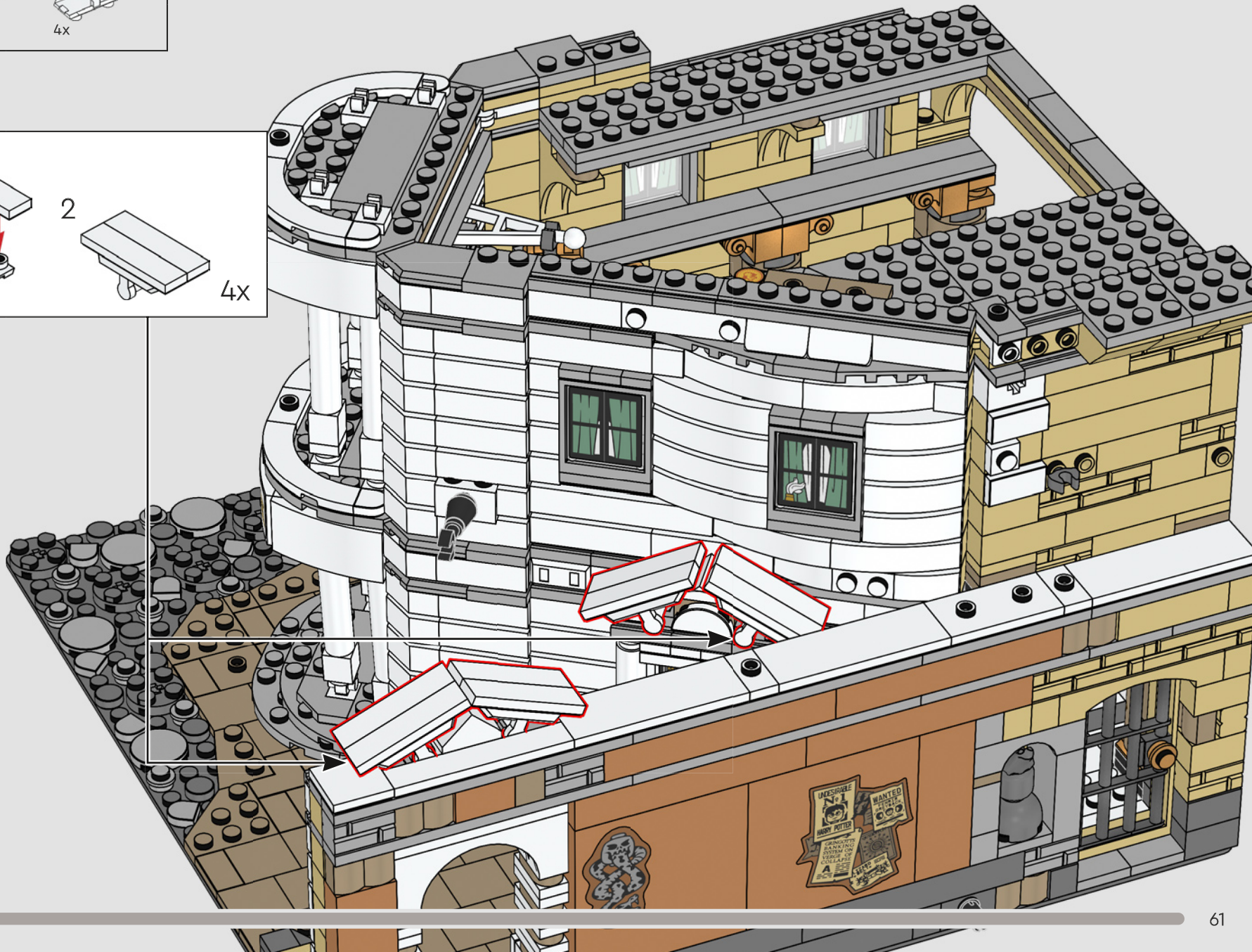
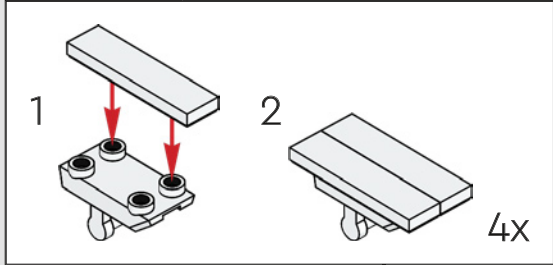

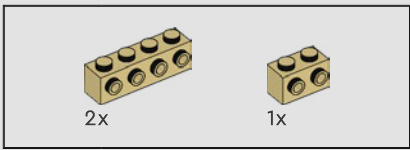

409

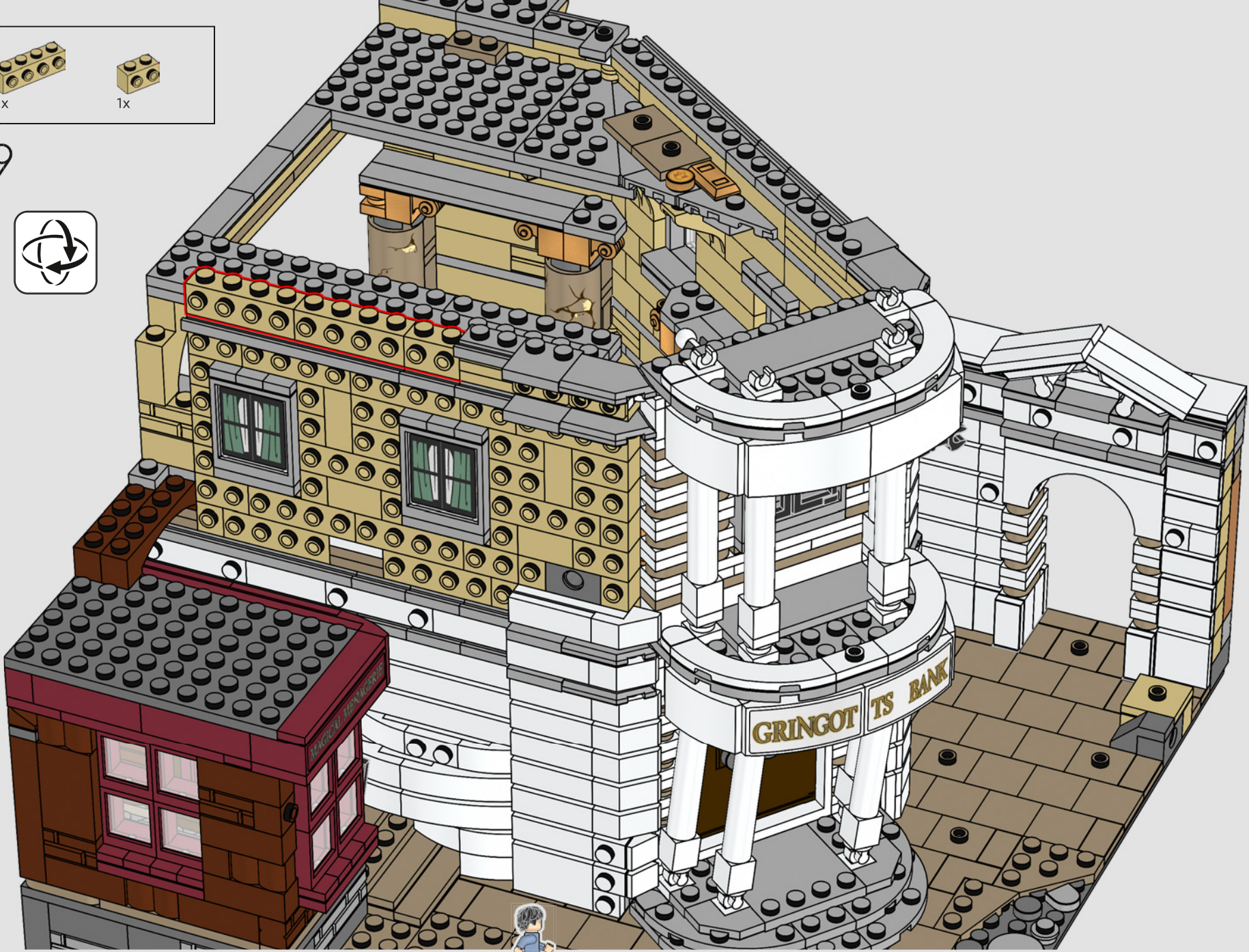

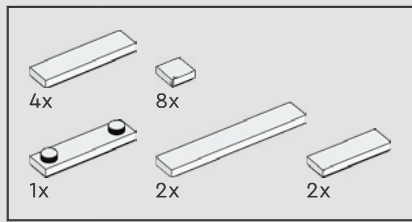

410

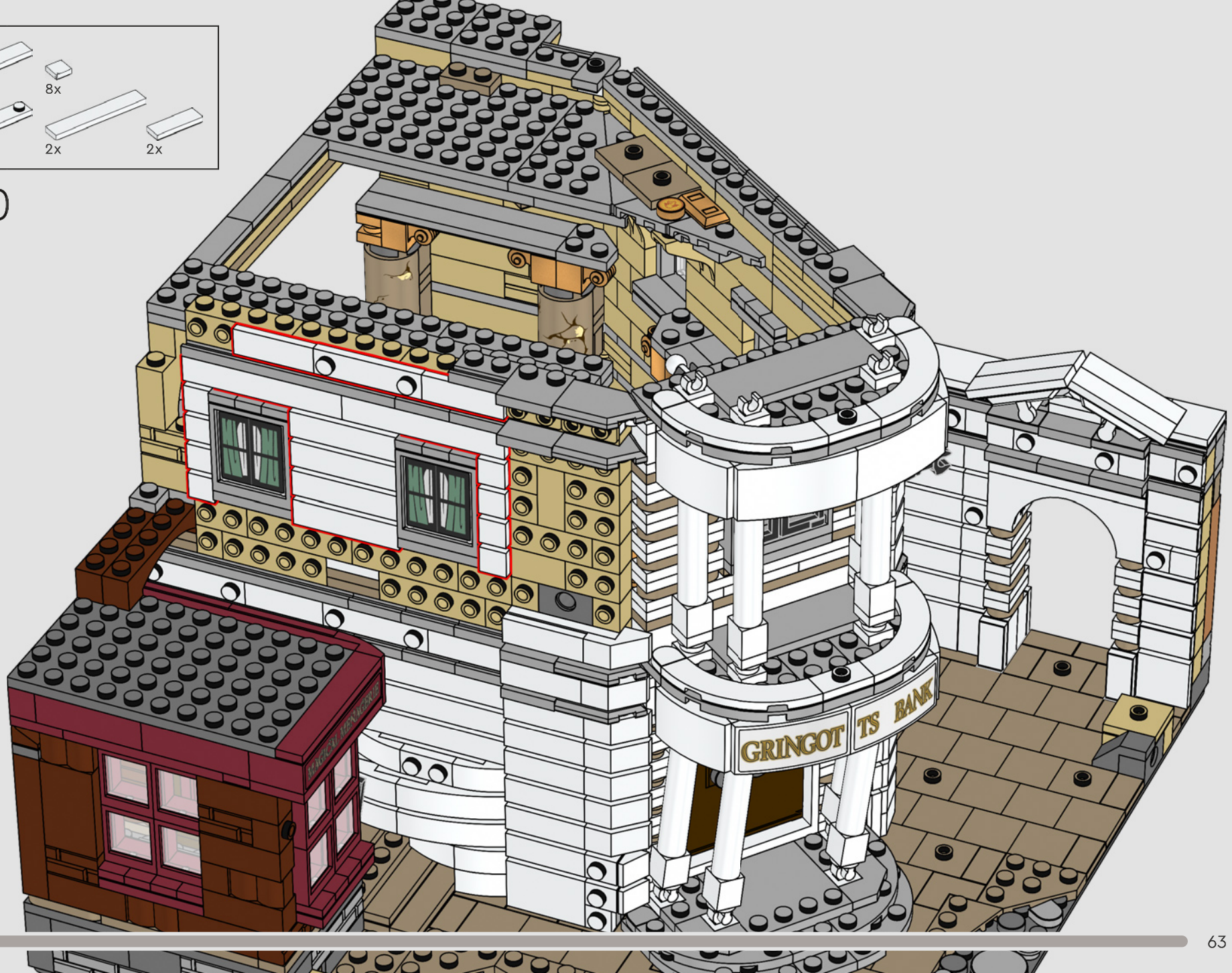

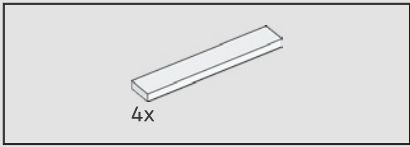

411

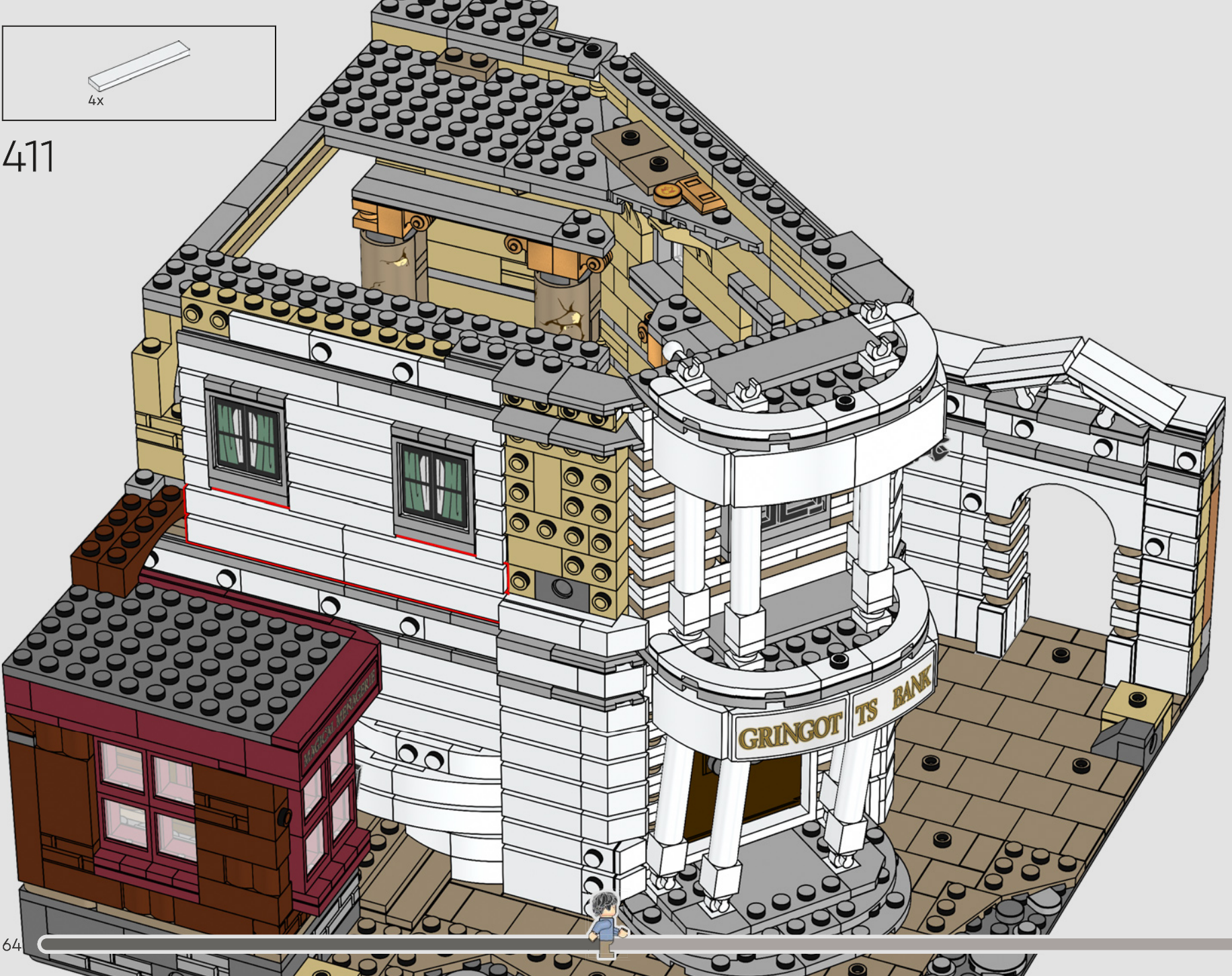



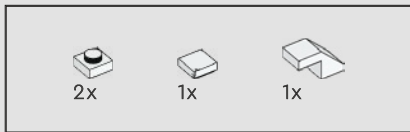



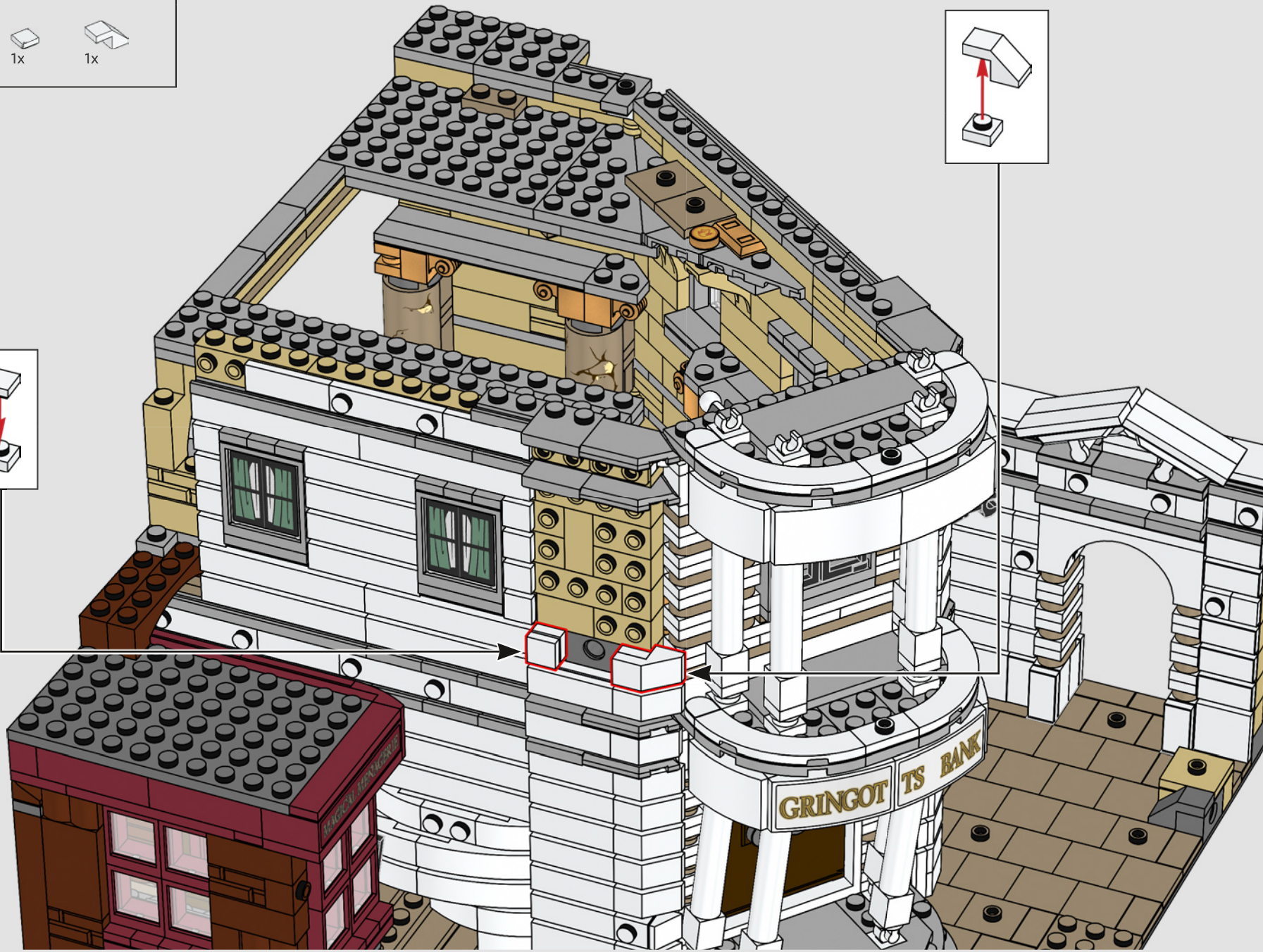
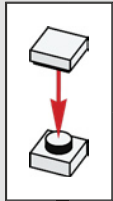
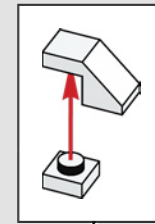

412



-  1x
-  1x
-  1x
-  1x

413

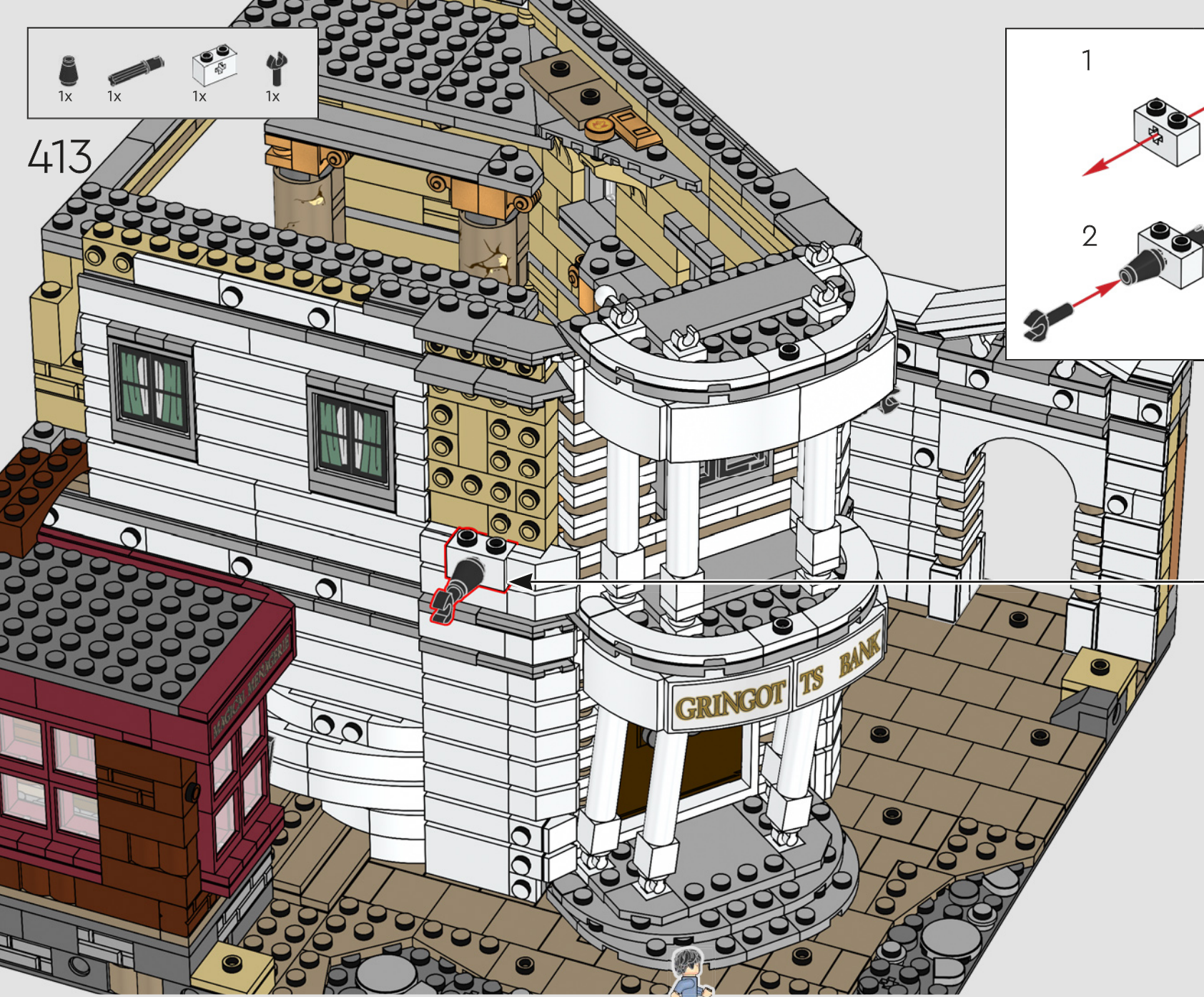
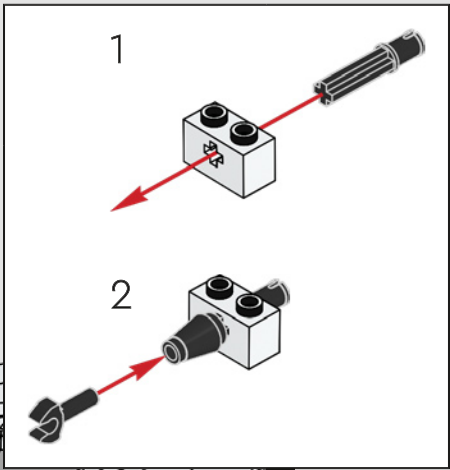

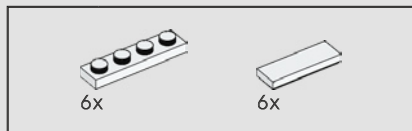

414

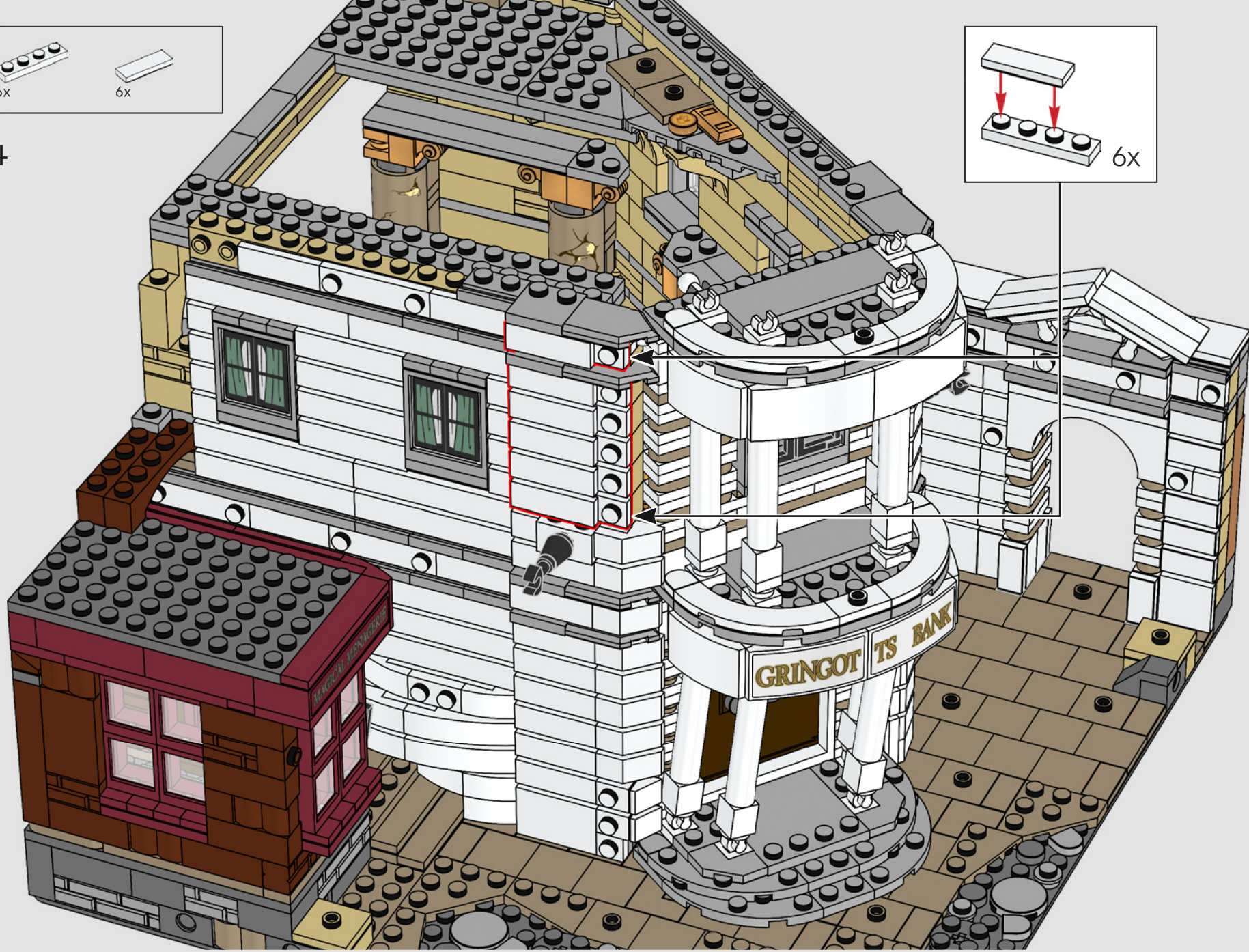
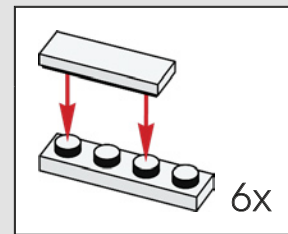

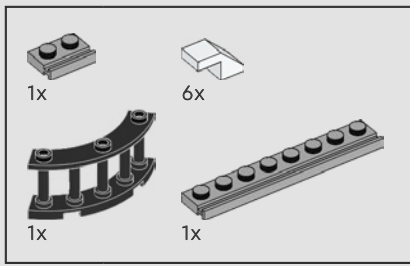

415

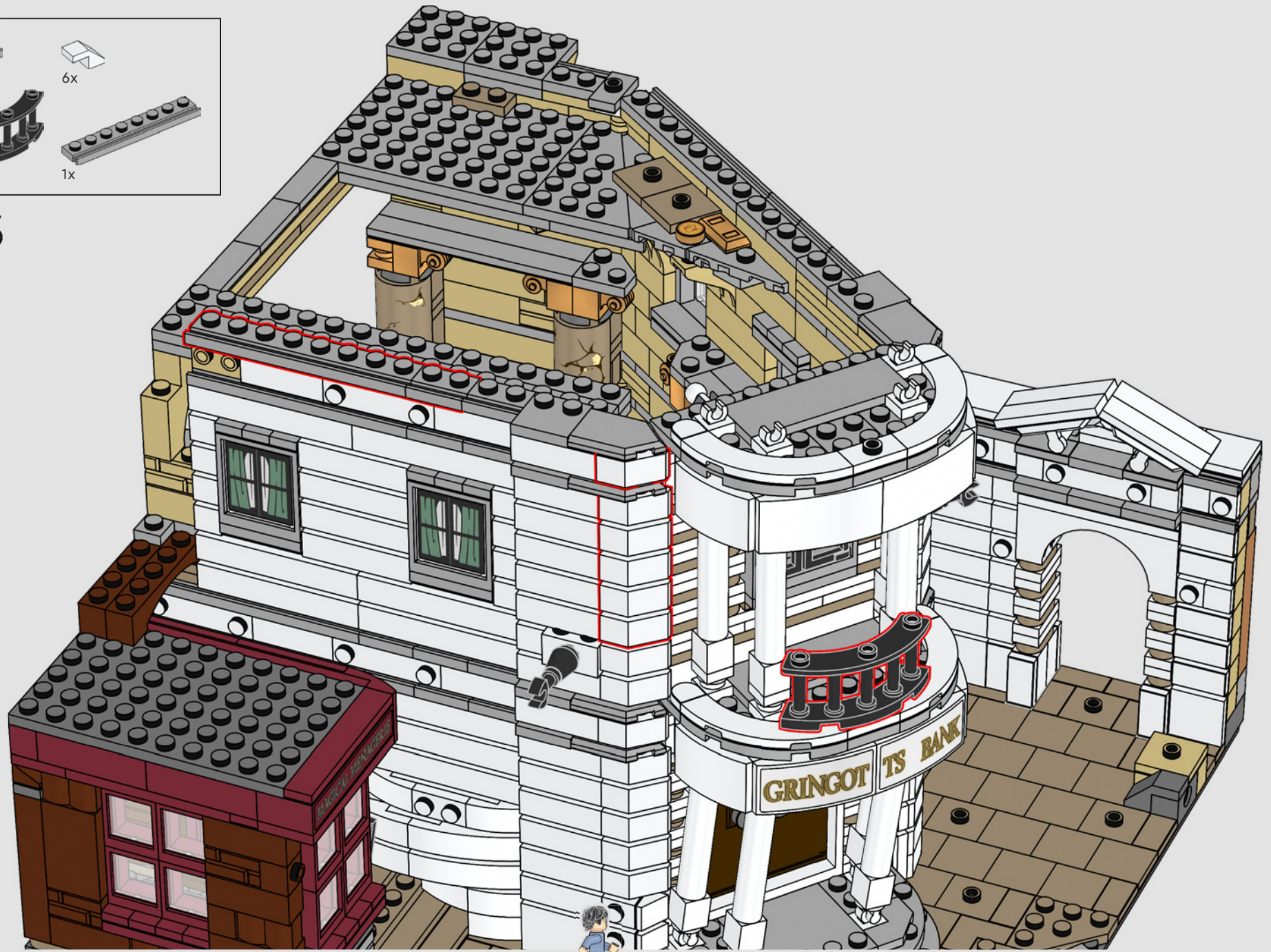

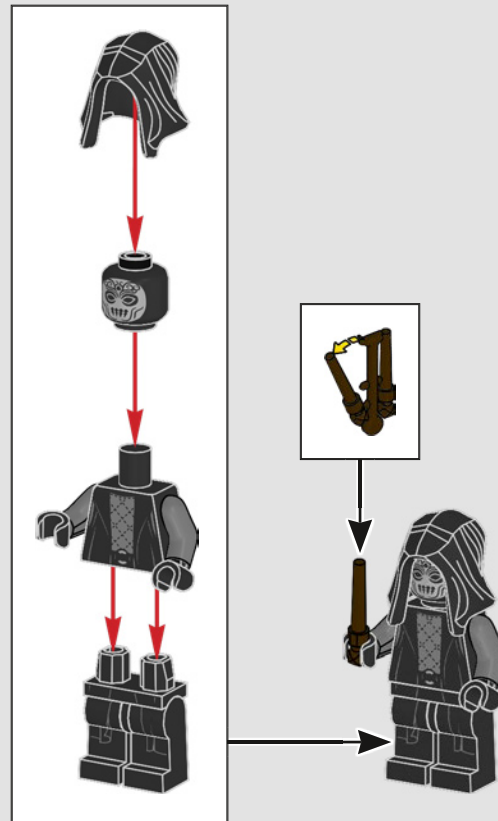
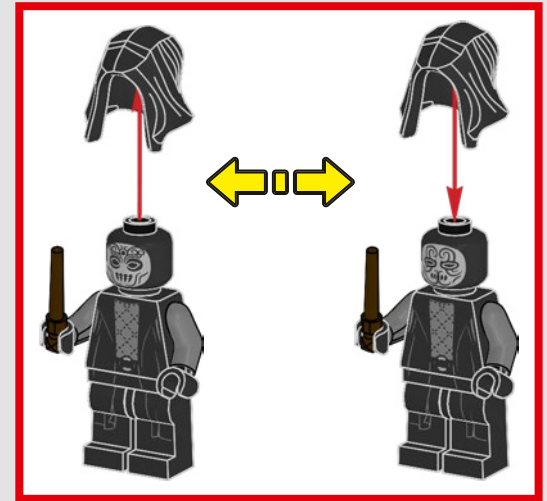

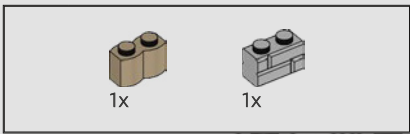

416

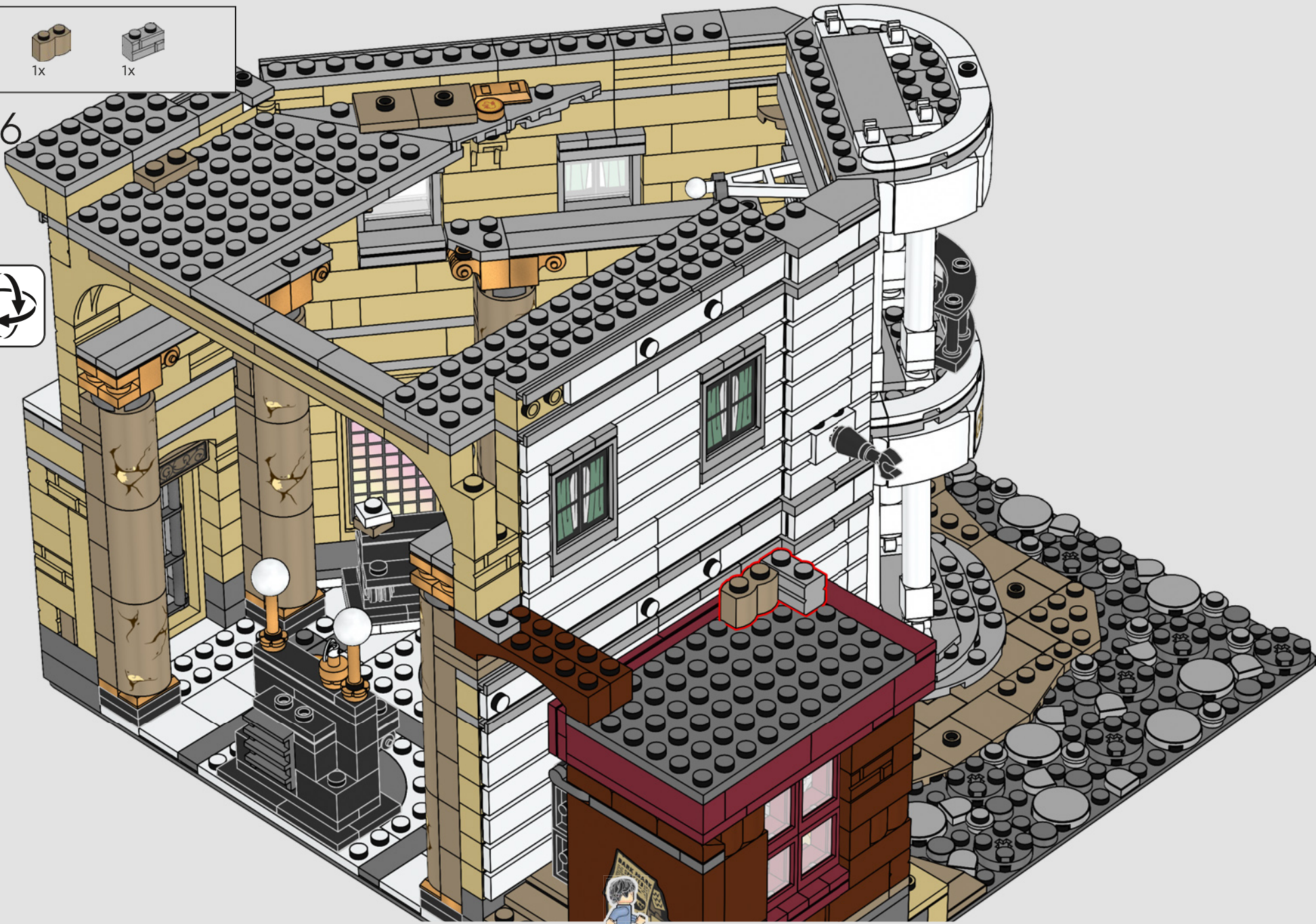

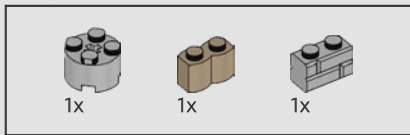

417

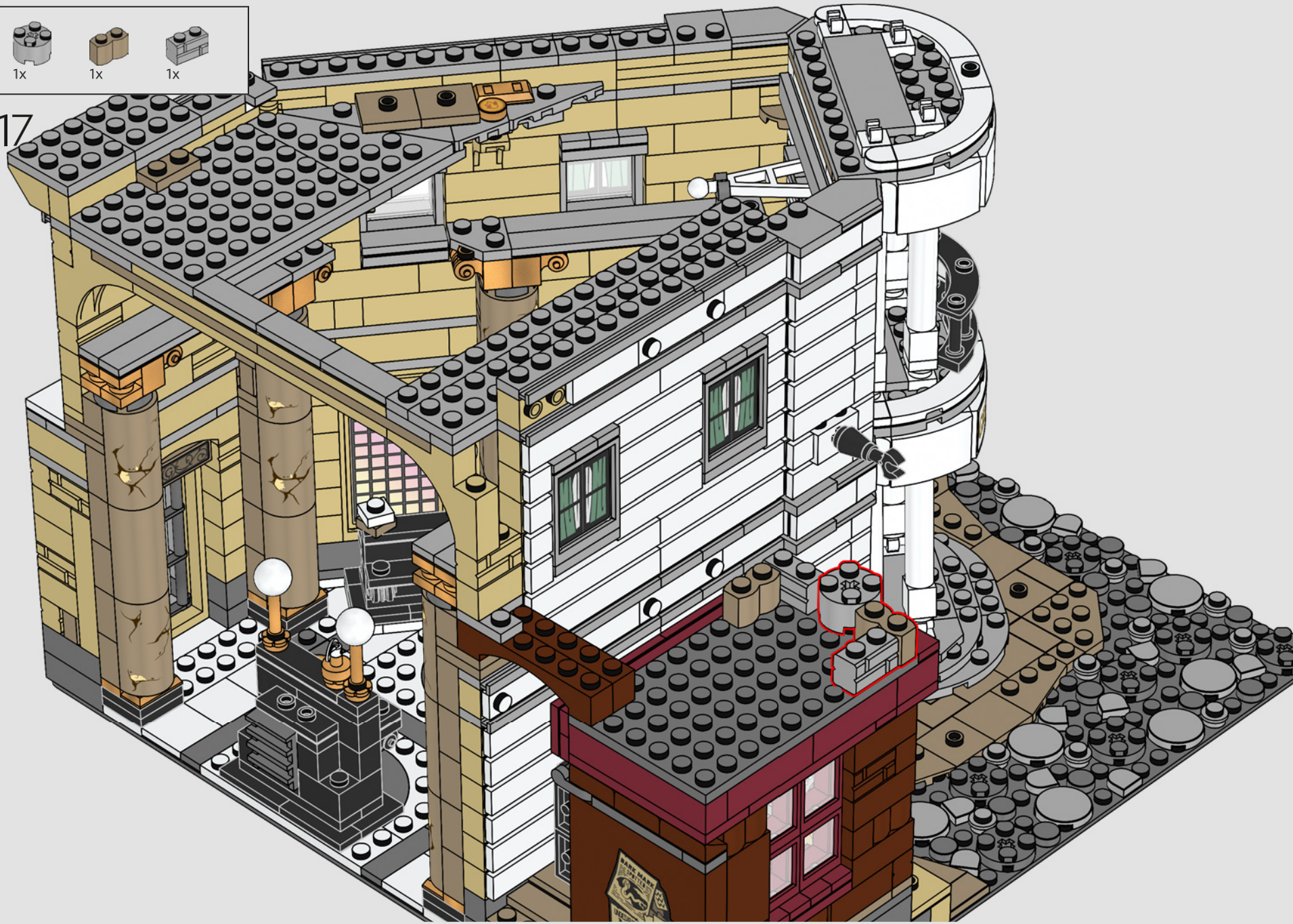

- 2x
- 1x
- 1x

418

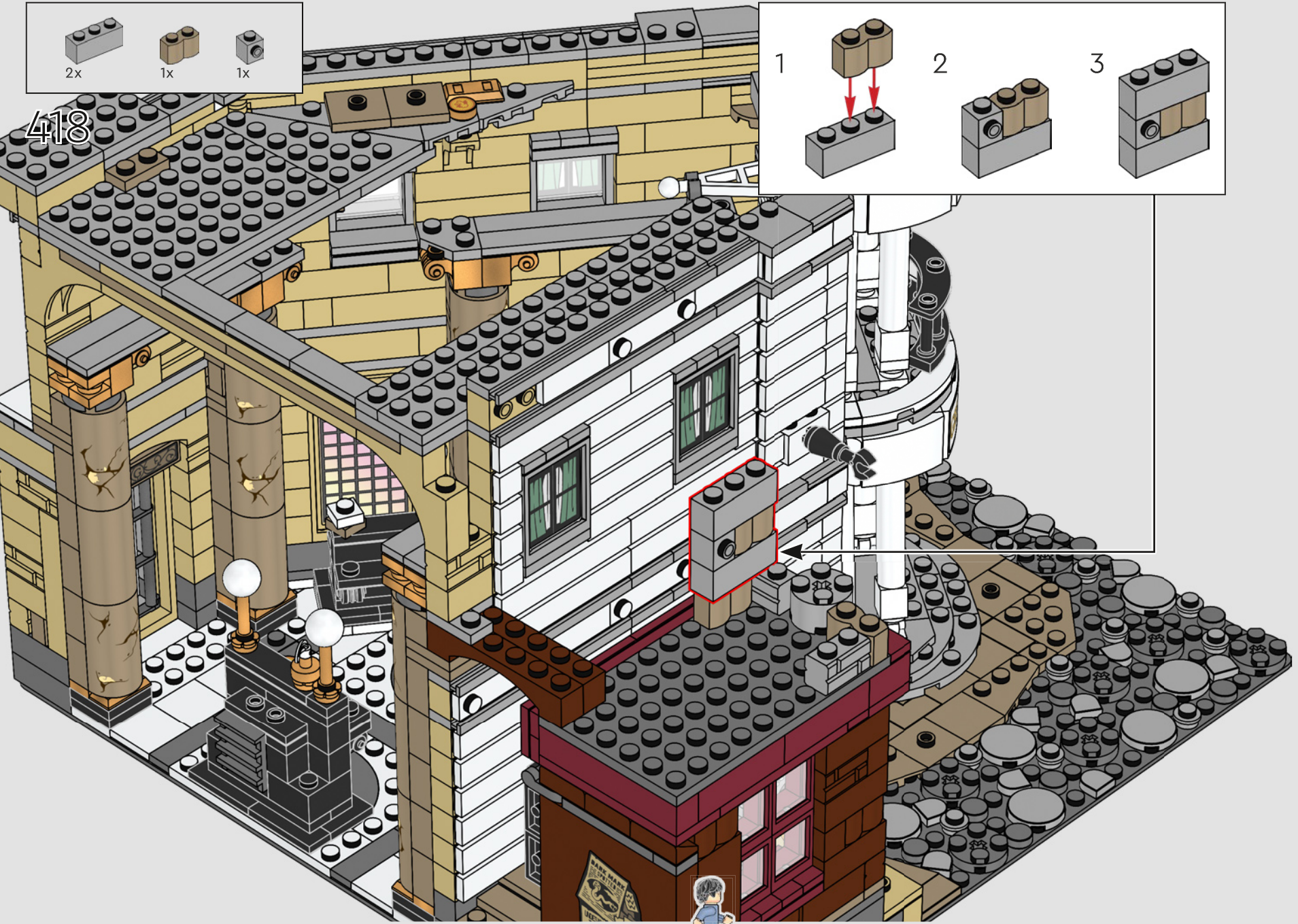
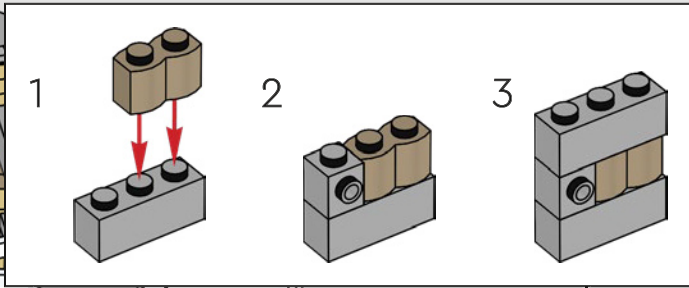



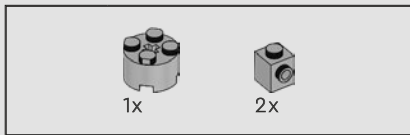

419

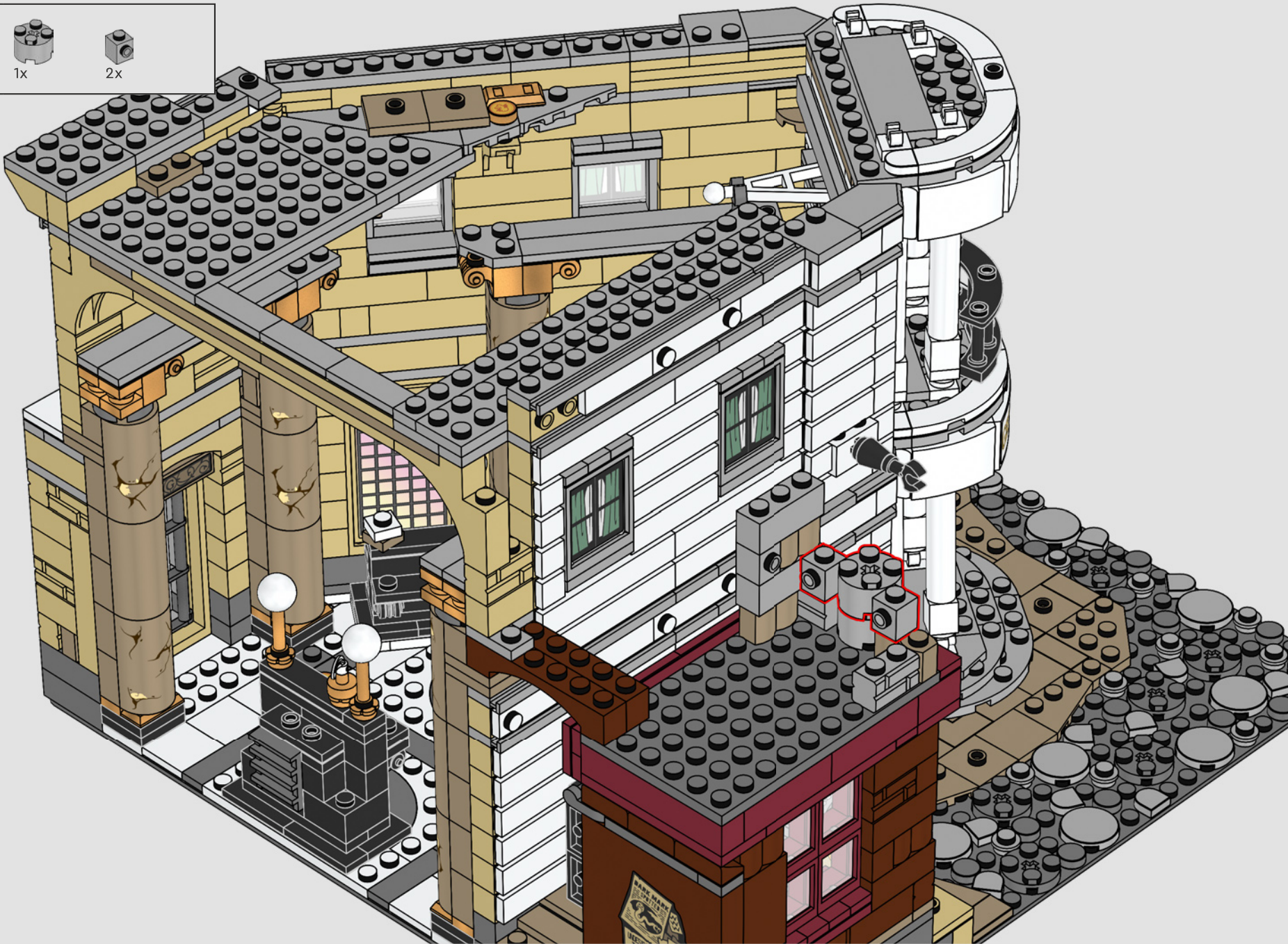

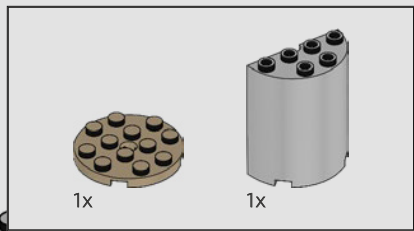

420

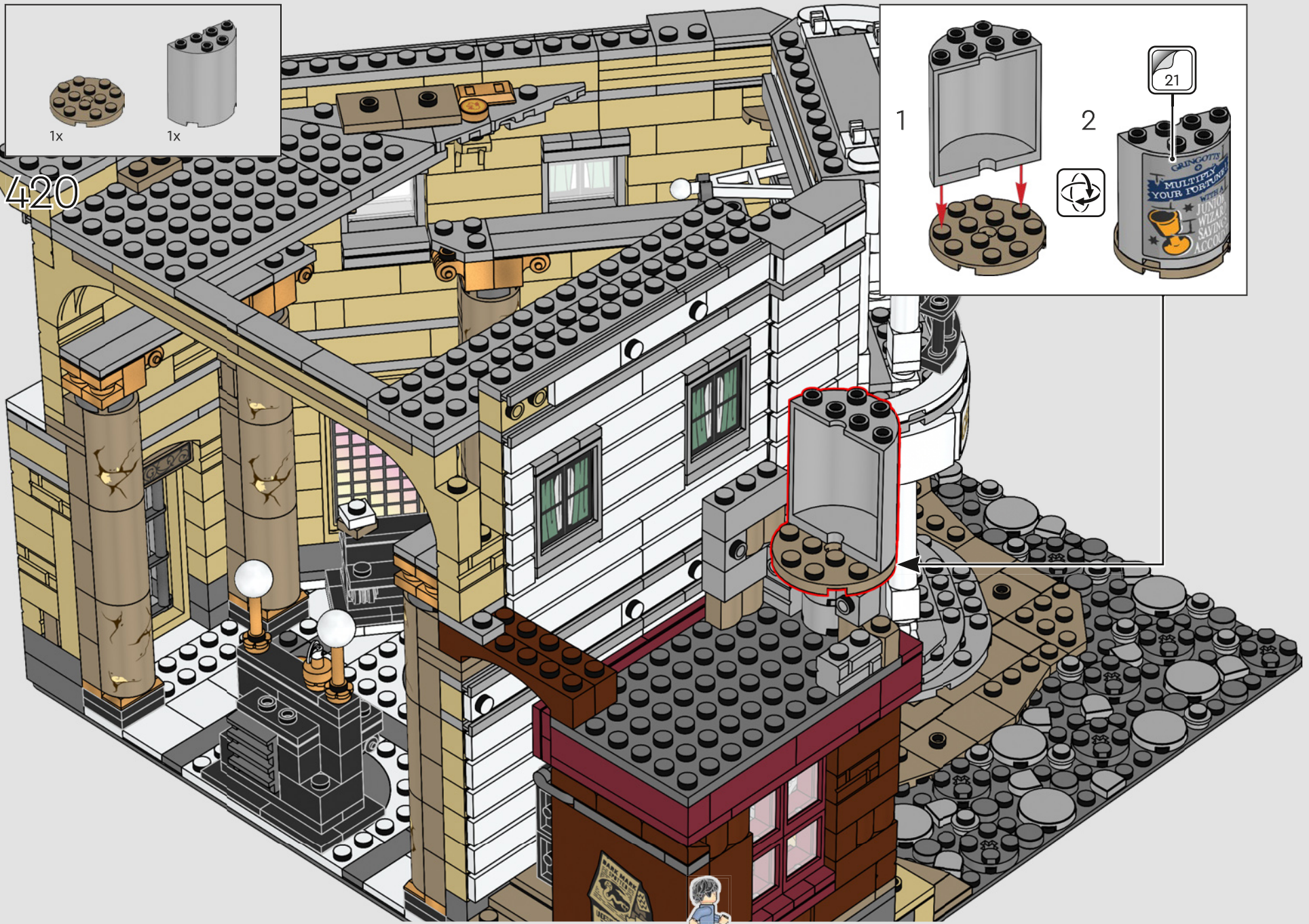
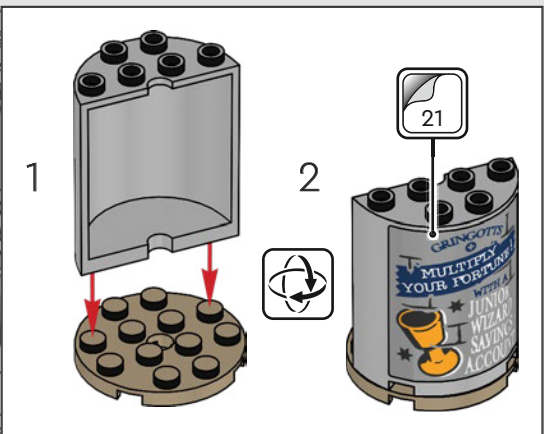

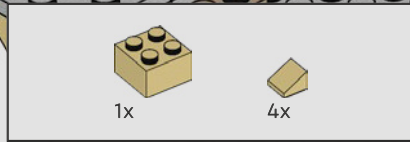

421

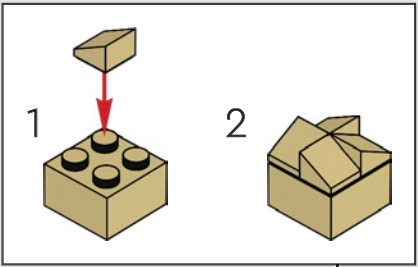



422

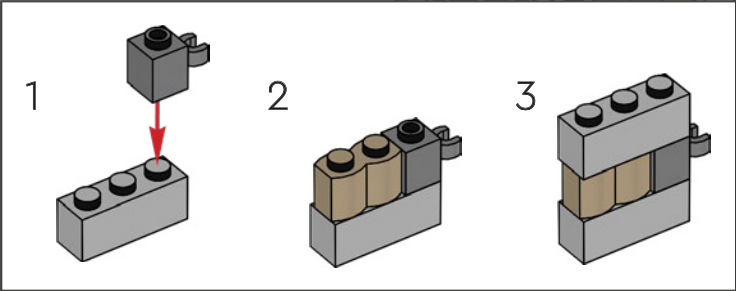

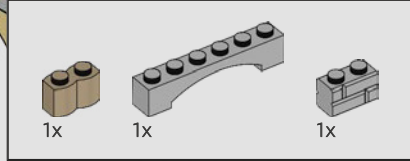

423

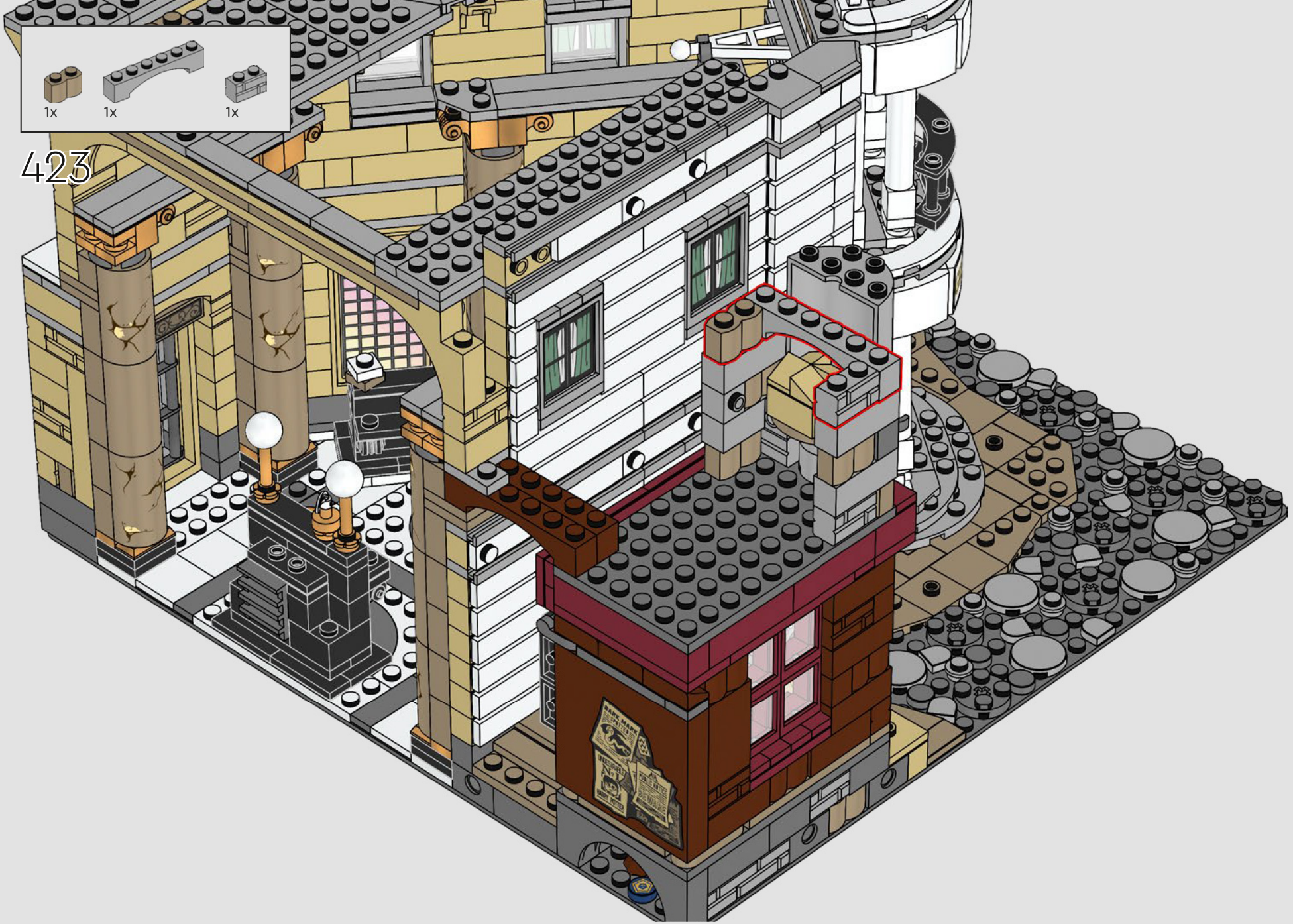

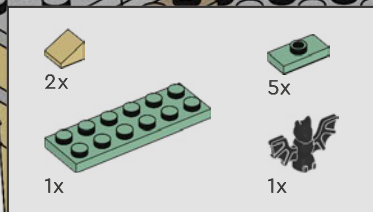

4/24

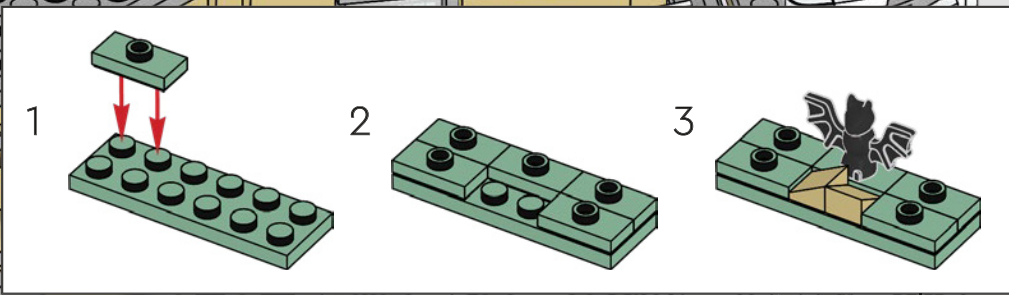

The first LEGO® Gringotts™ Bank featured some iconic details that we love. The vault was capped off with a bat sitting on a sand green jumper plate and, you'll be pleased to hear, that bat is still around today, making its nest on the top floor of the Magical Menagerie. How many other details from the first Gringotts™ Bank can you find in this model?

La première banque LEGO® Gringotts™ présentait des détails emblématiques que nous adorons. La voûte était couronnée par une chauve-souris assise sur une plaque 1×3 vert sable. Encore aujourd'hui, cette chauve-souris continue à faire son nid à l'étage supérieur de la Ménagerie magique. Combien d'autres détails de la première banque Gringotts™ pourrez-vous trouver dans ce modèle ?

El primer banco Gringotts™ LEGO® presentaba algunos detalles icónicos que nos encantan. La bóveda estaba rematada con un murciélago sentado sobre una placa verde arena. Te alegrará saber que ese murciélago sigue existiendo hoy en día haciendo su nido arriba de la tienda de animales mágicos. ¿Cuántos detalles más del primer banco Gringotts™ puedes encontrar en este modelo?



425

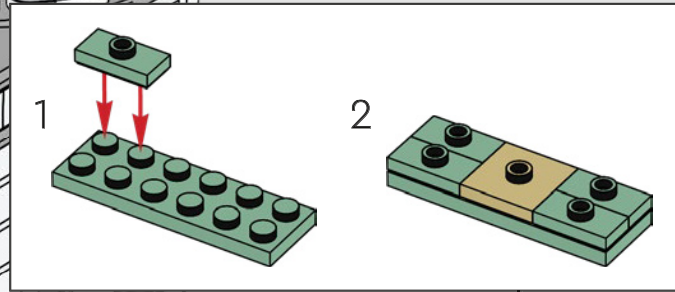
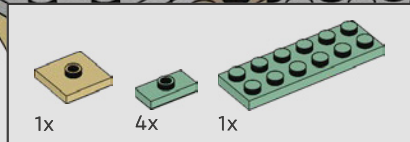



426

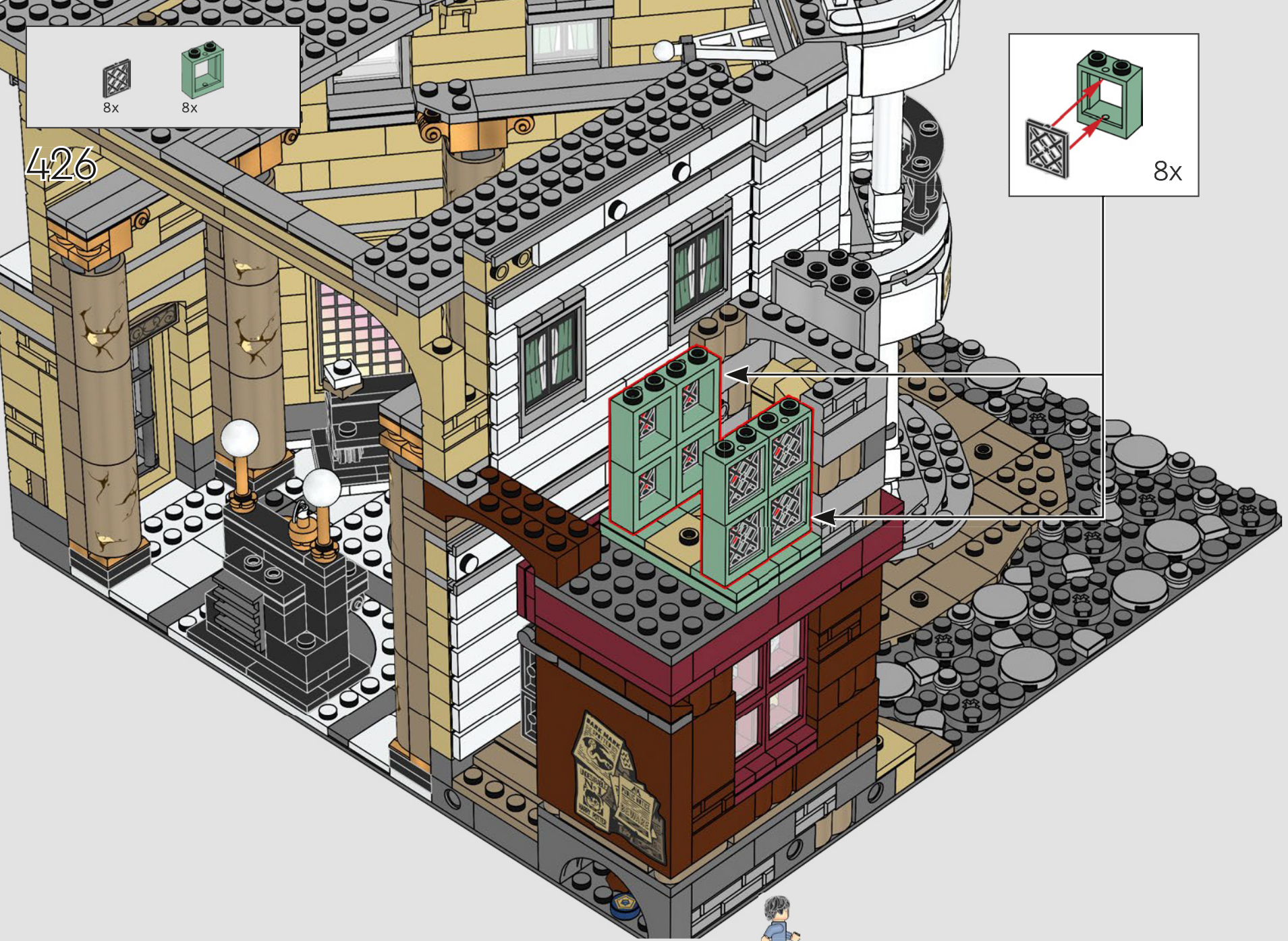
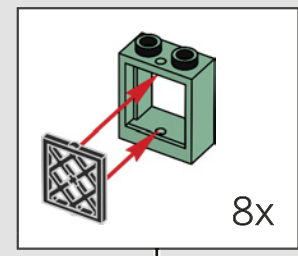





427

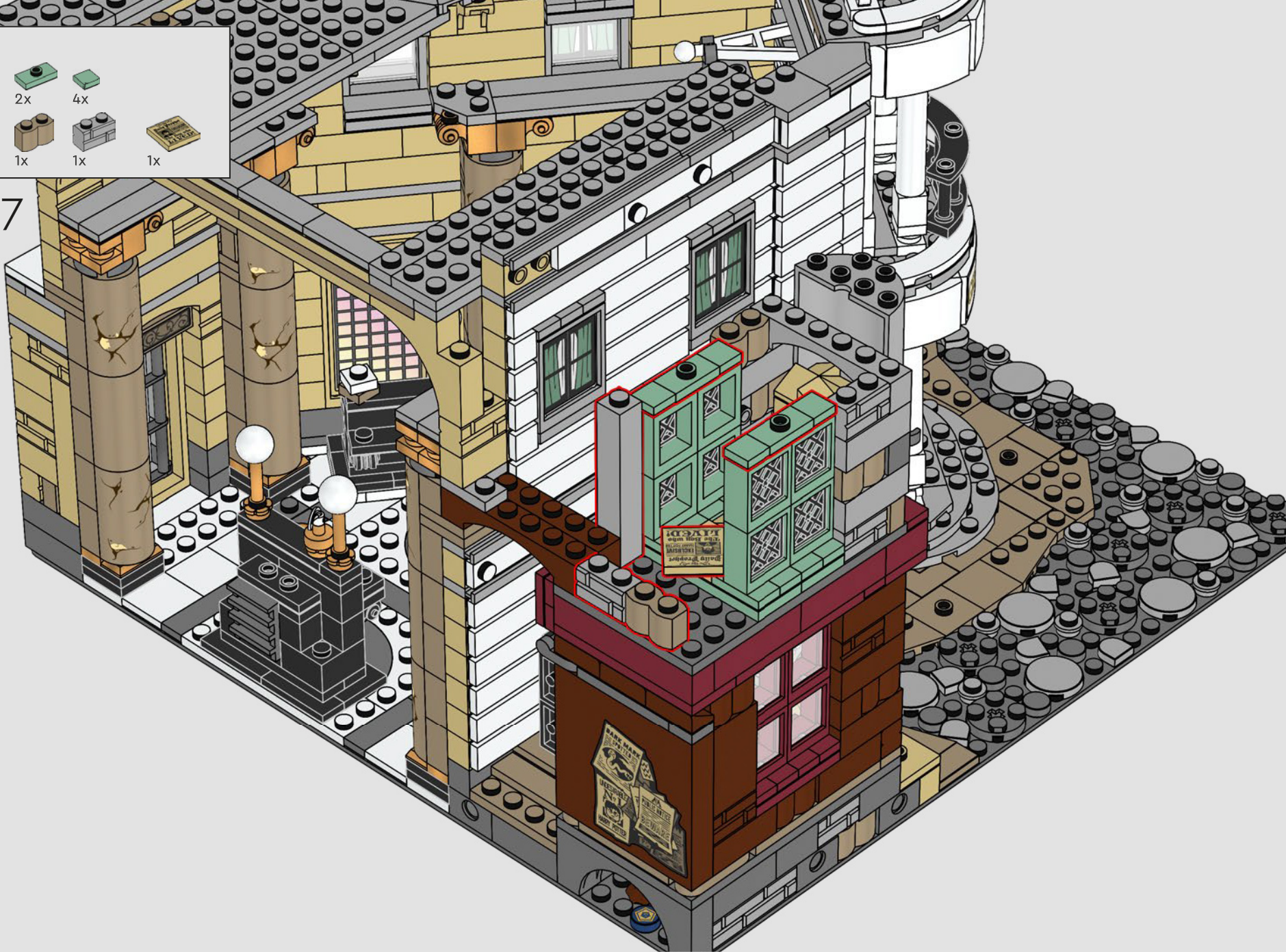

428

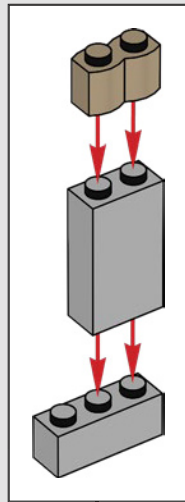

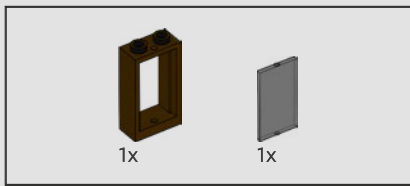

429

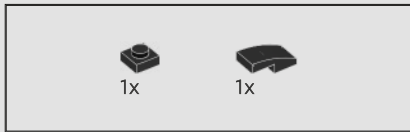
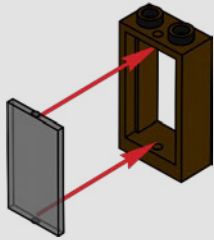

430

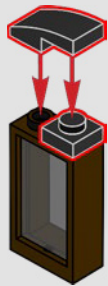

431

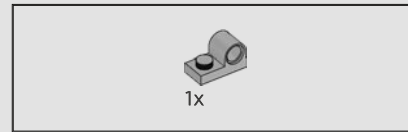
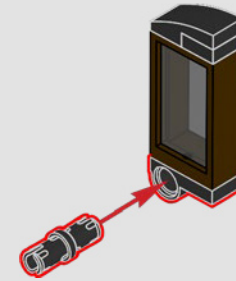

432

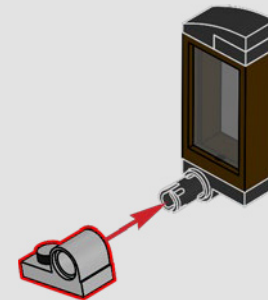

433

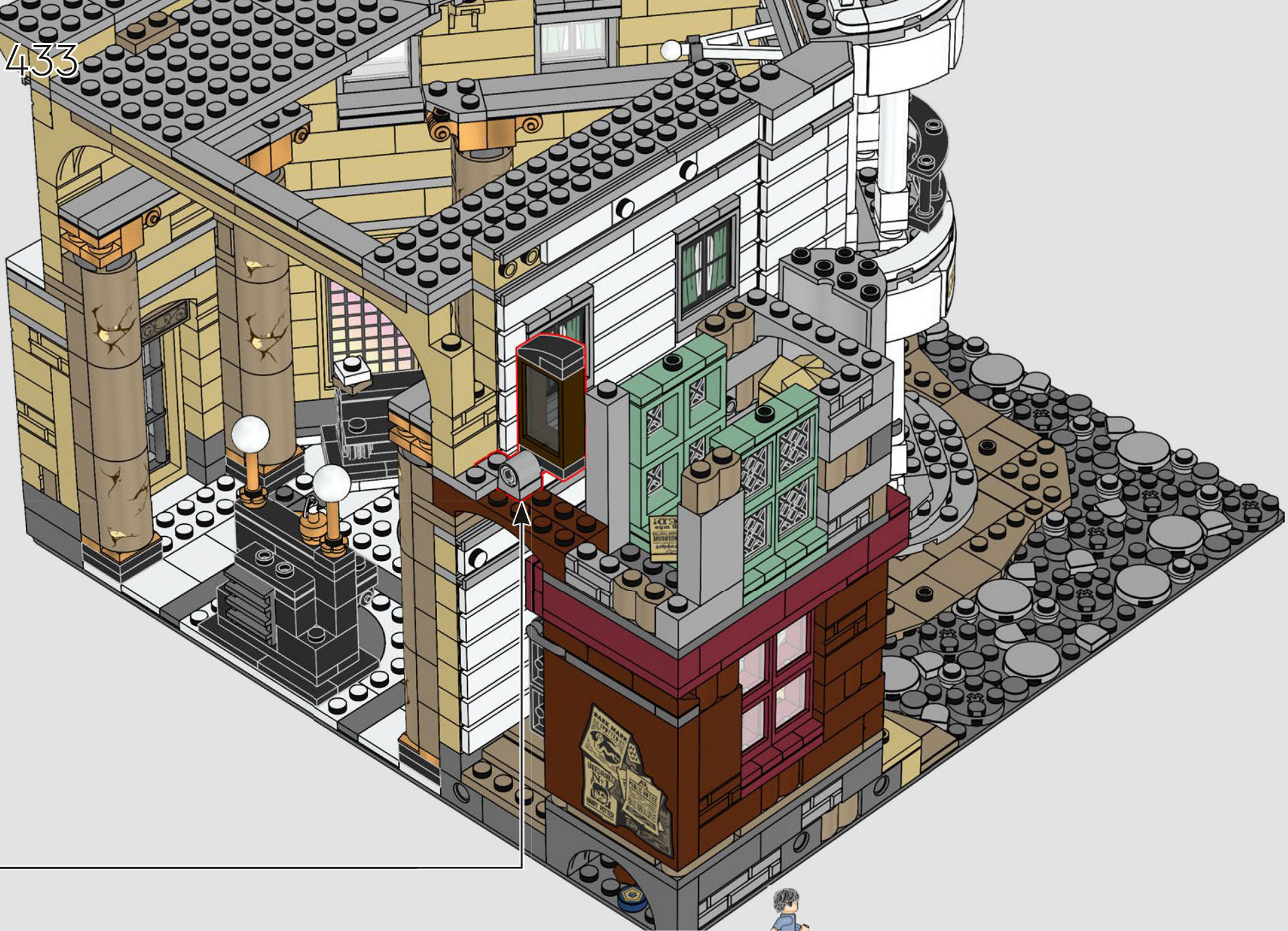

- 1x
- 1x
- 1x

434

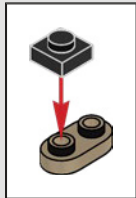
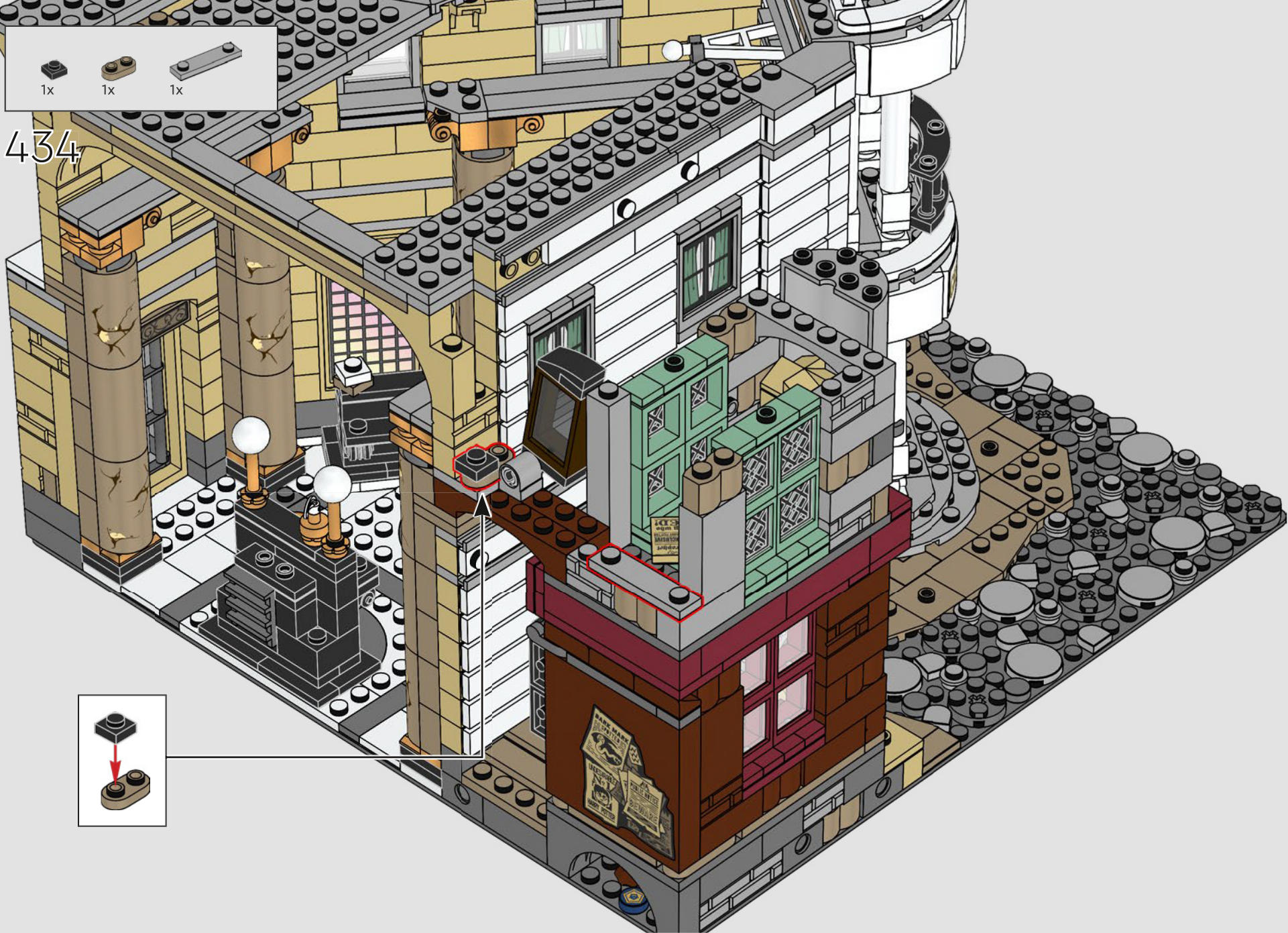

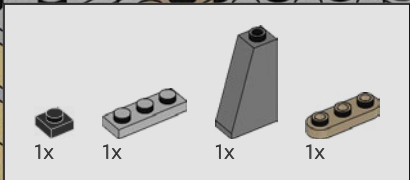

435

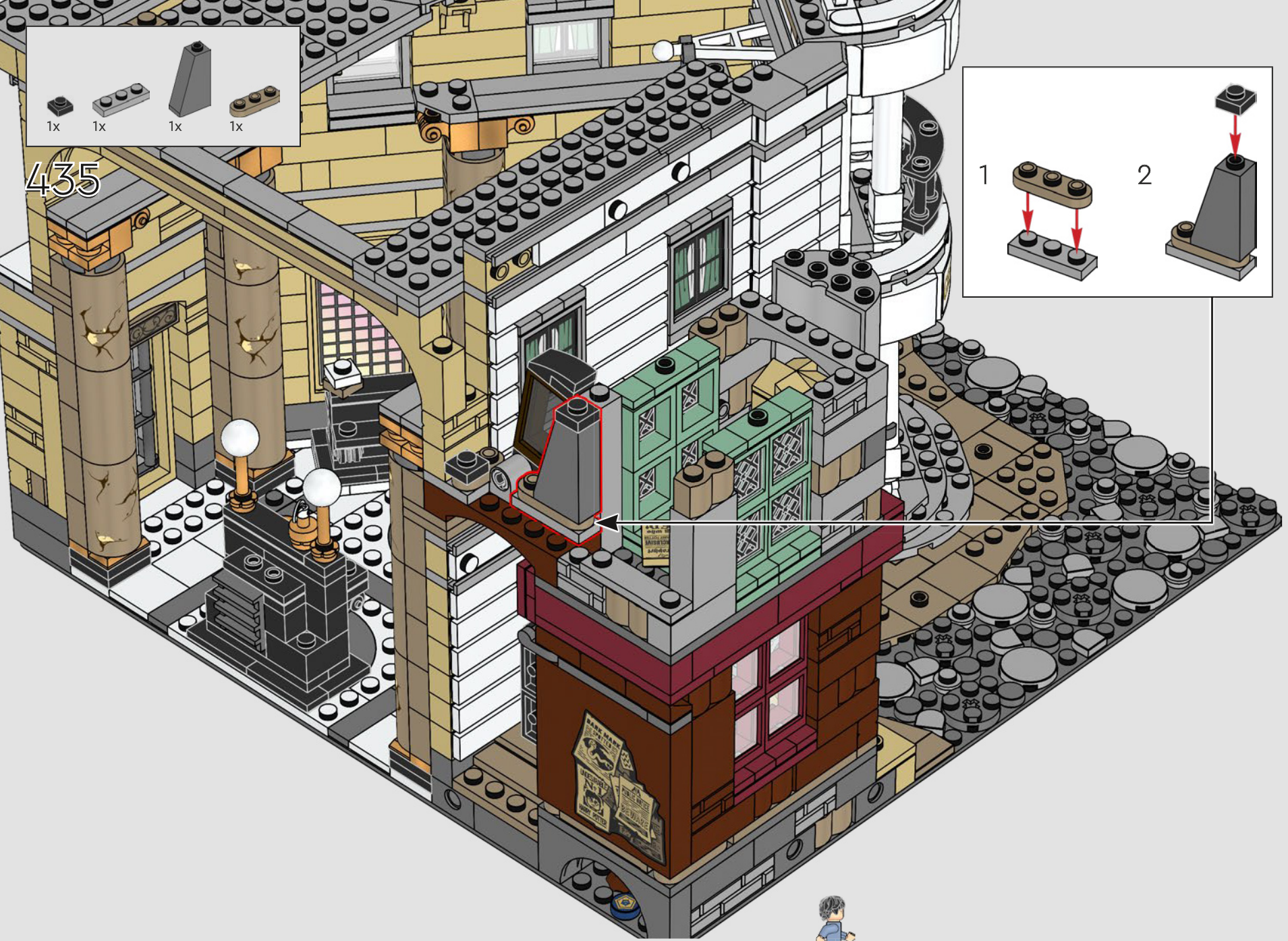
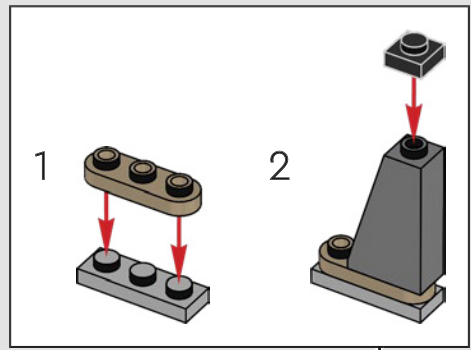



436

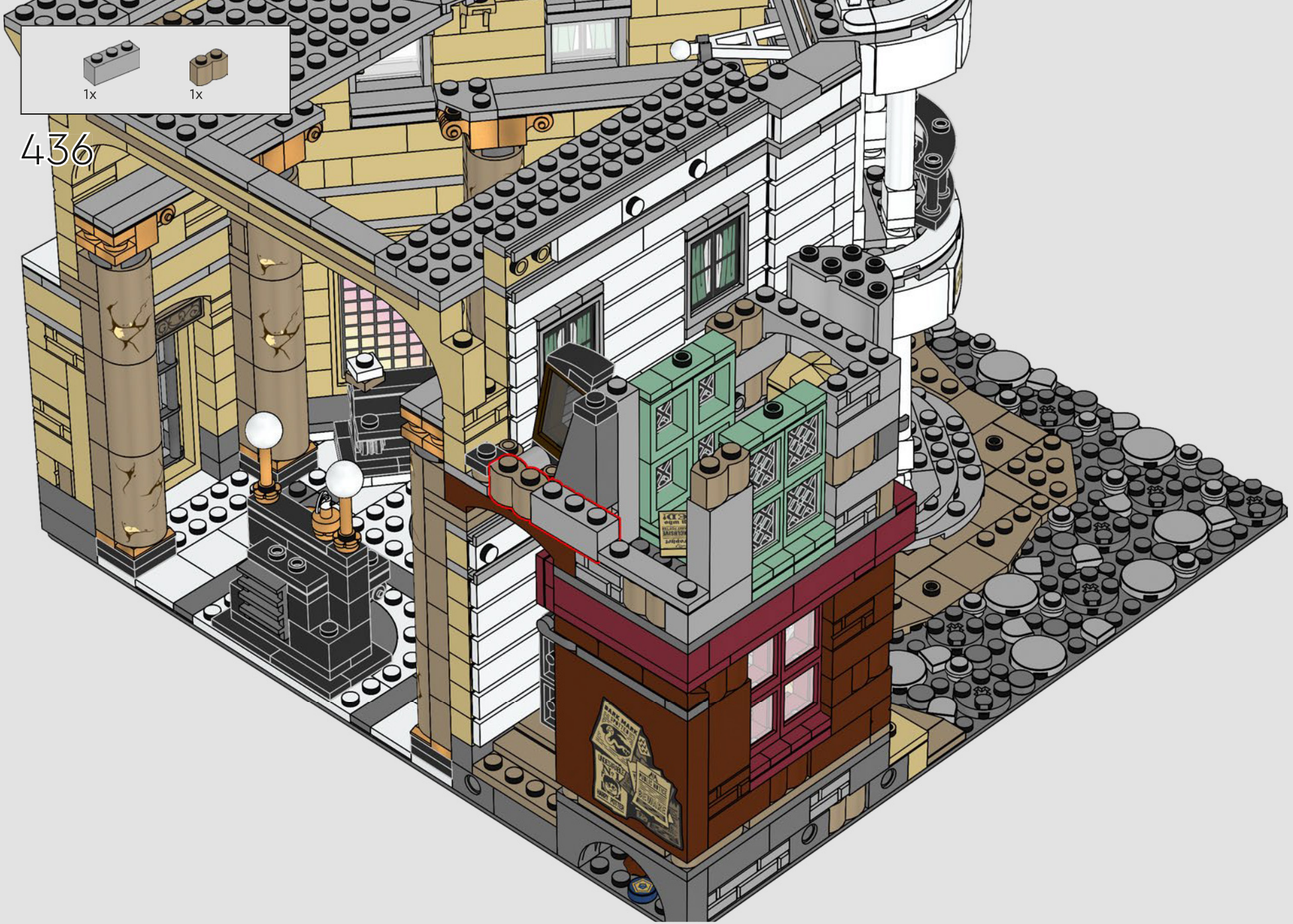

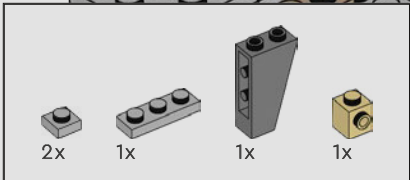

437

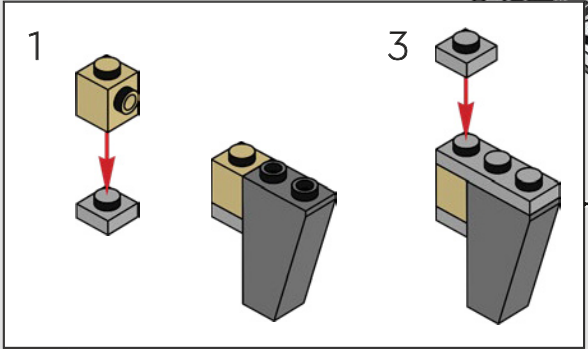



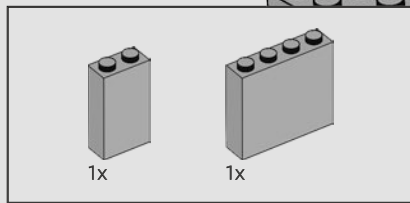

438

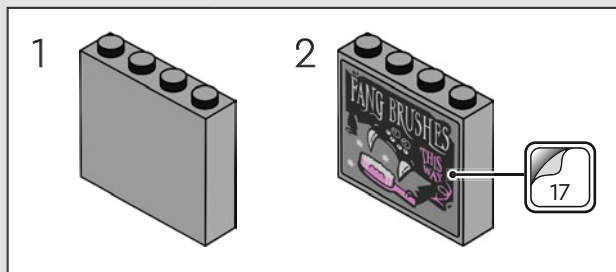
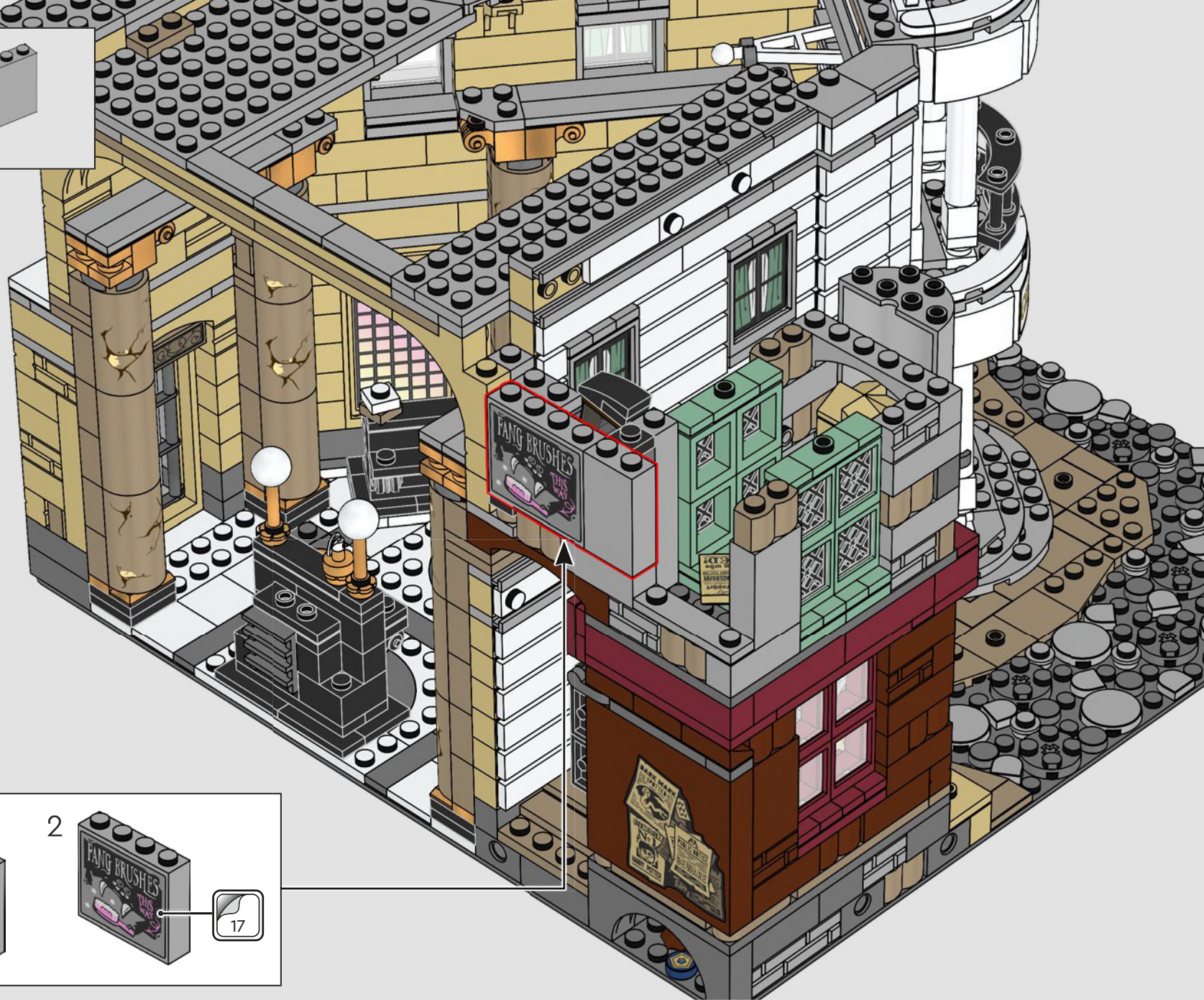

439

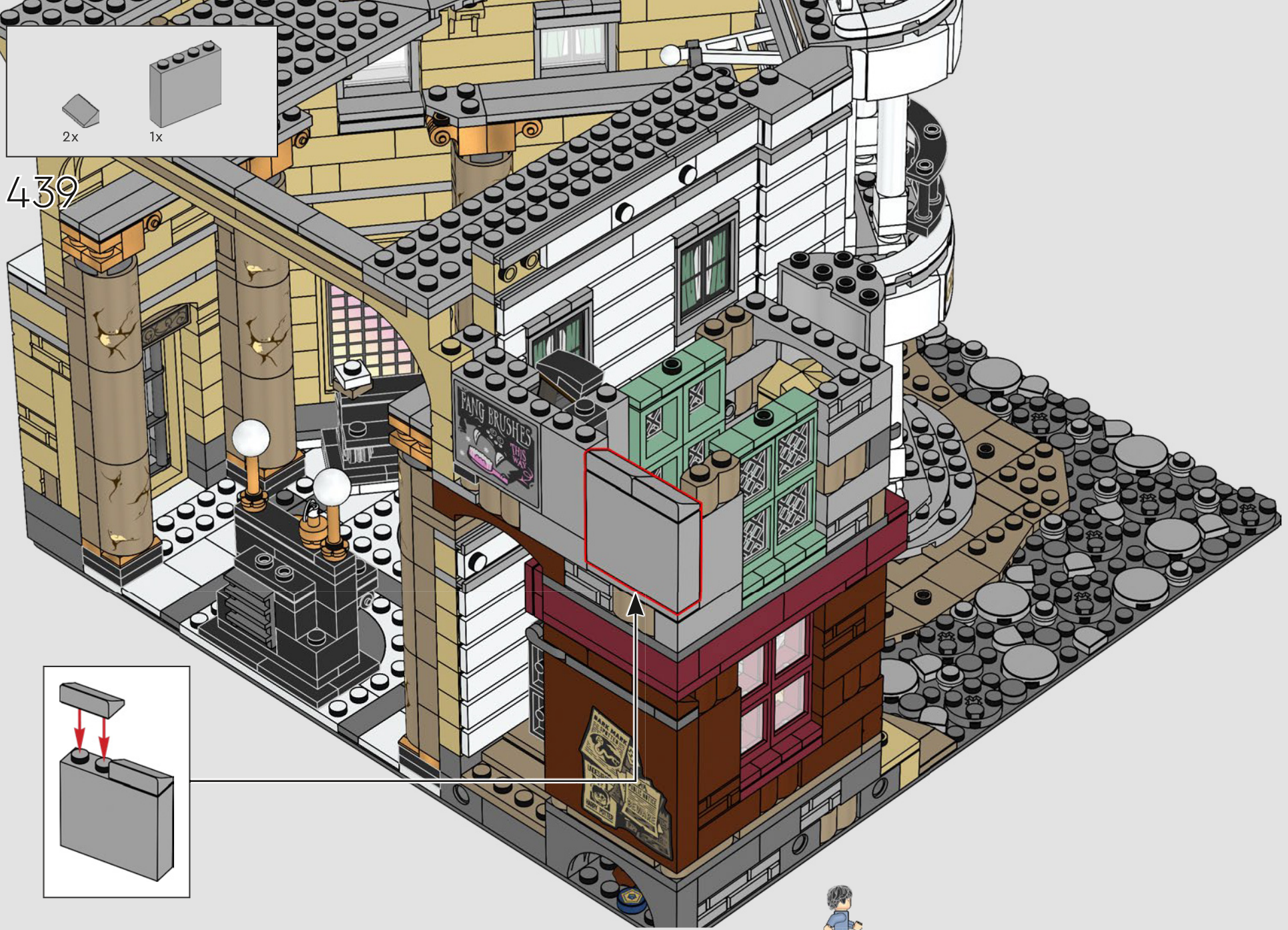
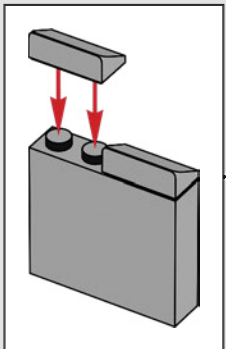
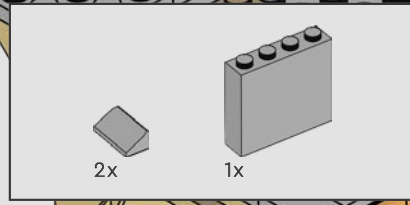

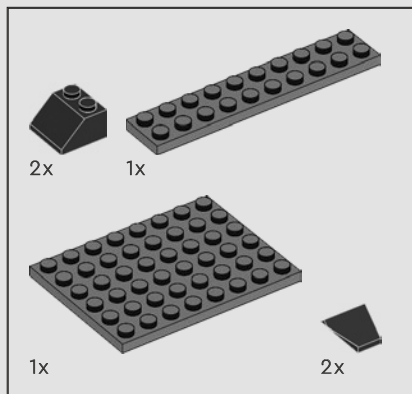

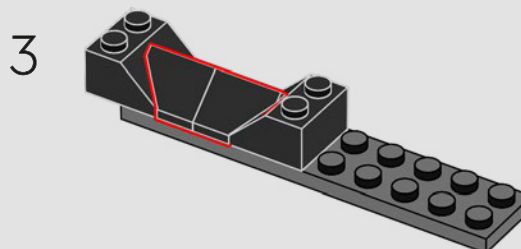
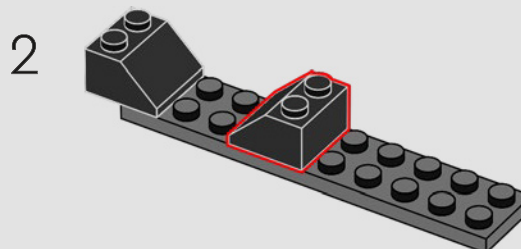
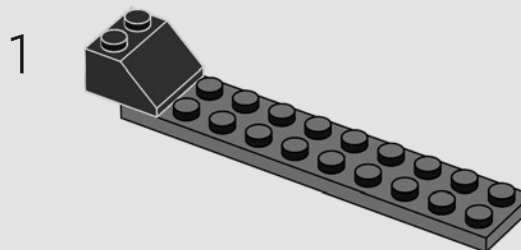

440

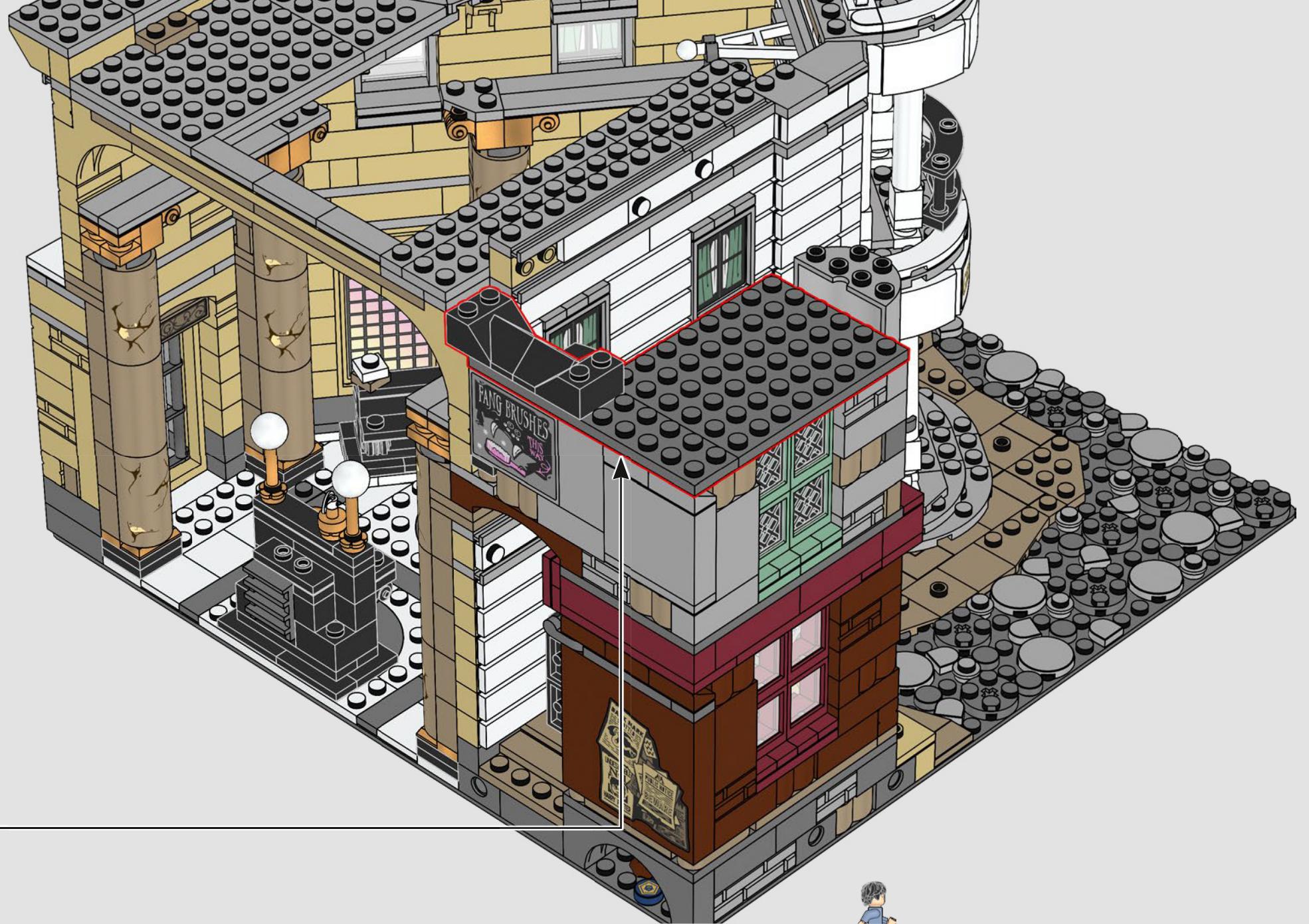



- 2x 
- 2x 

441

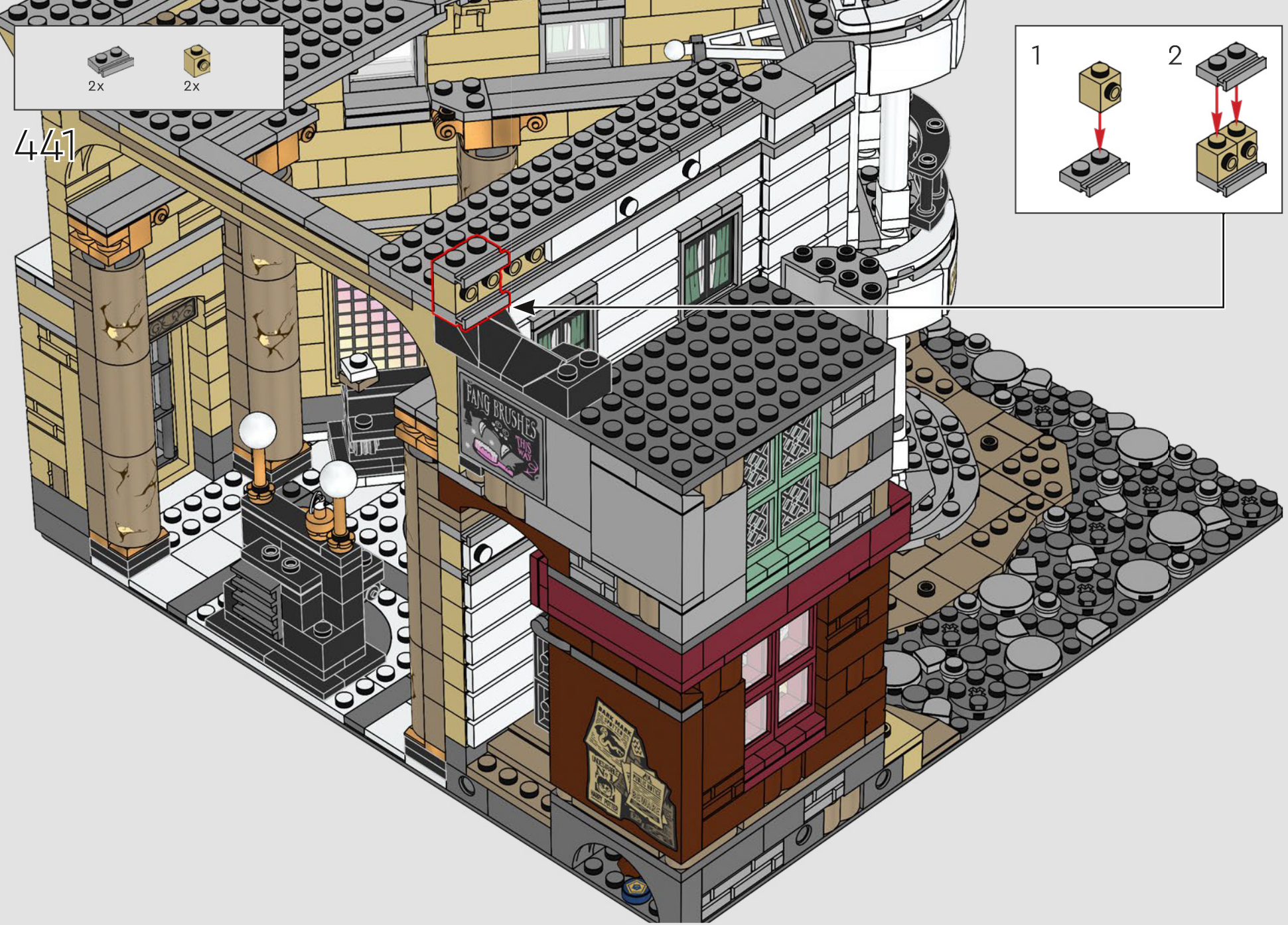
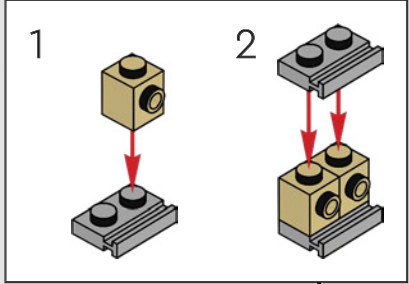



442





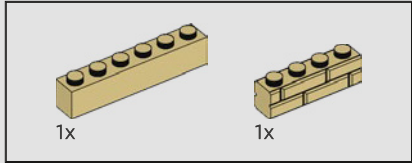
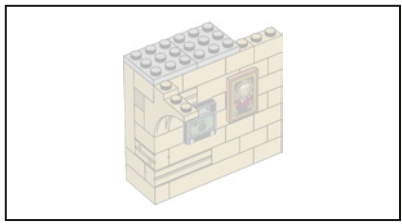

443

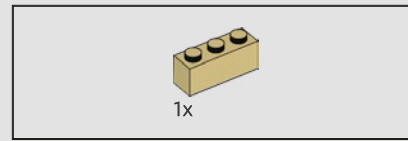
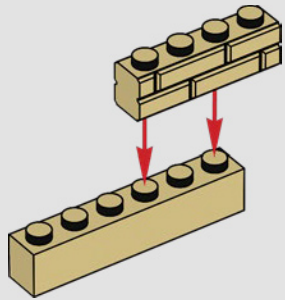

444

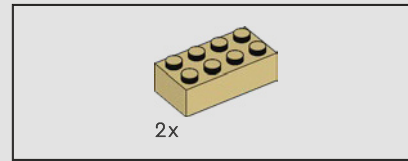
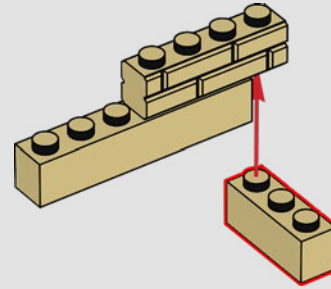

445

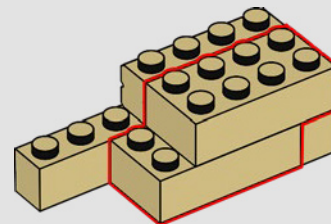
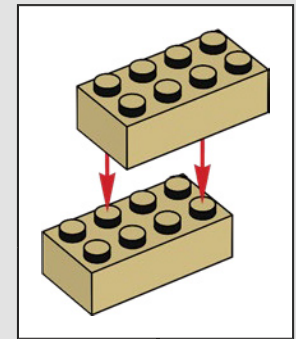



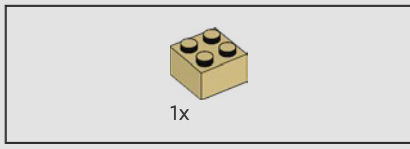

446

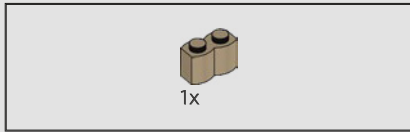
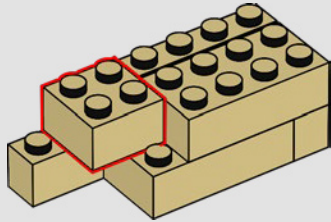

447

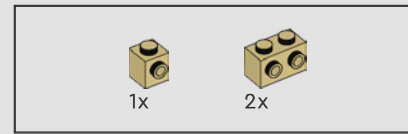
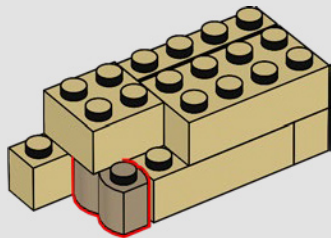

448

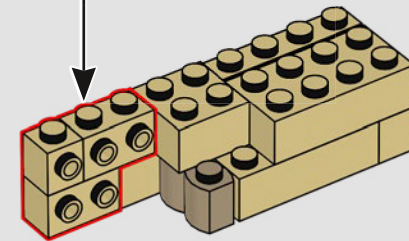
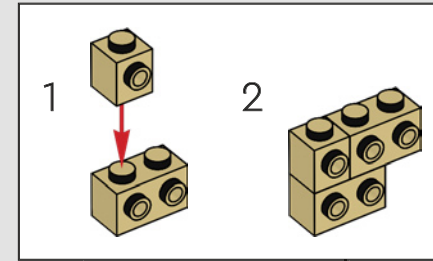

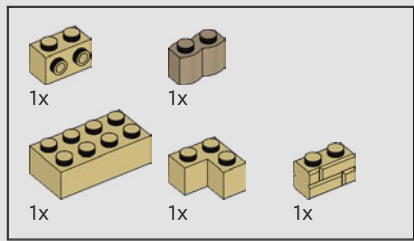

449

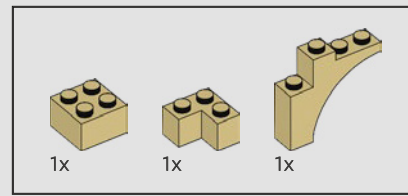
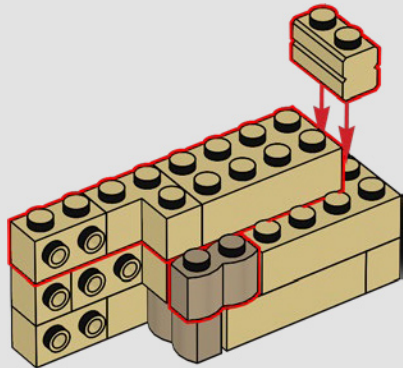

450

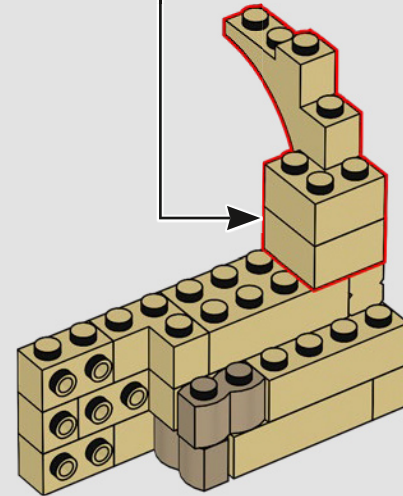
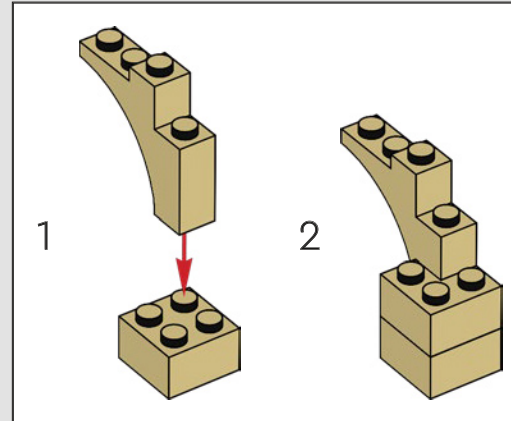

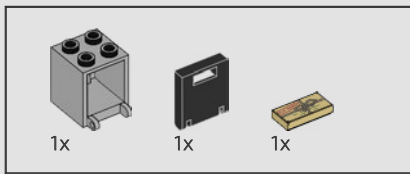

451

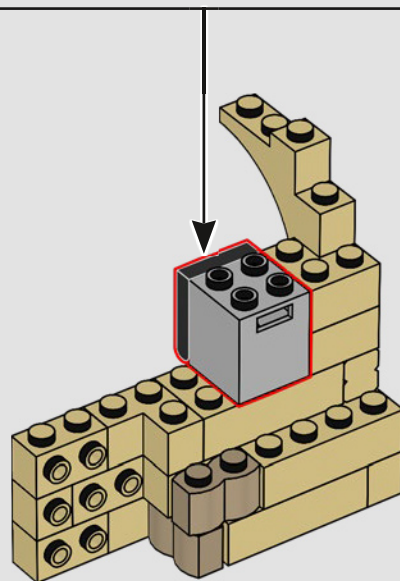
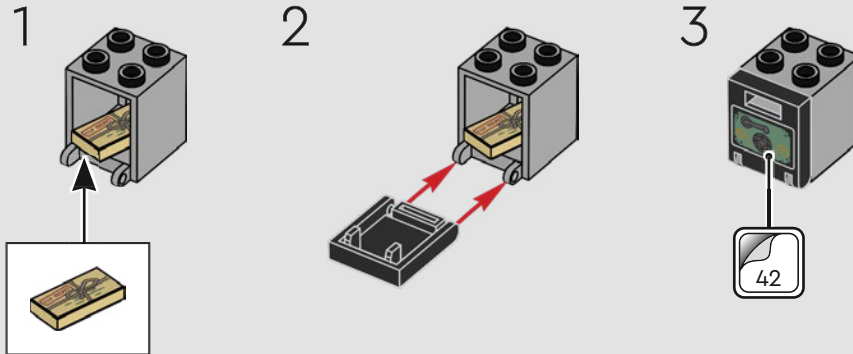

Hidden inside the wall on the mezzanine floor is a safe containing the TOP SECRET letter Hagrid™ delivers from Albus Dumbledore™ as he picks up the you-know-what from vault you-know-which.

Caché dans le mur de la mezzanine se trouve un coffre contenant la lettre ultrasecrète d'Albus Dumbledore™, que Hagrid™ remet lorsqu'il récupère le vous-savez-quoi du coffre vous-savez-lequel.

Oculto en el interior de la pared del entresuelo hay una caja fuerte que contiene la carta ULTRASECRETA de Albus Dumbledore™ que Hagrid™ entrega al recoger lo-que-tú-sabes de la-bóveda-que-tú-sabes.



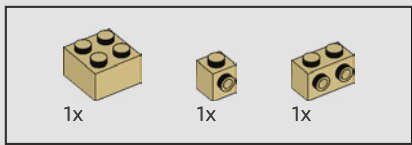

452

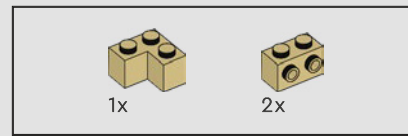
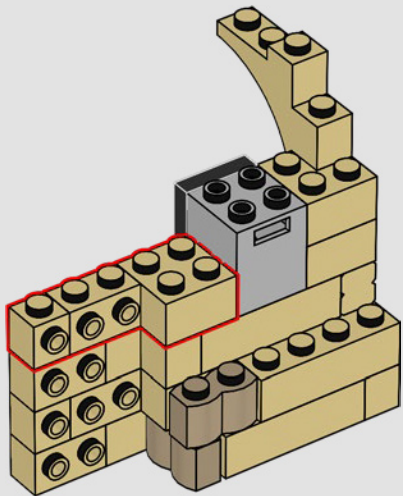

453

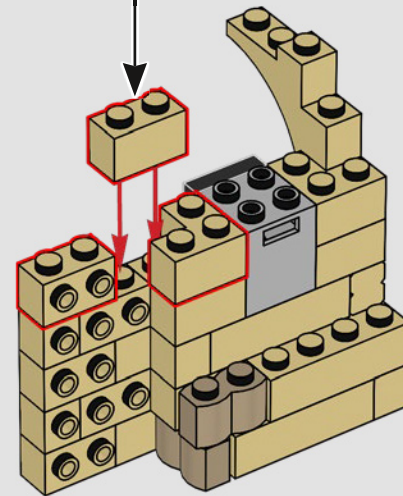
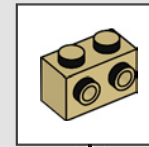

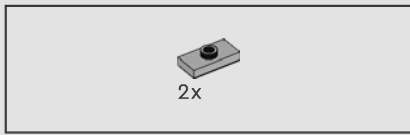

454

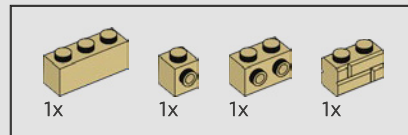
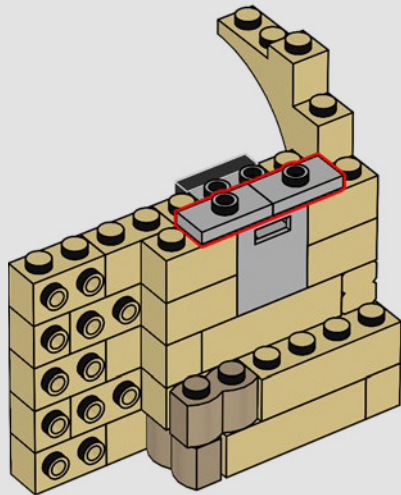

455

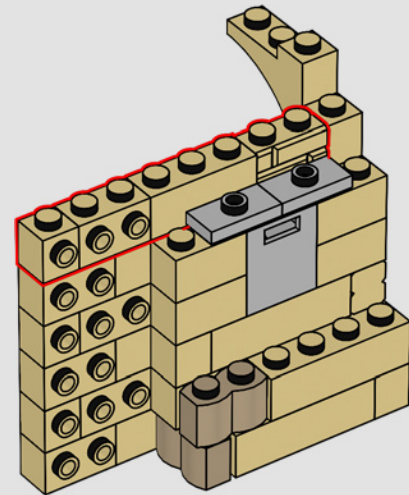



456

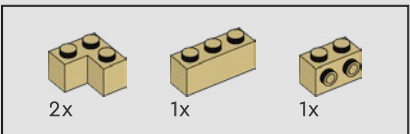
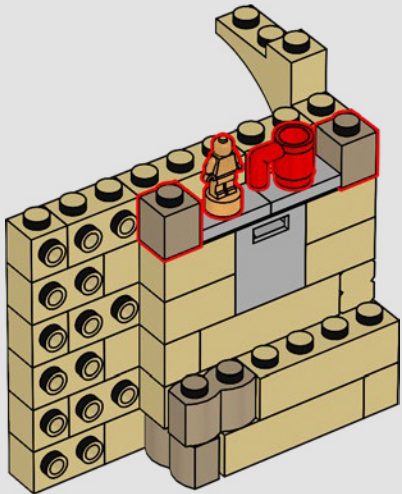

457

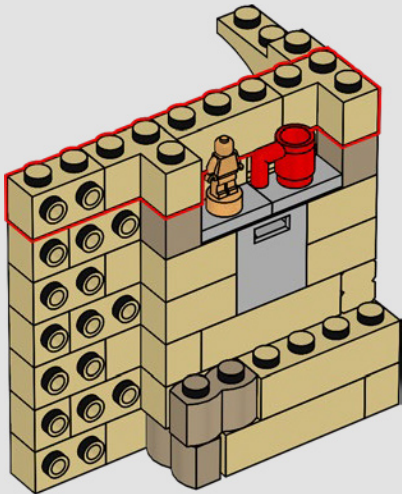

Looks like a goblin left their cup here while the bank was being built. Maybe it's time to put the kettle on and take a well-earned break?

On dirait qu'un gobelin a laissé sa tasse ici pendant la construction de la banque. Il est peut-être temps de préparer la bouilloire et de prendre une pause bien méritée ?

Parece que un duende dejó su taza aquí mientras se construía el banco. Quizá sea hora de poner la tetera al fuego y tomarse un merecido descanso...



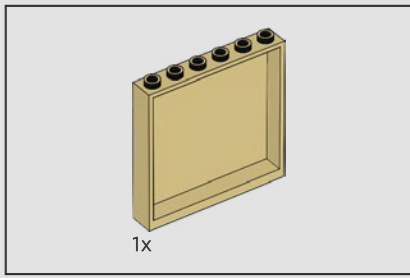

458



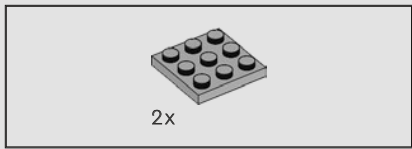

459

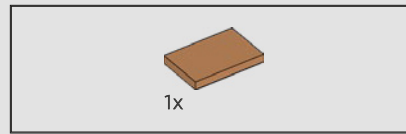
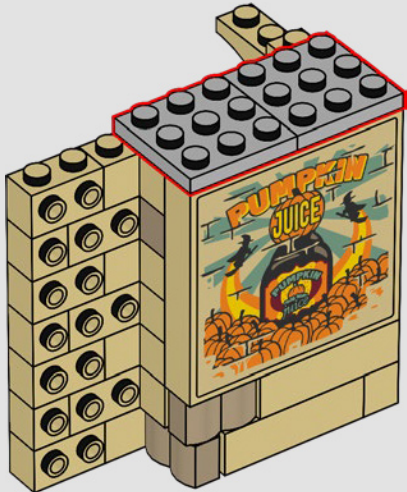



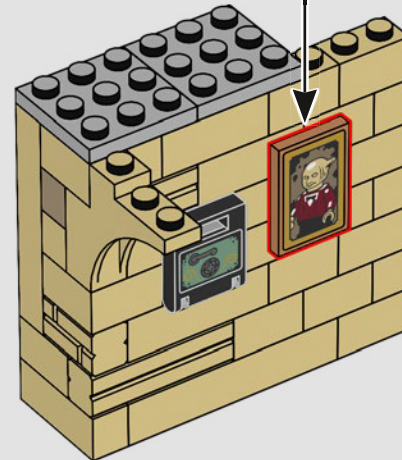
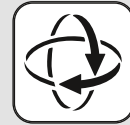
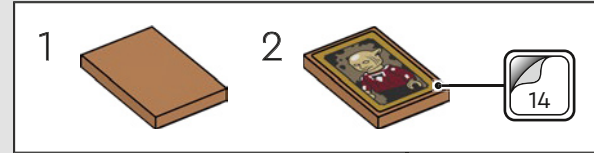

460





461



-  1x
-  1x
-  1x
-  1x

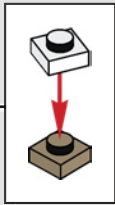

462

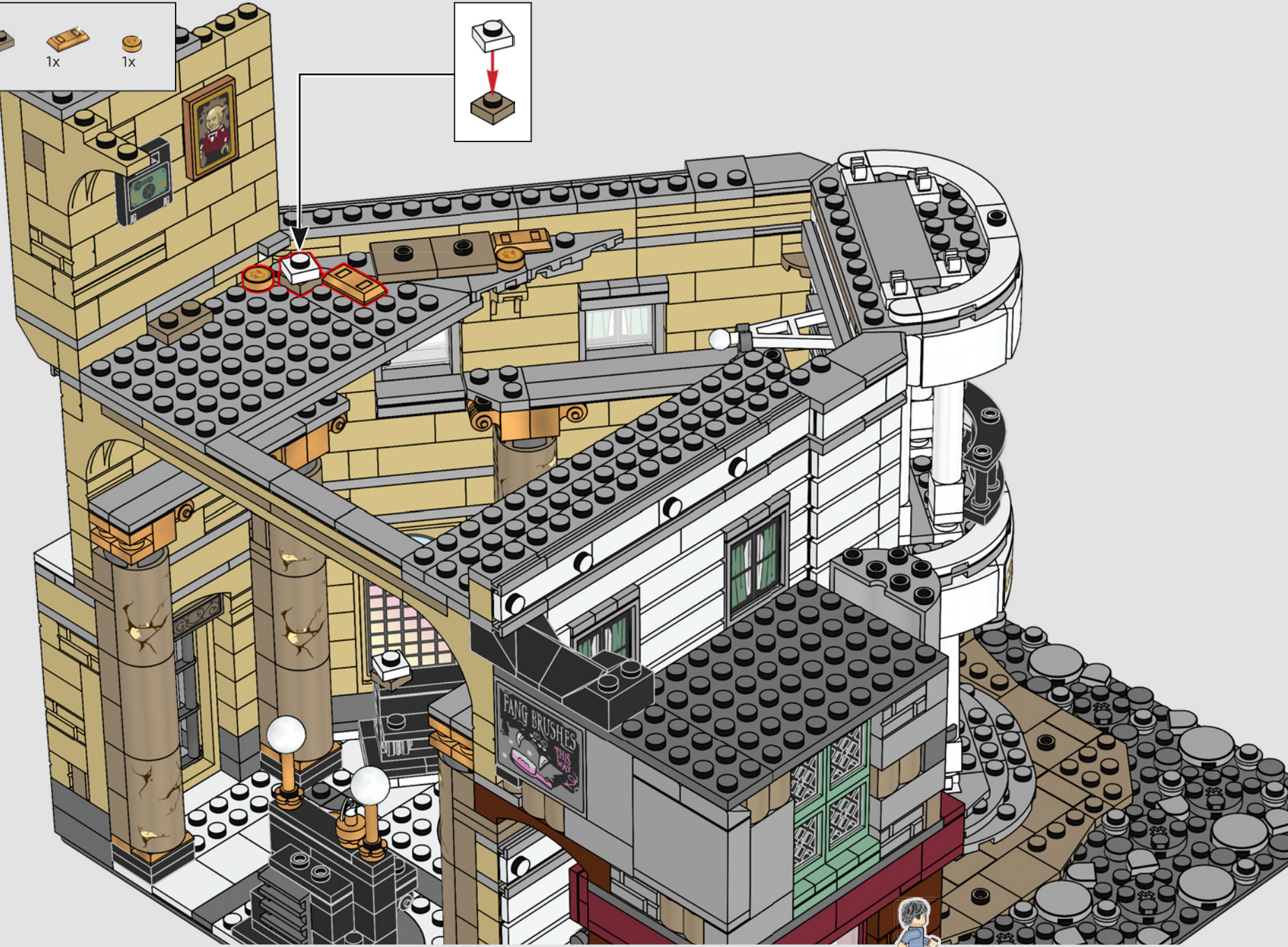

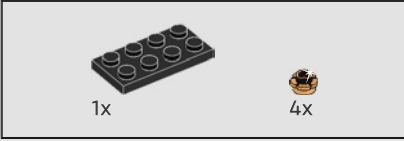

463

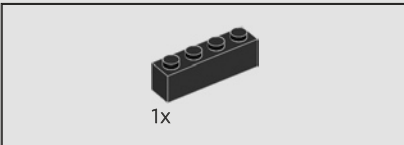
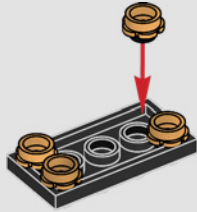

464

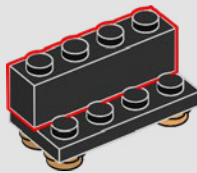

465

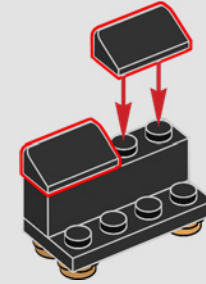

466

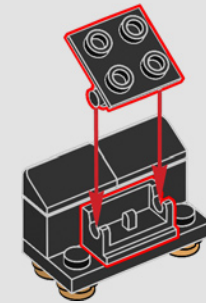

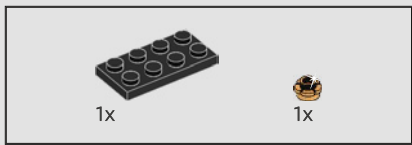

467

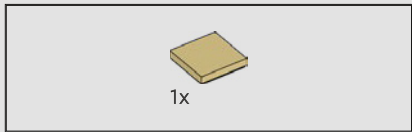
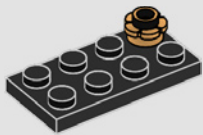

468

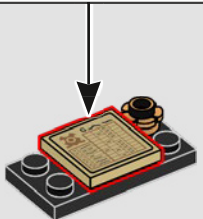

469

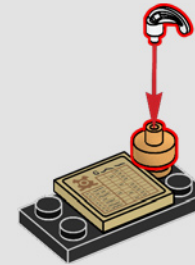

470



471

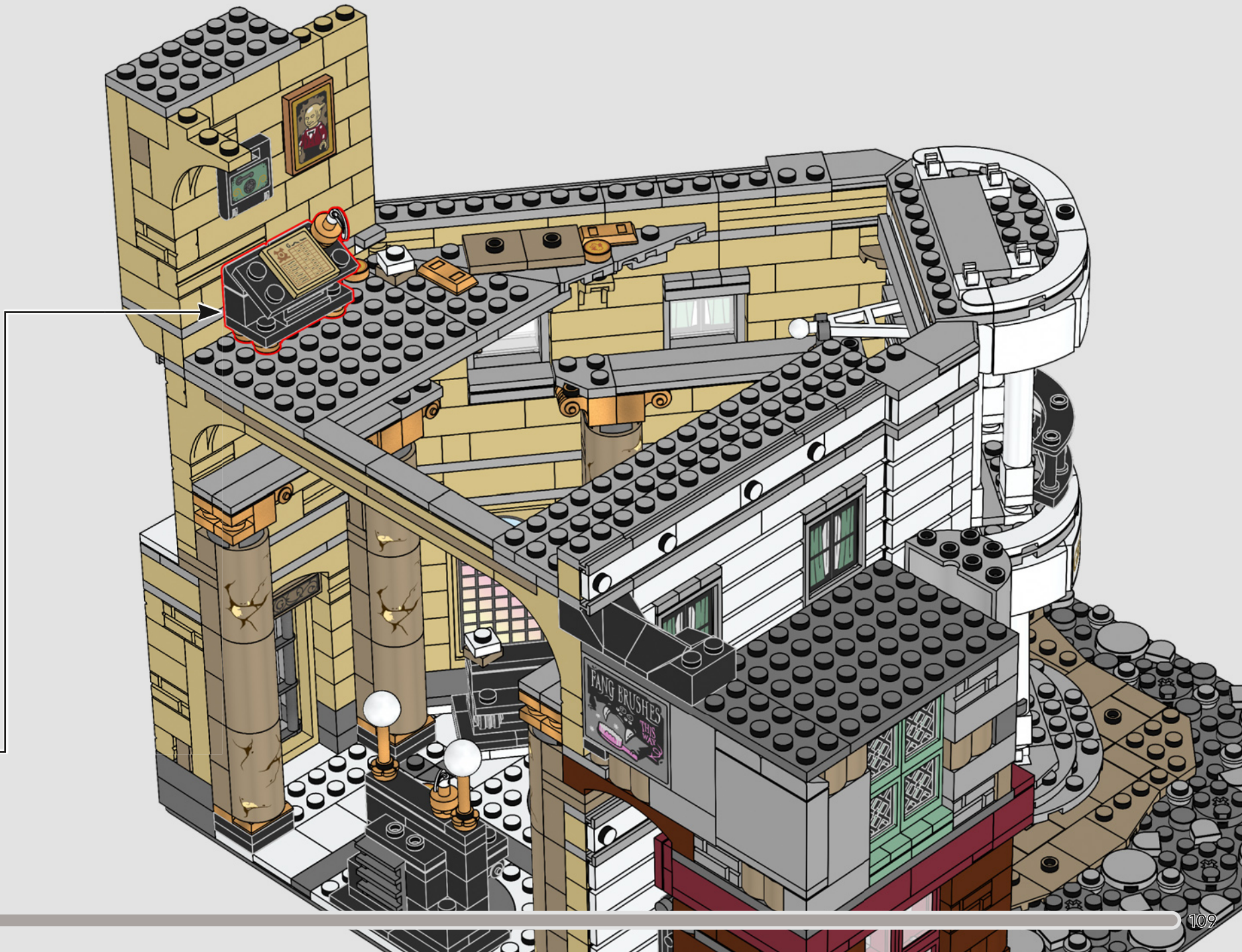

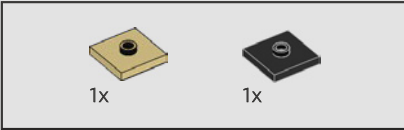
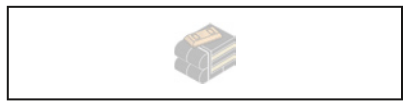

472

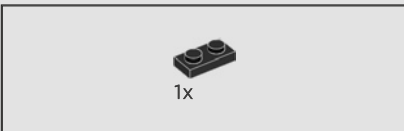
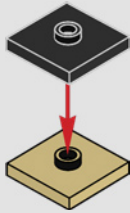

473

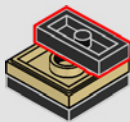

474

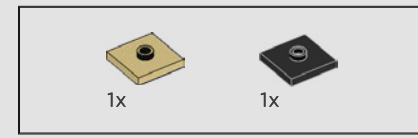
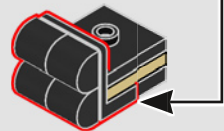
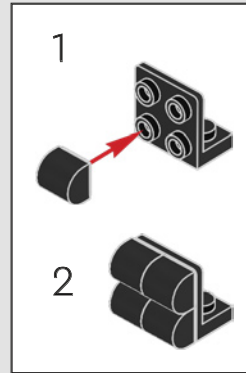

475

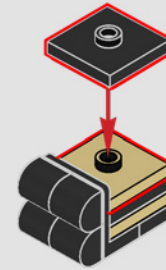

476

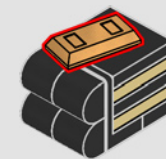

477



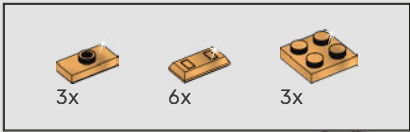

478

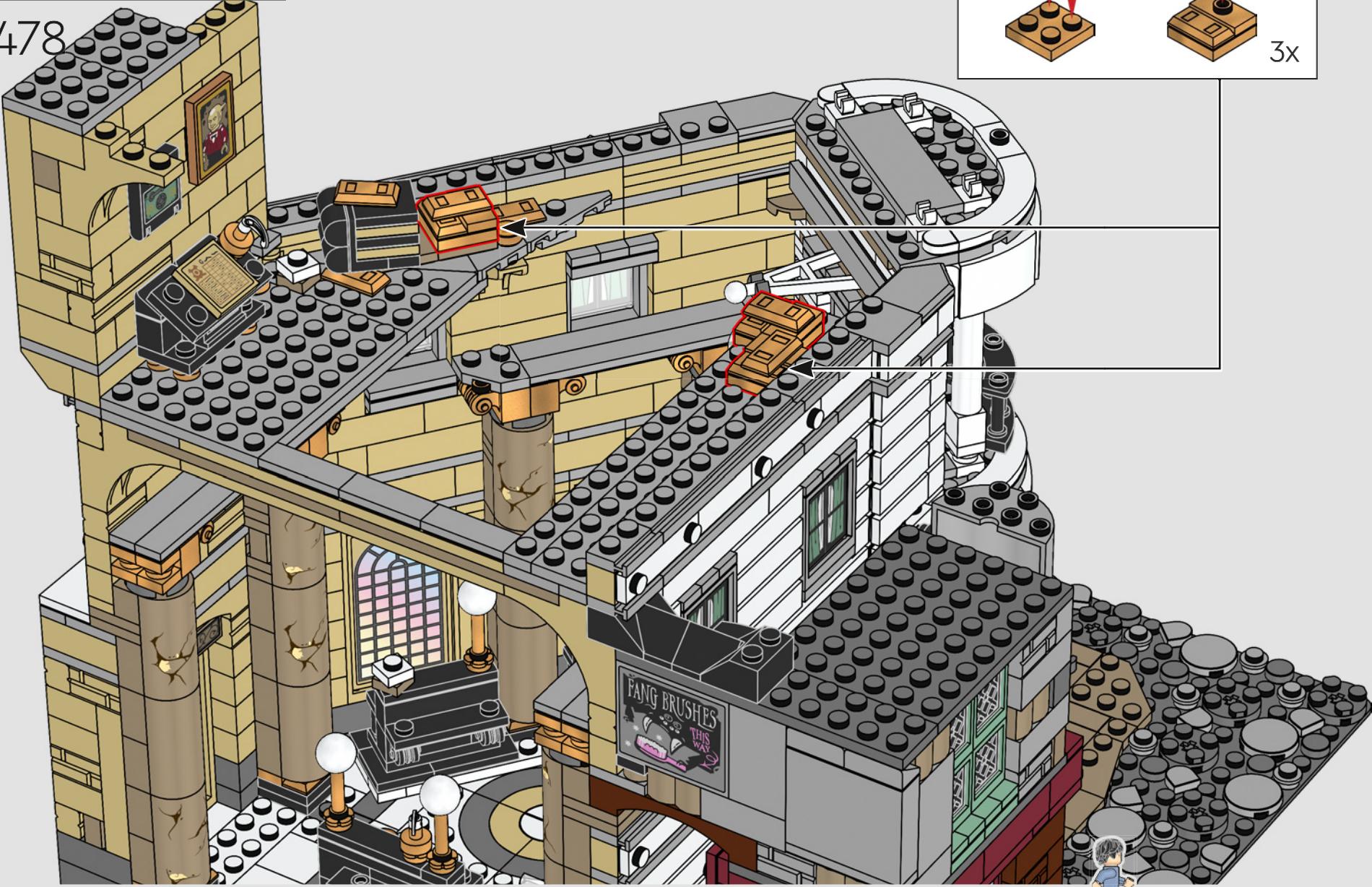
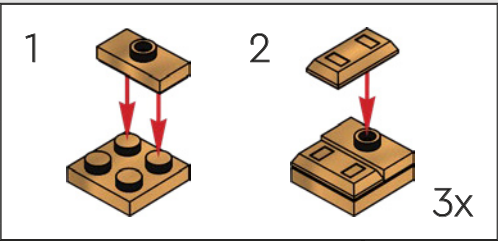



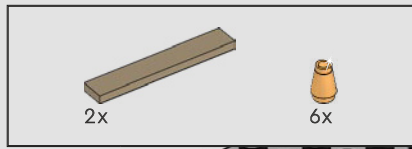

479

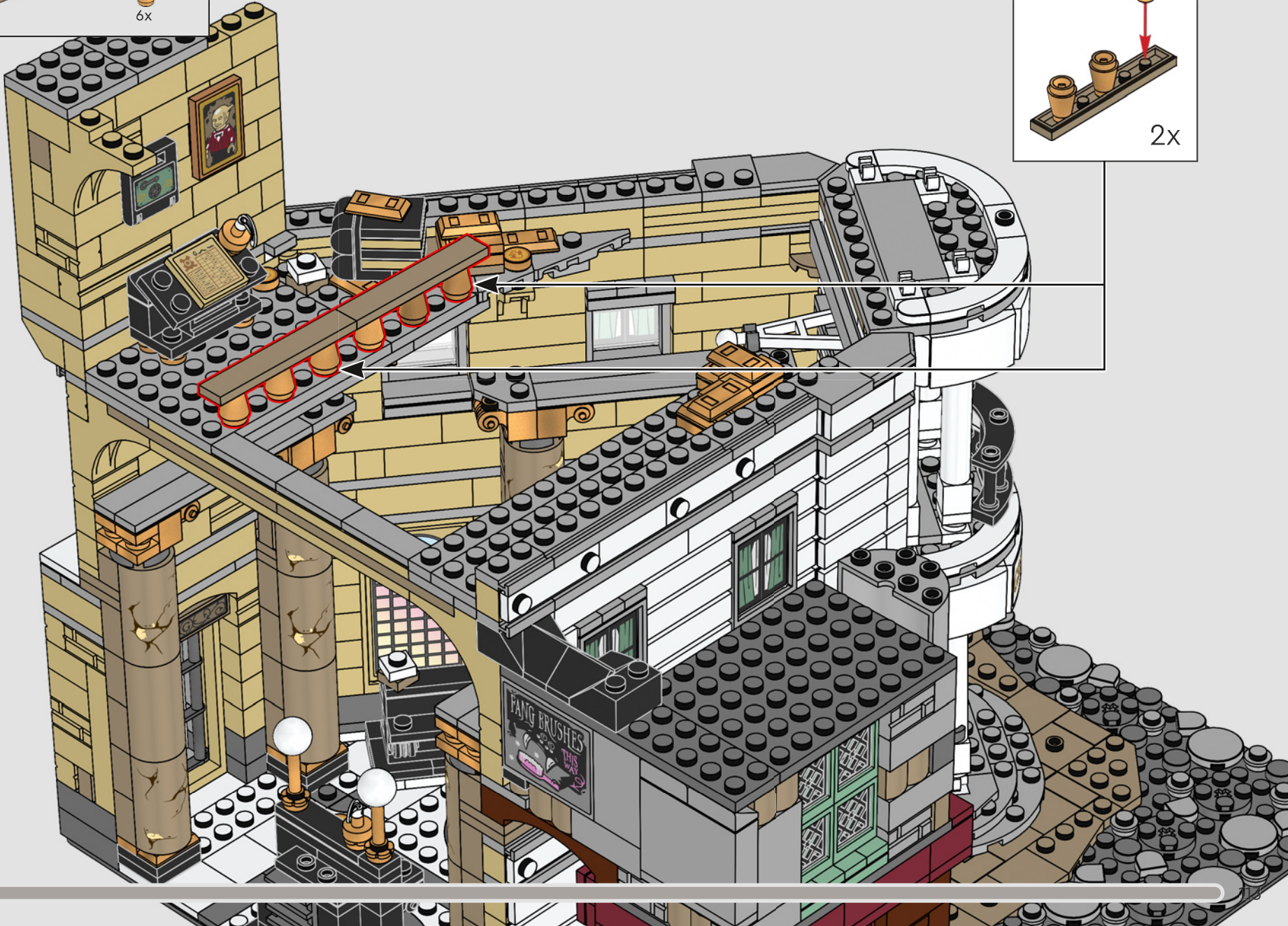
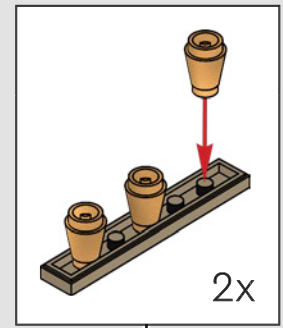

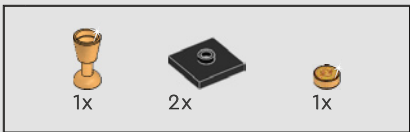

480

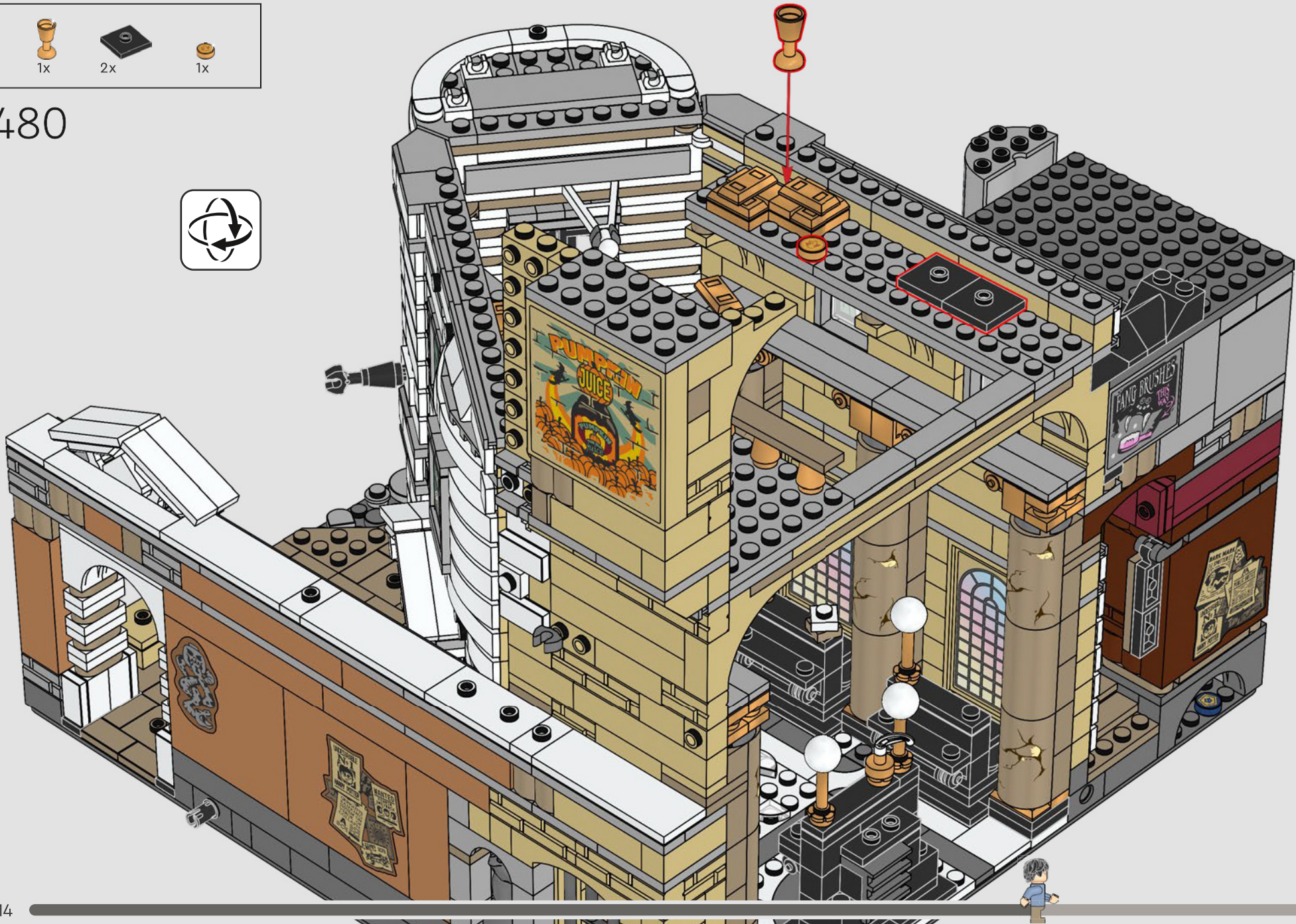

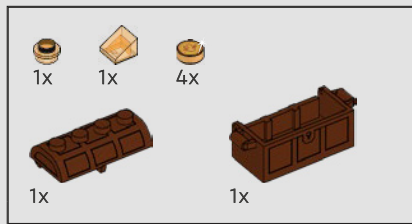

481

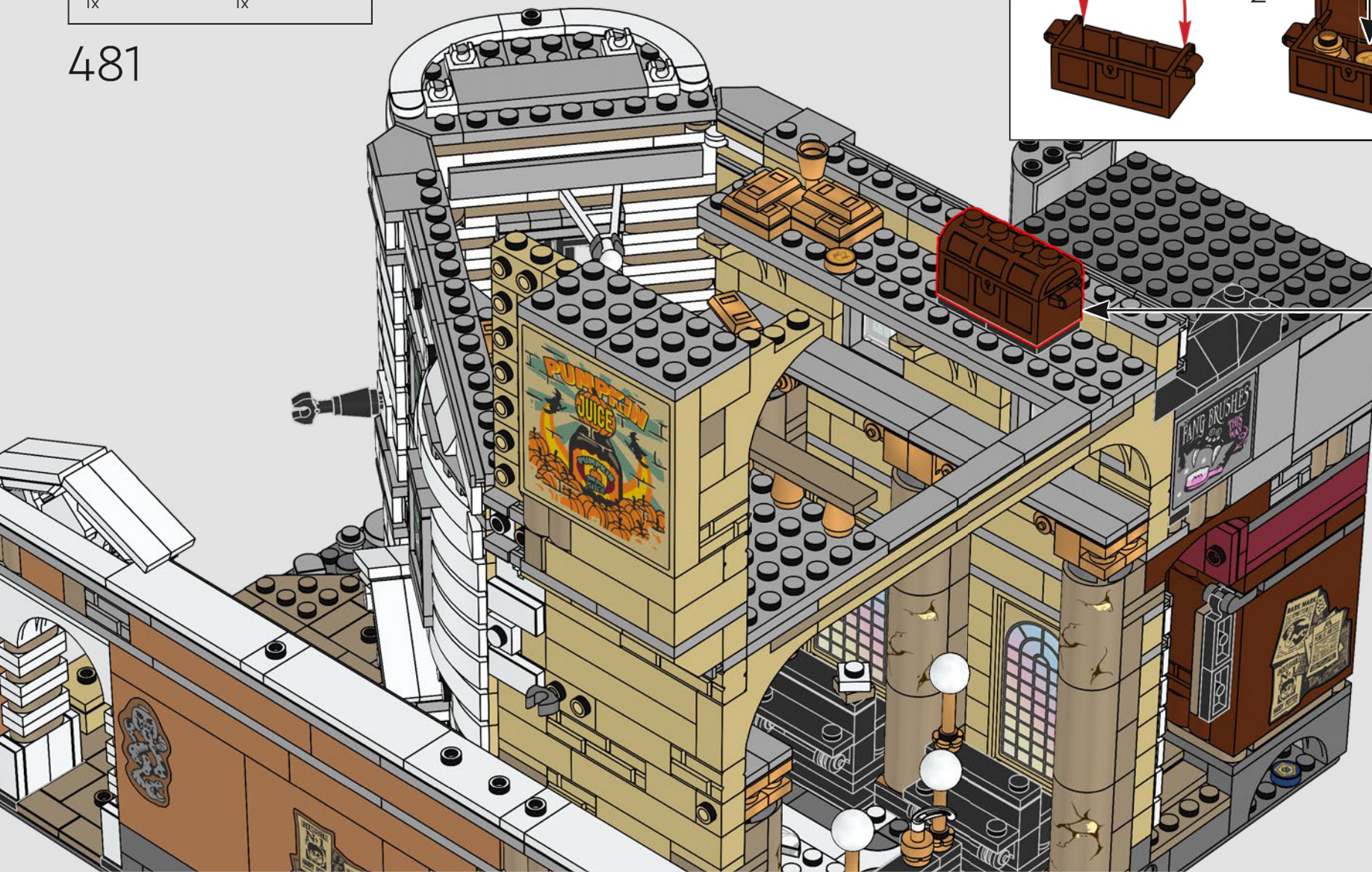
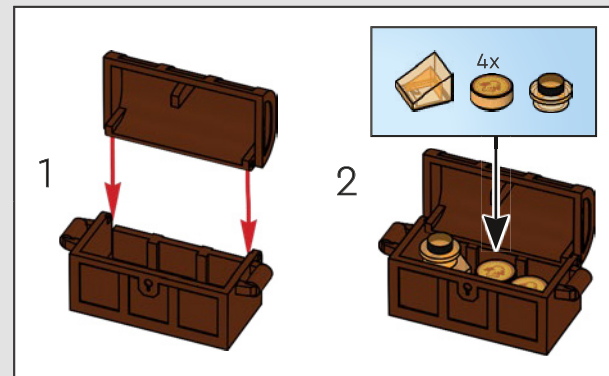



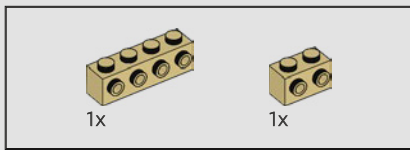

482

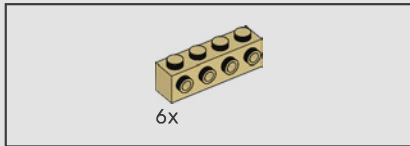
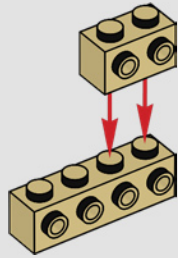

483

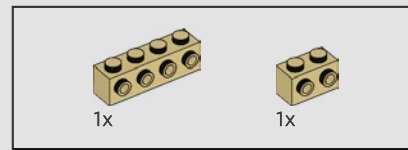
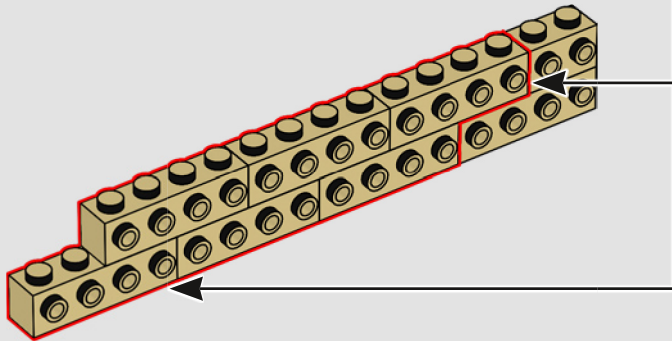
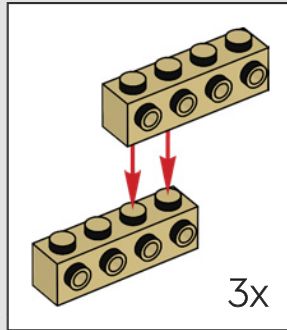

484

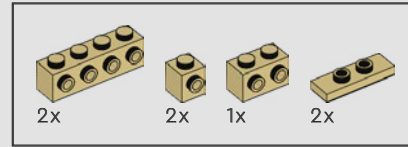
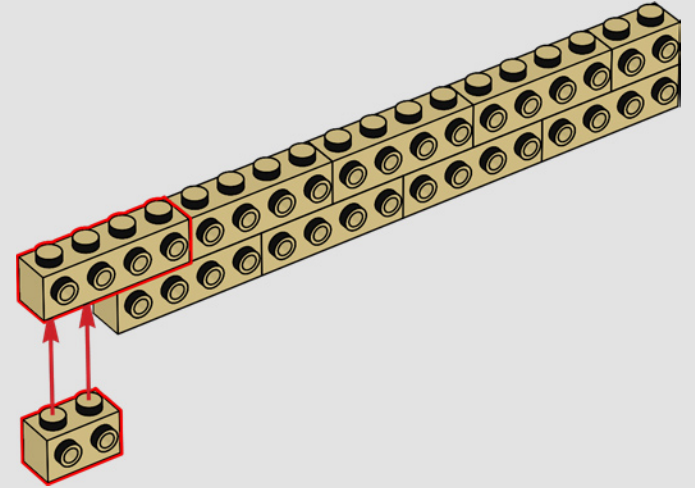

485

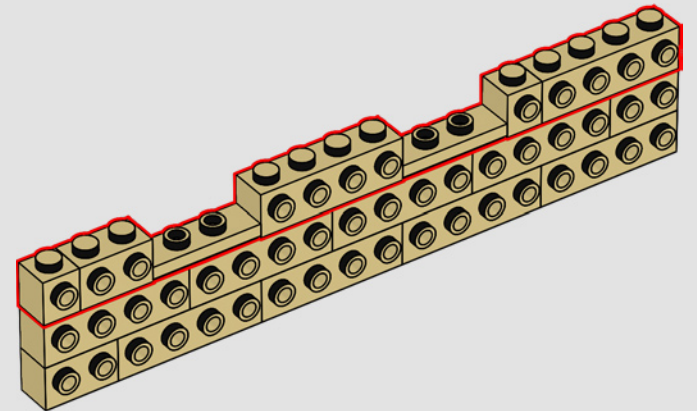

486

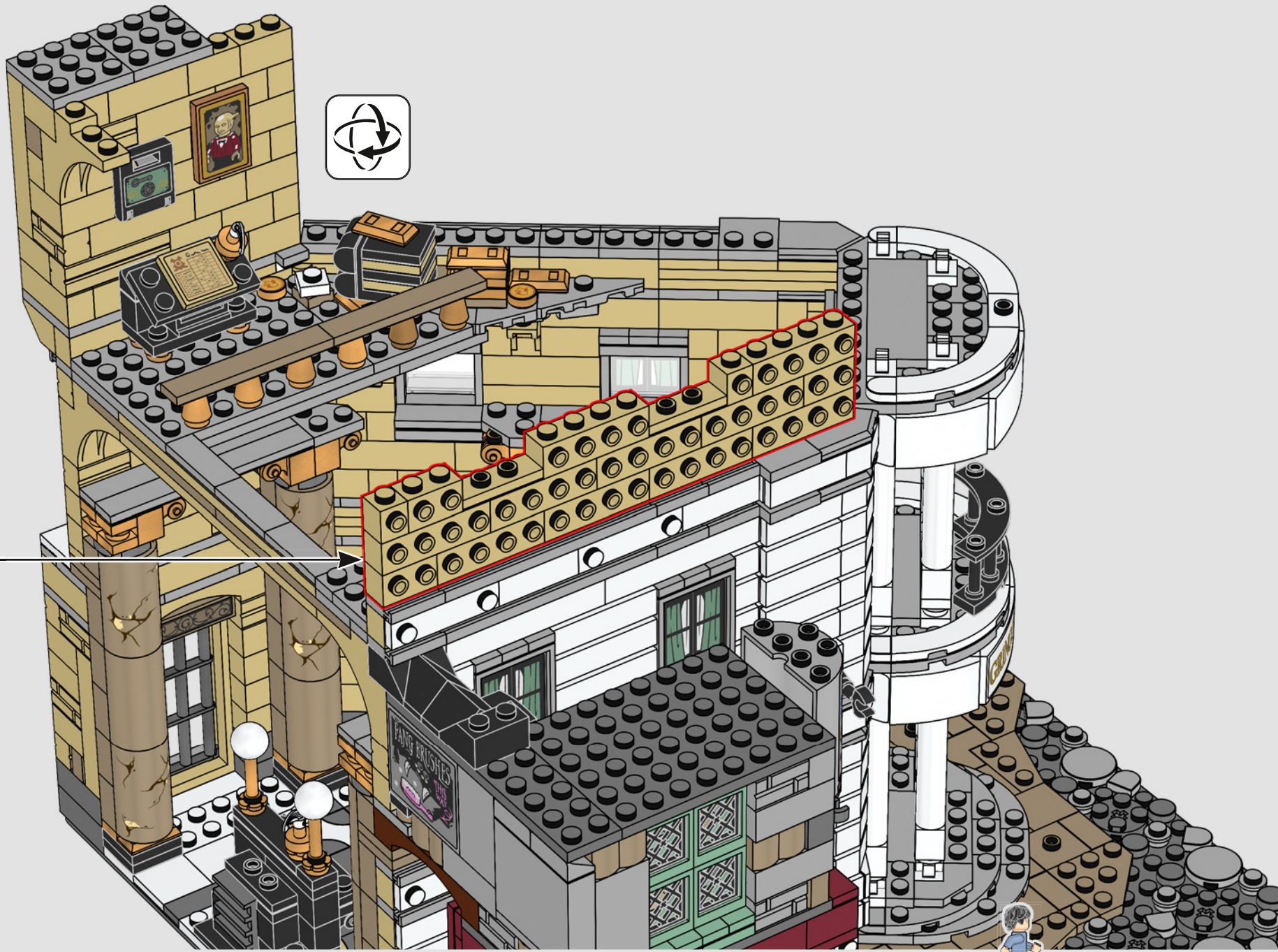

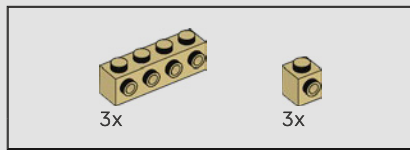

487

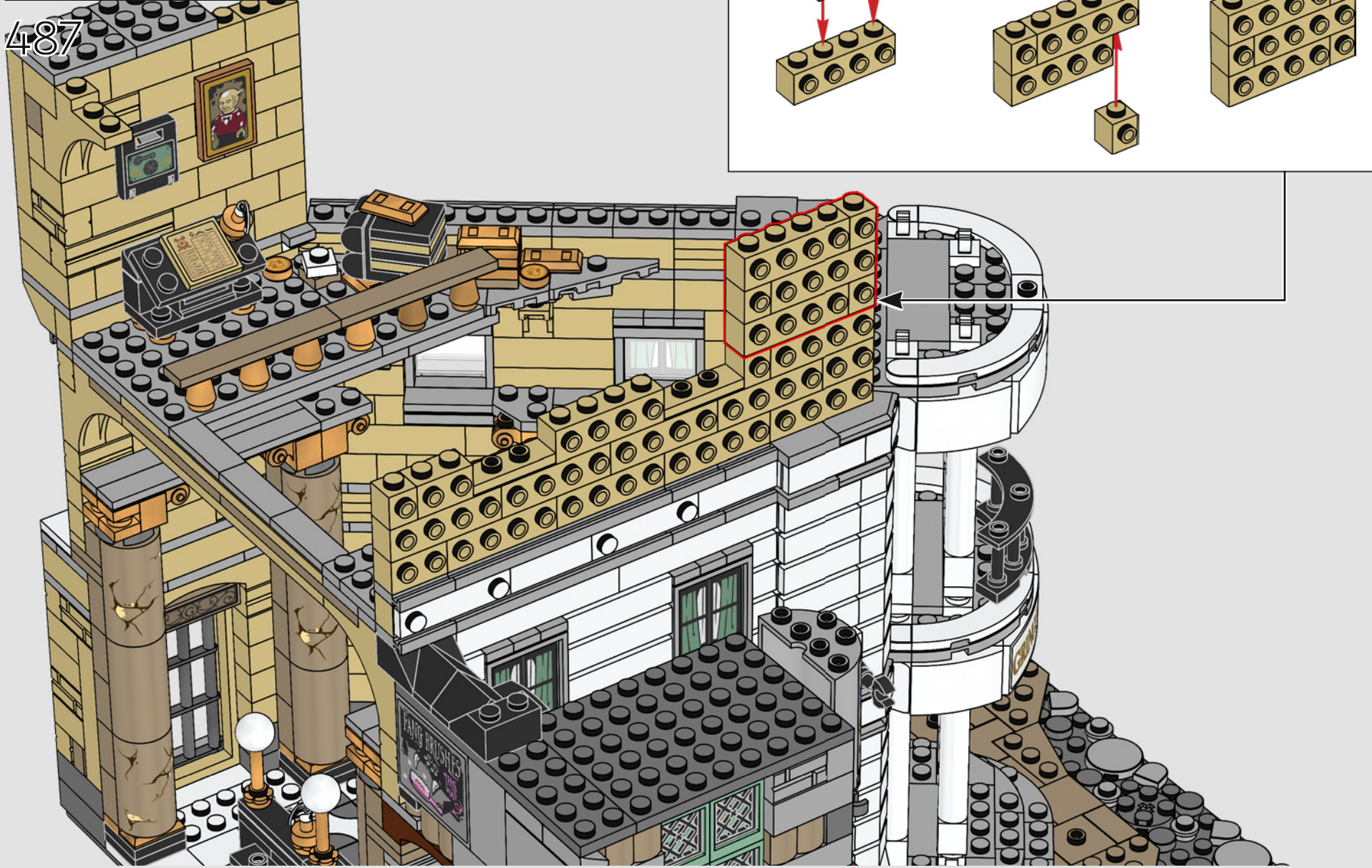
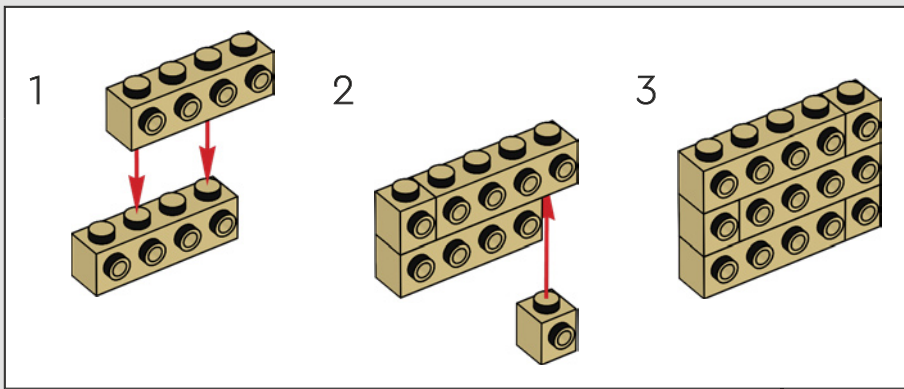

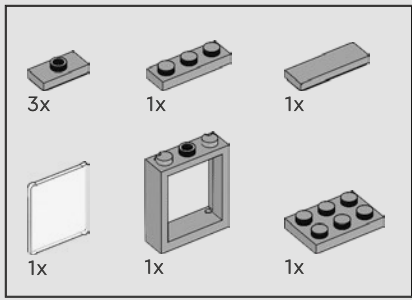

488

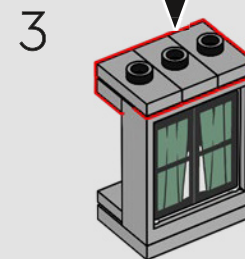
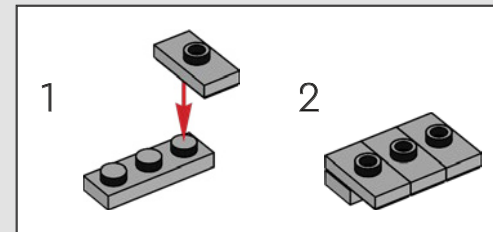
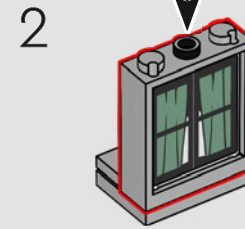
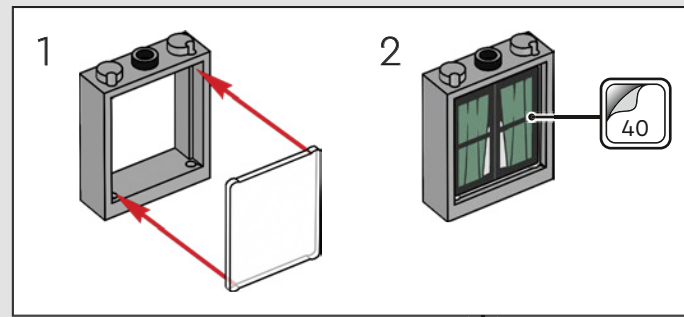
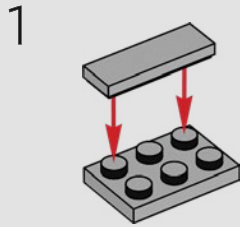



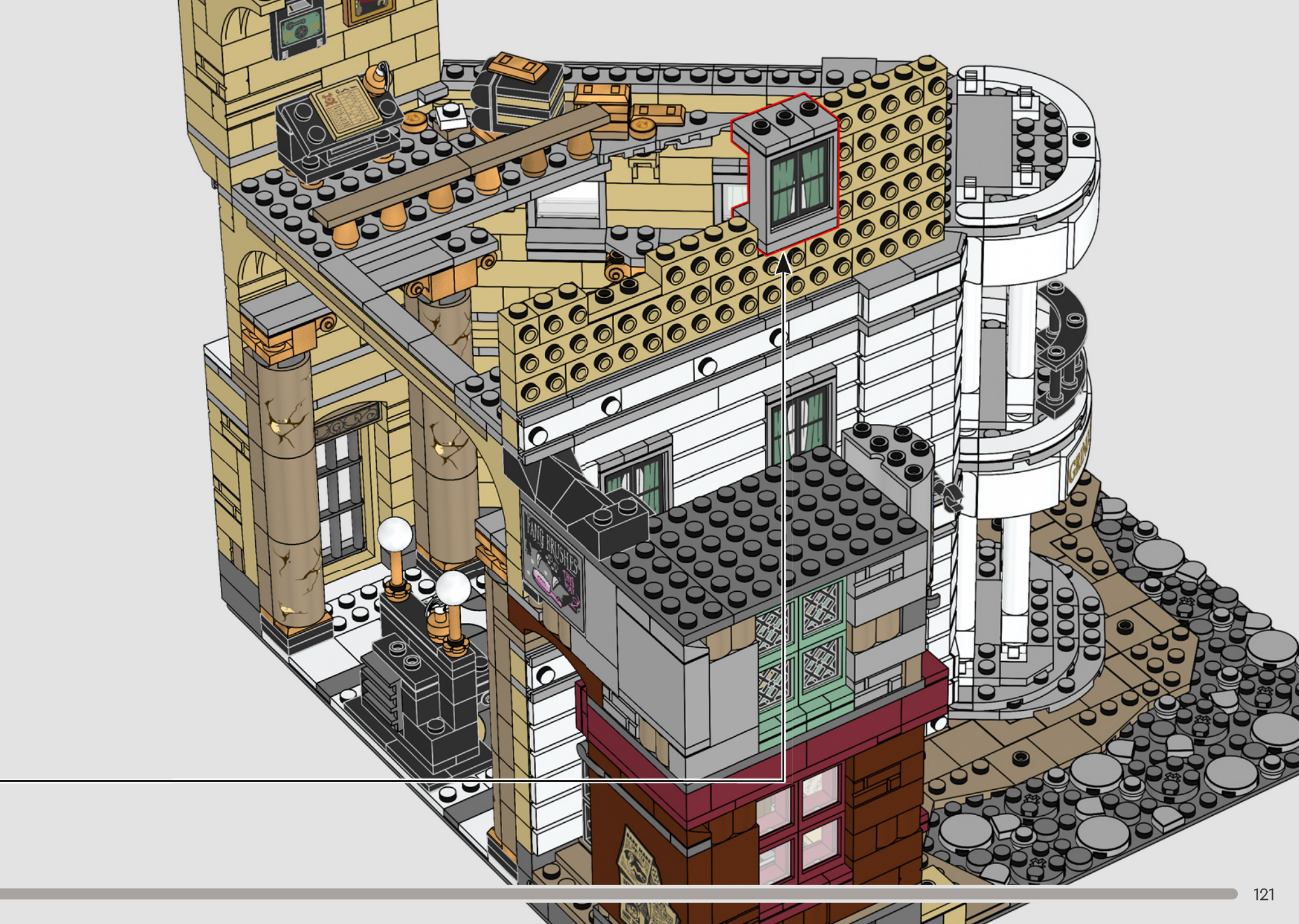

492

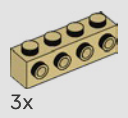

3x

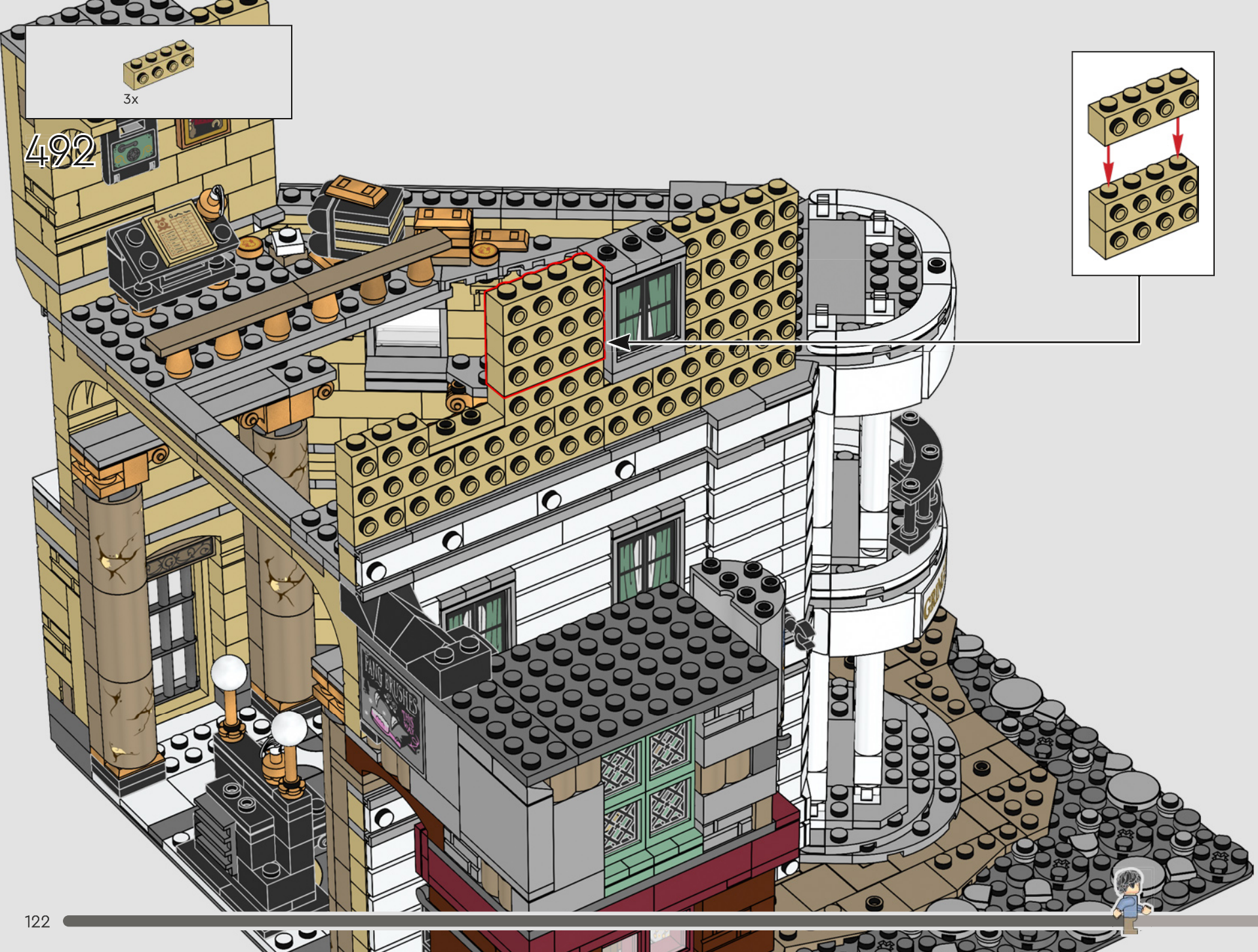
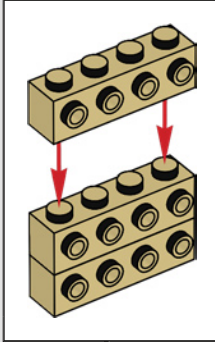

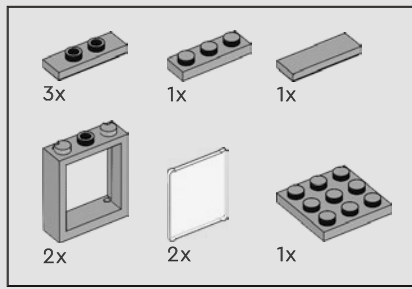

490

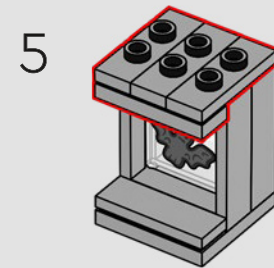
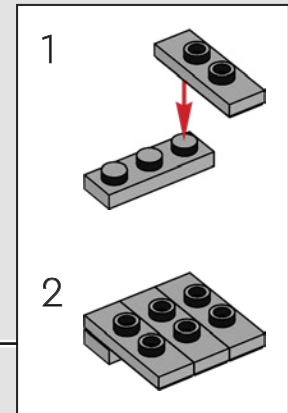
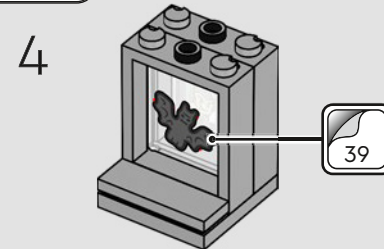
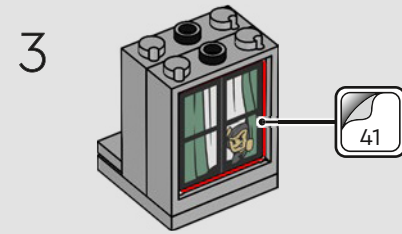
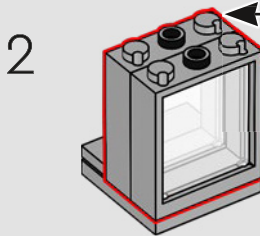
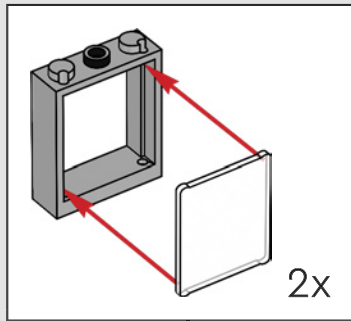
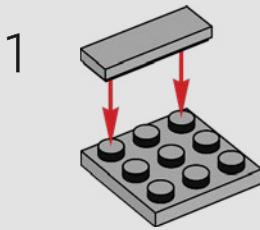

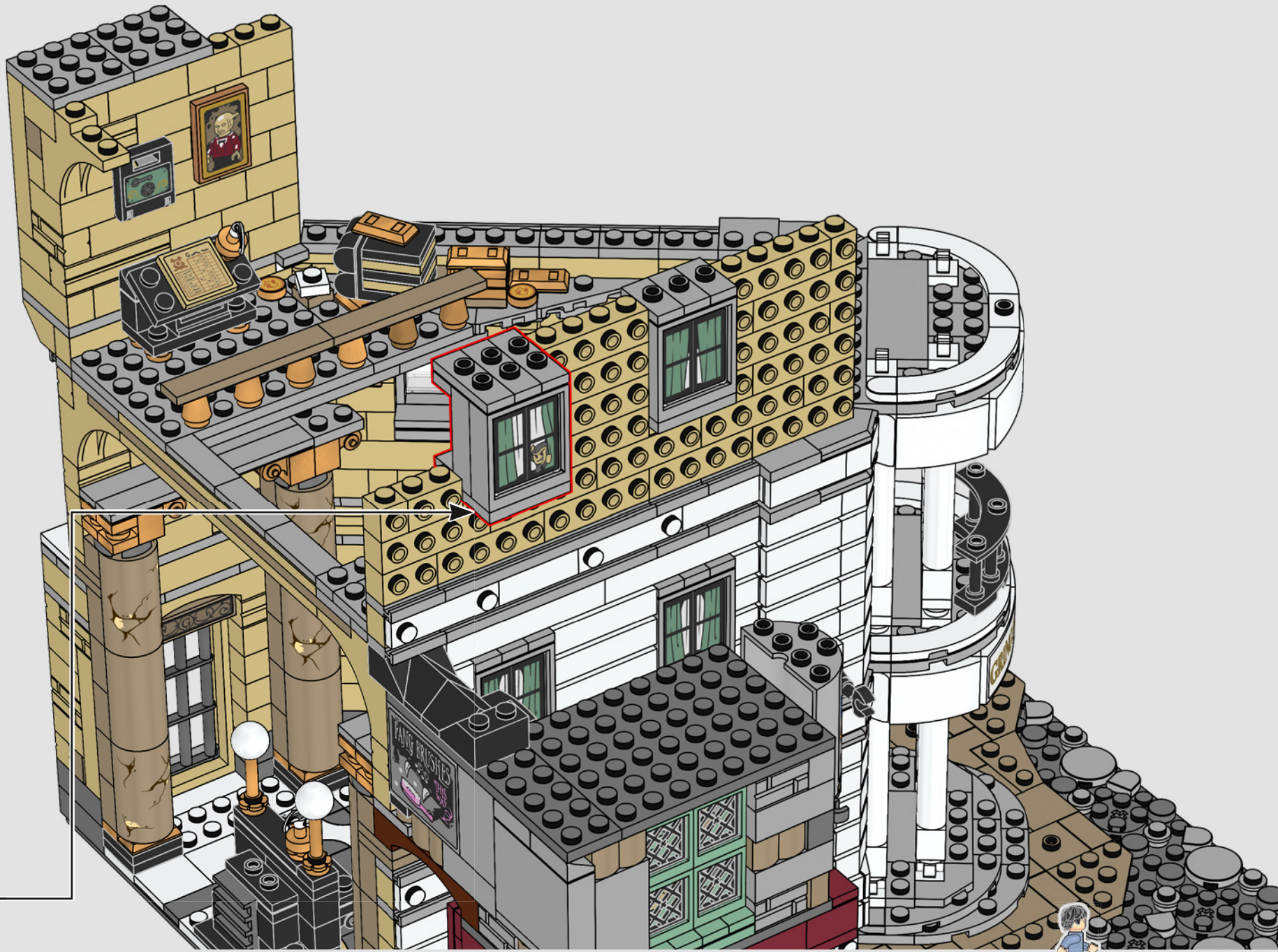



491

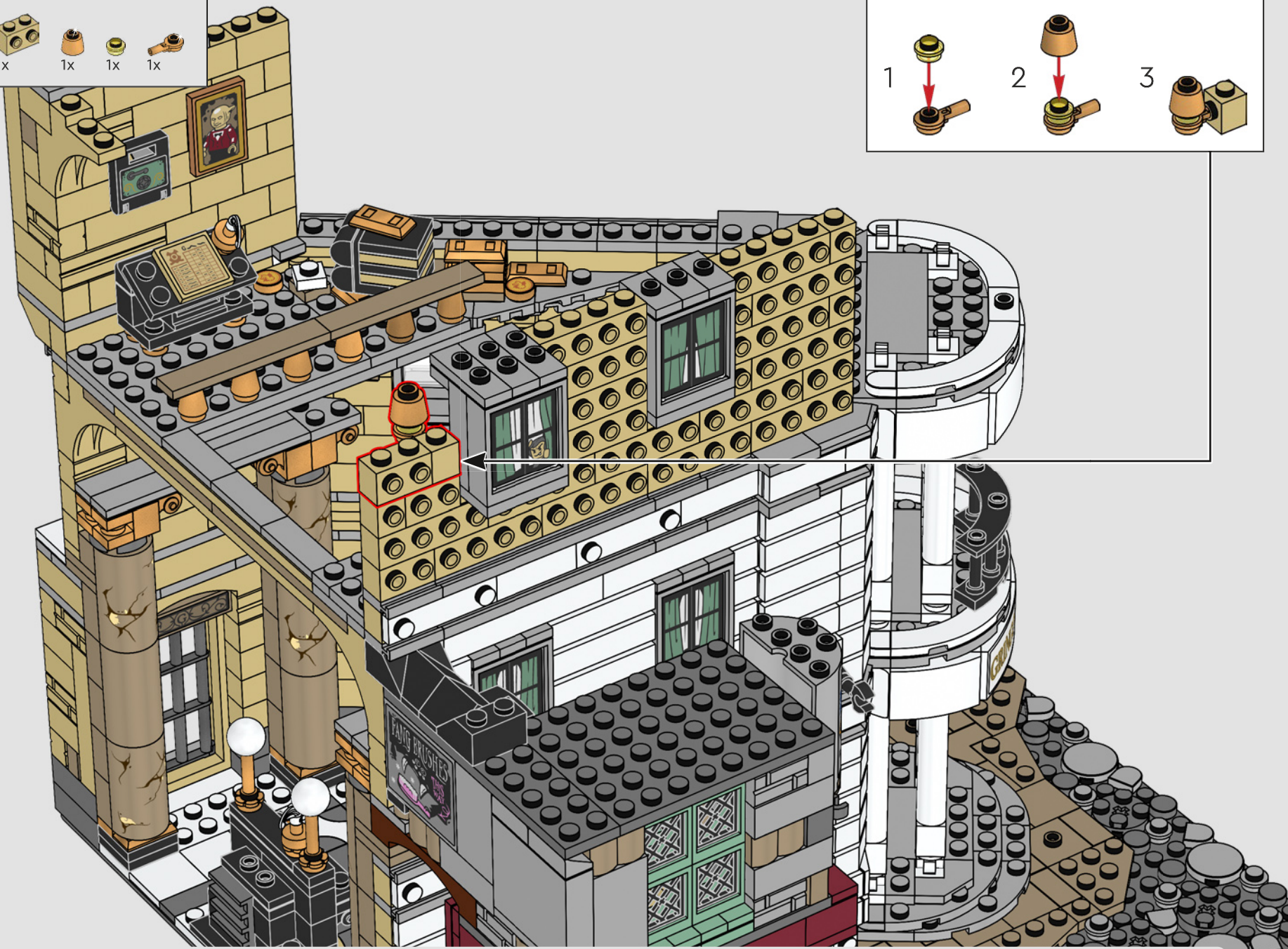
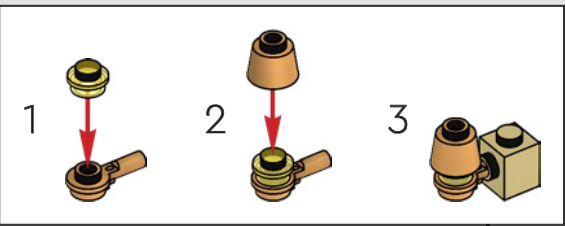

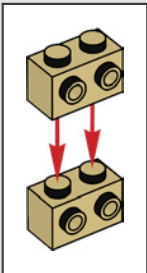
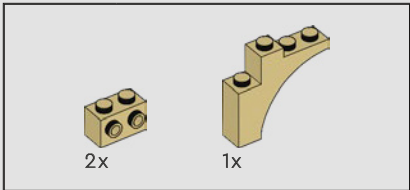

492

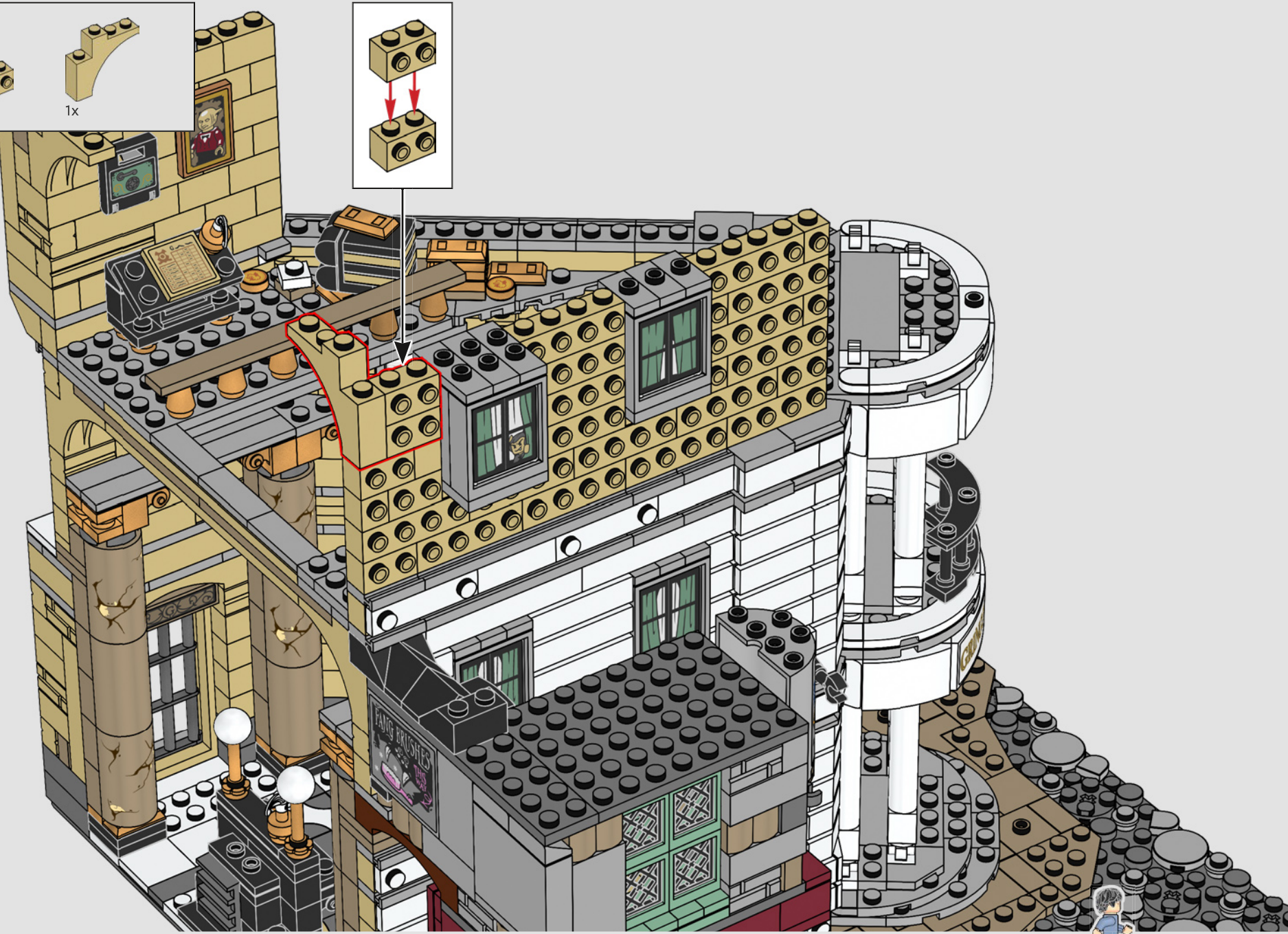

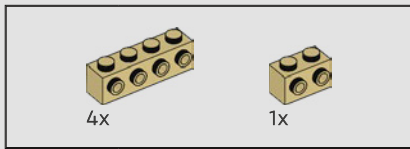

493

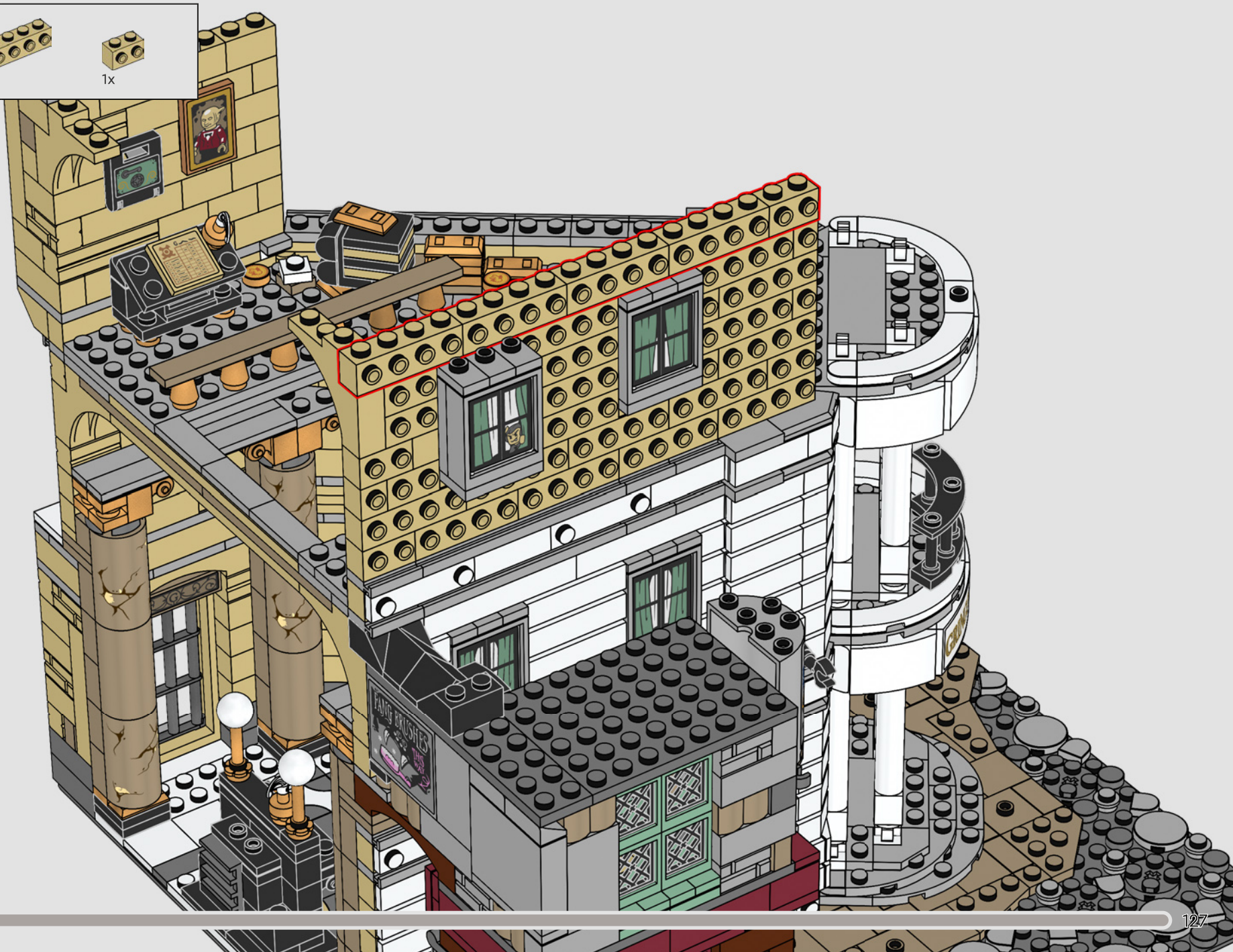

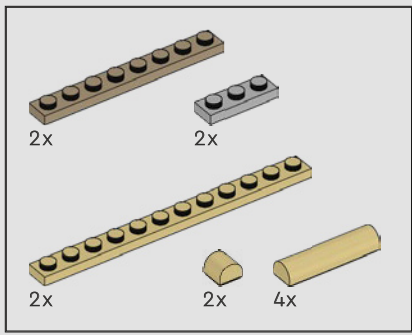

494

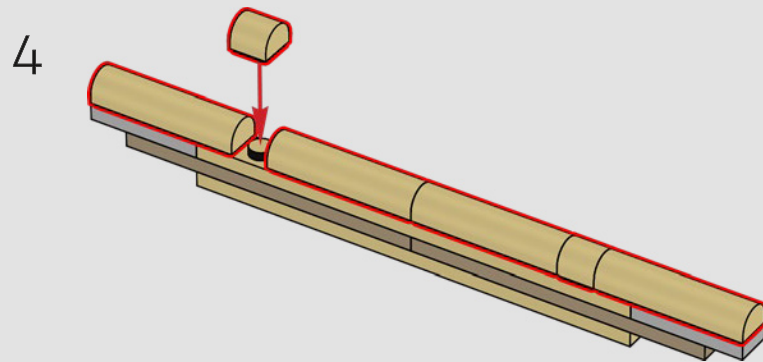
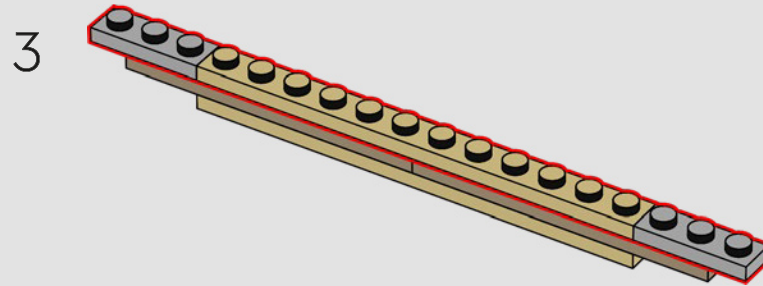
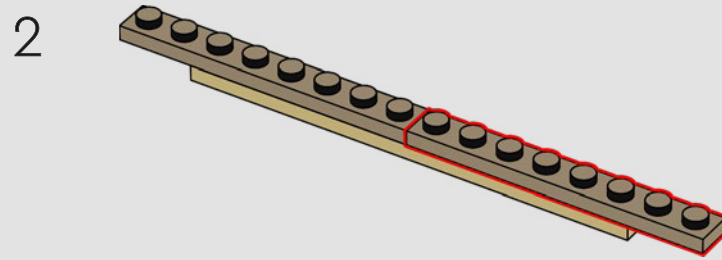
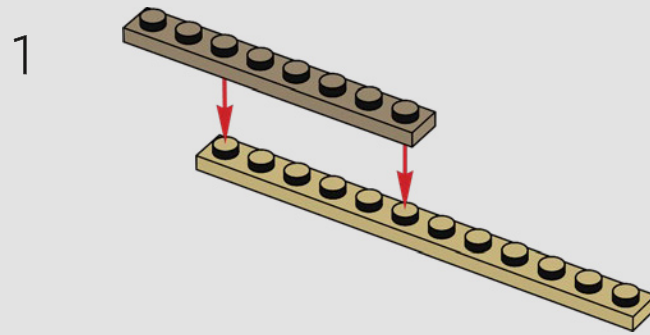



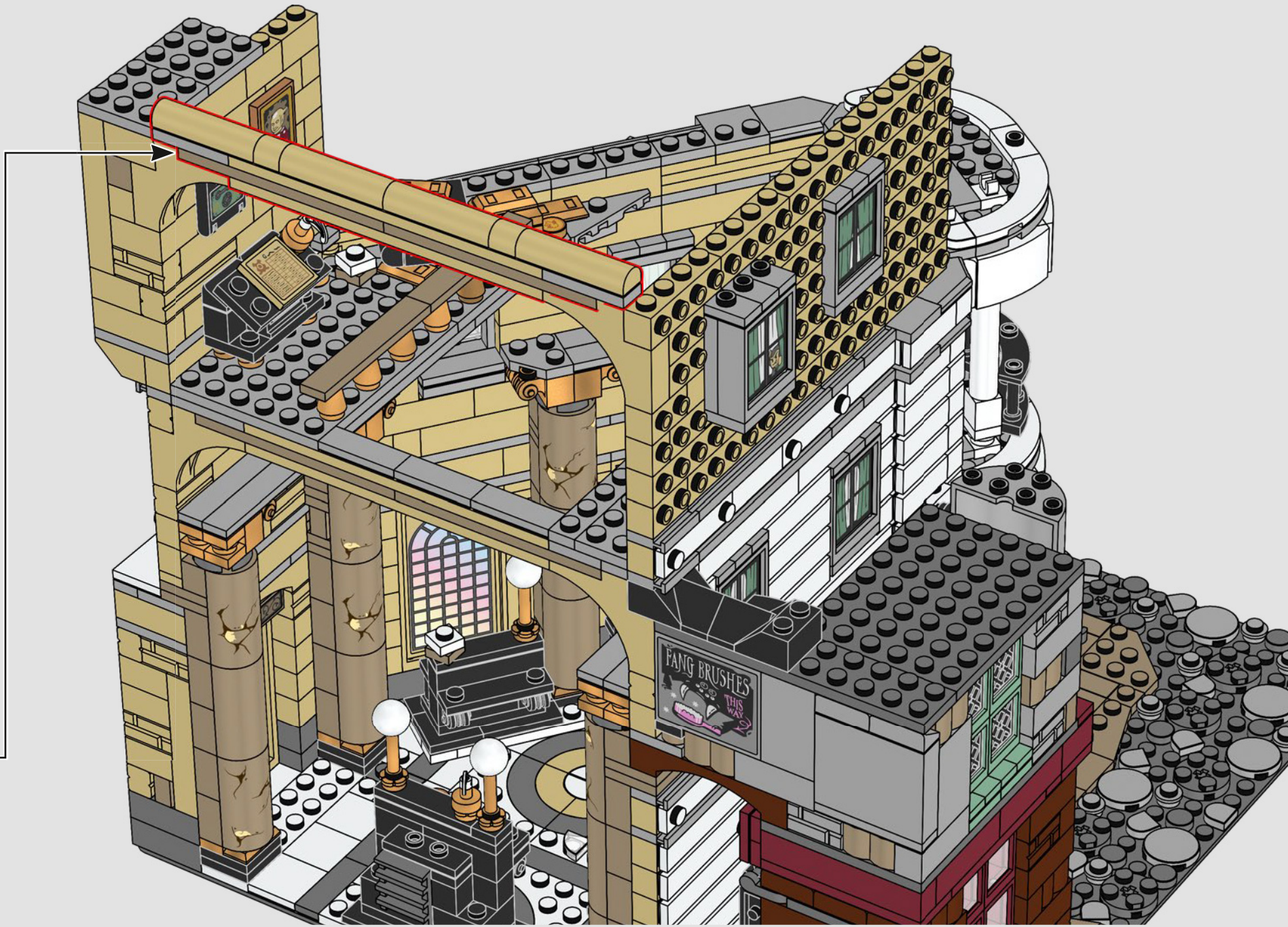

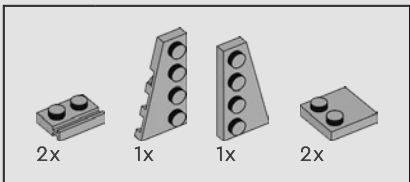

495

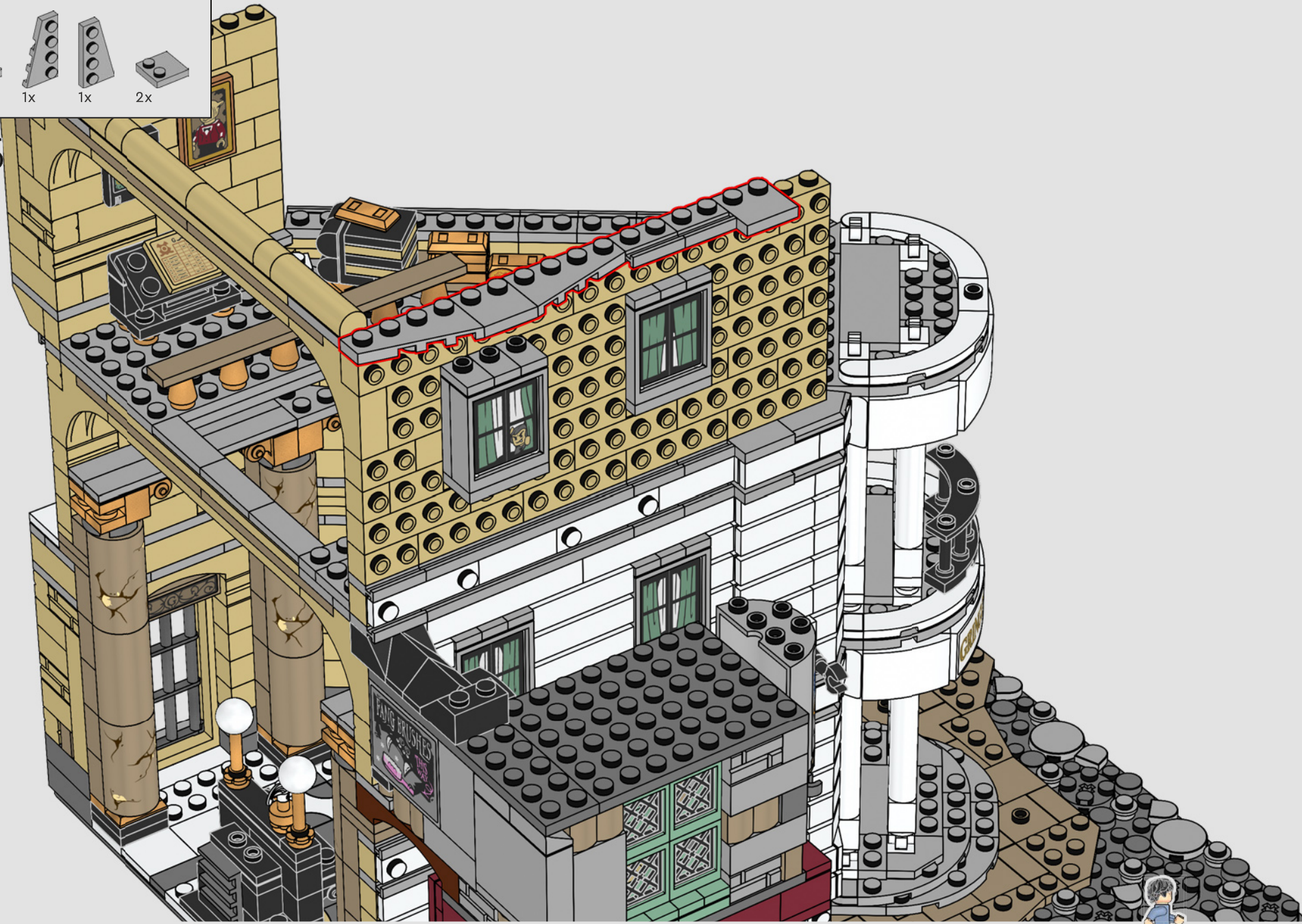

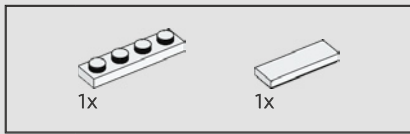

496

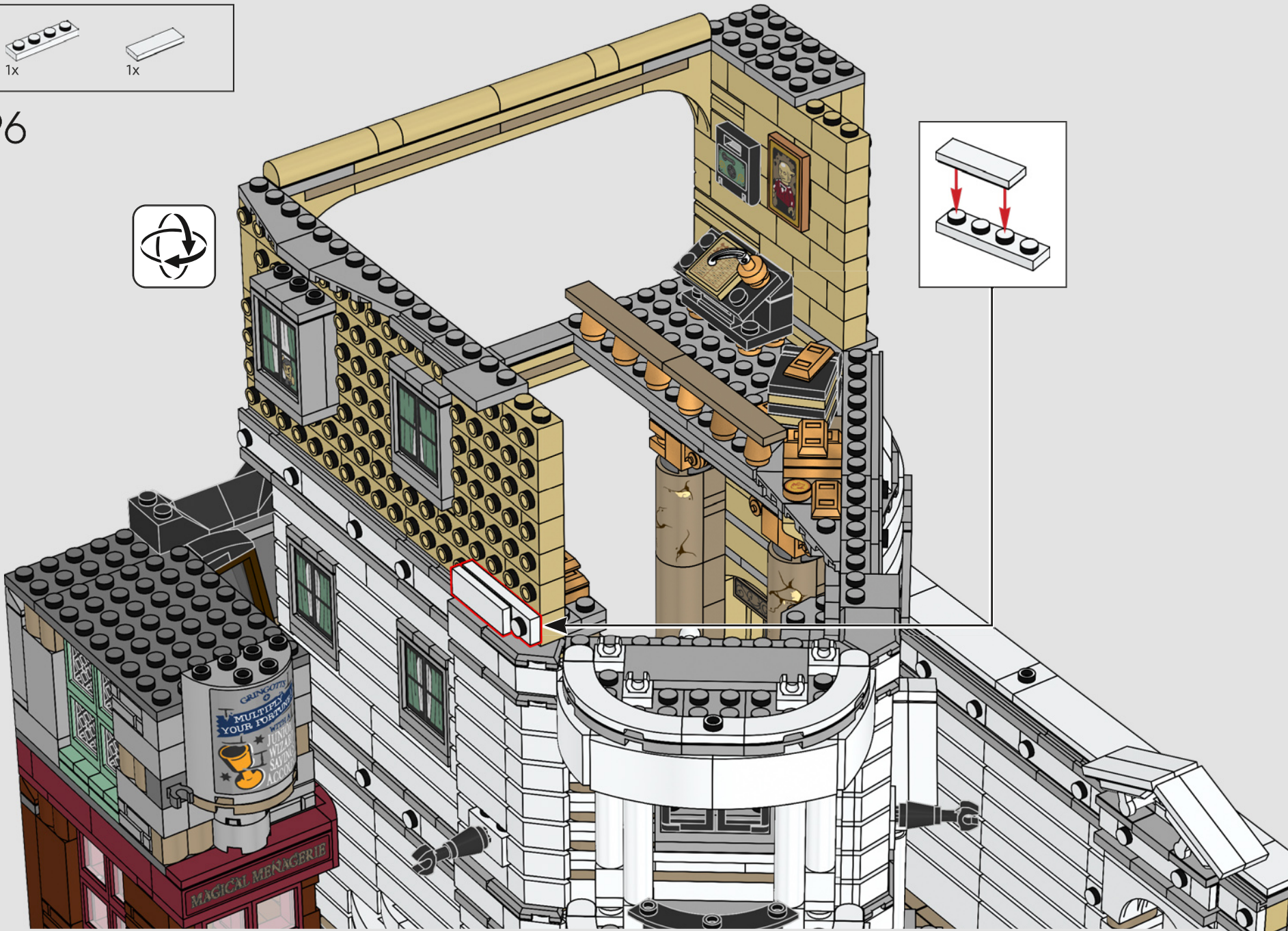
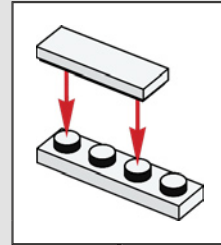

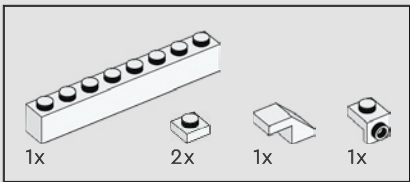

497

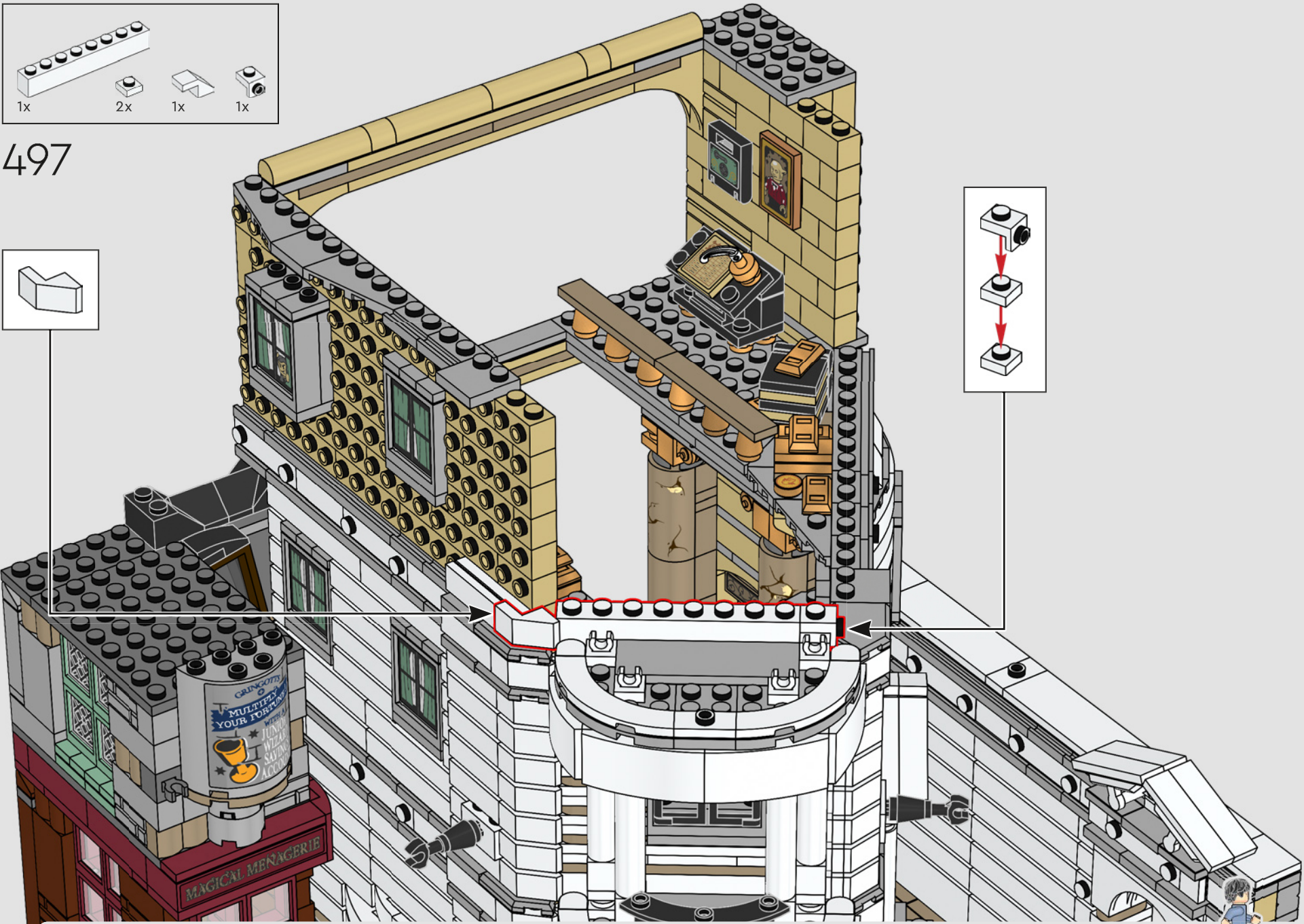
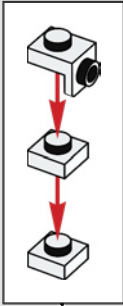
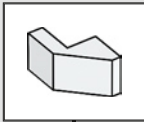

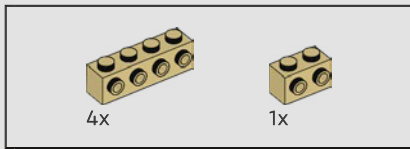

498

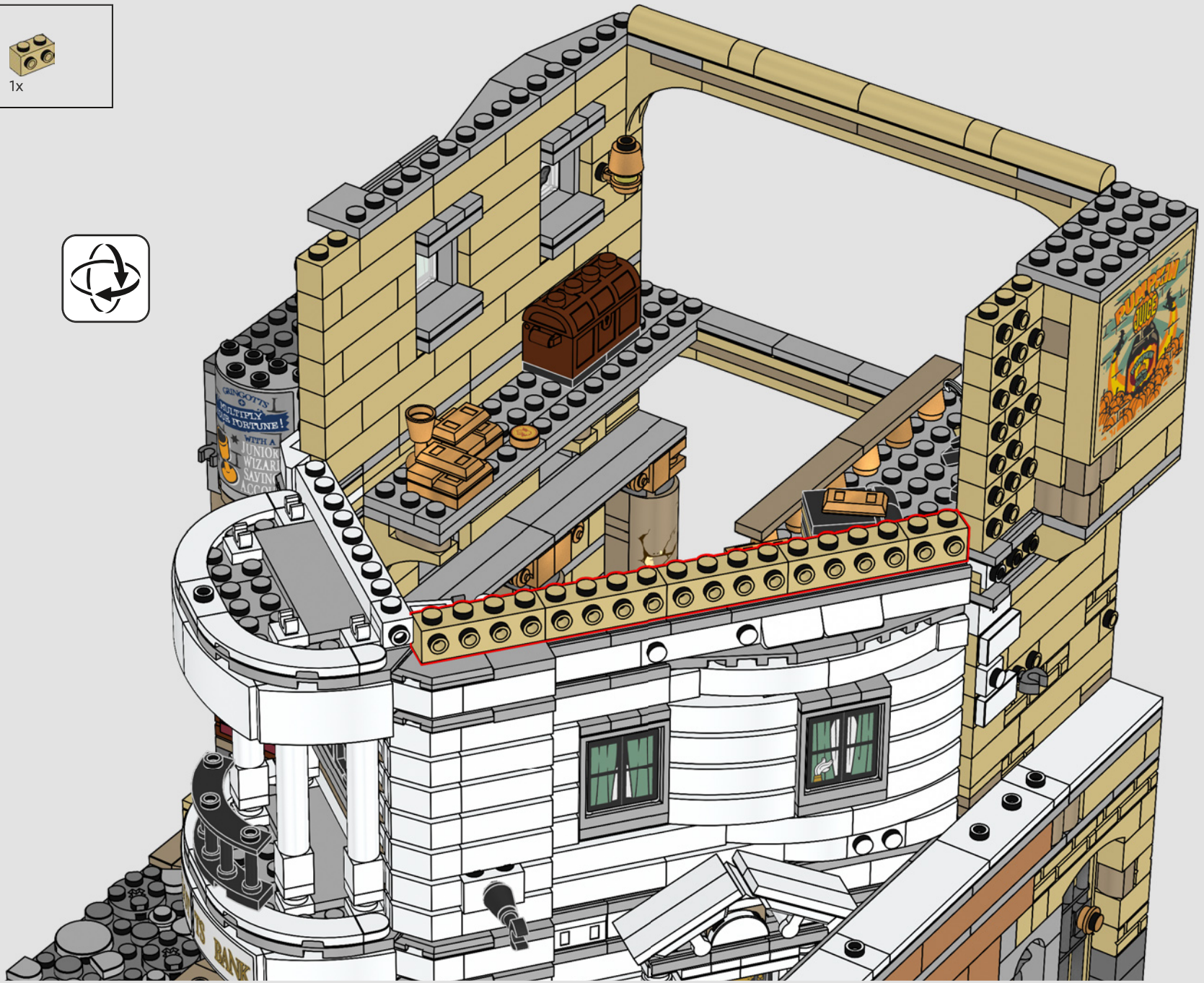

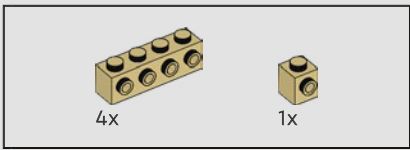

499

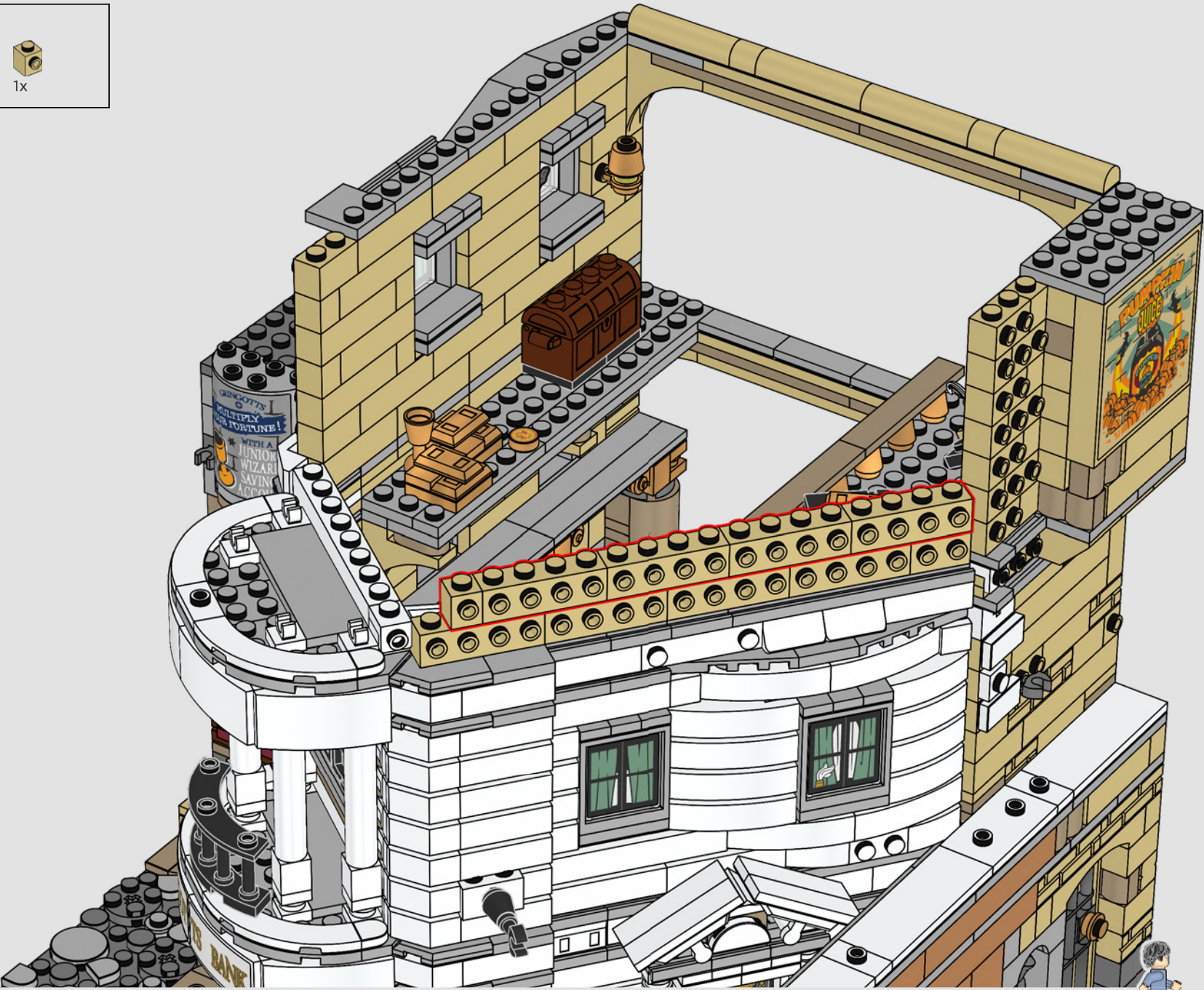

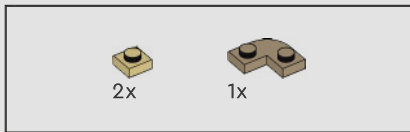

500

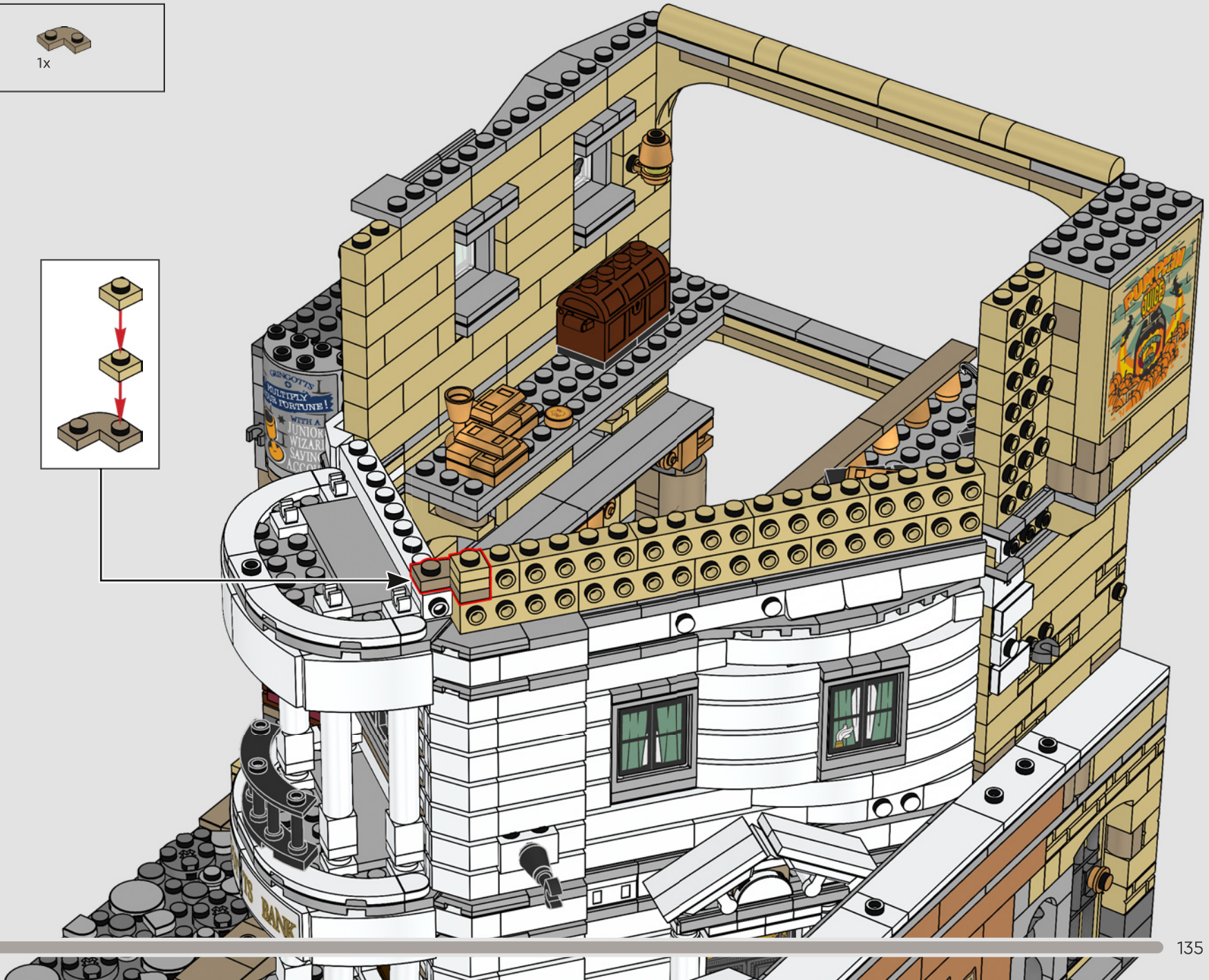
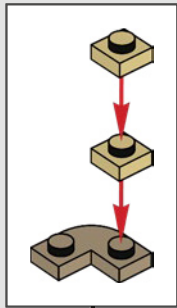

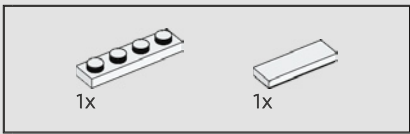

501

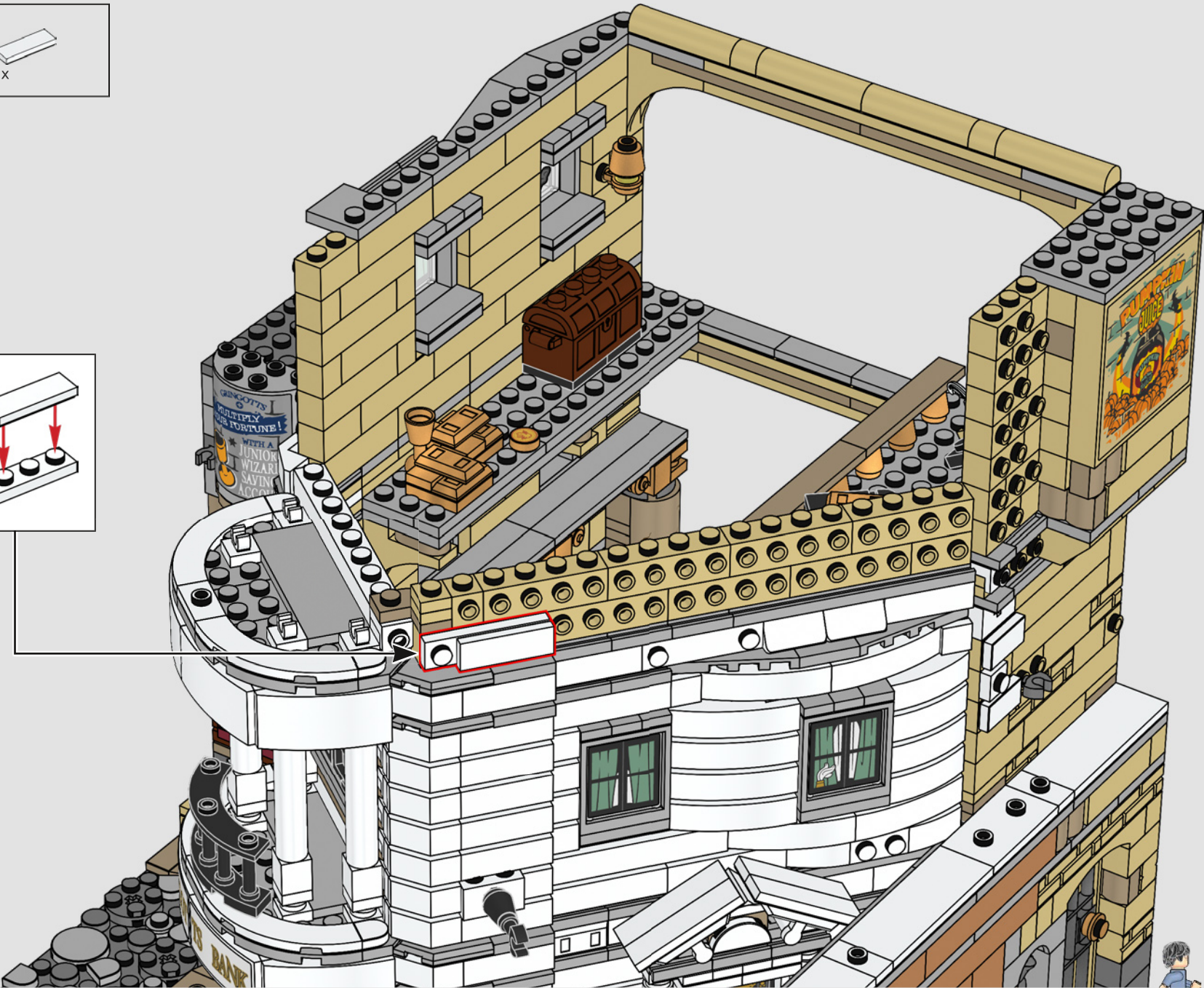
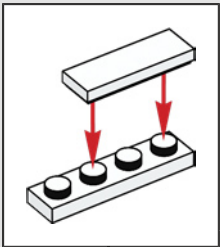



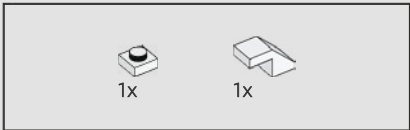

502

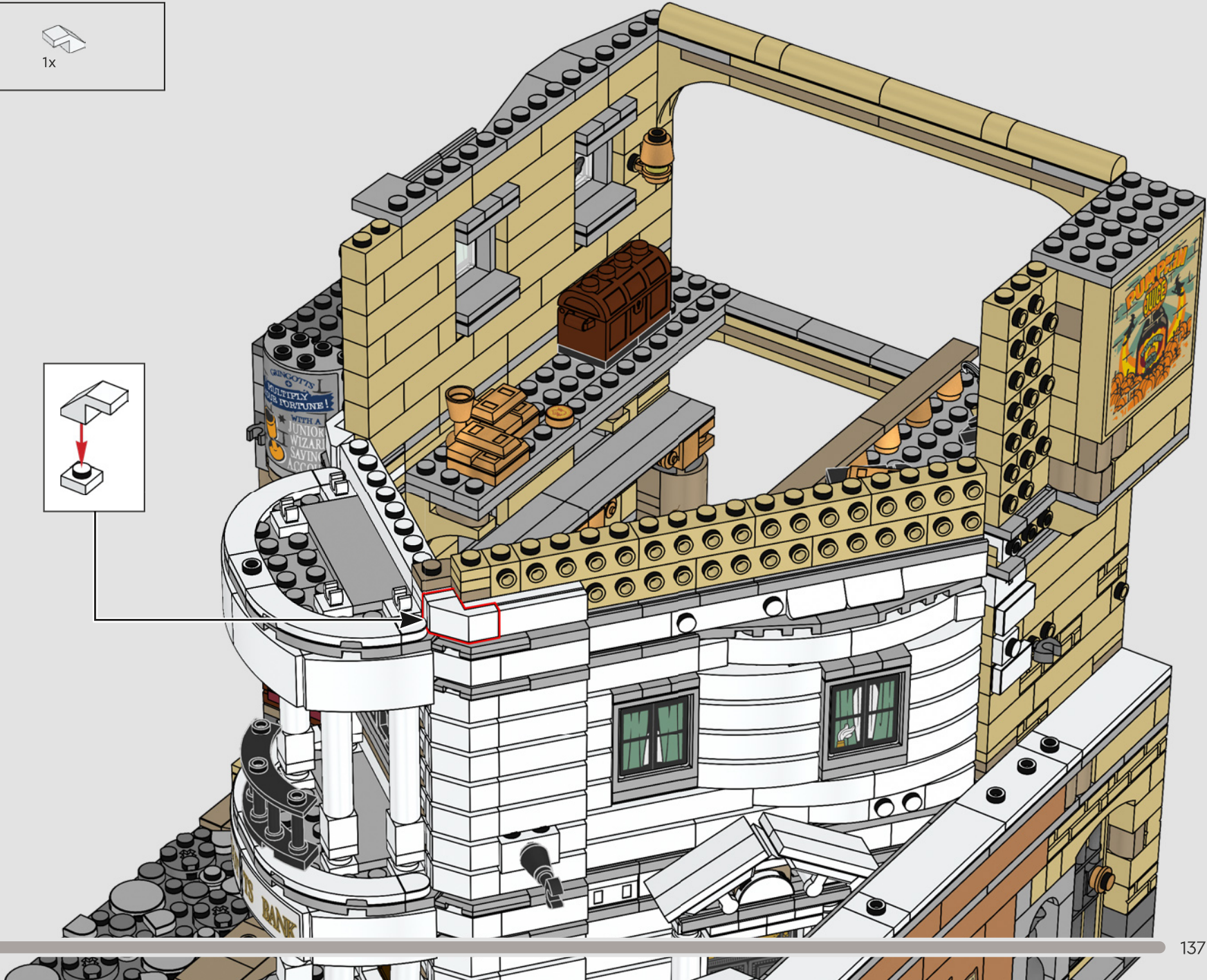
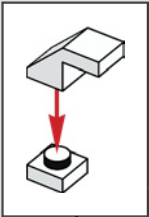

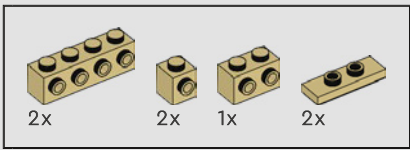

503

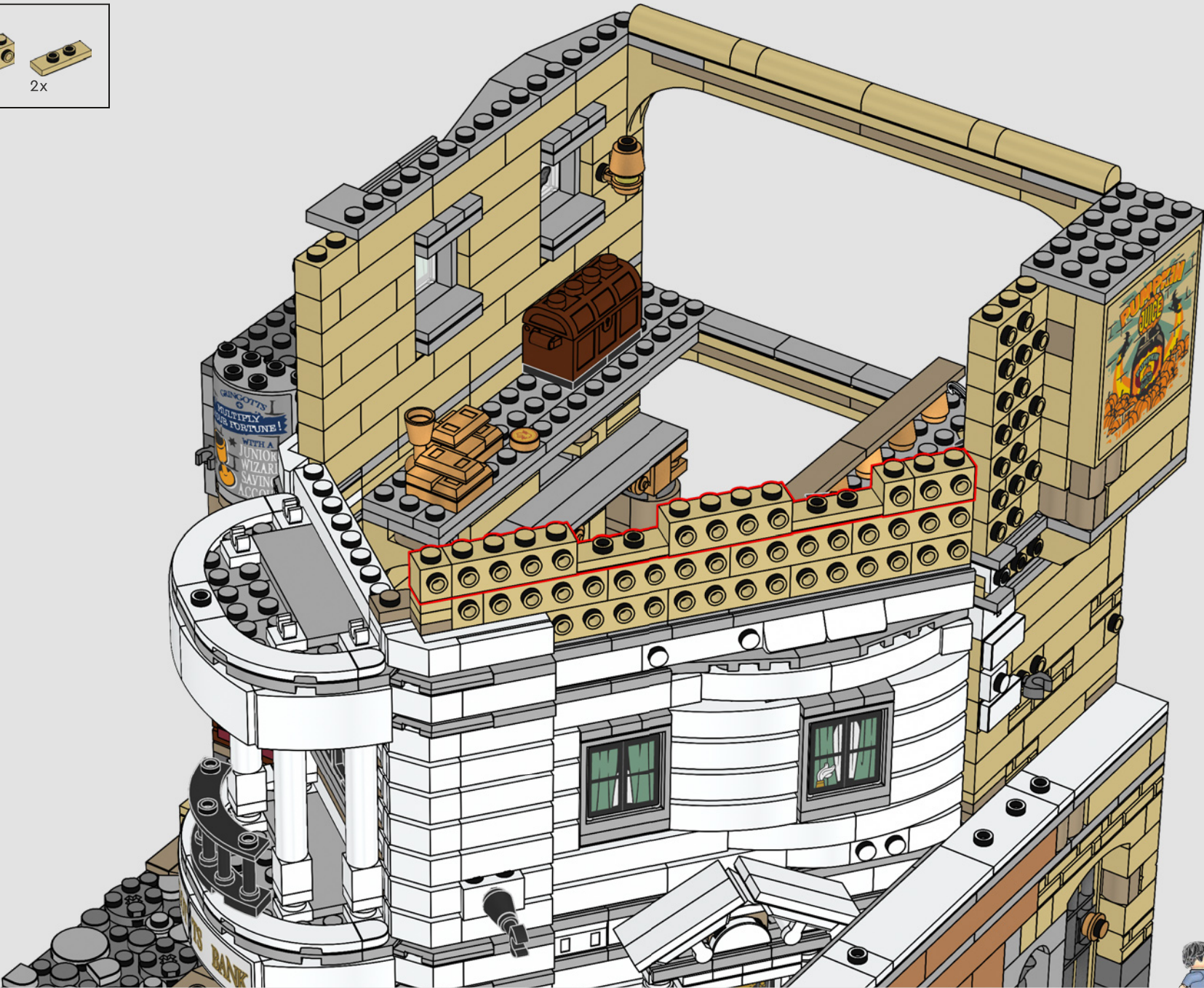



504

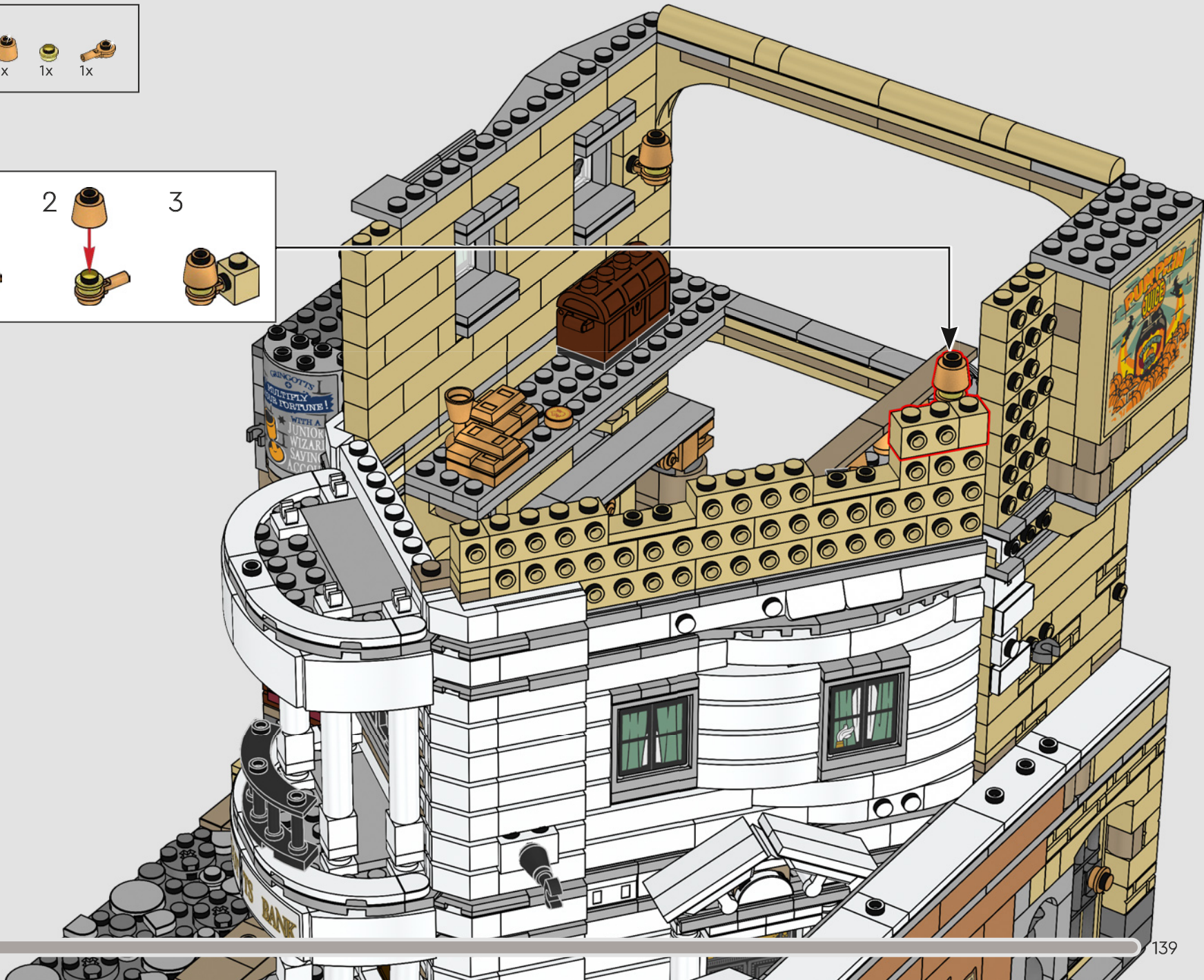
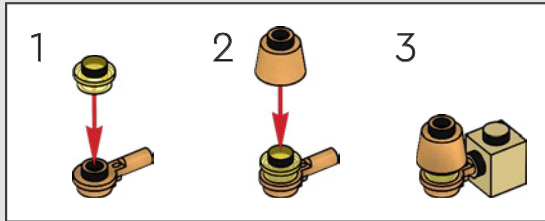

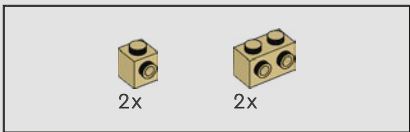

505

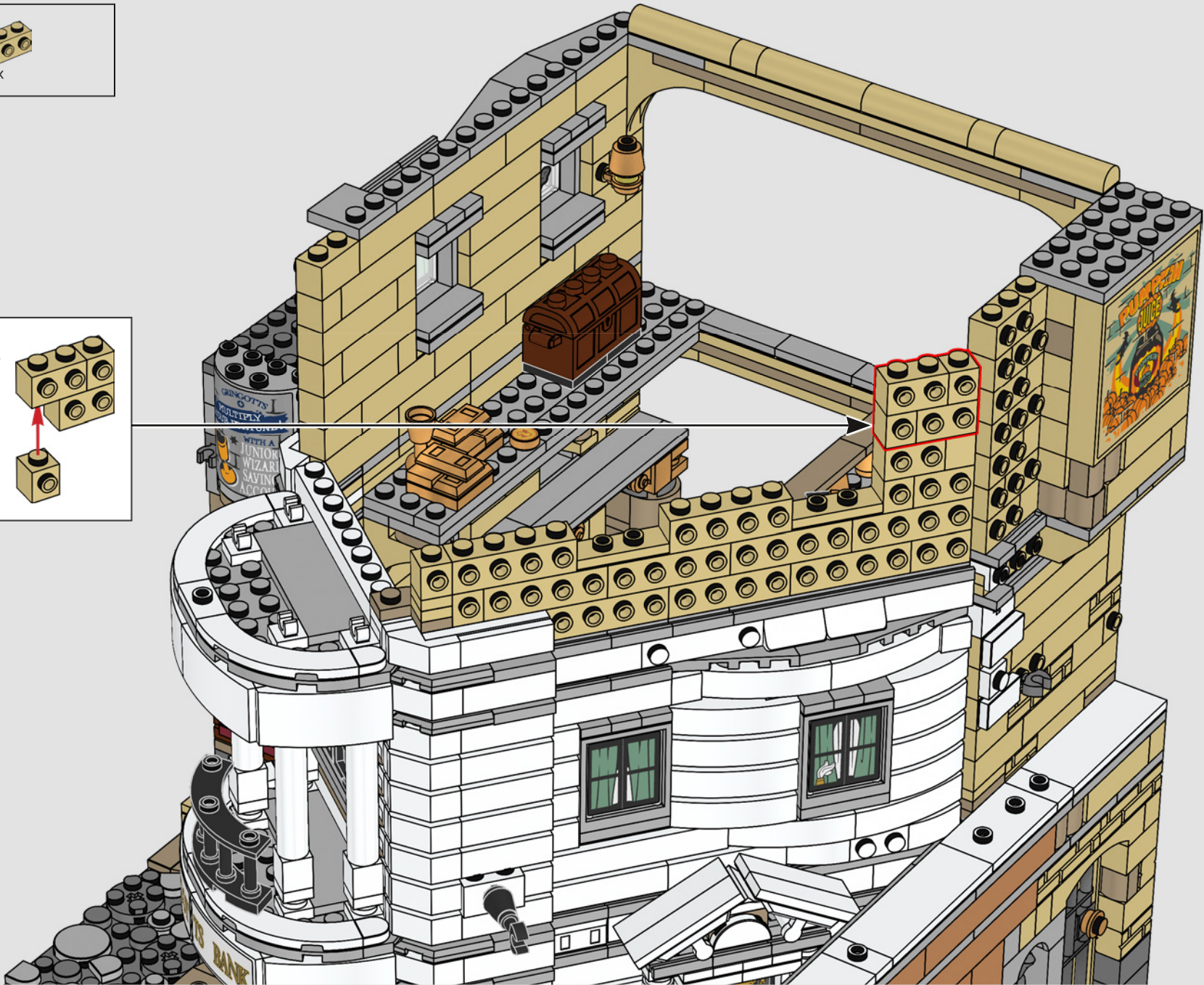
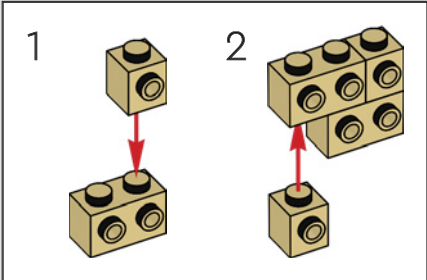

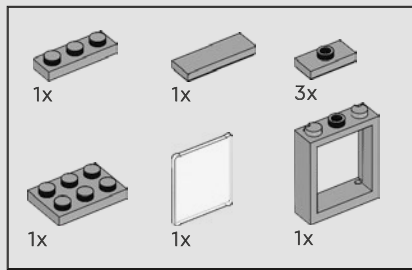

506

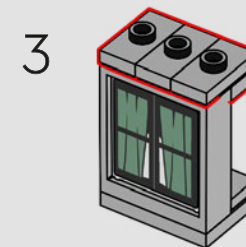
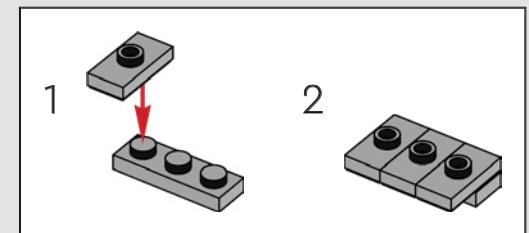
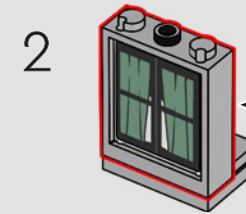
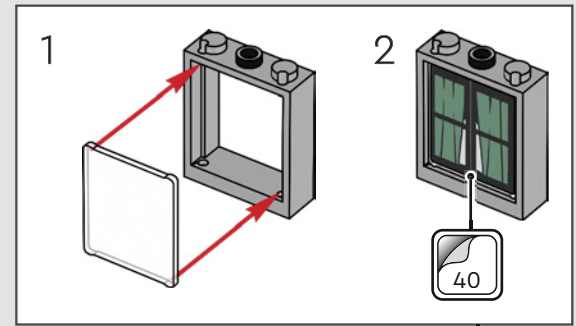
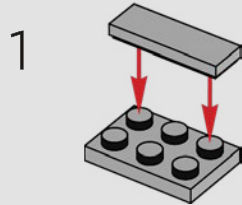

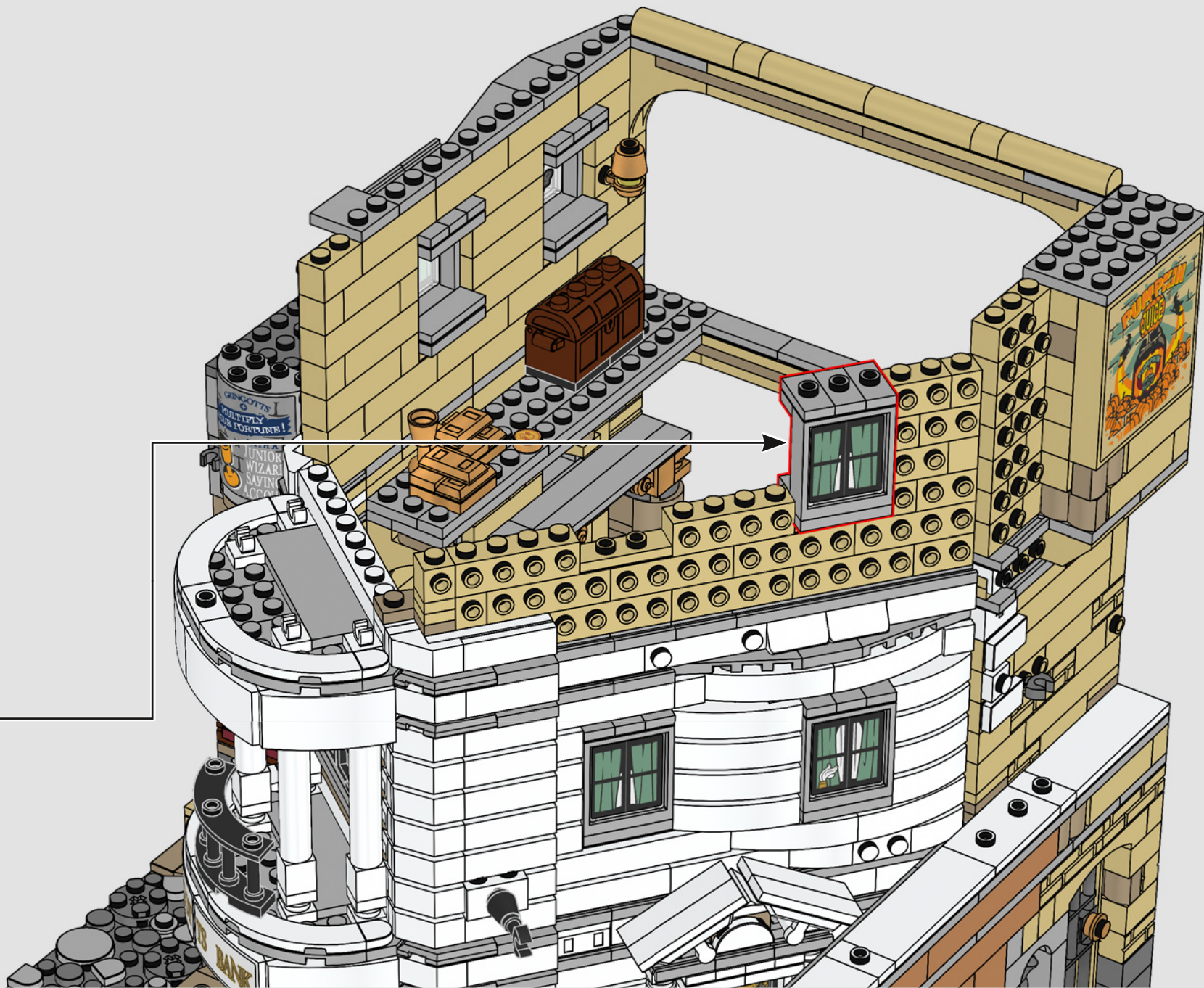



3x

507

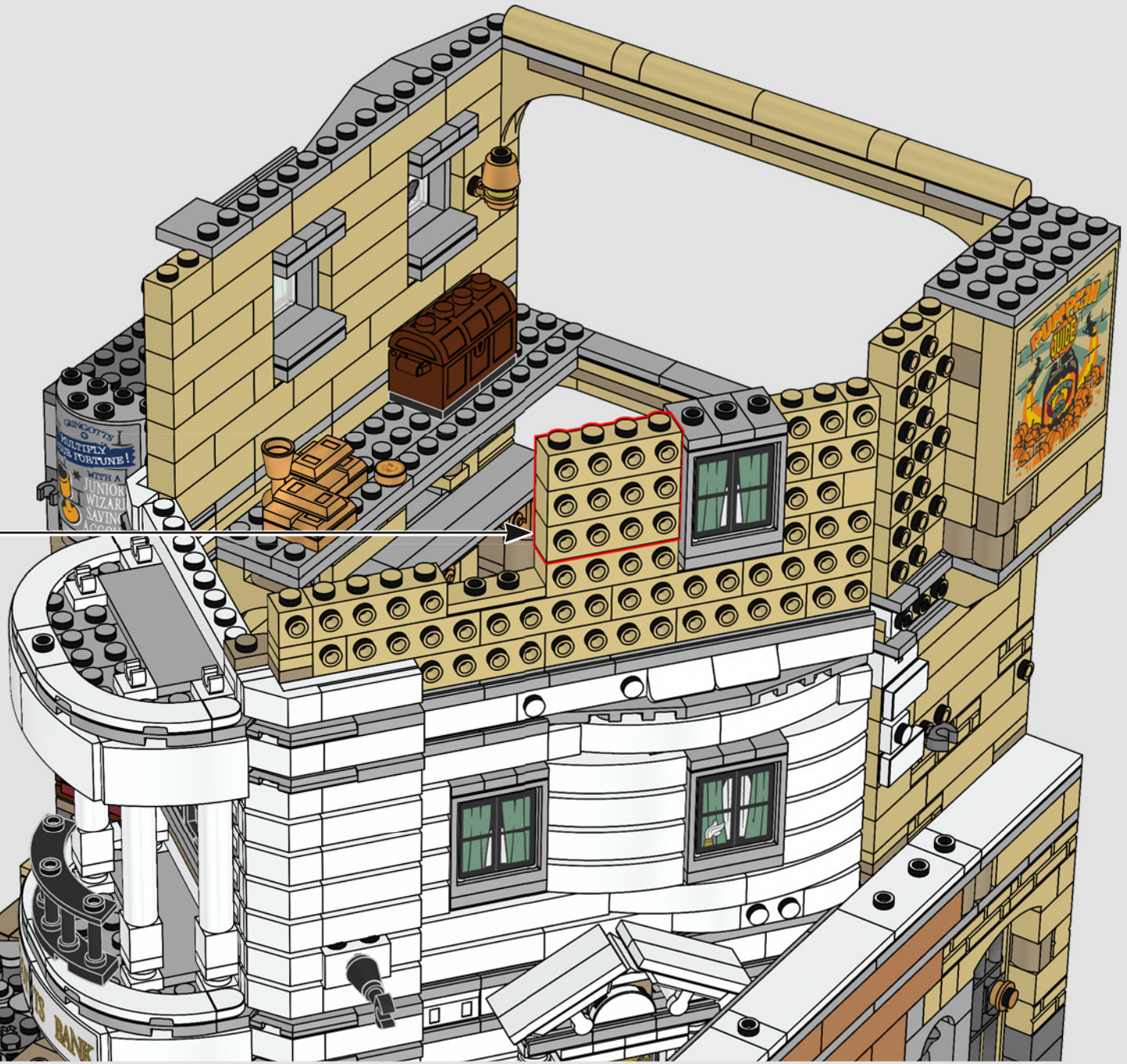
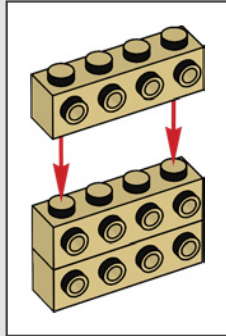

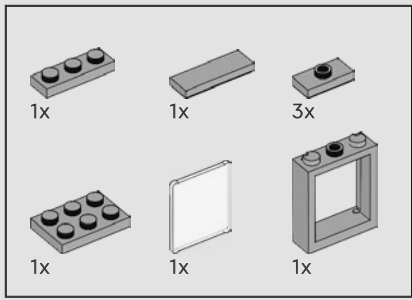

508

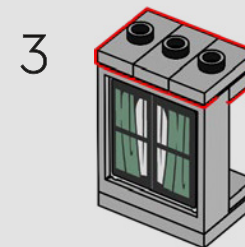
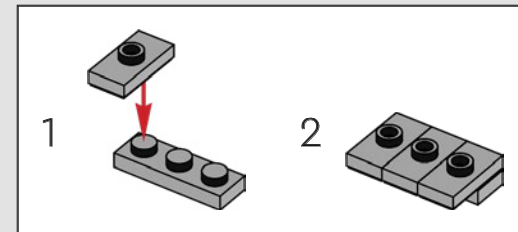
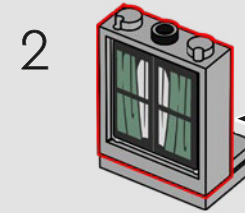
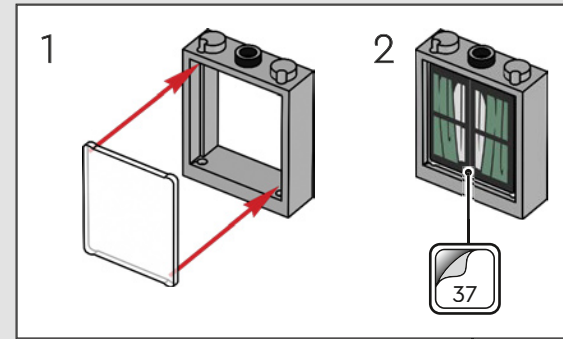
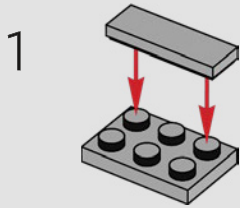



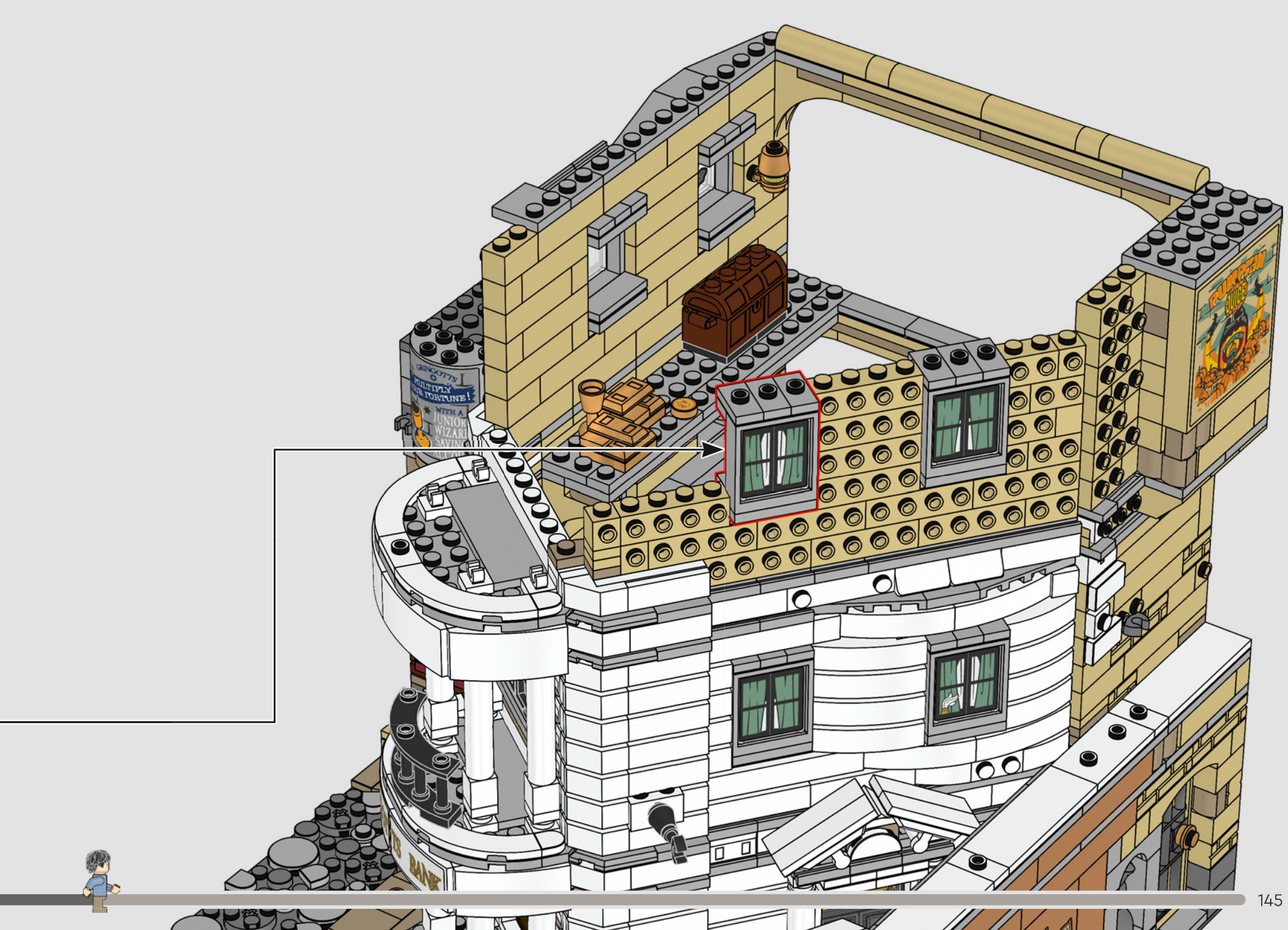

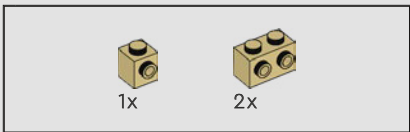

509

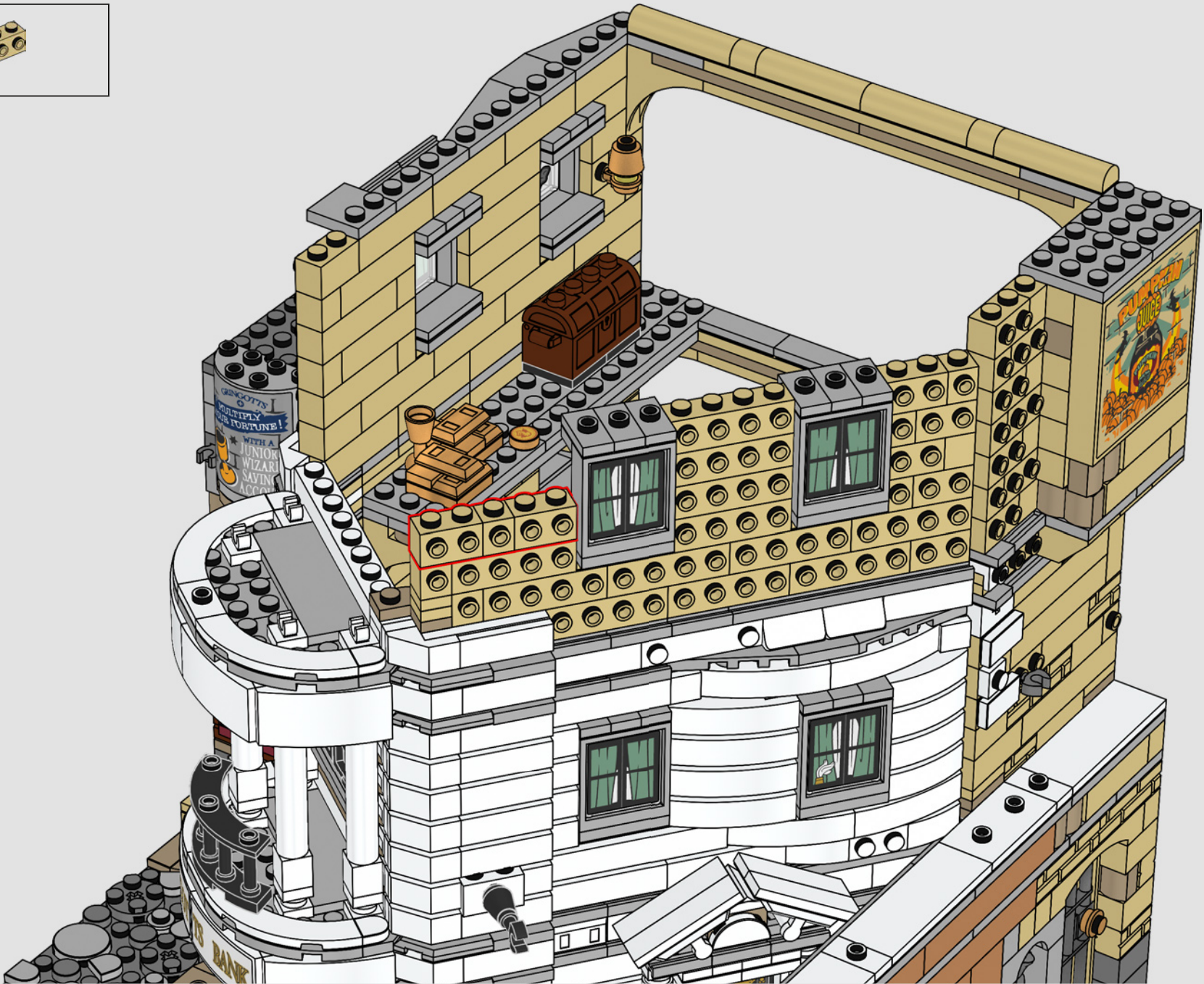

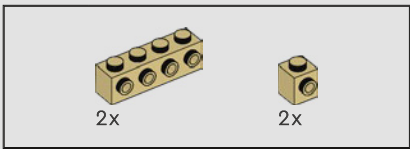

510

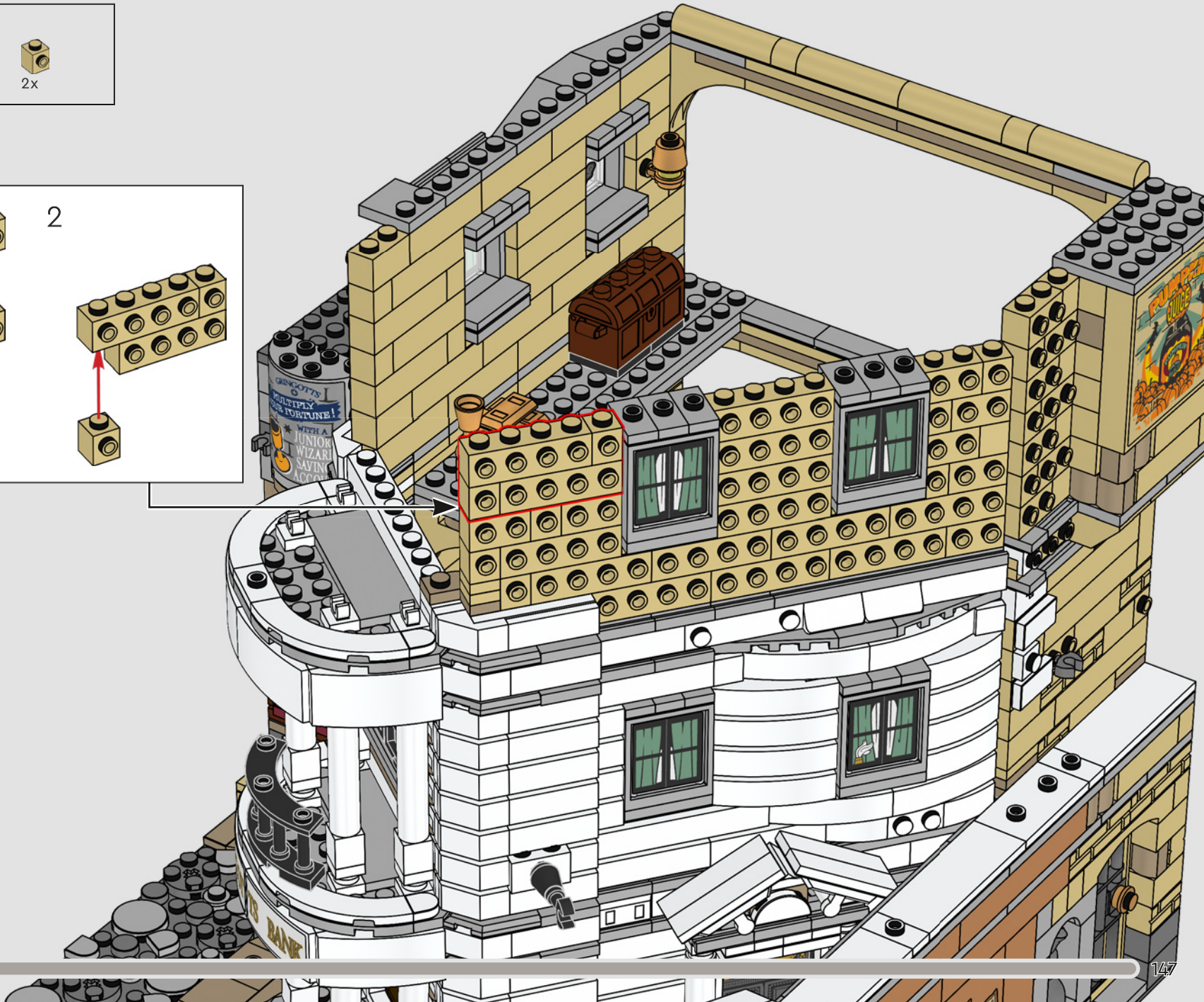
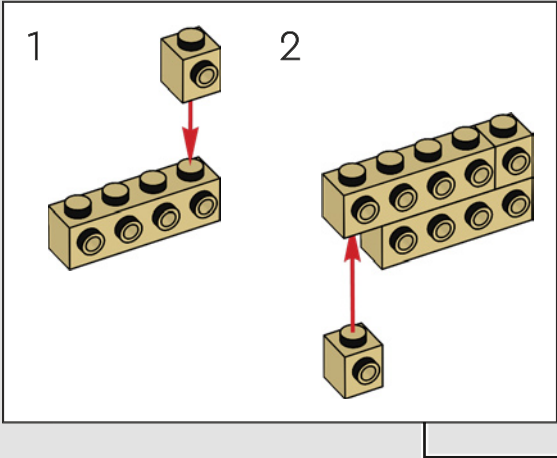



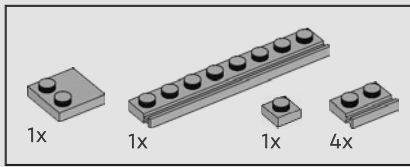

512

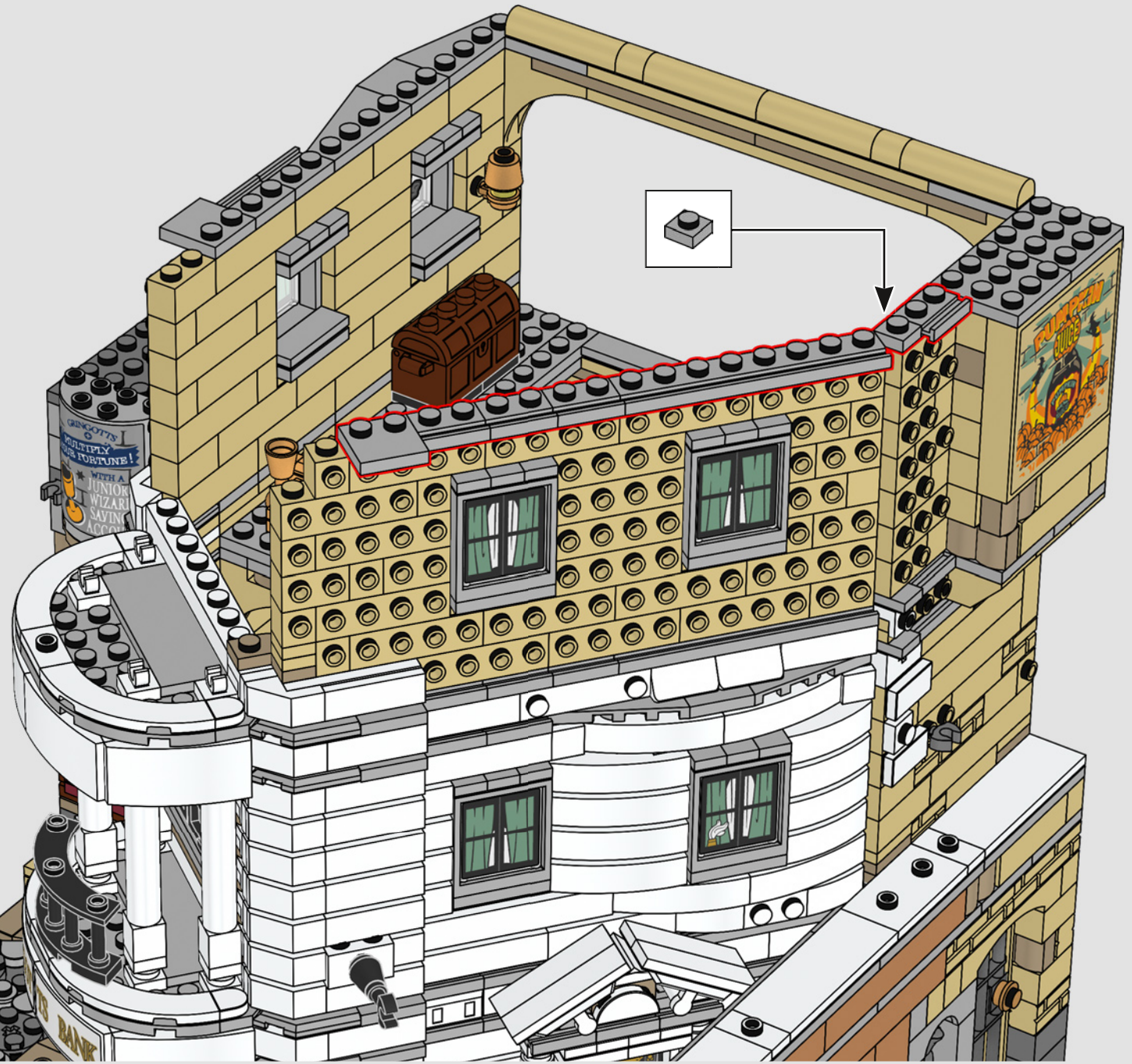

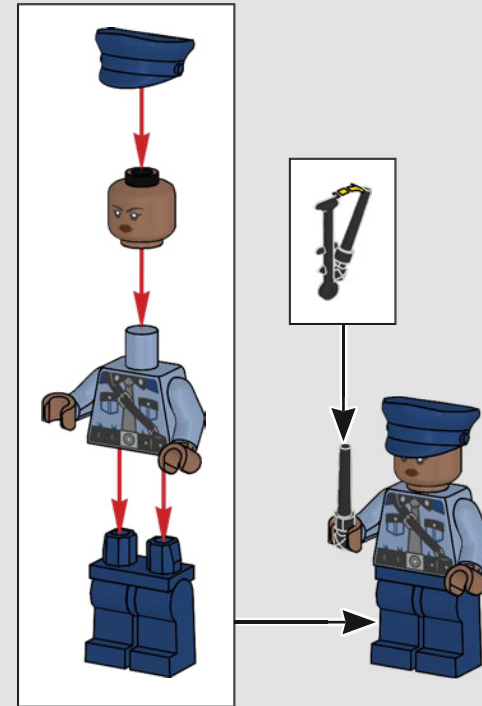

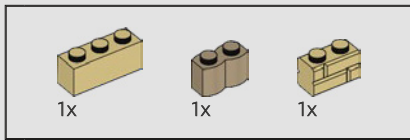

513

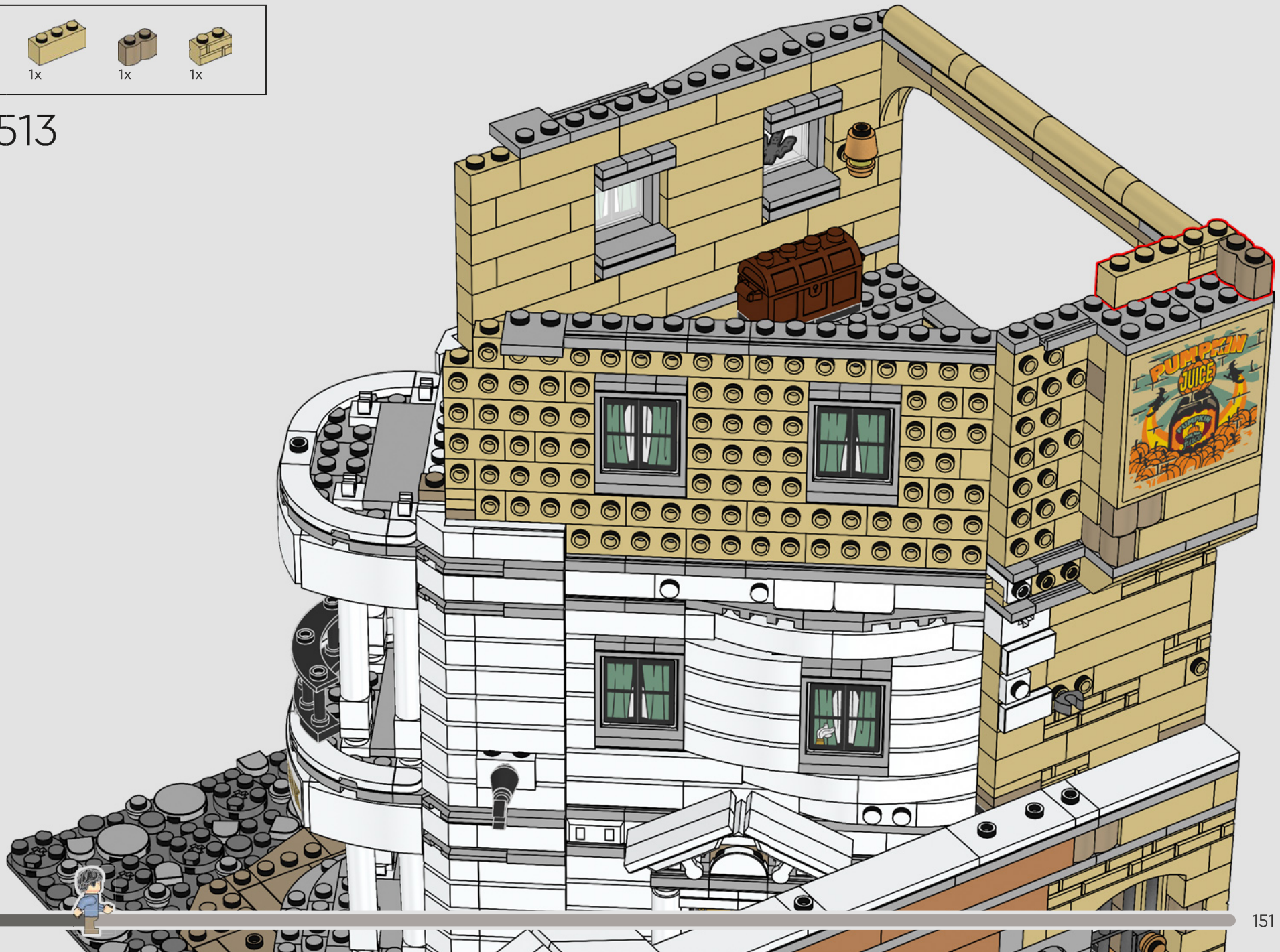

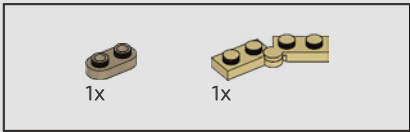
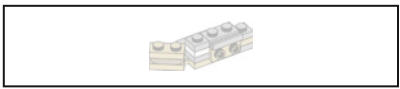

514

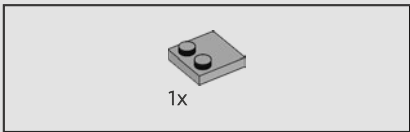
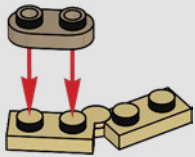

515

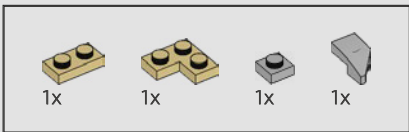
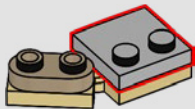

516

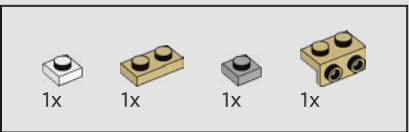
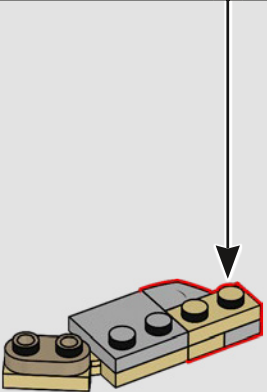
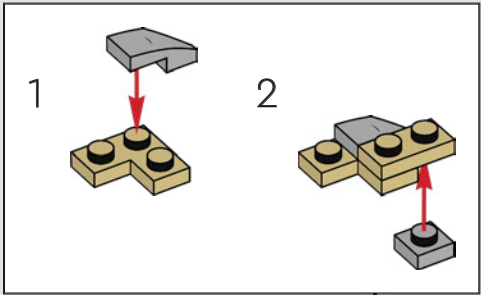

517

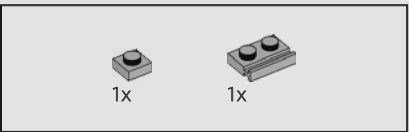
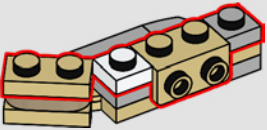

518

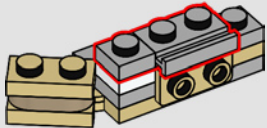



519

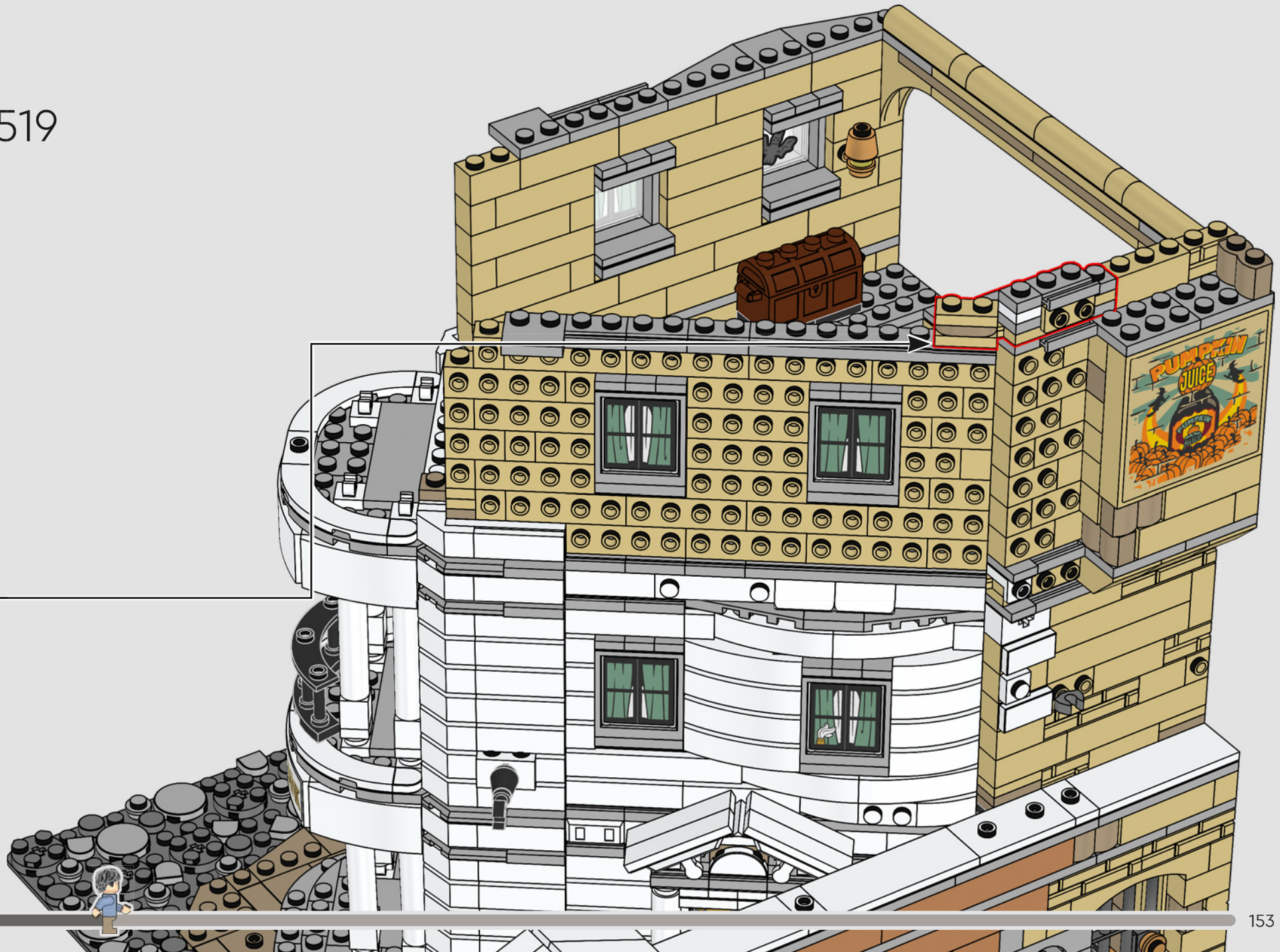

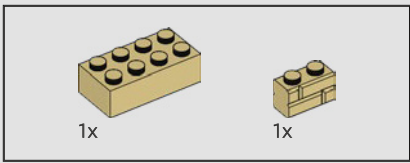

520

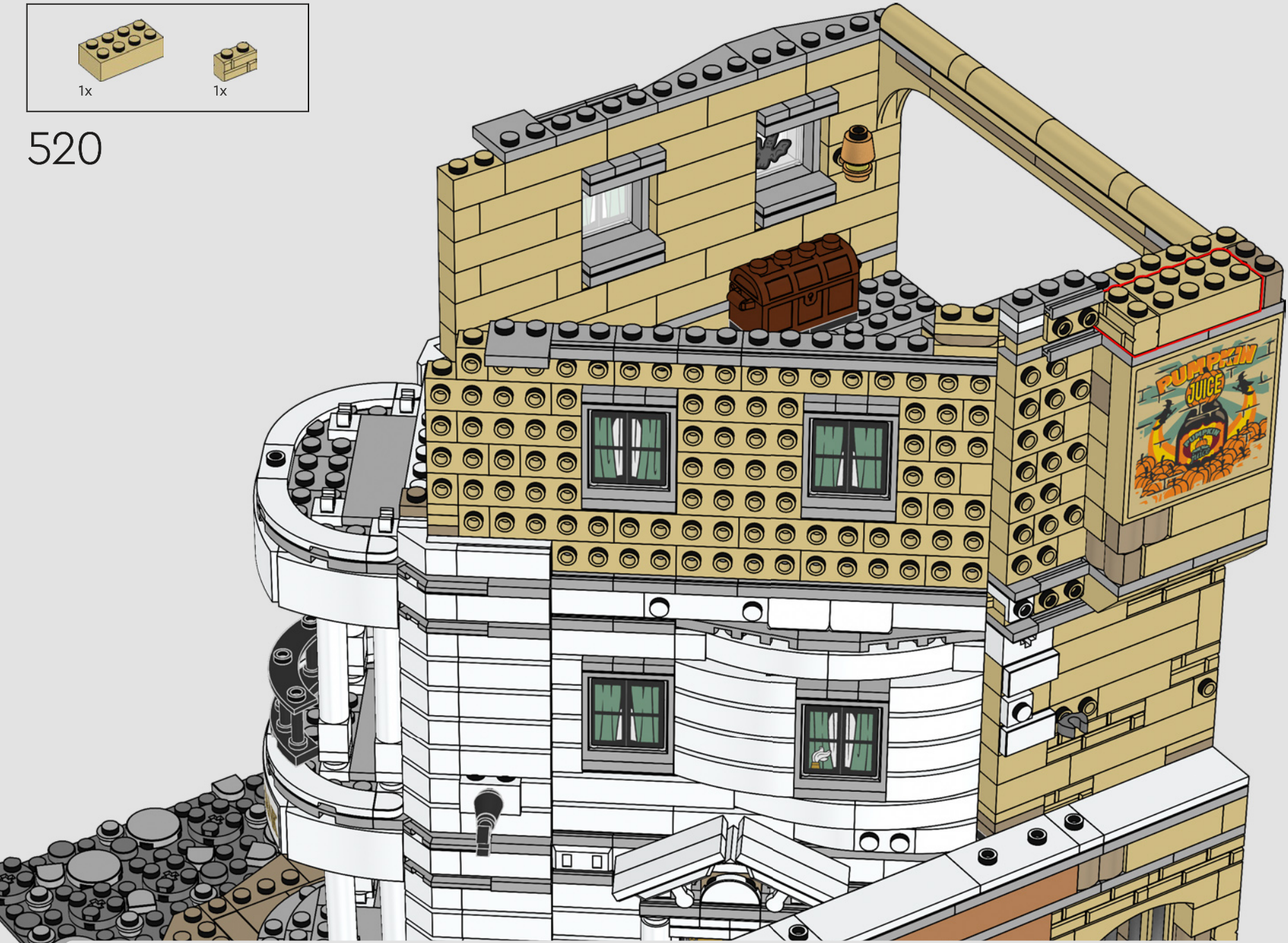

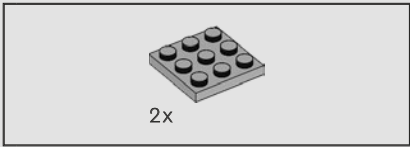

521

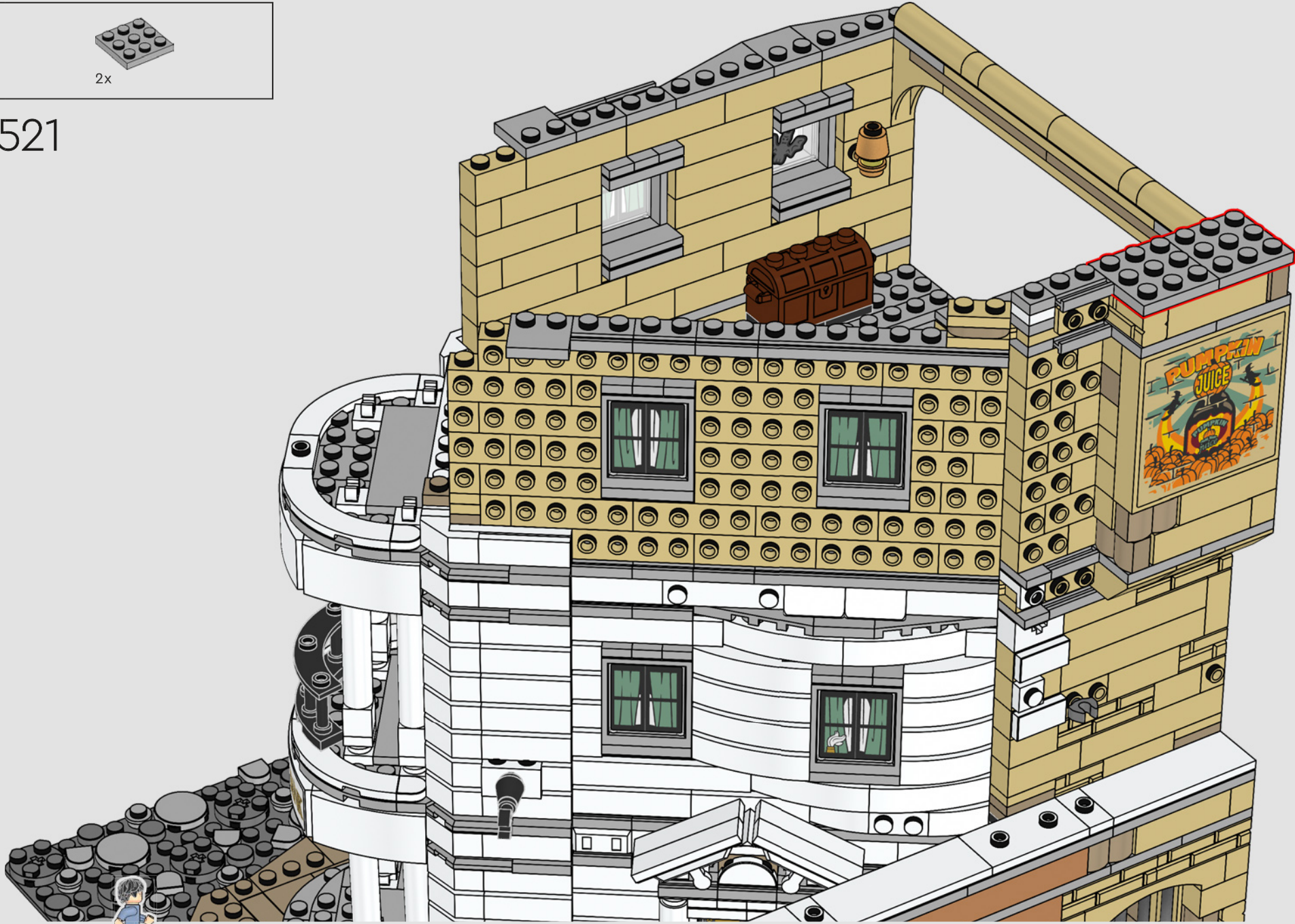

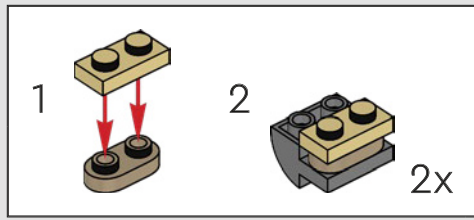
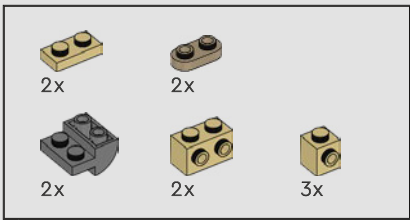

522

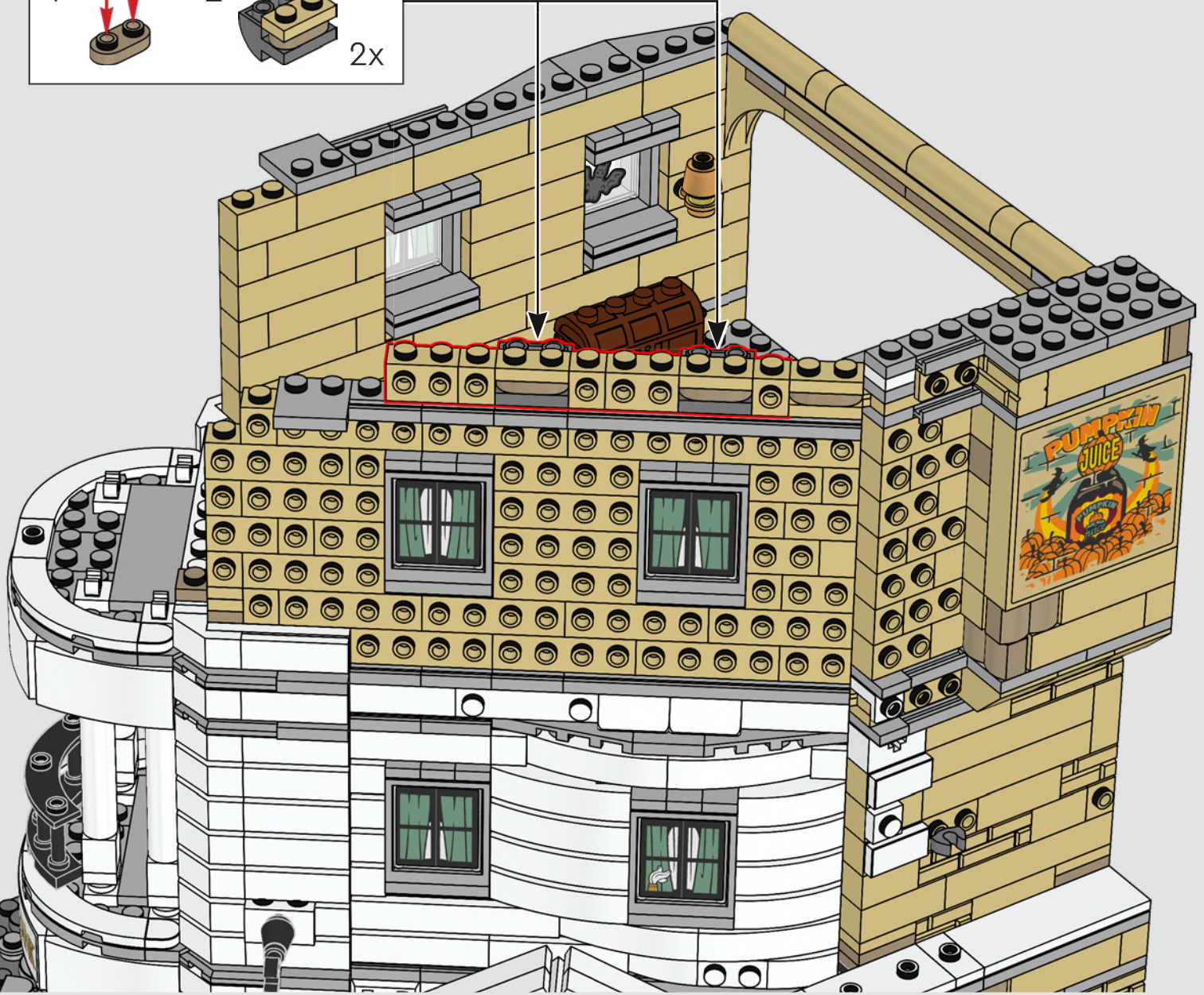

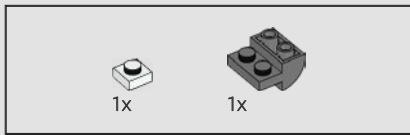

523

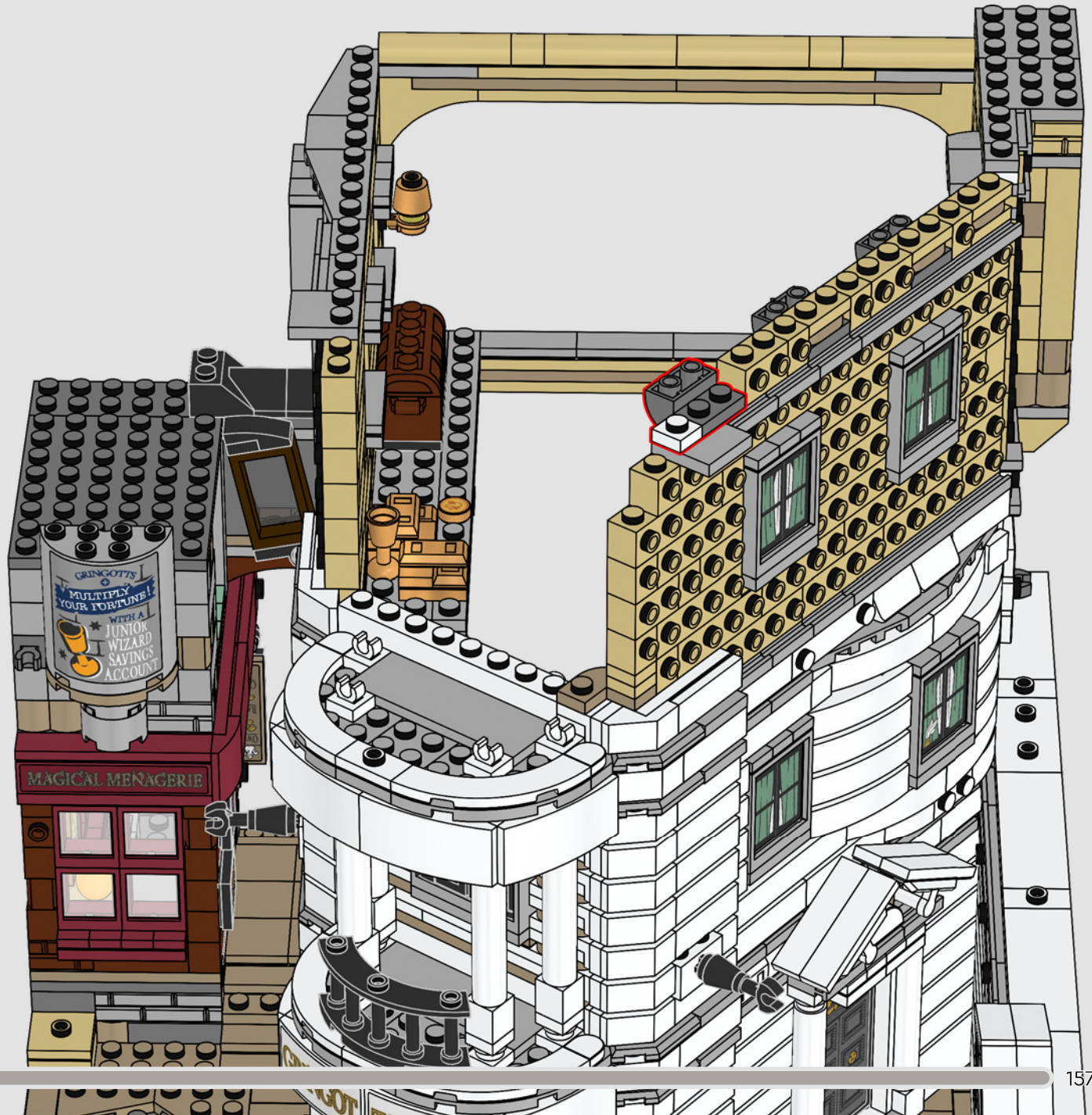

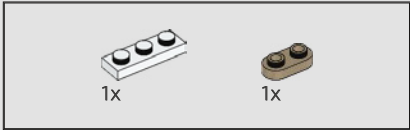
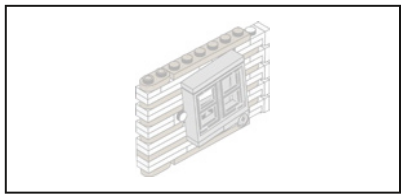

524

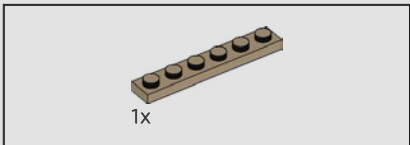
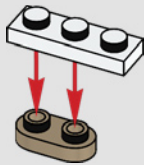

525

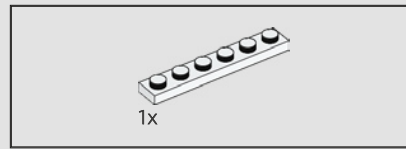
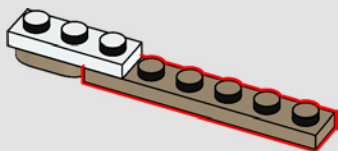

526

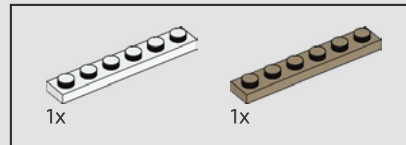
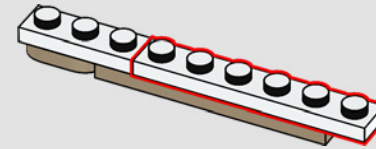

527

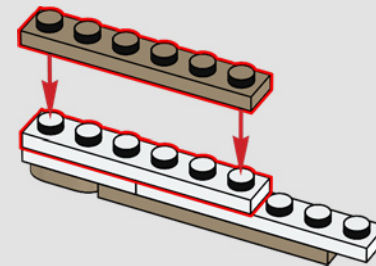

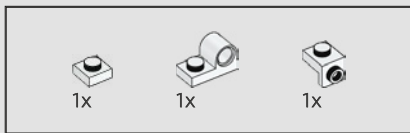

528

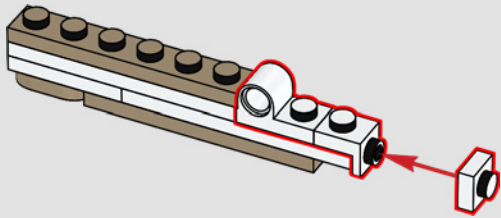

529

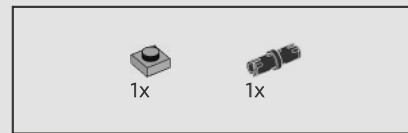
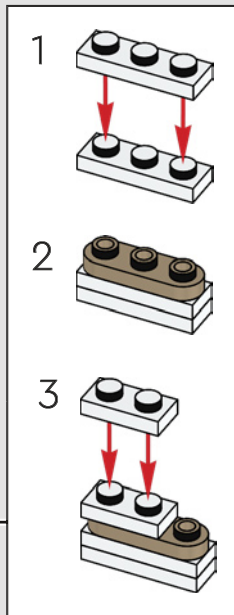
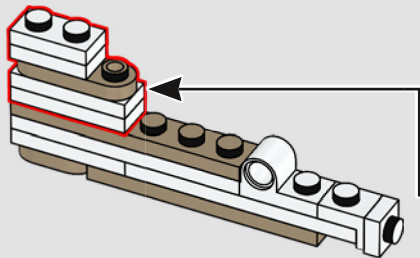

530

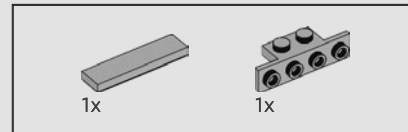
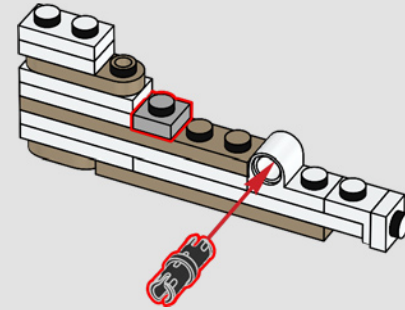

531

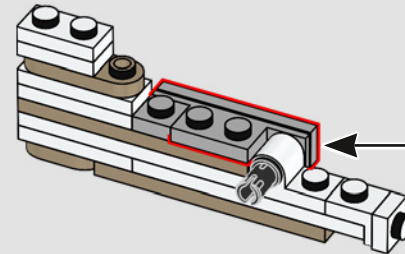
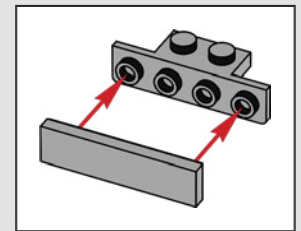

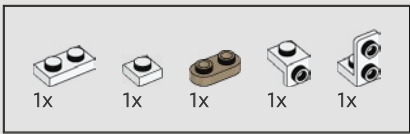

532

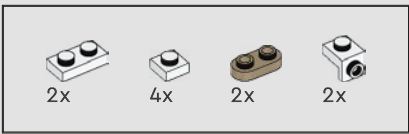
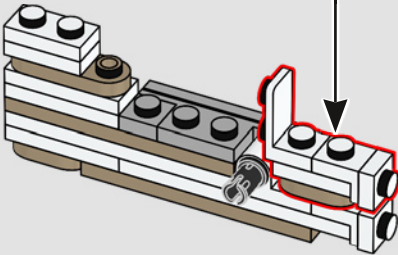
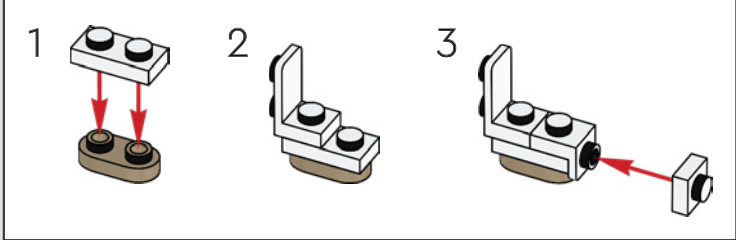

533

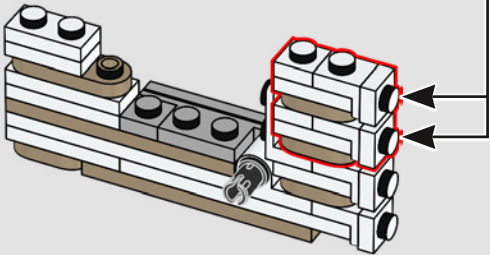
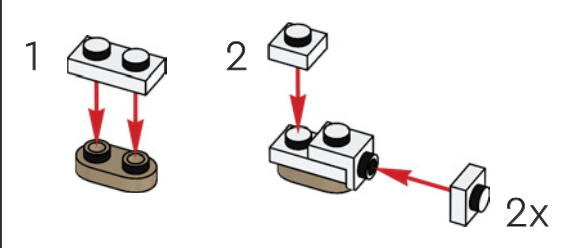



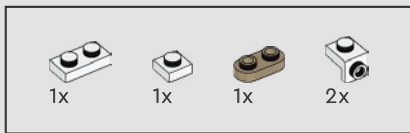

534

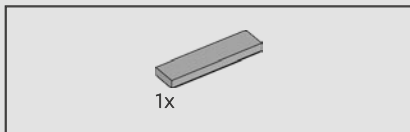
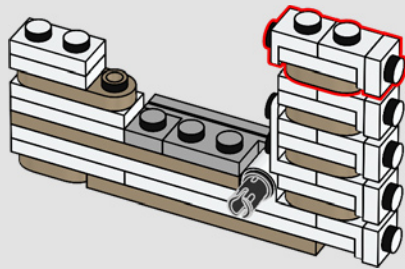
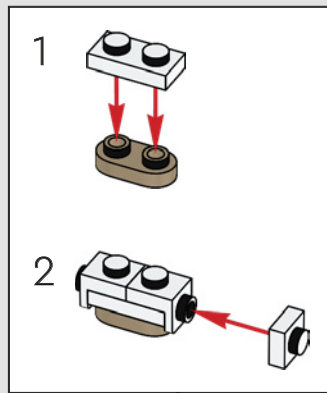

535

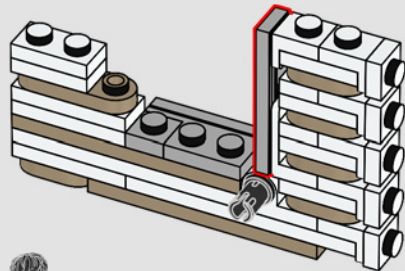

536

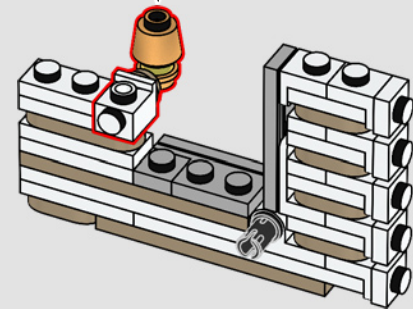
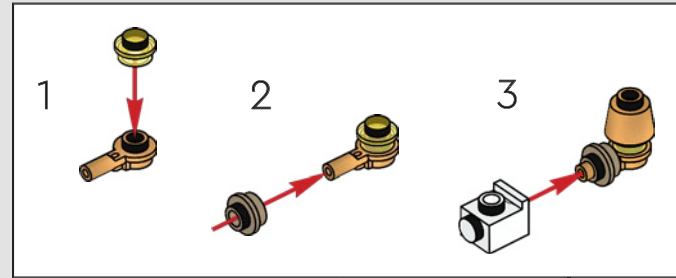



537

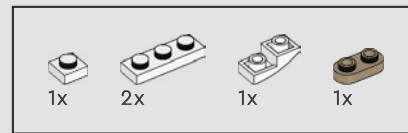
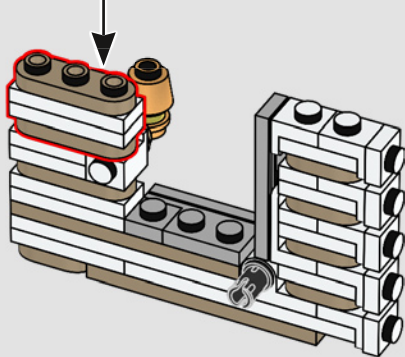
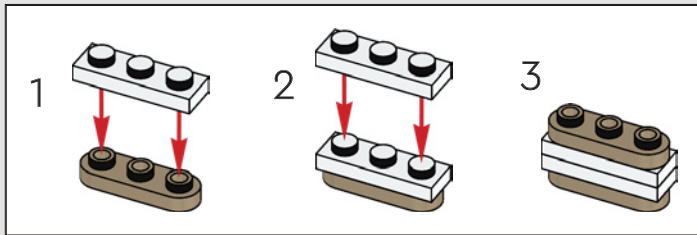

538

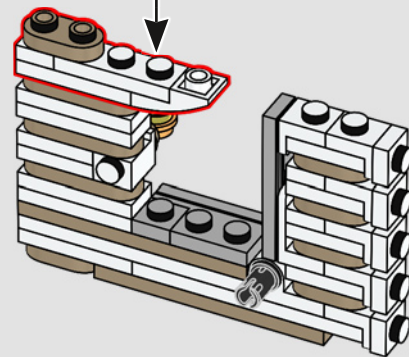
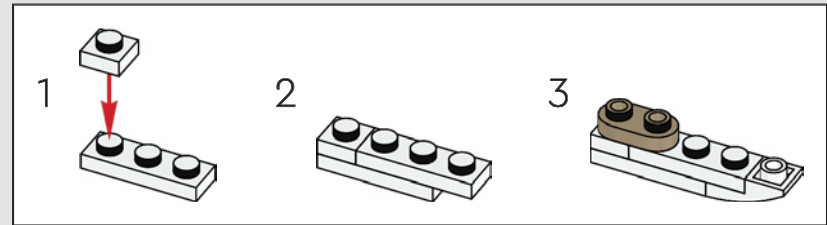

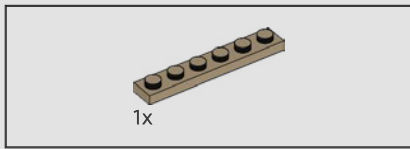

539

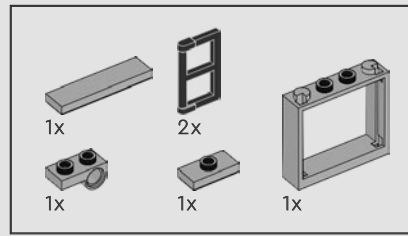
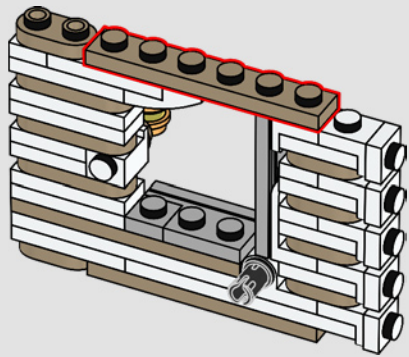

540

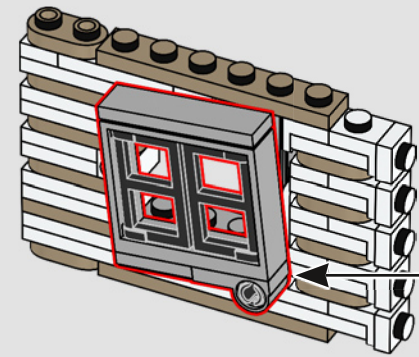
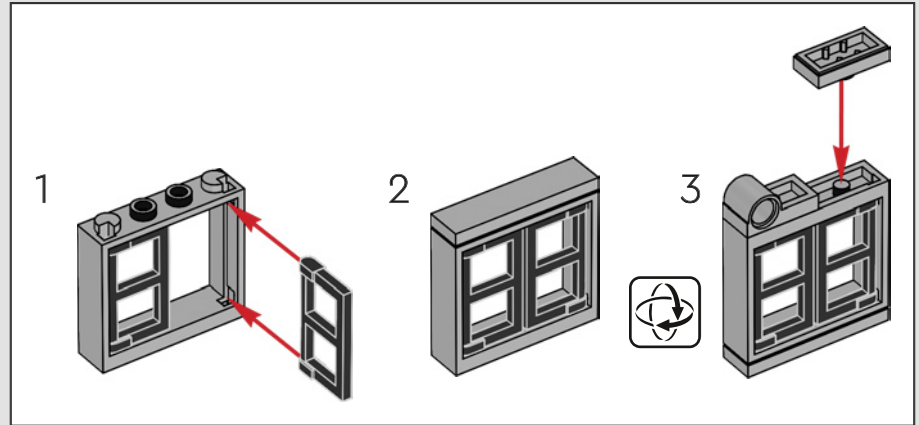

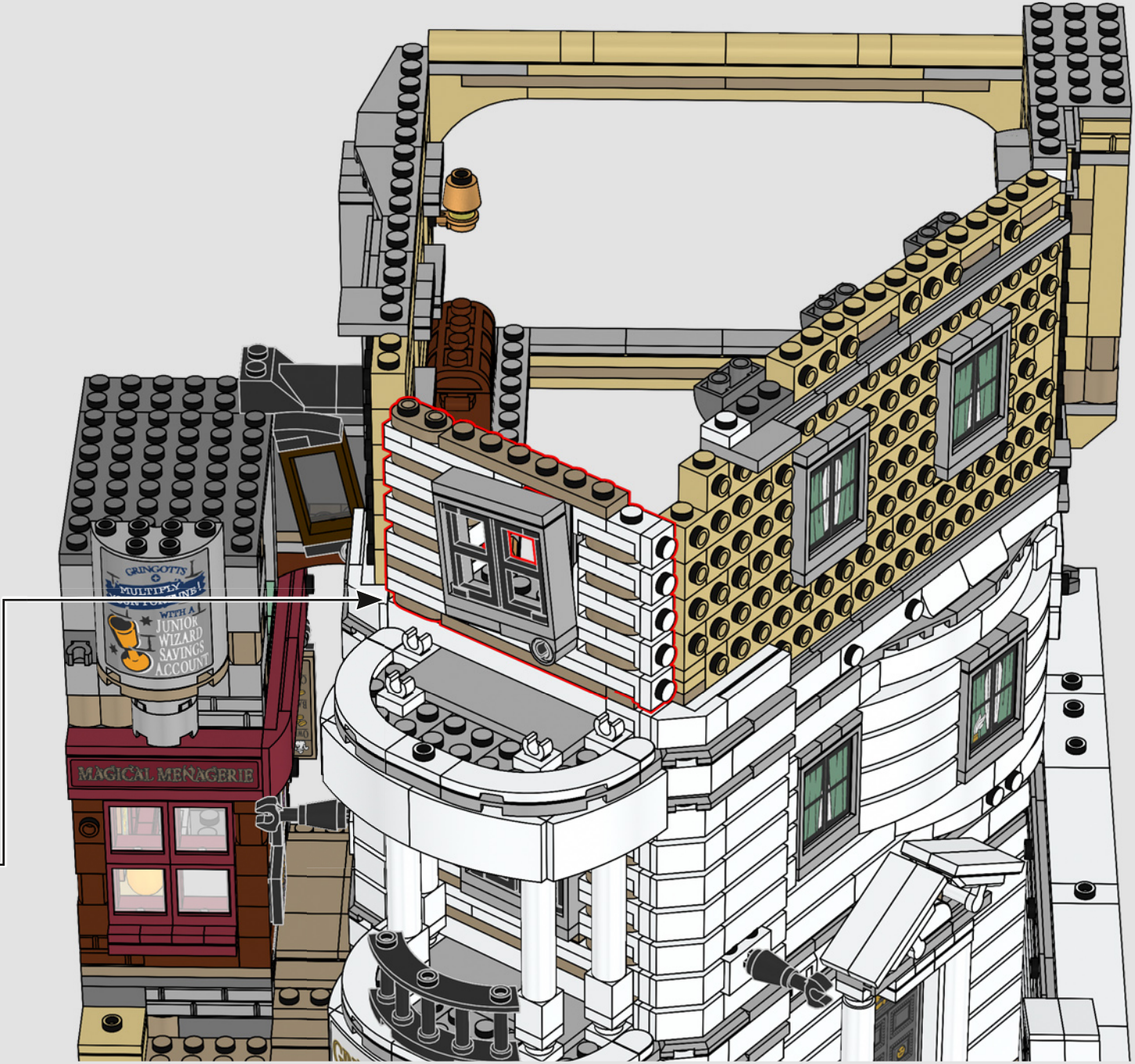

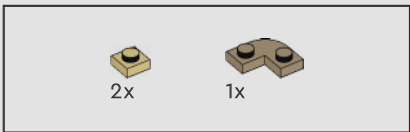

542

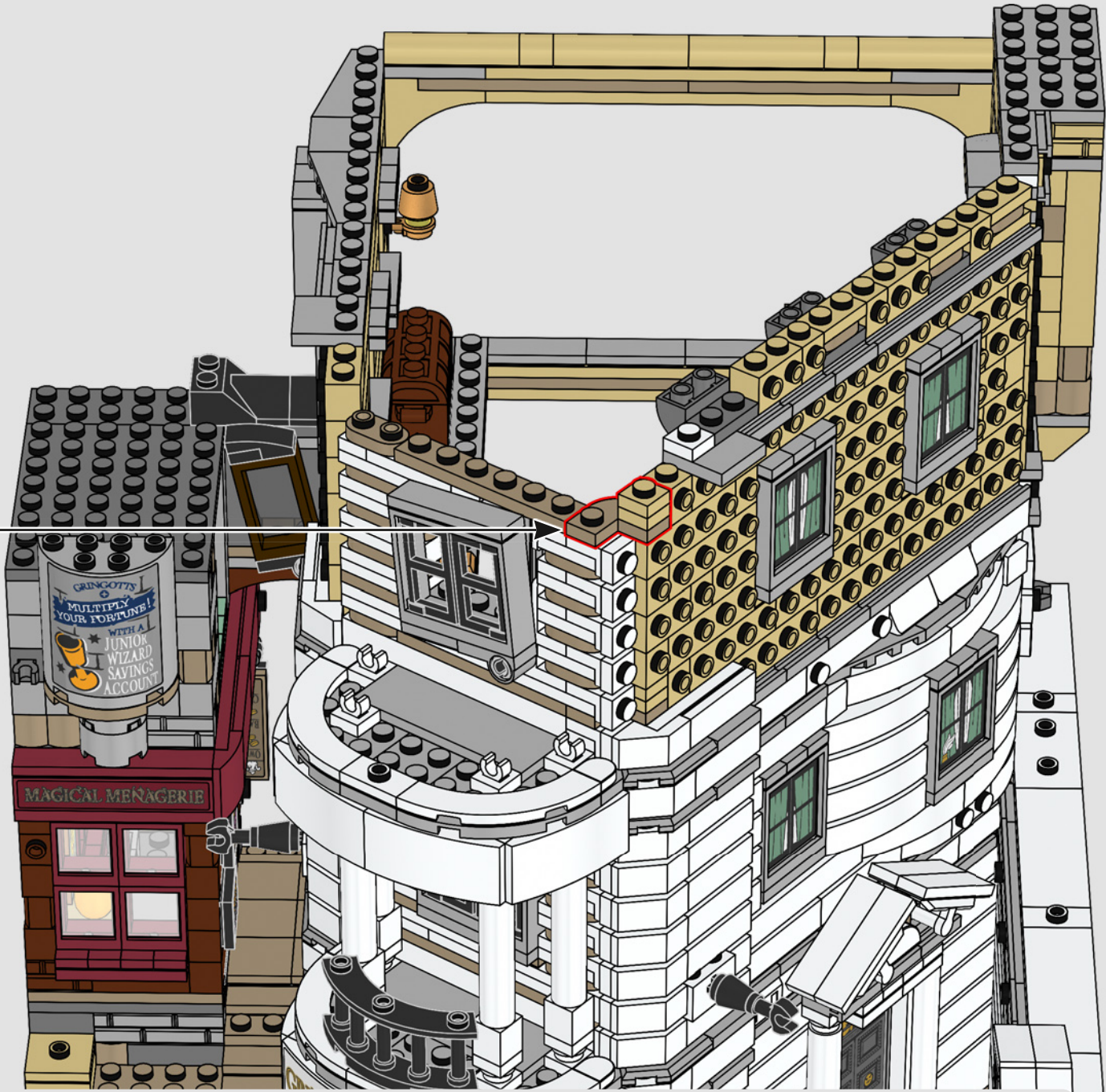
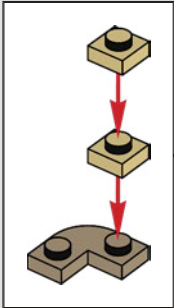

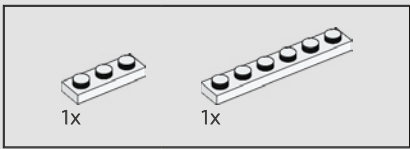

543

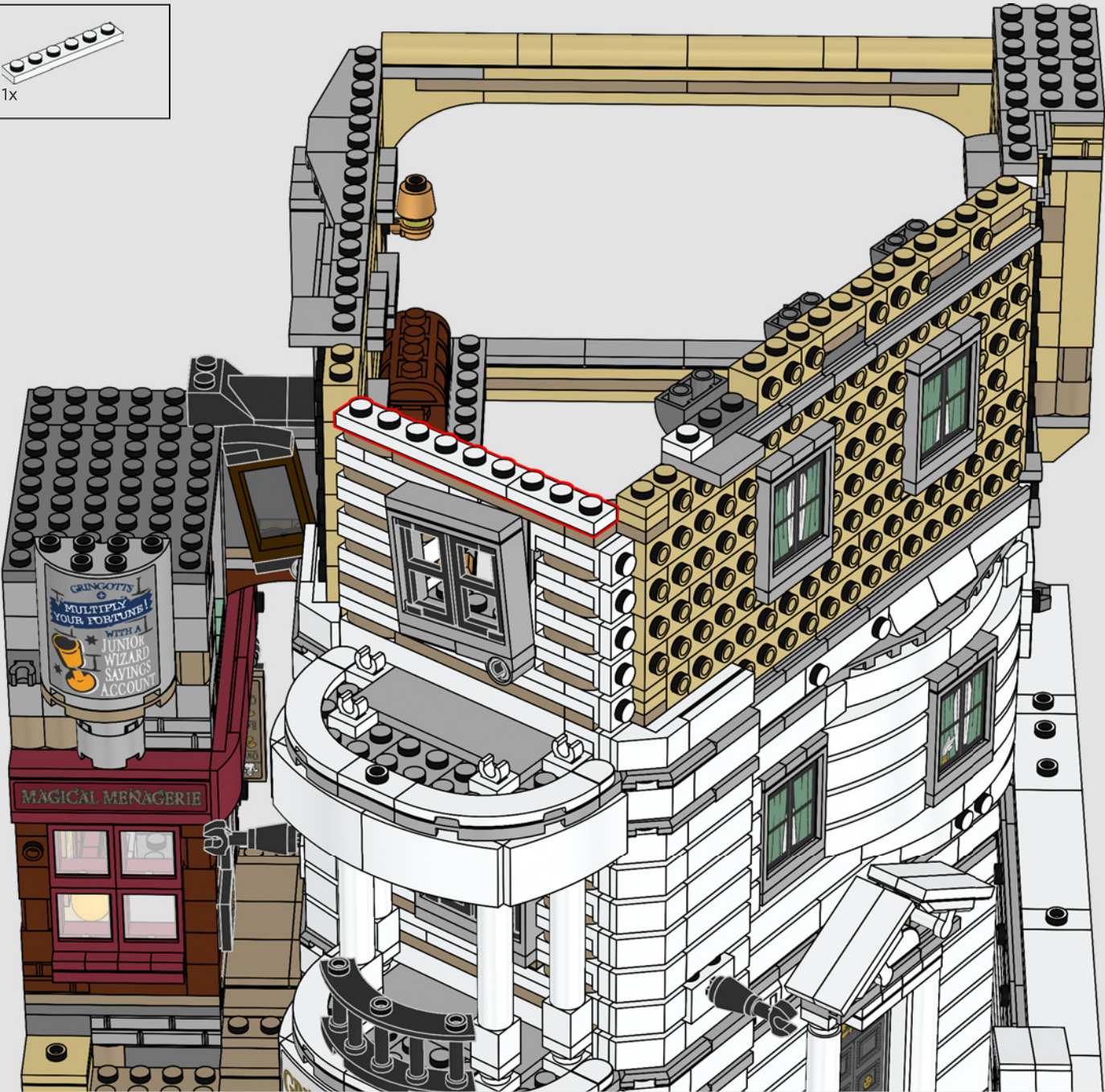

2x

1x

544

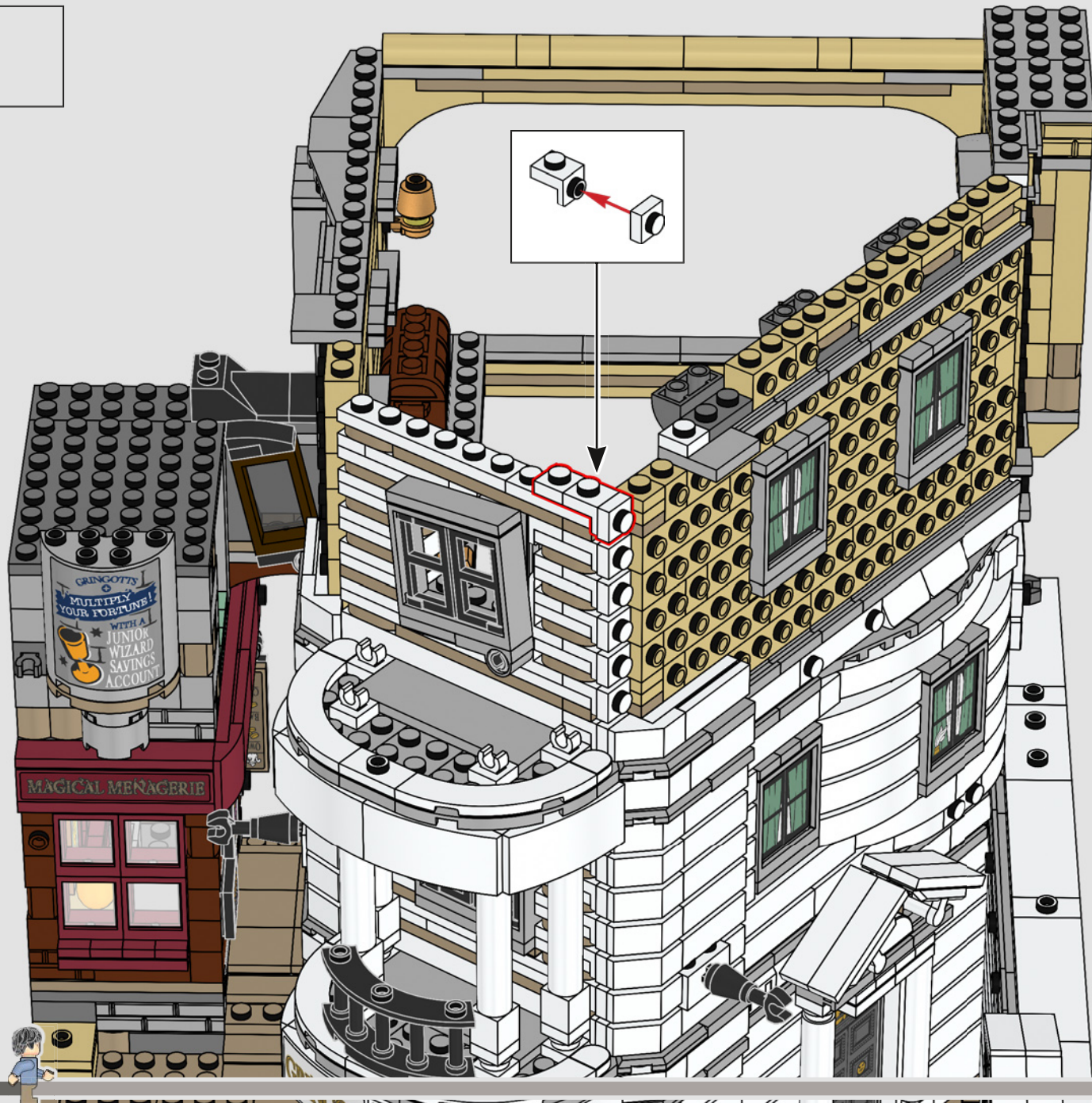

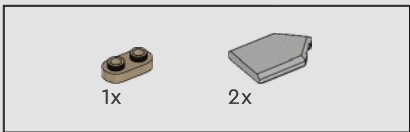

545

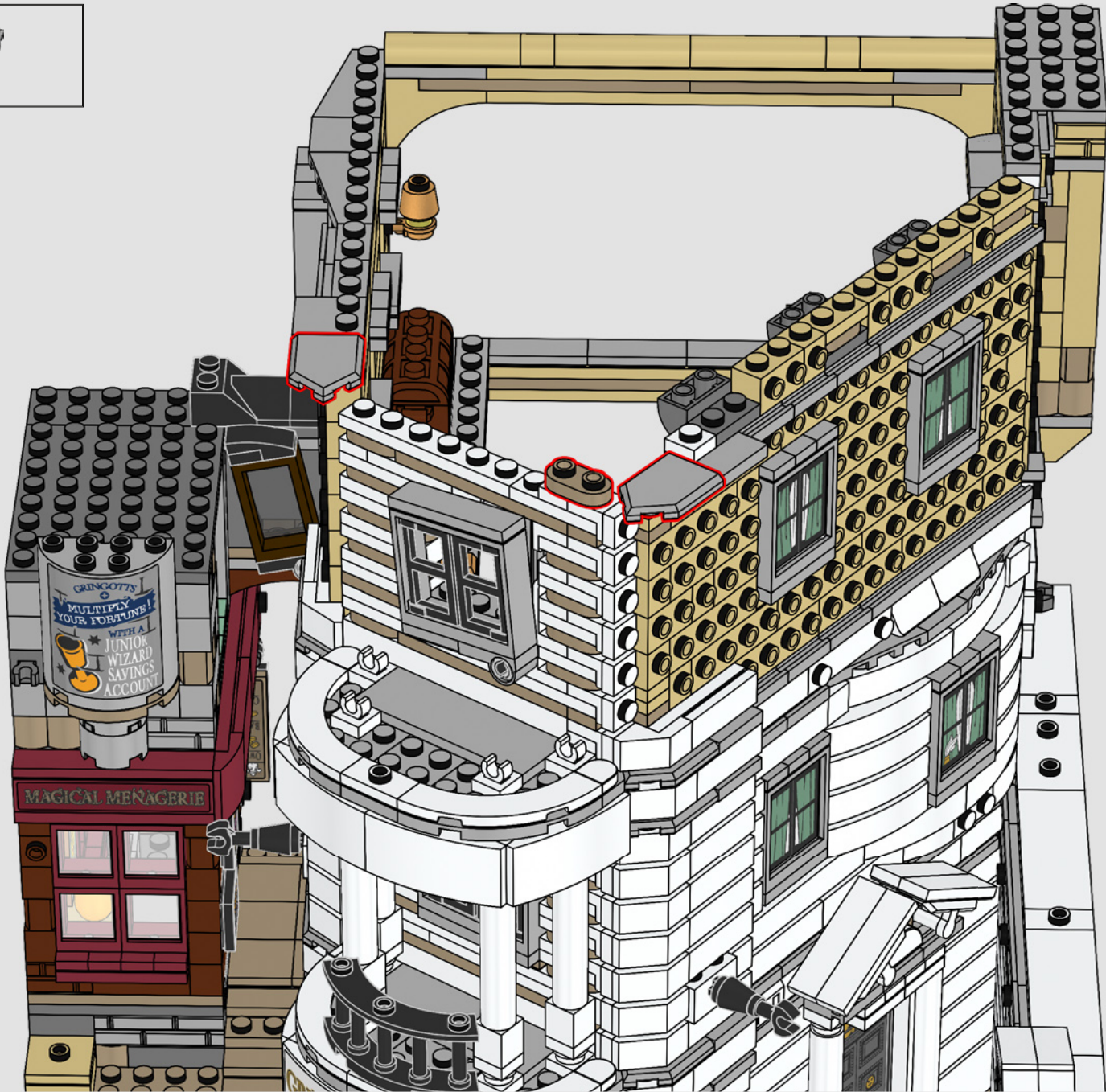



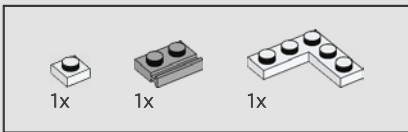

546

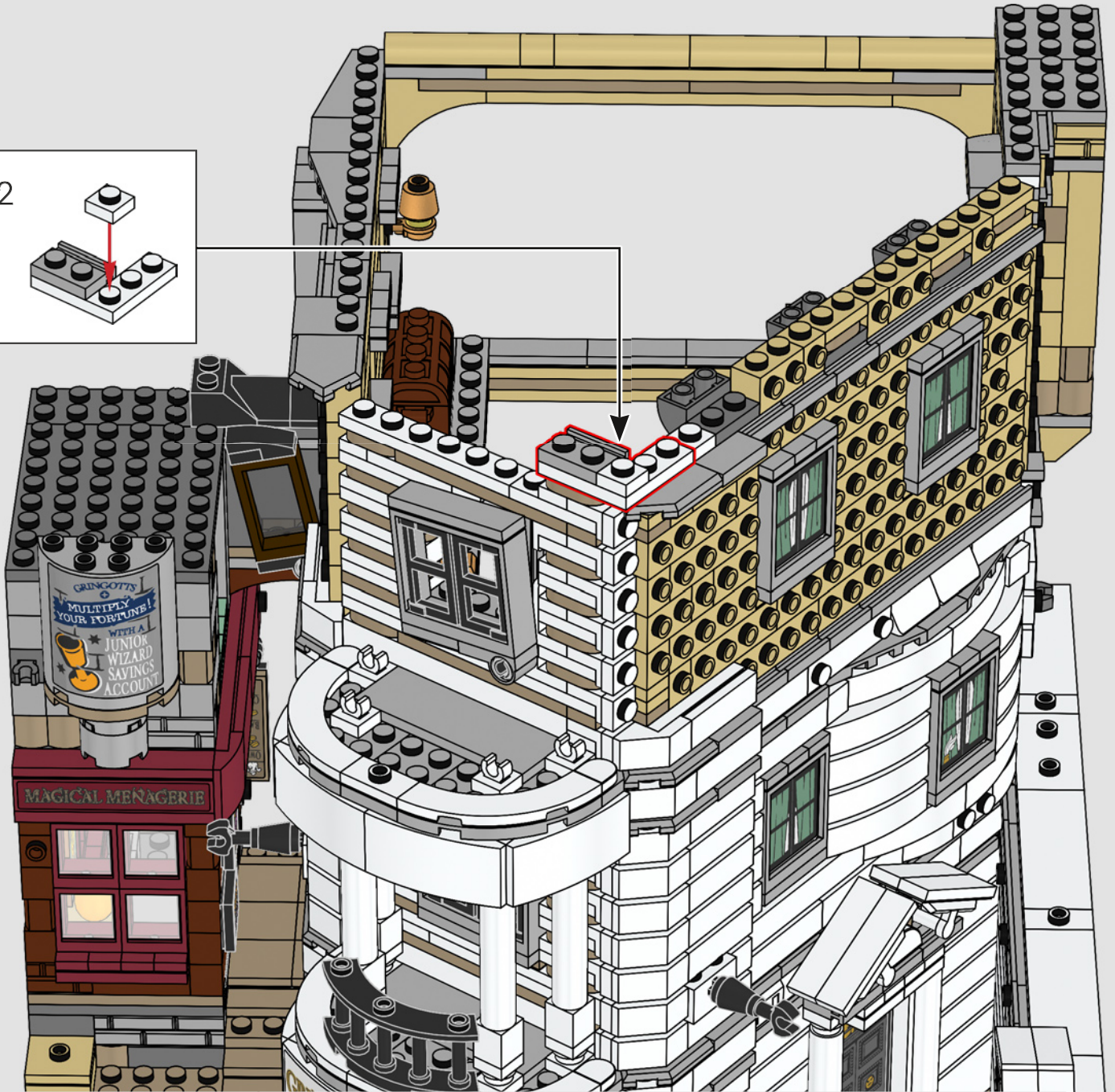
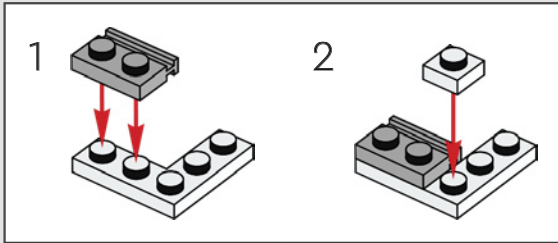

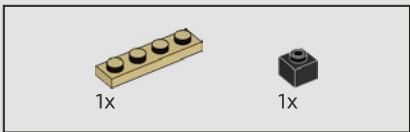

547

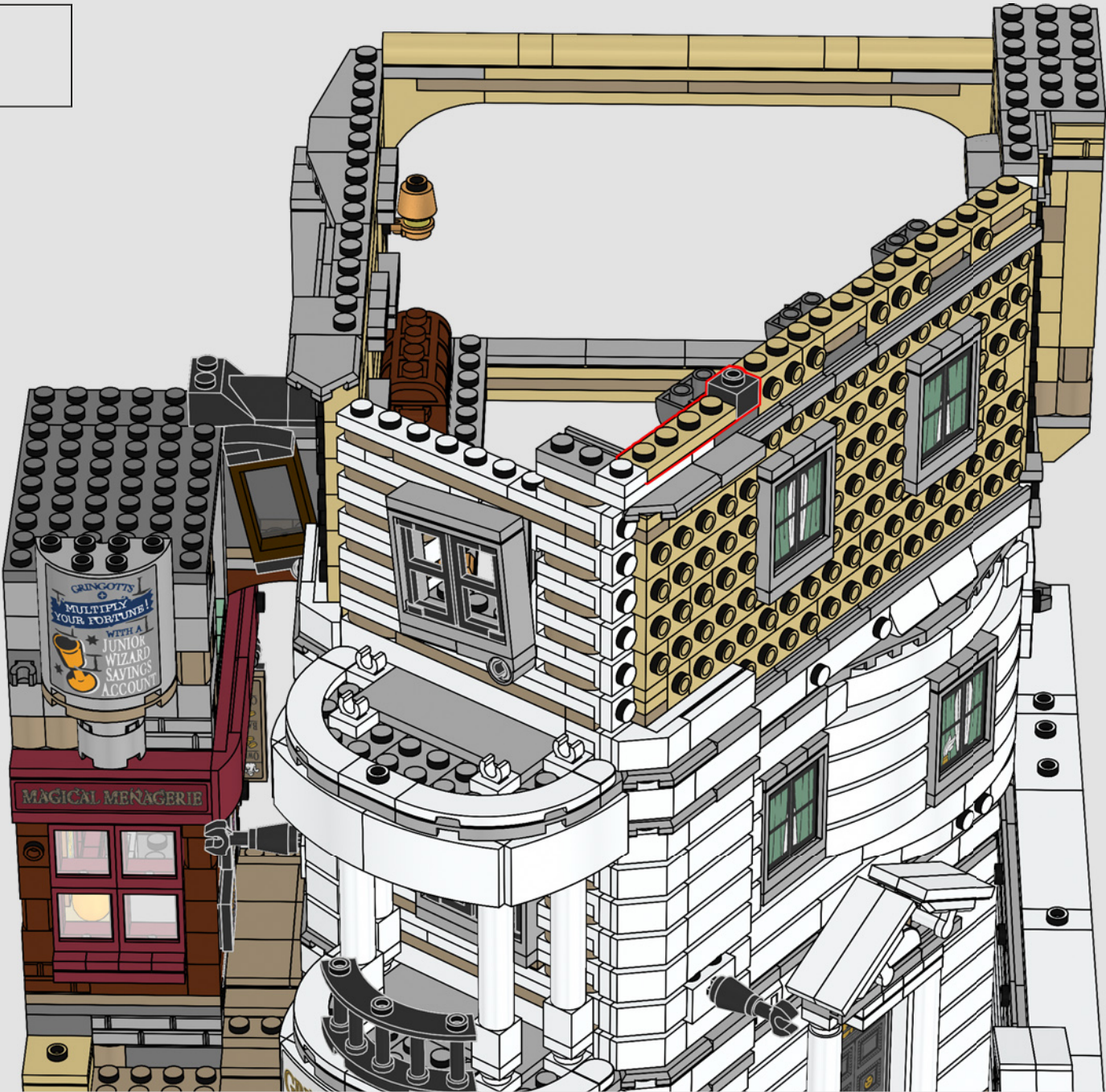



2x

548

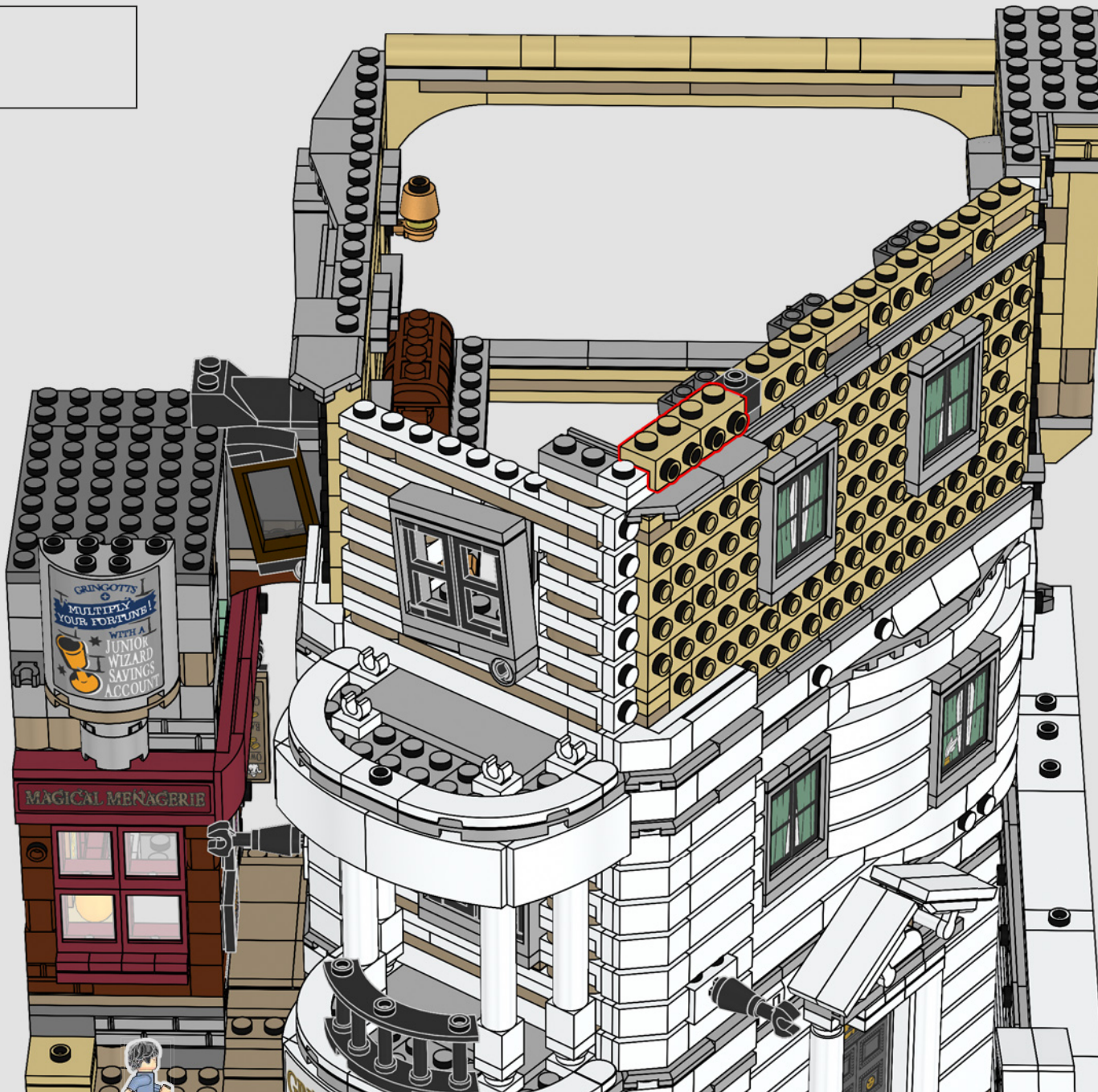

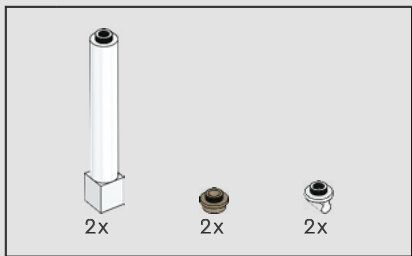

549

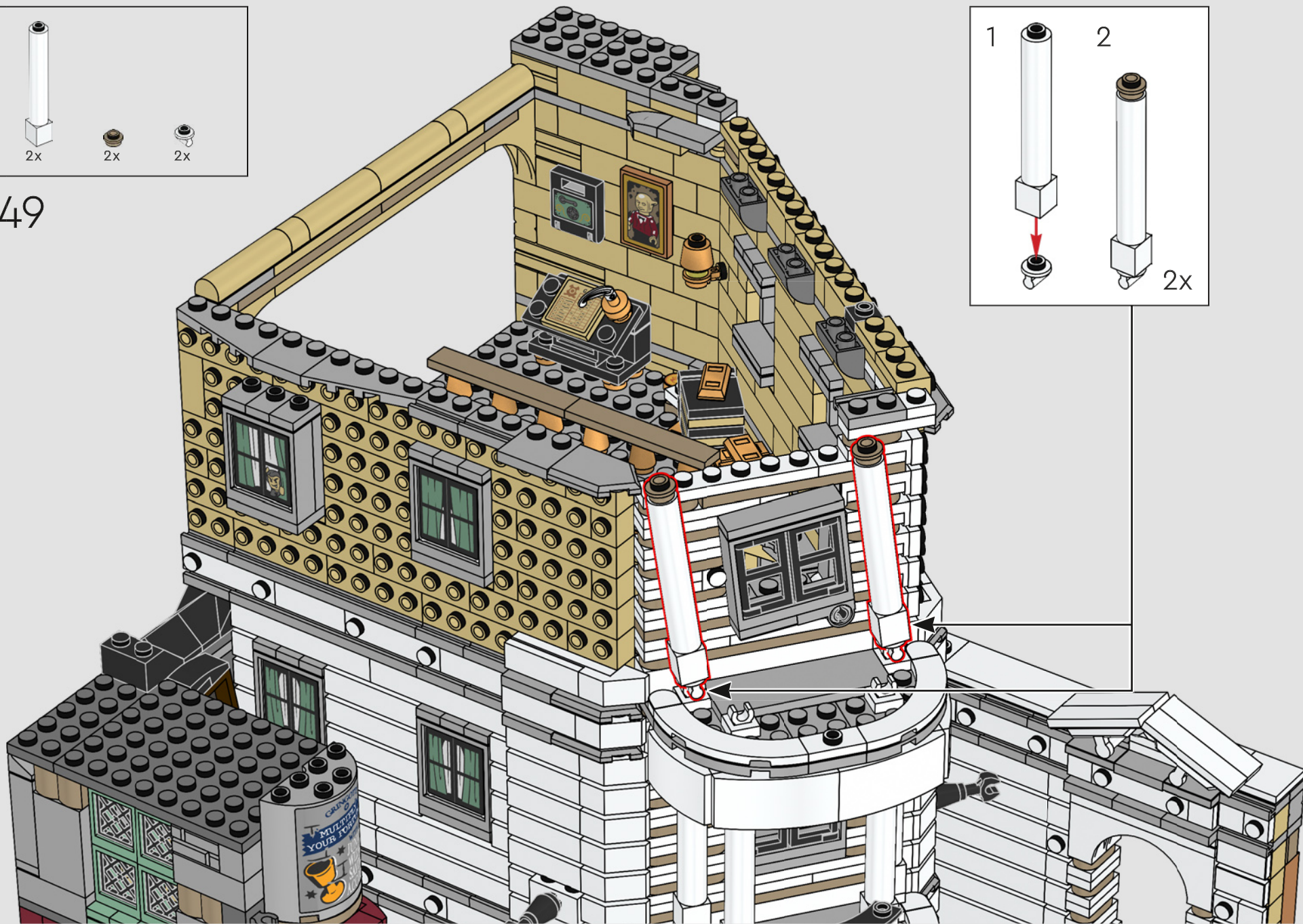
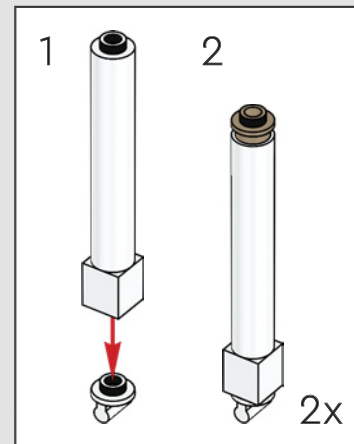

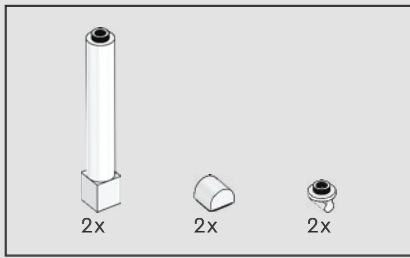

550

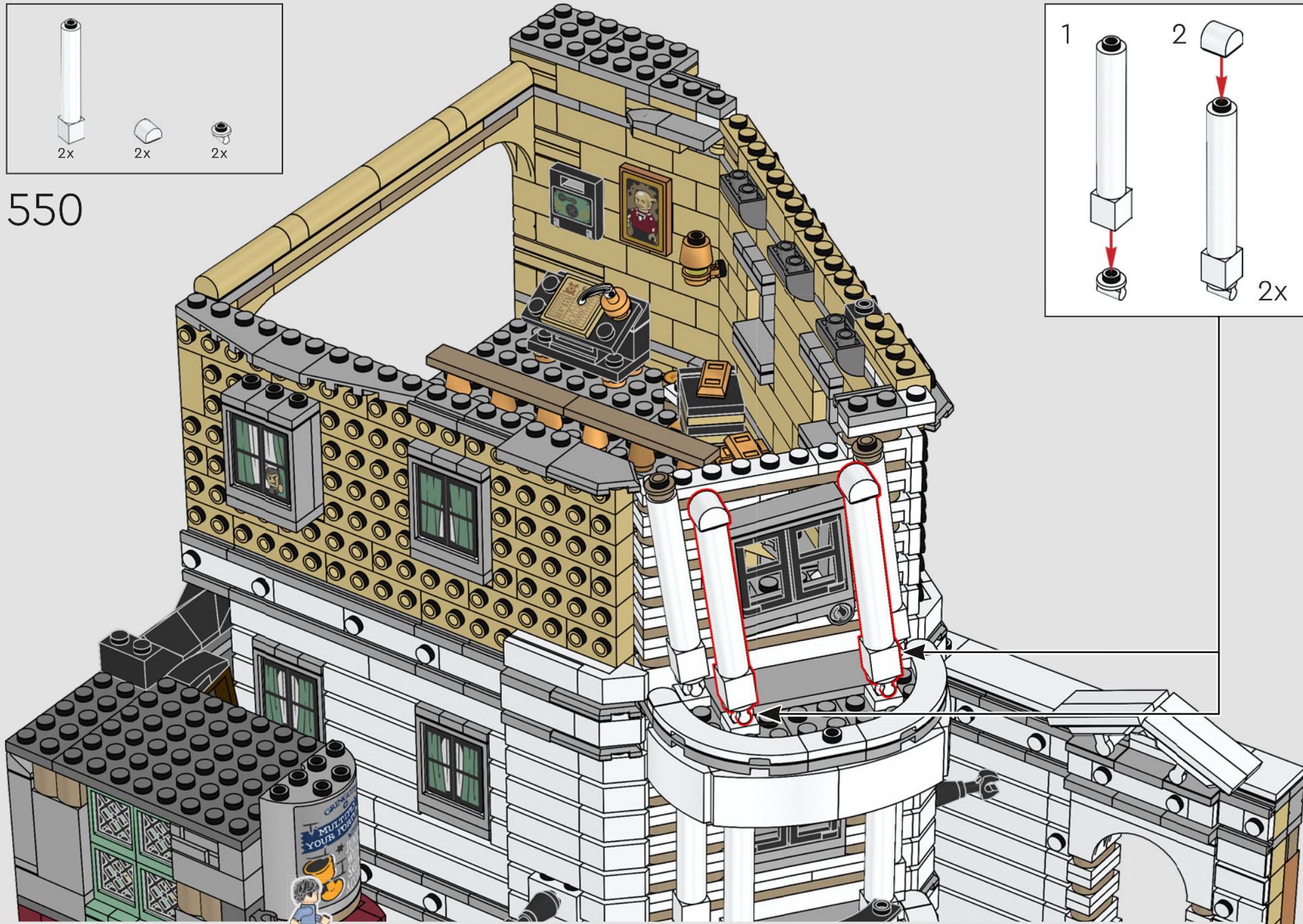
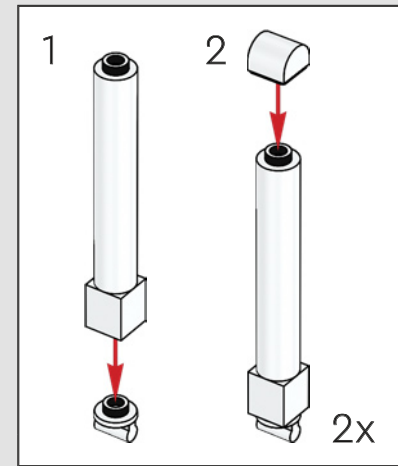

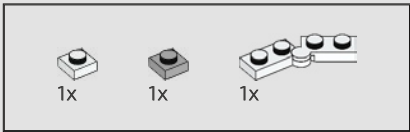
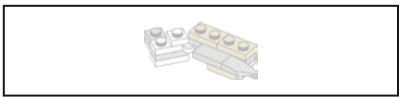

551

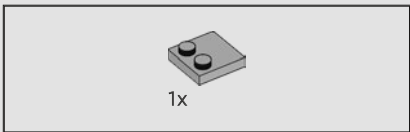
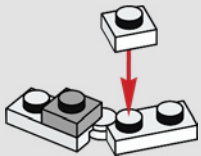

552

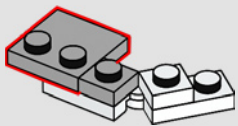

553

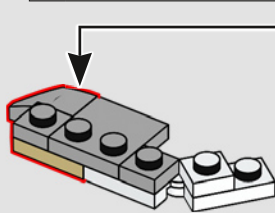
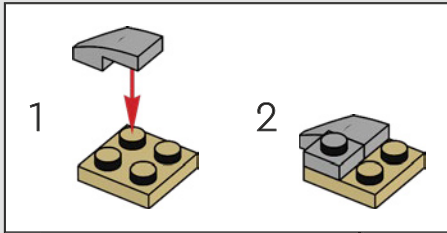

554

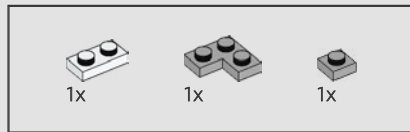
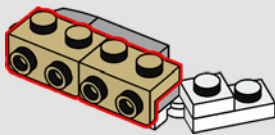

555

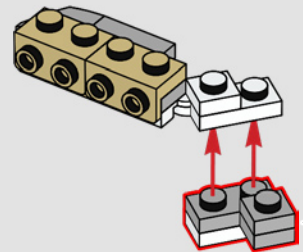
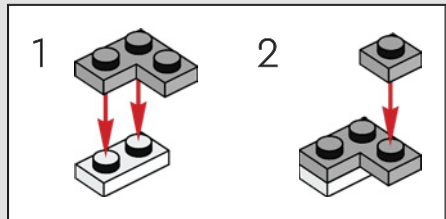

556

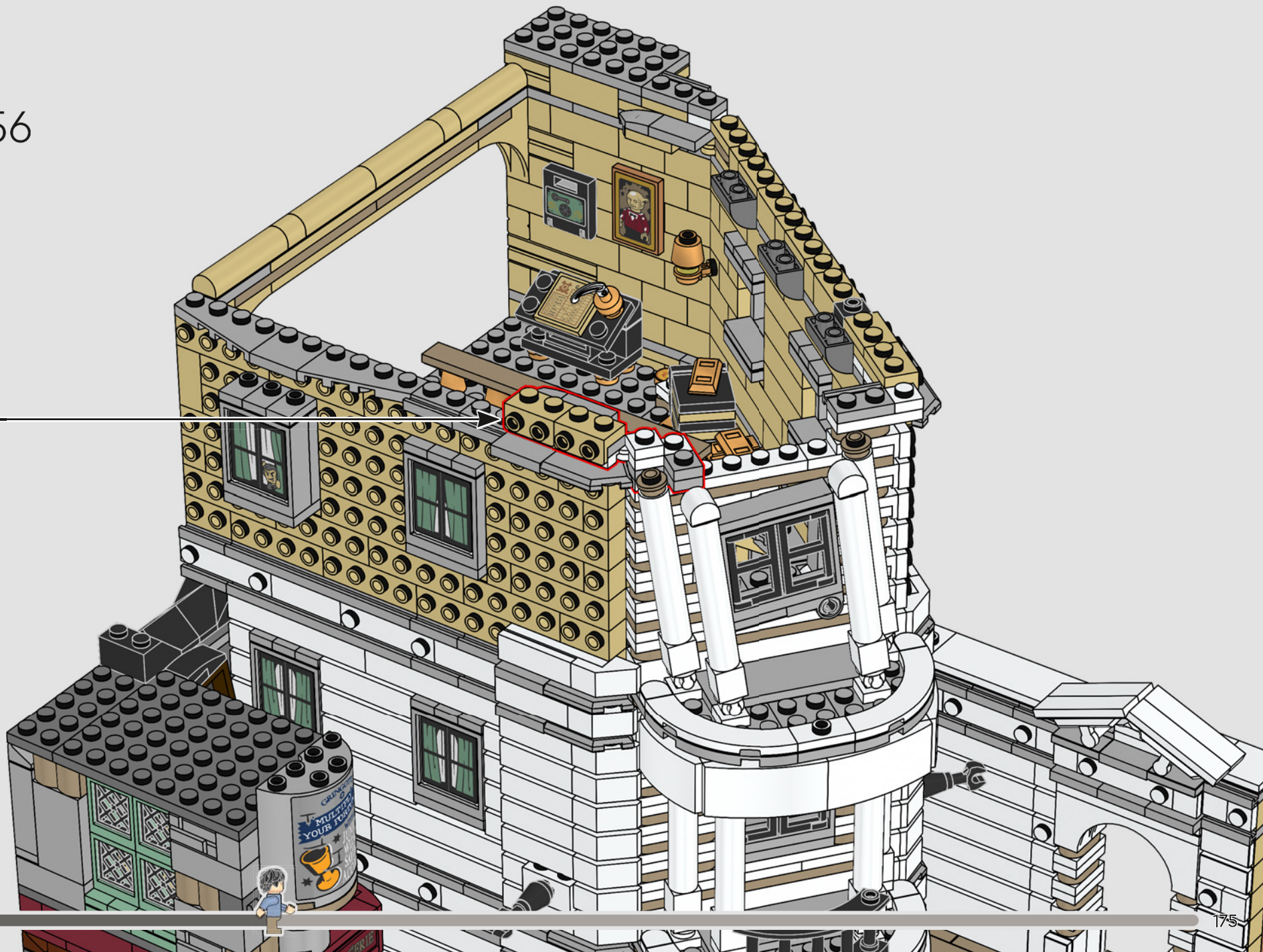

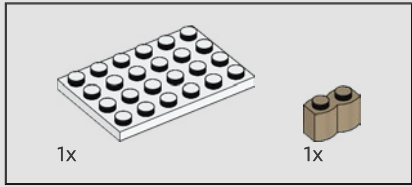
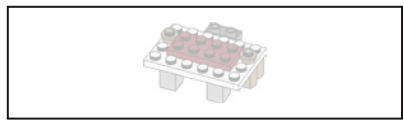

557

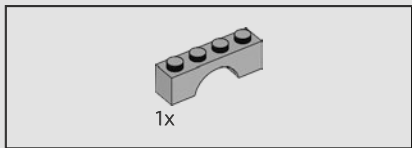
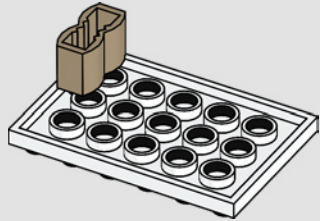

558

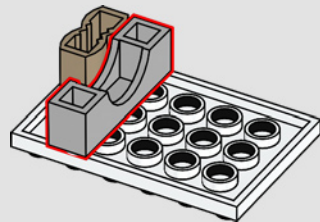

559

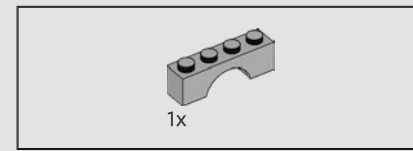
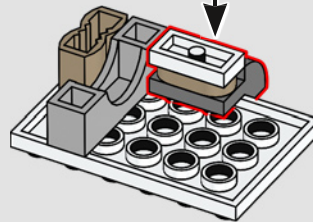
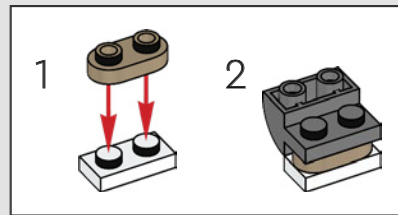

560

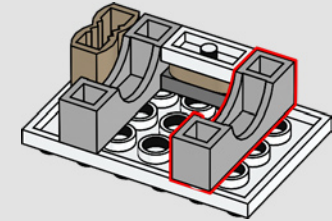

561

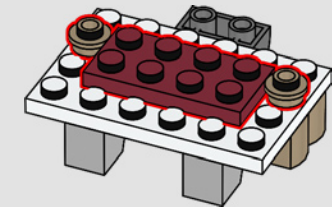
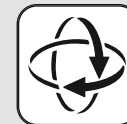



562

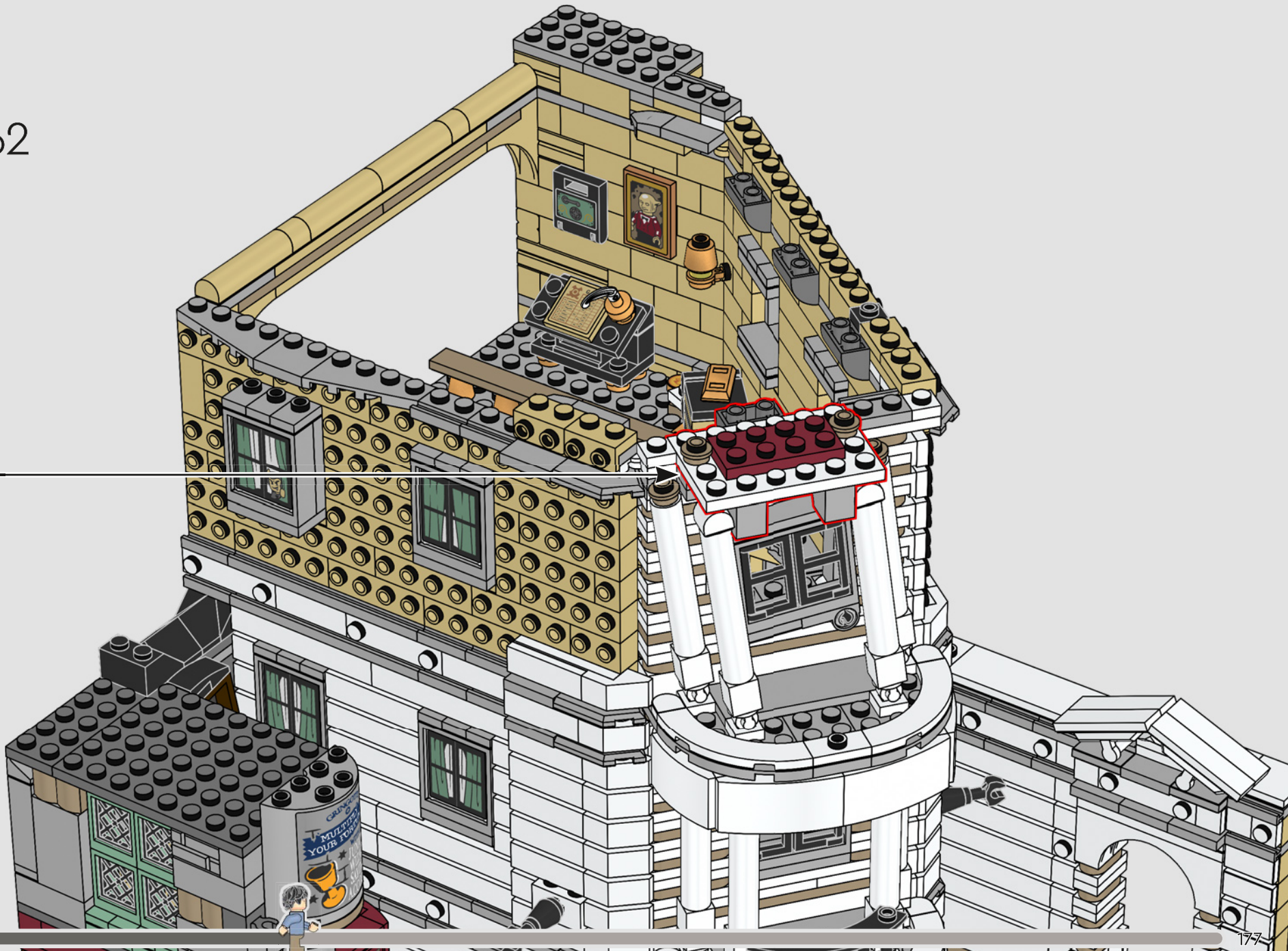

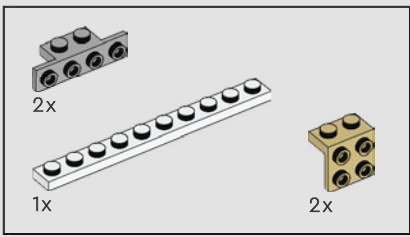

563

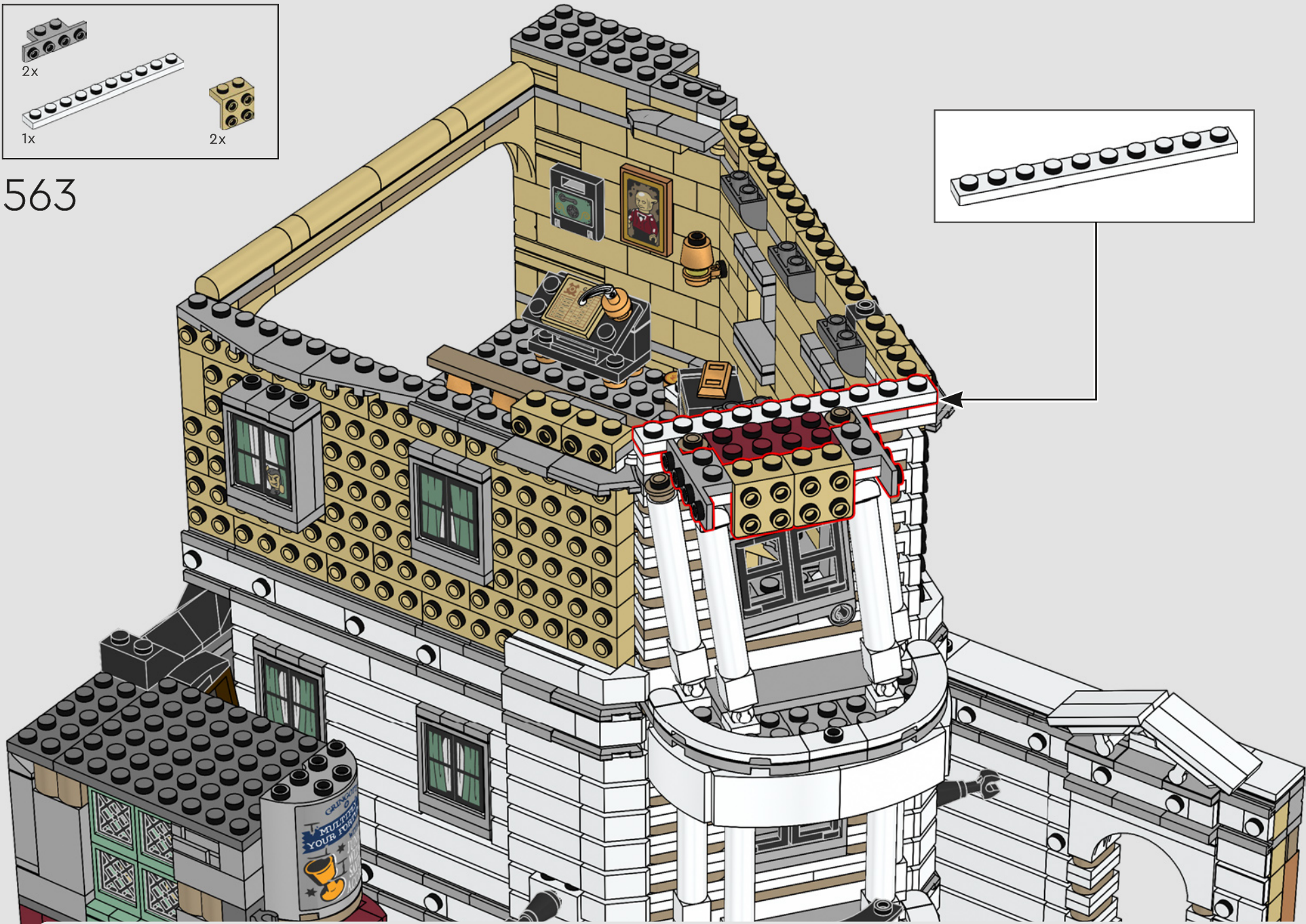
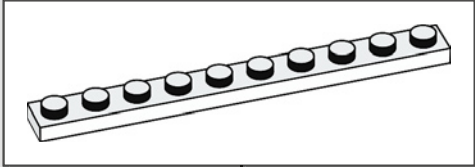

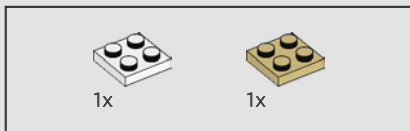

564

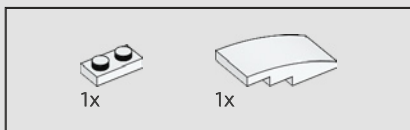
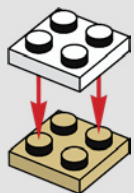

565

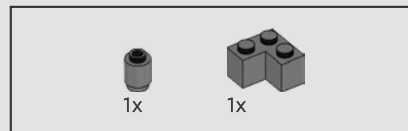
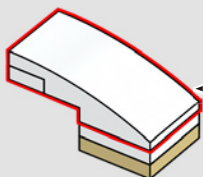
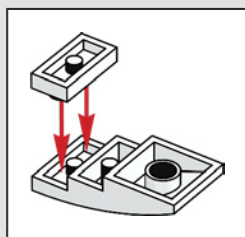

566

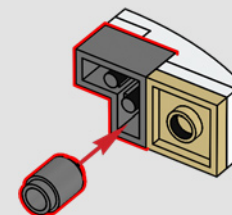

567

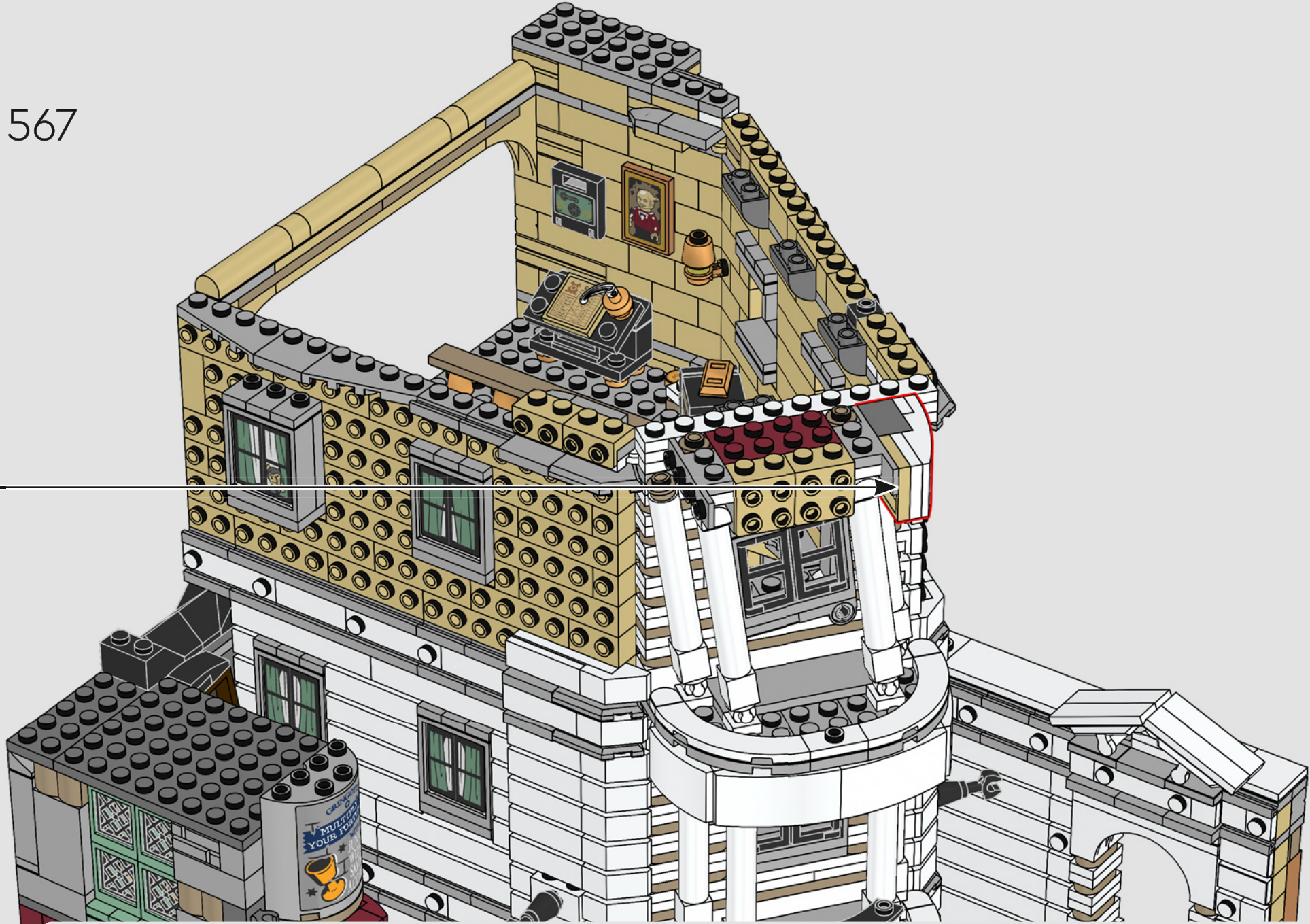

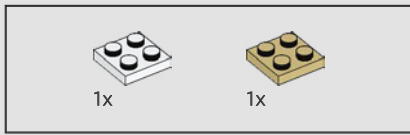

568

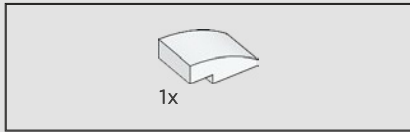
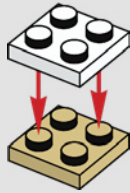

569

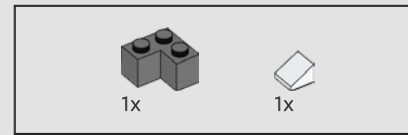
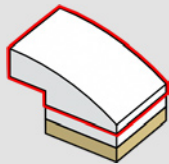

570

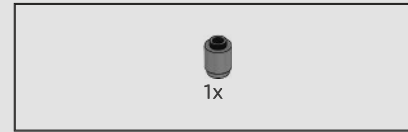
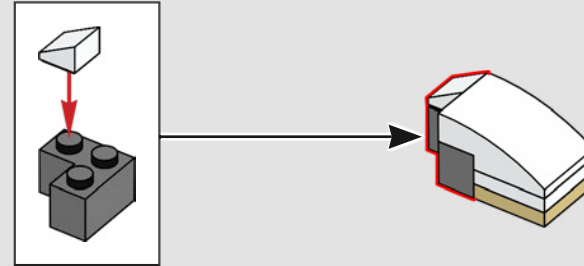

571

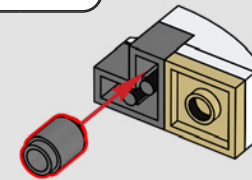
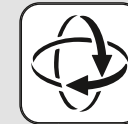

572

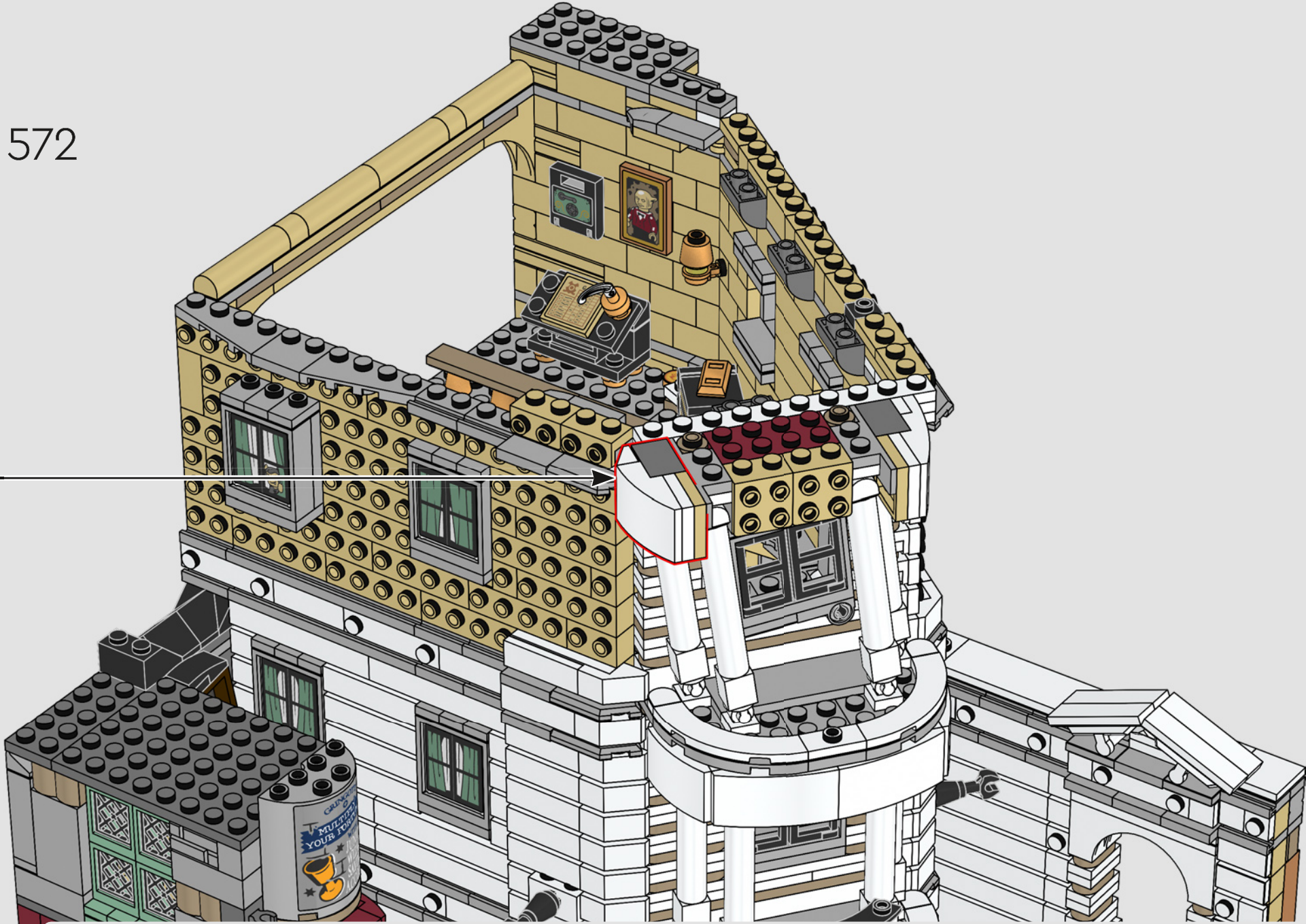

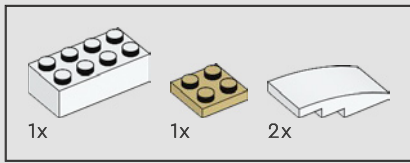

573

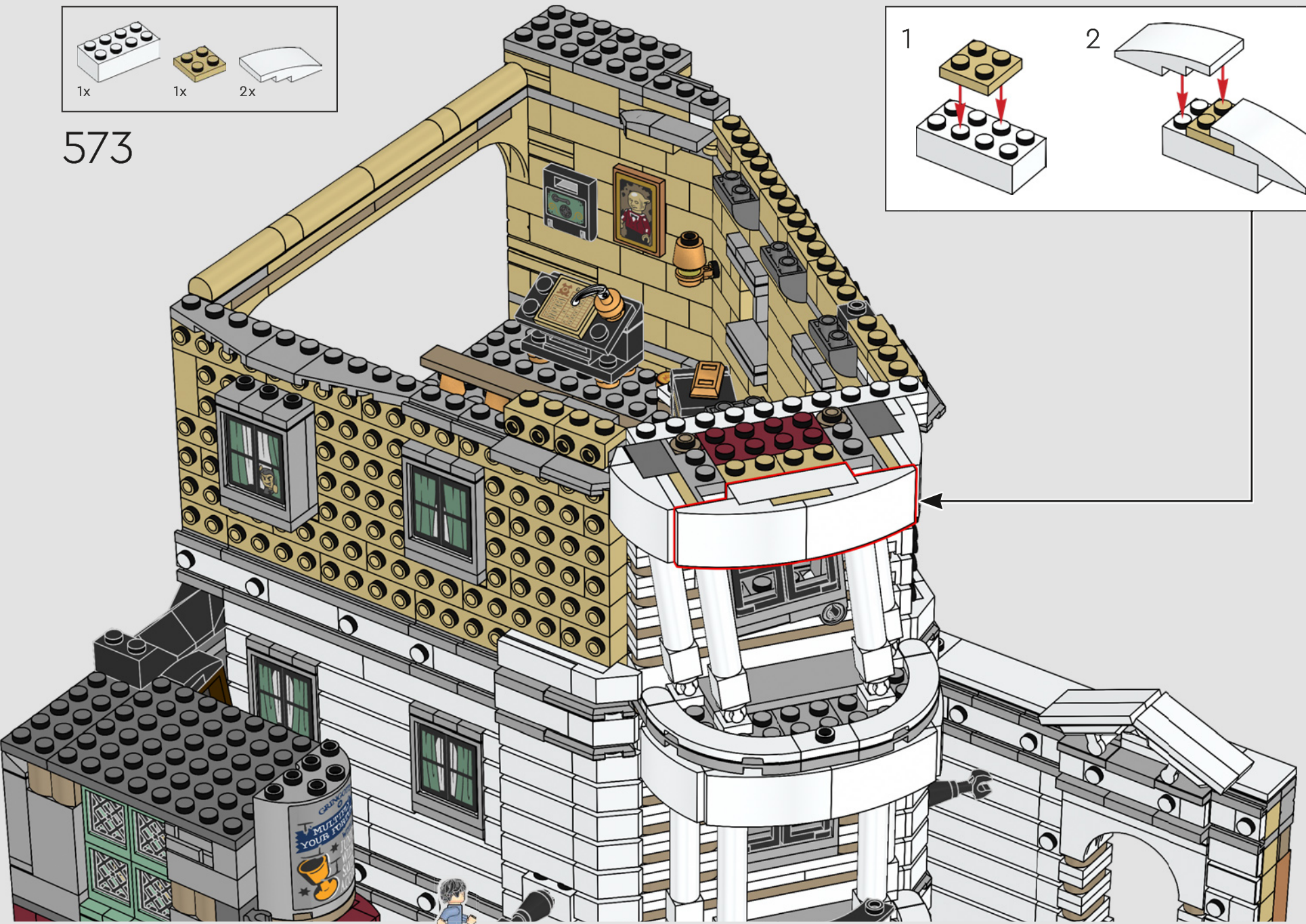
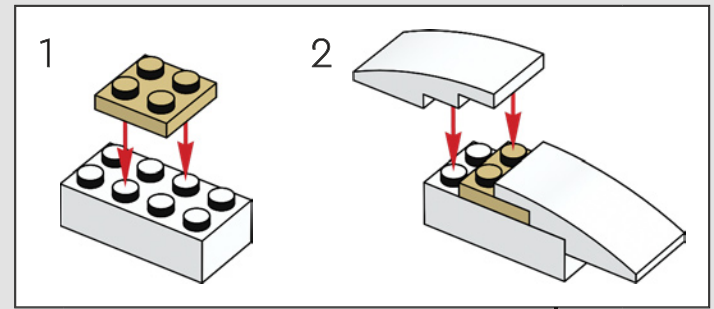

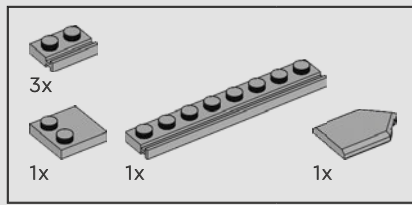

574

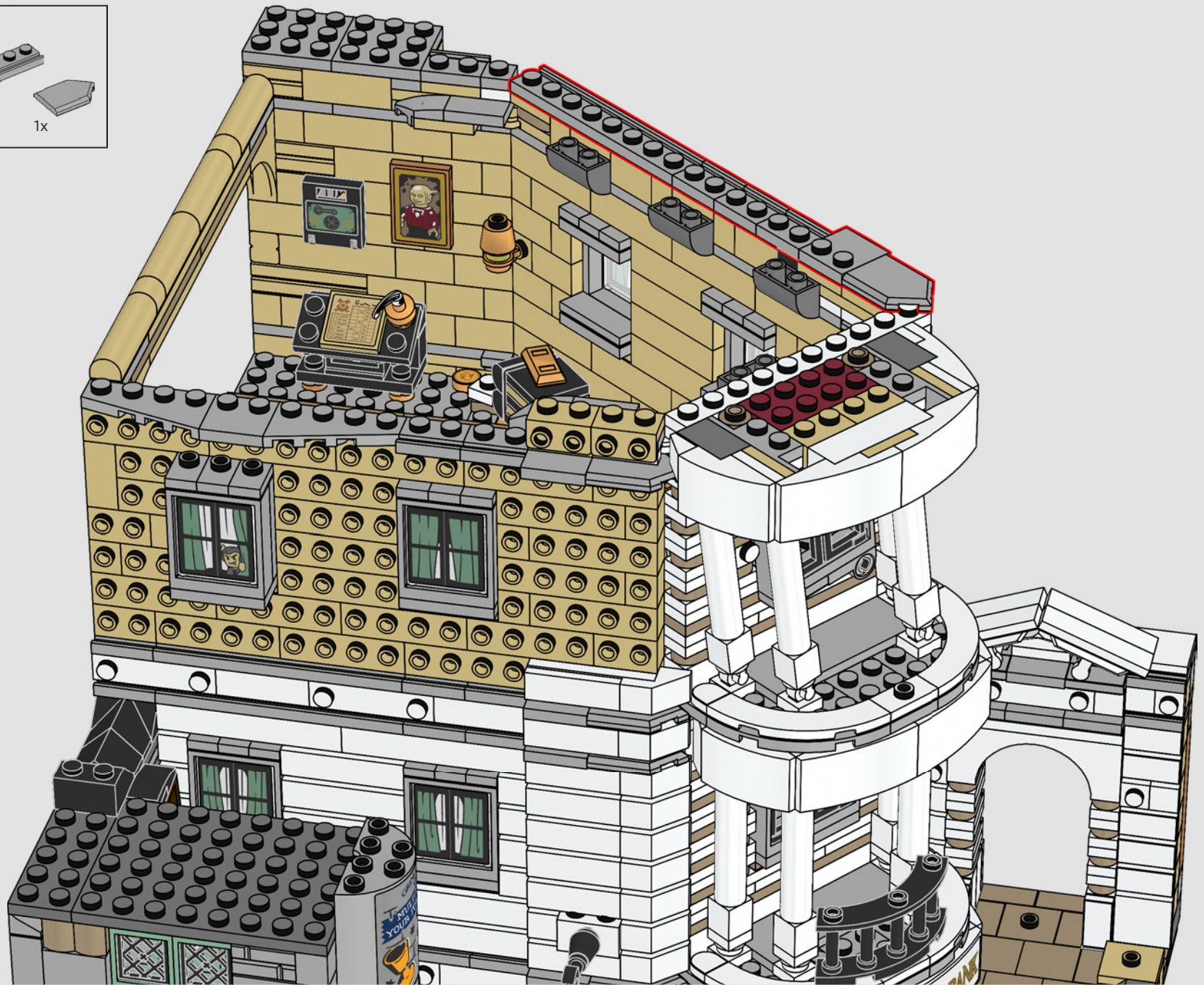



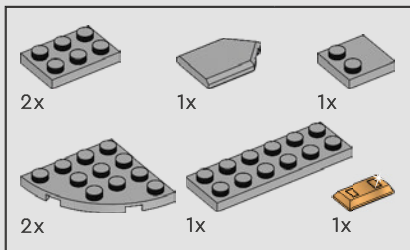

575

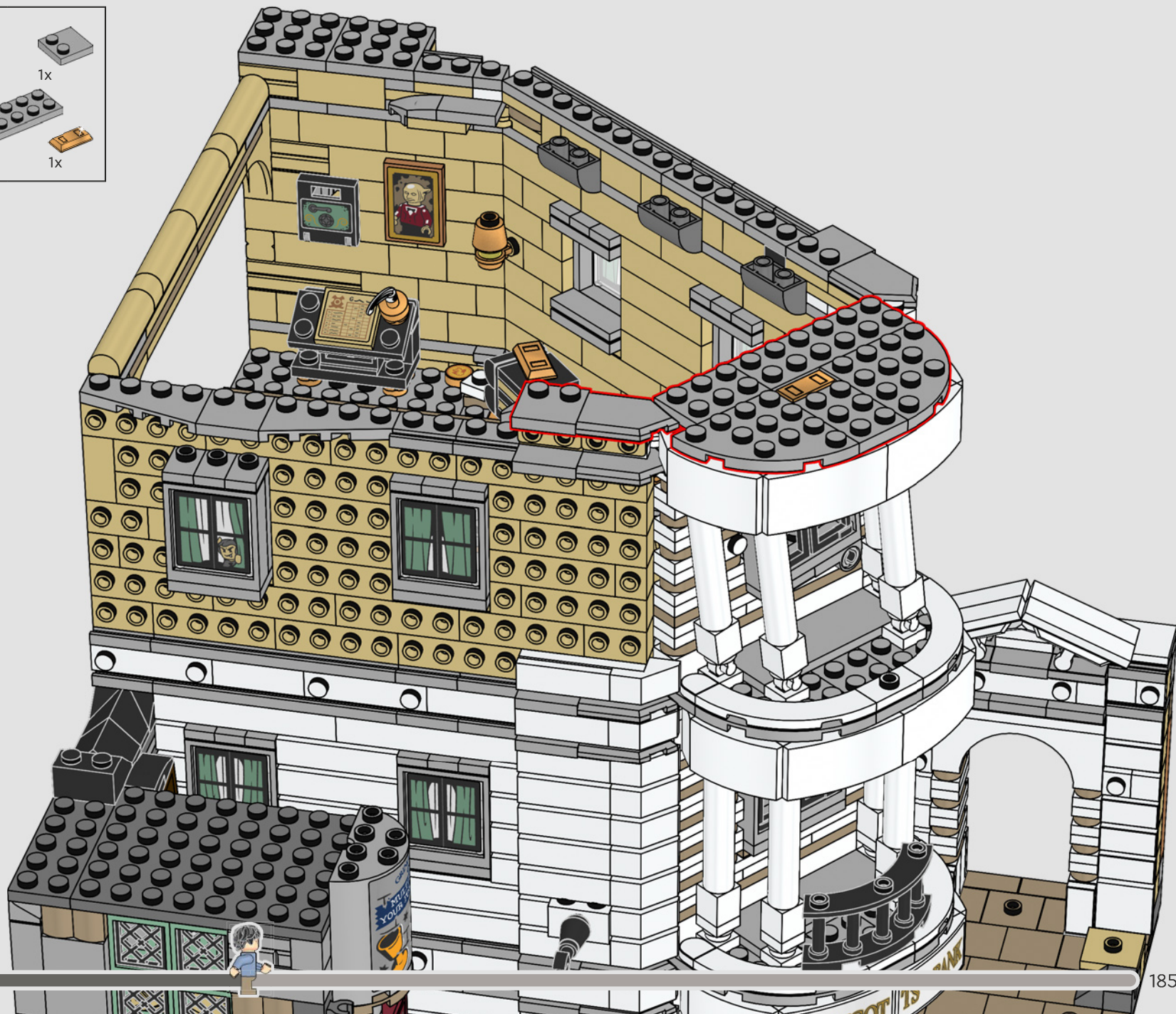

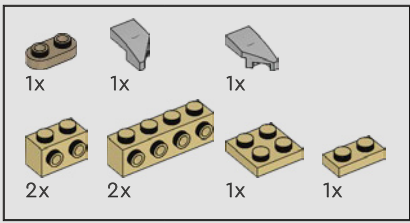

576

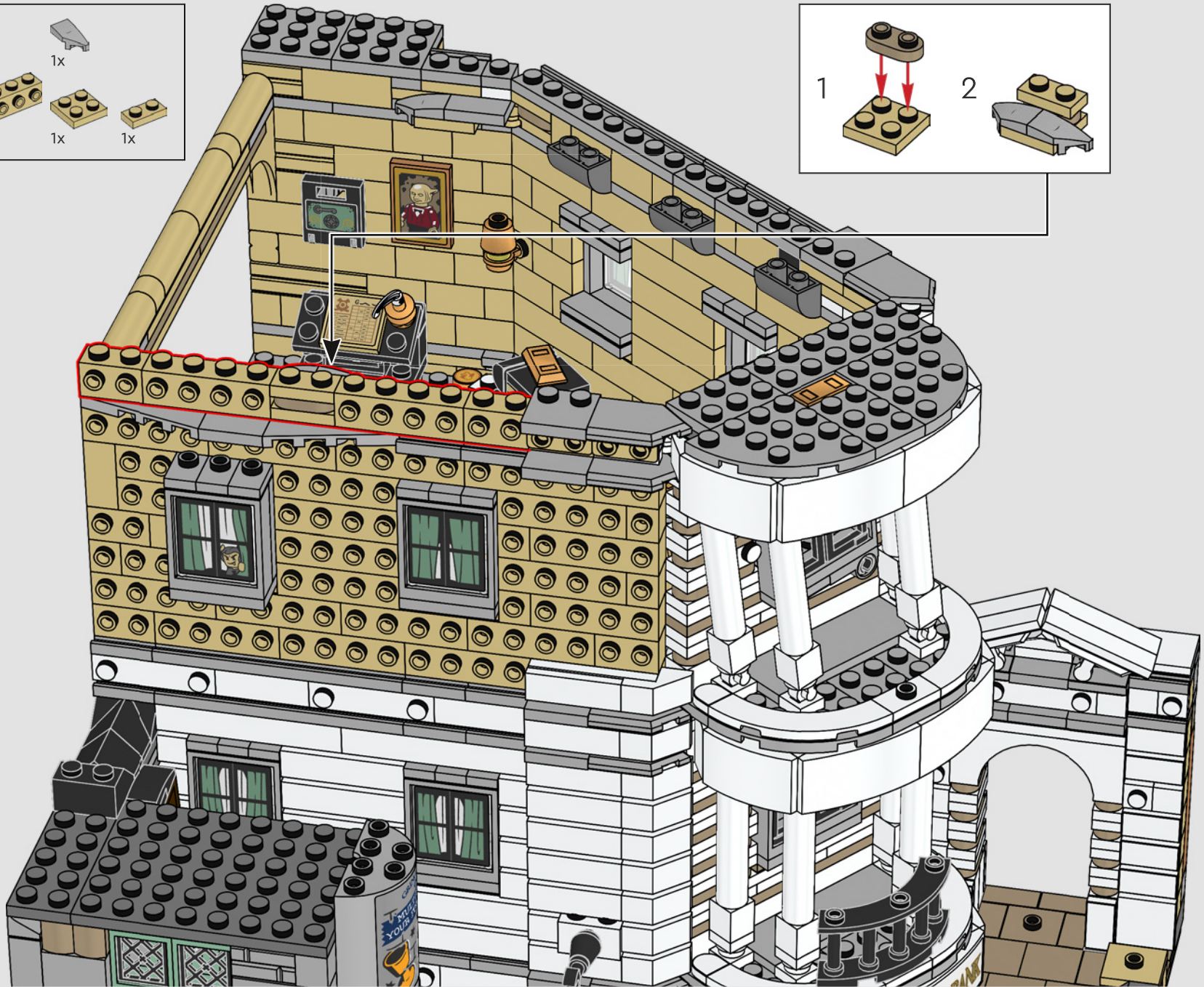
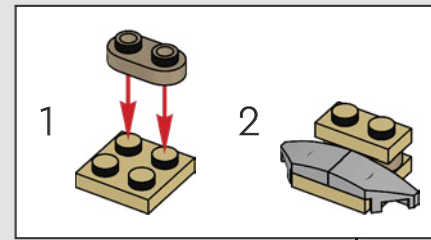

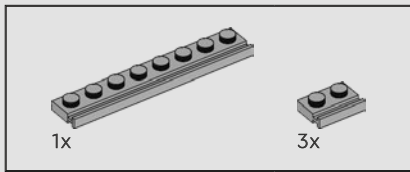

577

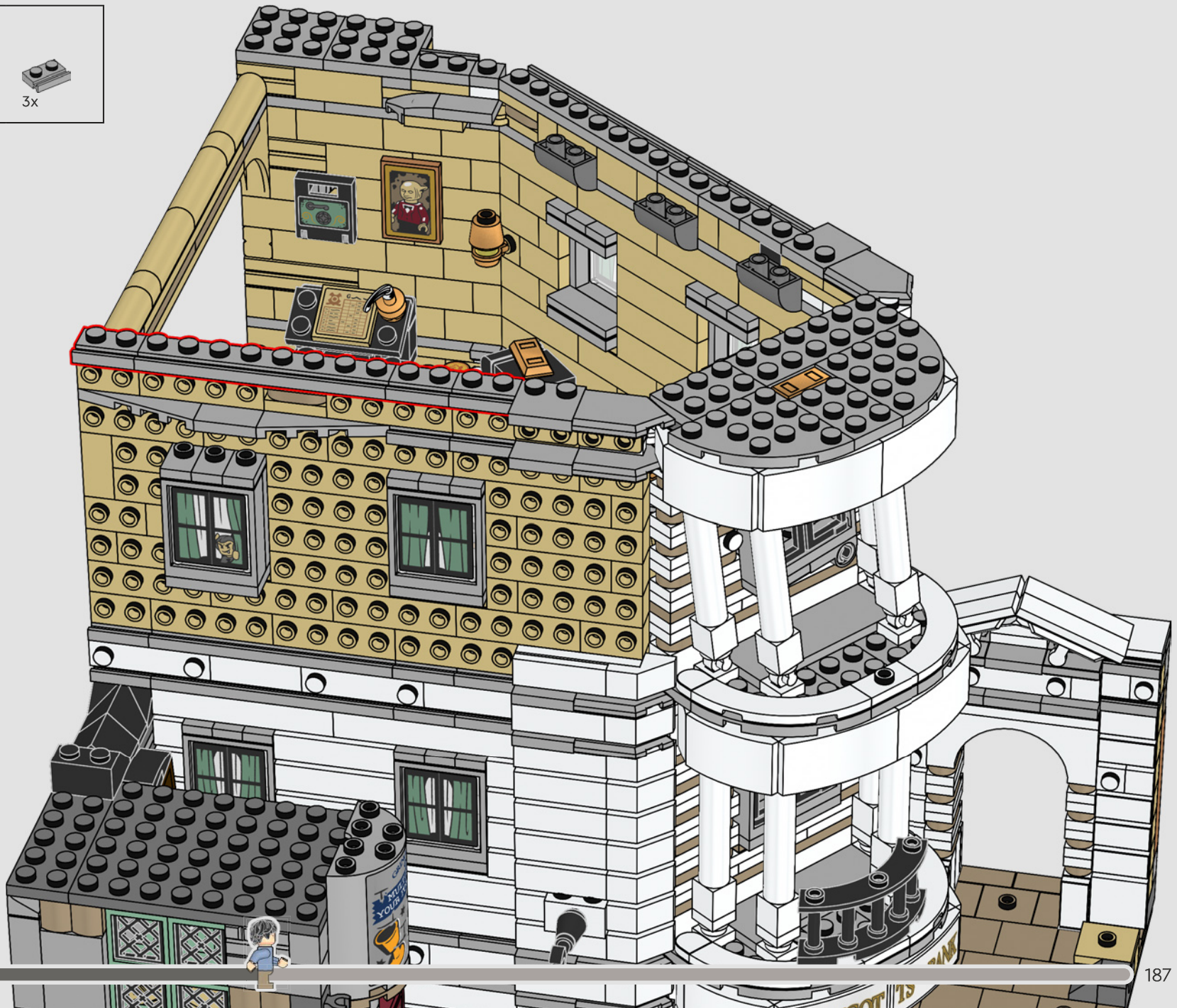



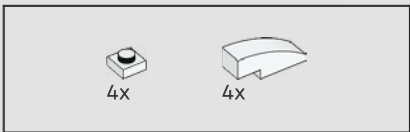

578

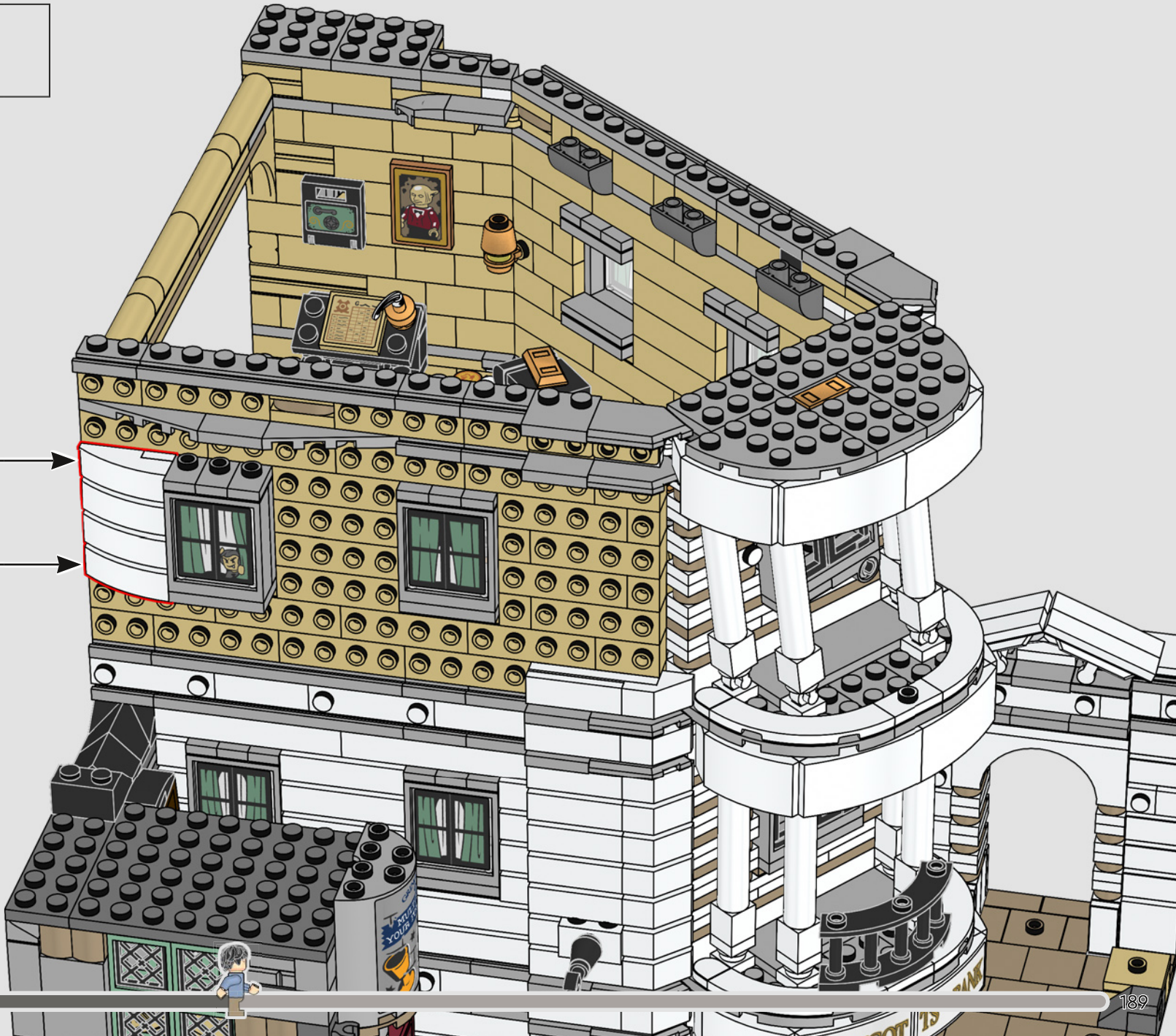
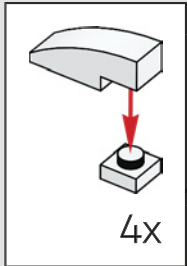

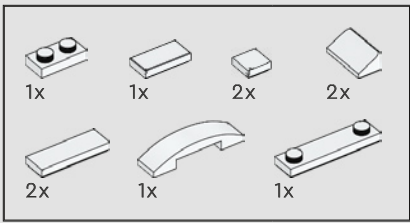

579

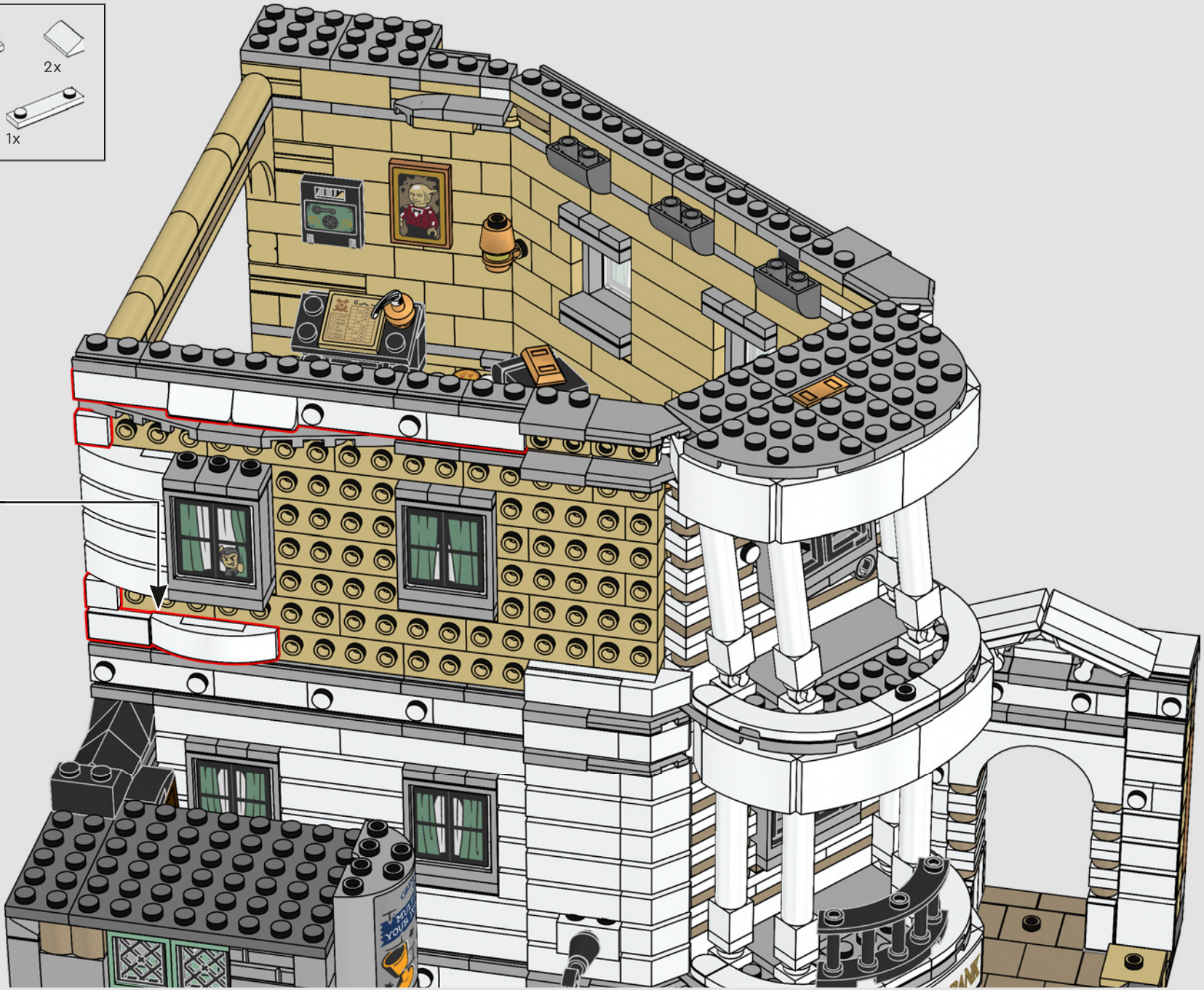
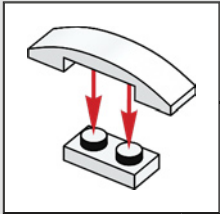

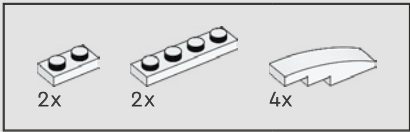

580

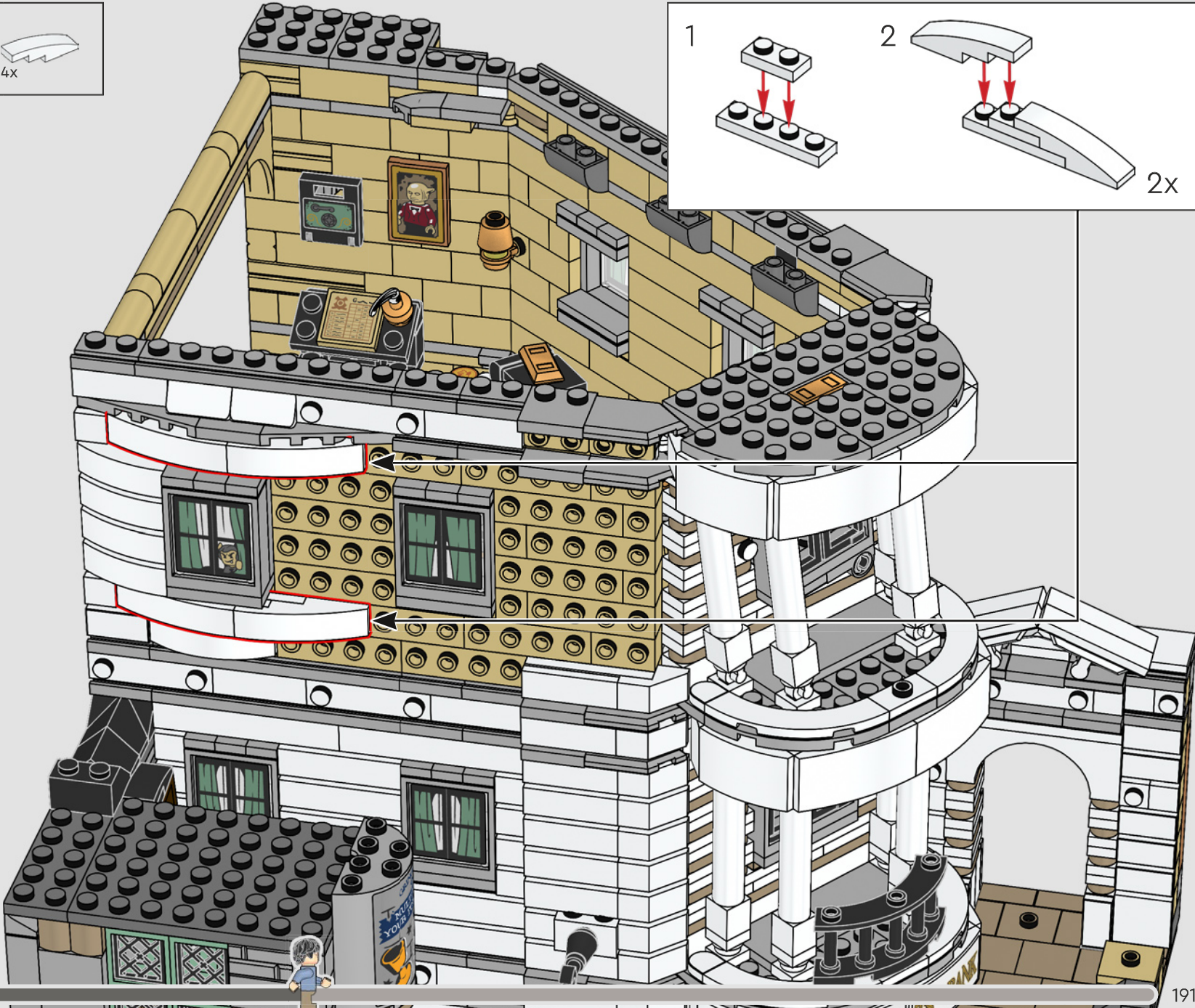
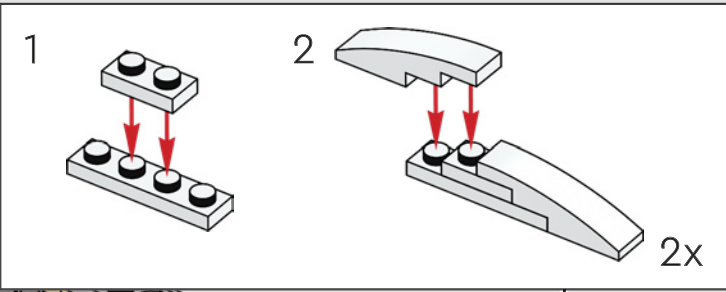

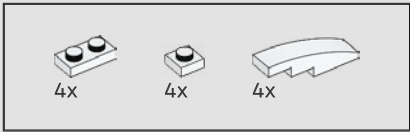

581

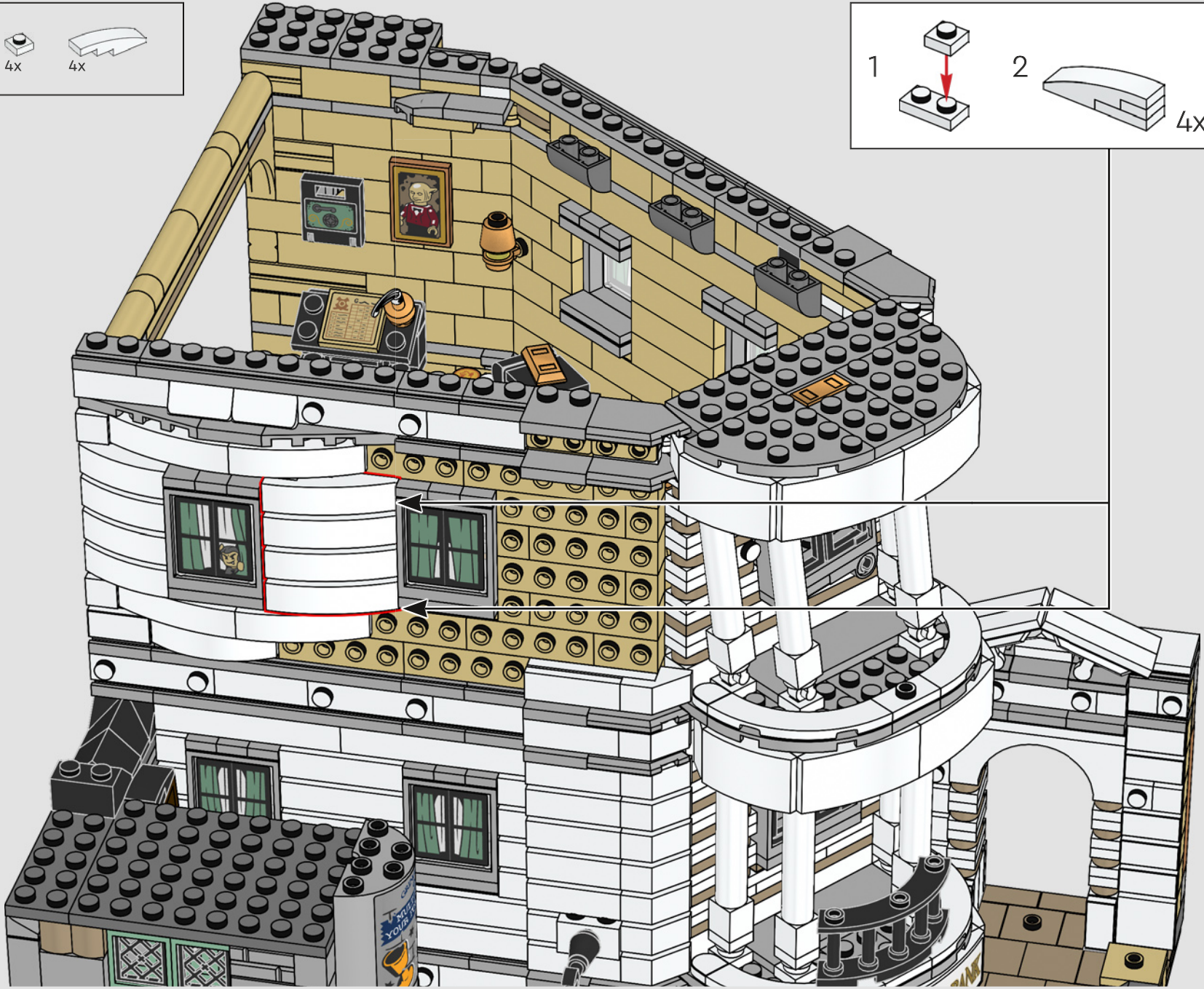
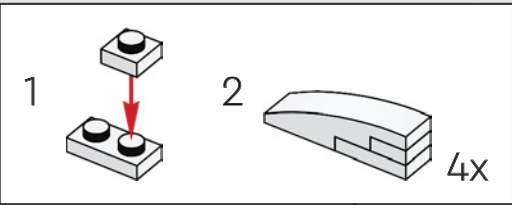



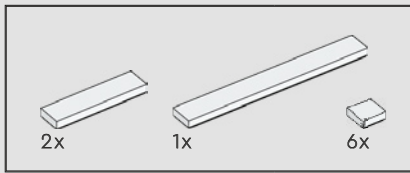

582

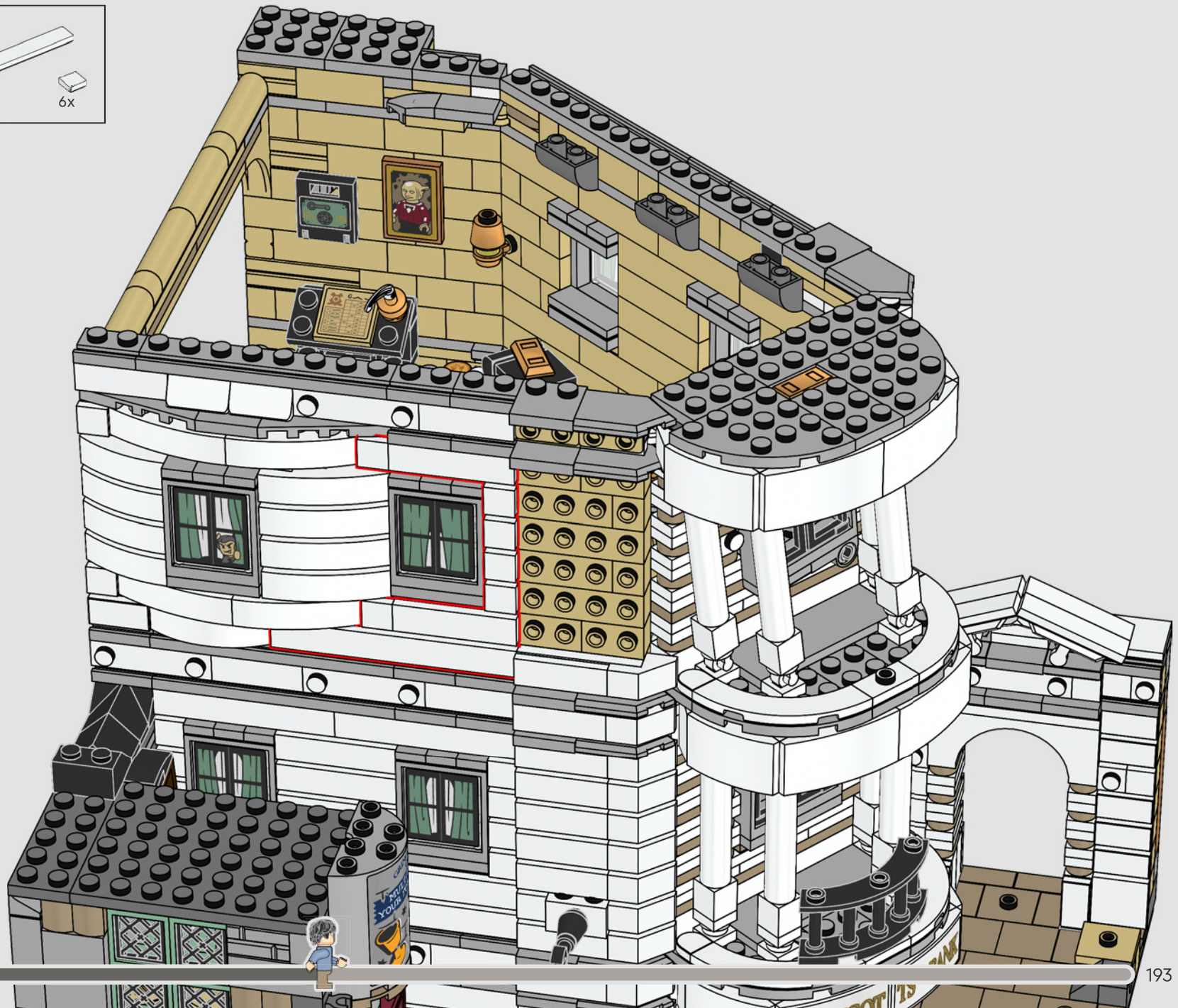

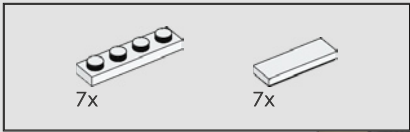

583

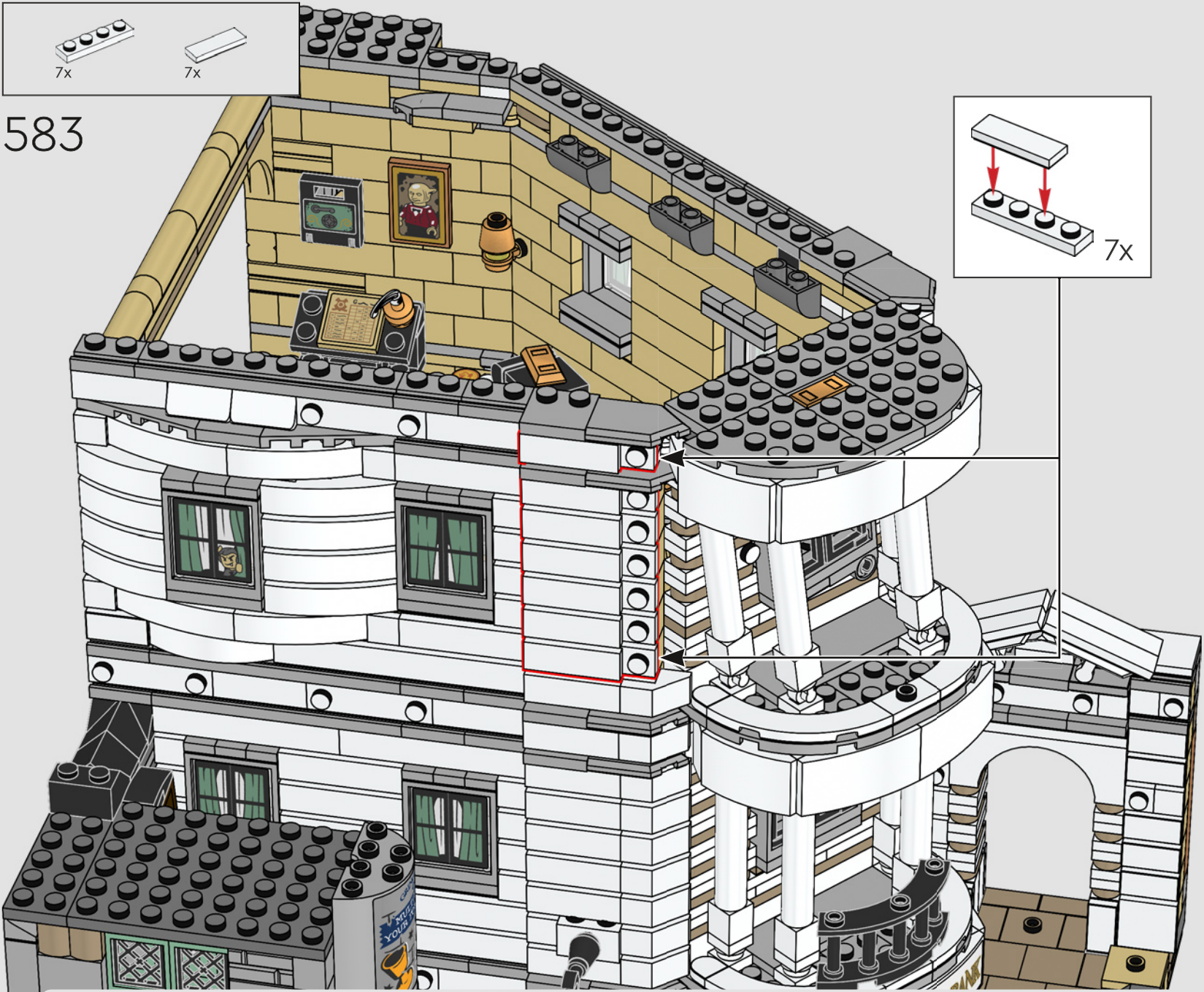
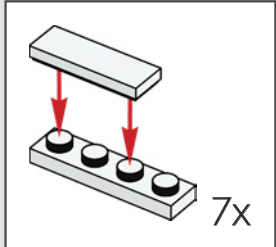

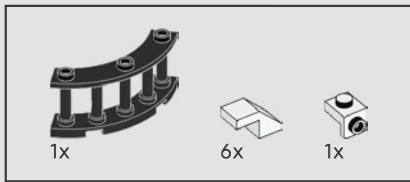

584

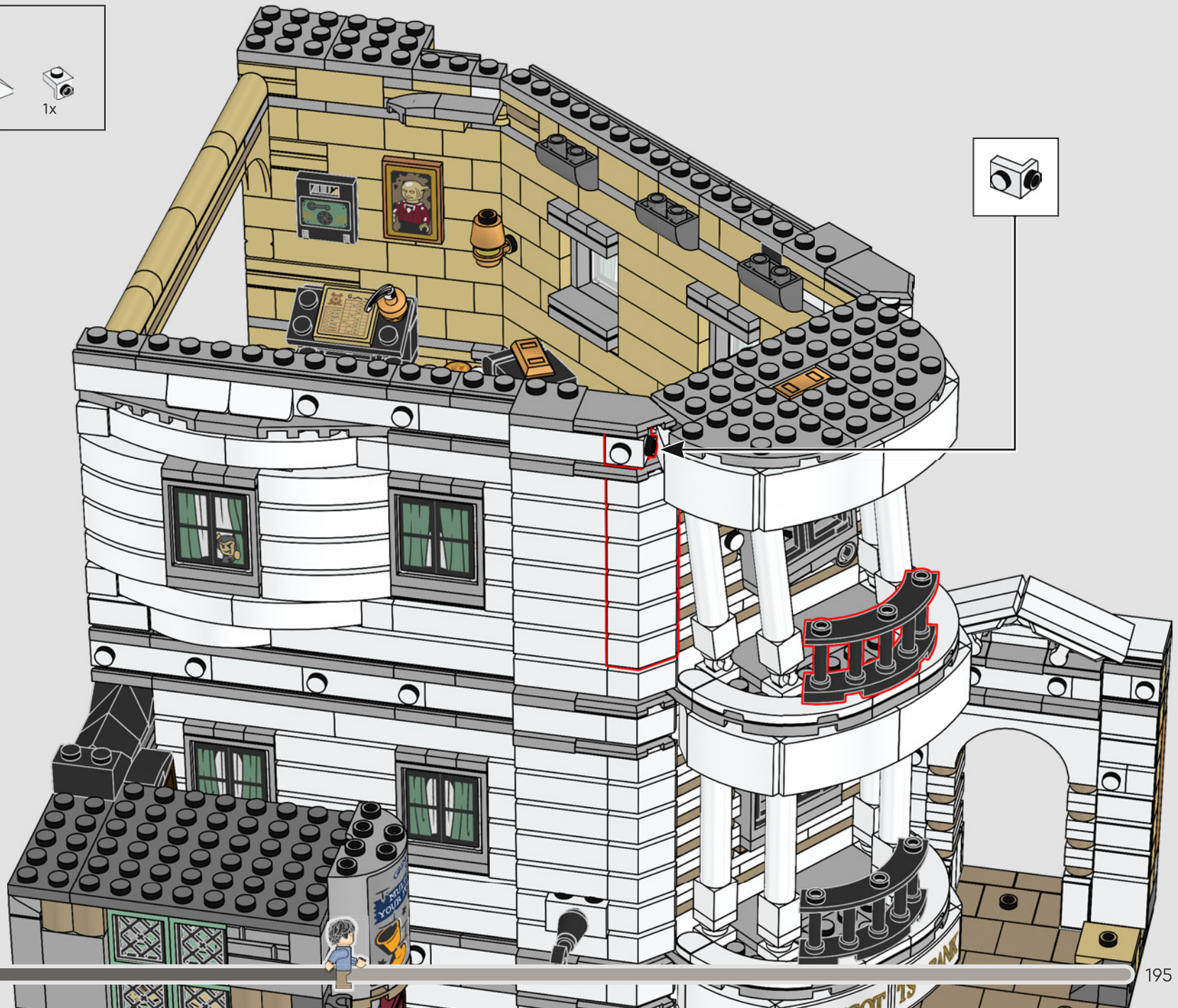

3x 5x 2x

585

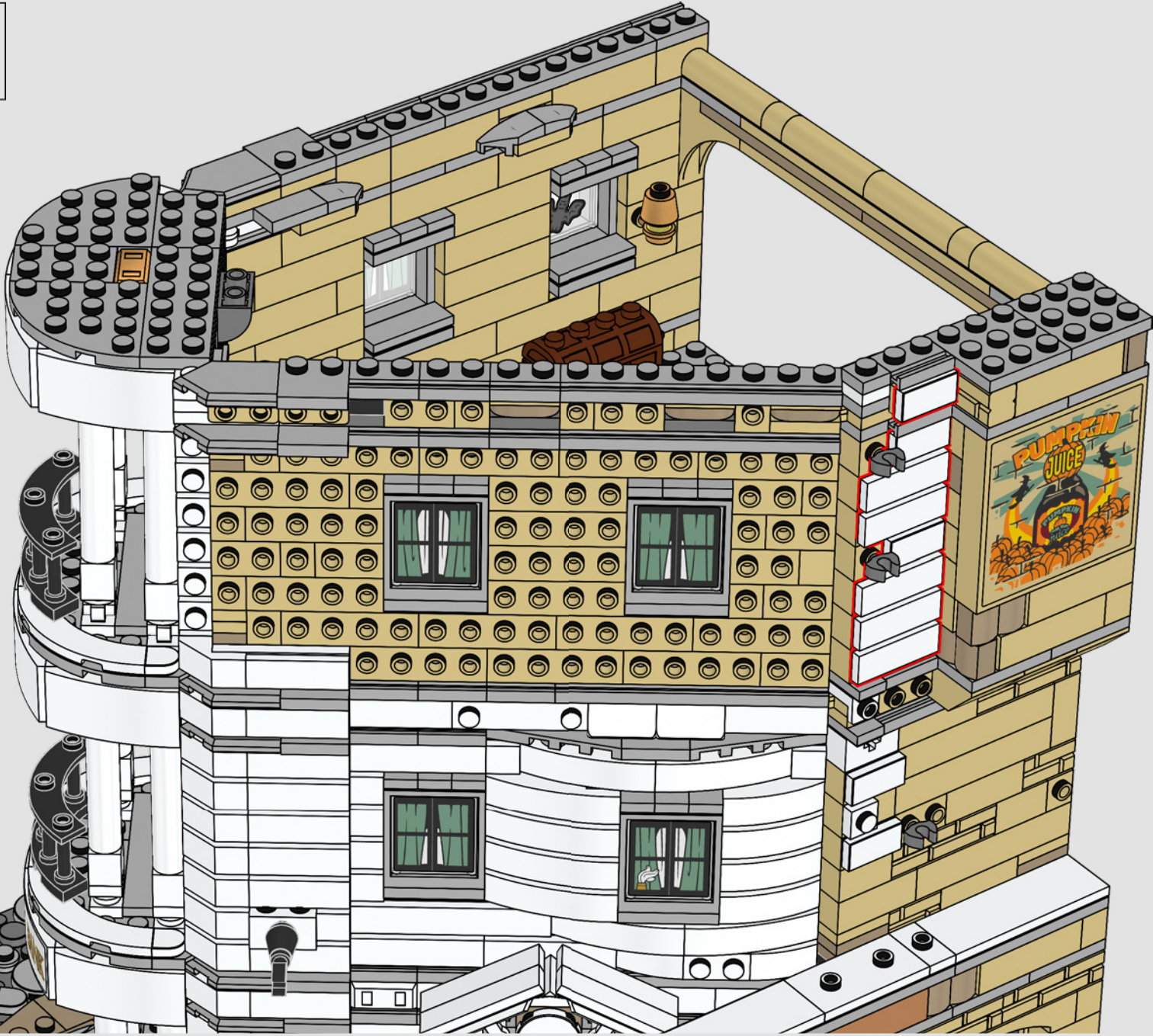

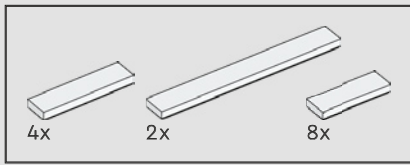

586

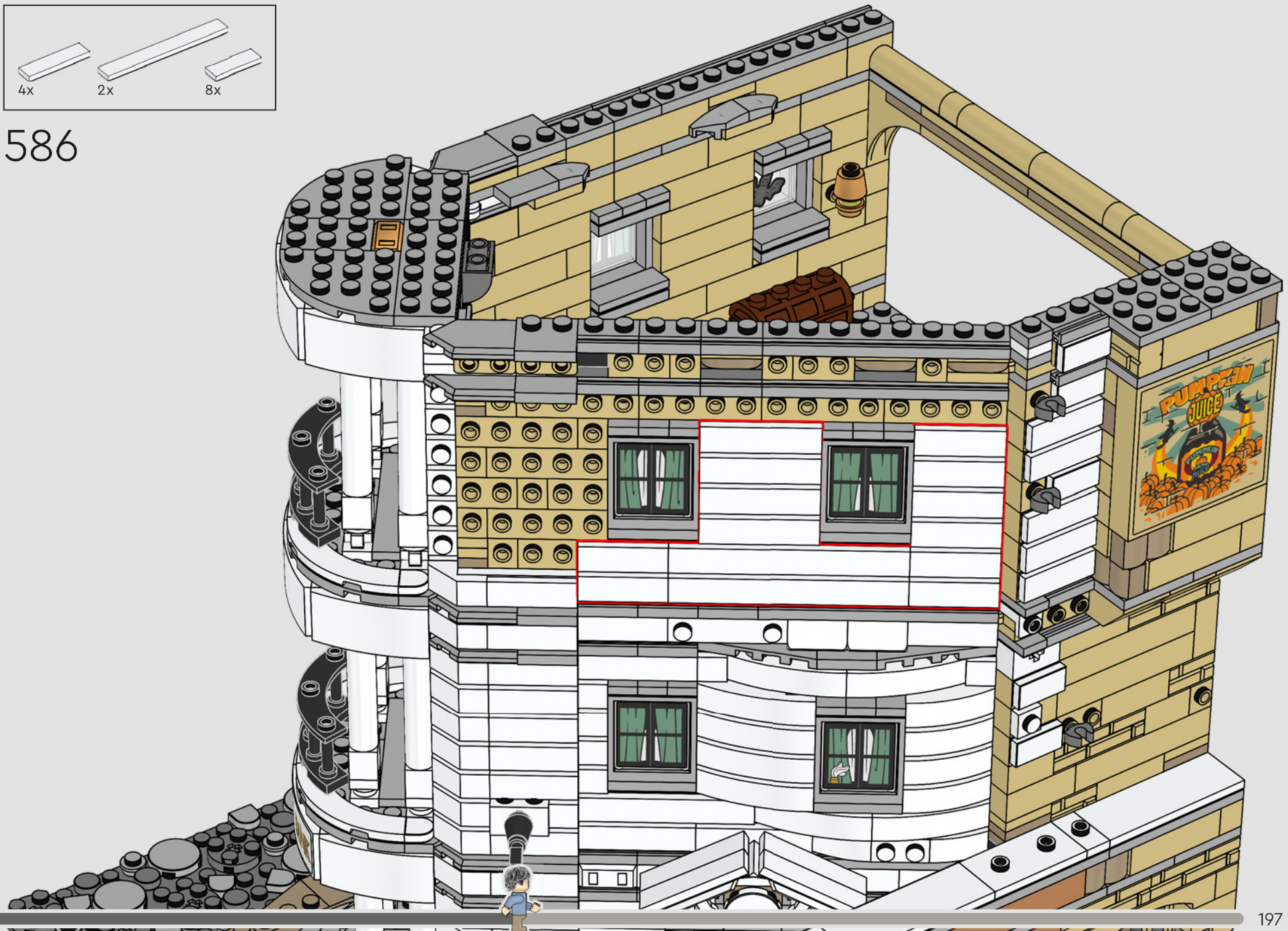

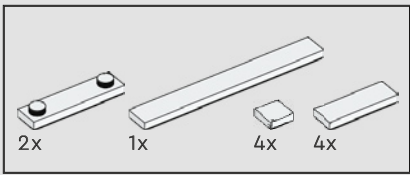

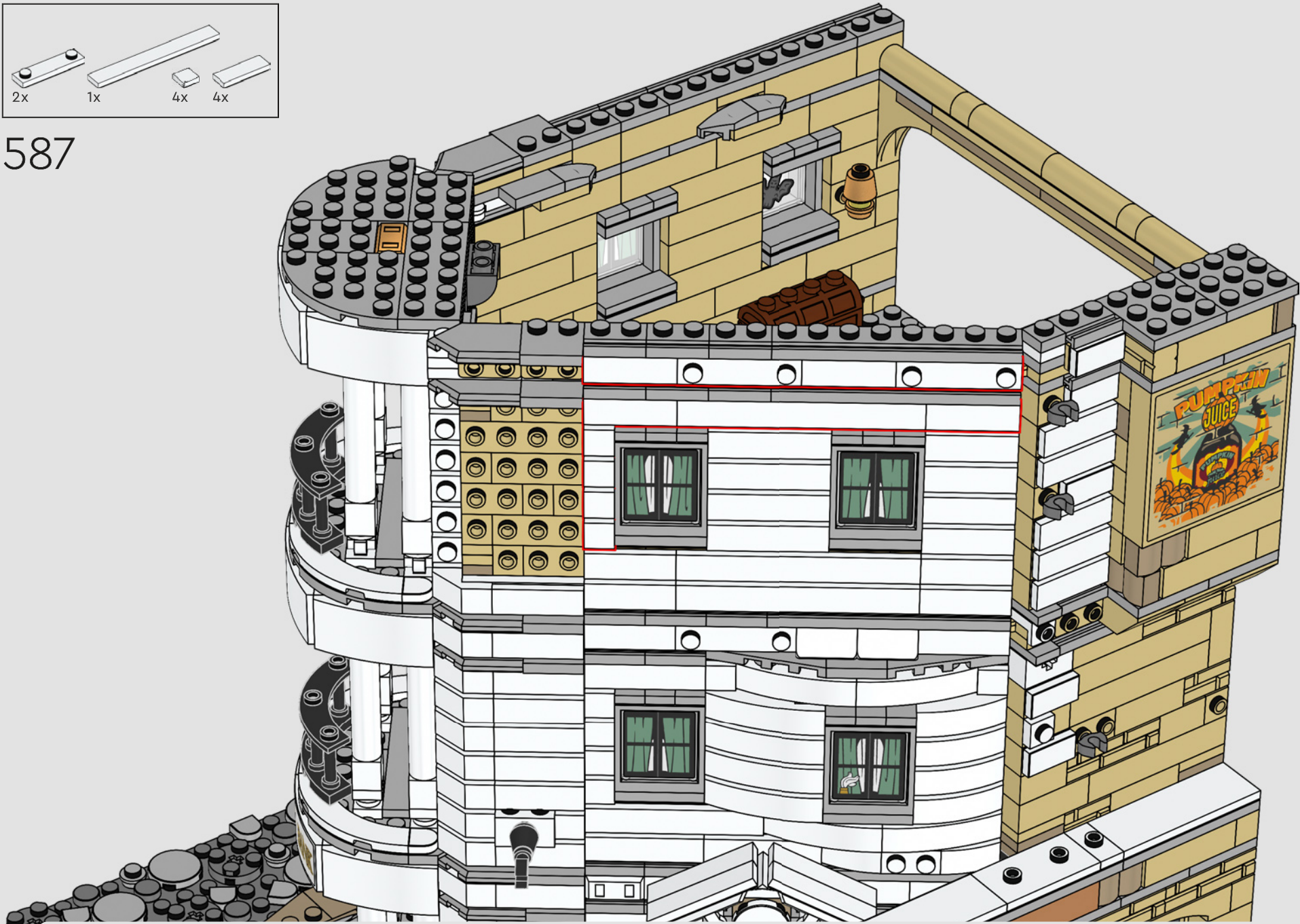

587

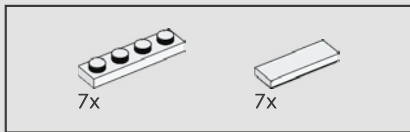

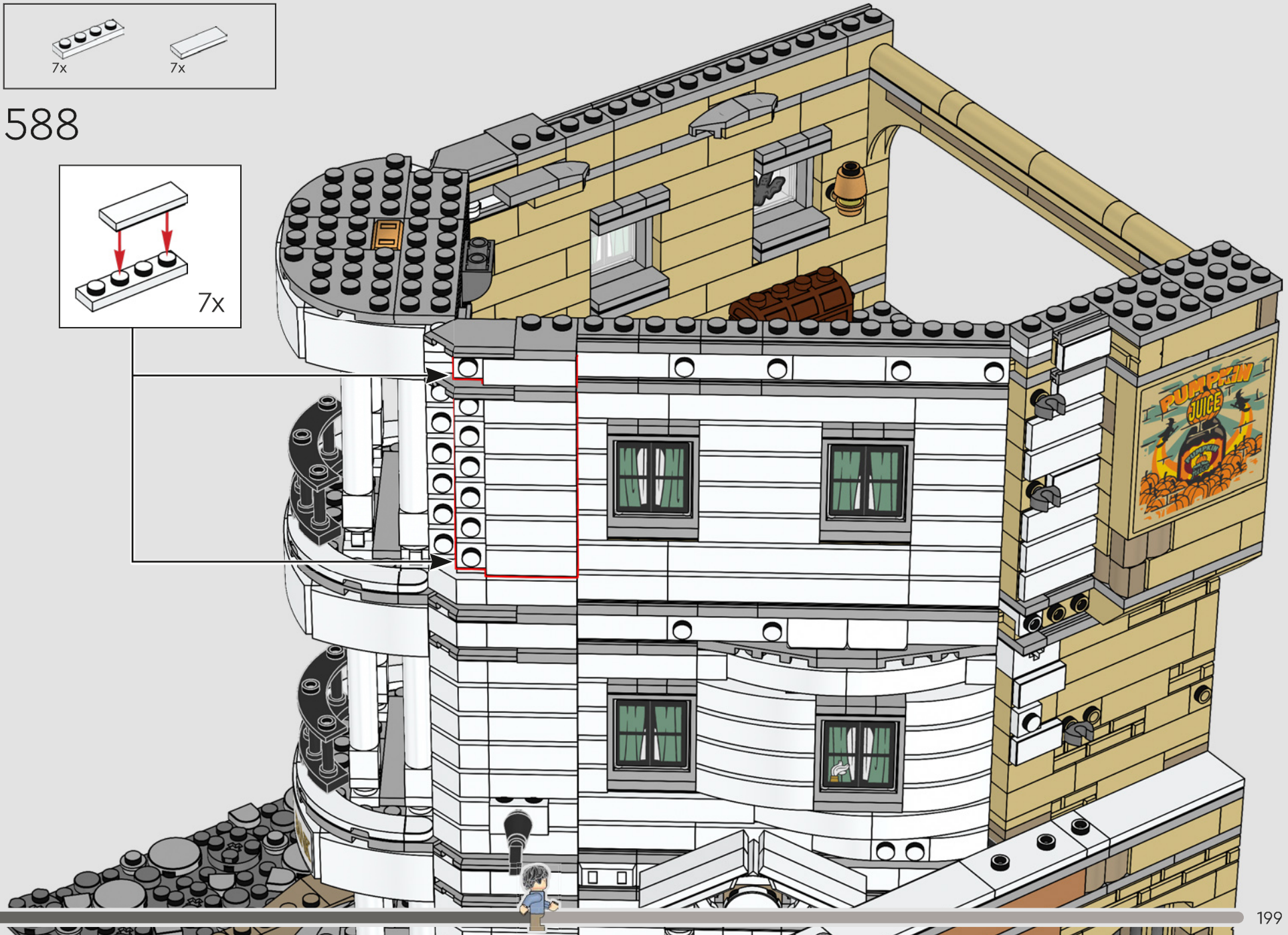
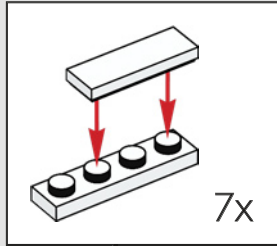

588



		
1x	6x	1x

589

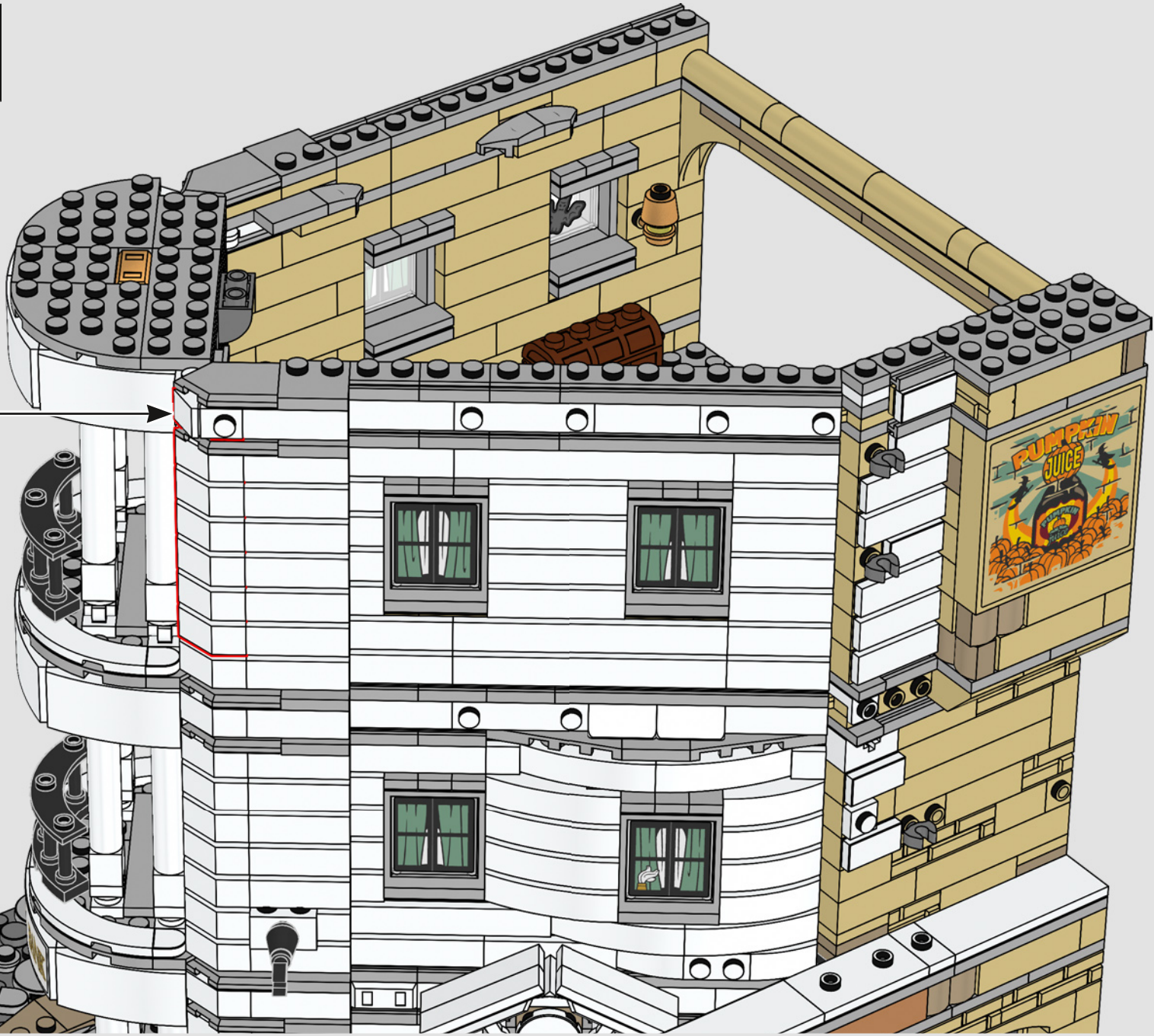
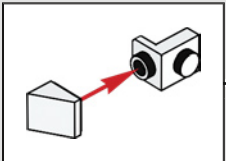





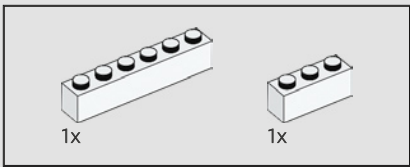

590



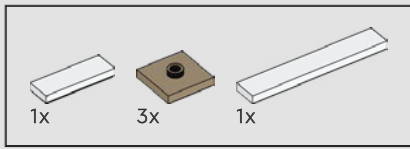

591

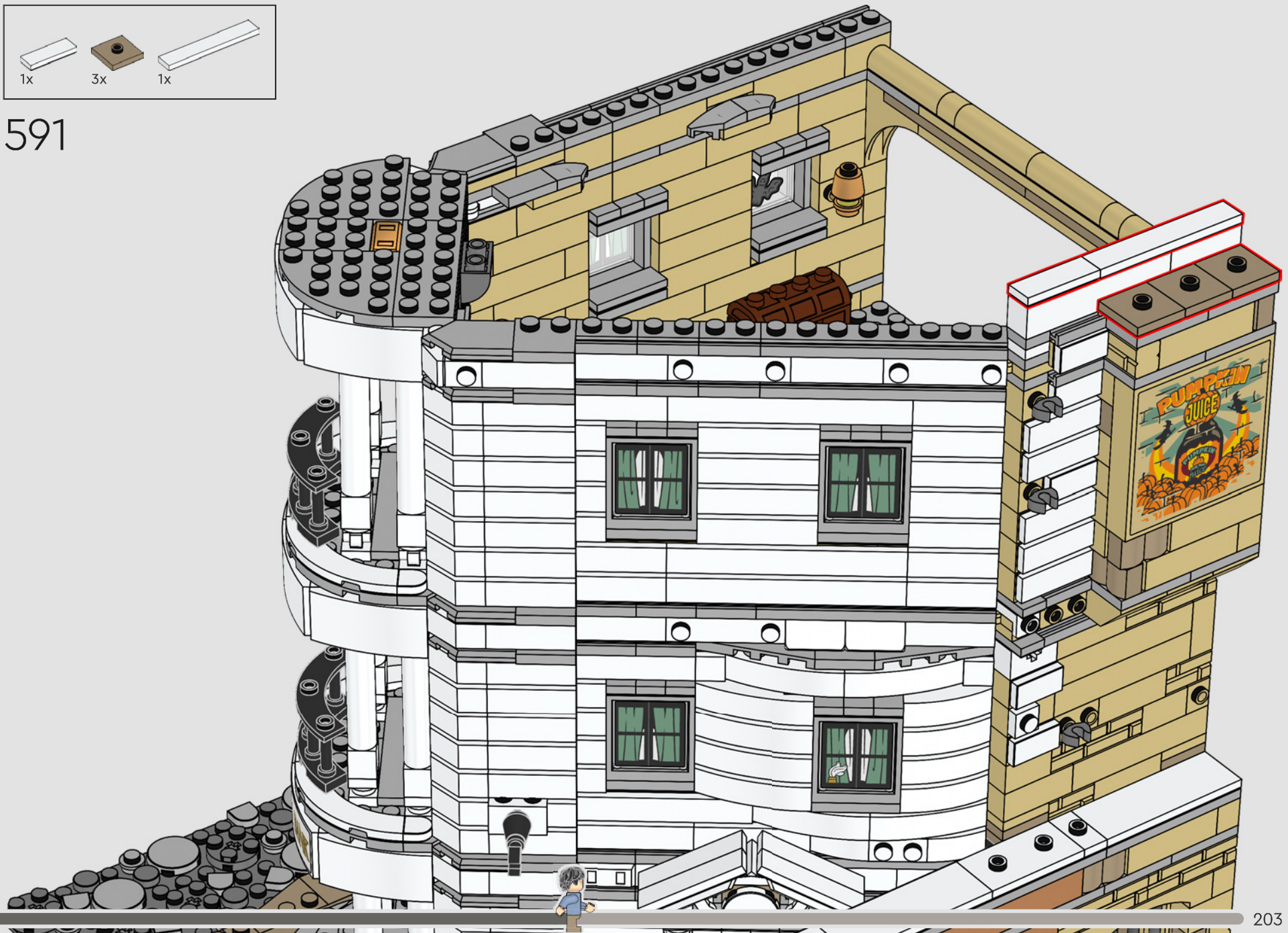

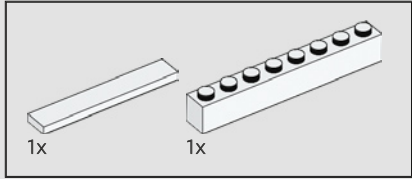
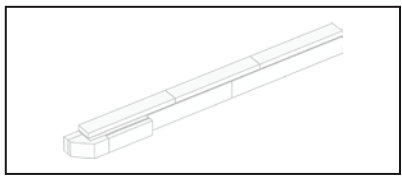

592

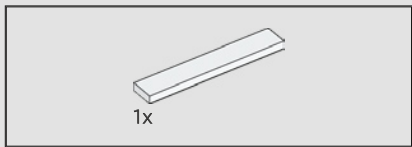
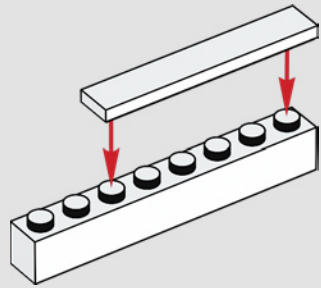

593

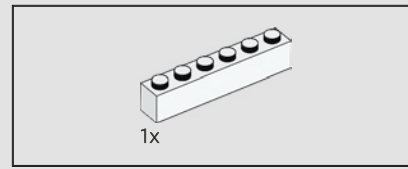
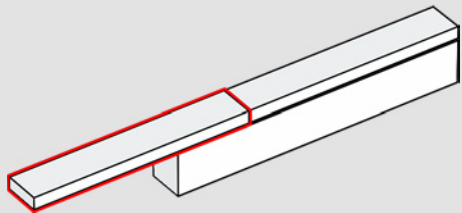

594

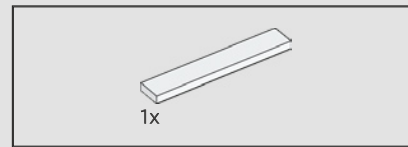
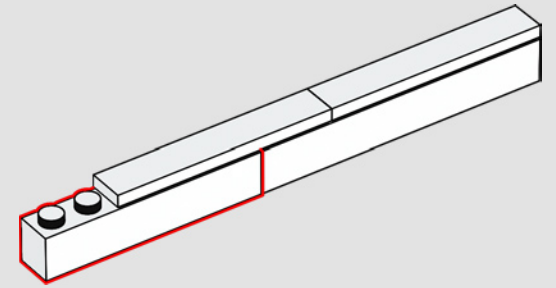

595

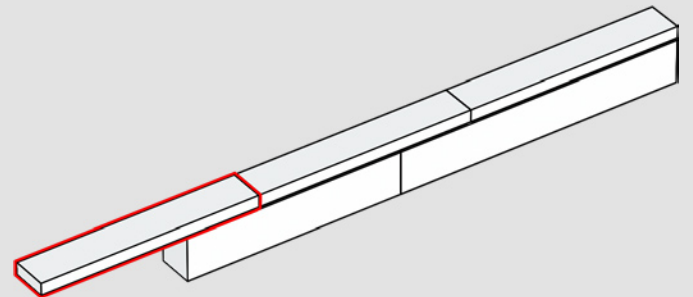

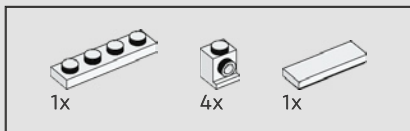

596

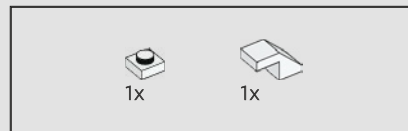
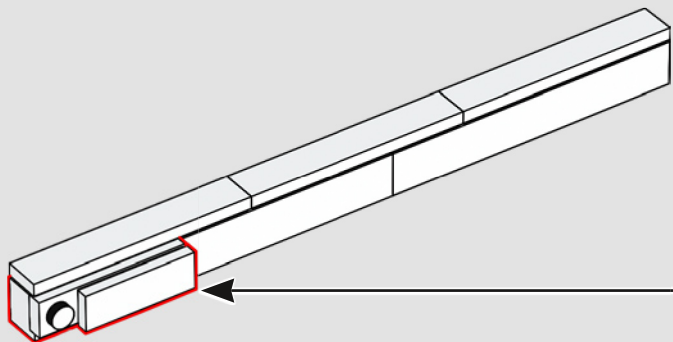
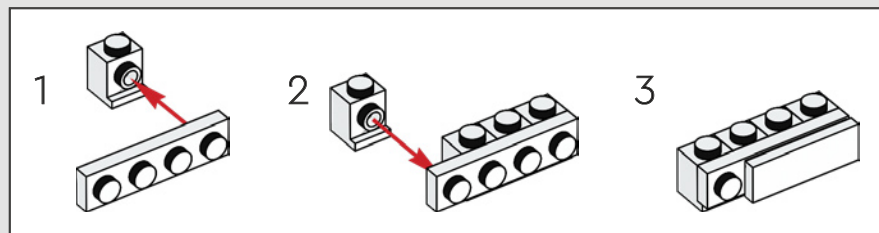

597

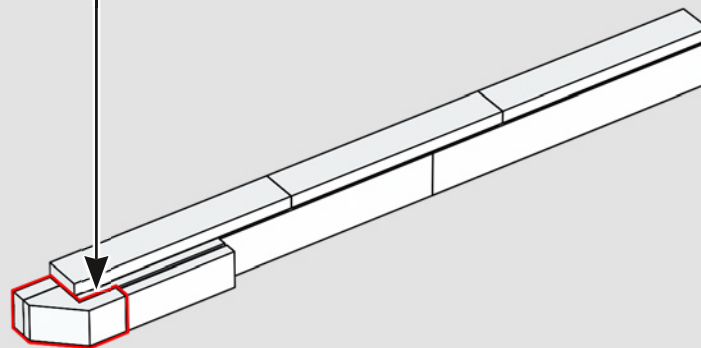
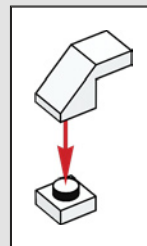

598

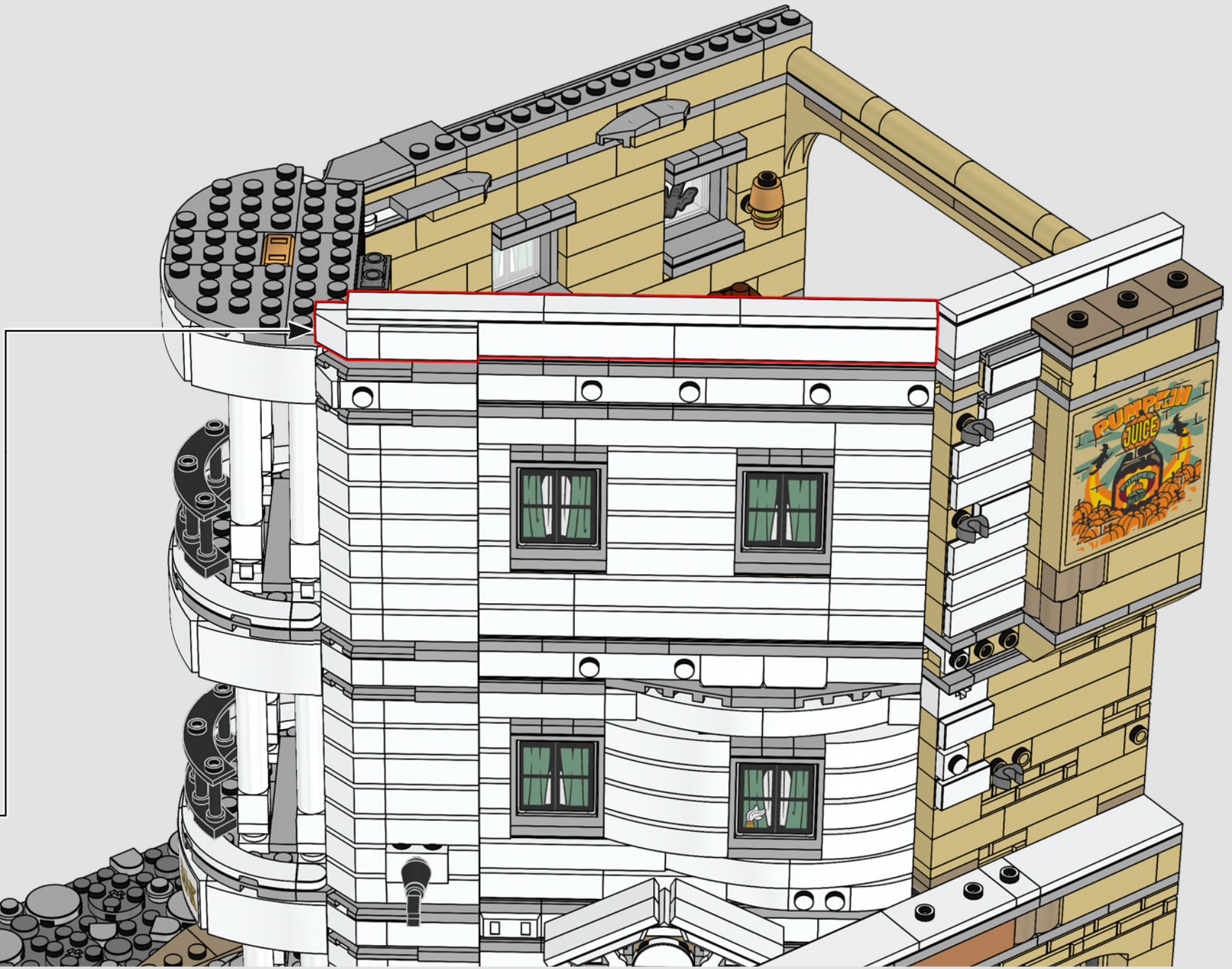

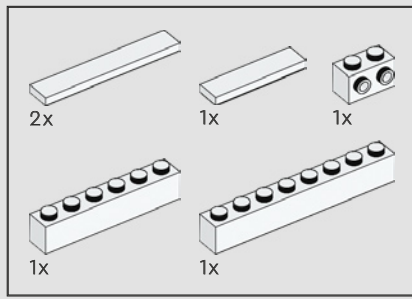

599

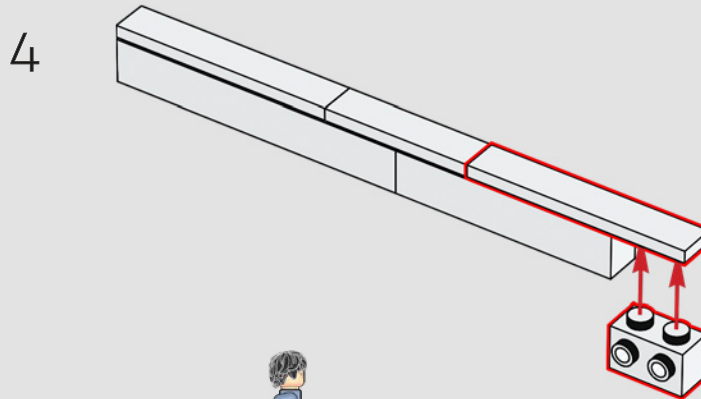
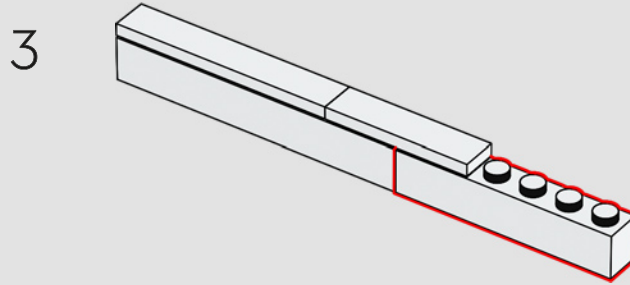
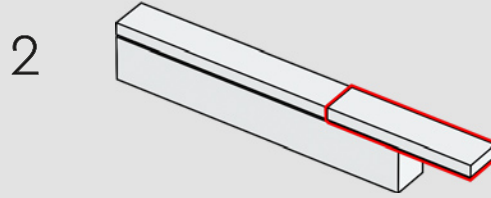
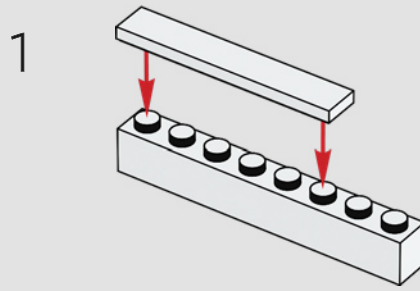

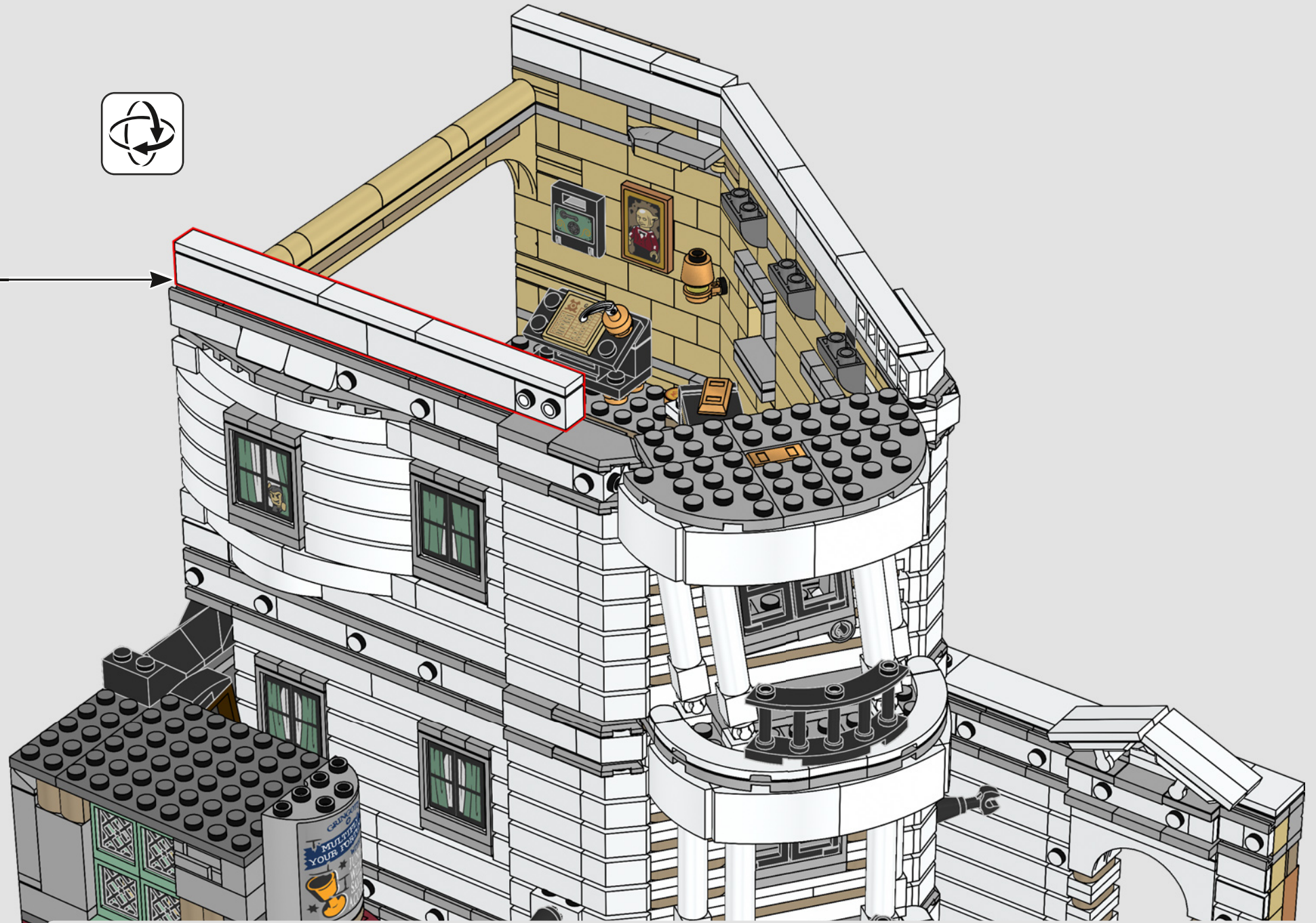



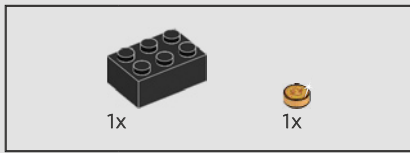

600

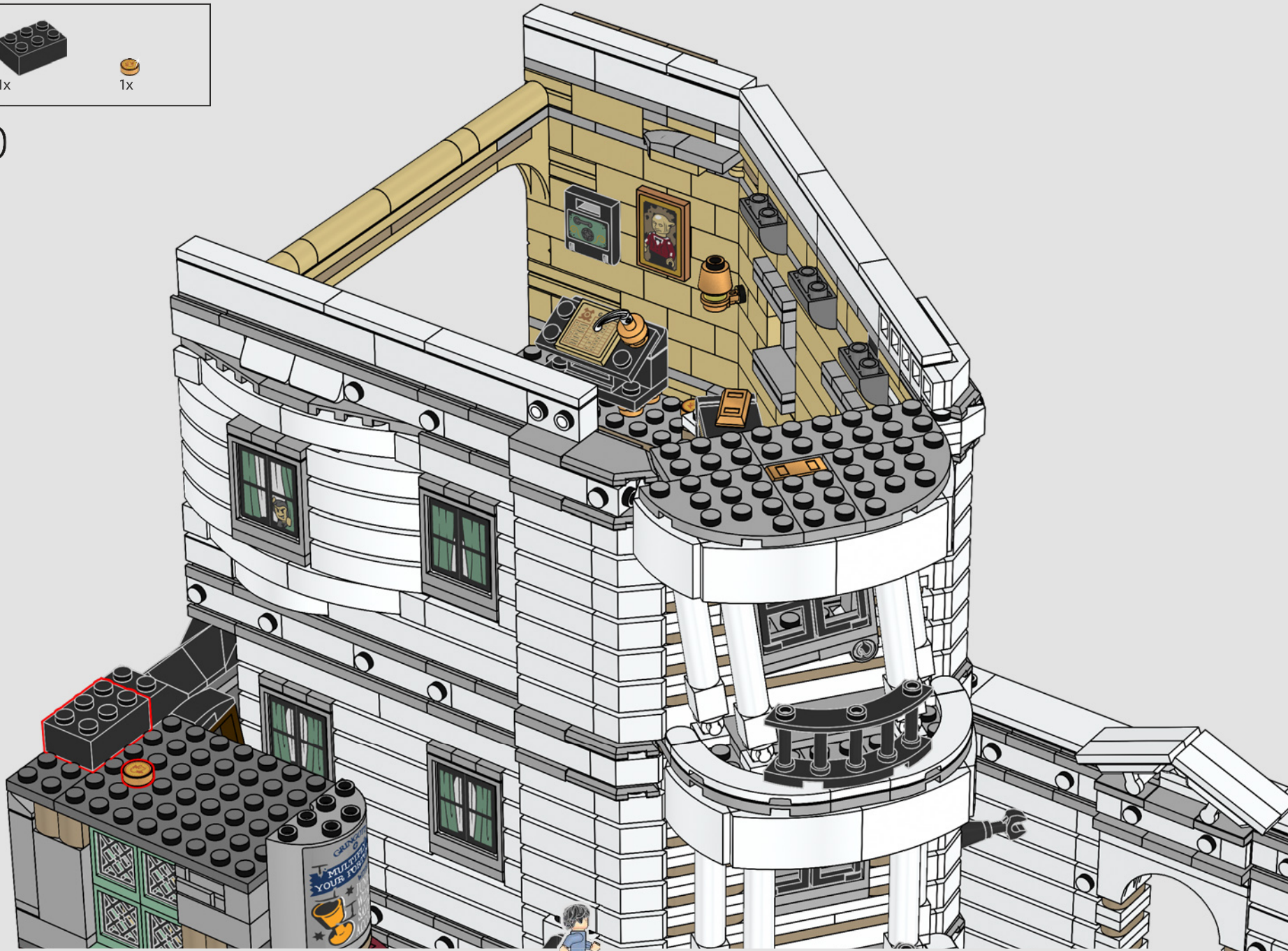

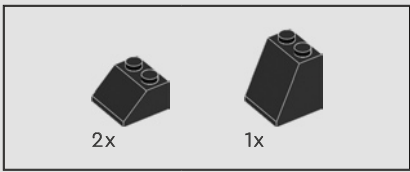

601

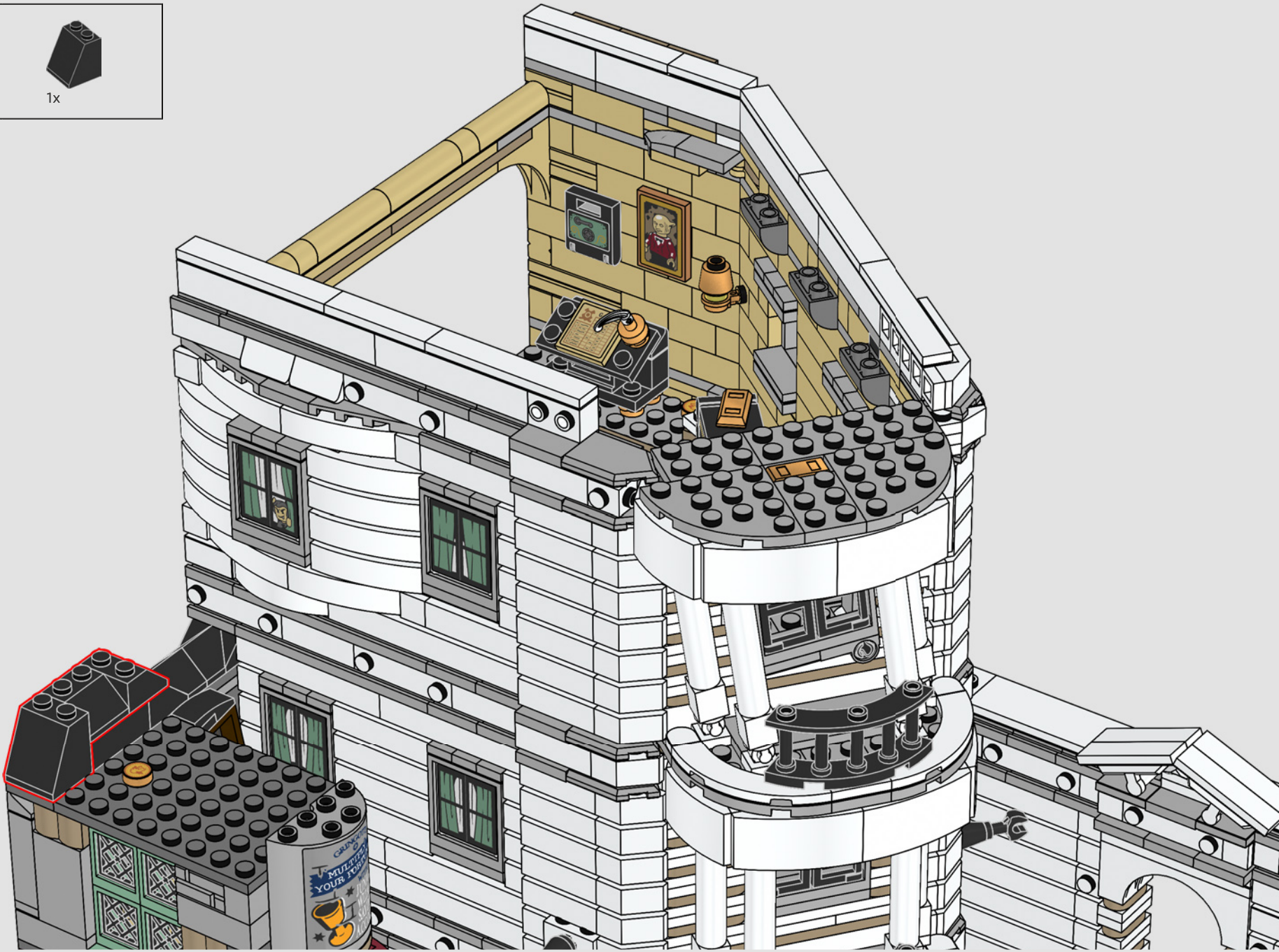

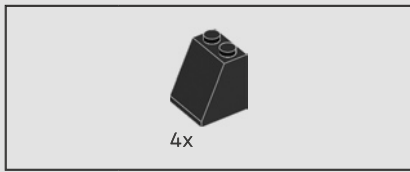

602

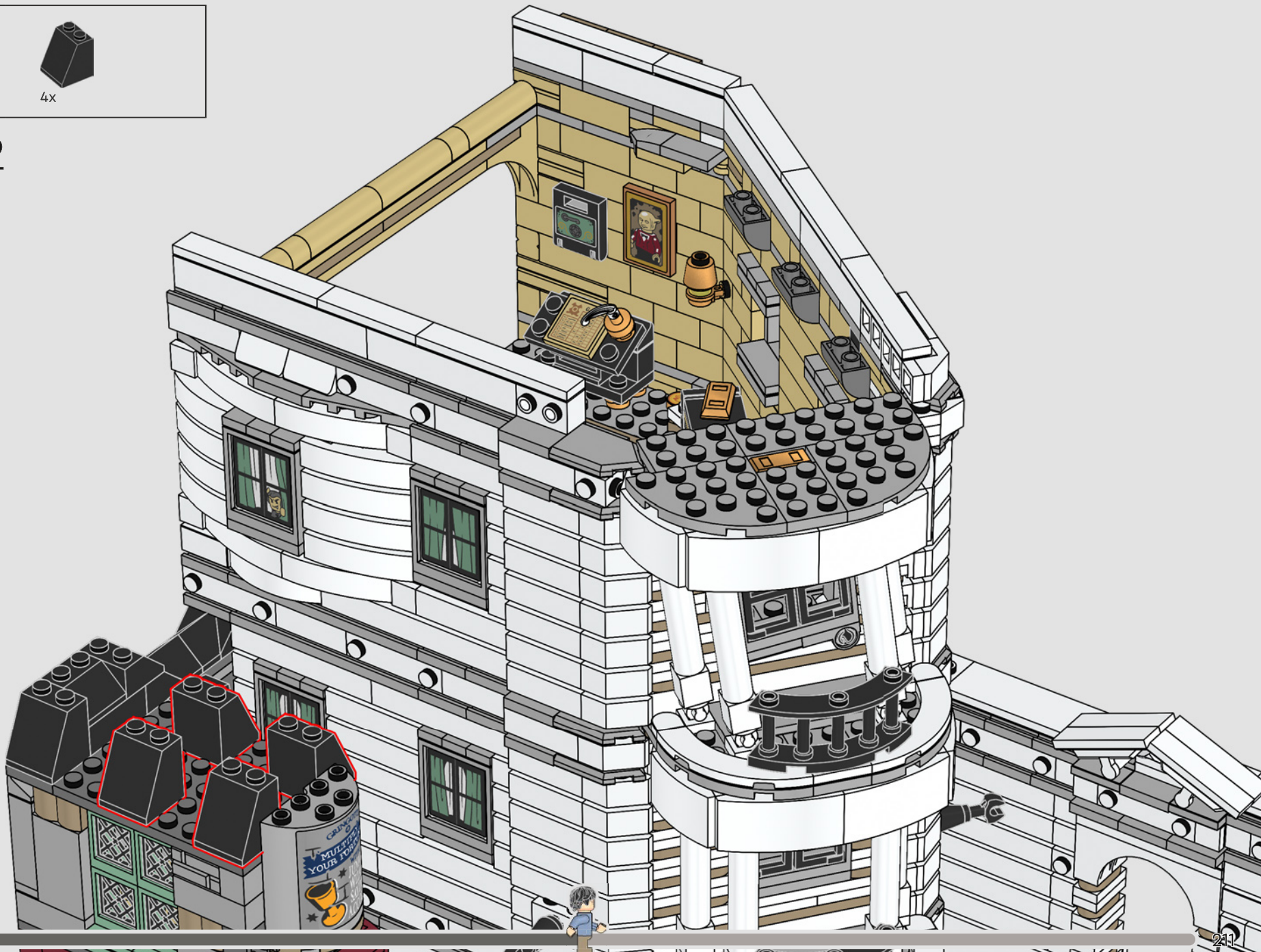

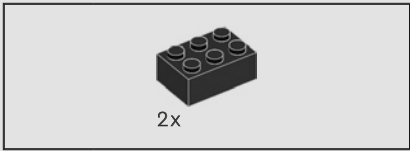

603

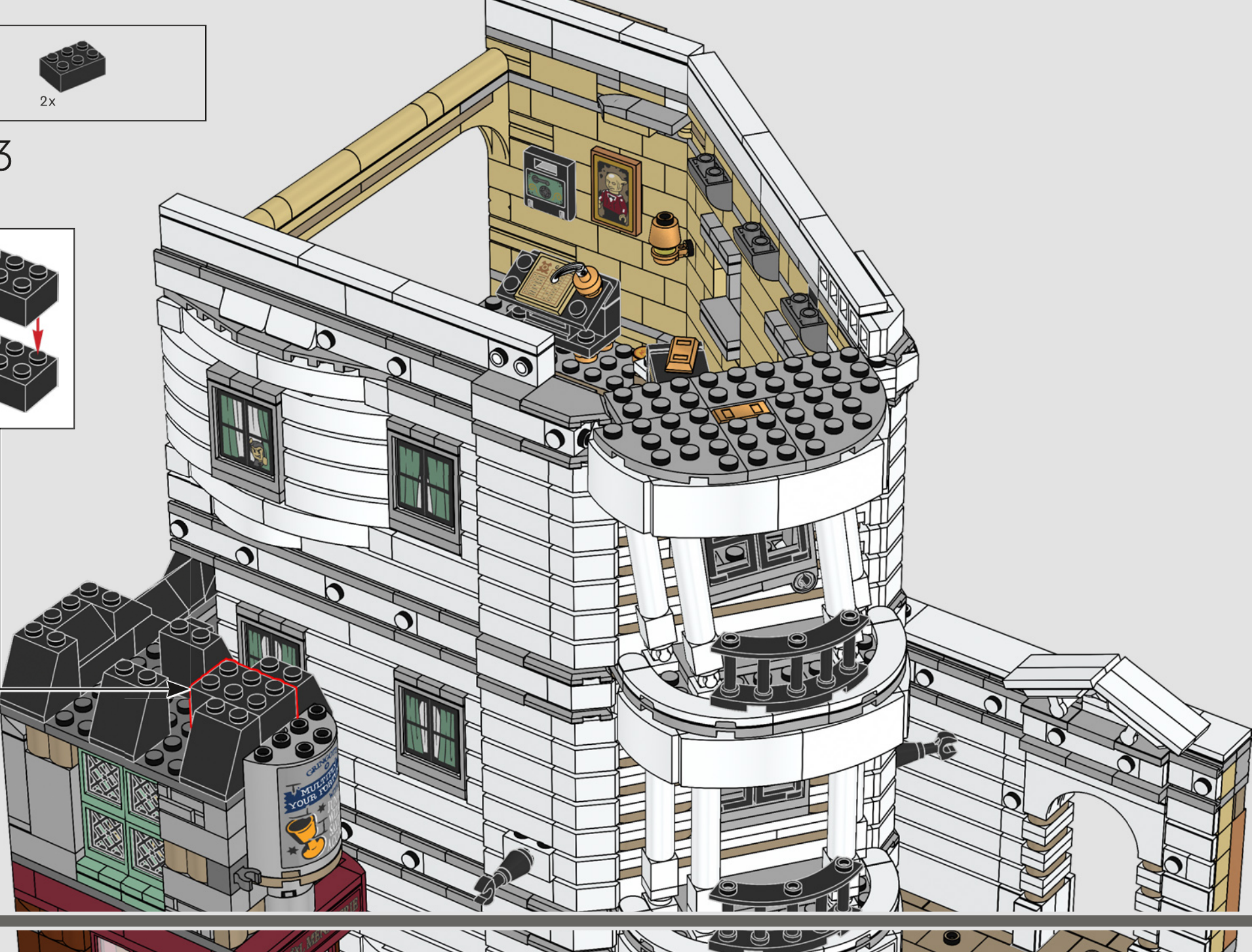
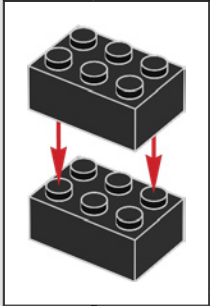



604

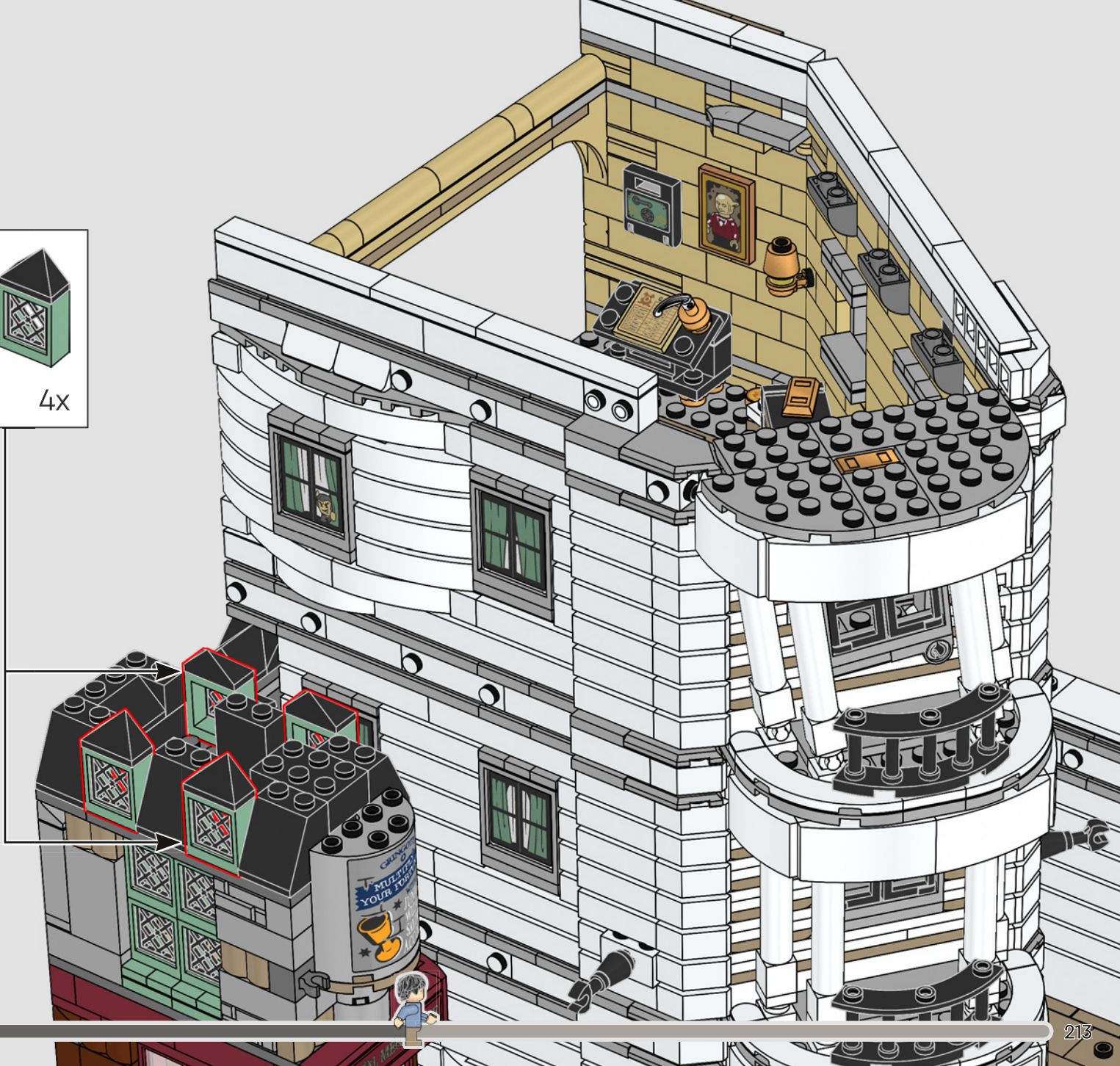
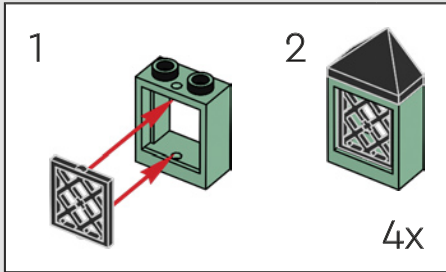

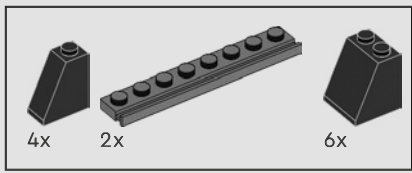

605

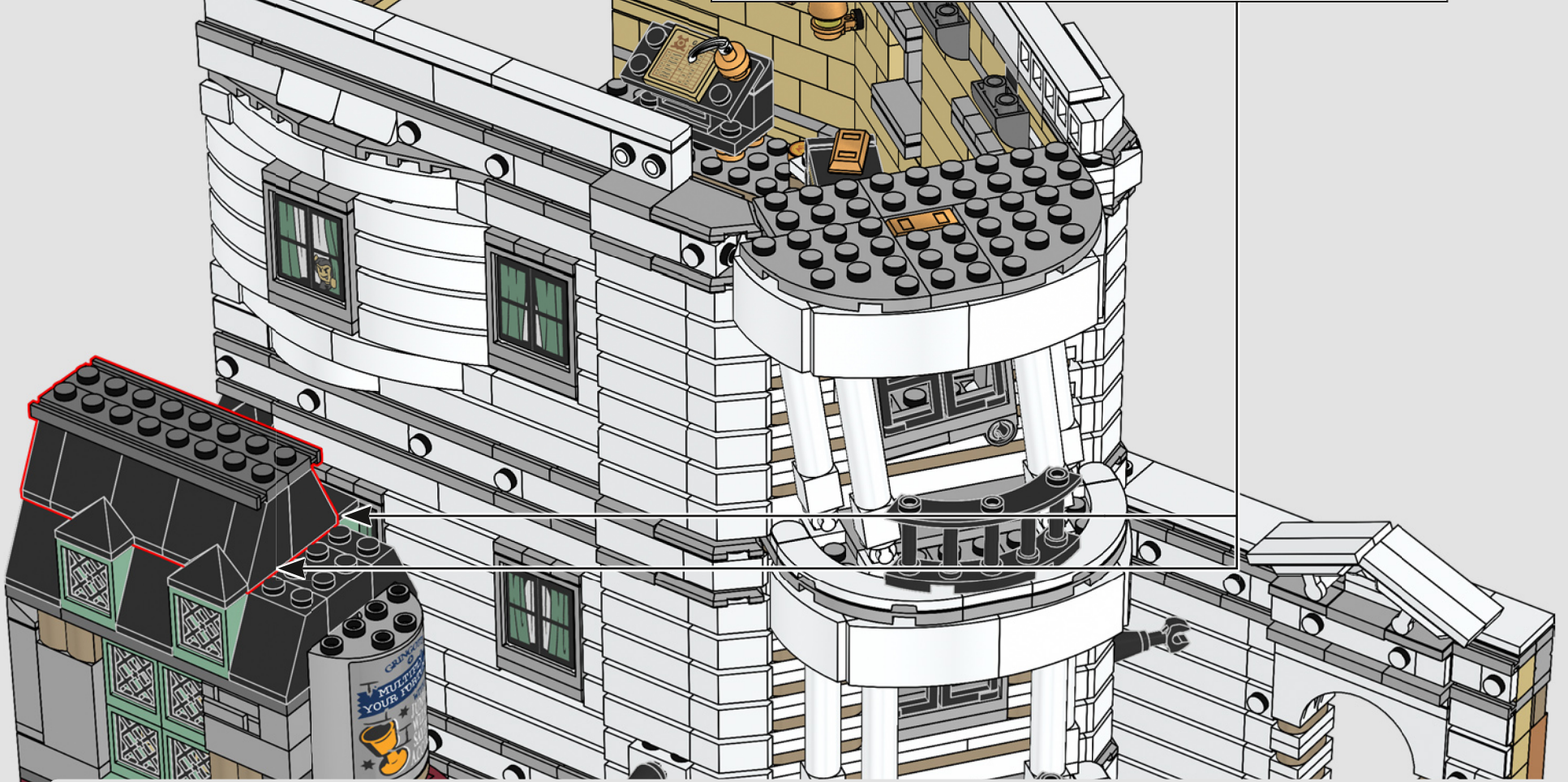
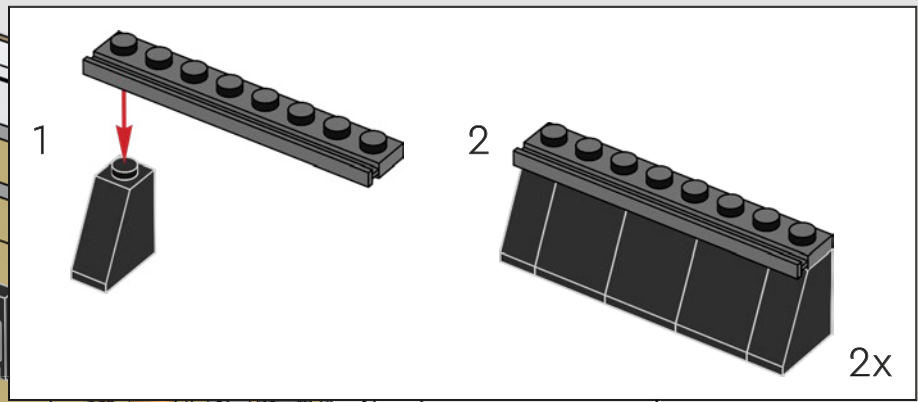

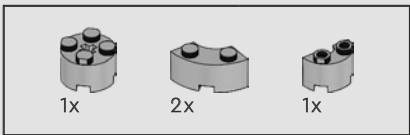

606

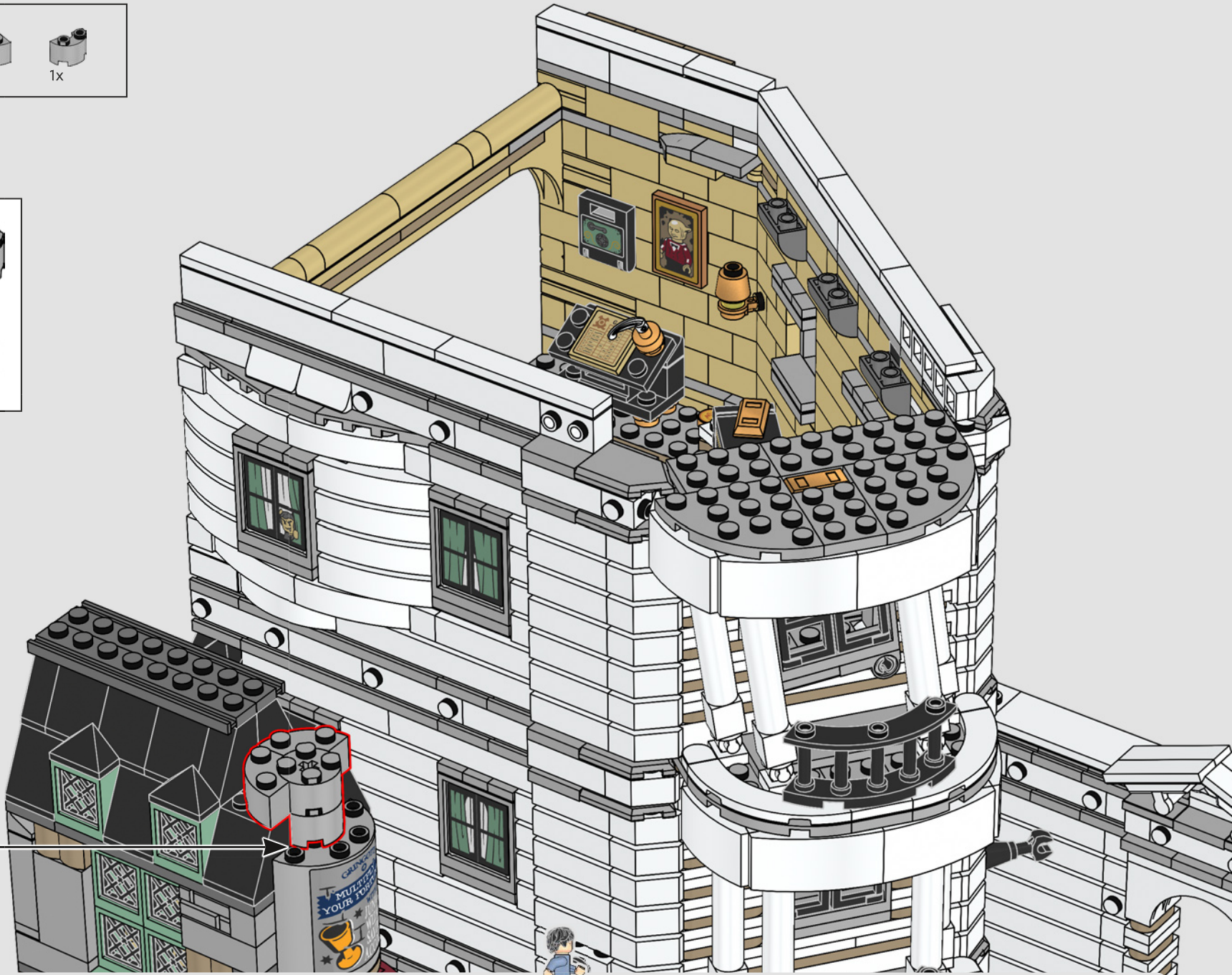
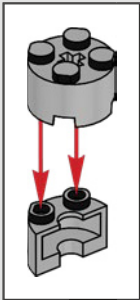

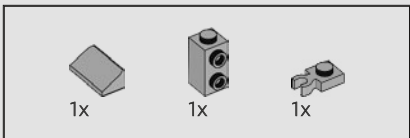

607

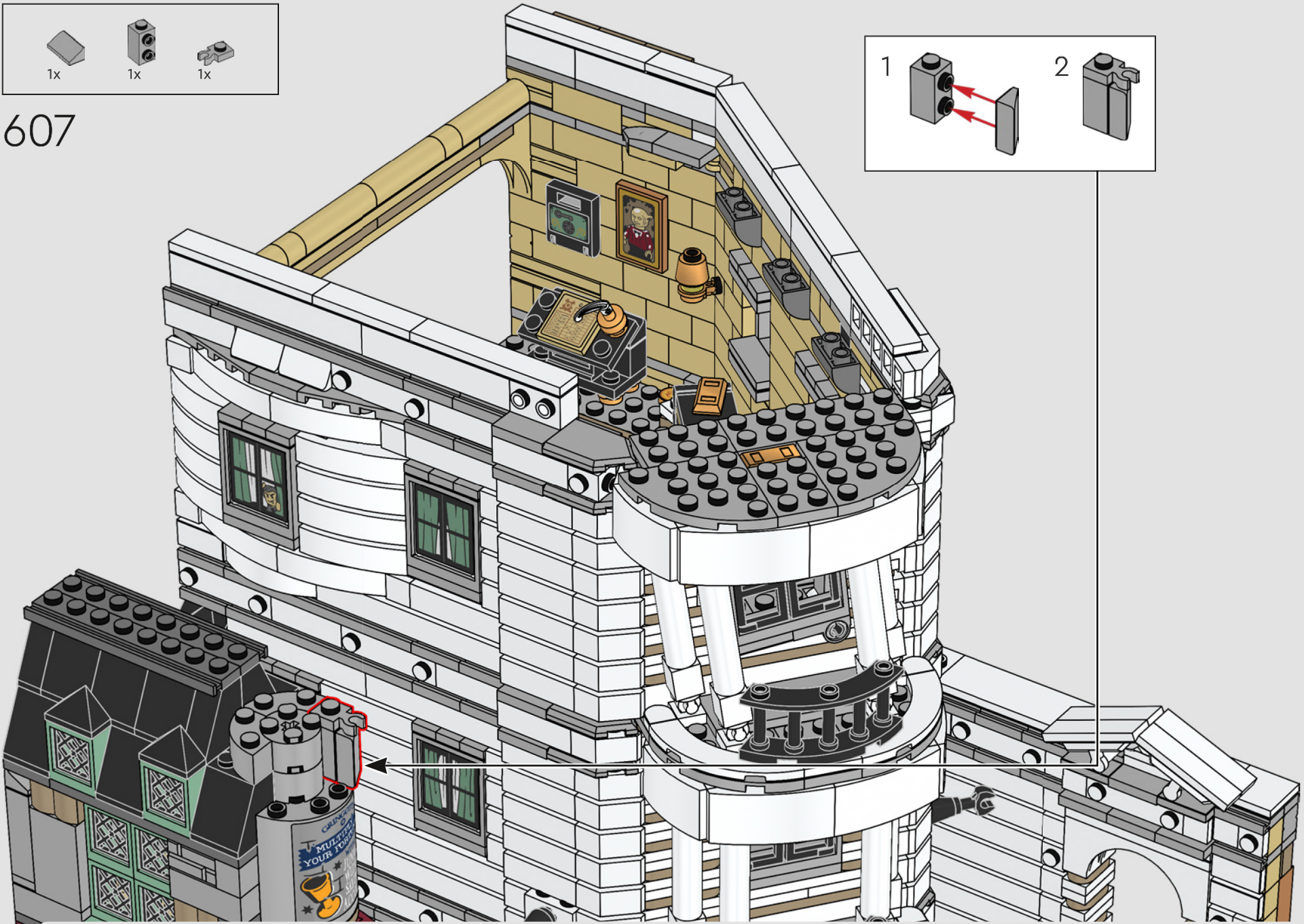
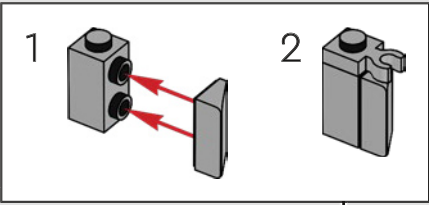



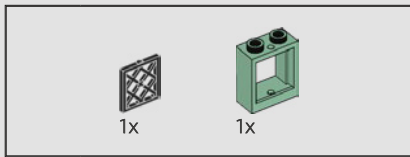

608

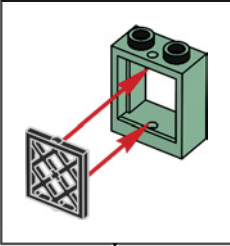
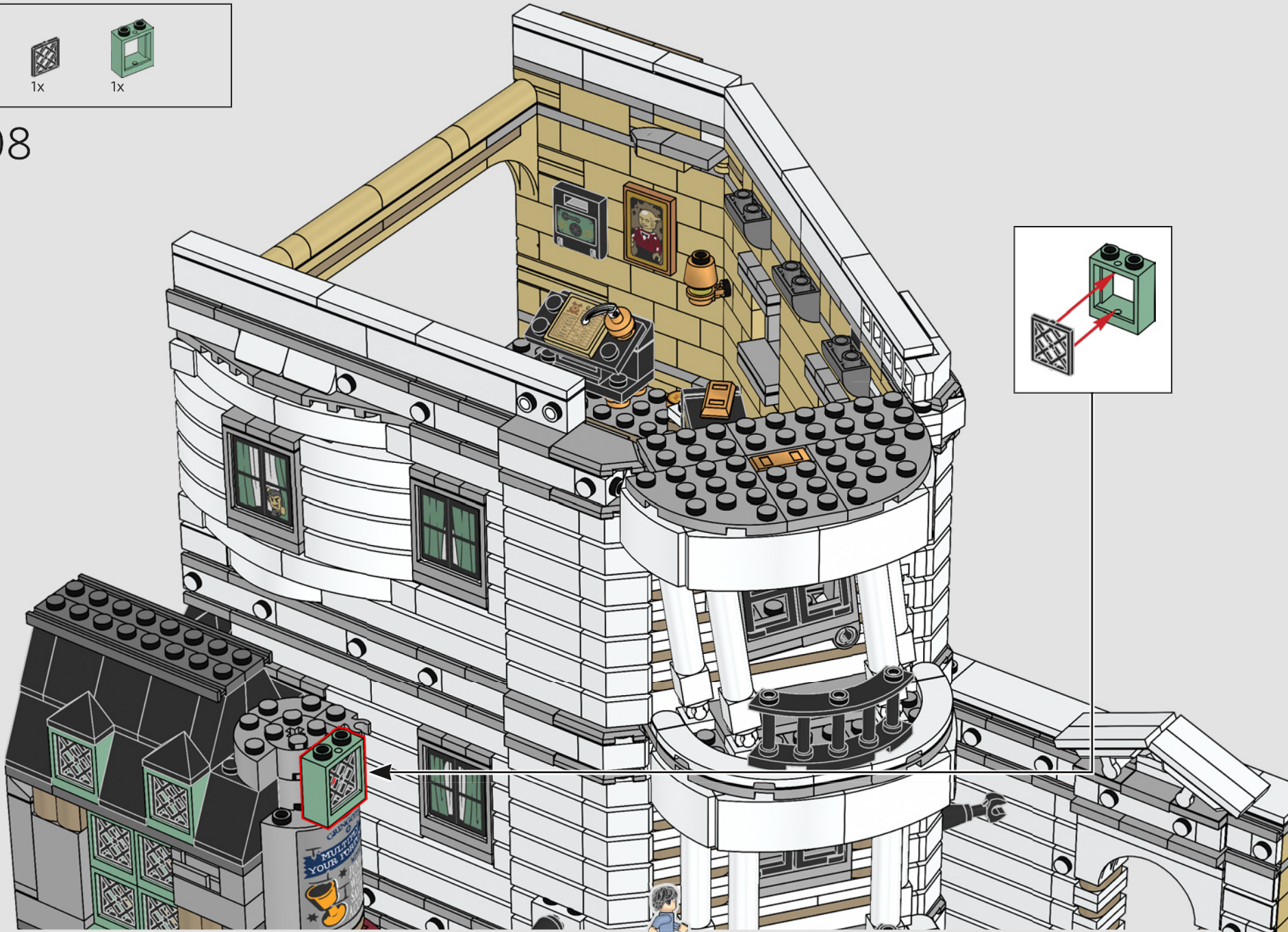

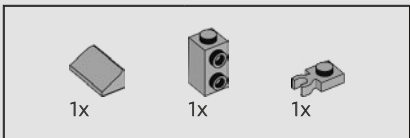

609

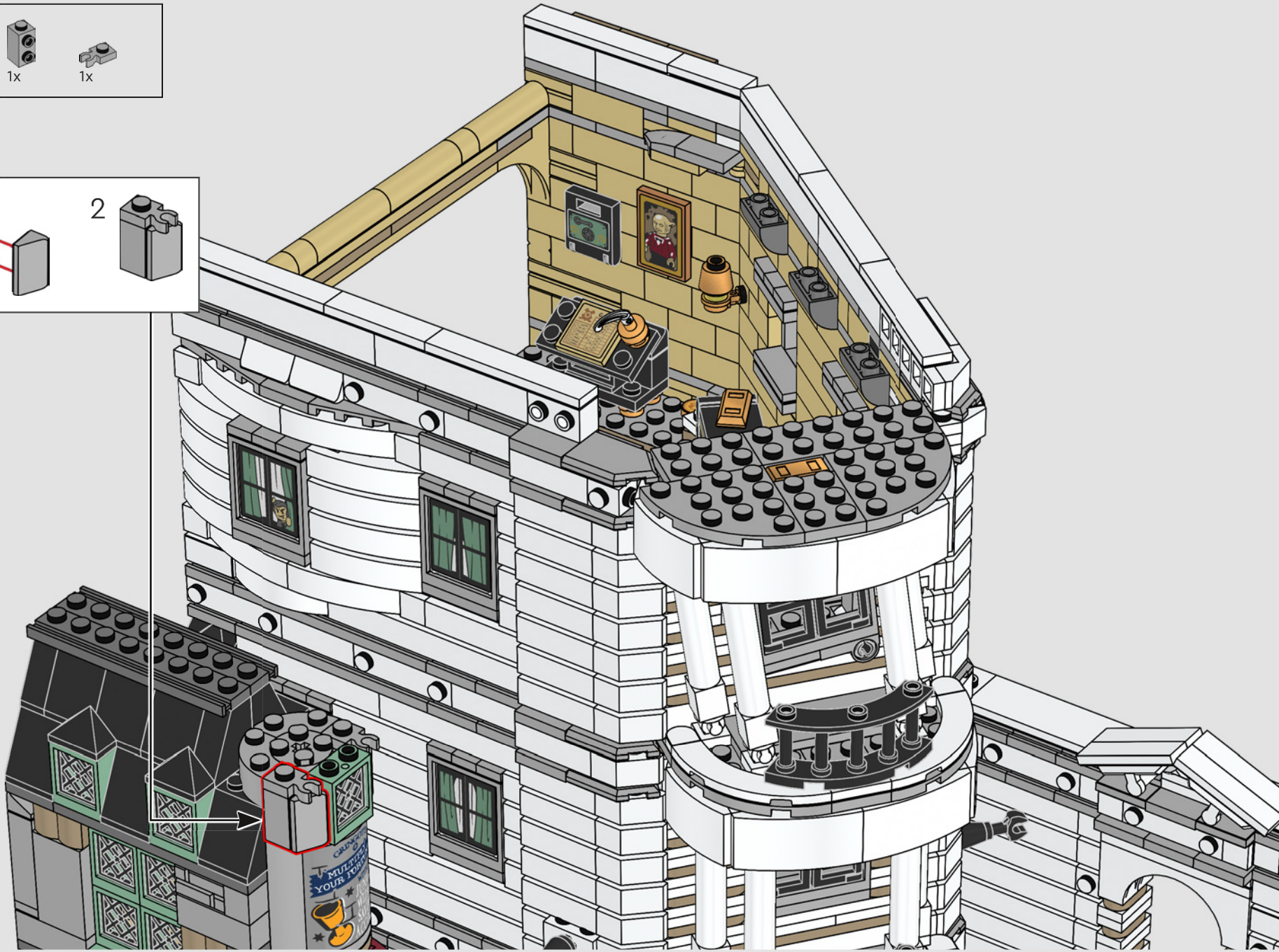
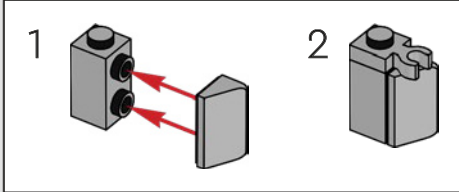



4x

610

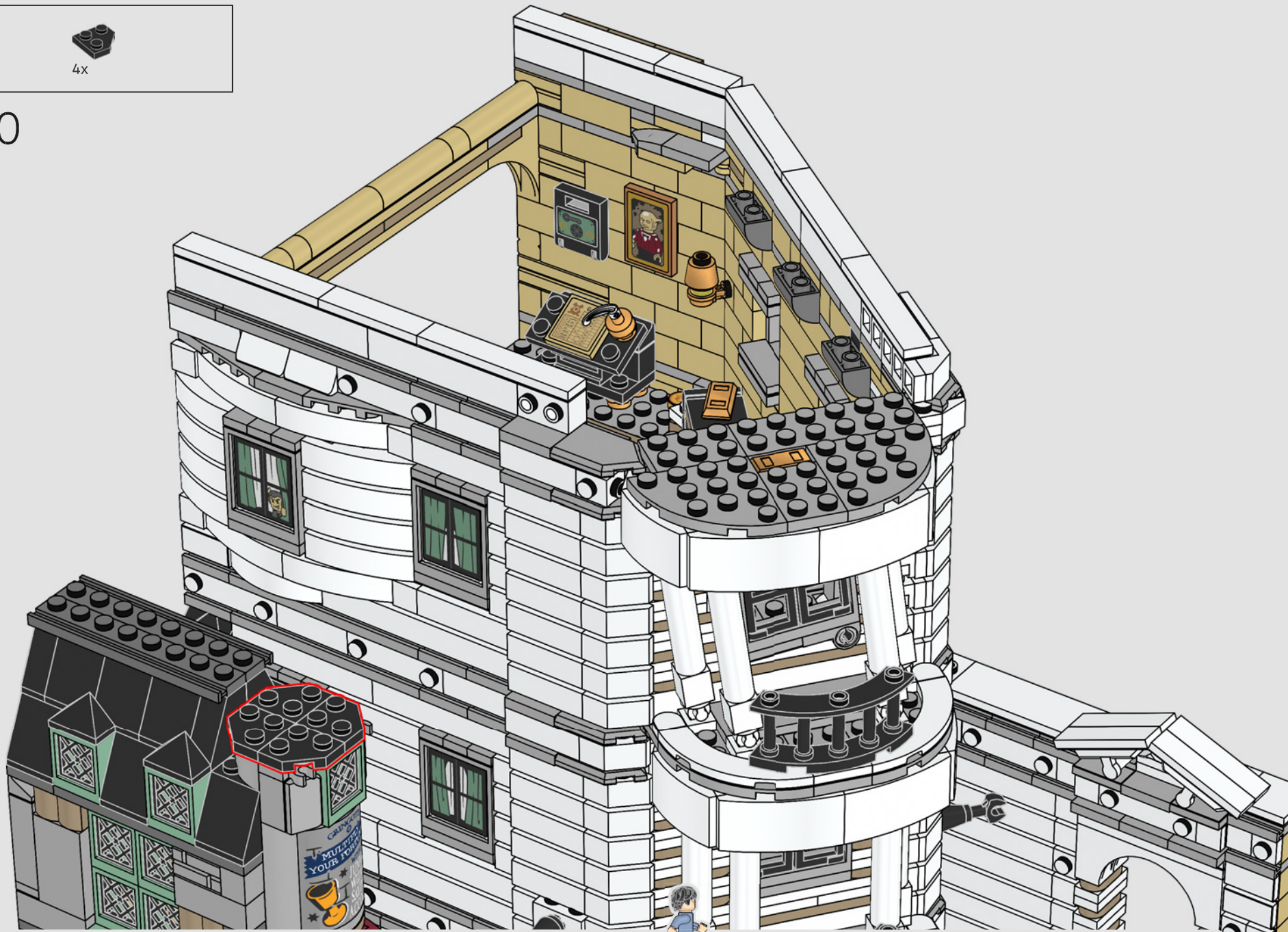

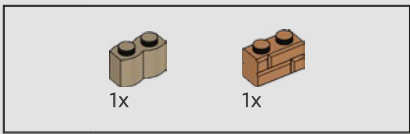

611

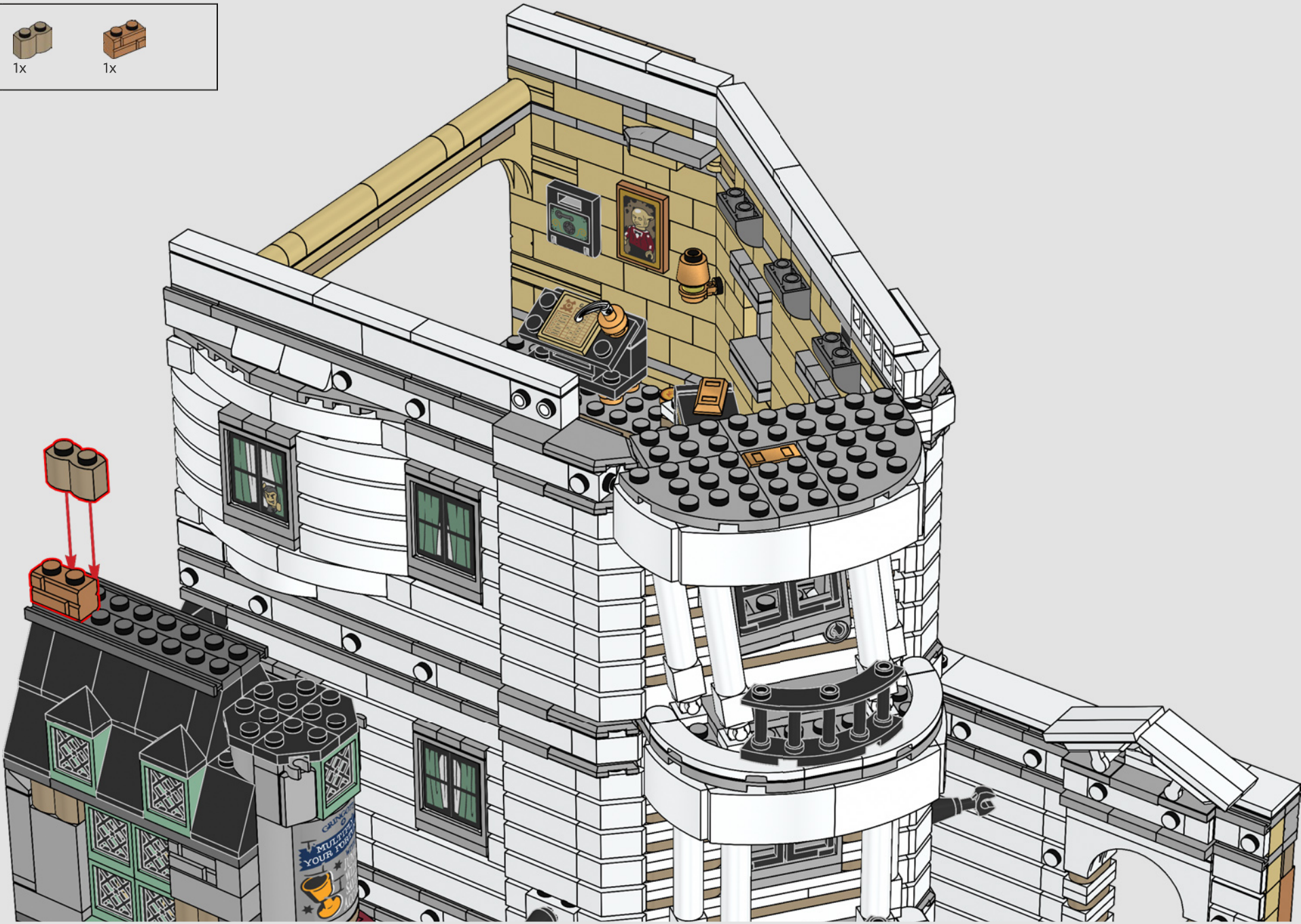

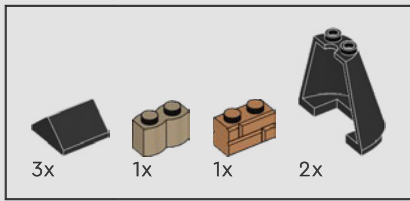

612

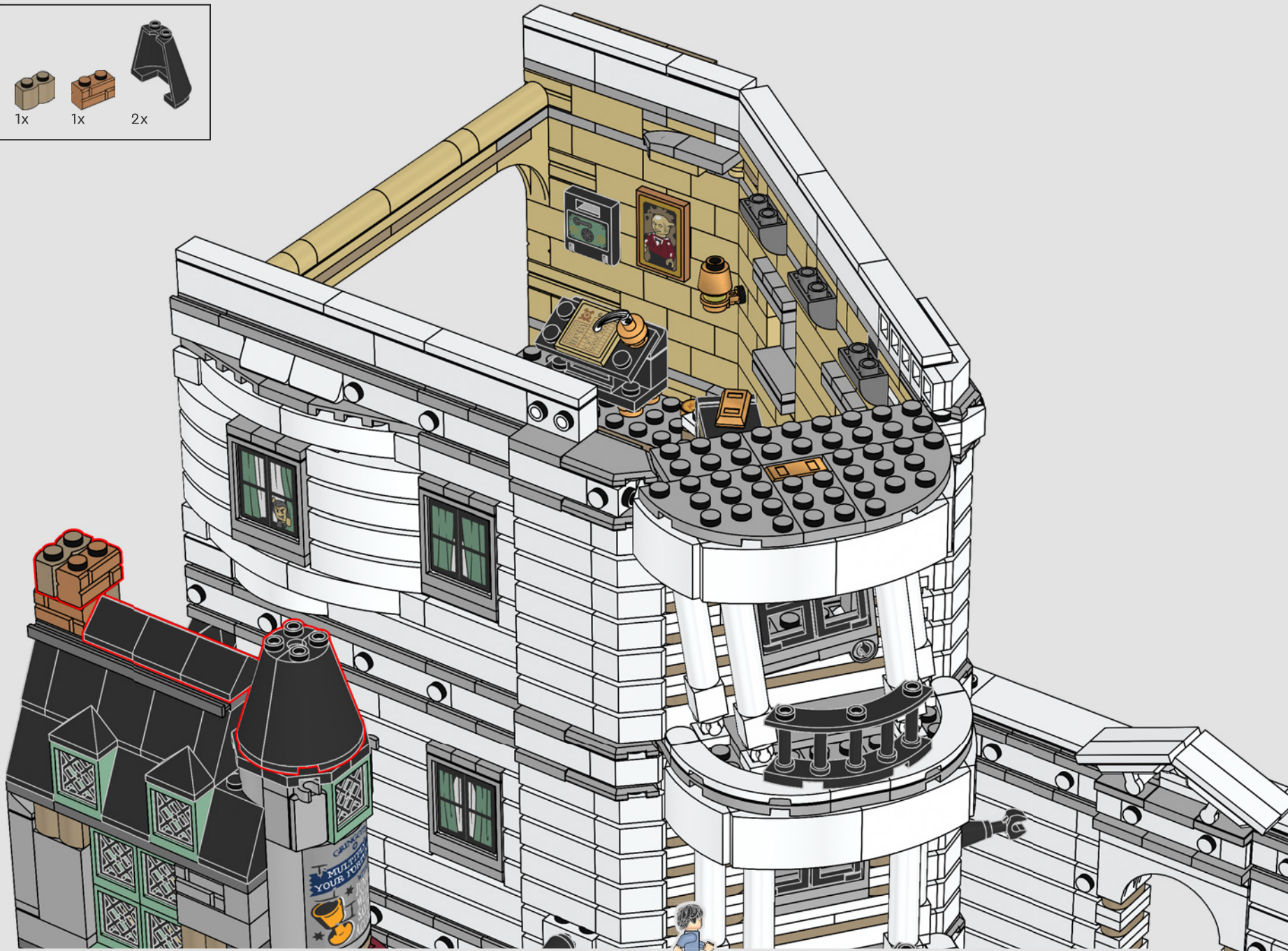

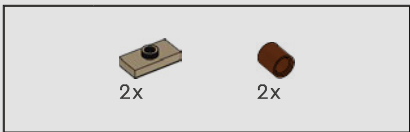

613

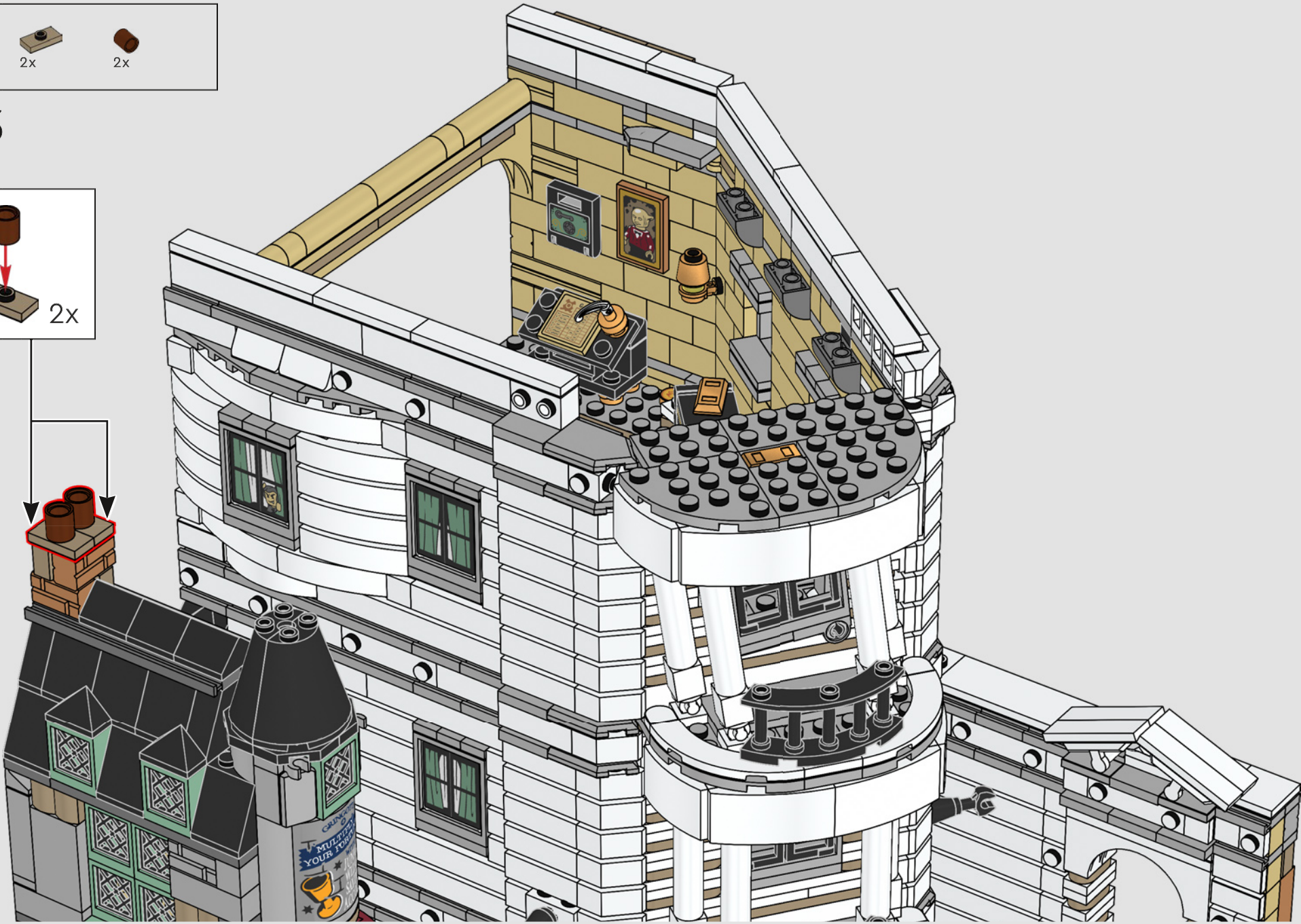
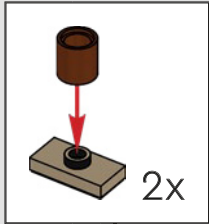

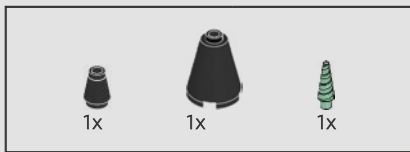

614

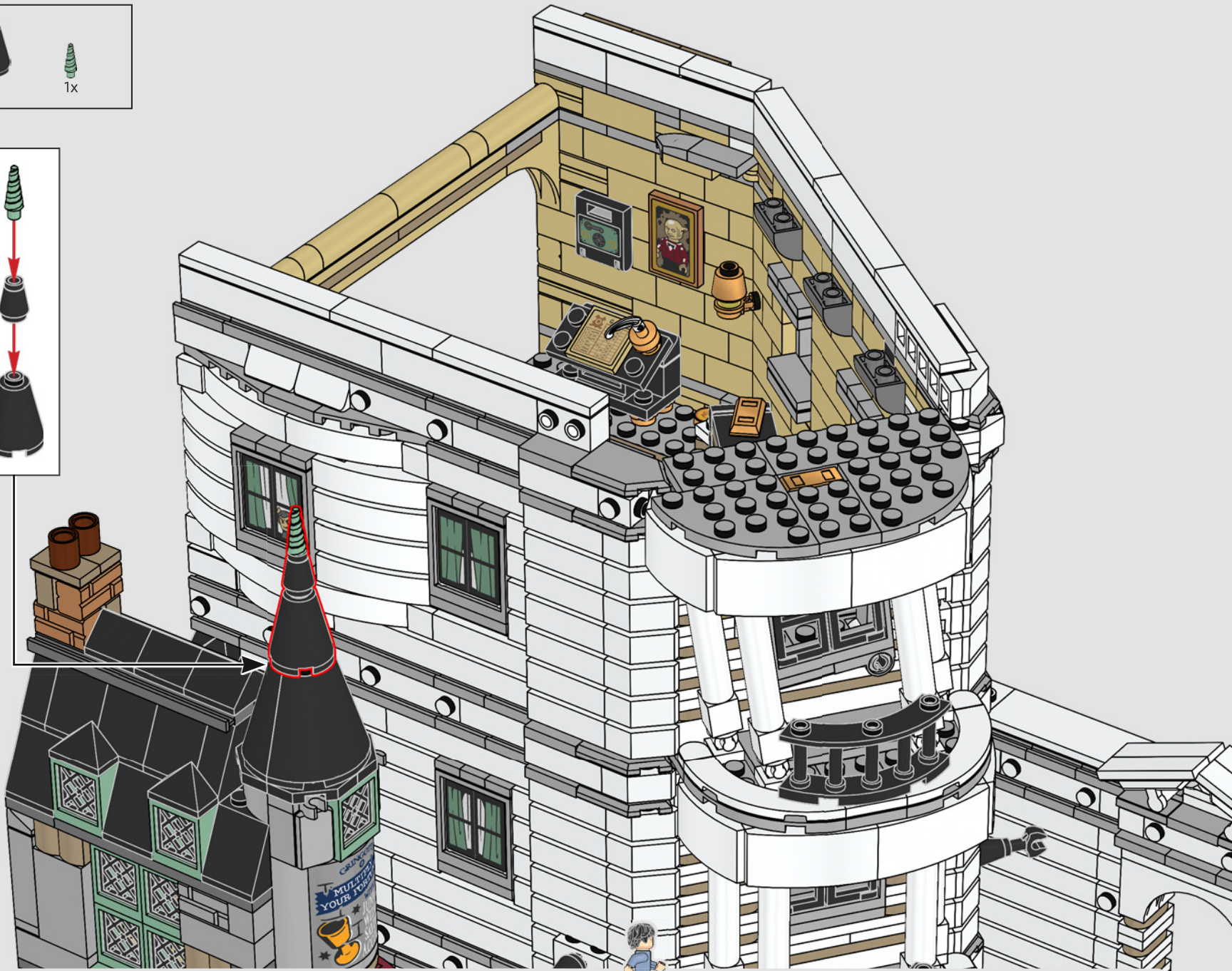
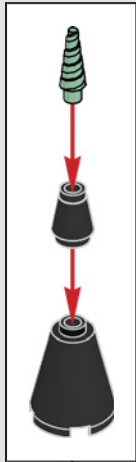

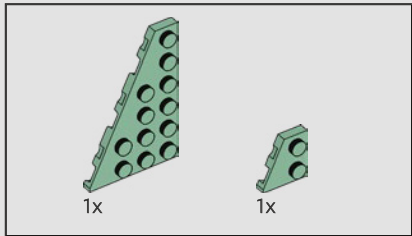
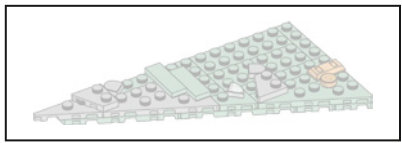

615

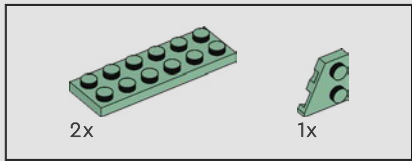
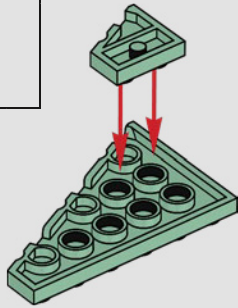

616

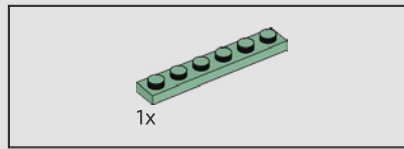
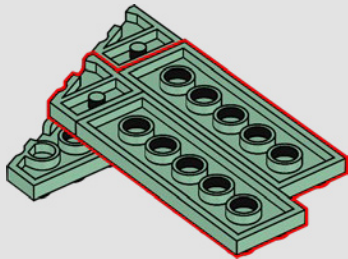

617

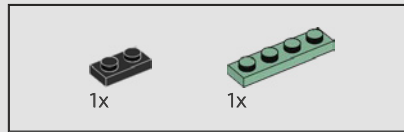
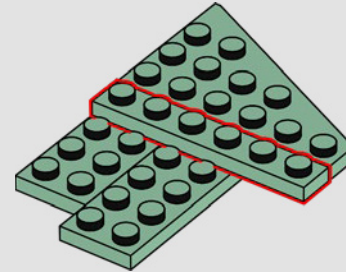

618

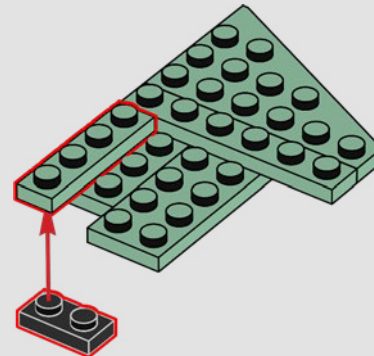



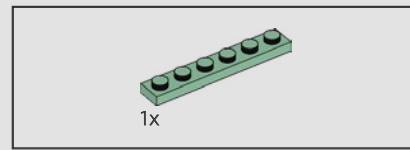
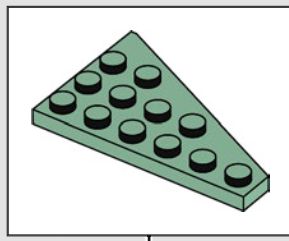
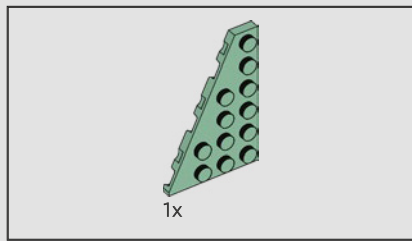

619

621

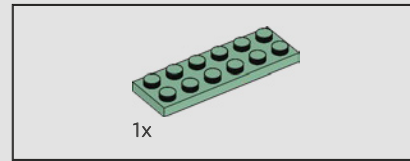
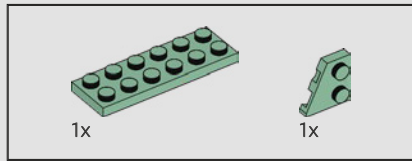
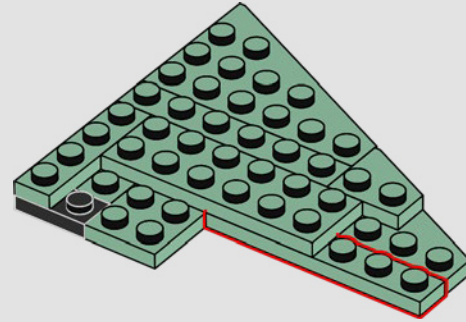
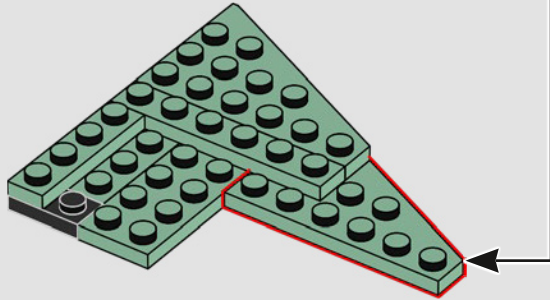

620

622

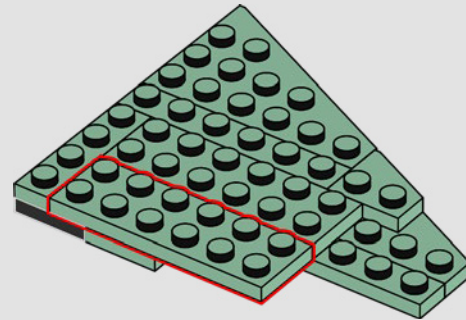
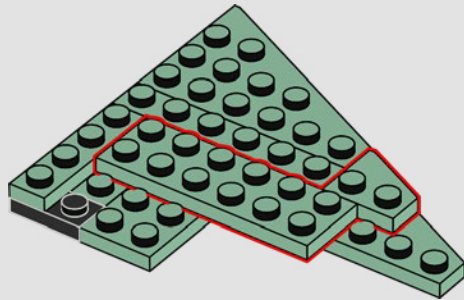

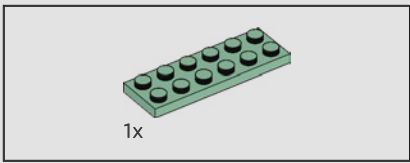

623

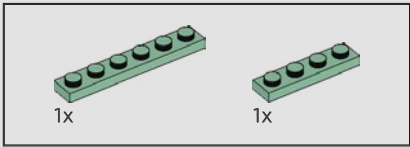
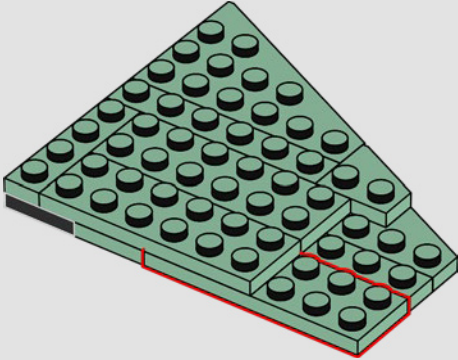

624

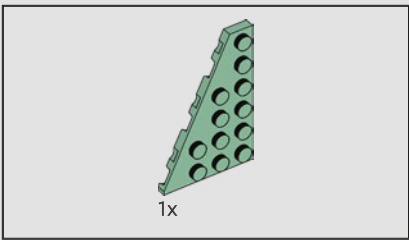
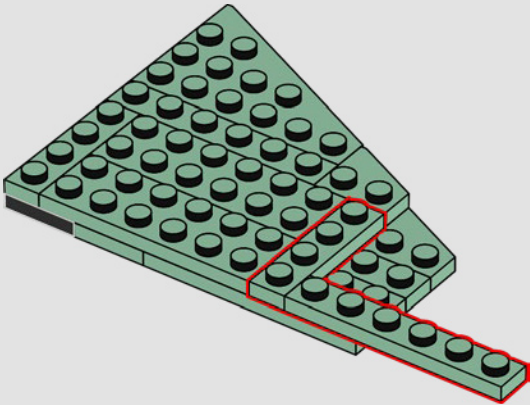

625

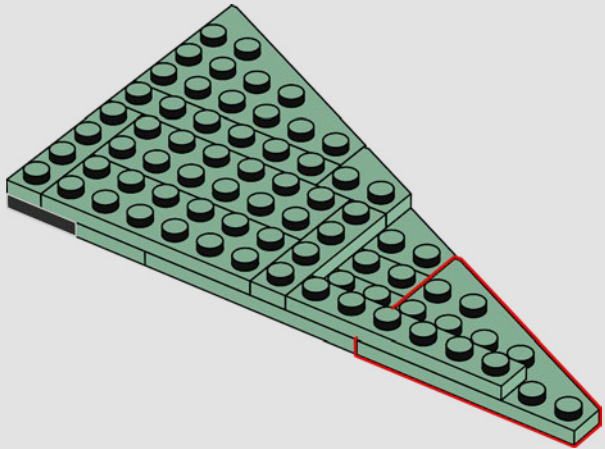

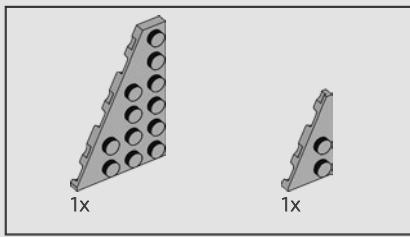

626

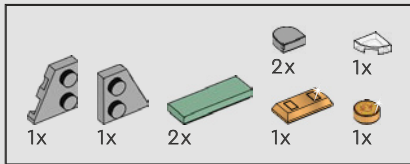
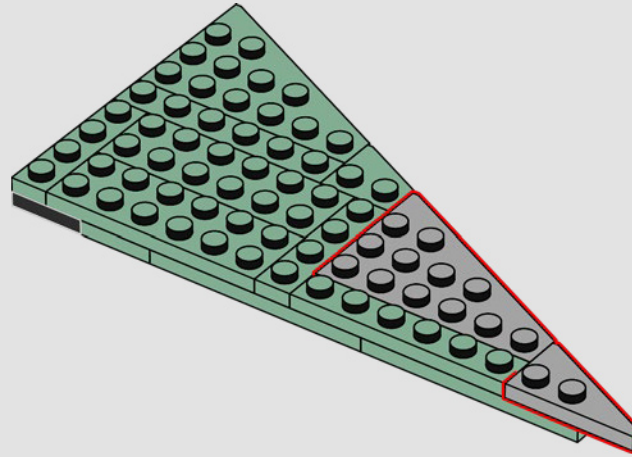

627

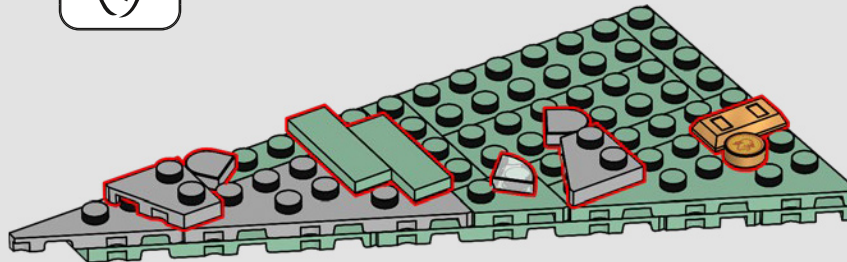

628

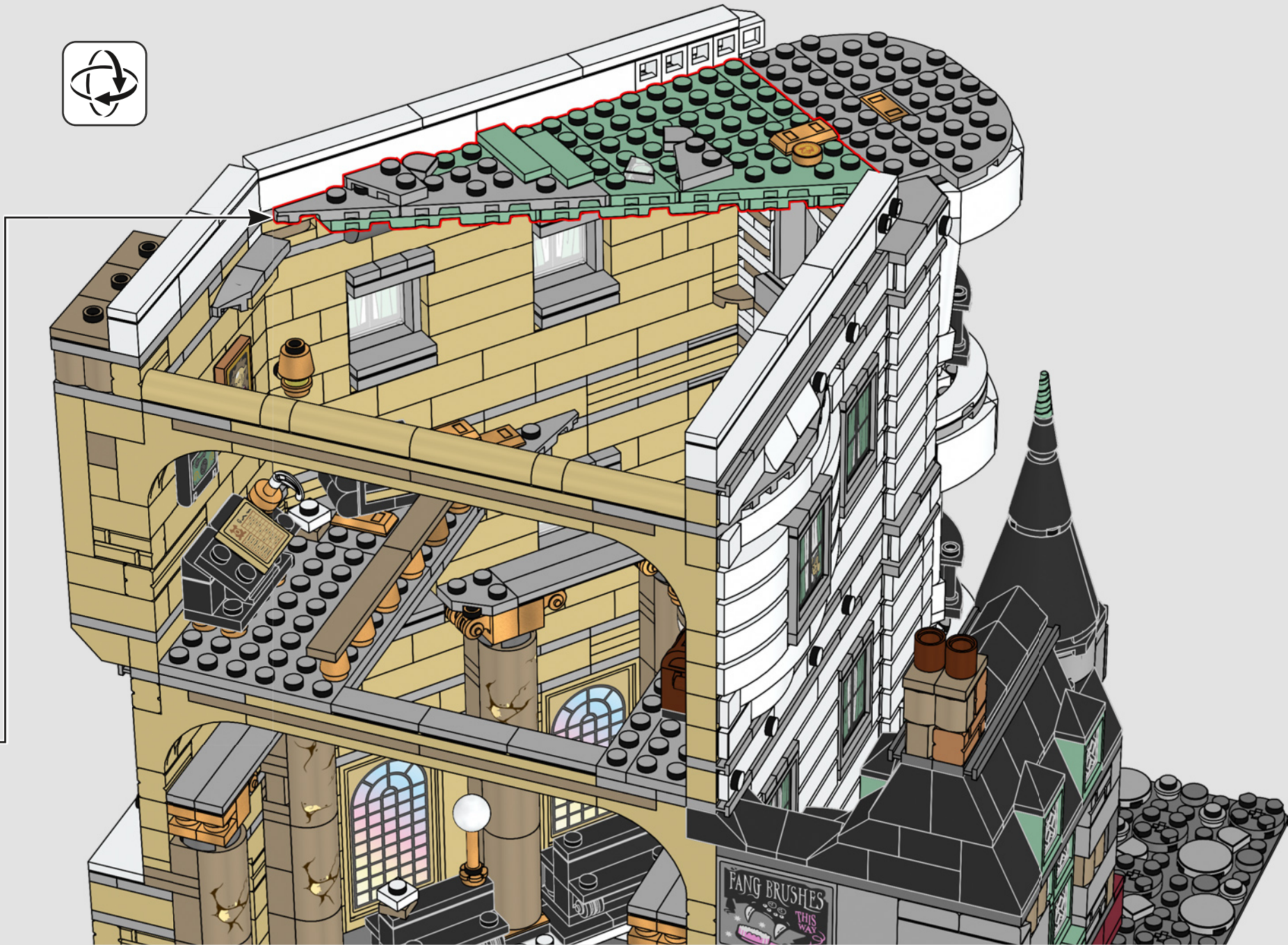

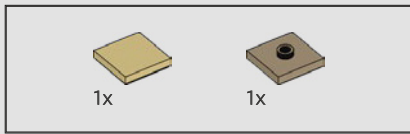

629

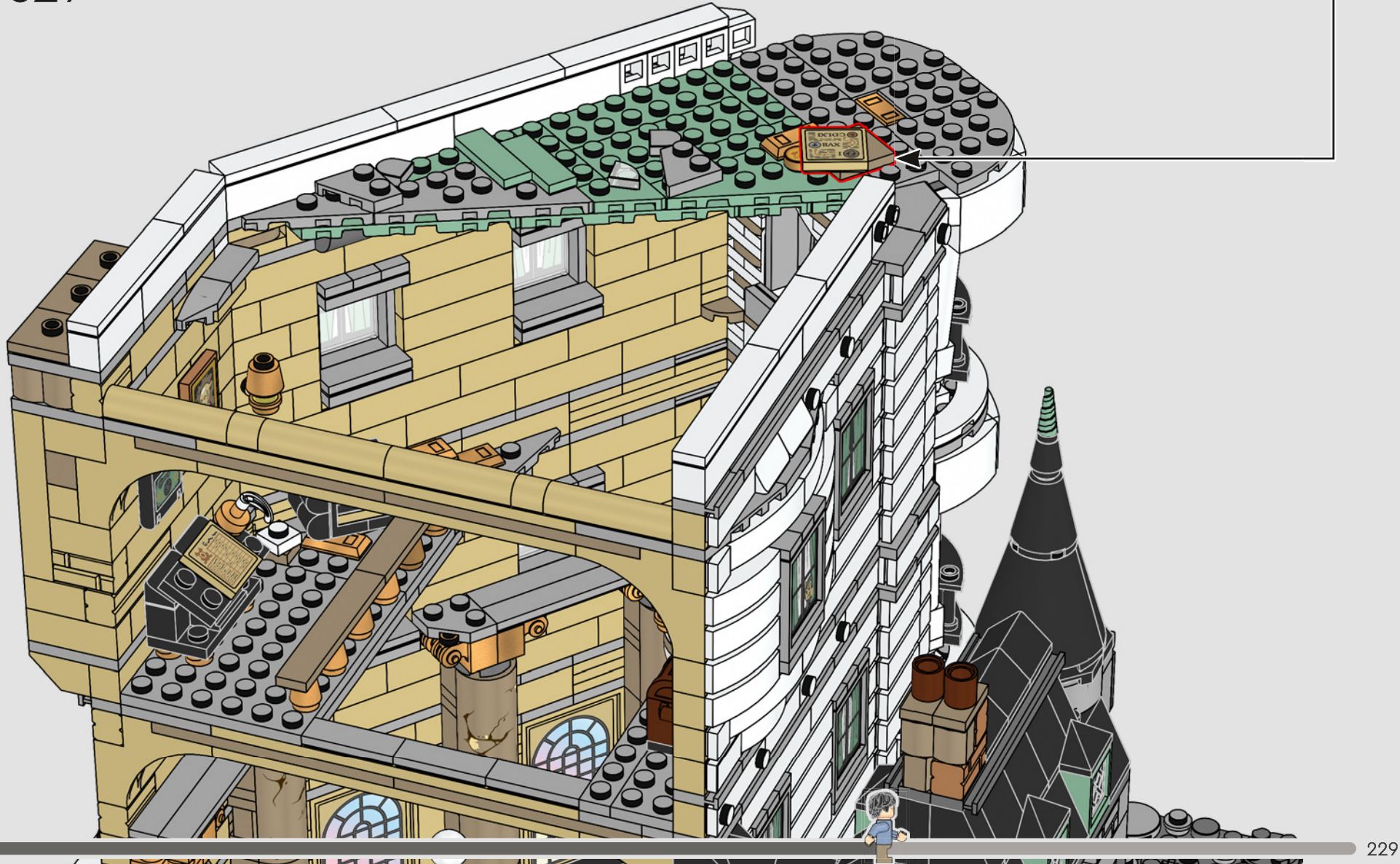
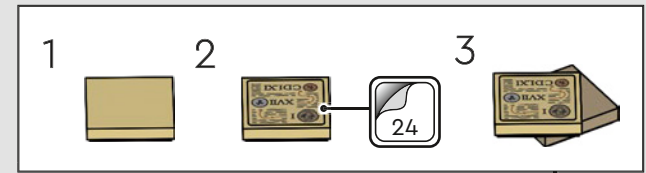

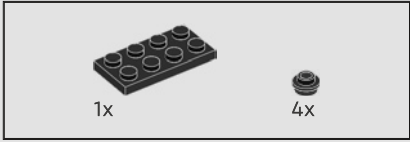

630

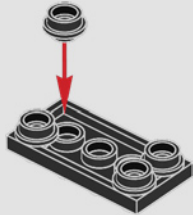

631

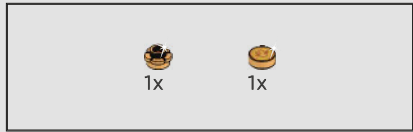
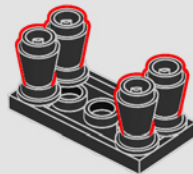

632

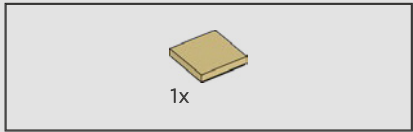
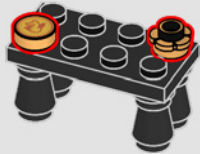

633

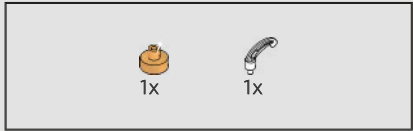
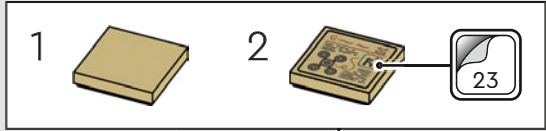

634

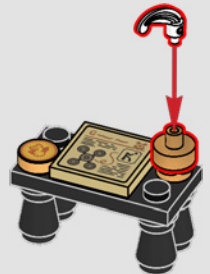

635

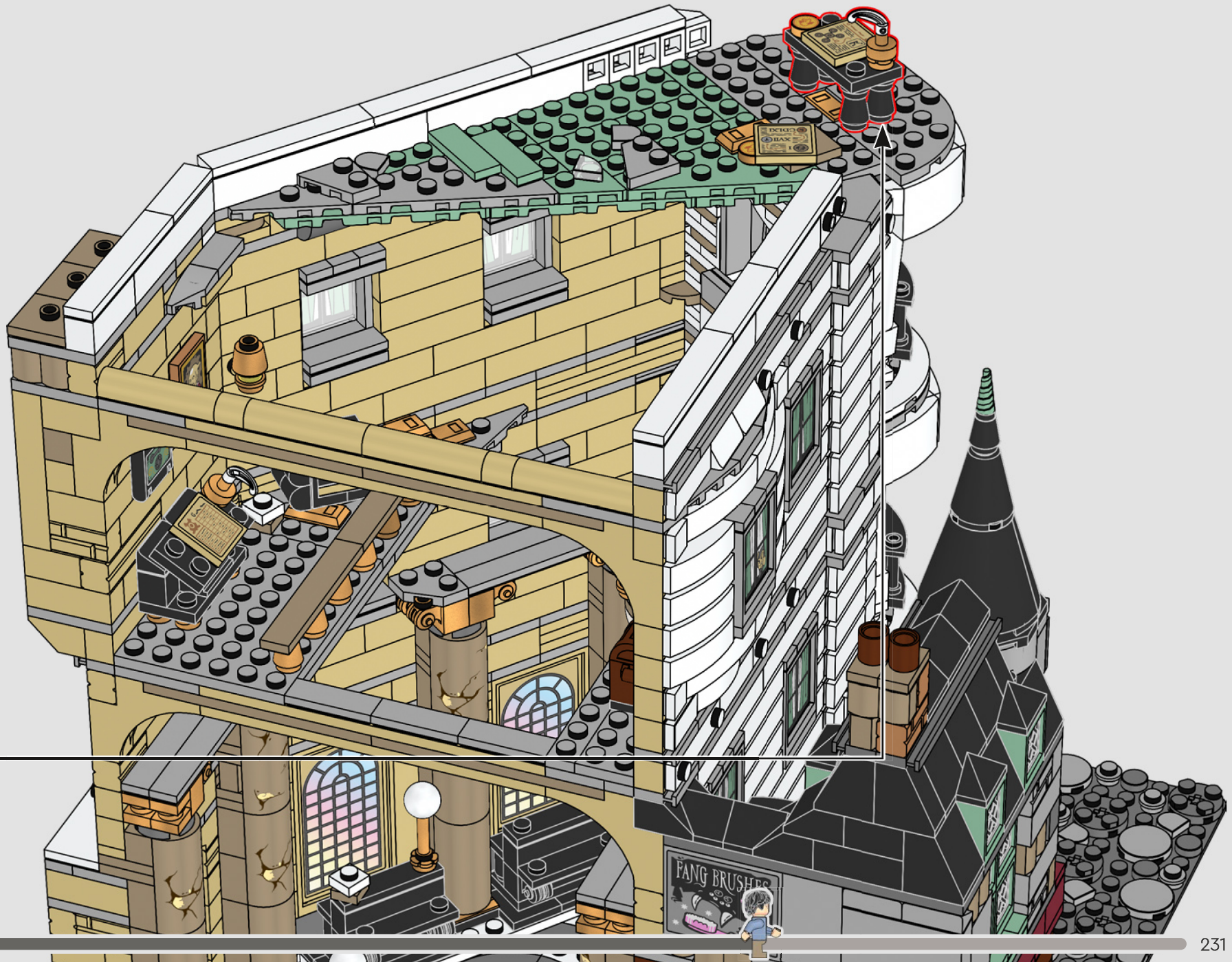

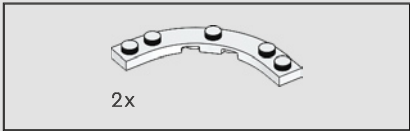
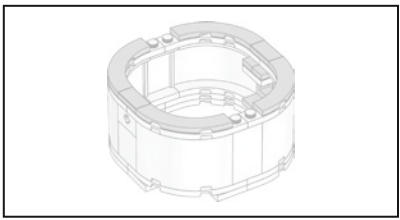

636

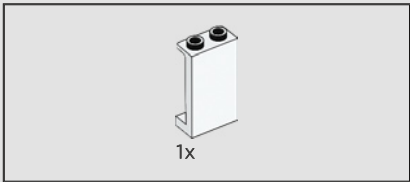
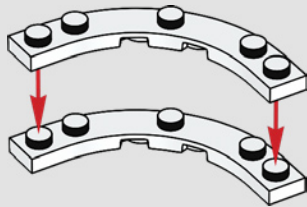

637

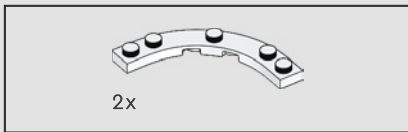
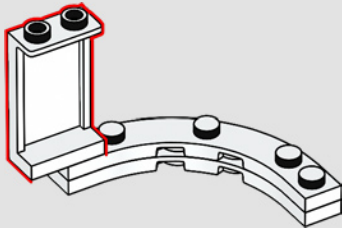

638

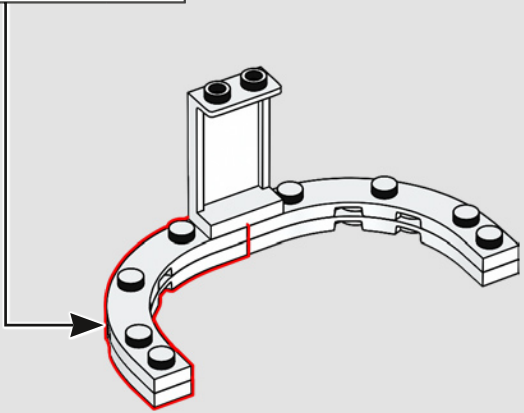
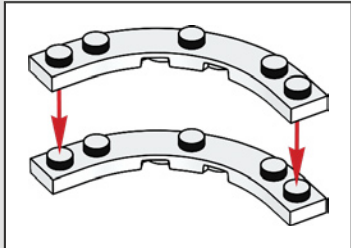



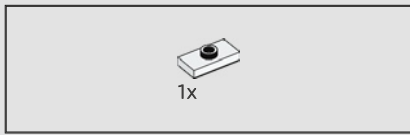

639

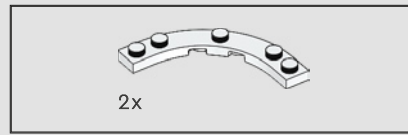
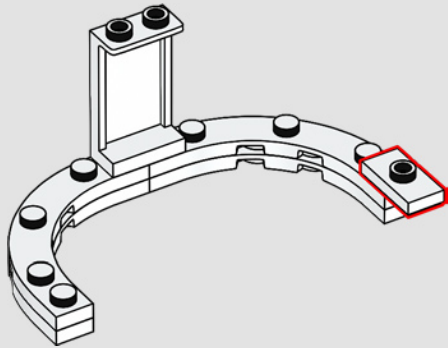

640

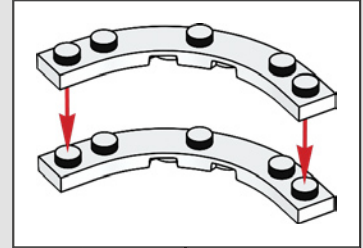
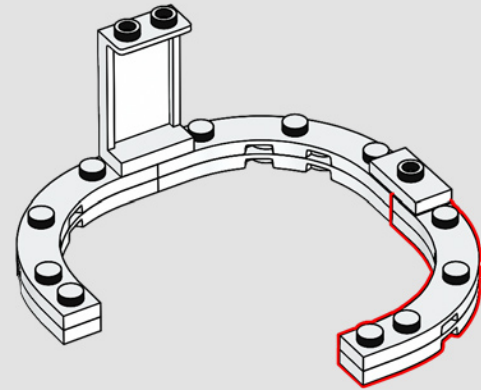

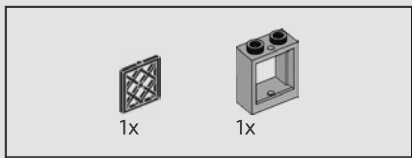

641

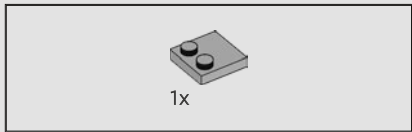
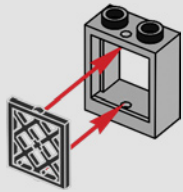

642

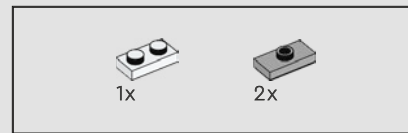
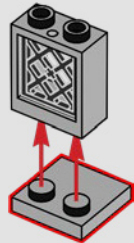

643

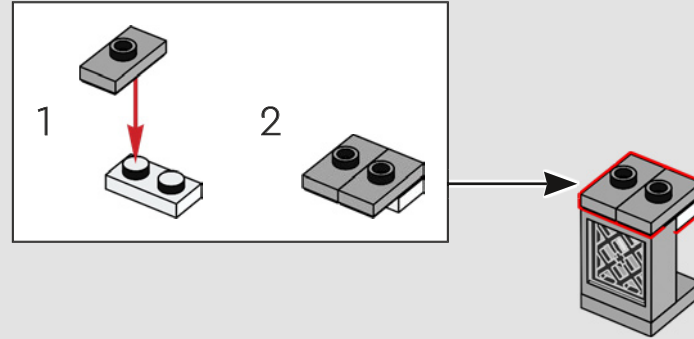

644

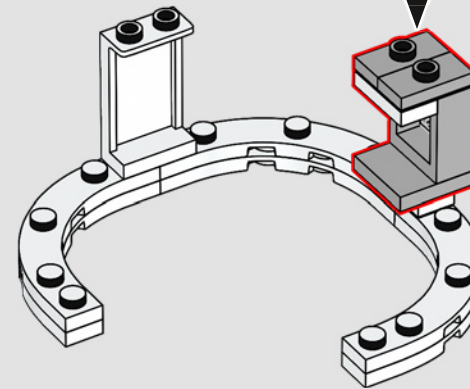

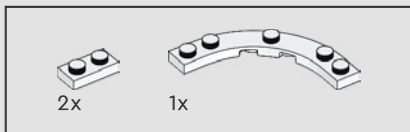

645

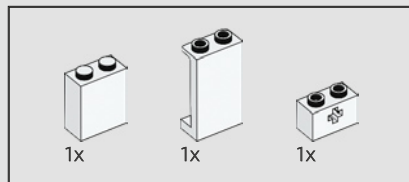
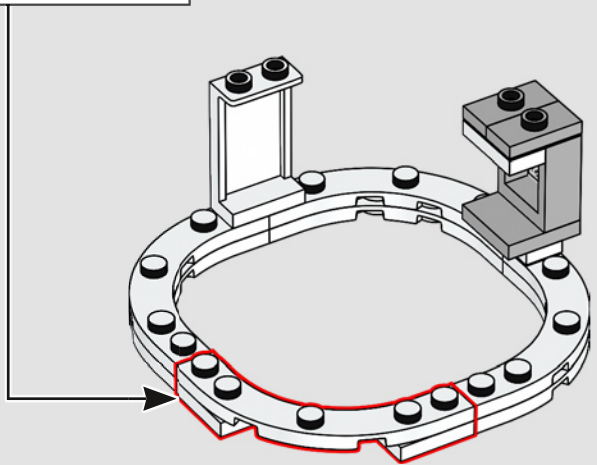
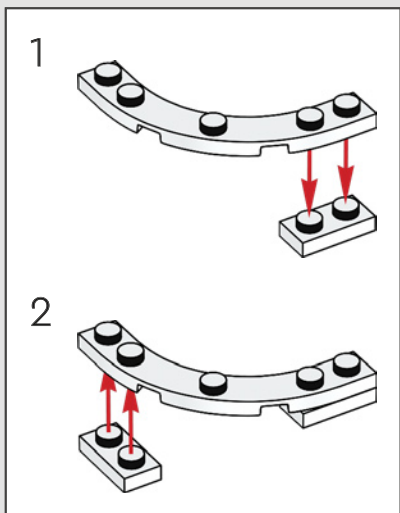

646

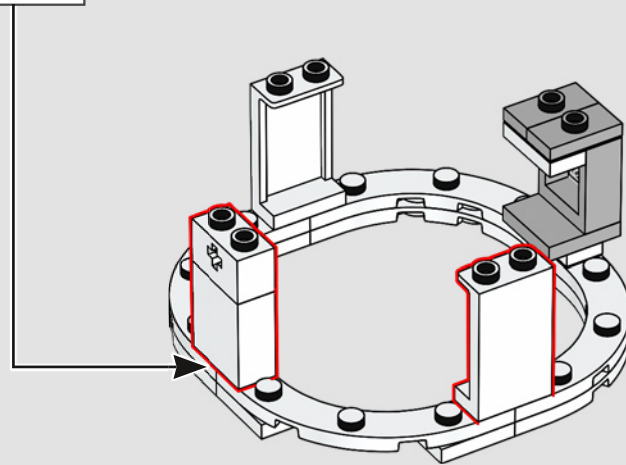
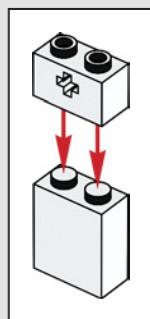

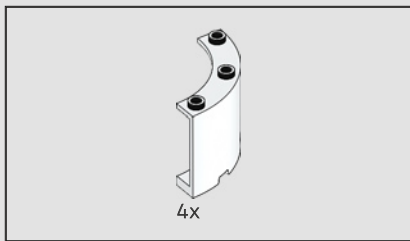

647

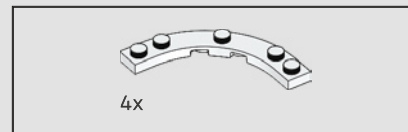
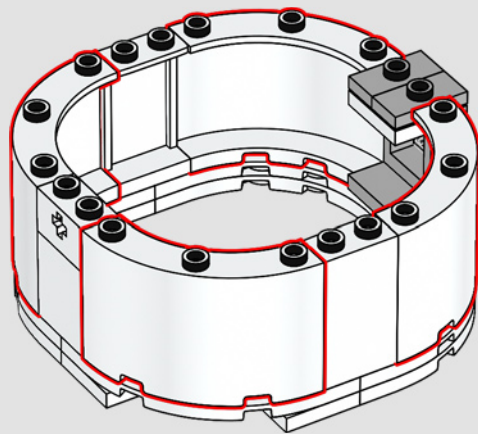

648

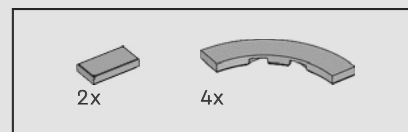
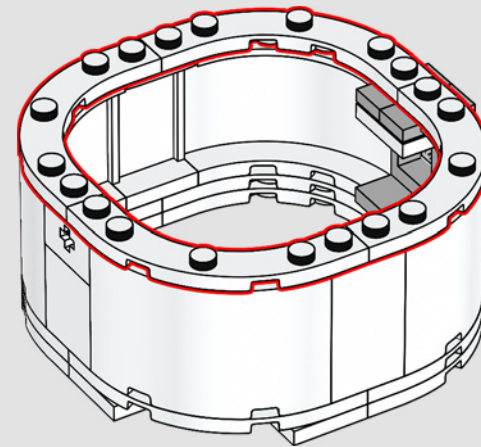

649

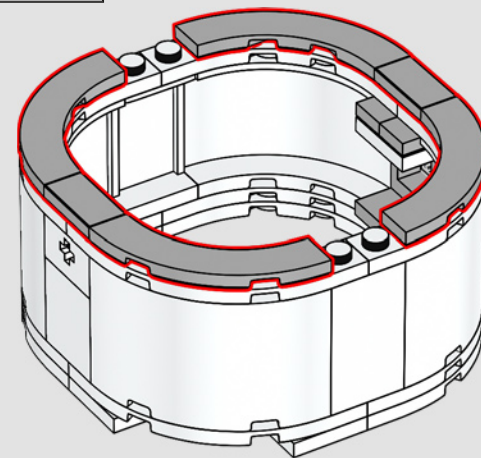

650

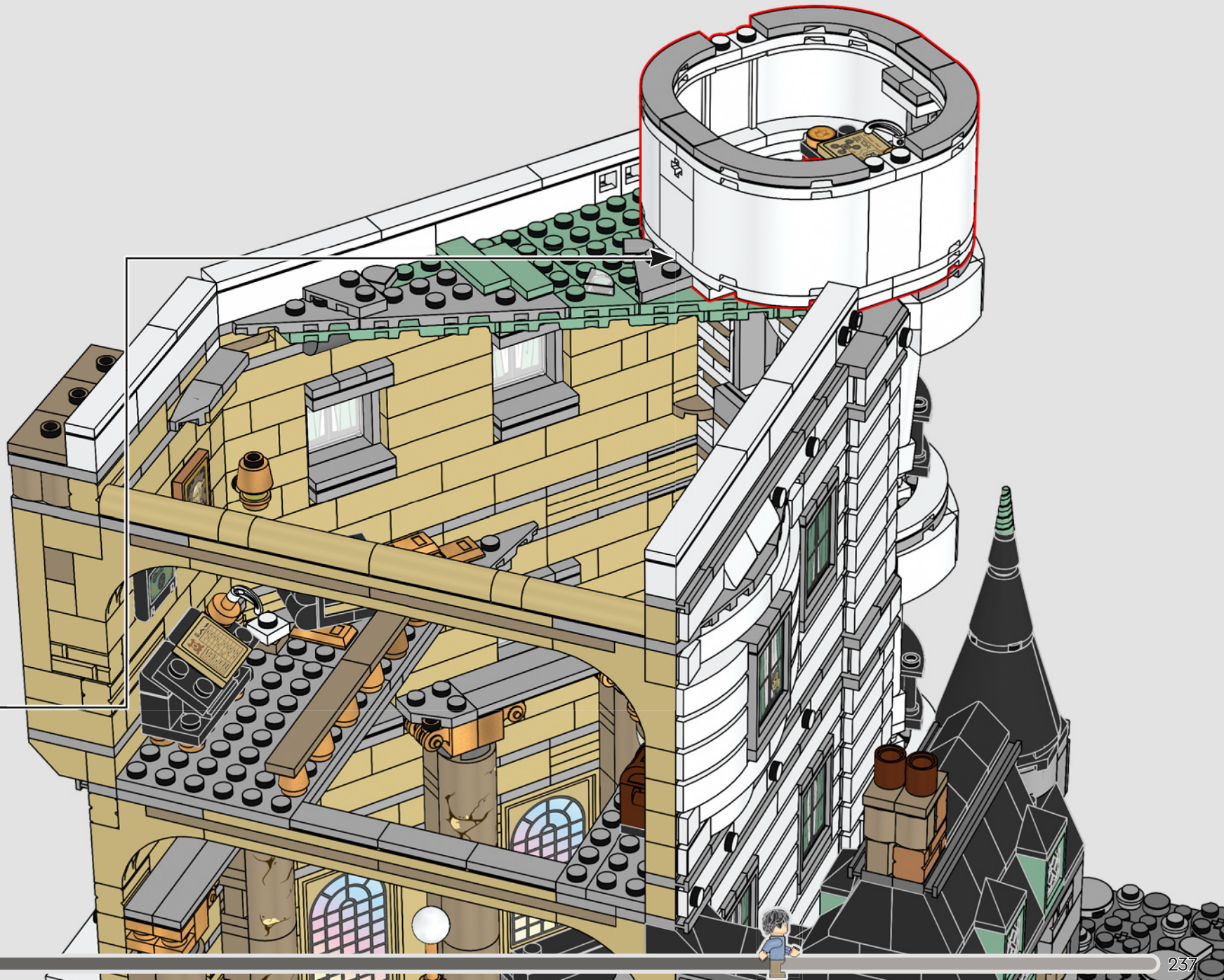

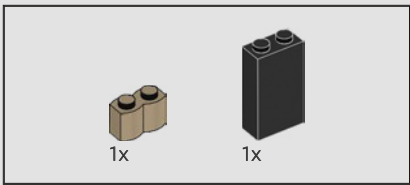

651

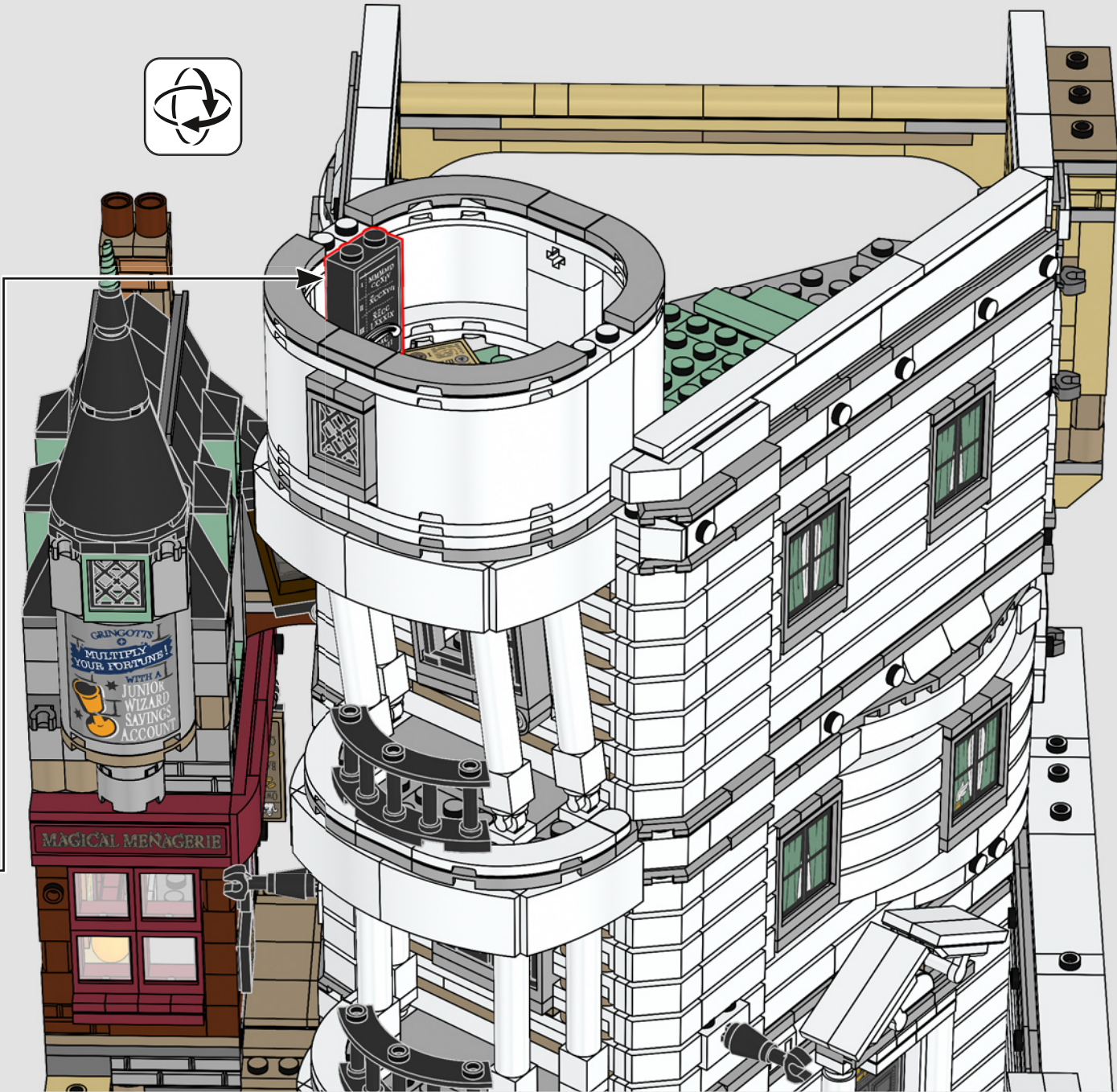
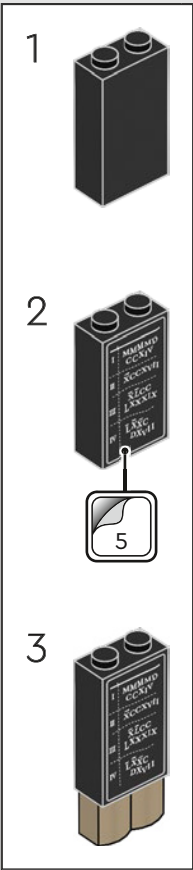

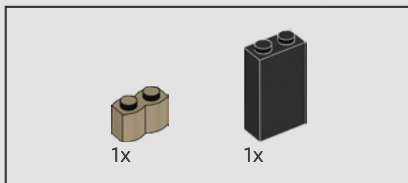

652

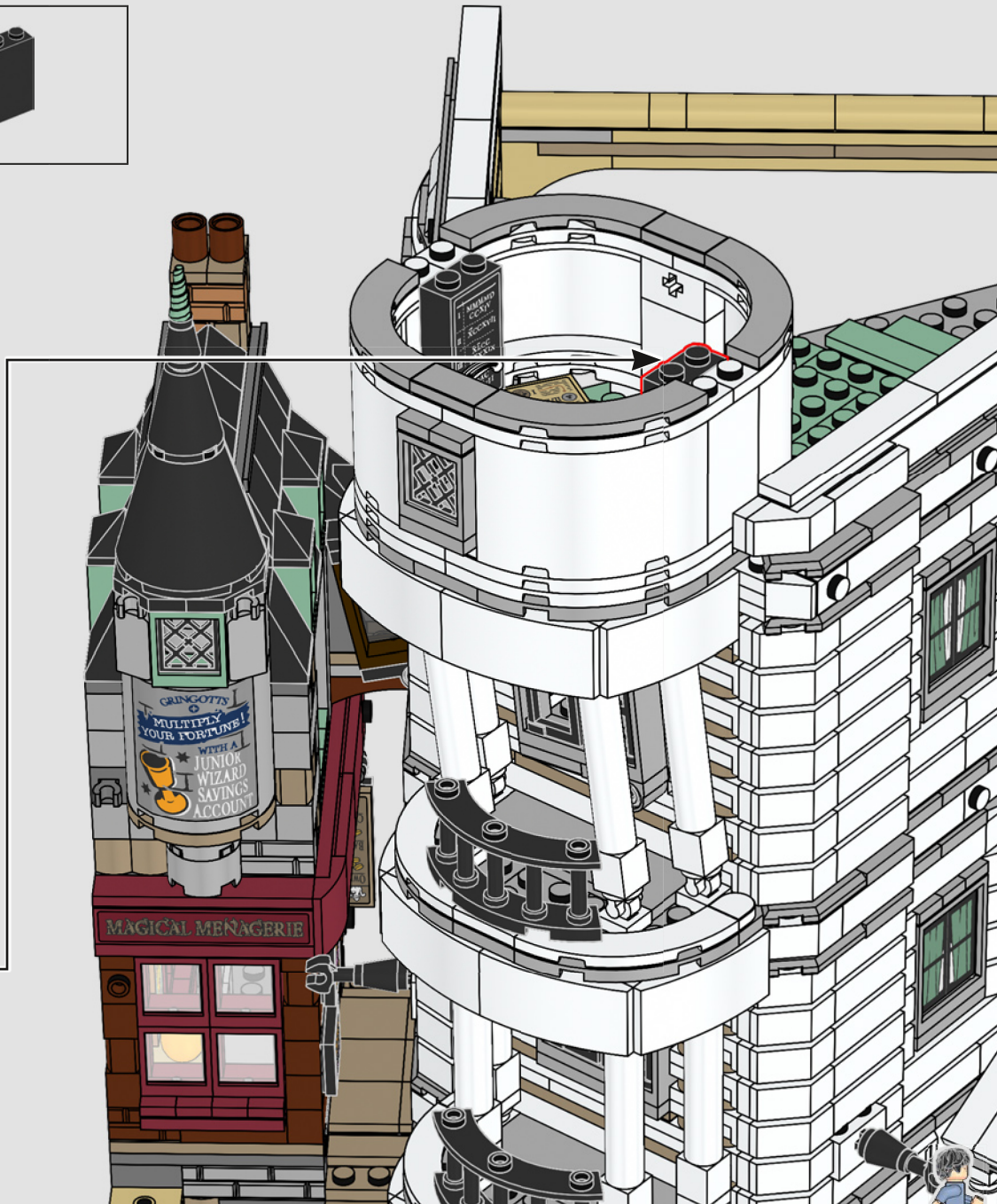
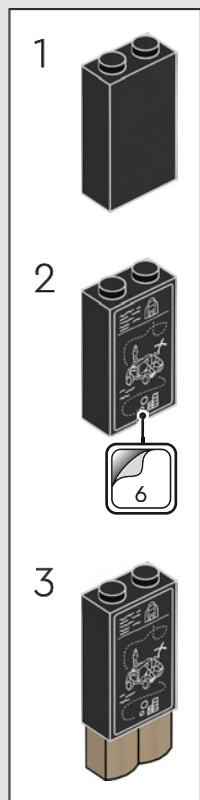

What have the Gringotts™ goblins been calculating on these chalkboards? You may need to travel deep into the LEGO® archives to find out...

Qu'est-ce que les gobelins de Gringotts™ ont calculé sur ces tableaux noirs ? Vous devrez peut-être voyager au plus profond des archives LEGO® pour le découvrir...

¿Qué han estado calculando los duendes de Gringotts™ en estos pizarrones? Quizá tenga que viajar a lo más profundo de los archivos de LEGO® para averiguarlo...



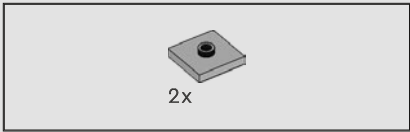

653

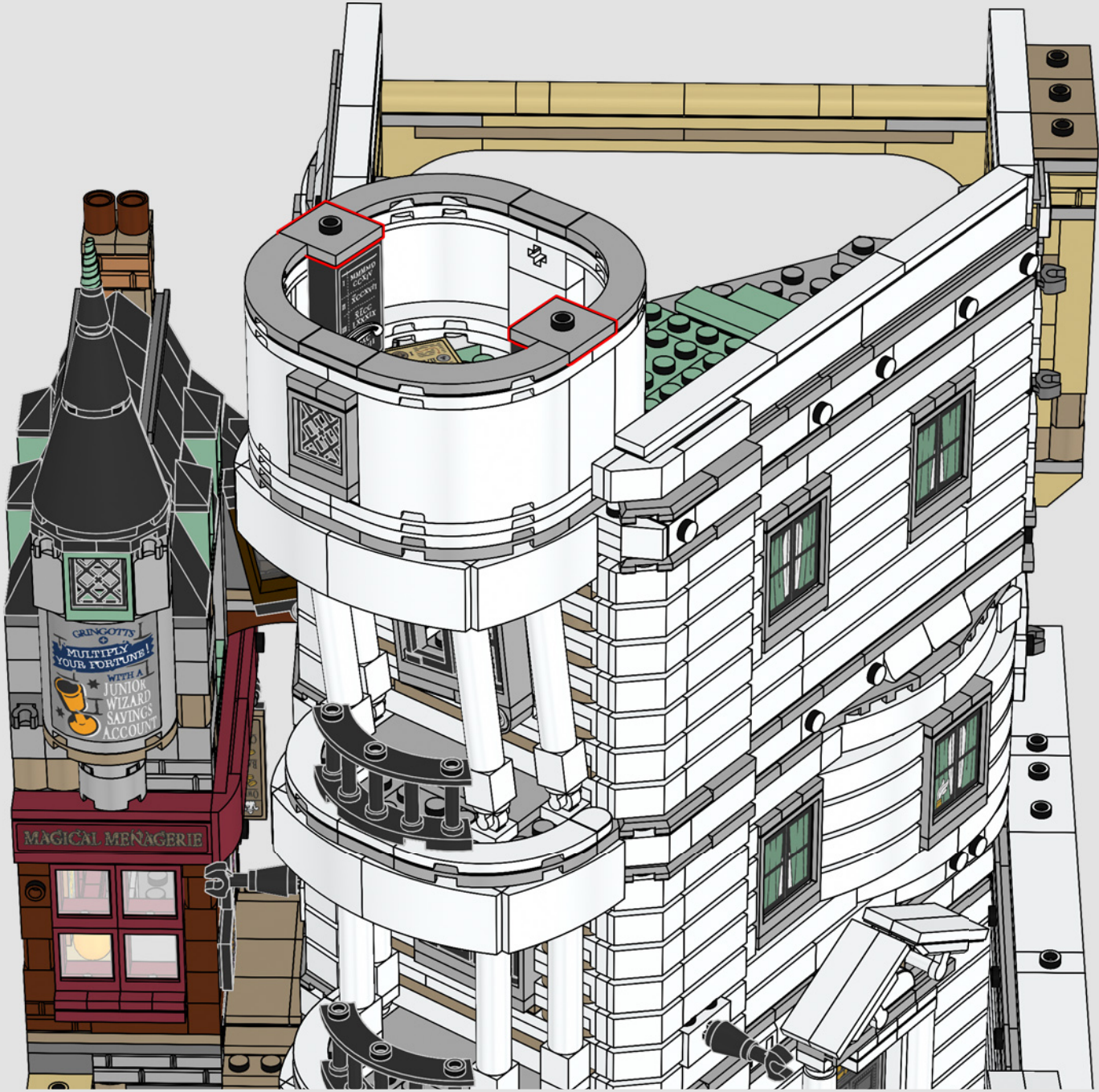



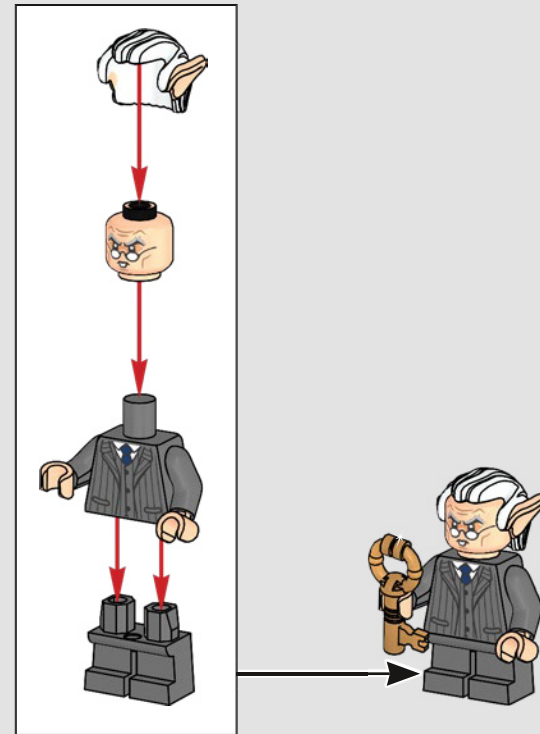

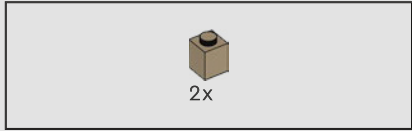
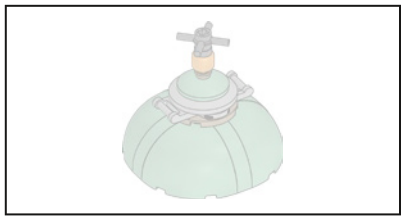

654



655

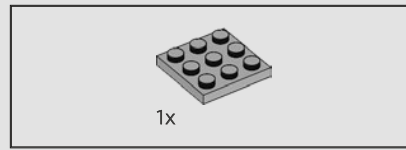

656

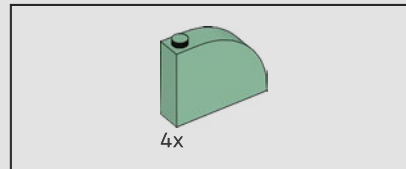
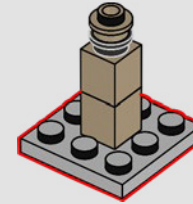

657

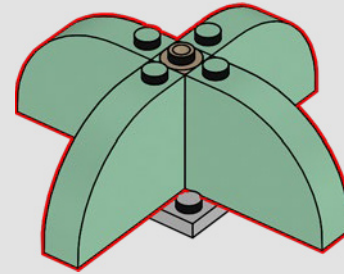

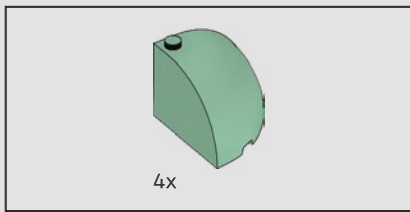

658

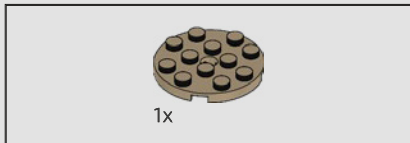
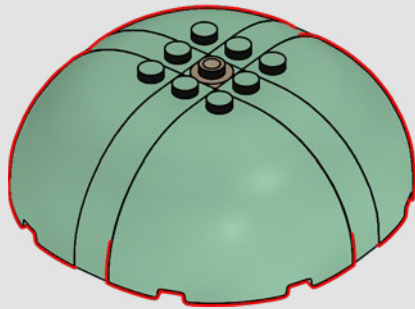

659

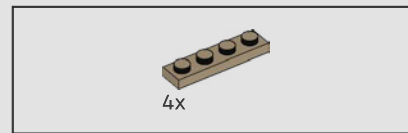
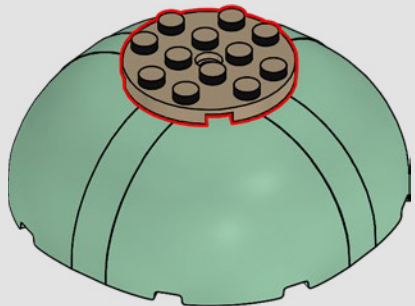

660

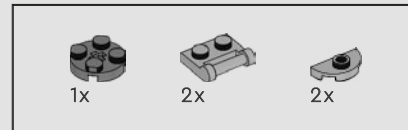
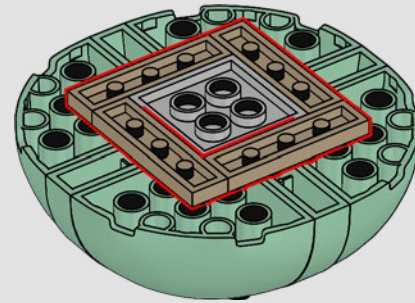

661

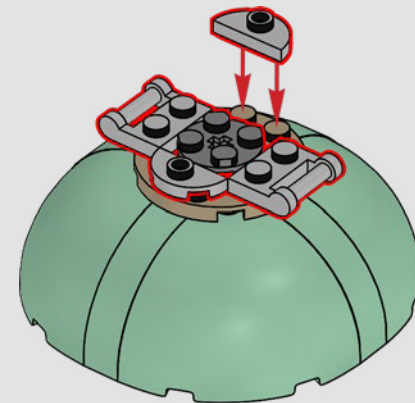

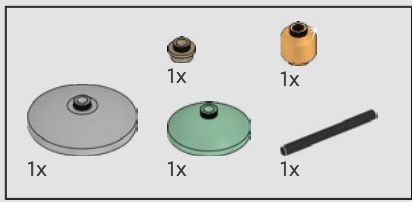

662

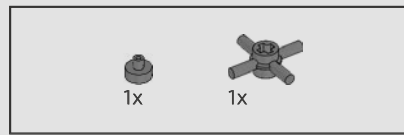
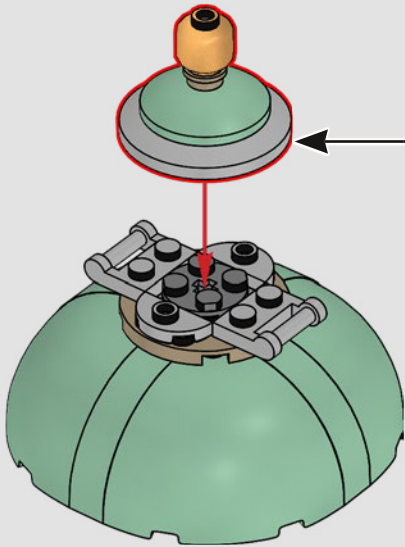
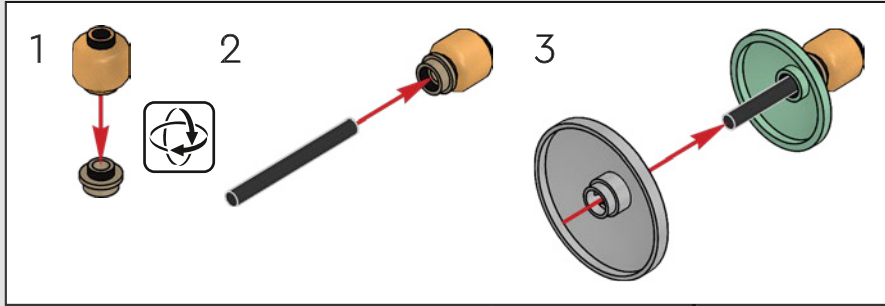

663

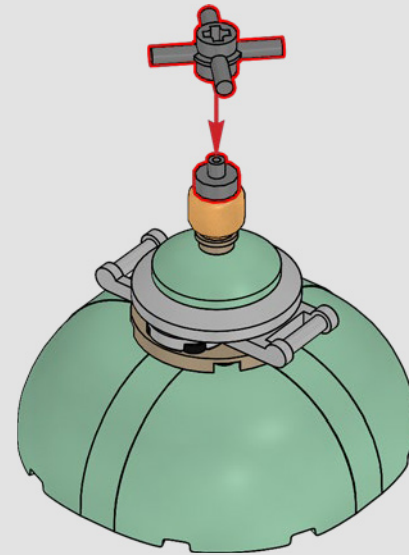

664





665

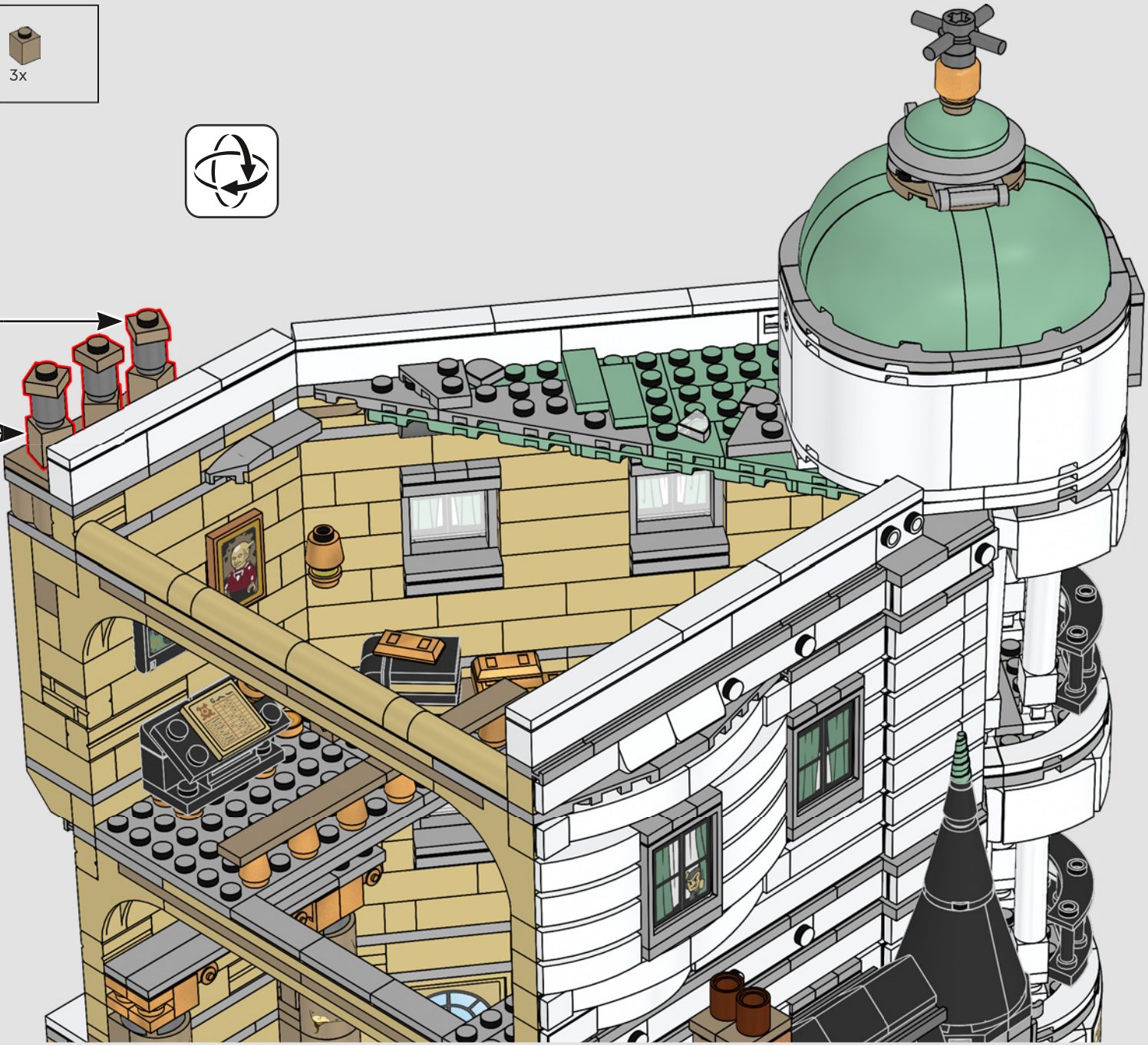
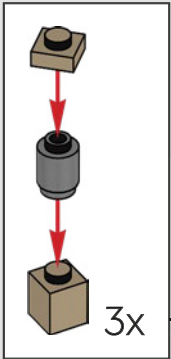

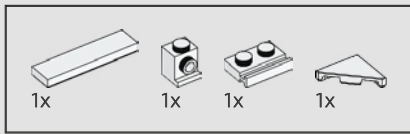

666

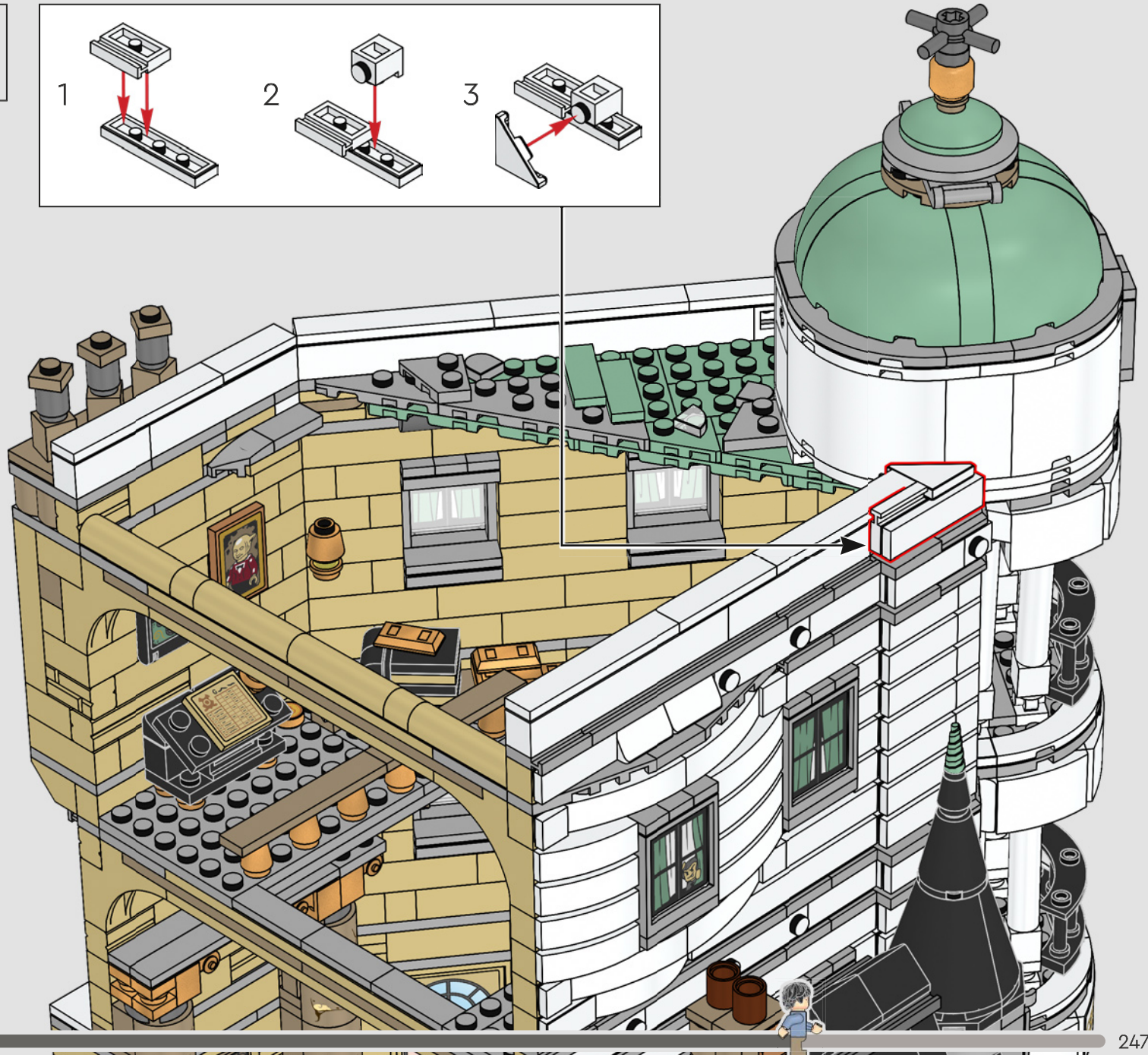
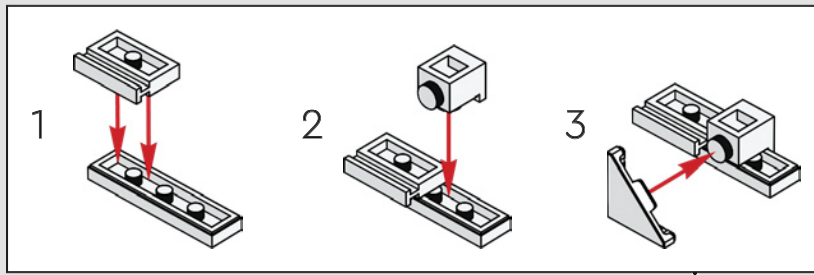

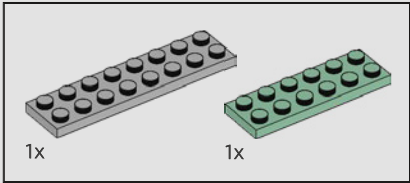
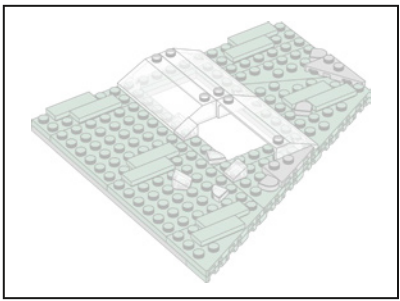

667

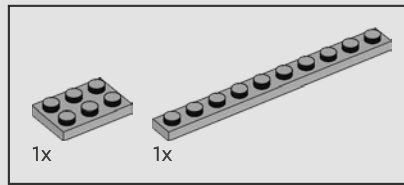
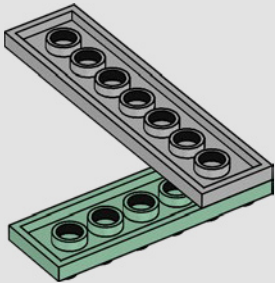

668

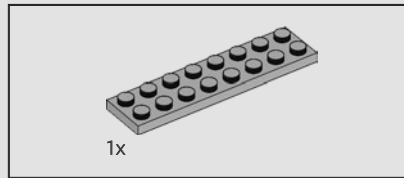
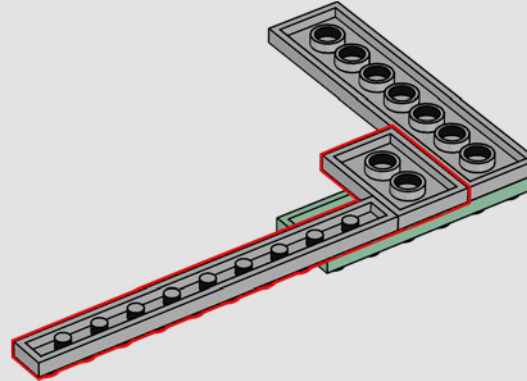

669

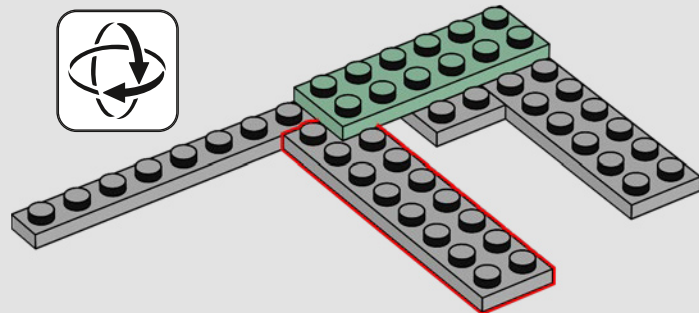



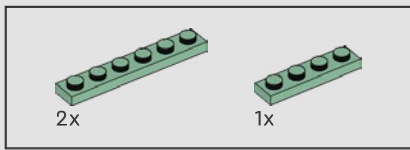

670

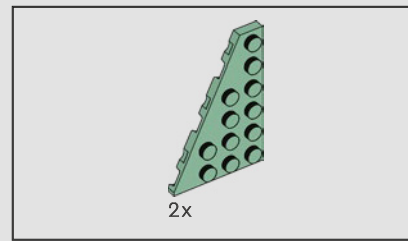
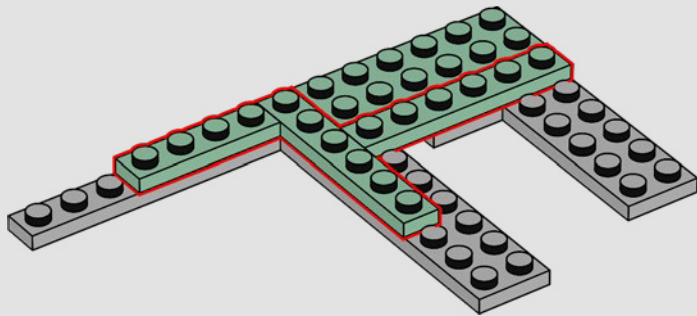

671

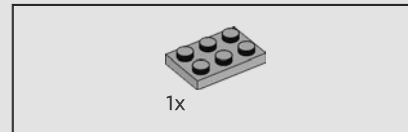
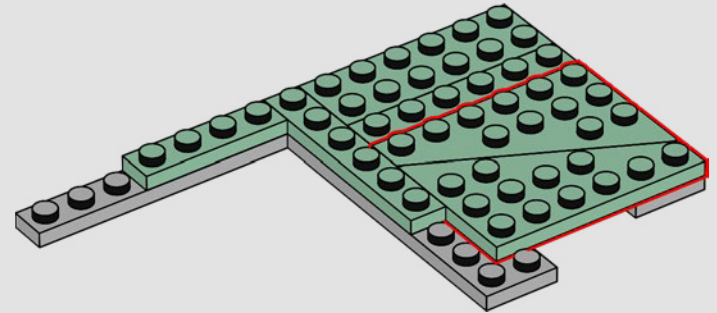

672

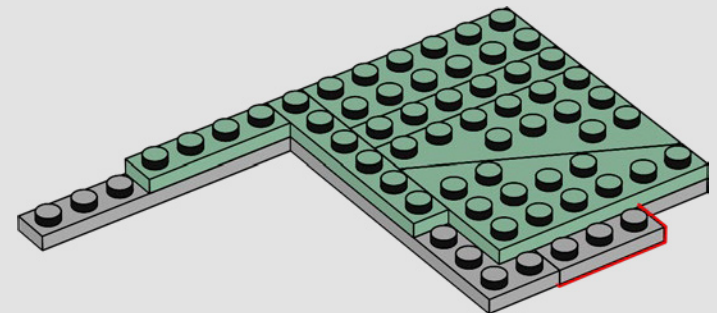

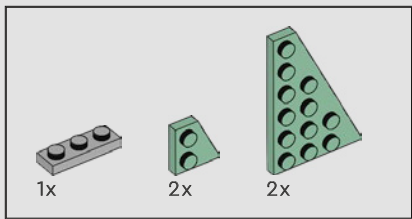

673

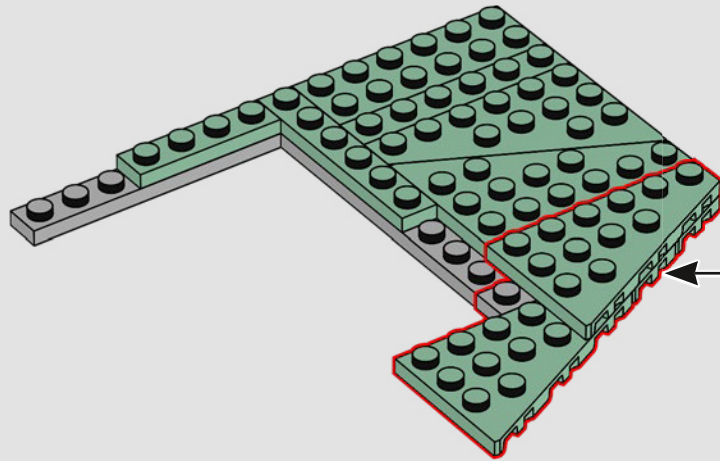
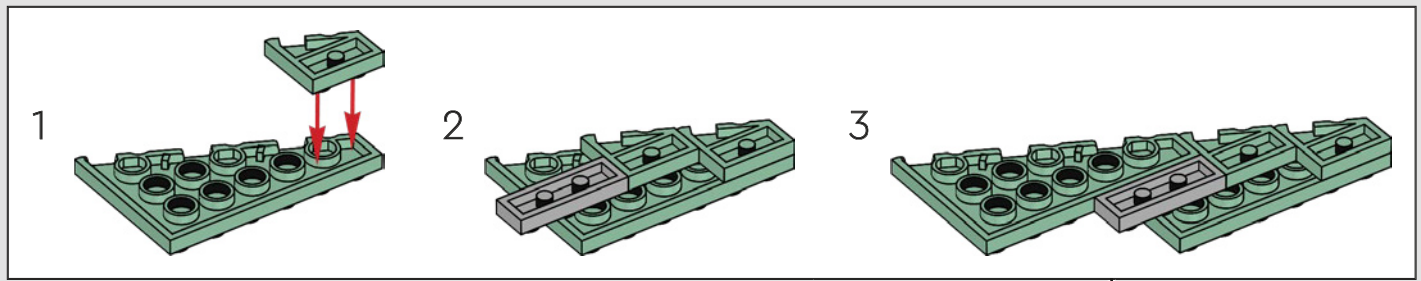

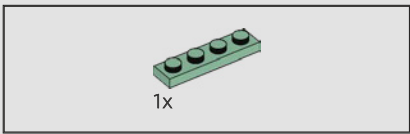

674

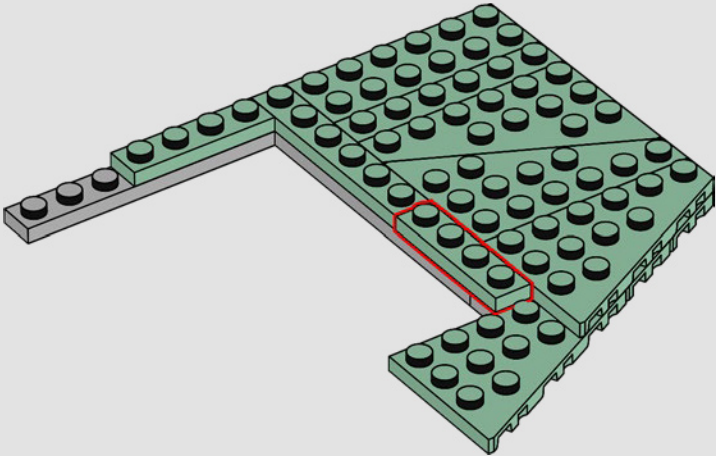

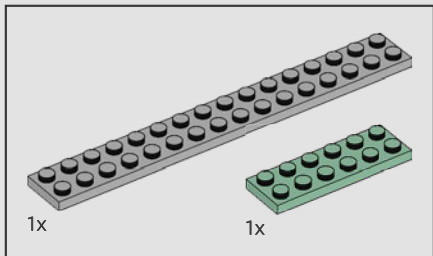
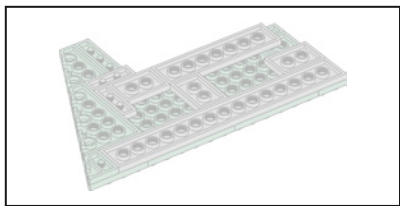

675

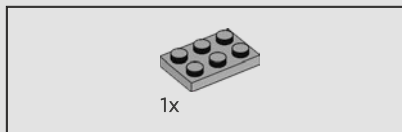
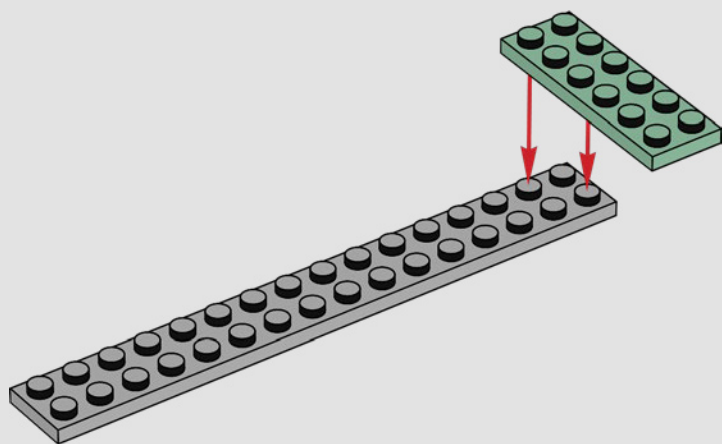

676

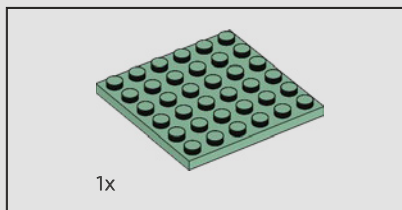
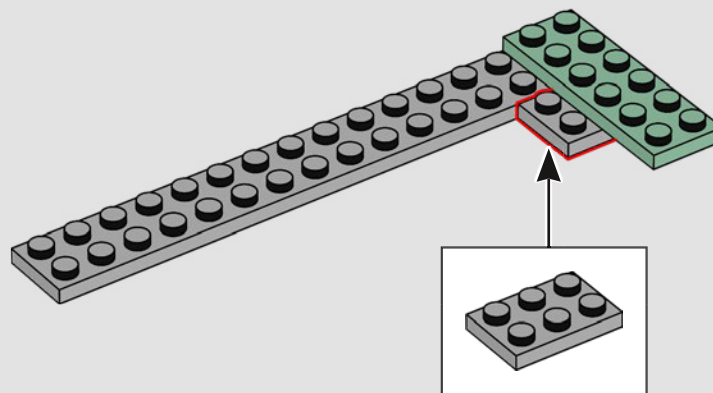

677

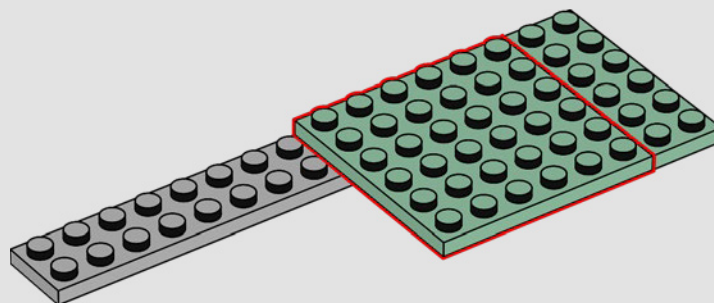

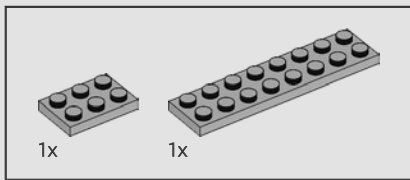

678

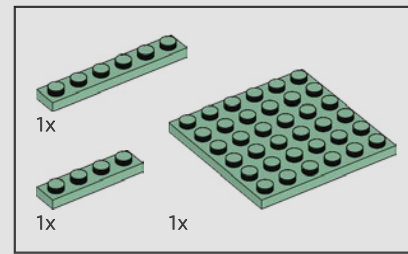
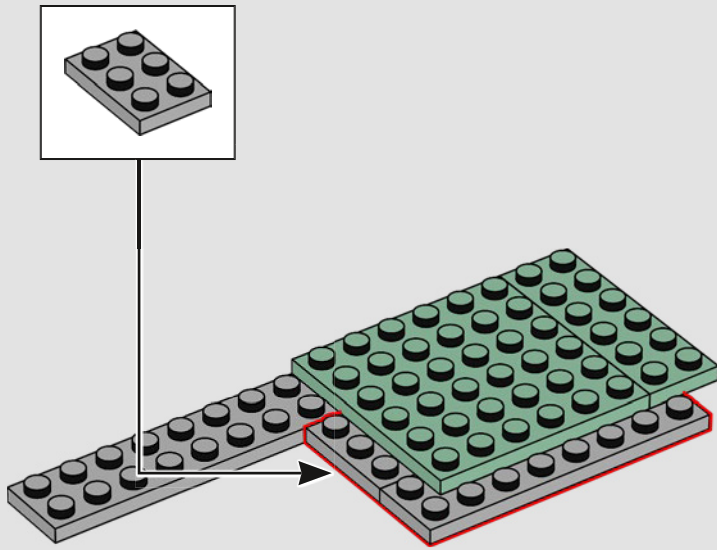

679

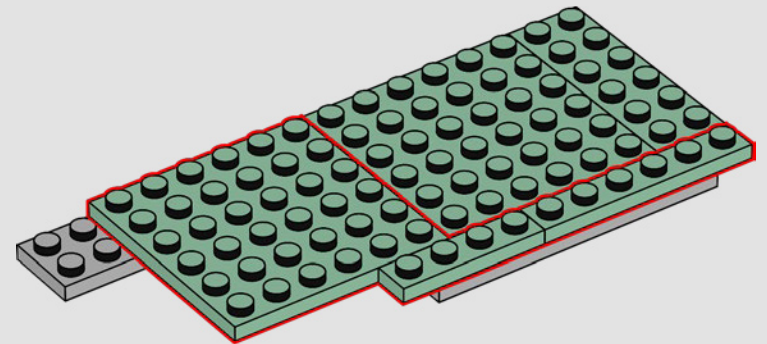

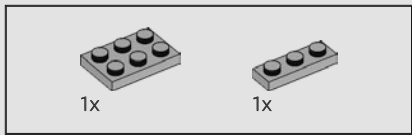

680

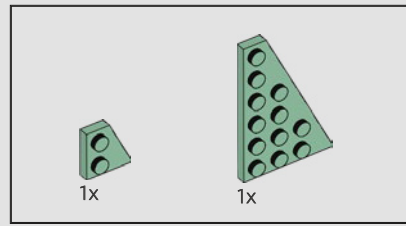
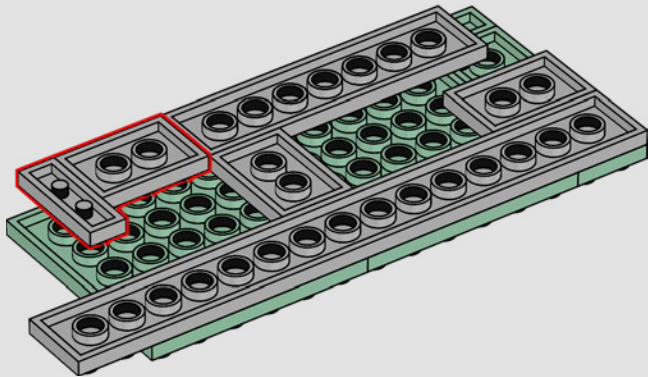

681

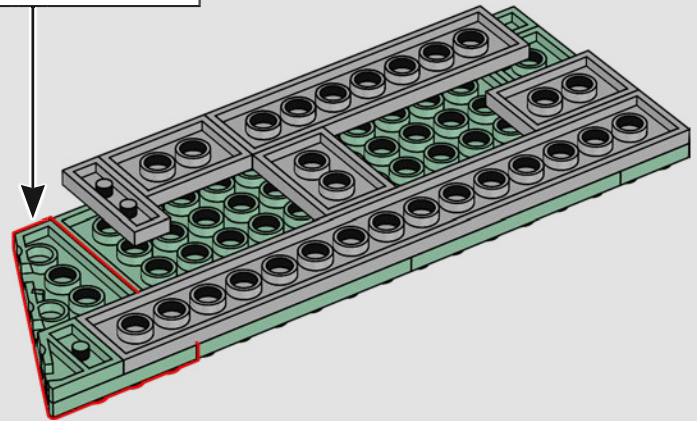
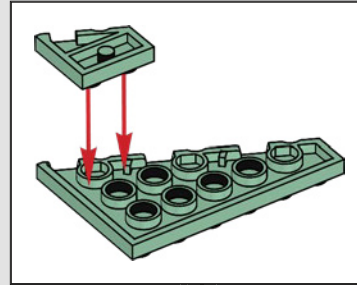

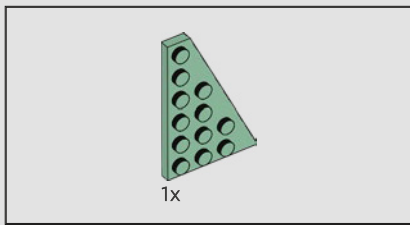

682

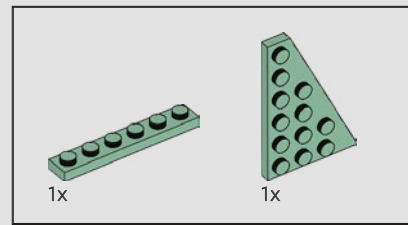
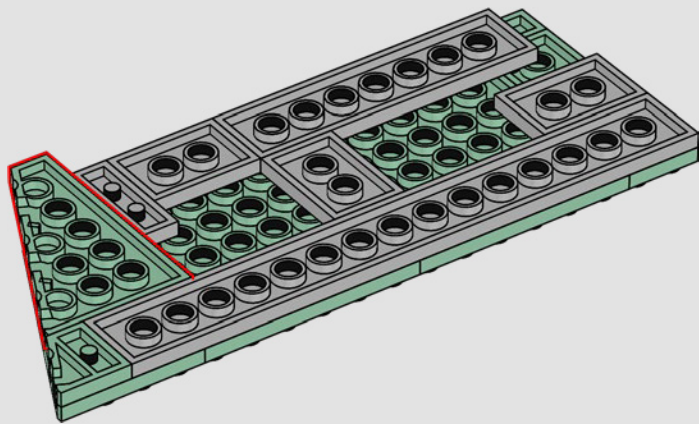

683

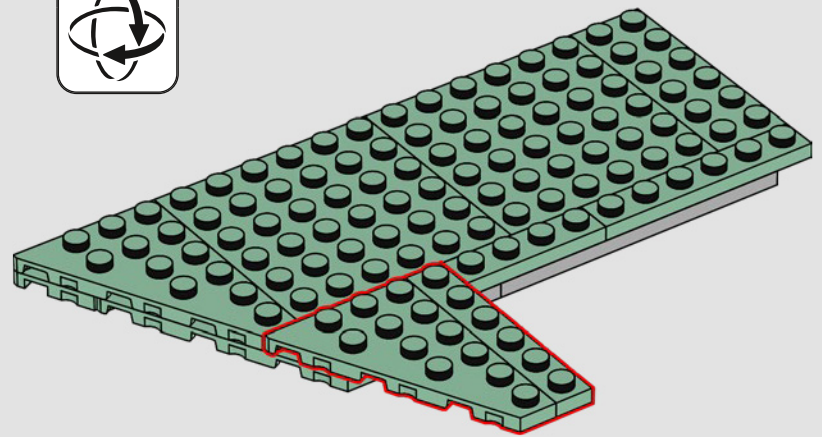

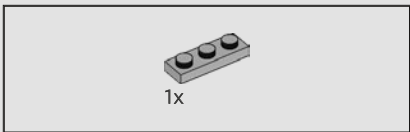

684

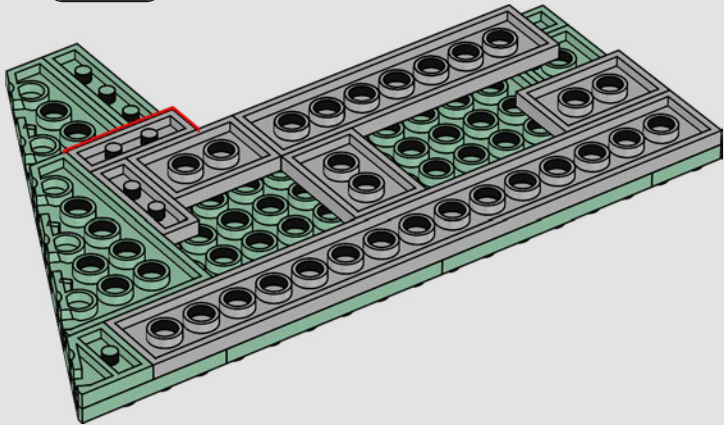

685

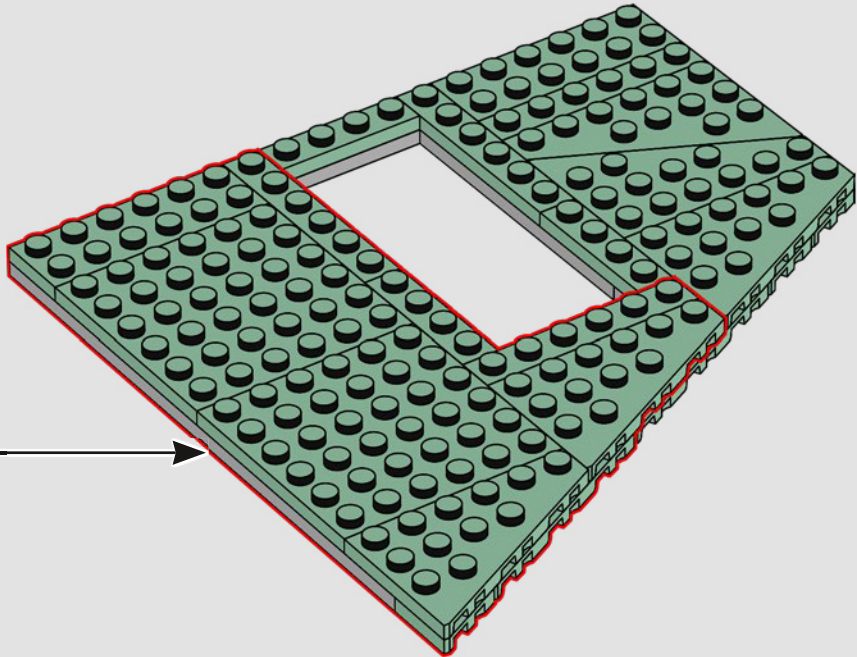



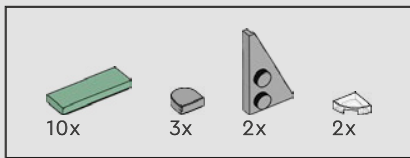

686

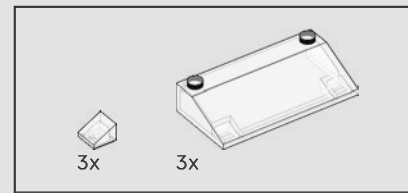
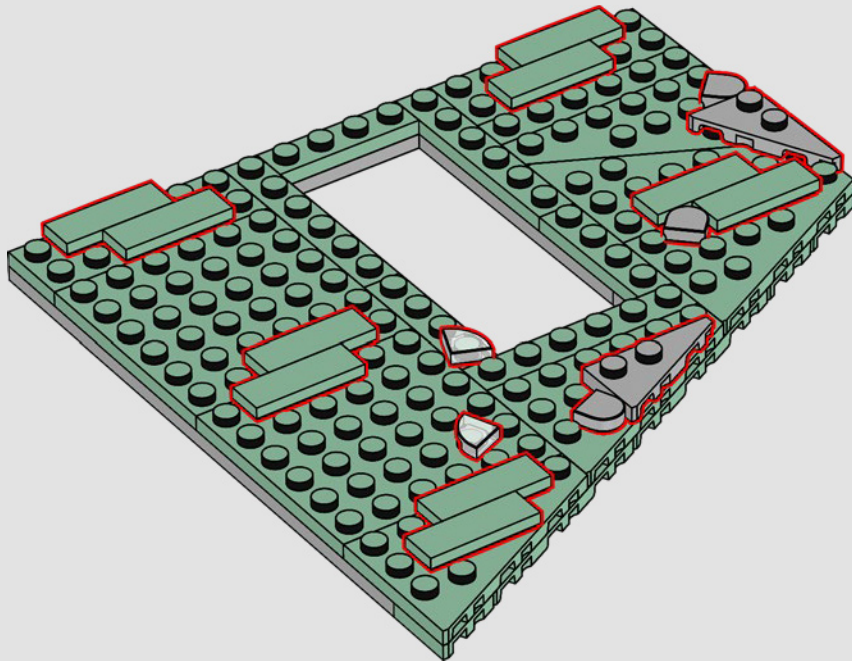

687

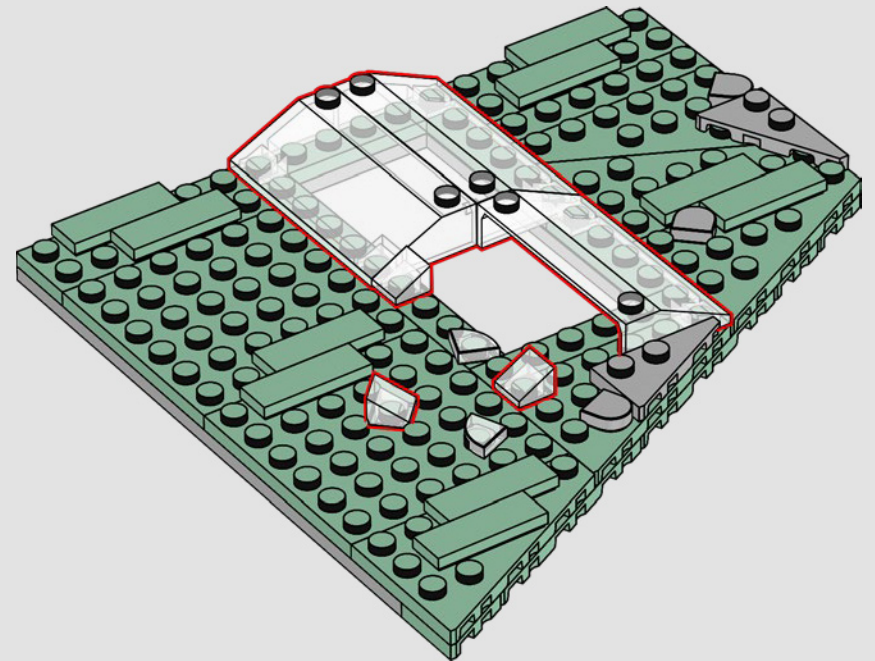



2x

688

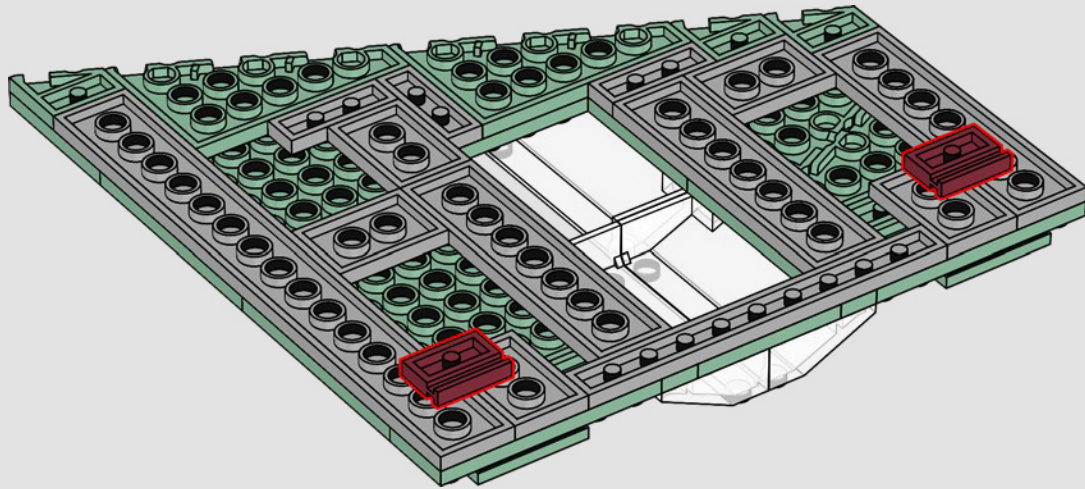

689

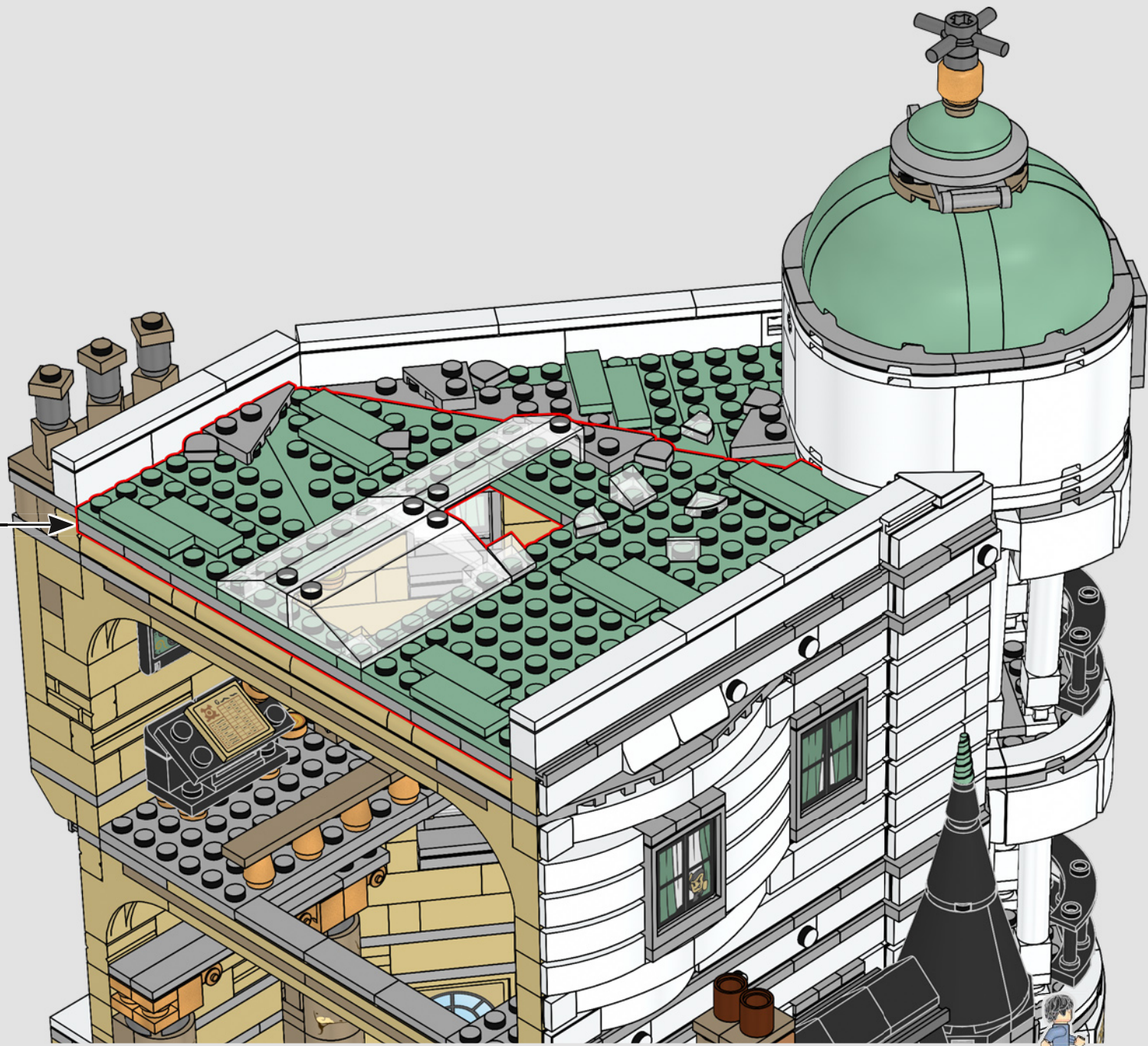



690

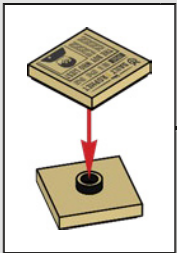
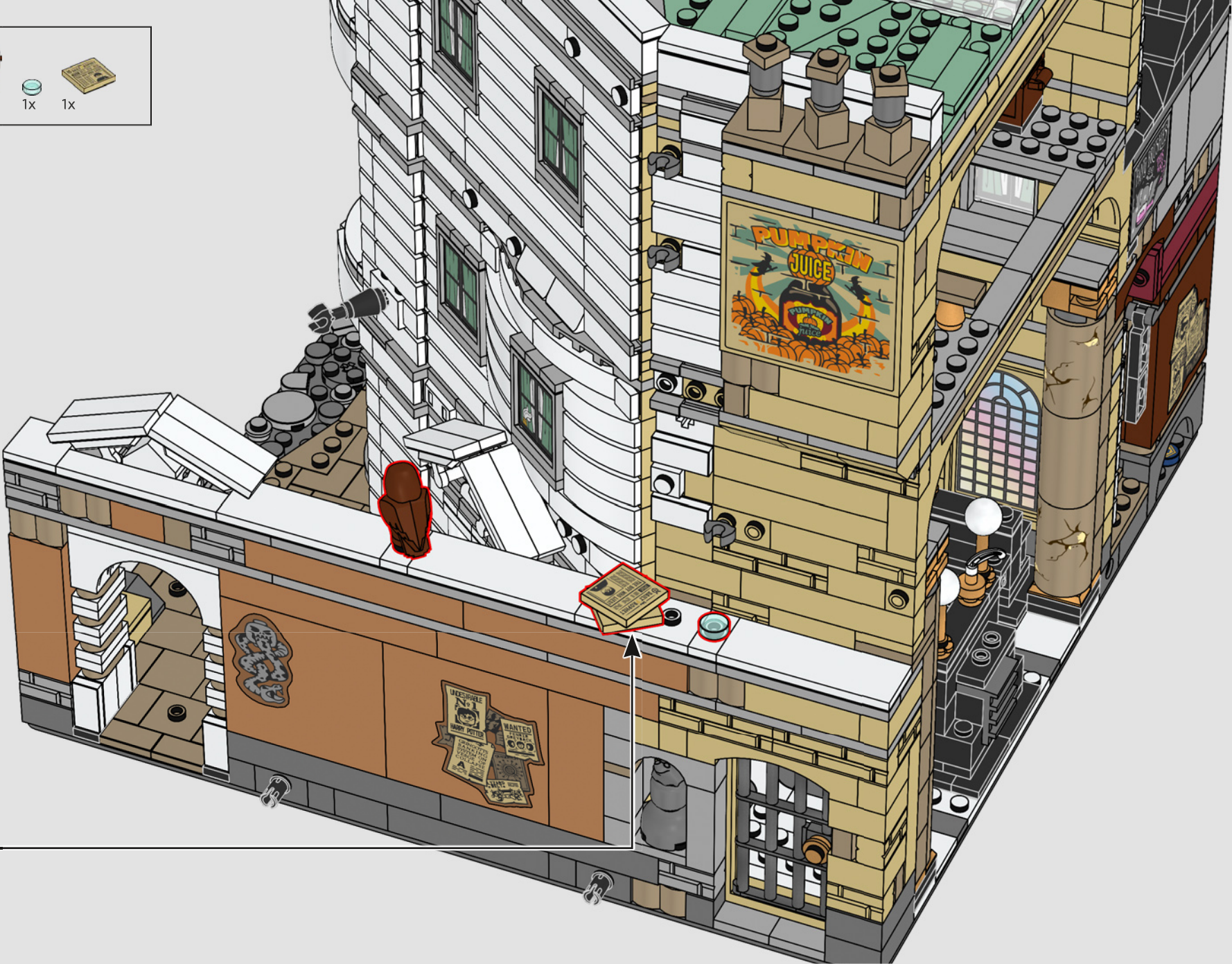

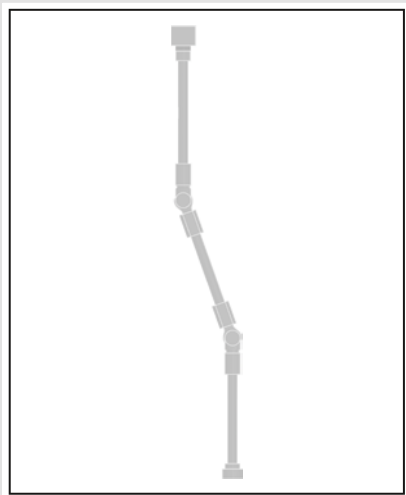

691

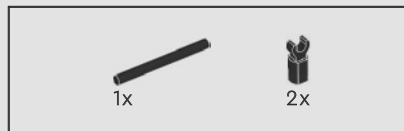
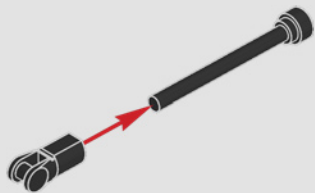

692

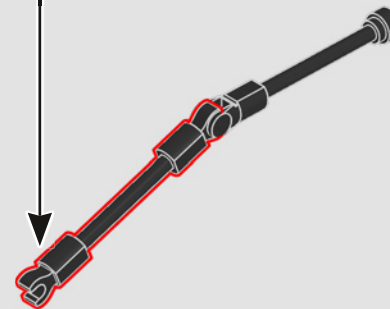
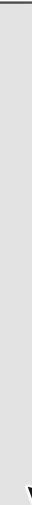
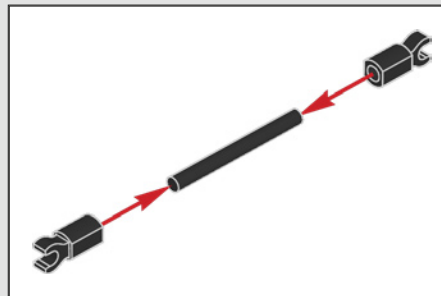



693

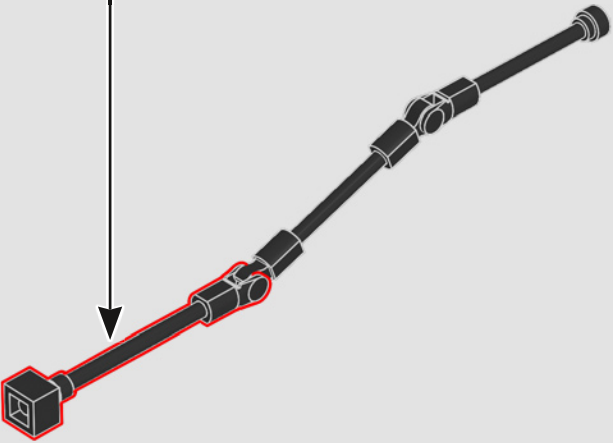
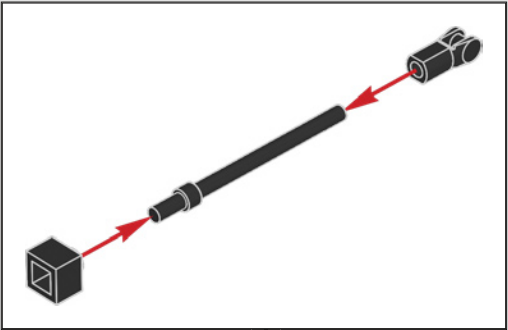

694



695

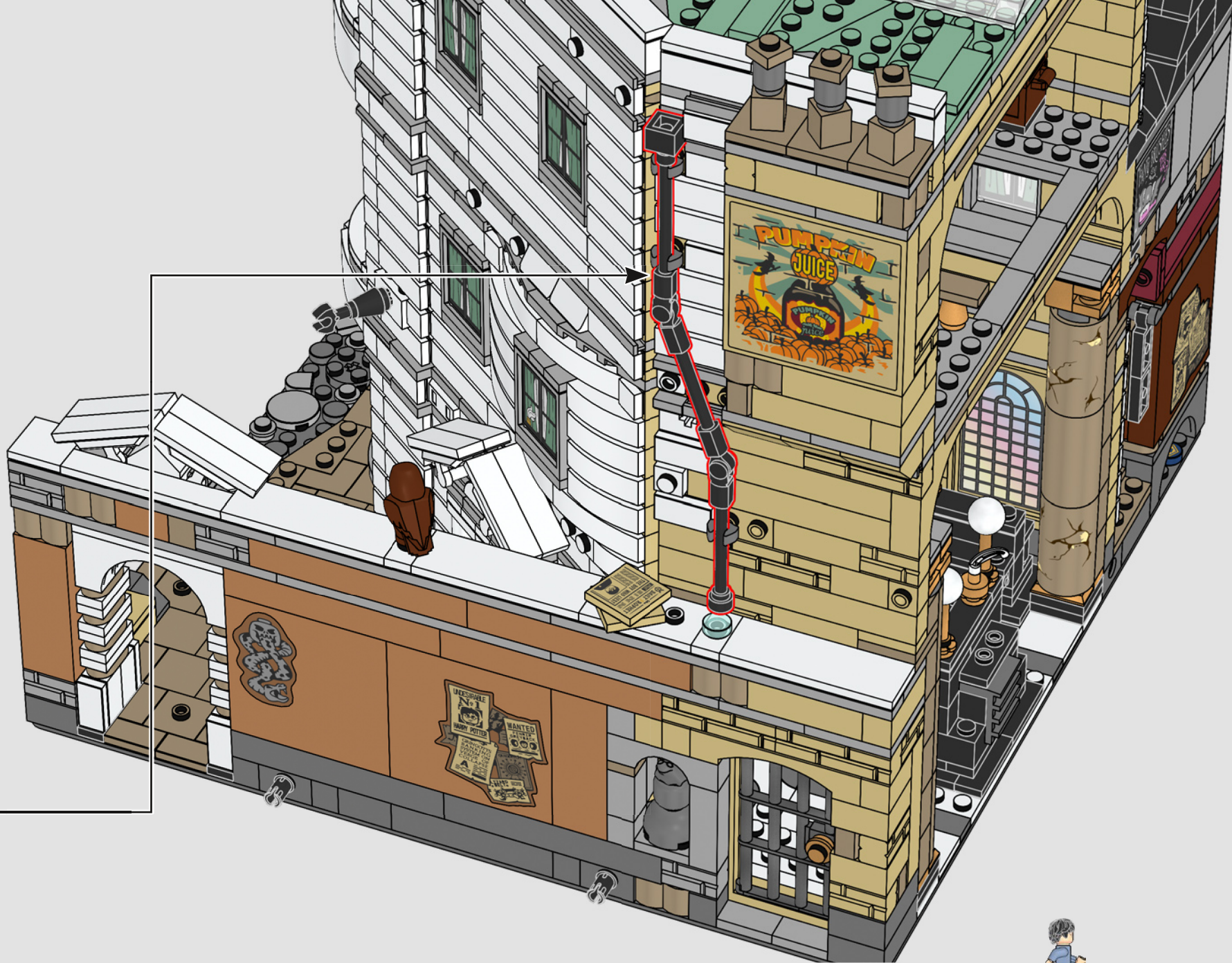

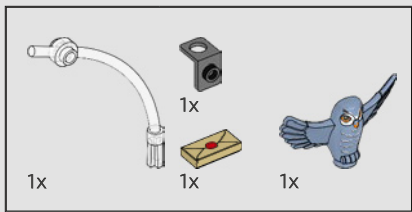

696

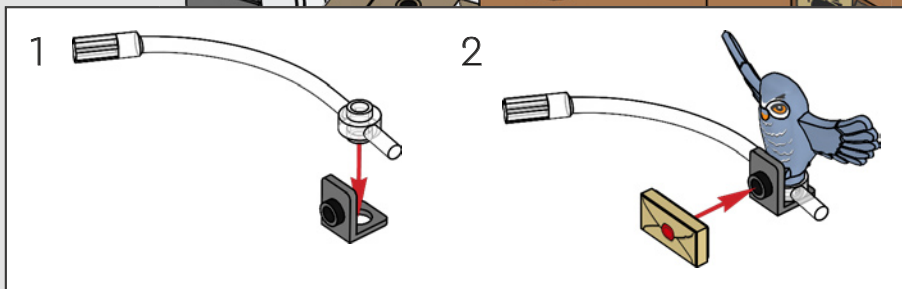
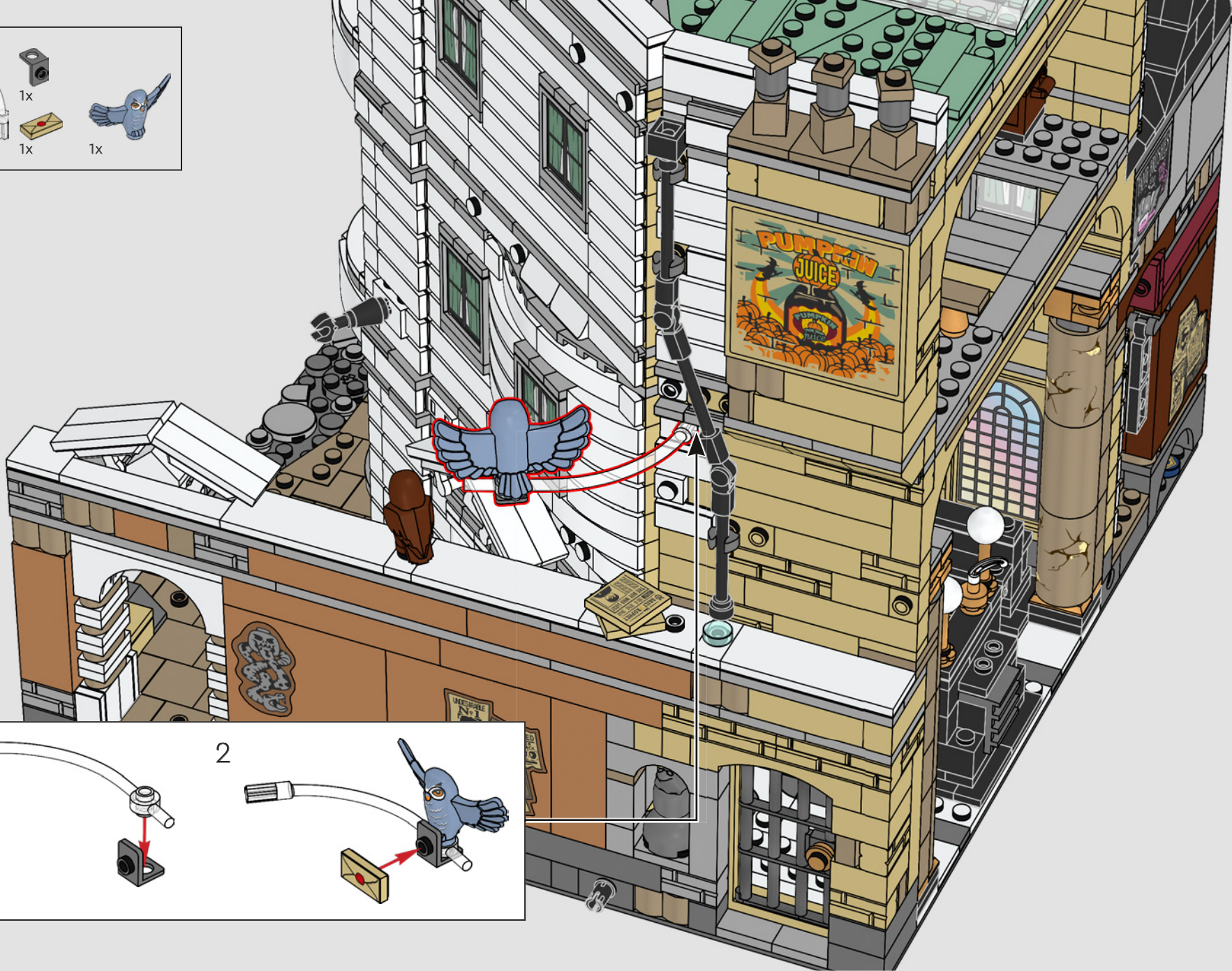



- 2x
- 1x
- 1x
- 2x
- 2x

697

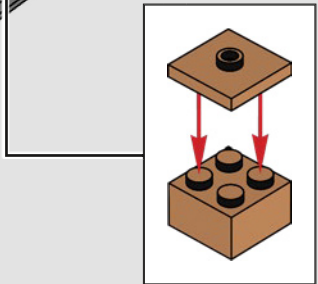
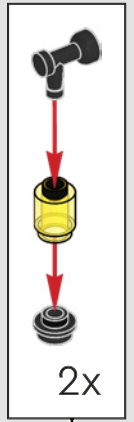

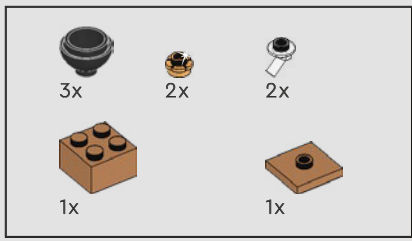

698

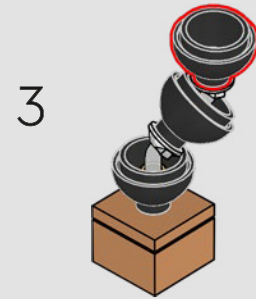
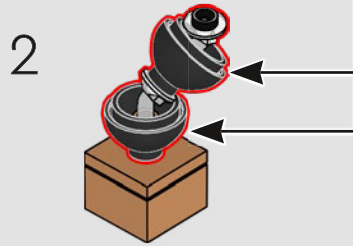
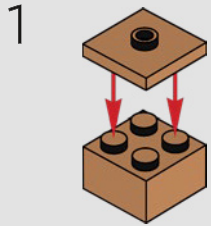
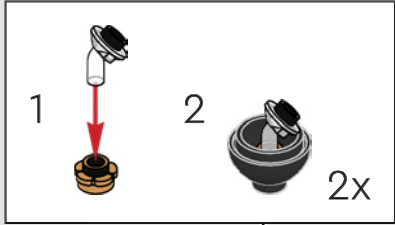



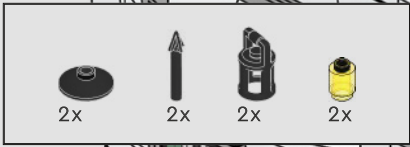

699

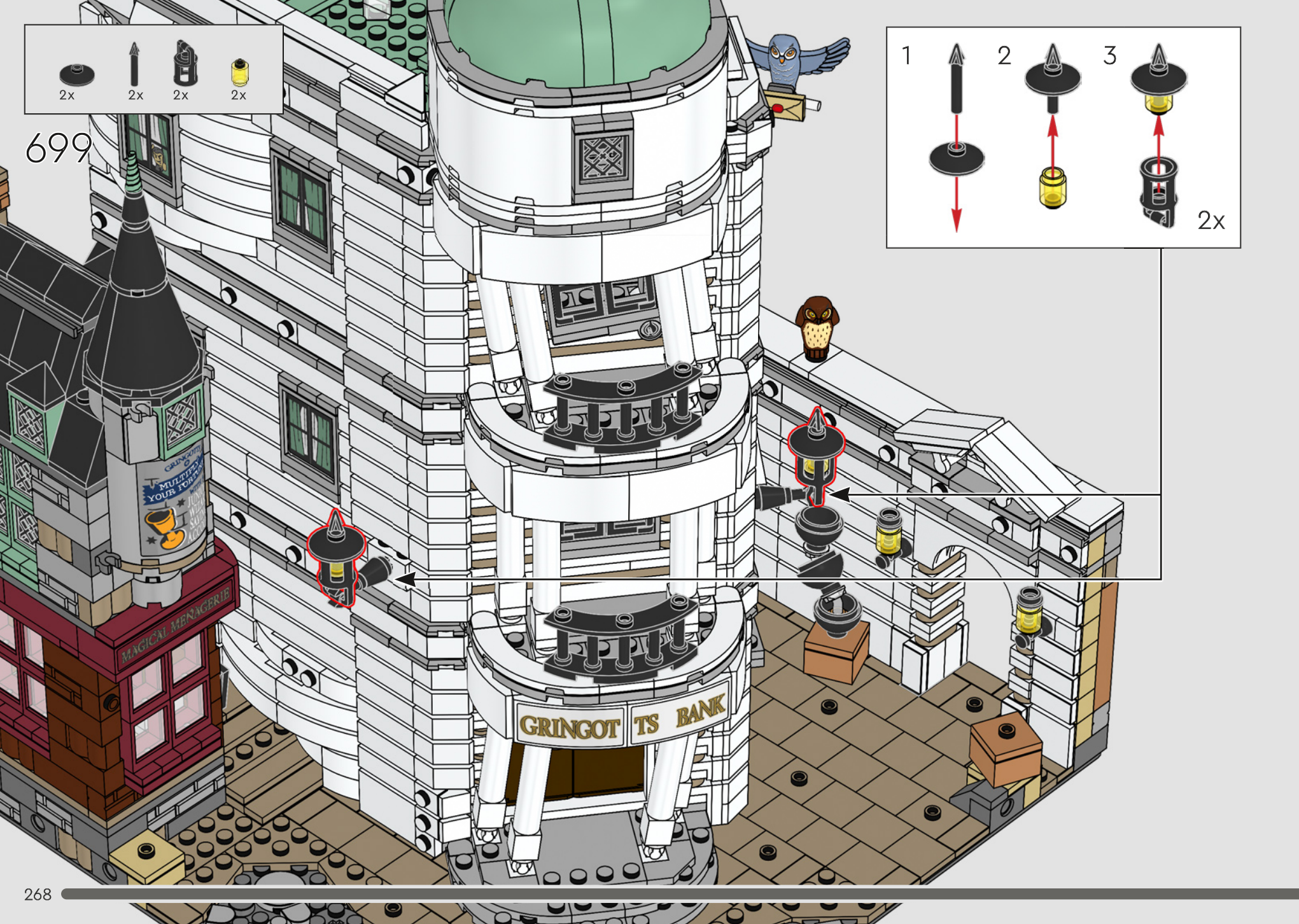
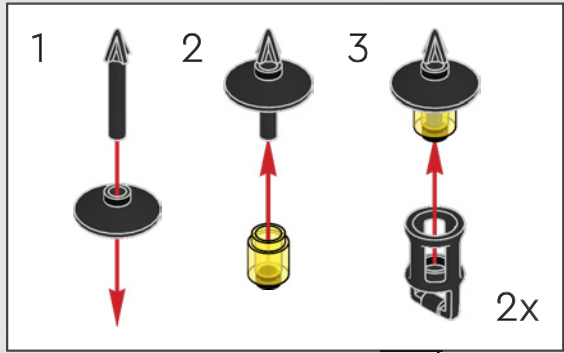



700

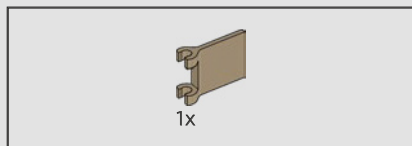

701

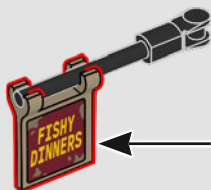
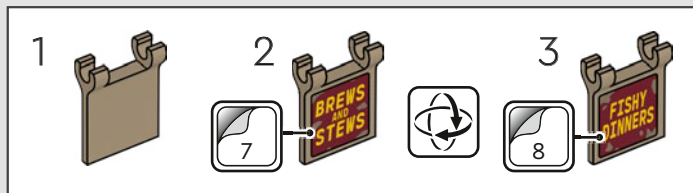

702

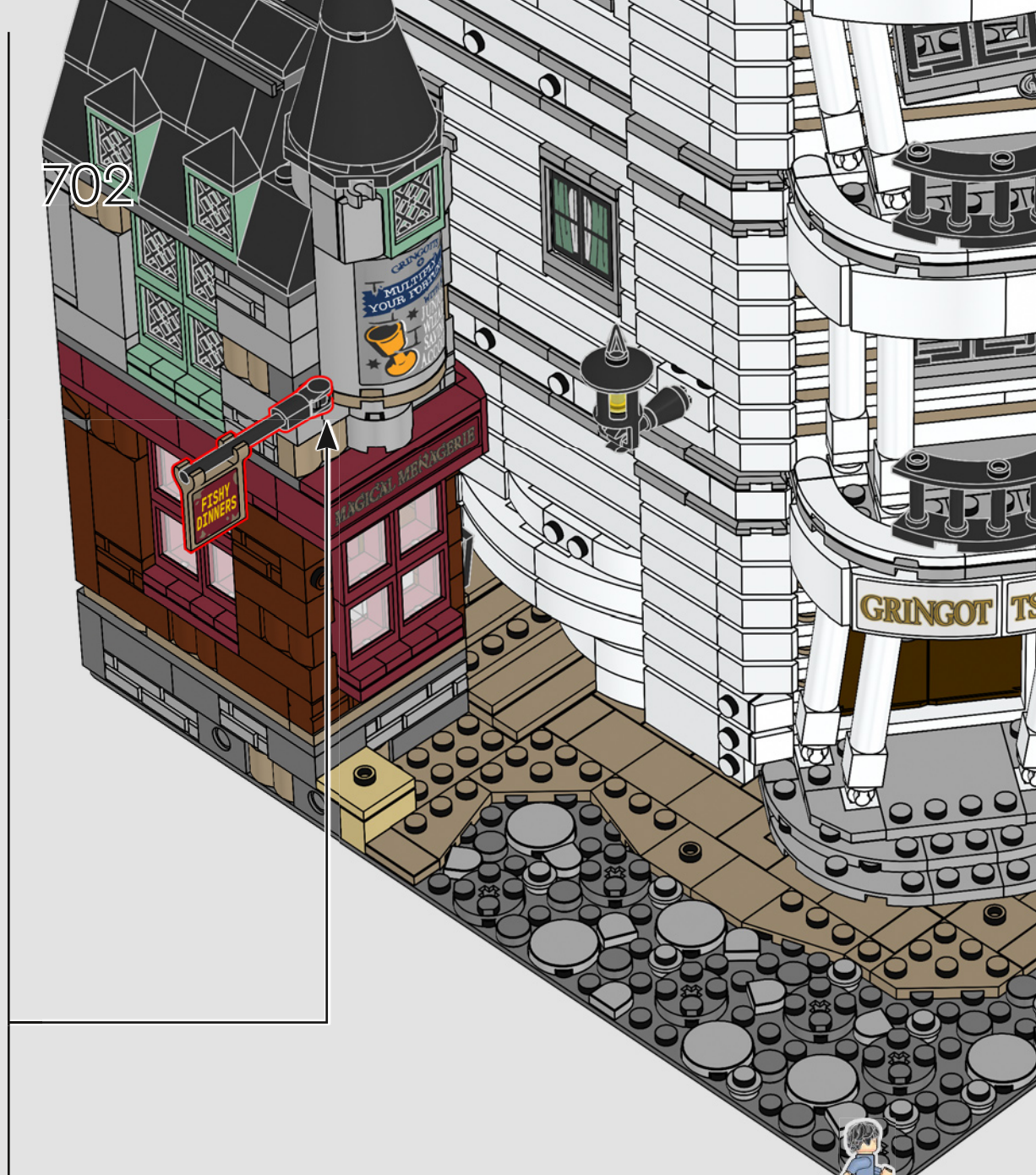



- 1x 
- 1x 
- 1x 

704

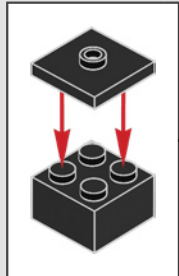

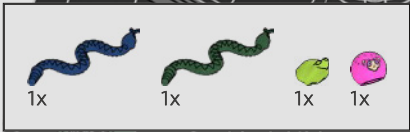

705







When placed on top of the caverns, this baseplate is 13 in. (33 cm) off the ground! This is not the first time a LEGO® baseplate has been raised (the first was in 2003 – LEGO Sports Snowboarder Boarder Cross Race 3538), however it is the highest!

Lorsqu'elle est placée sur les cavernes, cette plaque de base se situe à 33 cm du sol ! Ce n'est pas la première fois qu'une plaque de base LEGO® est surélevée (la première était en 2003 avec l'ensemble LEGO Sports Cross en planche à neige 3538), mais c'est la plus haute !

Quando se coloca encima de las cavernas, ¡esta base queda a 33 cm del suelo! No es la primera vez que se eleva una base LEGO® (la primera fue en 2003 con el set LEGO Sports Snowboarder Boarder Cross Race [3538]), ¡pero nunca se había hecho a una altura tan sorprendente!





## HOW TO HOLD AND SEPARATE THE MODEL

The safest way to keep both the bank and all its occupants secure is to separate the bank on its baseplate from the vault section first and make sure you lift with both hands, supporting each module from the base.

## COMMENT TENIR ET SÉPARER LE MODÈLE

Le moyen le plus sûr de sécuriser la banque et tous ses occupants est de séparer d'abord la banque sur sa plaque de base de la section des coffres et de s'assurer que vous soulevez avec les deux mains, en tenant chaque module à partir de la base.

## CÓMO SOSTENER Y SEPARAR EL MODELO

La forma más segura de mantener a salvo tanto el edificio como a todos sus ocupantes es separar primero el banco con su base de la sección de las bóvedas asegurándose de levantarlo con ambas manos, sujetando cada módulo por la base.







3x

706

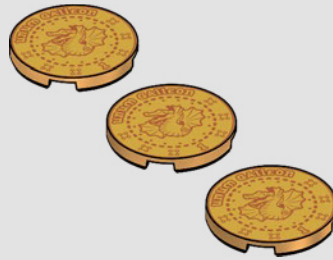

Three golden Galleons!  
These exclusive coins can be added to your collection of Hogwarts™ artifacts from the LEGO® Hogwarts Icons set (76391).

Trois gallions d'or !  
Ces pièces de monnaie exclusives peuvent être ajoutées à votre collection d'objets de Poudlard de l'ensemble LEGO® Les icônes de Poudlard (76391).

¡Tres galeones de oro! Estas exclusivas monedas pueden añadirse a tu colección de artefactos de Hogwarts™ del set LEGO® Íconos de Hogwarts (76391).



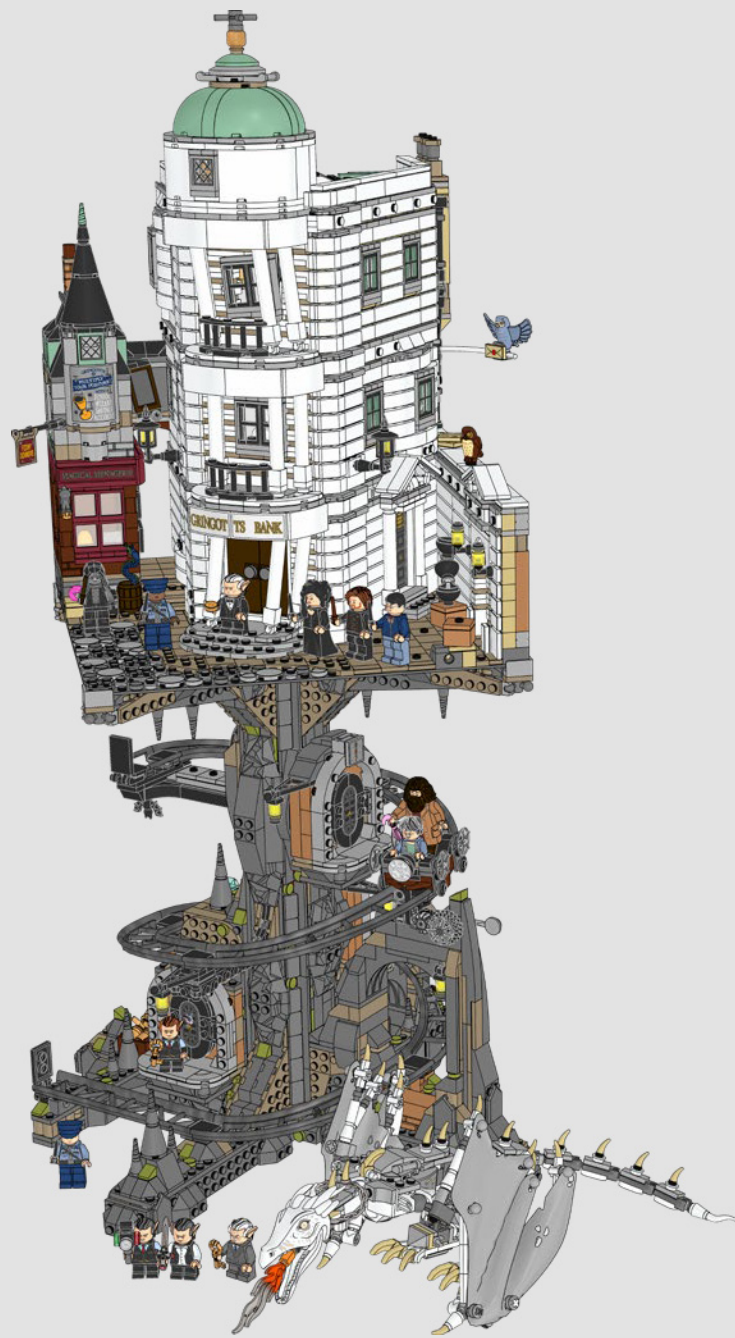

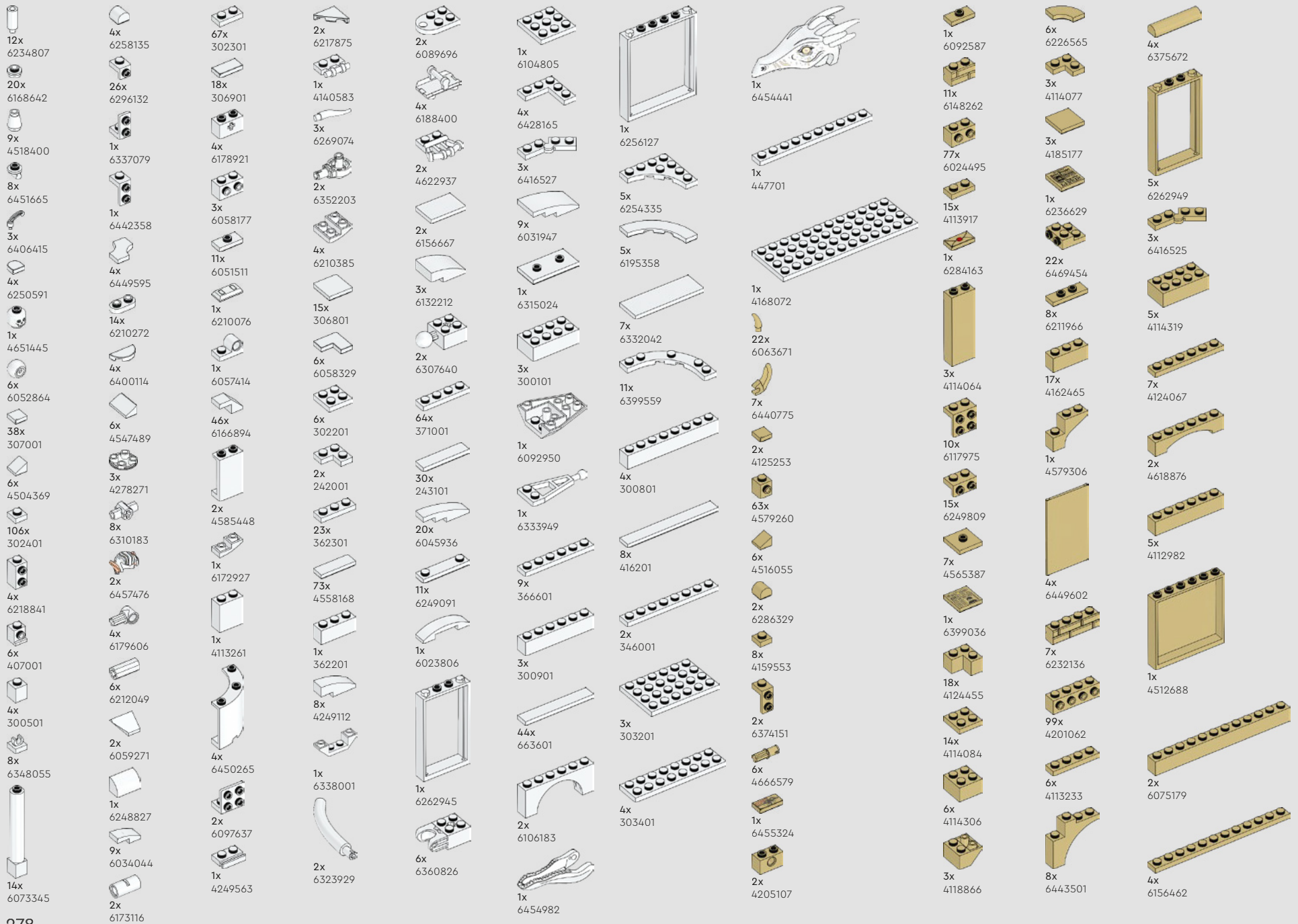

2x 654121	7x 4529236	14x 6234994	1x 4653822	4x 6267487	1x 6234806	6x 300326	2x 6457489	2x 6360129	2x 6174411	1x 6457875
1x 389921	5x 306226	1x 6170566	3x 4278359	1x 6146220	4x 6336989	3x 4163373	1x 6454431	1x 395726	1x 6093518	1x 6274738
2x 4143832	1x 6356406	1x 4526110	1x 6092664	1x 243226	4x 4225201	1x 4124096	1x 6454448	3x 300126	1x 6457513	2x 6285587
6x 300121	3x 6439039	4x 6299338	1x 6310823	1x 393726	1x 6350725	5x 6089119	1x 6456683	1x 4587844	6x 6208787	3x 6245250
3x 300821	2x 6270027	4x 6171060	1x 6174243	4x 6174243	2x 6273708	1x 4515368	1x 6457117	1x 4587844	2x 379526	7x 6404363
1x 4562805	2x 4286267	1x 473326	2x 474026	4x 4515373	2x 6398391	1x 6457336	1x 6457123	12x 302026	2x 379526	8x 6254552
1x 6189191	2x 459926	1x 6233922	2x 6280097	1x 300426	7x 242026	1x 6457517	1x 6457123	2x 6115198	2x 6318582	1x 6163901
2x 654124	4x 6445055	1x 6344752	10x 6449592	2x 6228588	13x 302226	1x 6116604	3x 6116604	4x 6350415	1x 6401209	1x 6286876
2x 6331822	2x 6227901	1x 6196548	4x 6449592	1x 6192309	13x 306826	1x 6154860	1x 6162892	4x 6256116	14x 447726	
2x 4121625	1x 6228987	3x 6102341	4x 4596914	1x 6047276	12x 6211476	7x 6199908	5x 300226	4x 6256116	3x 4274405	
2x 6210496	6x 6273589	1x 6191994	2x 6308975	2x 6016172	16x 6191630	10x 4558170	4x 6331483	3x 4274405	1x 6170421	
2x 6315887	5x 6335388	4x 4548180	1x 6281919	1x 6006650	1x 6394979	1x 362226	2x 6370959	4x 6331483	6x 6105963	
4x 6321194	4x 6388352	4x 6051508	2x 4220539	2x 6346535	4x 303926	1x 6256051	5x 301026	2x 6370959	6x 389426	
19x 6168646	1x 6065496	6x 4109810	13x 302326	2x 6346535	11x 4273703	1x 6256051	10x 6254045	10x 6254045	1x 663626	
	6x 302426	19x 6279875	1x 6178922	2x 4106513	16x 4565323	2x 6450658		1x 663626		
		2x 6275732	2x 6275732							

11

11

- 1x 6264987
- 10x 6278710
- 1x 6365618
- 2x 6360033
- 1x 6444527
- 3x 6396803
- 3x 6258607
- 1x 6247785
- 2x 6274739
- 5x 6245277
- 10x 6435020
- 7x 6252049
- 1x 6240515
- 280
- 3x 6240216
- 9x 6238674
- 1x 6274742
- 1x 6390029
- 1x 6301397
- 1x 6435720
- 4x 6013530
- 1x 4267425
- 1x 6322231
- 1x 6457509
- 1x 6457506
- 1x 6381997
- 25x 6300322
- 45x 4549436
- 20x 6001824
- 71x 6251386
- 4x 6385281
- 4x 6385280
- 7x 6002843
- 7x 6002847
- 72x 4520257
- 1x 6016059
- 17x 6310835
- 24x 4530678
- 6x 6121959
- 41x 6449563
- 2x 6101254
- 24x 4496699
- 4x 6092591
- 5x 6330148
- 1x 6365489
- 10x 6449564
- 41x 6047415
- 9x 6356427
- 12x 6398654
- 4x 6276849
- 46x 4507045
- 14x 6126075
- 4x 6456637
- 4x 6031821
- 3x 6038637
- 26x 6035540
- 28x 4626904
- 10x 6175927
- 23x 6001822
- 3x 6232138
- 11x 6449596
- 10x 6455323
- 4x 4267874
- 3x 6167854
- 5x 6015424
- 4x 4507047
- 3x 4550329
- 12x 6156492
- 12x 6395743
- 3x 4246957
- 1x 4570111
- 1x 6450979
- 2x 6055306
- 2x 4162916
- 1x 6456672
- 1x 6401398
- 1x 6401399
- 1x 6223215
- 1x 4521948
- 3x 6247894
- 4x 6223913
- 3x 6247895
- 13x 6449861
- 11x 6184432
- 1x 6223166
- 12x 6202626
- 6x 6100234
- 4x 6449568
- 4x 6441284
- 10x 6249817
- 5x 6449566
- 7x 6099187
- 9x 6194726
- 5x 6449565
- 2x 6186830
- 4x 4550169
- 11x 6092597
- 8x 6382785
- 4x 6186005
- 9x 6107758
- 1x 6062650
- 5x 6052777
- 5x 6186003
- 5x 4539071
- 4x 4541528
- 2x 4650865
- 3x 4618986
- 1x 6089268
- 2x 6037995
- 1x 6240227
- 3x 6245265
- 1x 6453246
- 1x 6270028
- 1x 6234347
- 2x 6170813
- 4x 6062574
- 1x 4596335
- 3x 6035291
- 11x 4211180

3,2



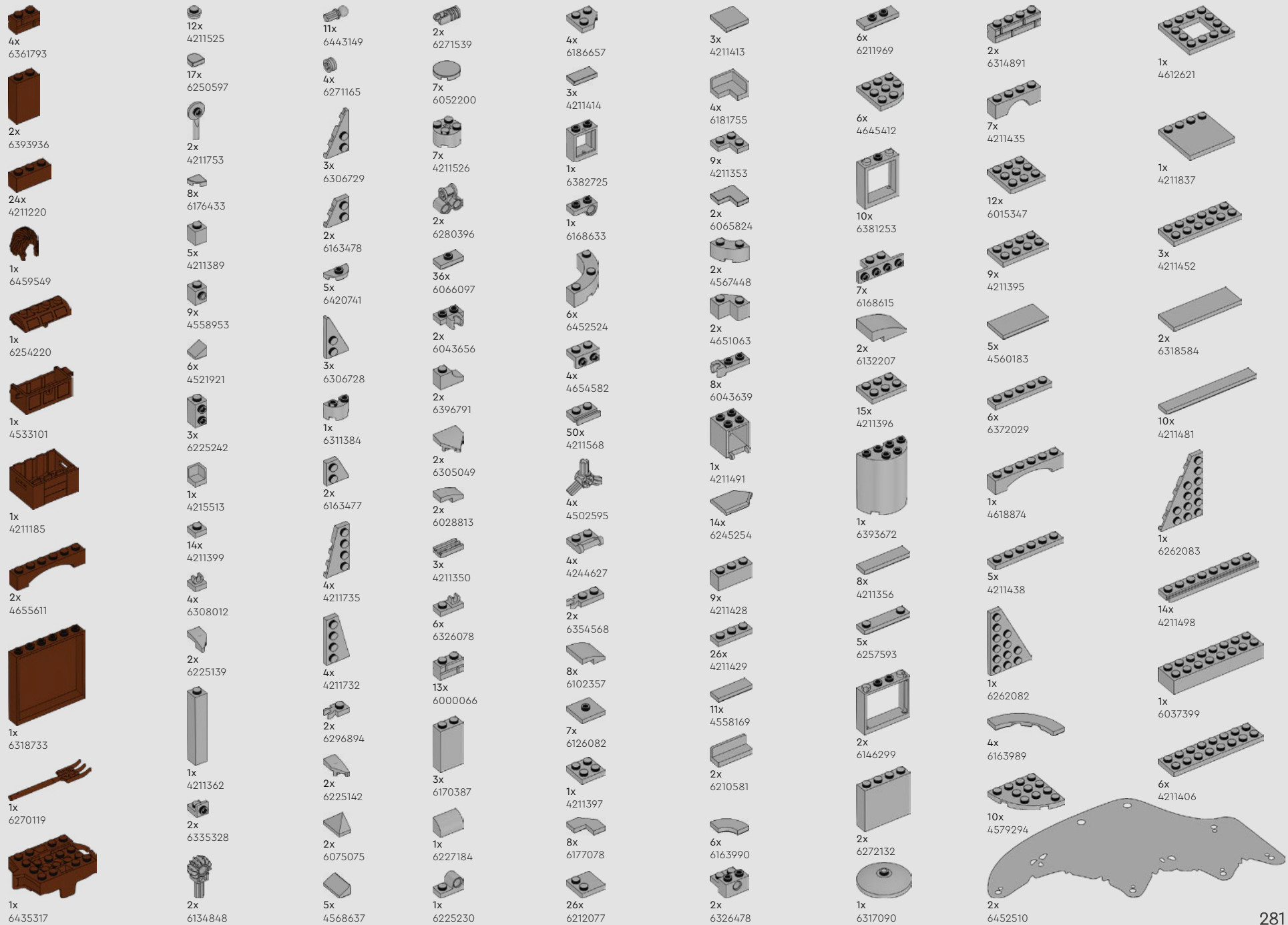

19x  
6445056

25x  
4529240

9x  
4211090

20x  
6284596

2x  
6271752

4x  
6439040

1x  
6171103

1x  
6192569

7x  
4251149

5x  
4211462

1x  
4211408

2x  
4211705

3x  
4211486

8x  
4211085

15x  
4211065

6x  
6075060

15x  
6172134

6x  
6079036

7x  
4210779

15x  
421056

15x  
4211056

13x  
4211100

1x  
6058858

1x  
6106191

4x  
4243831

11x  
4210875

2x  
6321746

2x  
6230281

11x  
4211008

6x  
4211099

5x  
4211115

2x  
4210967

2x  
6037666

11x  
4211107

1x  
4211061

8x  
4558955

4x  
6204668

8x  
6199549

3x  
4210719

1x  
6170811

8x  
6225494

4x  
6435043

2x  
6321350

1x  
6265669

2x  
6265702

10x  
6350724

4x  
6204667

1x  
6388119

33x  
4567887

4x  
6100030

1x  
6381750

16x  
4211042

2x  
6457493

1x  
6233908

2x  
6398662

16x  
4211042

2x  
6457493

1x  
6233908

2x  
6398662

11x  
6013658

4x  
6069164

10x  
4211111

1x  
4500975

1x  
4221745

1x  
6168776

4x  
6117972

4x  
6000606

4x  
6092666

1x  
6429051

5x  
6250018

1x  
6285244

4x  
4586562

4x  
4209014

1x  
6316692

30x  
4211054

5x  
6250018

1x  
6285244

4x  
4586562

4x  
4209014

1x  
6316692

4x  
4211055

17x  
4211000

3x  
6314192

4x  
6359227

2x  
6309059

11x  
4234534

11x  
6071261

16x  
4211109

4x  
6445057

6x  
6015356

6x  
6469463

2x  
4289258

8x  
6335316

1x  
6457137

22x  
4568734

2x  
6309059

11x  
4234534

11x  
6071261

16x  
4211109

4x  
6445057

6x  
6015356

6x  
6469463

2x  
4289258

8x  
6335316

1x  
6457137

22x  
4568734

21x  
4211104

26x  
6227909

6x  
4211060

2x  
6135290

16x  
4582257

3x  
4211105

29x  
4210725

2x  
4648256

8x  
4211001

5x  
4535930

3x  
4210637

2x  
6343337

6x  
6393306

2x  
6416526

2x  
6324639

4x  
6039482

8x  
4211085

15x  
4211065

6x  
6075060

15x  
6172134

6x  
6079036

7x  
4210779

15x  
421056

13x  
4211100

1x  
6058858

1x  
6106191

4x  
4243831

11x  
4210875

2x  
6321746

2x  
6230281

11x  
4211008

6x  
4211099

5x  
4211115

2x  
4210967

2x  
6037666

11x  
4211107

1x  
4211061



29x  
6133611



4x  
4211067



2x  
4211114

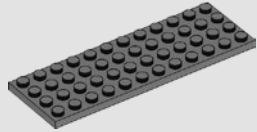

3x  
4210706

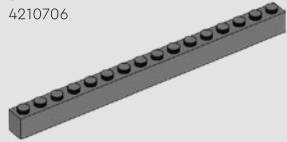

7x  
4210783



9x  
4210796



1x  
6451658

1x  
6139364



1x  
6287323



7x  
6435637



2x  
4210678



4x  
4210794

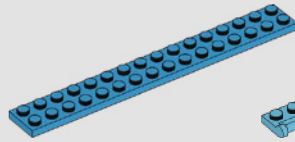

1x  
6249123



19x  
6097419



1x  
6249415



1x  
6441006



1x  
6236582



2x  
6354673



1x  
6209684



1x  
6455325



24x  
6284595



37x  
6002841



4x  
6278087



10x  
6278088



1x  
6405179



1x  
6447005



1x  
6445154



1x  
6359834



2x  
6099370



1x  
6383096



1x  
6445155



1x  
6118815



1x  
6237879



2x  
6454427



1x  
6454425



1x  
6454414



1x  
6454416



1x  
6455321



1x  
6454419



1x  
6454421



1x  
6335932



10x  
4505990



19x  
6445157



4x  
6190252



47x  
4523159



15x  
6209691



6x  
4529247



3x  
6186672



1x  
6328909



7x  
6173139



1x  
4621352



2x  
6452472



3x  
6335111



17x  
6112307



29x  
6207933



4x  
6092594



1x  
6022033



6x  
6093529



4x  
6347982



3x  
6455322



21x  
6069887



1x  
6270032



1x  
6278987



1x  
6005225



1x  
6468357



1x  
6403831



2x  
6452420



1x  
6337282



1x  
6170292



18x  
6422082



1x  
6237868



10x  
4656783



6x  
6186400



1x  
6237864



1x  
6237779



3x  
6058085



2x  
6102994



6x  
6189103



2x  
6187006



4x  
6396749



8x  
6099341



3x  
6106193

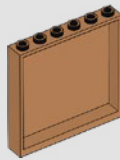

2x  
6313598

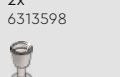

8x  
6107389

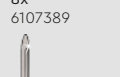

1x  
6306750

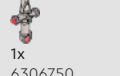

5x  
6323689



1x  
6037634



LEGO.com/service

# IV

LEGO and the LEGO logo are trademarks of the/sont des marques de commerce du/  
son marcas registradas de LEGO Group. ©2023 The LEGO Group. 6477038

WIZARDING WORLD and all related trademarks, characters, names, and indicia are  
© & ™ Warner Bros. Entertainment Inc. Publishing Rights © JKR. (s23)