



Harry Potter



76411





Get excited about our new packaging!

We're switching from plastic to paper-based packaging. That's why you might find a mix of paper and plastic in our boxes!

Nos nouveaux emballages vous emballeront !

Nous passons des emballages en plastique aux emballages à base de papier. C'est pourquoi vous pourriez trouver un mélange de papier et de plastique dans nos boîtes !

¡Te presentamos nuestros nuevos empaques!

Estamos sustituyendo las bolsas de plástico por bolsas con base de papel. ¡Por eso, puedes encontrar una mezcla de papel y de plástico en nuestras cajas!

[LEGO.com/sustainable-packaging](https://www.lego.com/sustainable-packaging)



BUILDER



Apple and the Apple logo are trademarks of Apple Inc., registered in the U.S. and other countries and regions. App Store is a service mark of Apple Inc. Google Play and the Google Play logo are trademarks of Google LLC. Tencent and the Tencent logo are trademarks of Tencent Inc.

LEGO.com/devicecheck

EN Ask parents' permission before going online | DE Eltern um Erlaubnis bitten, bevor du online gehst | FR Demande l'autorisation d'un parent avant d'aller en ligne | IT Chiedi il permesso ai tuoi genitori prima di andare online | ES Pídeles permiso a tus papás antes de conectarte a Internet | PT pede autorização aos pais antes de acederes online | JA オンラインになる前にほご者の方のきよかをもらおう | ZH 上网前应先征得父母的同意 | KO 온라인 접속 전에 보호자 동의가 필요합니다 | RU Спроси разрешения у родителей, прежде чем заходить в интернет | PL Poproś rodziców o zgodę, zanim wejdiesz do Internetu | CS Než půjdeš na internet, požádej rodiče o svolení | SK Skôr než pôjdeš na internet, vypýtaj si povolenie od rodičov | HU Kérj szülői engedélyt, mielőtt online csatlakoznál! | RO Cere permisiunea părinților înainte de a te conecta online | BG Поискайте разрешение от родител, преди да влезете онлайн | LV Pirms došanās tiešsaistē palūdz atļauju vecākiem | ET Enne Interneti kasutamist küsi vanematelt luba | LT Prieš prisijungdami prie interneto, atsislaukite tėvų

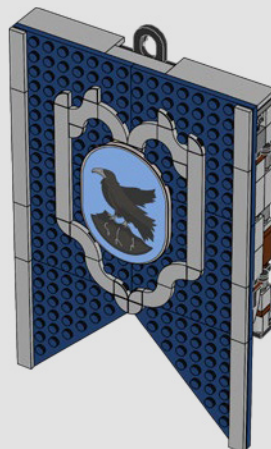
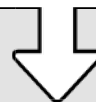
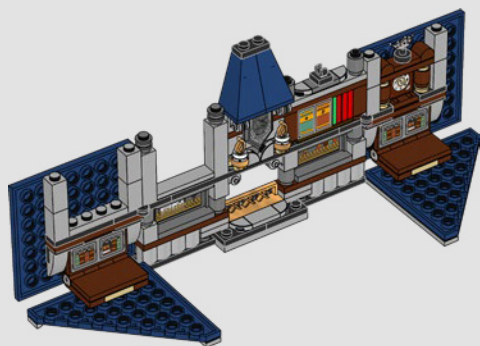
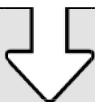

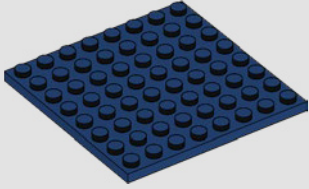
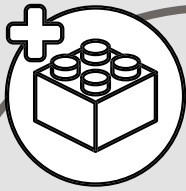

2x

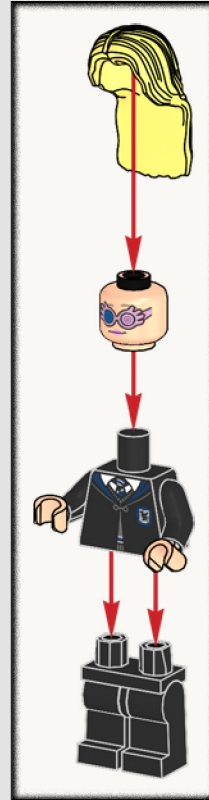

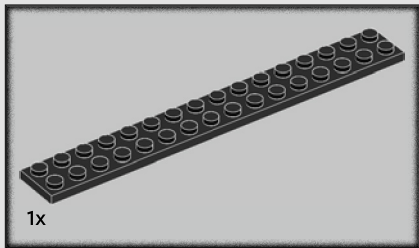
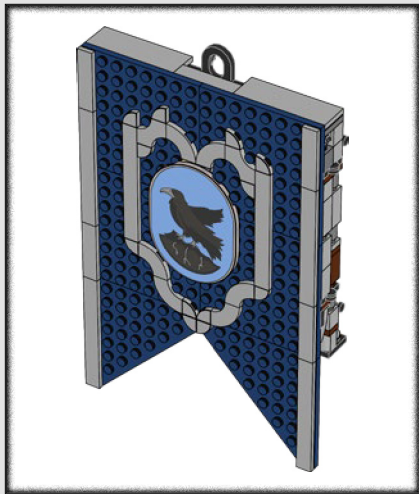

1

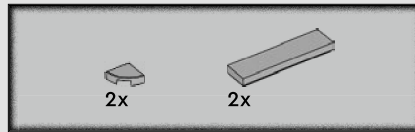
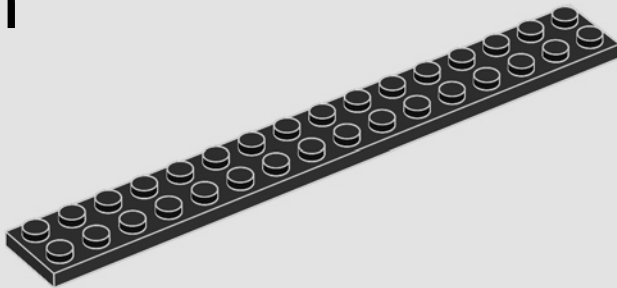

2

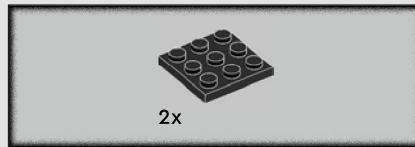
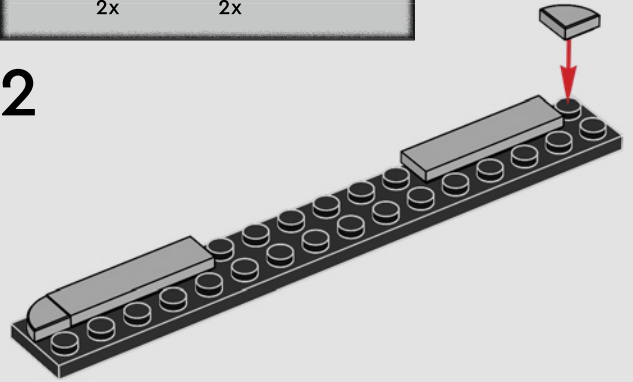

3

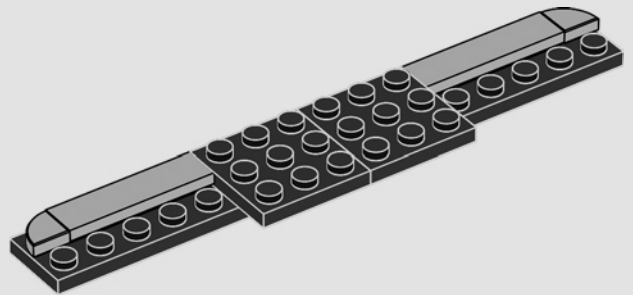

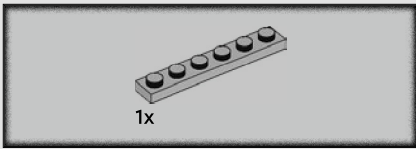

4

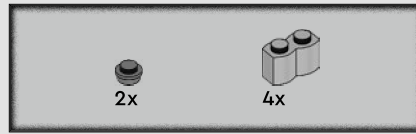
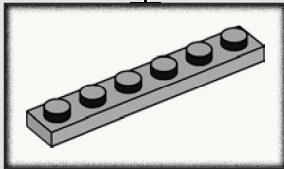
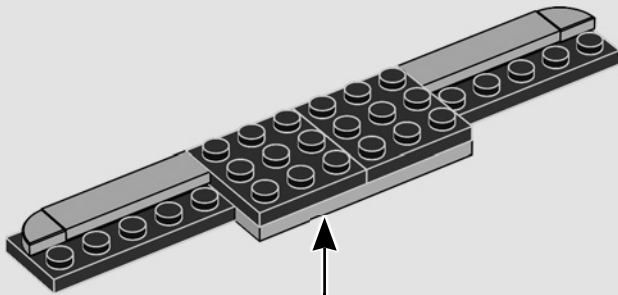

5

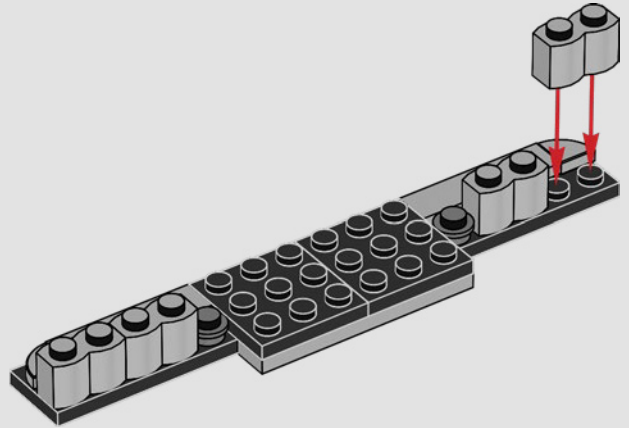

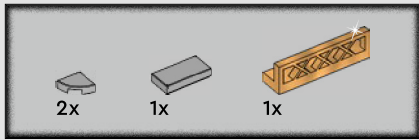

6

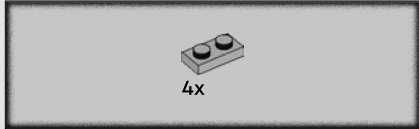
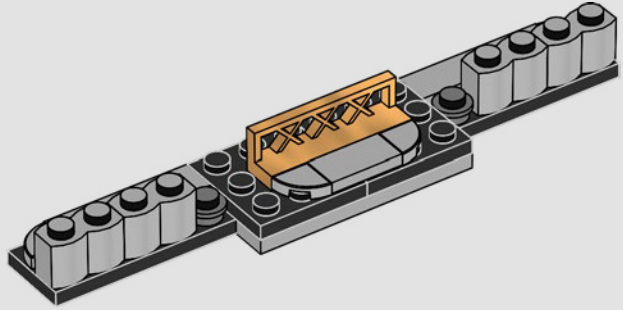

7

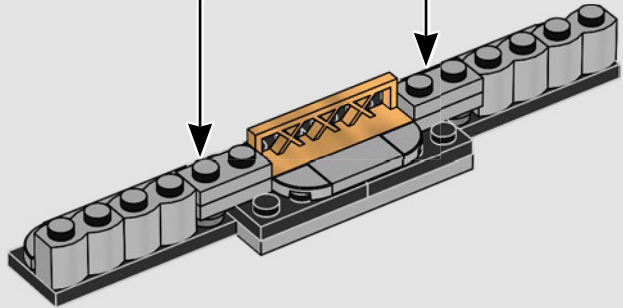
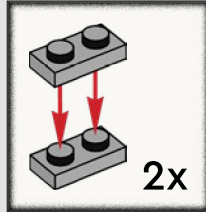

8



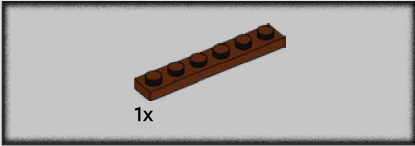
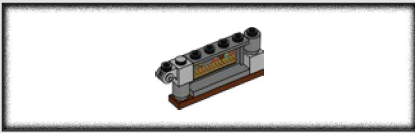

8

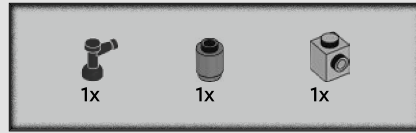
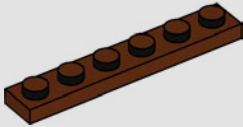

9

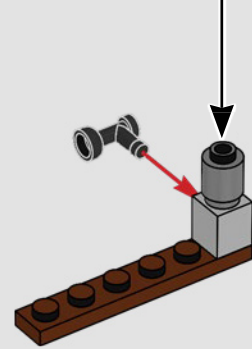
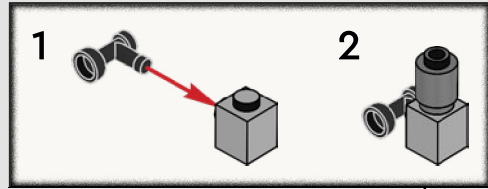

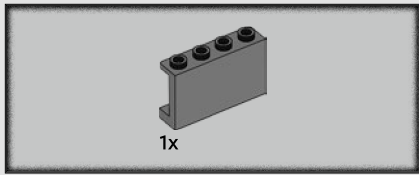

10

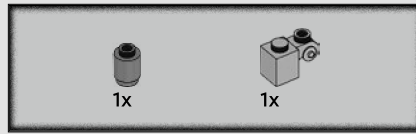
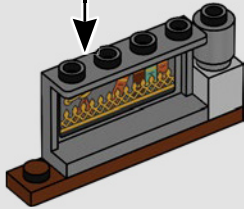
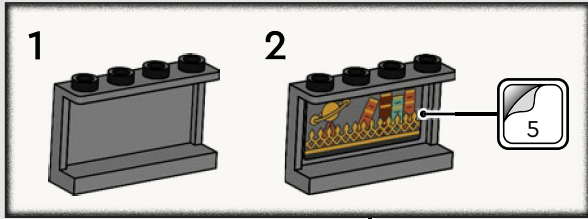

11

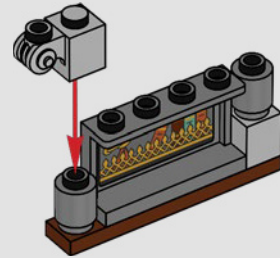

12

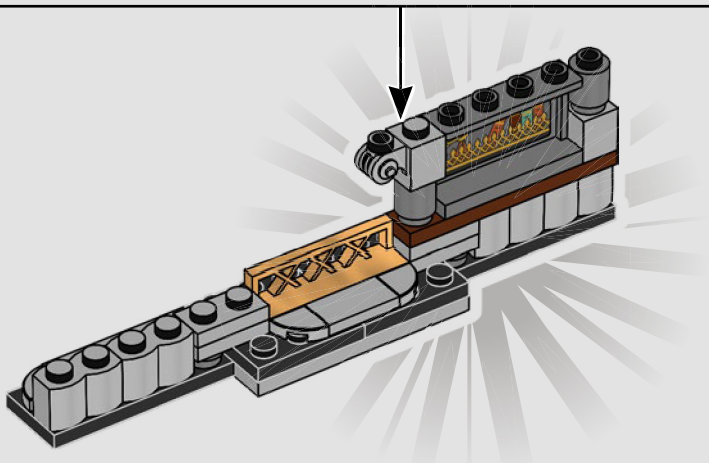

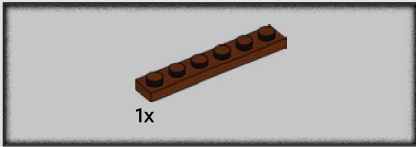

13

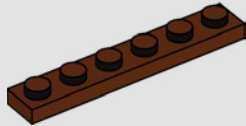

14

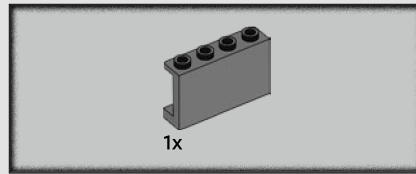
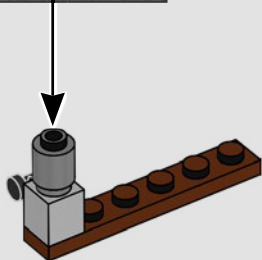
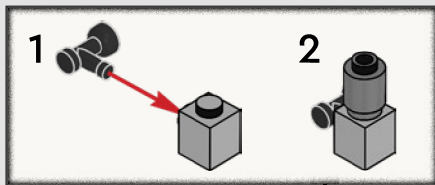

15

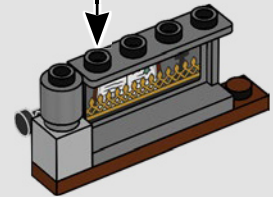
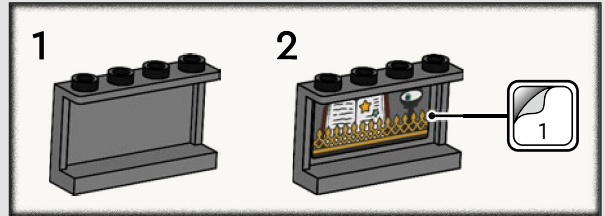

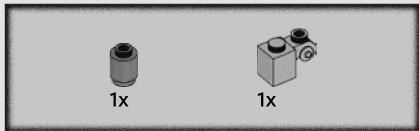

16

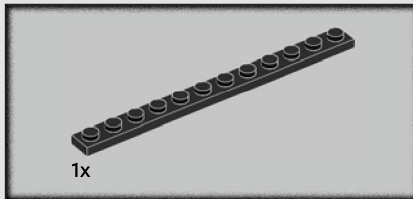
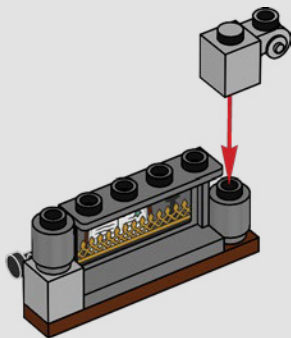

18

17

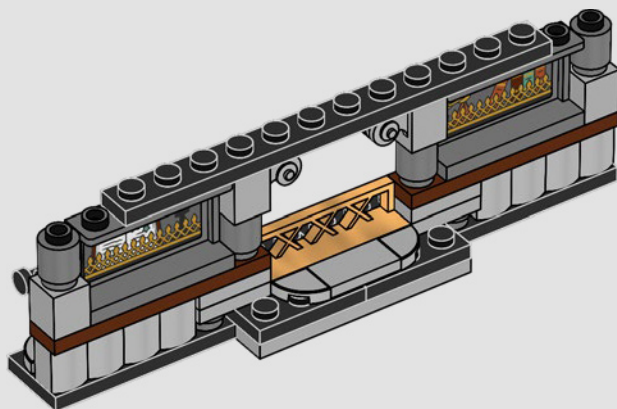
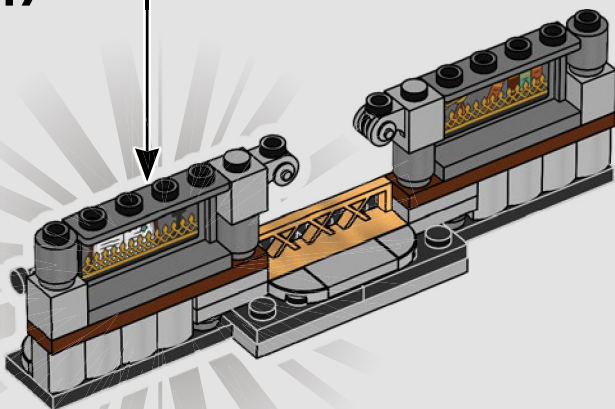

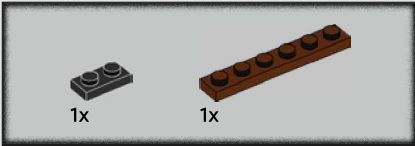
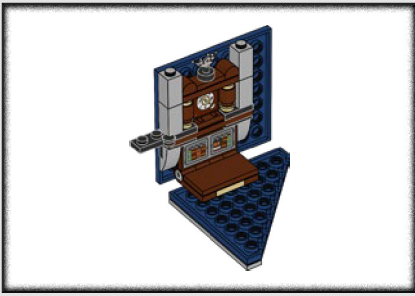

19

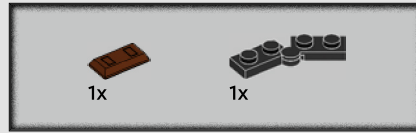
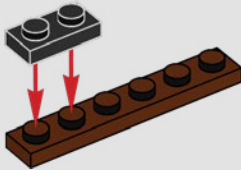

20

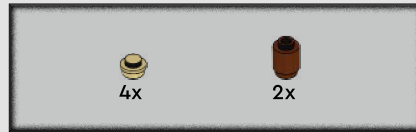
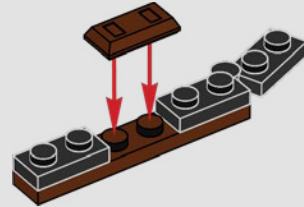

21

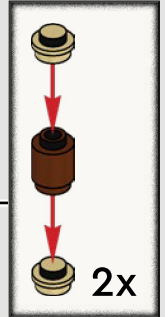
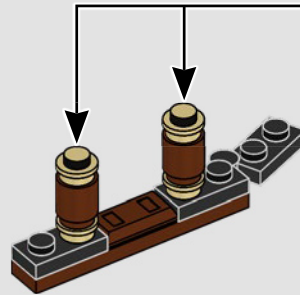

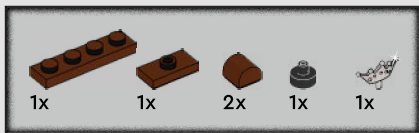

22

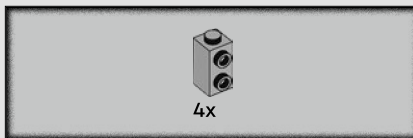
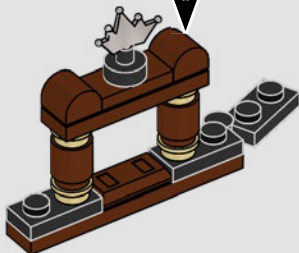
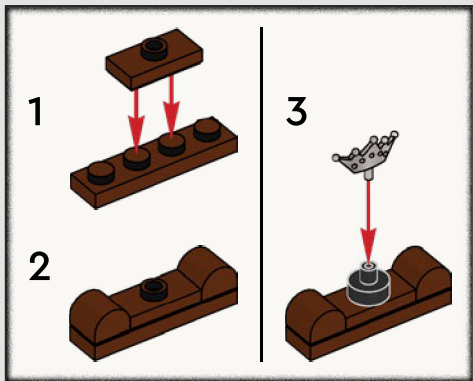

23

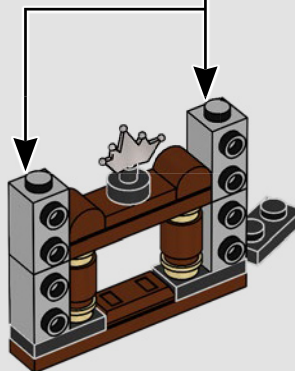
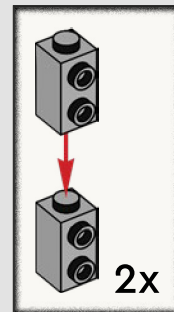

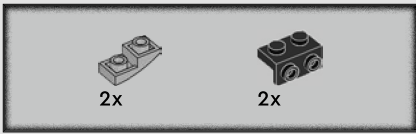

24

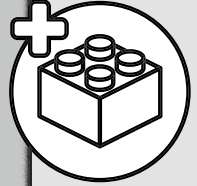
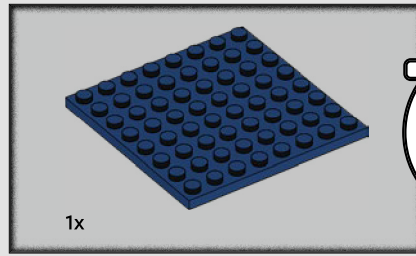
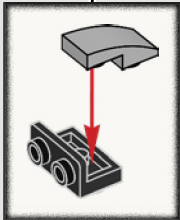
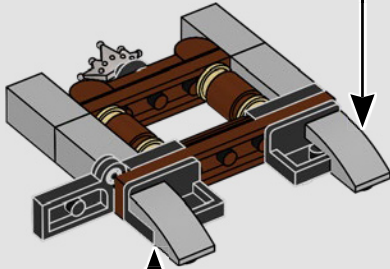
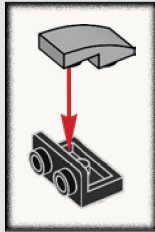

25

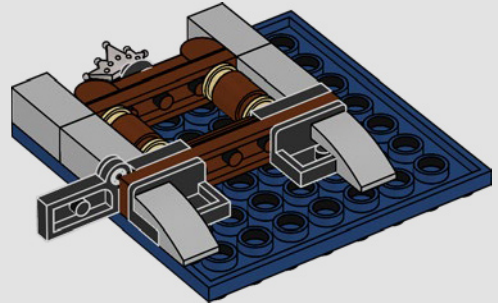



26

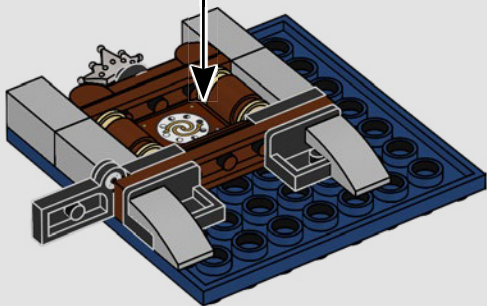
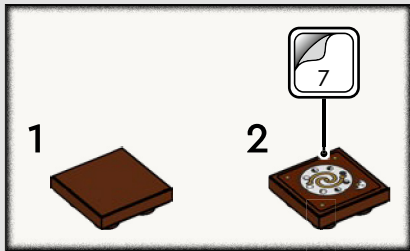

27

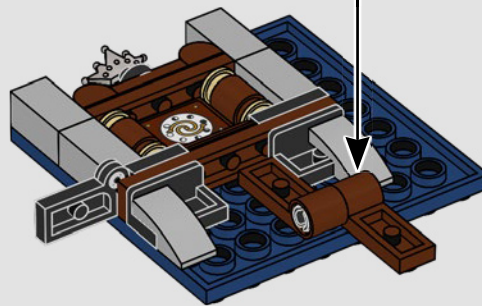
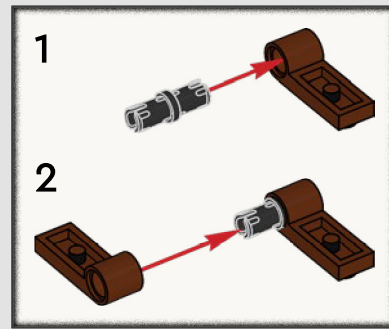

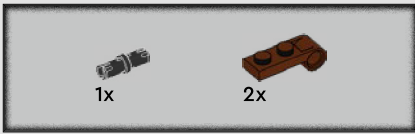

28

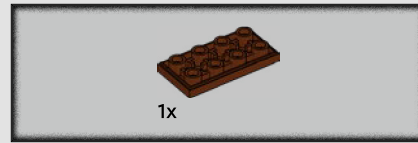
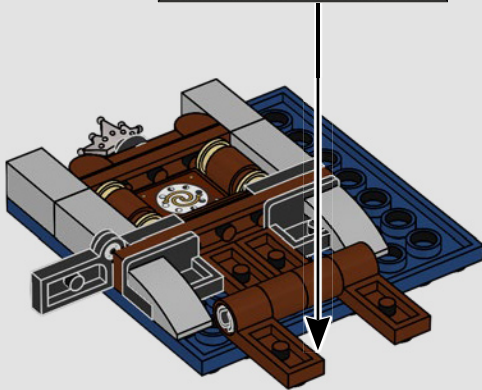
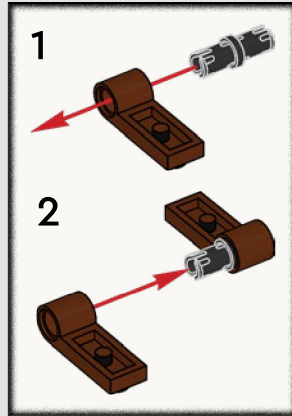

29

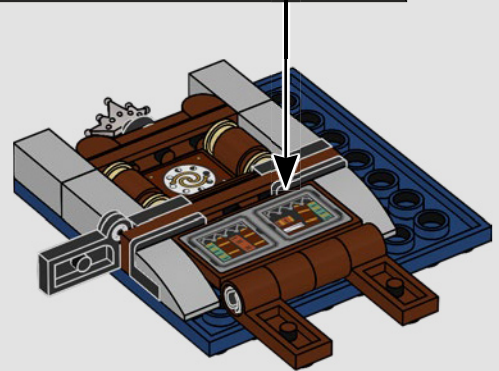
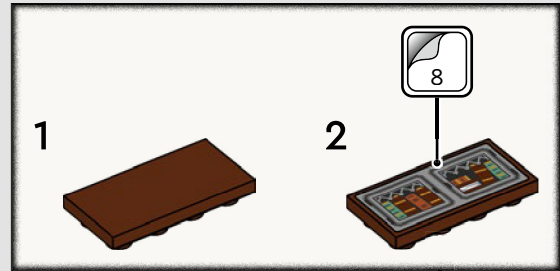

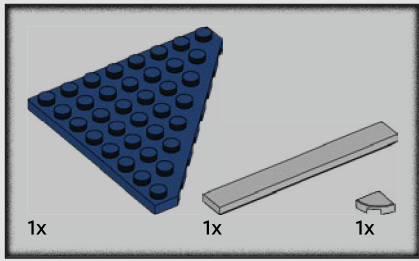

30

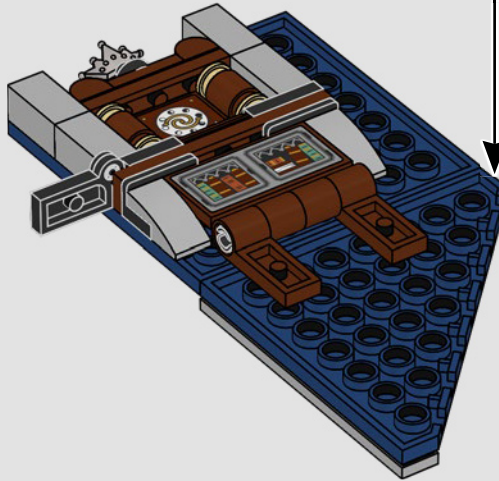
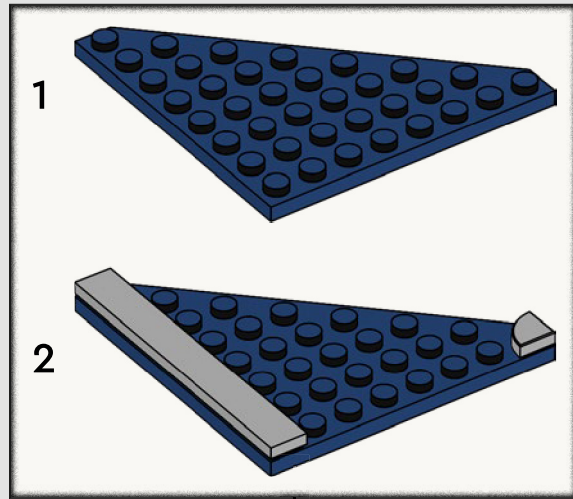

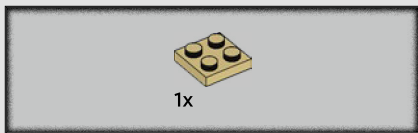

31

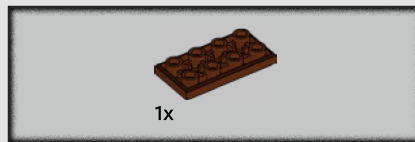
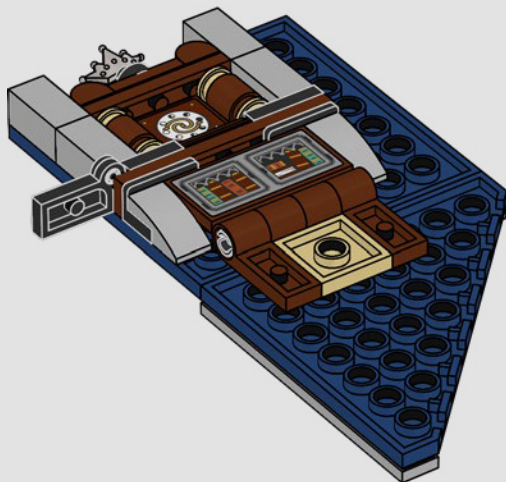

32

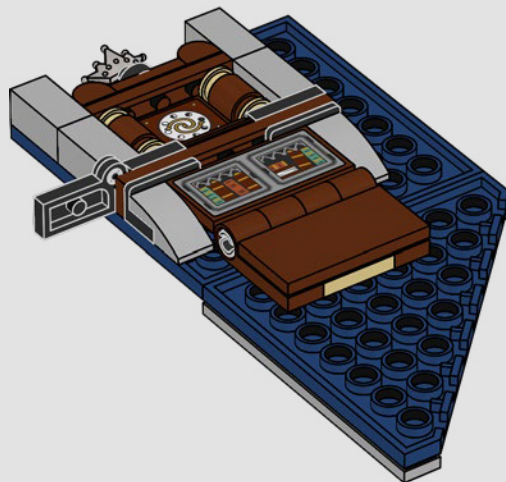

33



34

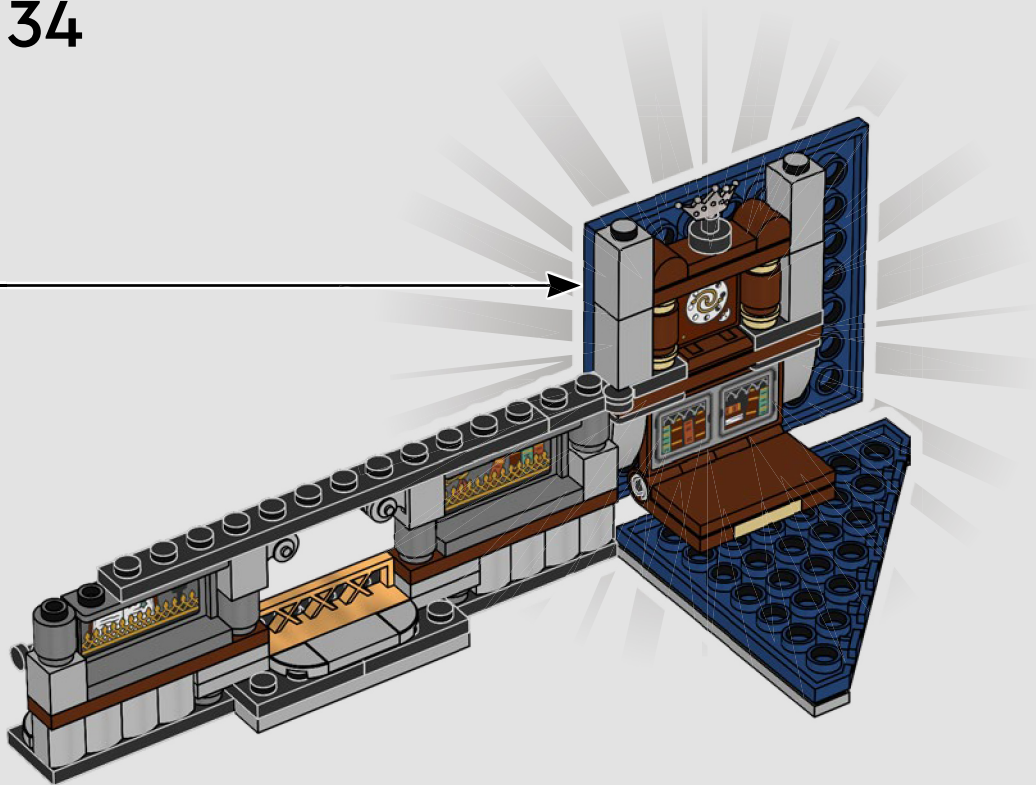

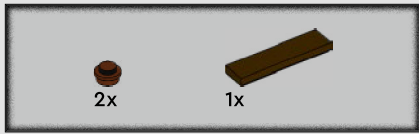

35

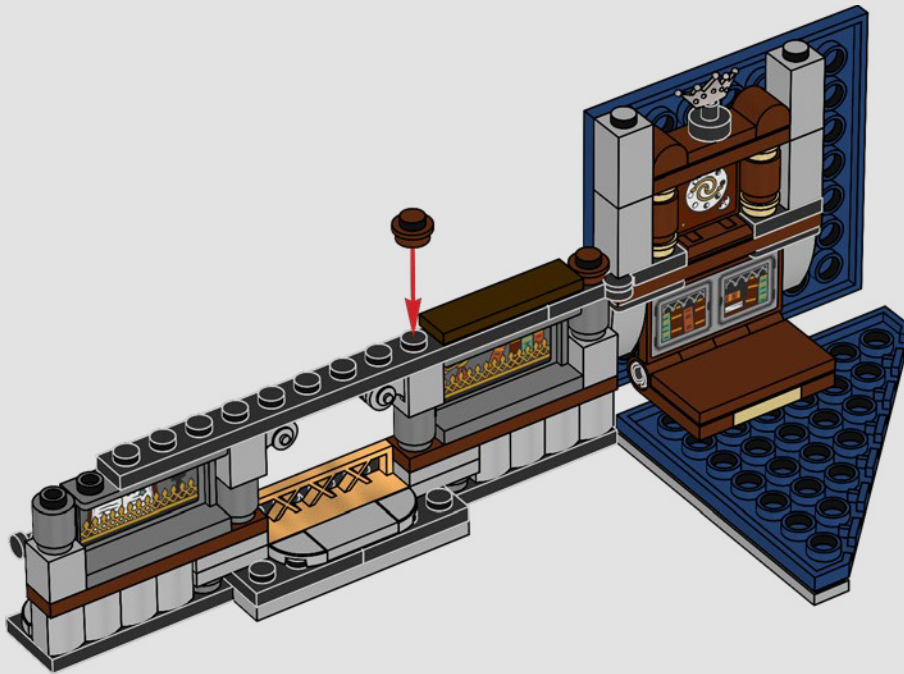

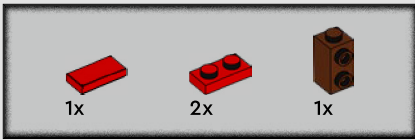

36

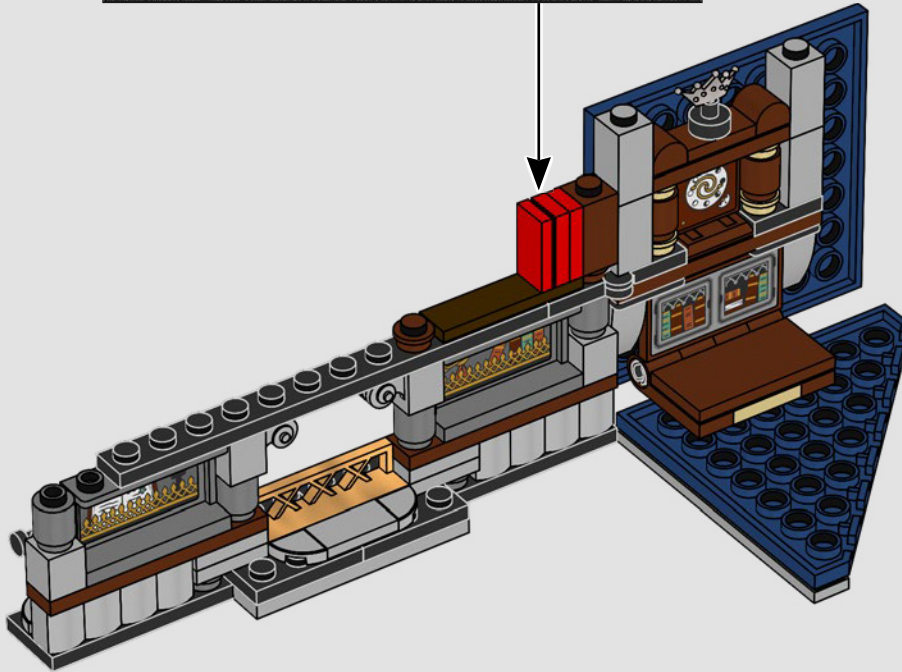
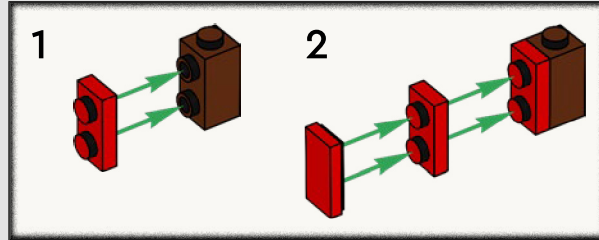

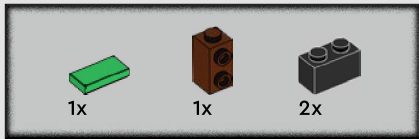

37

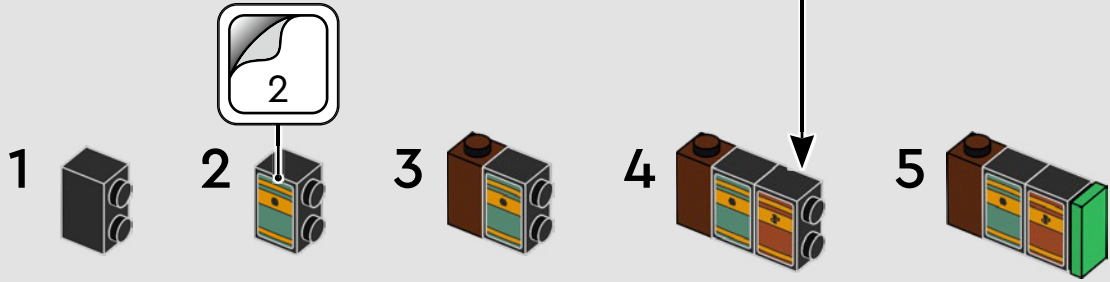

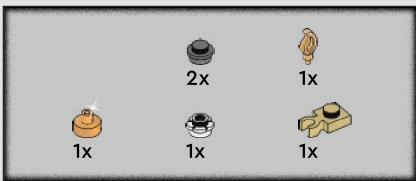

38

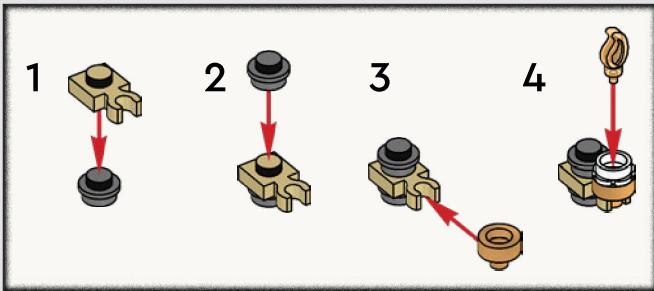

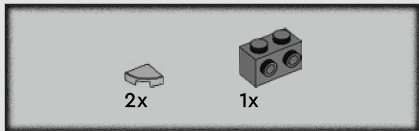

39

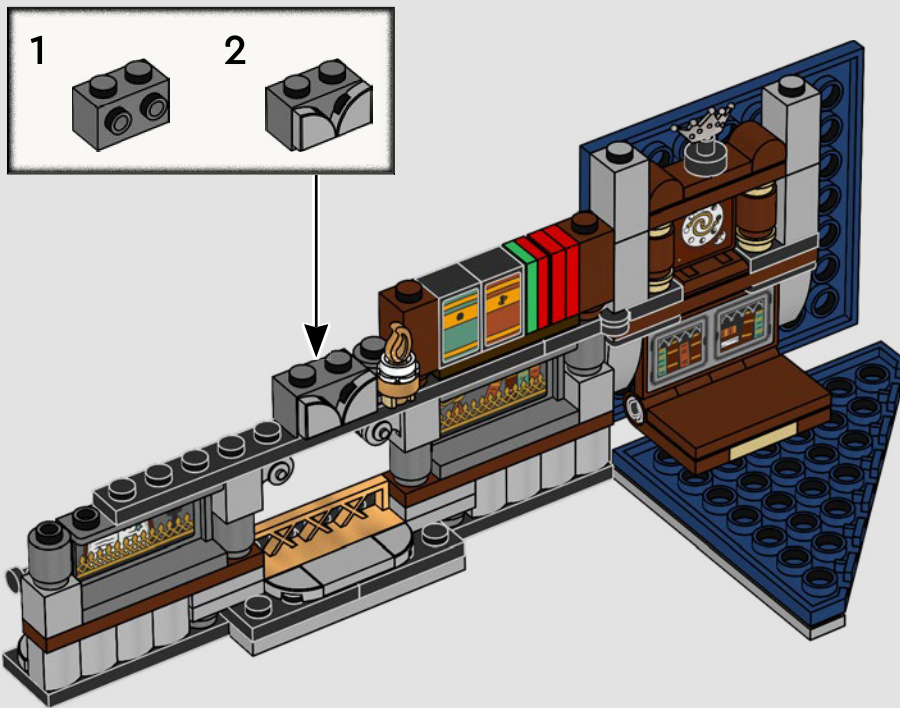

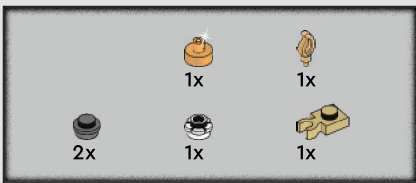

40

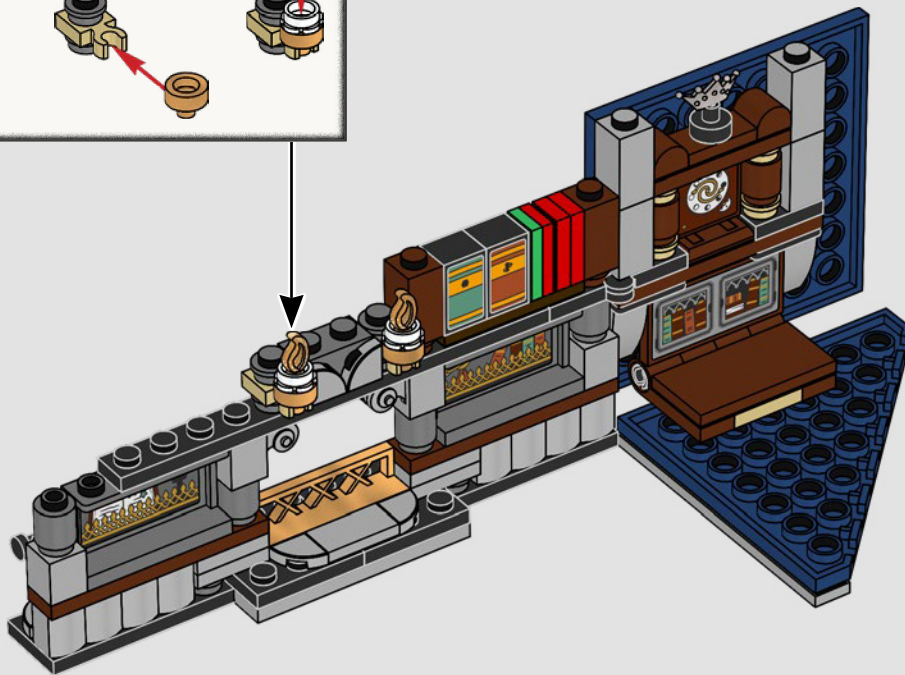
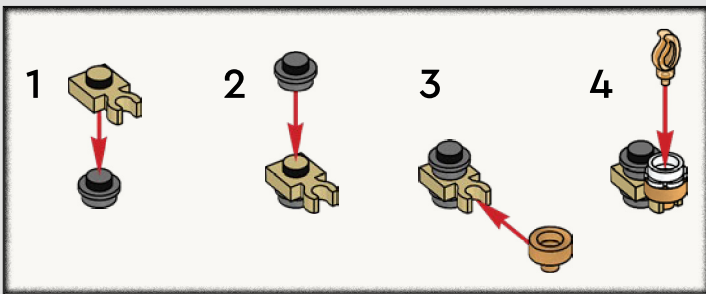

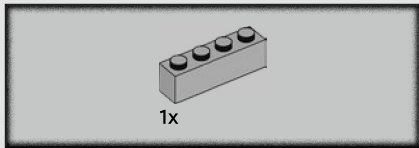

41

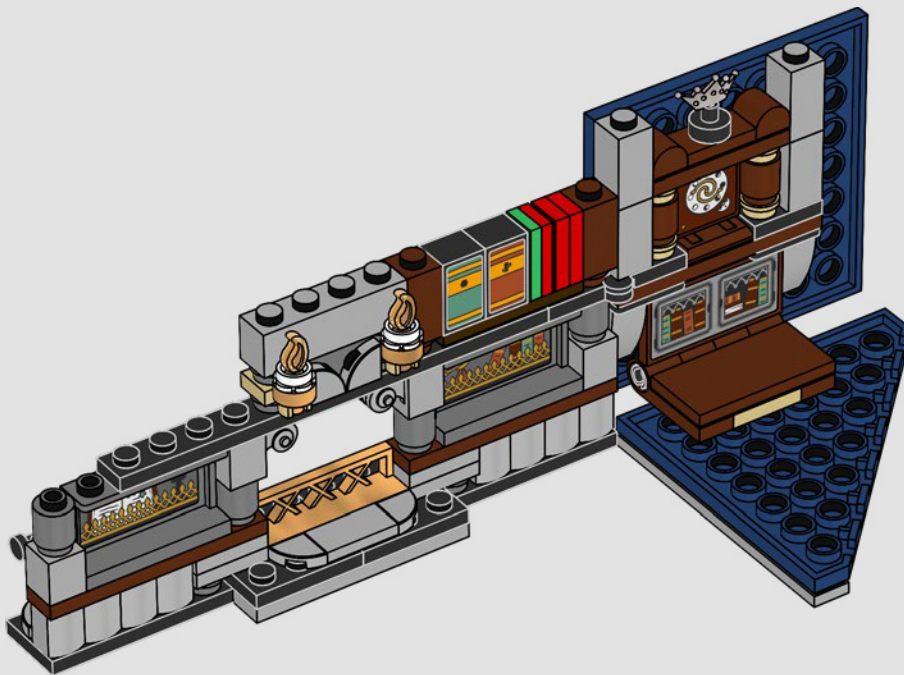

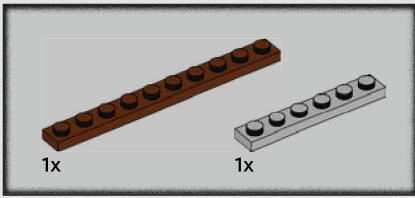

42

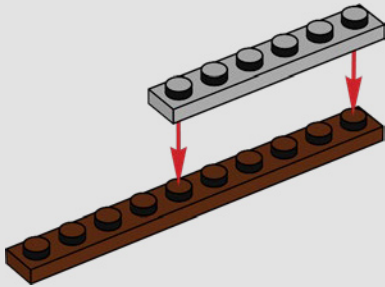

43

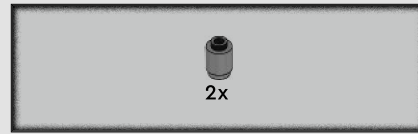
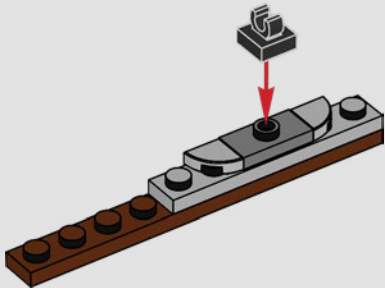

44

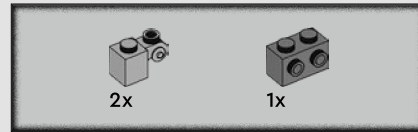
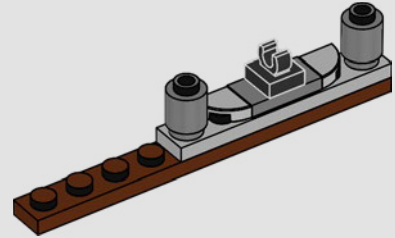

45

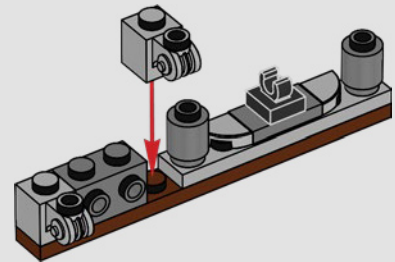

46

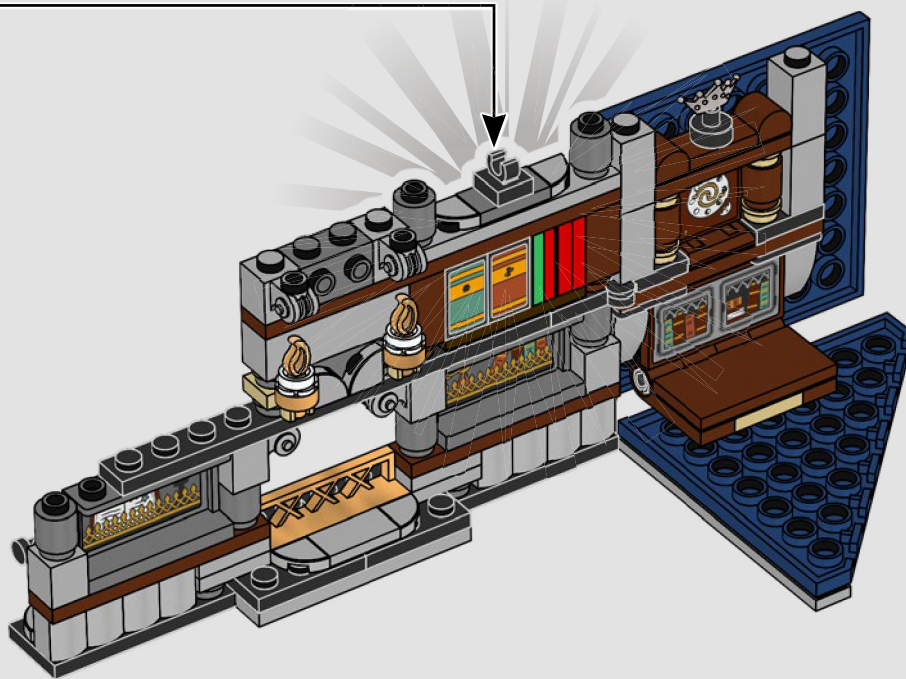

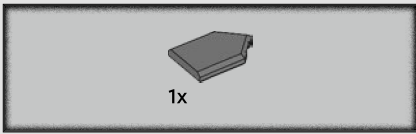

47

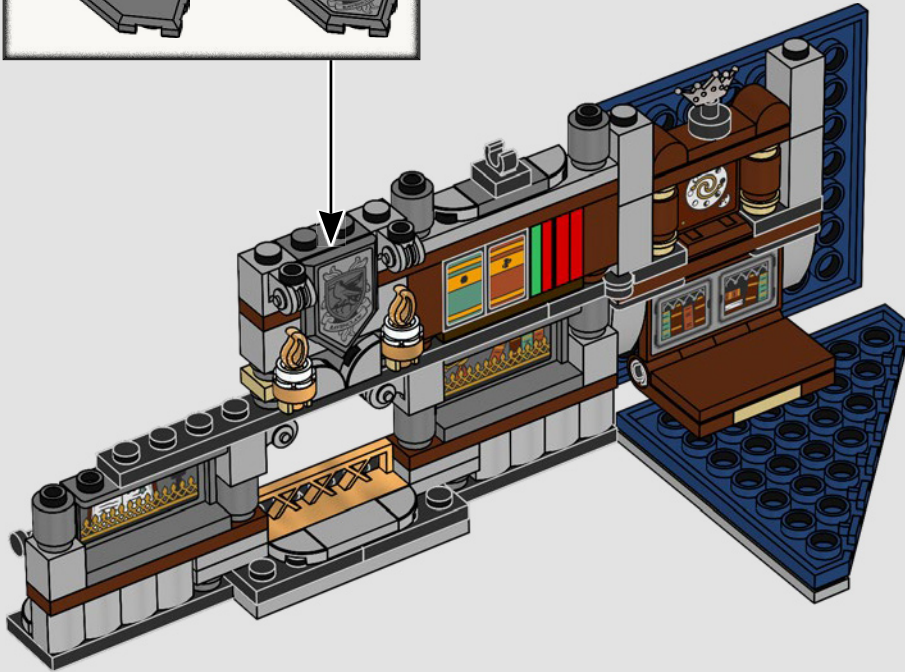
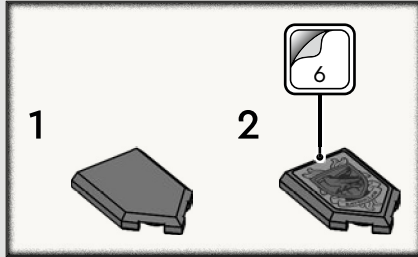

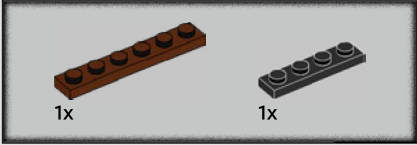
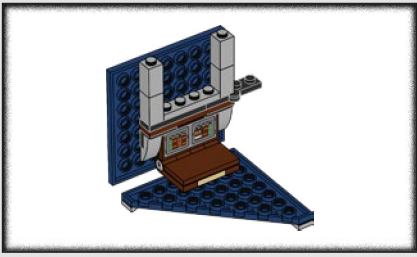

48

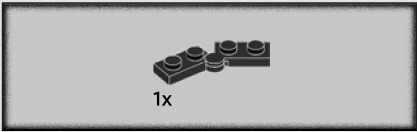
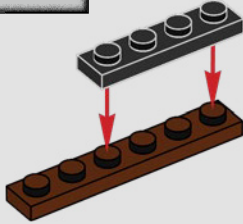

49

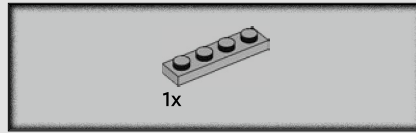
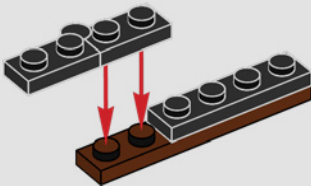

50

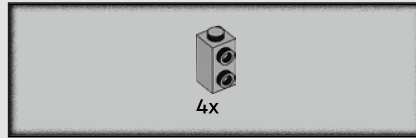
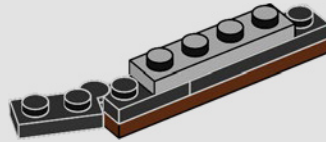

51

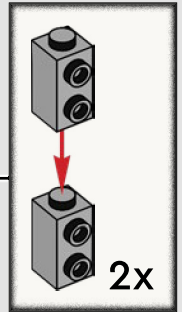
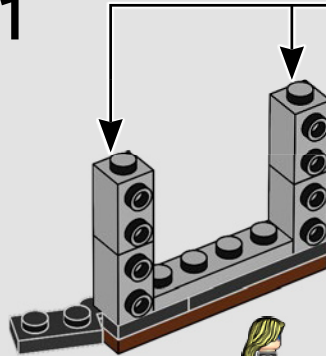

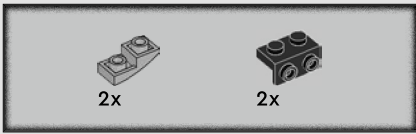

52

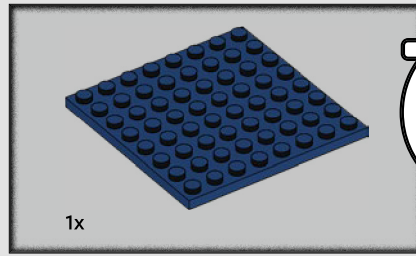
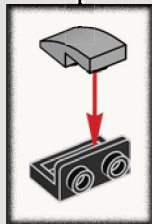
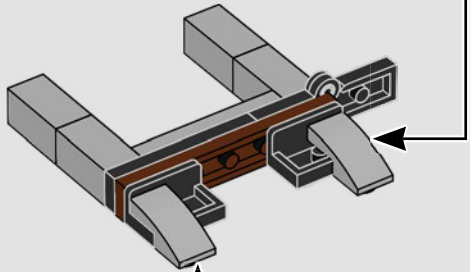
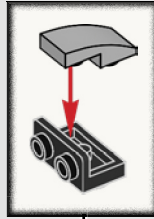

53

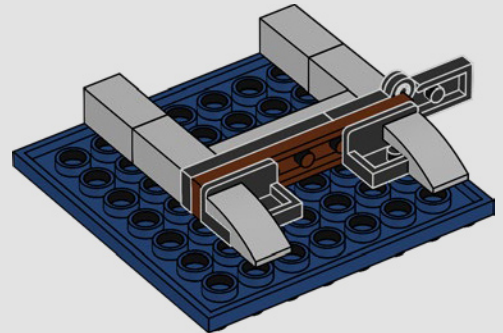
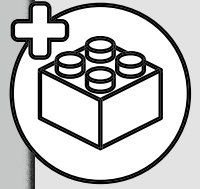

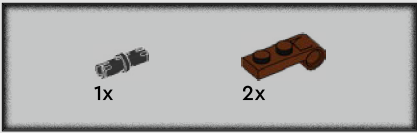

54

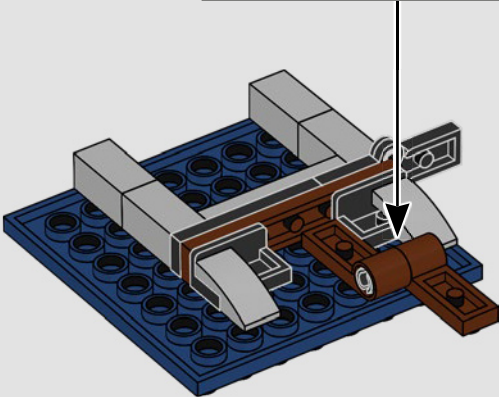
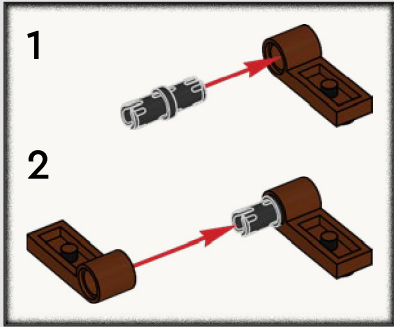

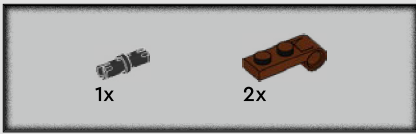

55

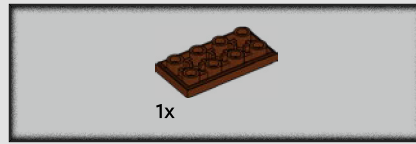
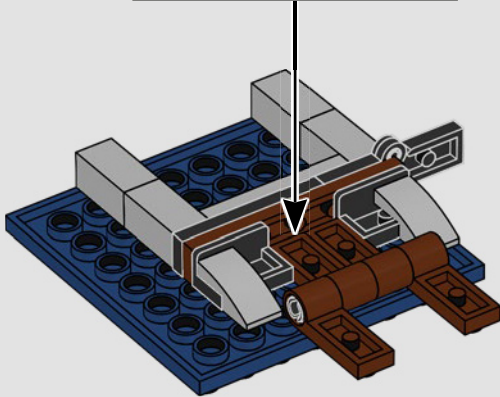
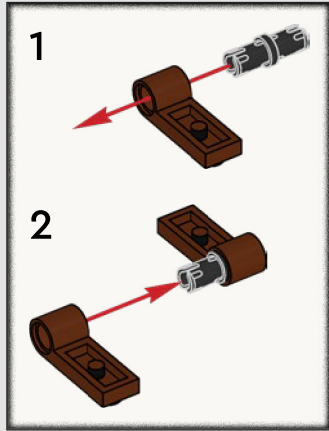

56

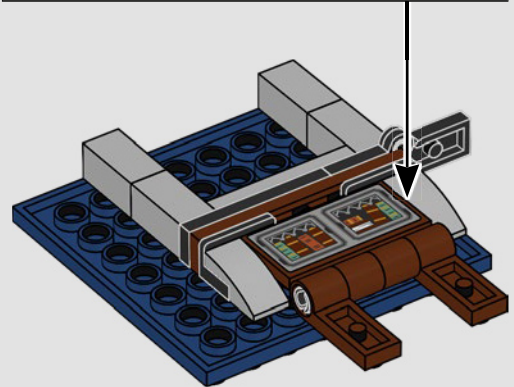
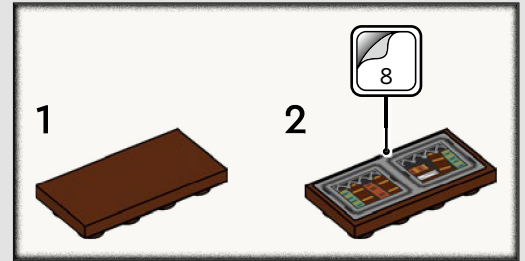

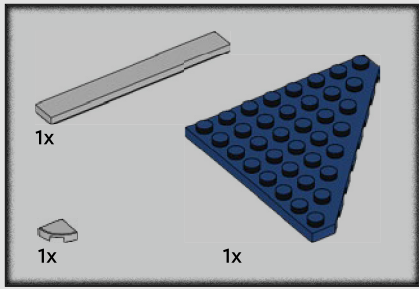

57

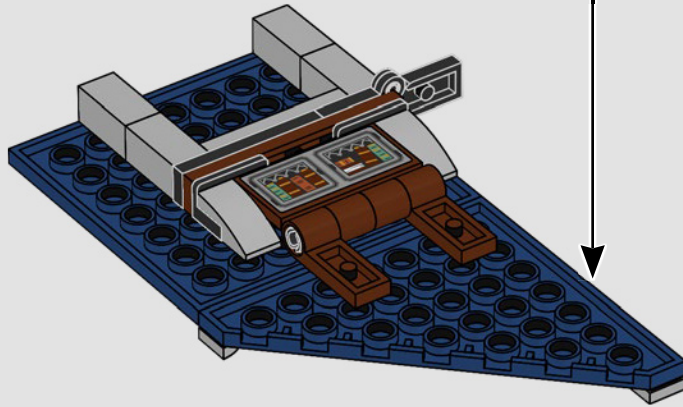
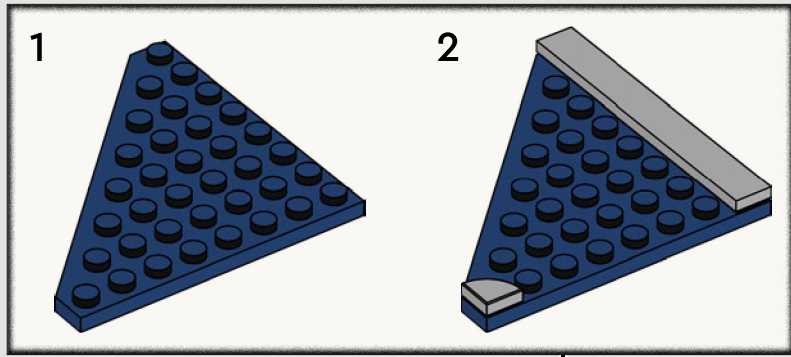

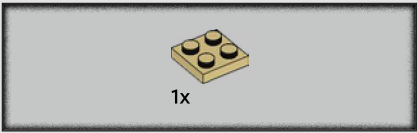

58

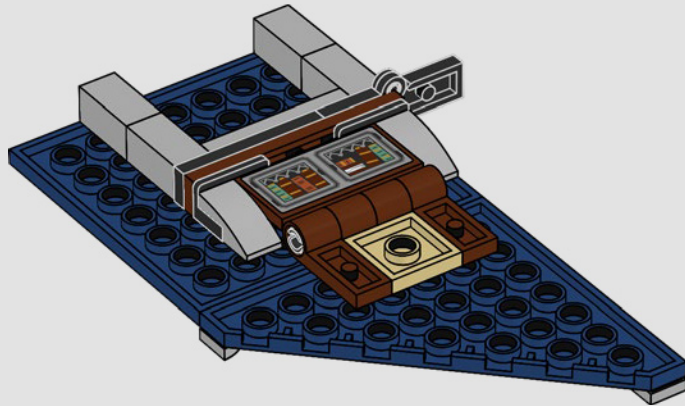

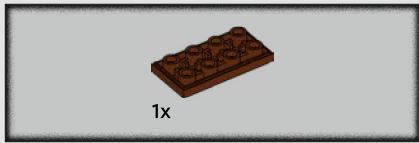

59

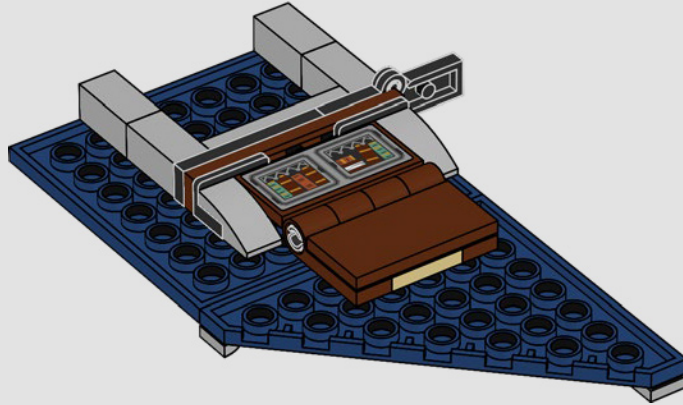

60

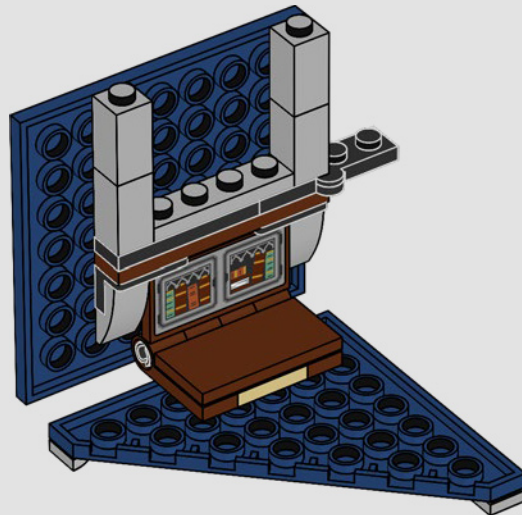

61

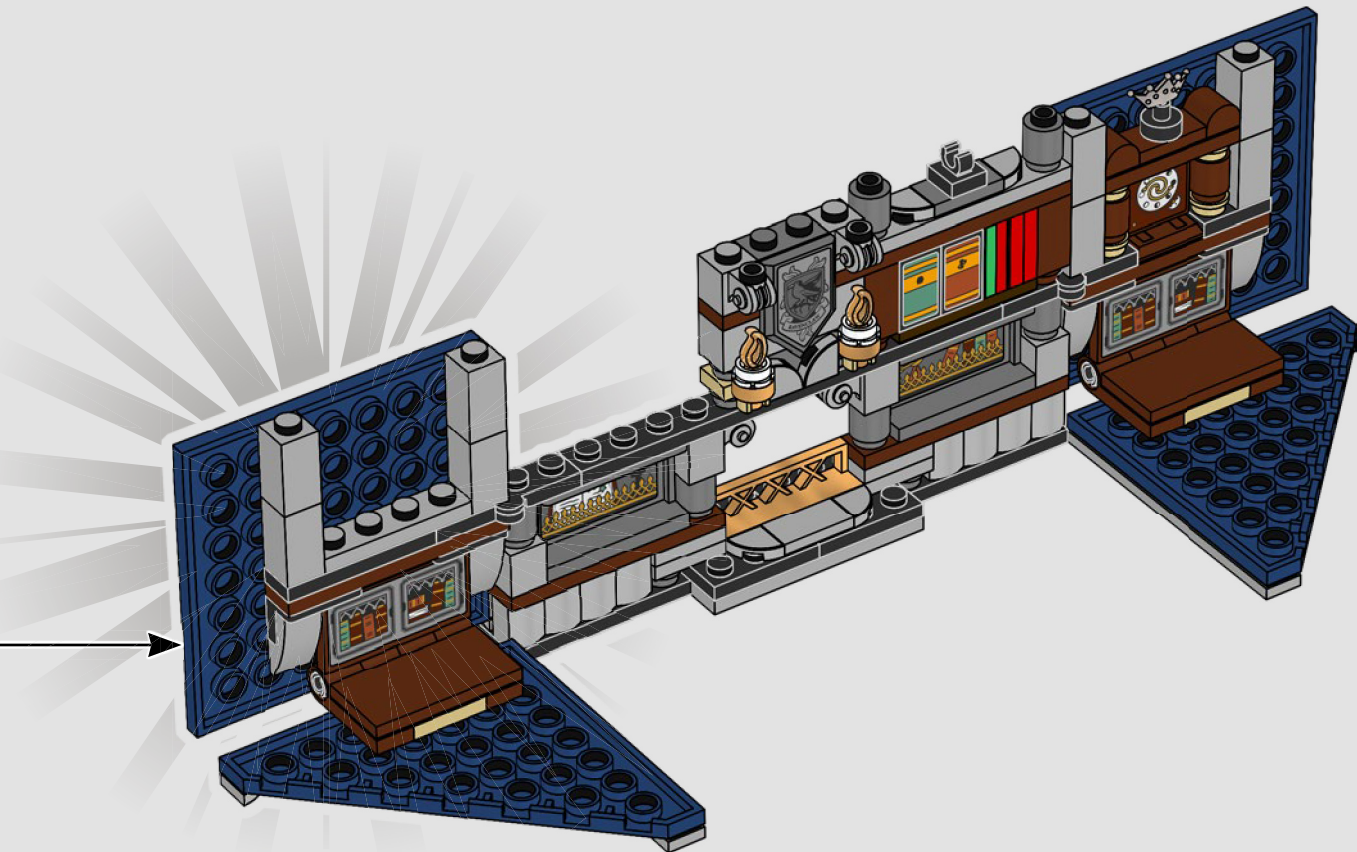

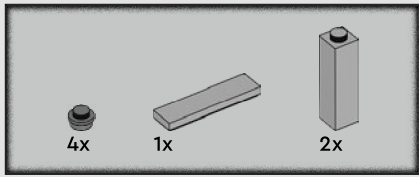

62

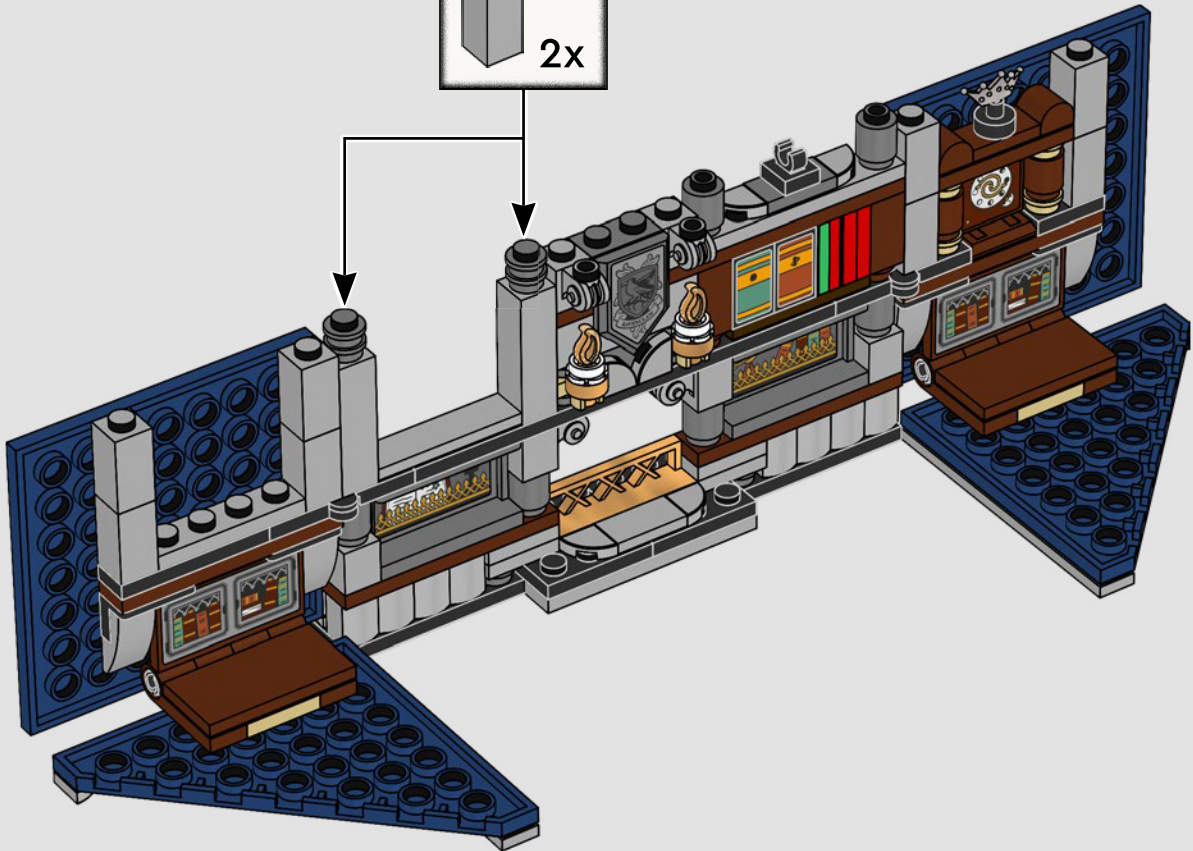
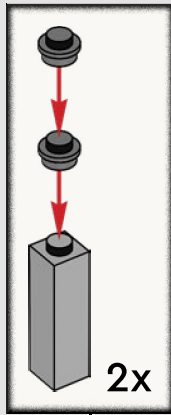

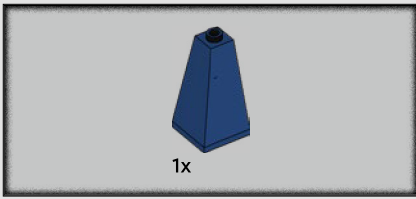

63

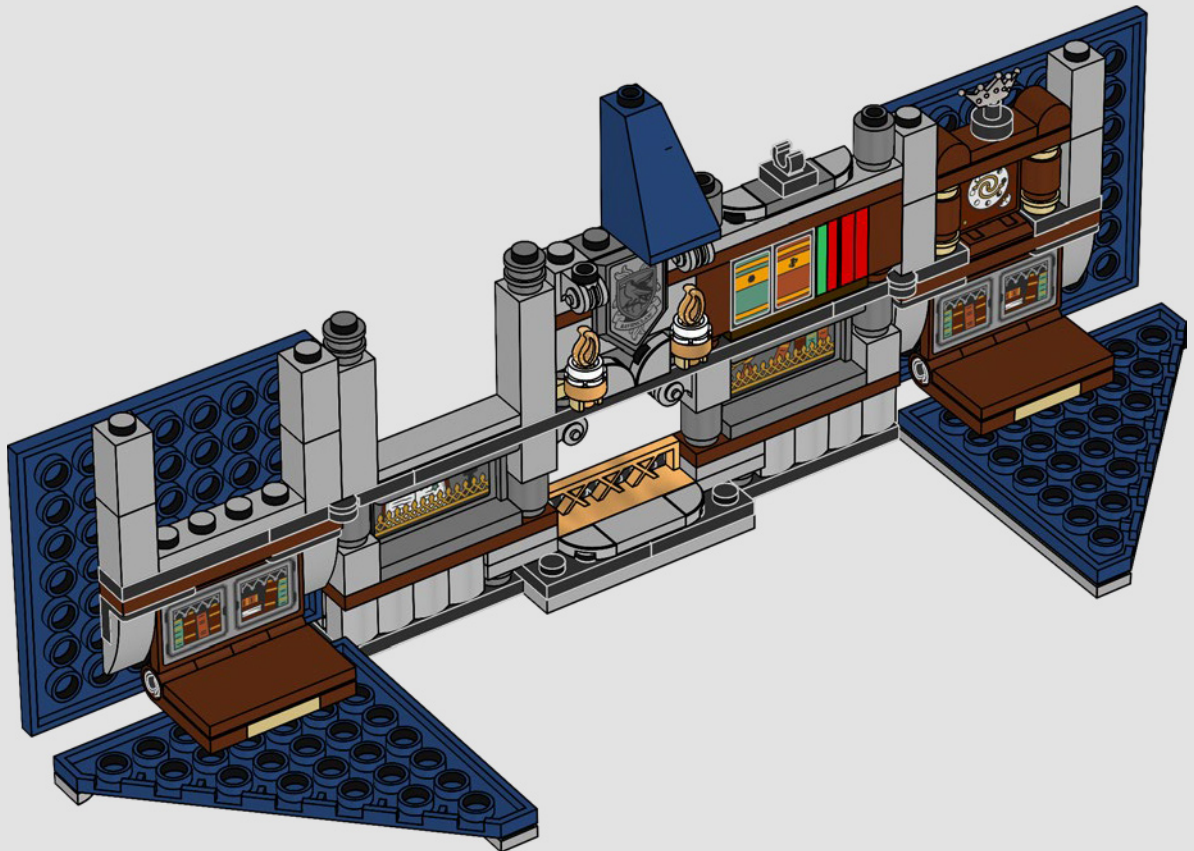

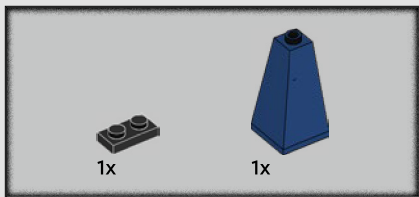

64

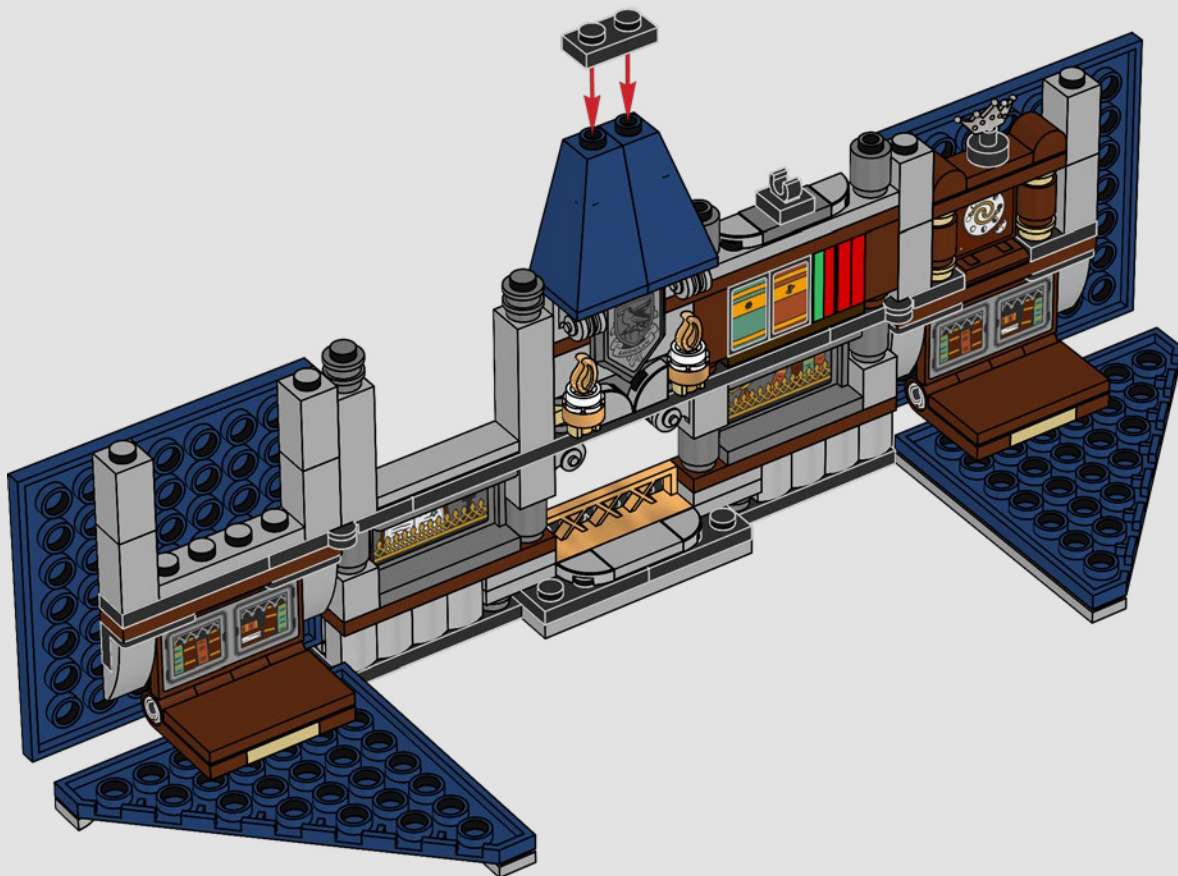

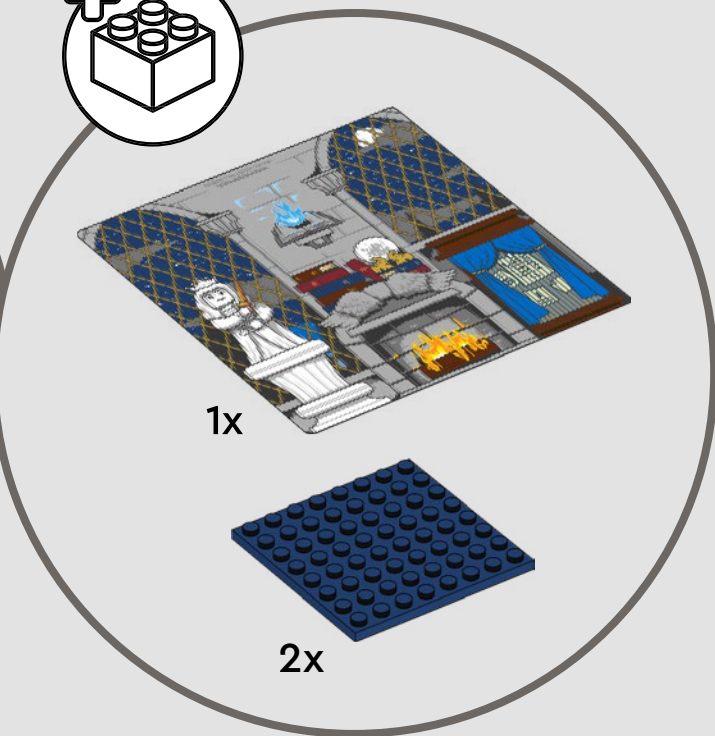
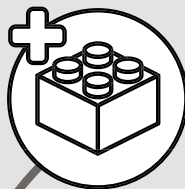

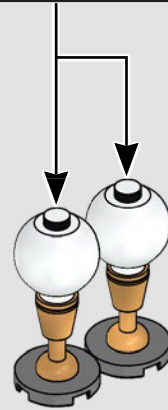
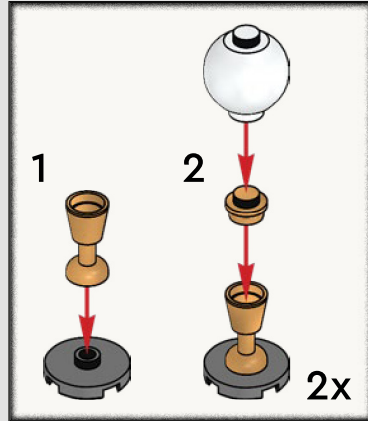
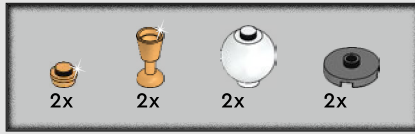
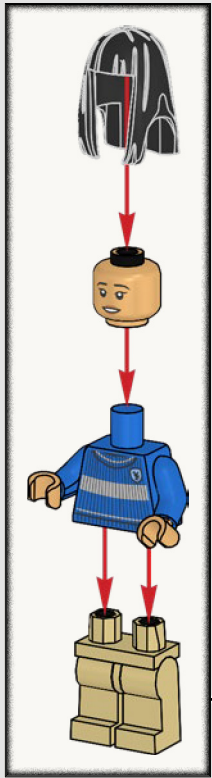

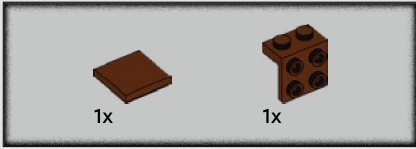

1

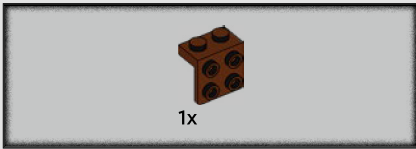
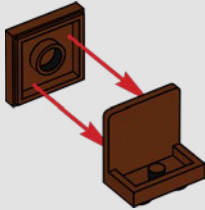

2

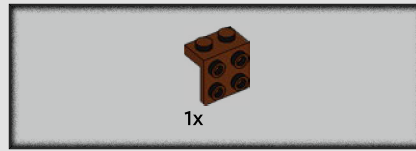

3

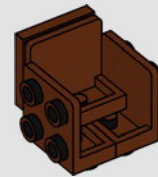

4

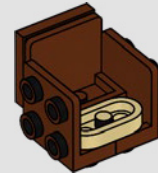

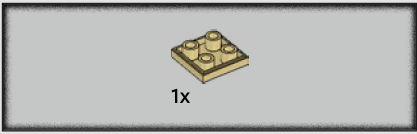

5



6

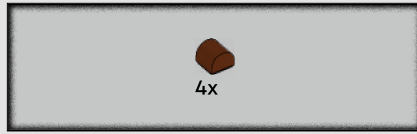
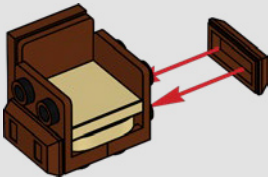

7

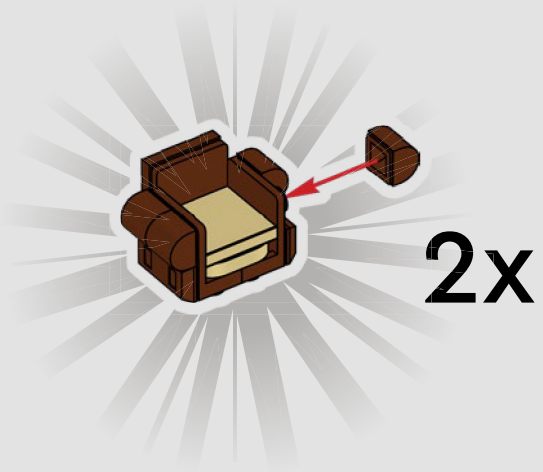

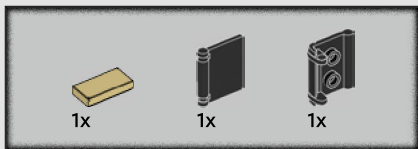

65

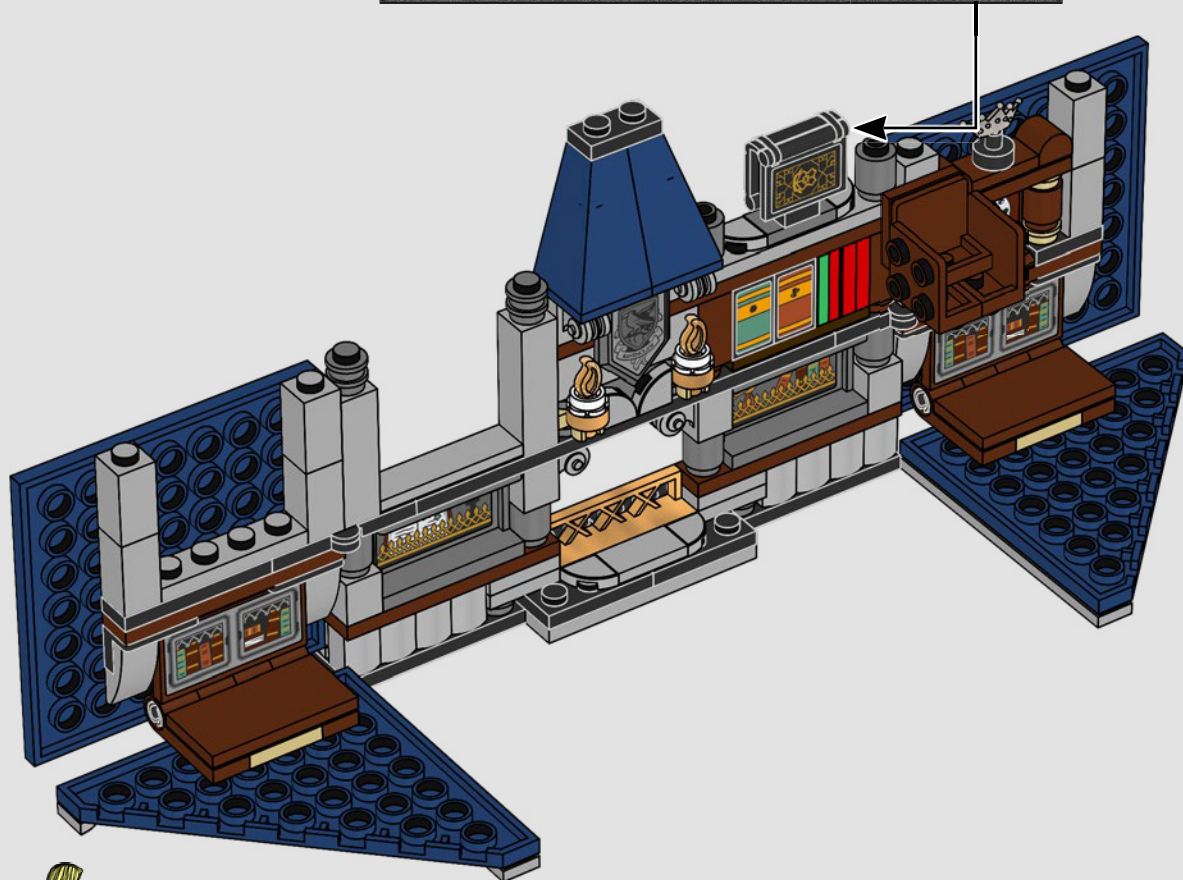
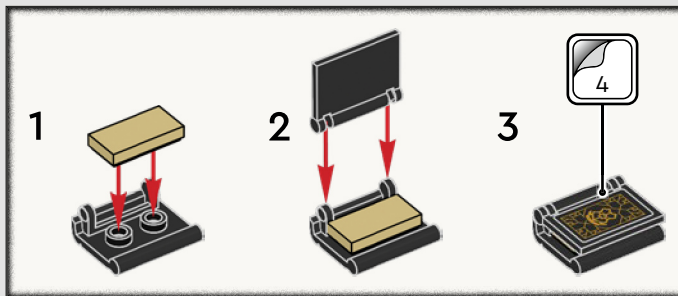

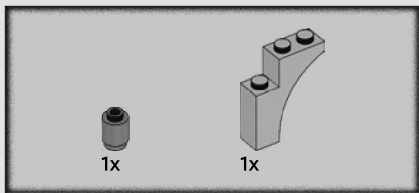

66

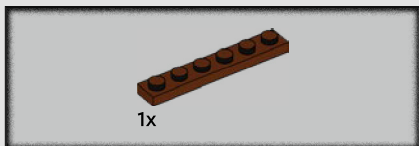
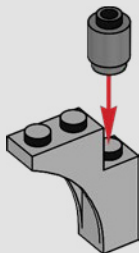

67

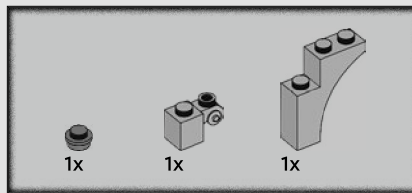
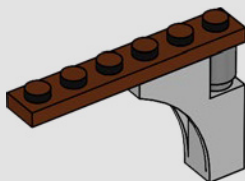

68

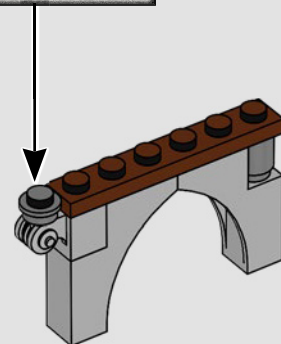
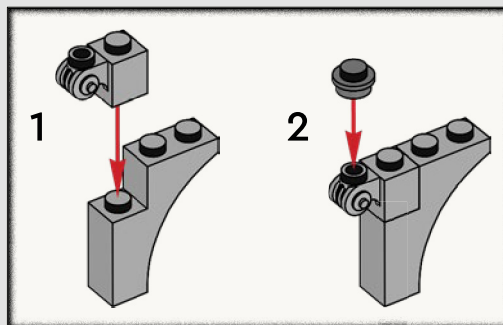

69

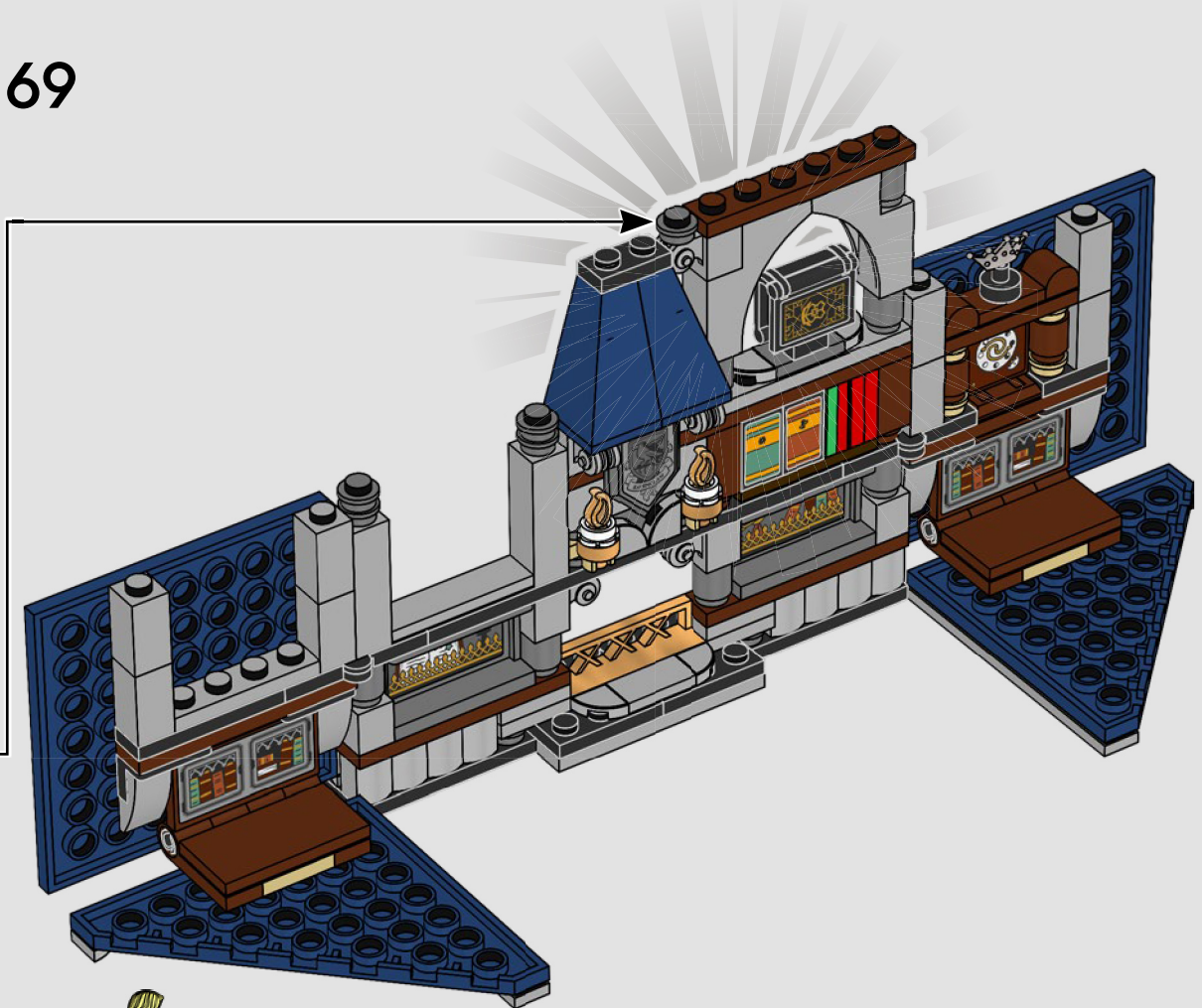

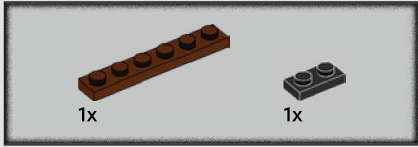
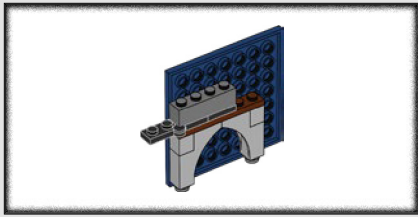

70

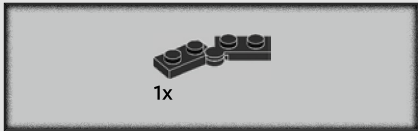
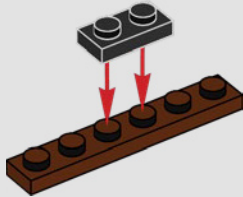

71

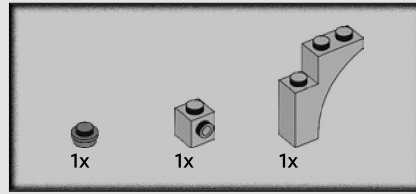
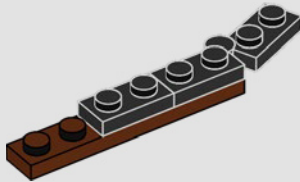

72

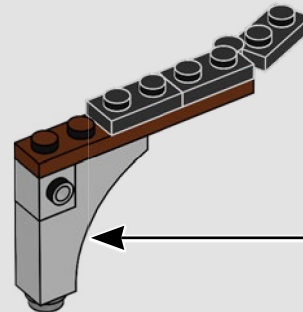
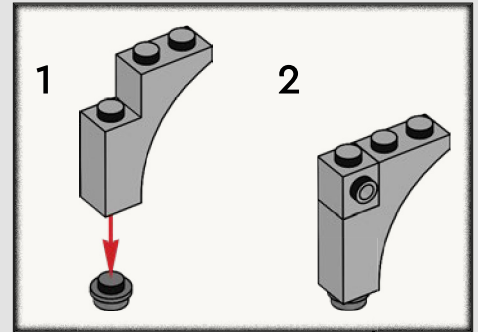

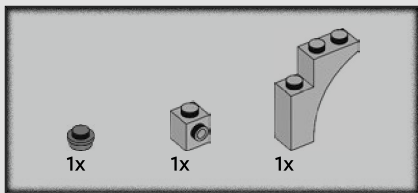

73

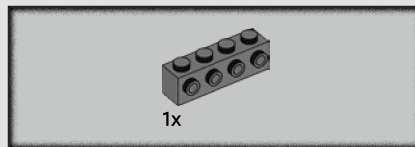
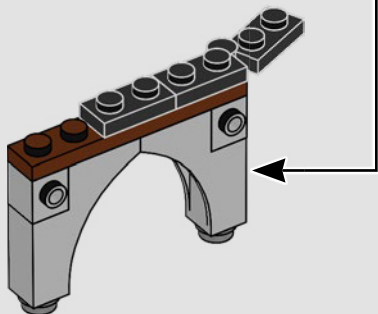
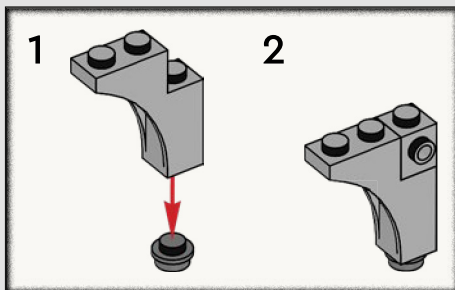

74

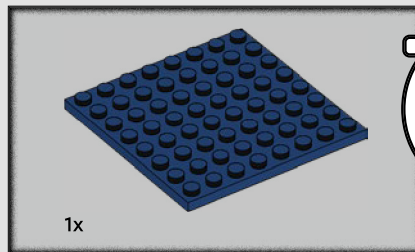
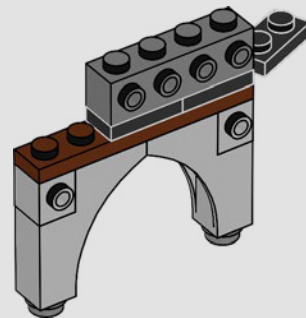

75

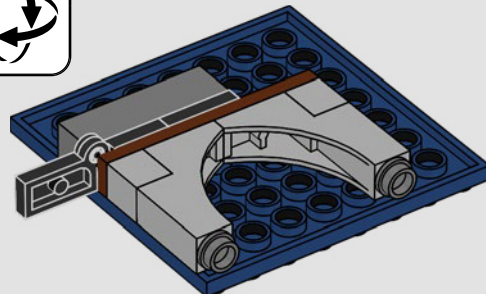

76

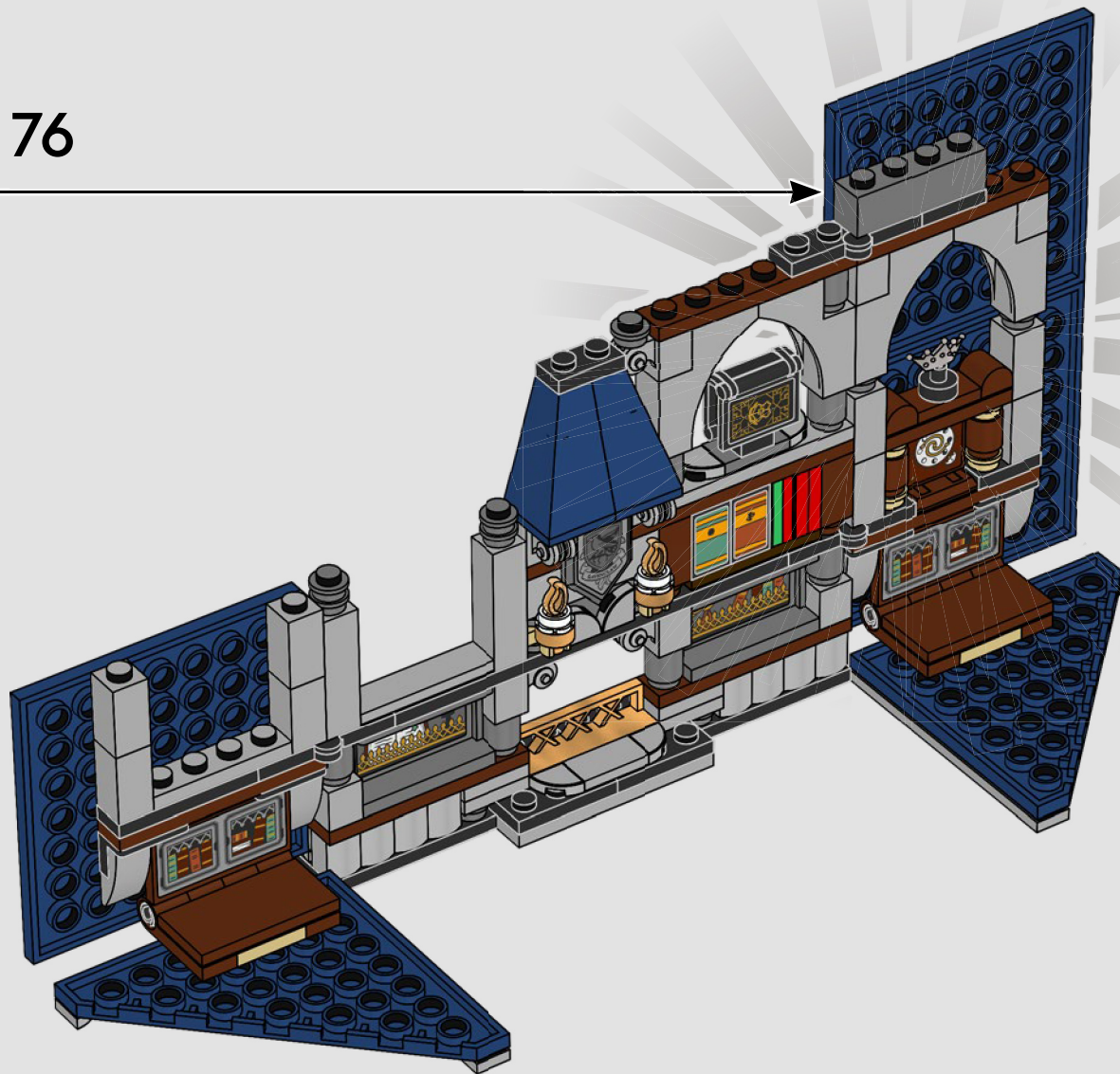

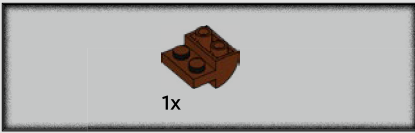

77

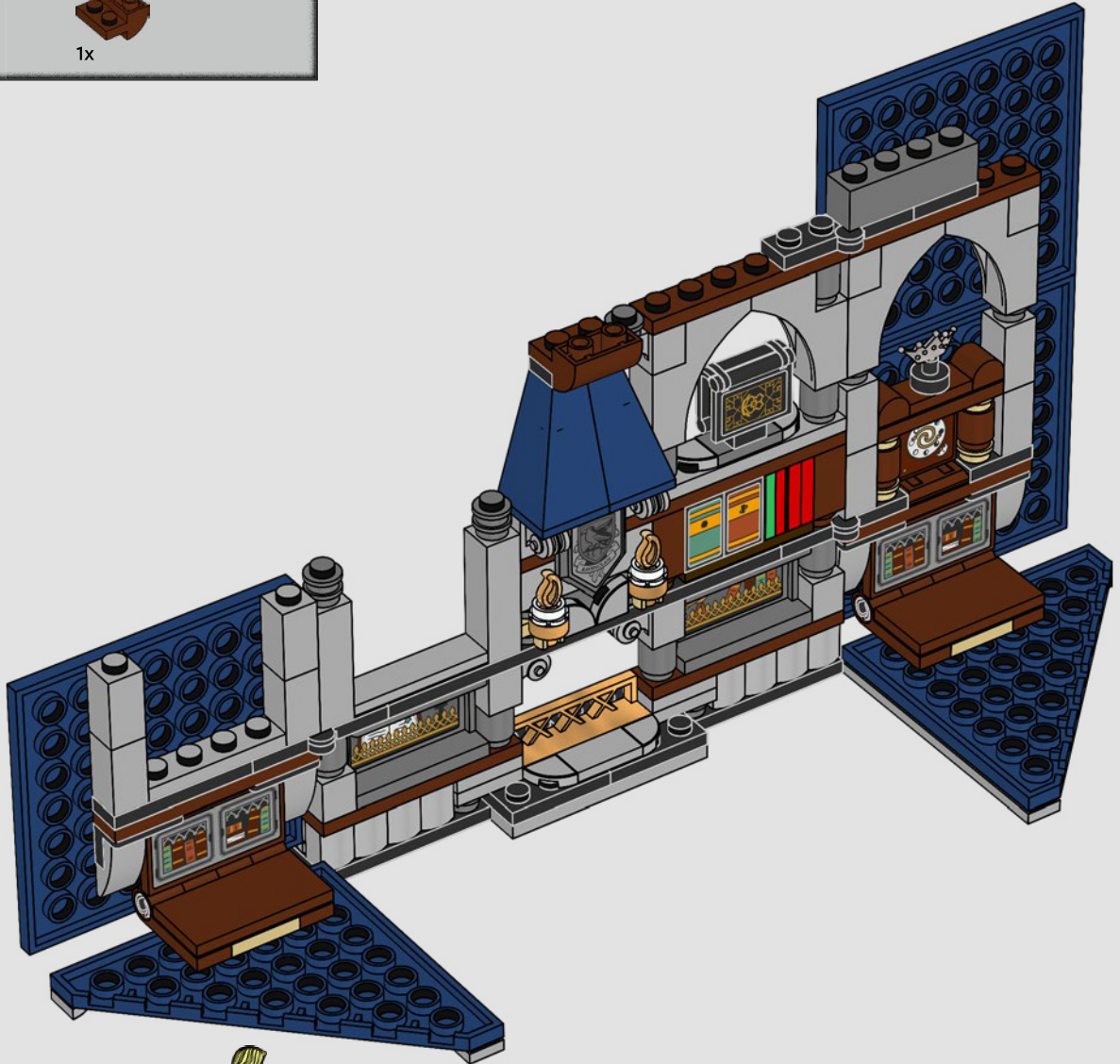

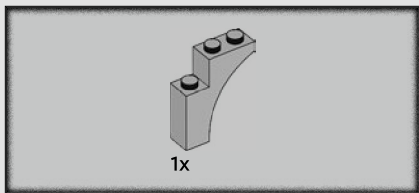

78

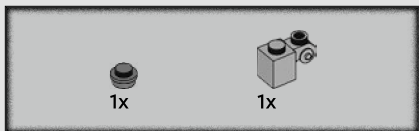
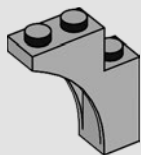

79

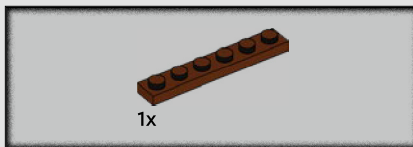
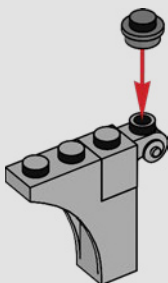

80

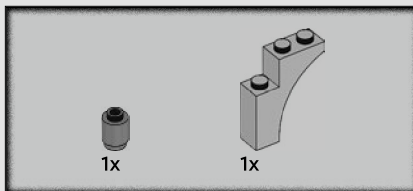
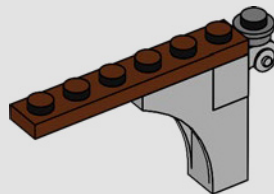

81

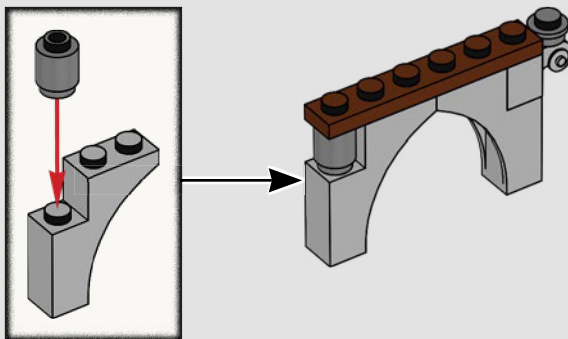

82

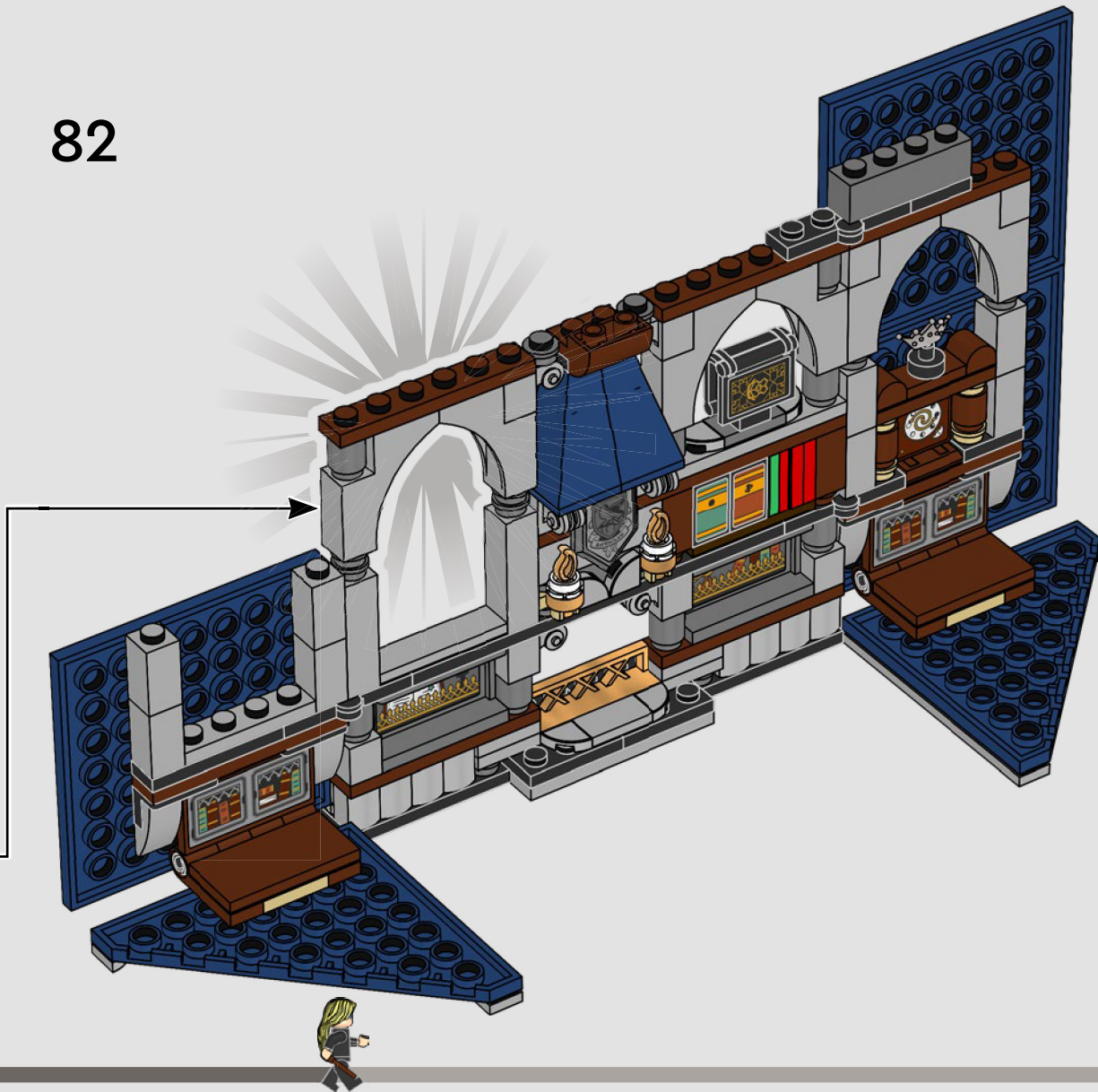

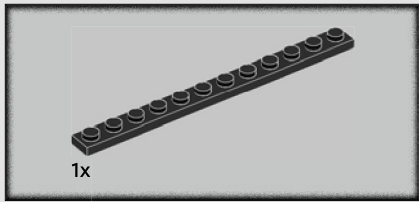

83

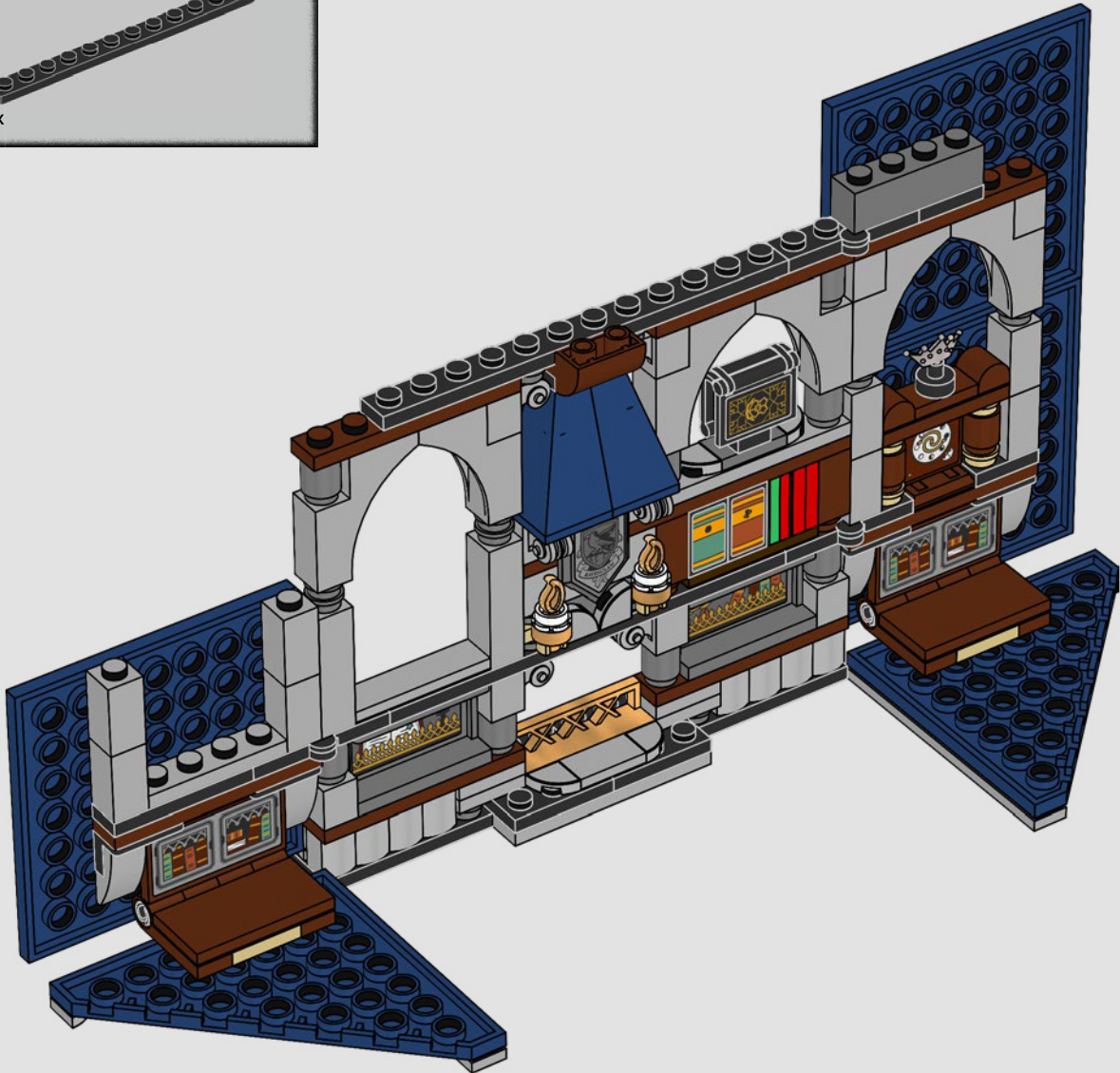

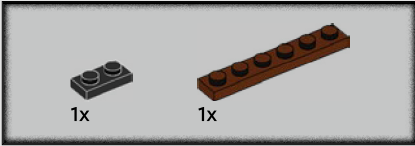
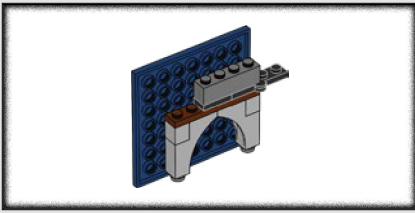

84

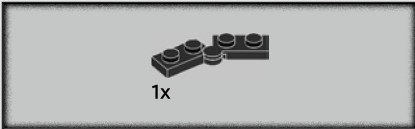
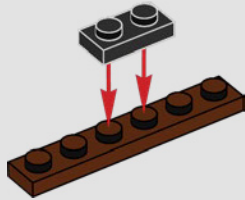

85

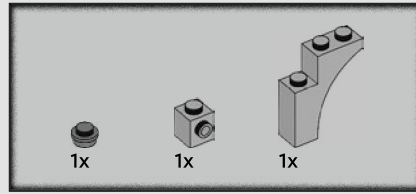
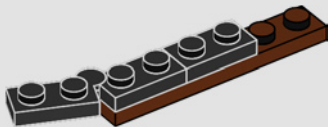

86

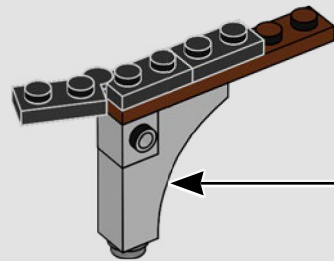
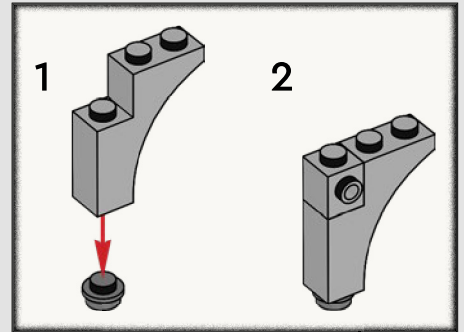

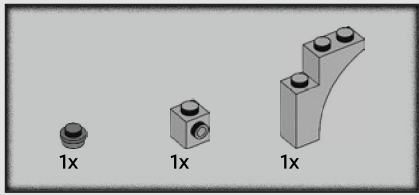

87

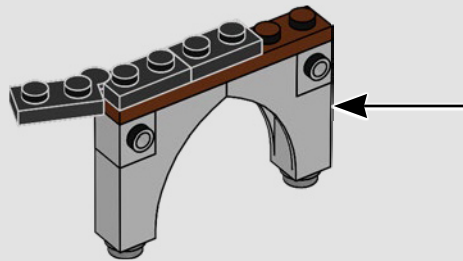
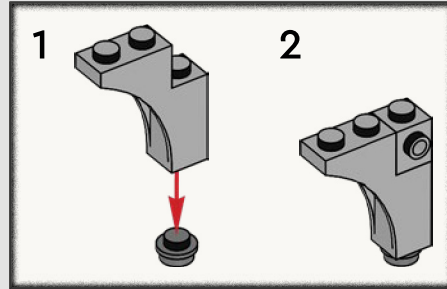

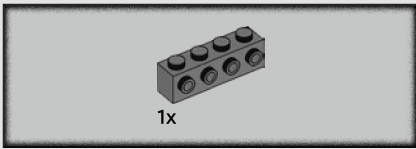

88

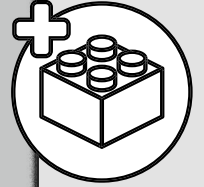
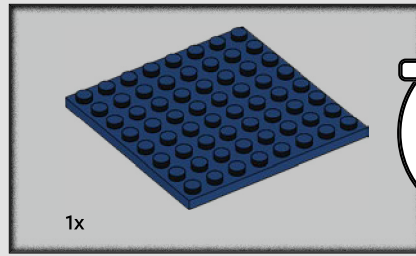
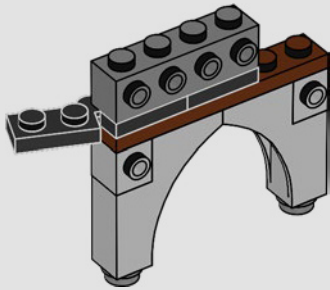

89

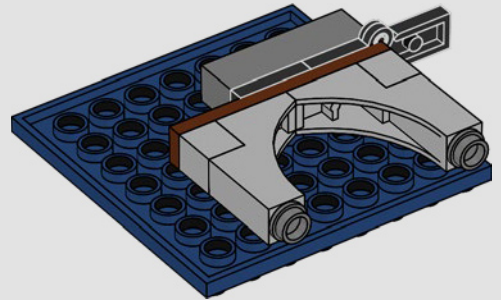
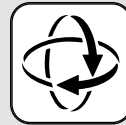

90

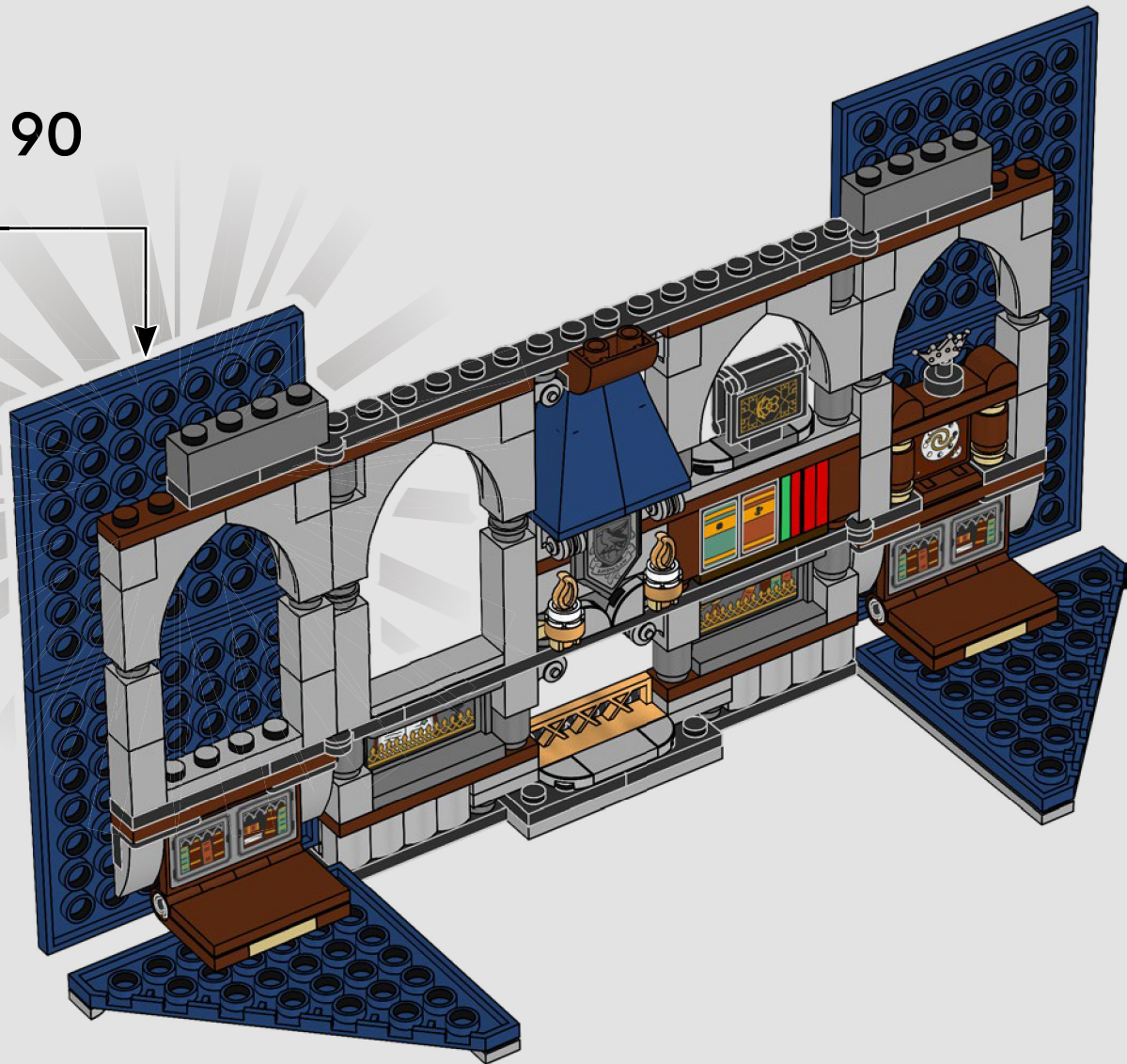

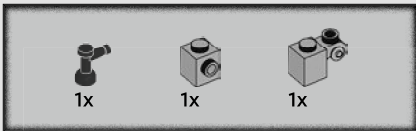

91

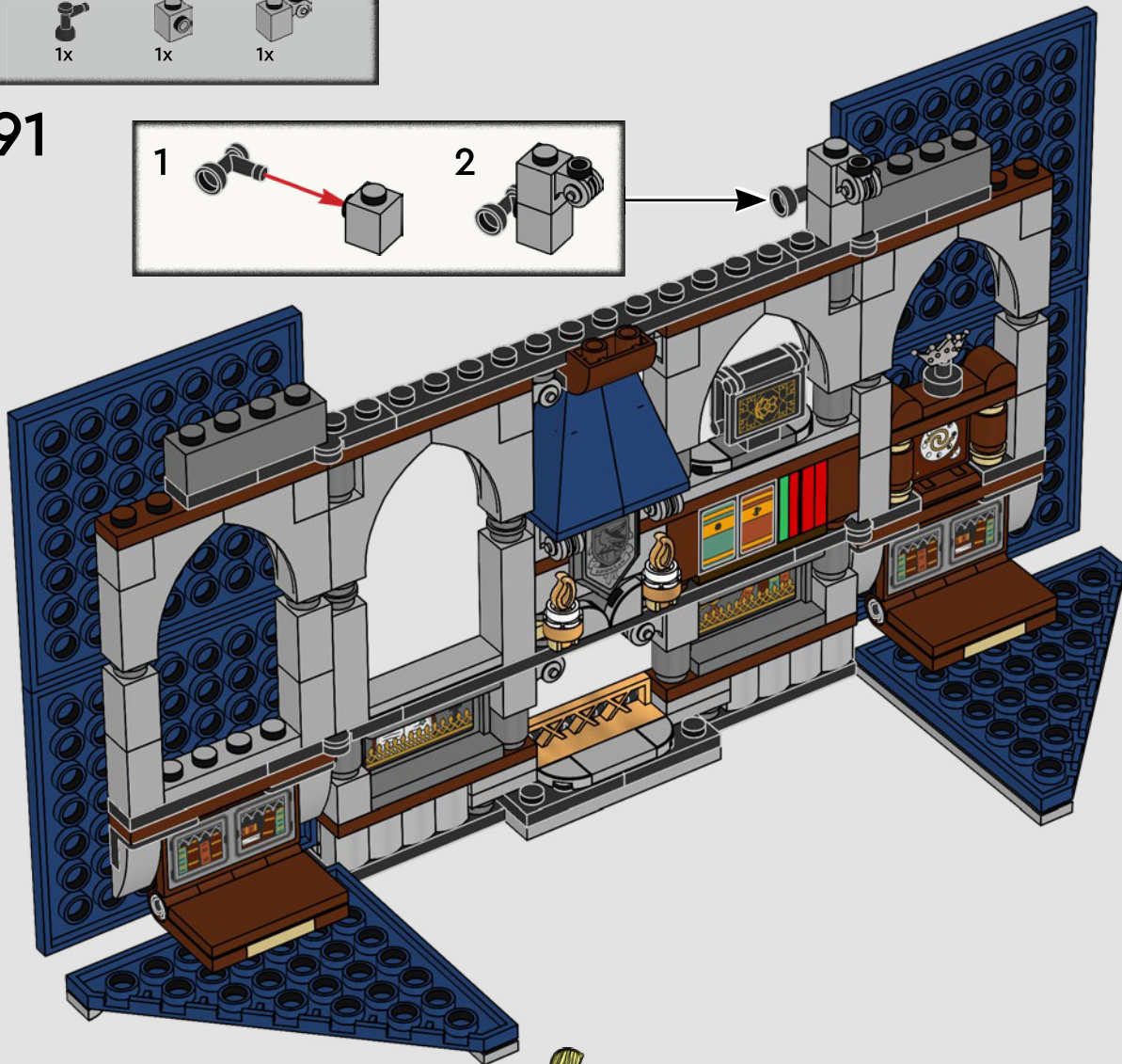
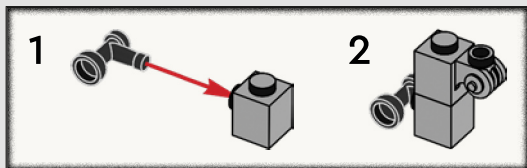

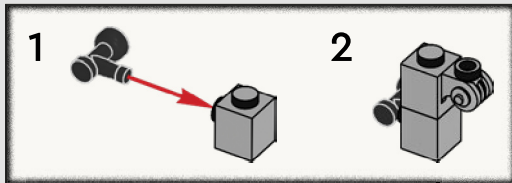
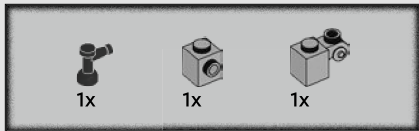

92

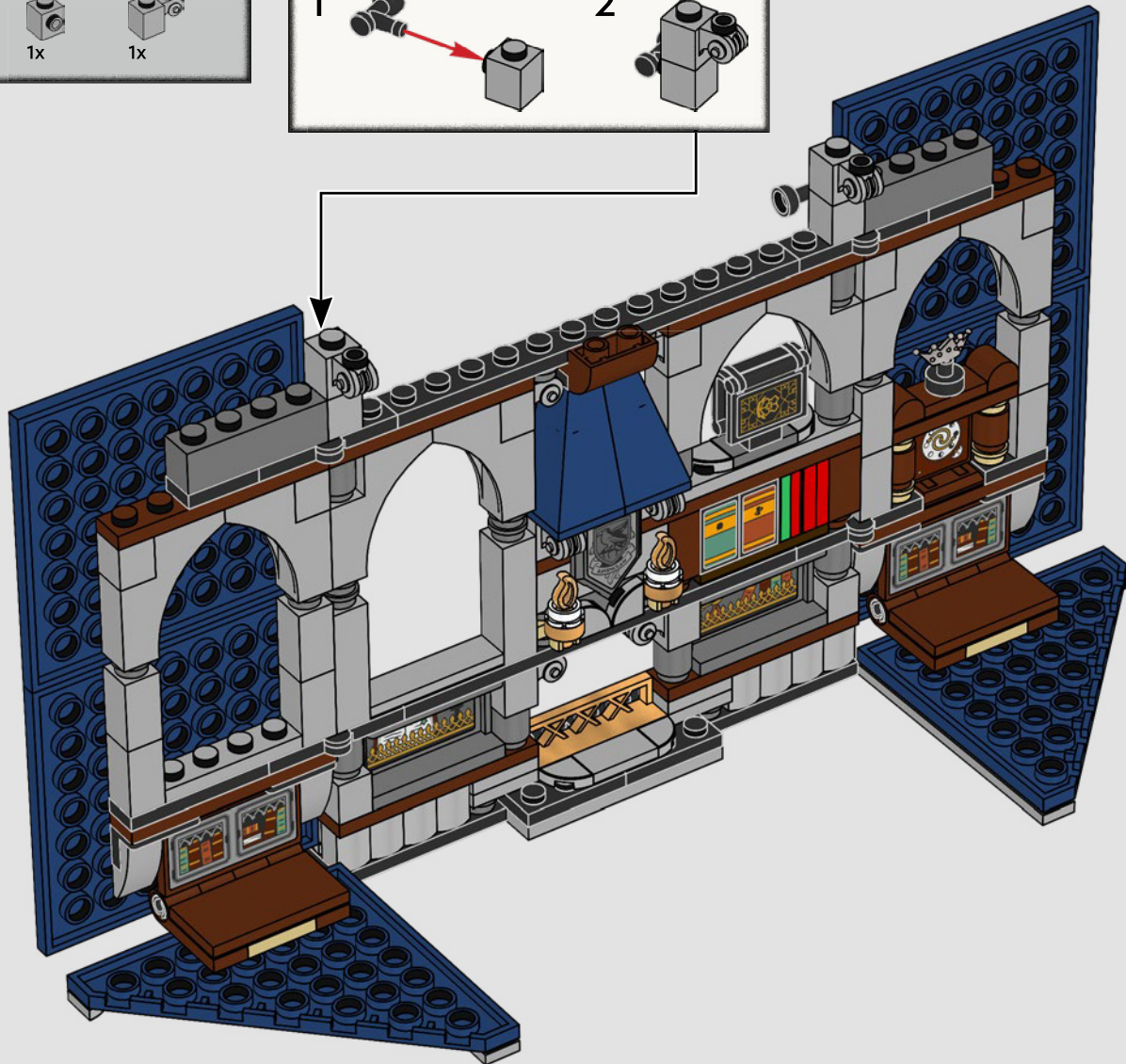

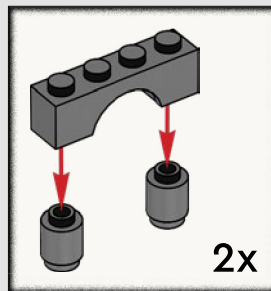
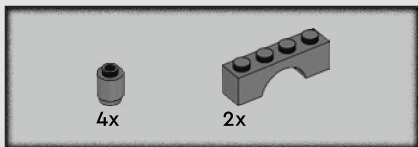

93

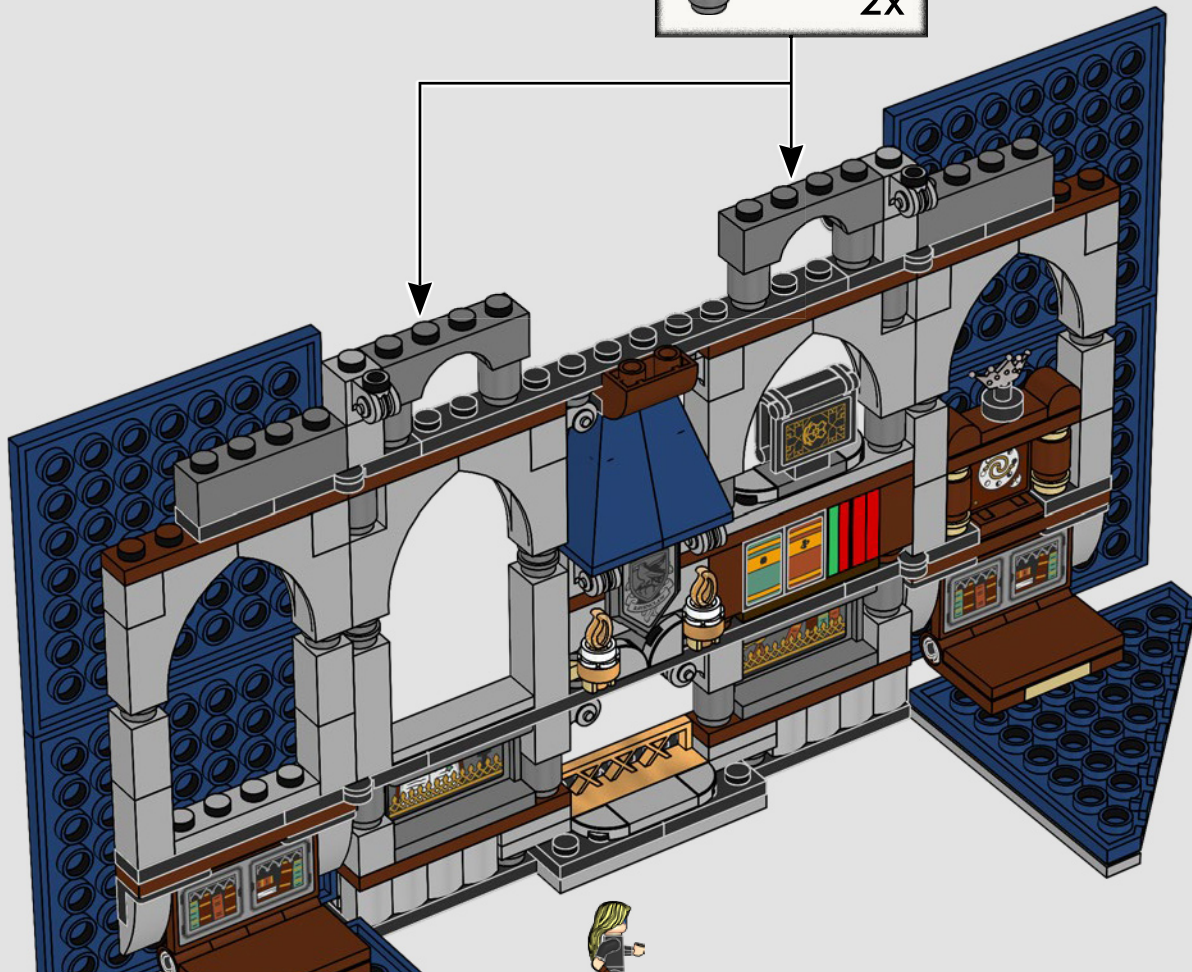

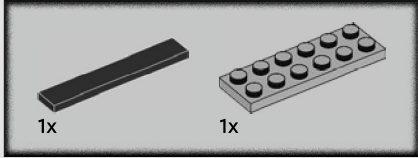

94

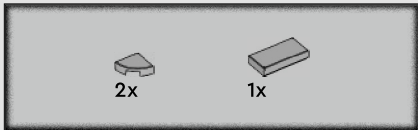
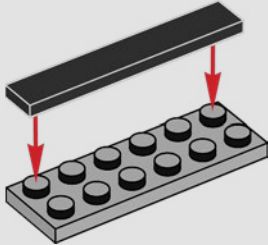

95

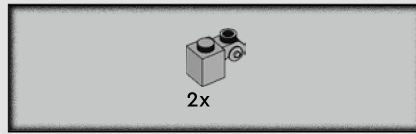
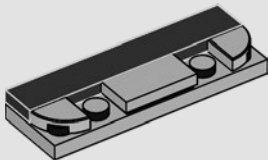

96

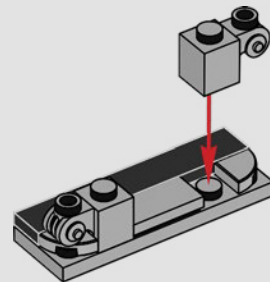

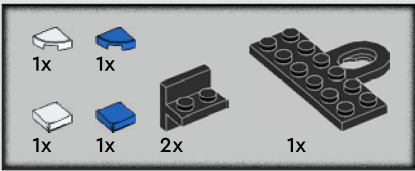

97

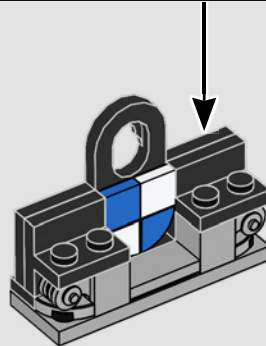
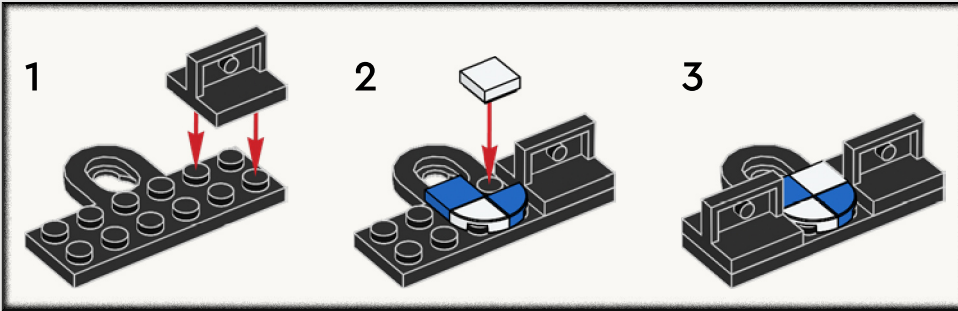

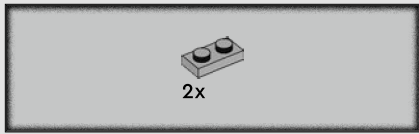

98

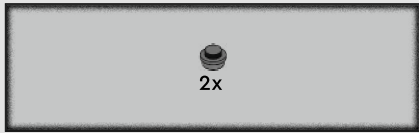
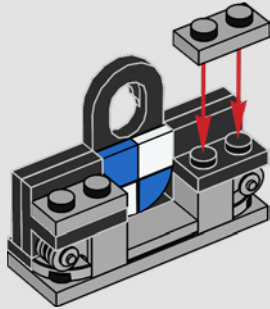

99

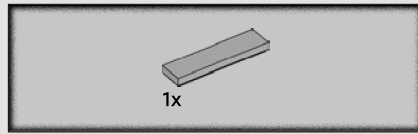
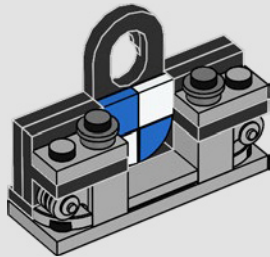

100

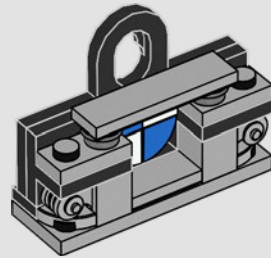

101

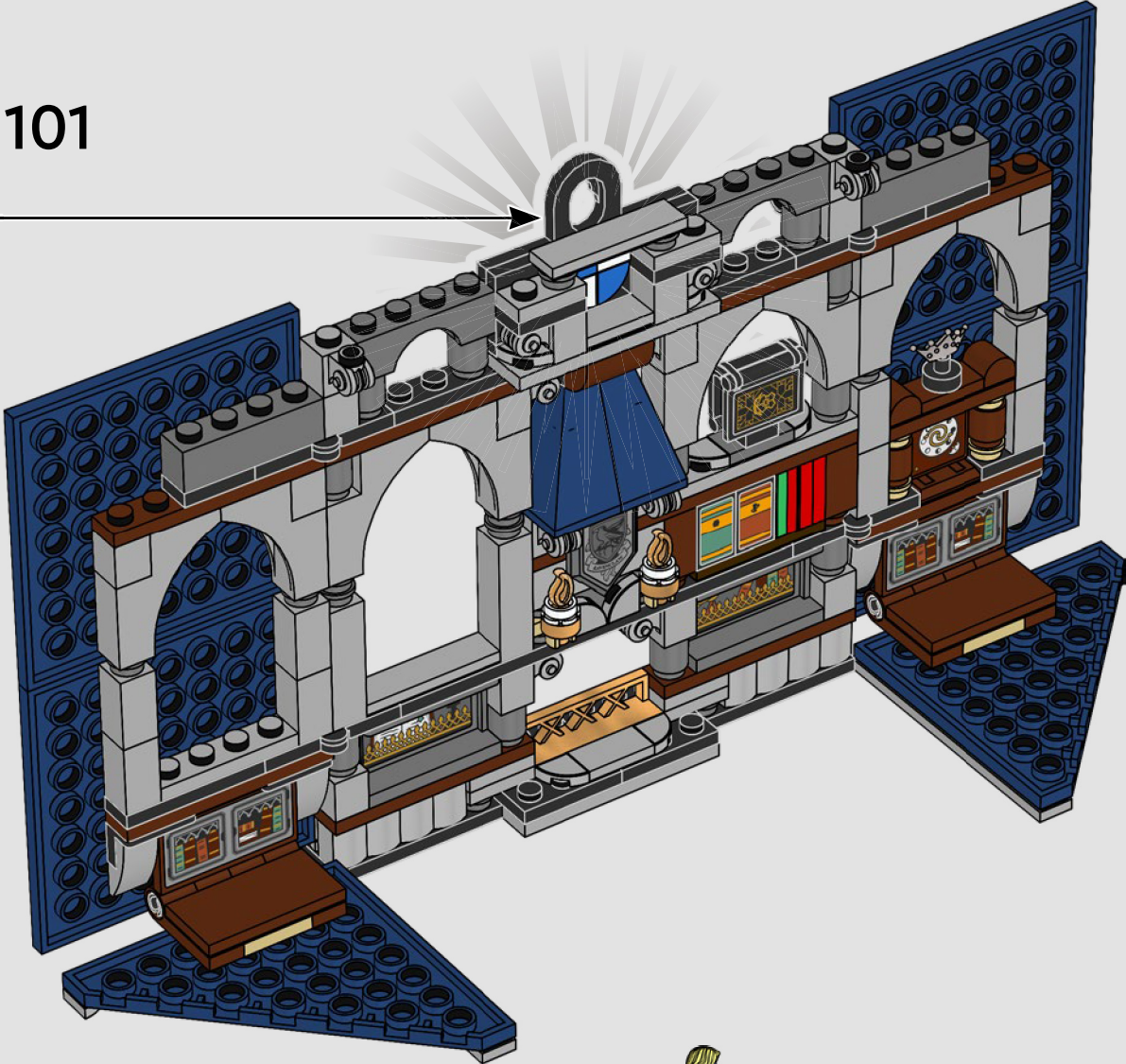

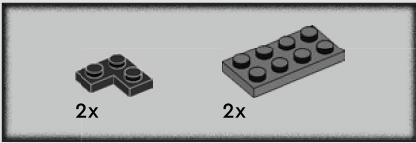

102

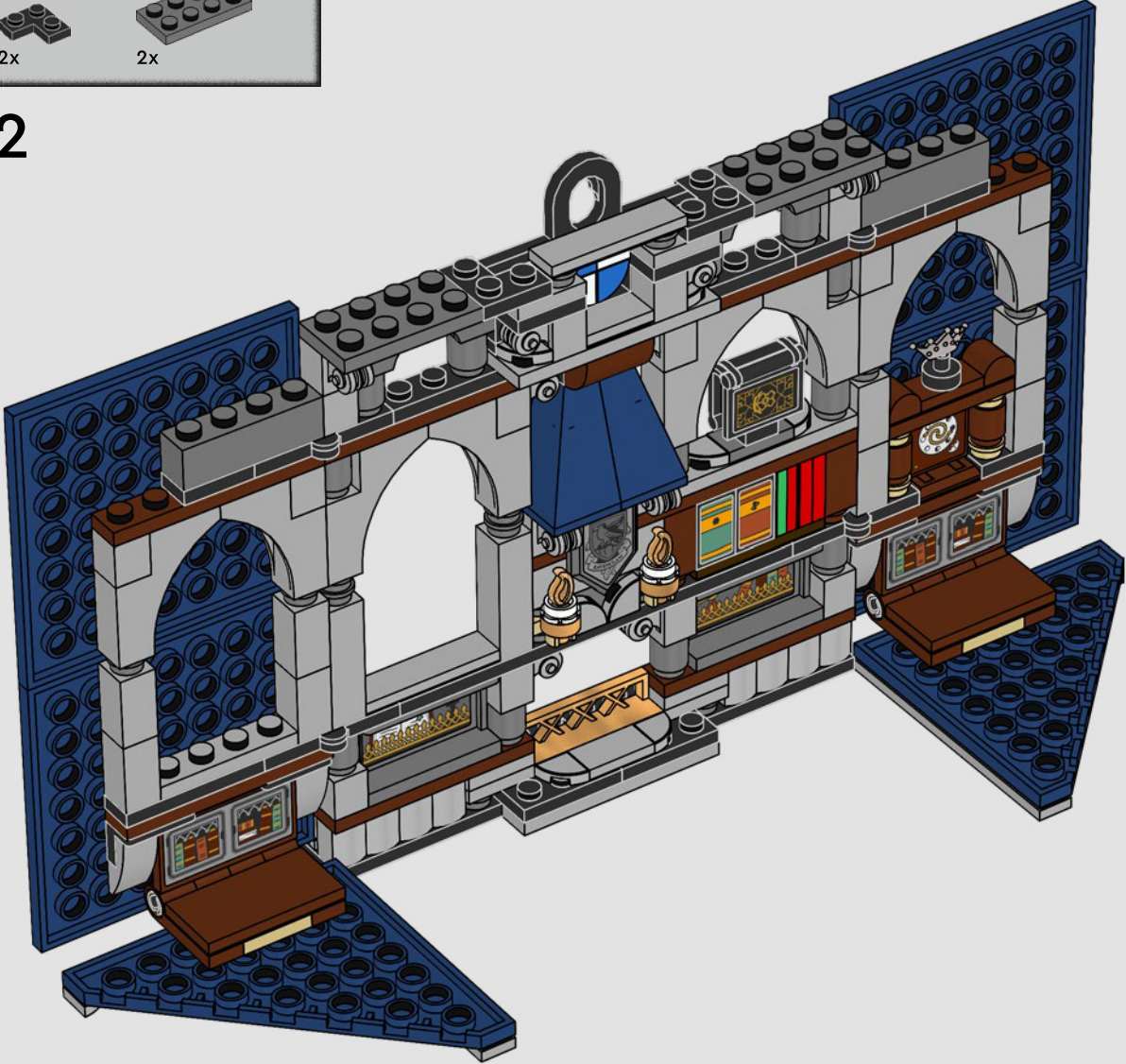

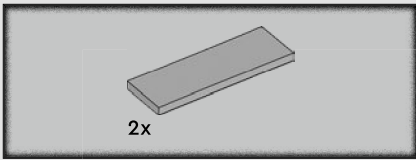

103

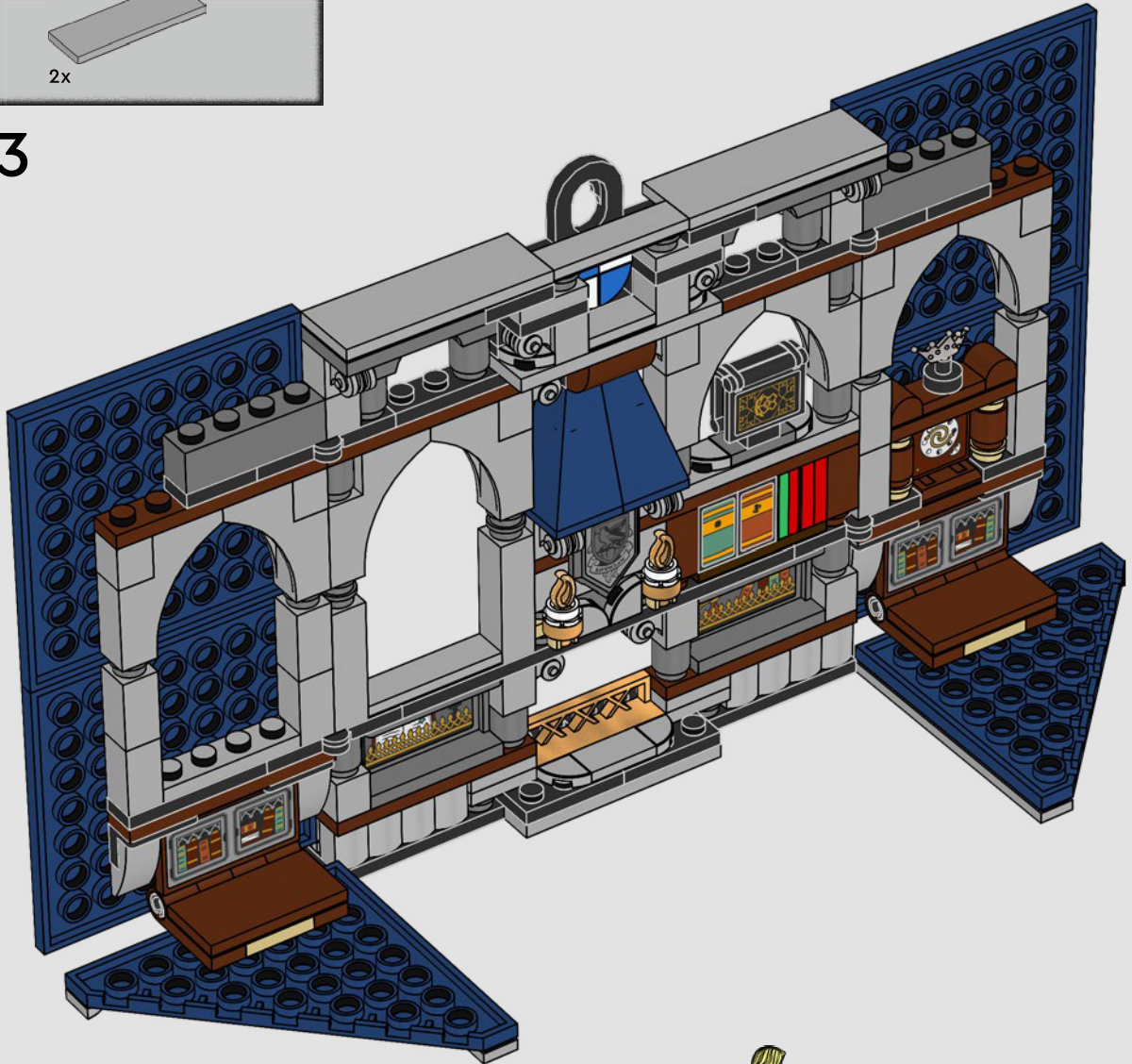

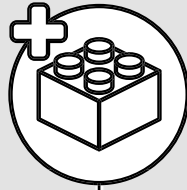
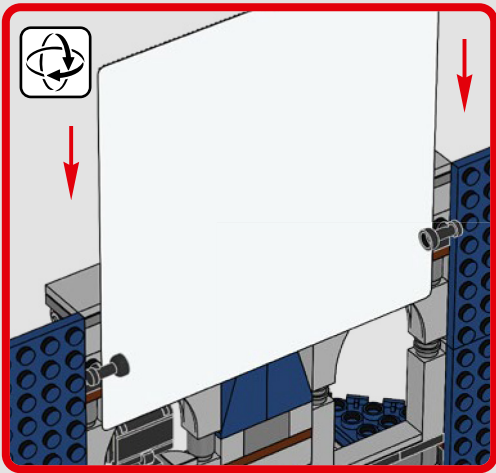

104

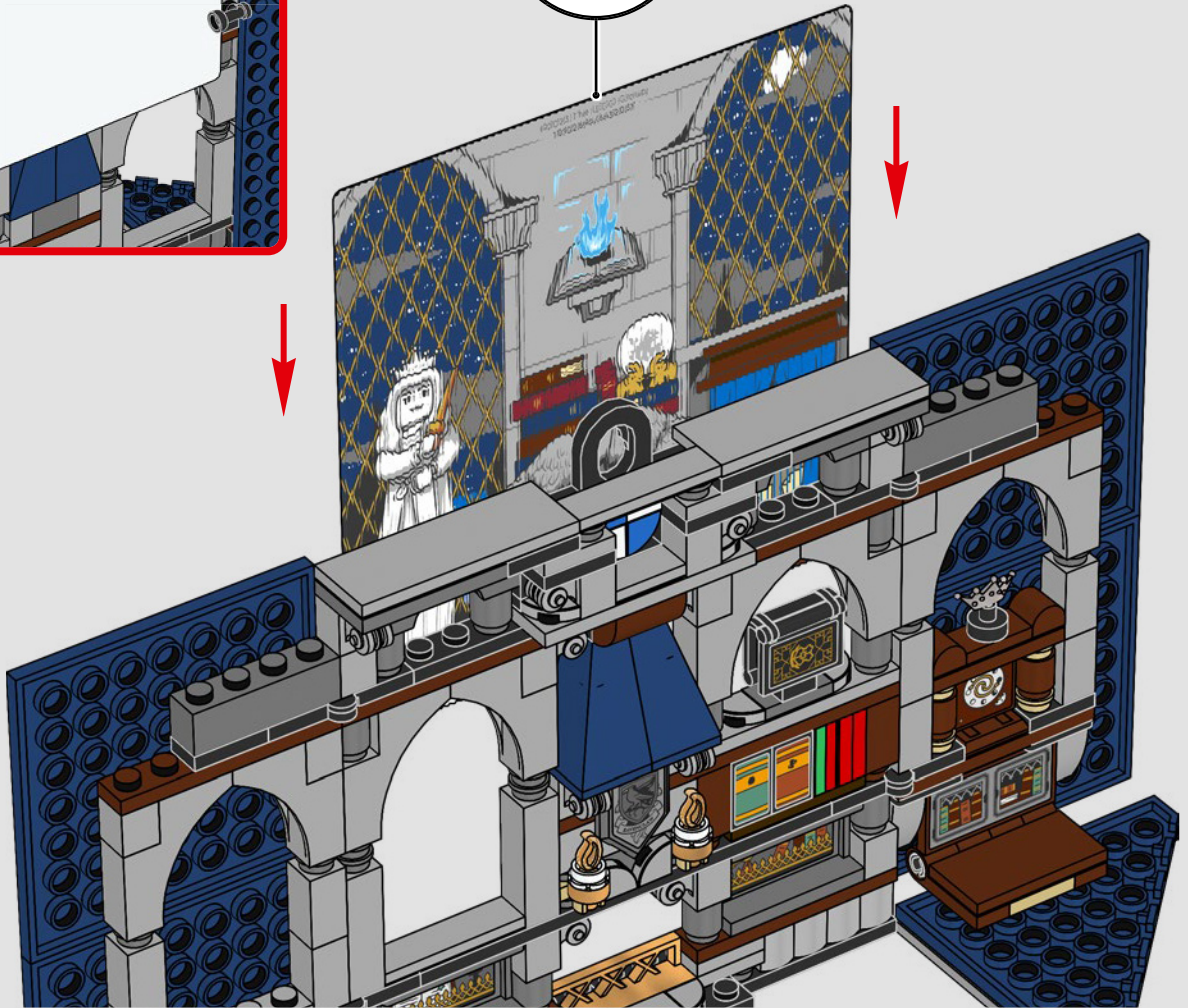

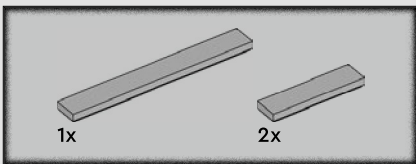

105

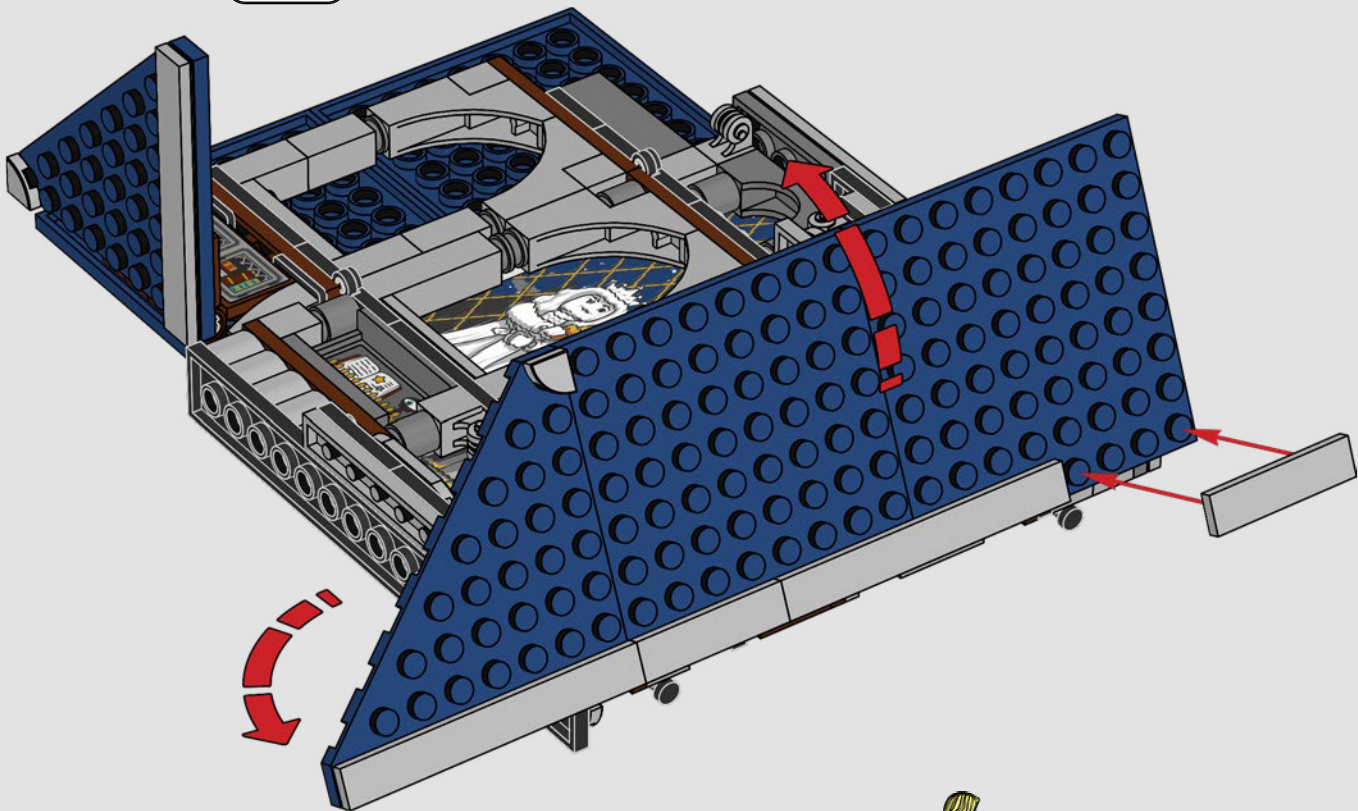

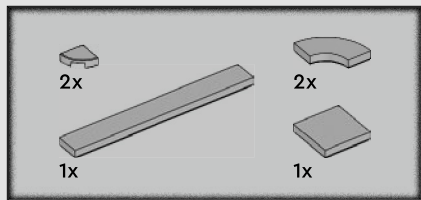

106

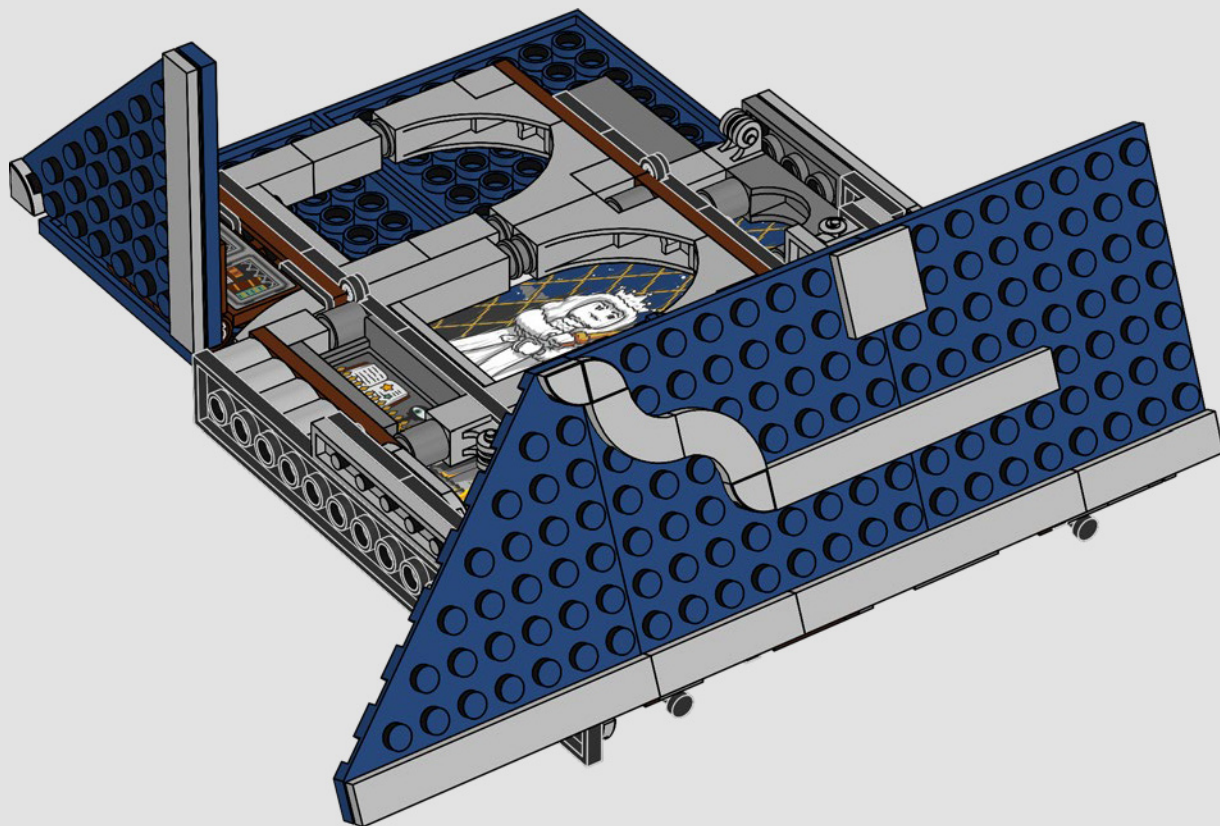

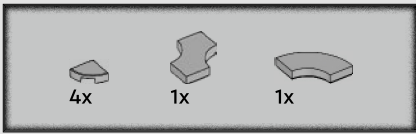

107

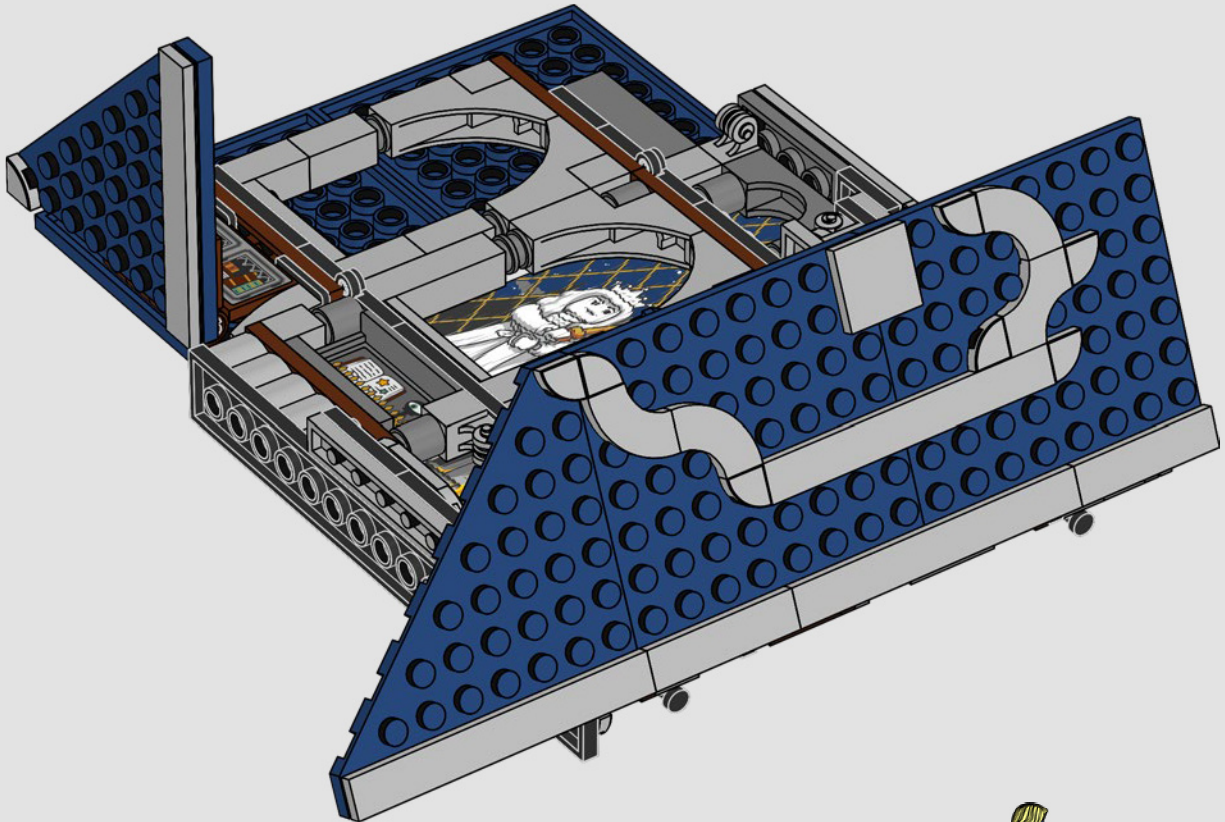

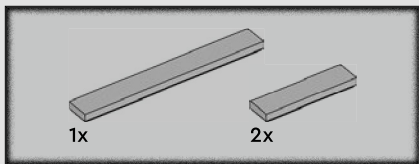

108

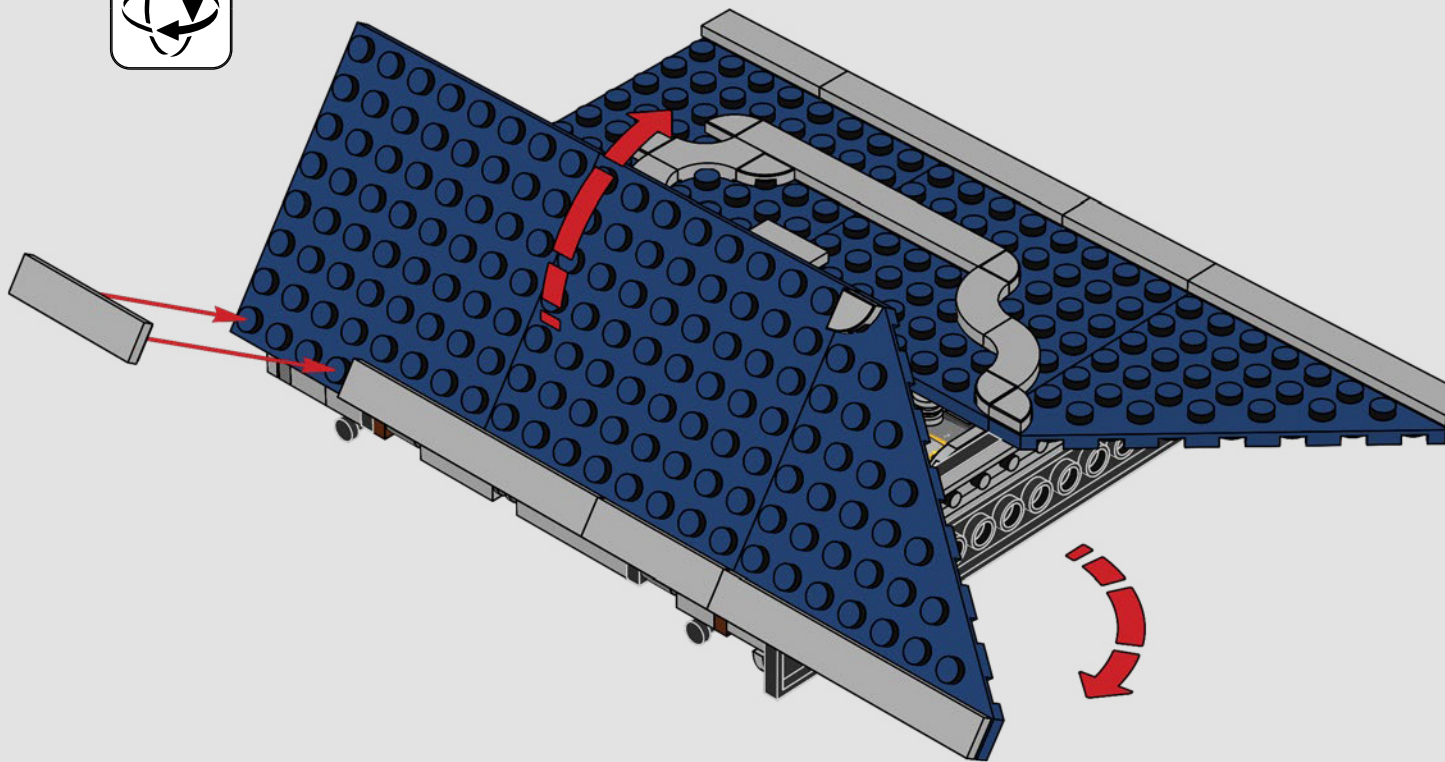

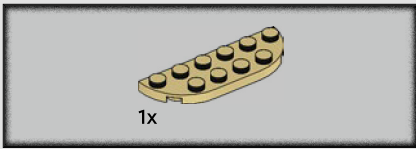

109

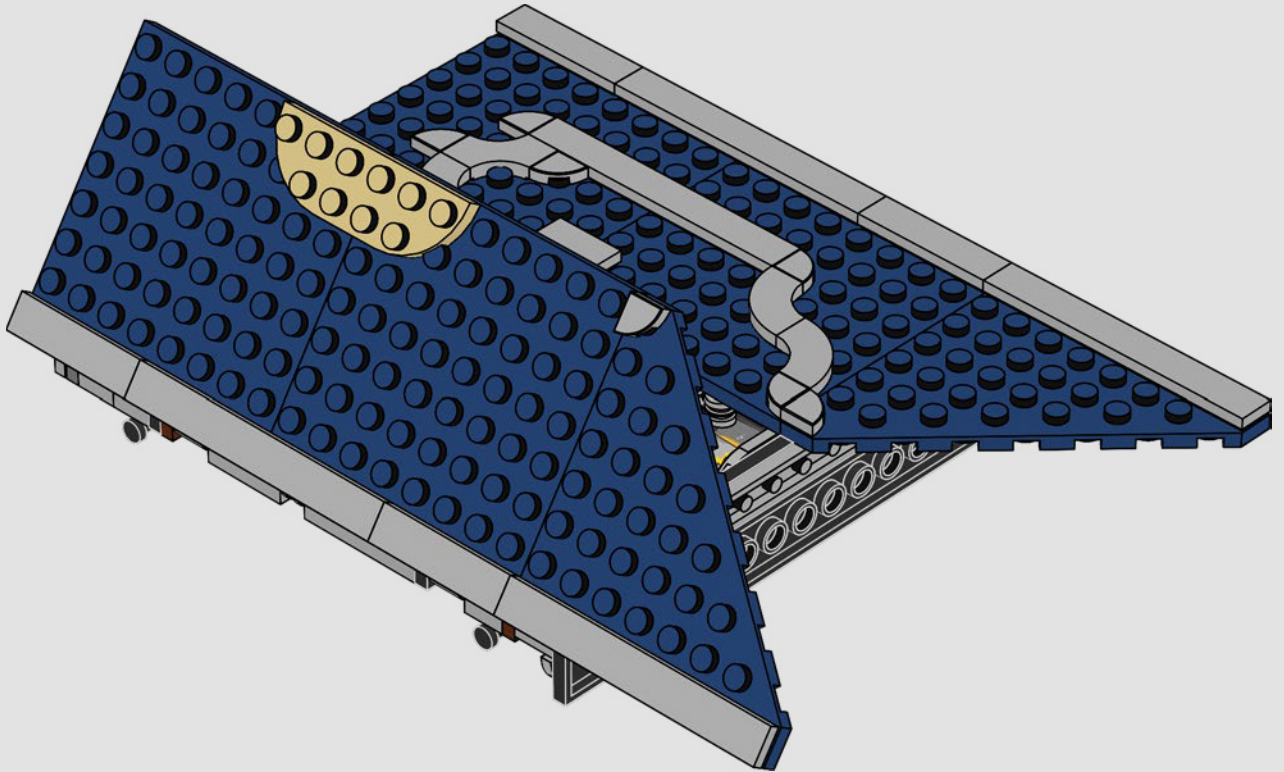

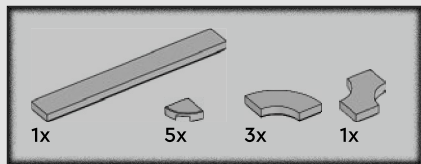

110

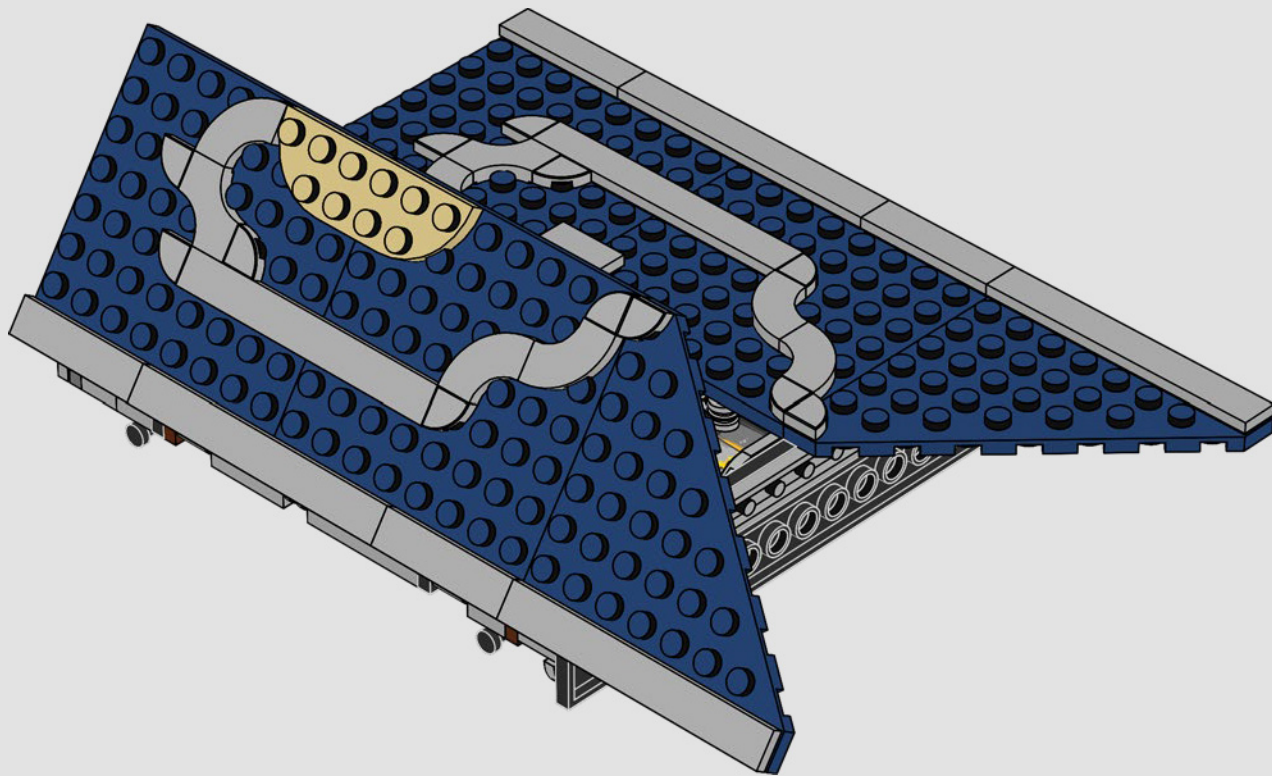

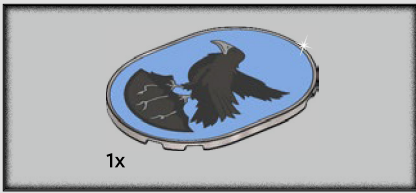

111

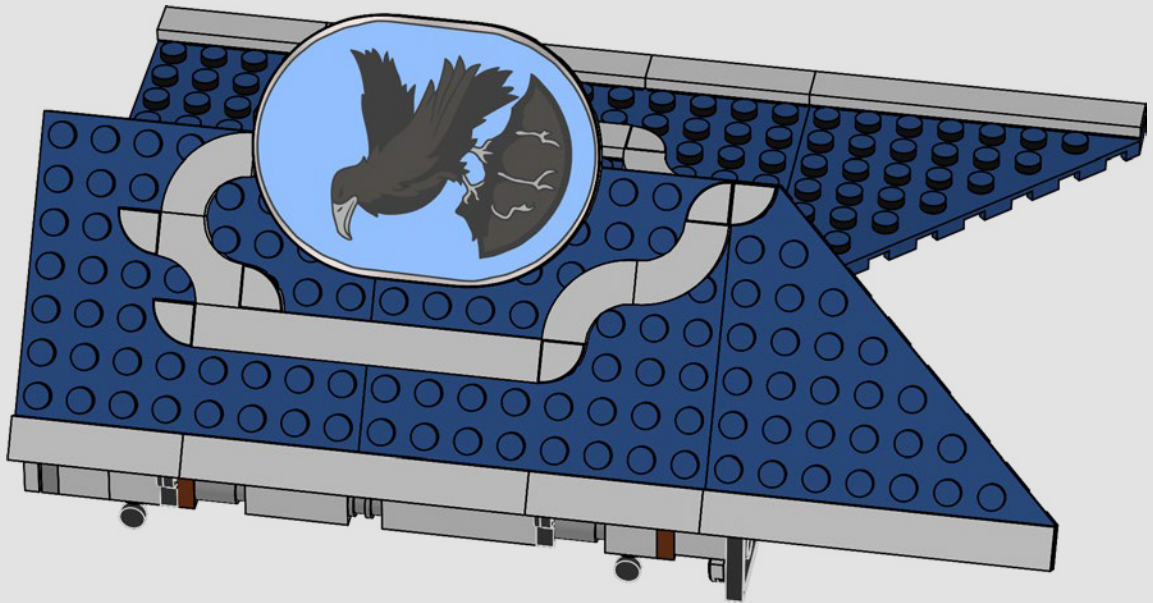

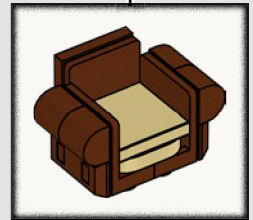
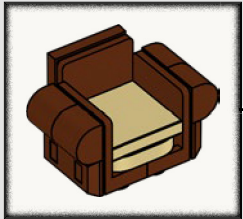
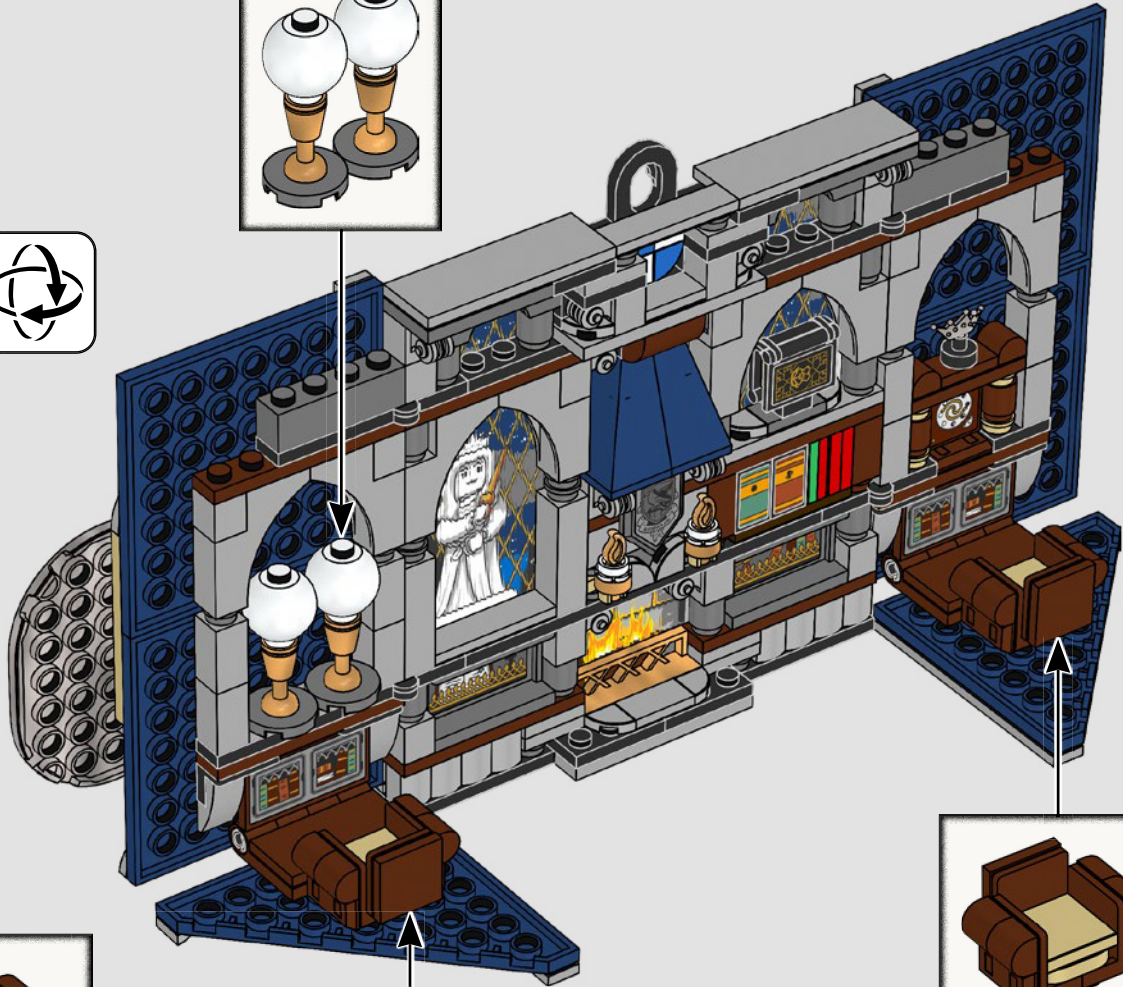
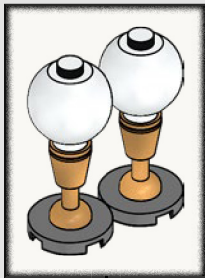

112

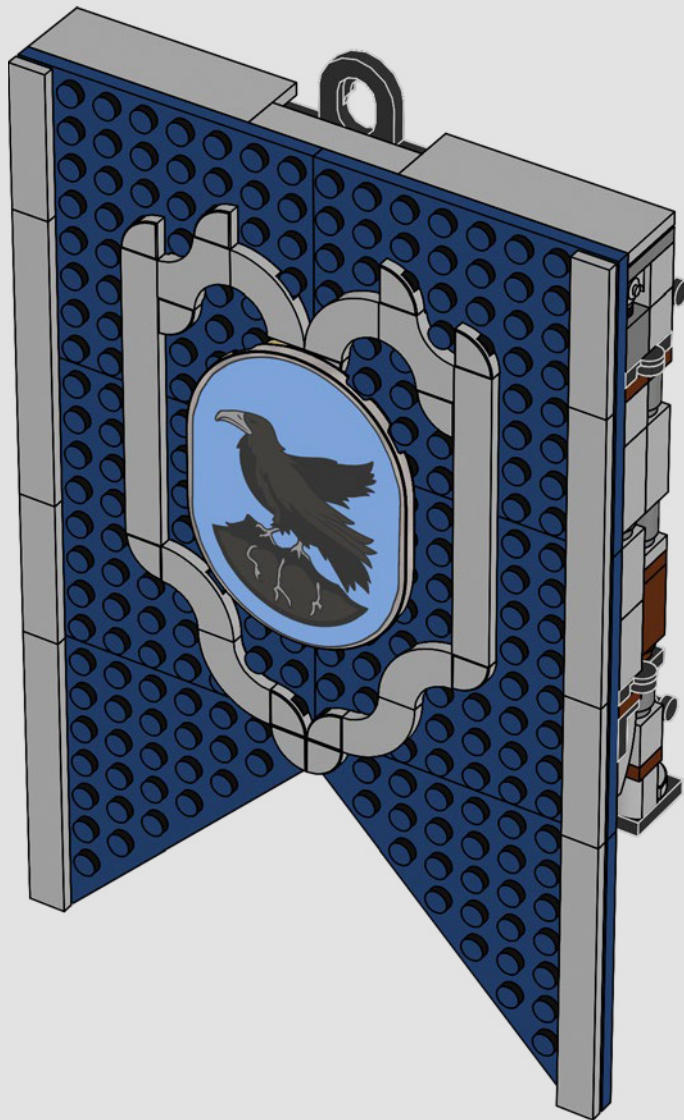







2x
6206149



1x
307001



1x
6172366



2x
6221773



4x
4161734



2x
6212758



2x
6352222



1x
4107623



1x
4114026



2x
4114084



2x
6013081



1x
6210759



1x
306921



2x
302321

82



1x
6186675



4x
459926



1x
6335388



1x
6315573



1x
6283610



4x
6279875



1x
6359887



1x
6354034



2x
9339



4x
302326



2x
300426



4x
6016172



2x
6250020



2x
242026



1x
371026



2x
6174917



4x
6416444



1x
6429020



1x
663626



2x
4514845



1x
428226

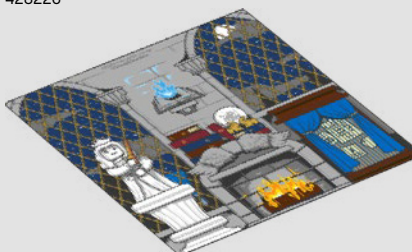

1x
6448414



1x
6302961



1x
4206330



1x
6435535



2x
6357747



1x
306928



1x
6270031



2x
6144750

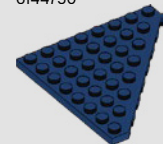

2x
6351760

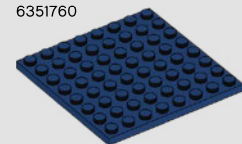

4x
6429018



2x
4211183



2x
6270028



2x
6201911

2x
4216581

10x
6371437

1x
6092590

5x
6261744

6x
6117976

1x
6409552

1x
6374056

2x
4271949

8x
6415991

1x
4211190

4x
6433946

8x
4221590

1x
4223683

23x
6176433

8x
4558953

4x
6144138

10x
6211917

6x
4211398

4x
4550325

1x
4211445

8x
4211356

2x
4211438

1x
4211452

2x
6318584

6x
4211481

2x
4211414

2x
6433942

6x
6163990

1x
4211413

8x
6225242

2x
6061702

1x
4211394

8x
6225228

12x
4211090

1x
6092572

2x
4210725

2x
6211916

18x
4210633

2x
6115080

2x
6230233

1x
6335316

2x
4210999

2x
4211065

1x
6435537

1x
6338824

1x
6399019

1x
6435972

2x
4505990

2x
6186672

1x
4536675

1x
6413538

1x
6403825

1x
6392533

1x
6313874

1x
6426732

1x
6420376

 [LEGO.com/service](https://www.LEGO.com/service)



YOU COULD **WIN**



Scan this QR code or go to **LEGO.COM/PRODUCTFEEDBACK** and give us your short feedback about this LEGO® set for a chance to win a cool LEGO prize.

Terms and Conditions apply*

DE: Du könntest GEWINNEN. Es gelten die Teilnahmebedingungen* **FR: Tu pourrais GAGNER.** Des conditions s'appliquent* **IT: Potresti VINCERE tu.** Termini e condizioni sono applicabili* **ES: Puedes GANAR.** Aplican términos y condiciones* **PT: Poderá GANHAR.** Aplicam-se termos e condições* **JA: プレゼント付き! 利用規約が適用されます*** **ZH: 轻松获奖. 条款和条件适用*** **KO: 상품의 주인이 되어보세요. 소정의 약관이 적용됩니다*** **RU: Вы можете ВЫИГРАТЬ.** Действуют положения и условия* **PL: Szansa na WYGRANĄ.** Obowiązują warunki korzystania* **CS: Máte šanci VYHRÁT.** Platí všeobecné smluvní podmínky* **SK: Máte šancu VYHRAŤ.** Platia všeobecné zmluvné podmienky* **HU: TE IS NYERHETSZ.** Felhasználási feltételek érvényesek* **RO: Ai putea CÂȘTIGA.** Se aplică termeni și condiții* **BG: Можете да СПЕЧЕЛИТЕ.** Има определени правила и условия* **LV: Tu vari LAIMĒT.** Ir spēkā noteikumi un nosacījumi.* **ET: Sul on võimalus VÕITA.** Kehtivad tingimused* **LT: Jūs galite LAIMĖTI.** Taikomos sąlygos*
*LEGO.com/productfeedback-terms

LEGO and the LEGO logo are trademarks of the/son des marques de commerce du/son marcas registradas de LEGO Group. ©2023 The LEGO Group.

WIZARDING WORLD and all related trademarks, characters, names, and indicia are © & ™ Warner Bros. Entertainment Inc.
Publishing Rights © JKR. (s23)