



MARVEL

76277



Q LEGO® Builder



LEGO.com/sustainable-packaging



FR
DONNEZ
OU
RECYCLEZ

 OU  OU 

ASSOCIATION MAGASIN DÉCHÈTERIE

Adresses sur quefairedemesdechets.fr



BUILDER



Apple and the Apple logo are trademarks of Apple Inc., registered in the U.S. and other countries and regions. App Store is a service mark of Apple Inc. Google Play and the Google Play logo are trademarks of Google LLC. Tencent and the Tencent logo are trademarks of Tencent Inc.



EN Ask parents' permission before going online | **DE** Eltern um Erlaubnis bitten, bevor du online gehst | **FR** Demande l'autorisation d'un parent avant d'aller en ligne | **IT** Chiedi il permesso ai tuoi genitori prima di andare online | **ES** Pídeles permiso a tus papás antes de conectarte a Internet | **PT** Pede autorização aos pais antes de acederes online | **ZH** 上网前应先征得父母的同意 | **PL** Poproś rodziców o zgodę, zanim wejdiesz do Internetu | **CS** Než půjdeš na internet, požádej rodiče o svolení | **SK** Skôr než pôjdeš na internet, vypýtaj si povolenie od rodičov | **HU** Kérj szülői engedélyt, mielőtt online csatlakoznál! | **RO** Cere permisiunea părinților înainte de a te conecta online | **BG** Поискайте разрешение от родител, преди да влезете онлайн | **LV** Pirms došanās tiešsaistē palūdz atļauju vecākiem | **ET** Enne Interneti kasutamist küsi vanematelt luba | **LT** Prieš prisijungdami prie interneto, atsiklauskite tėvų





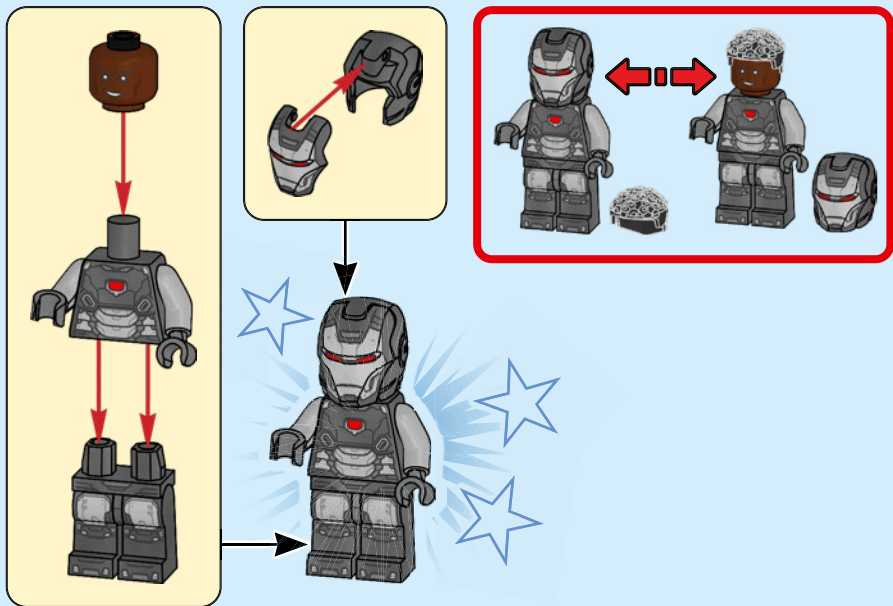

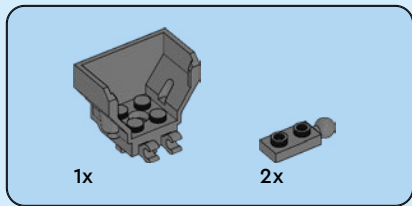

1

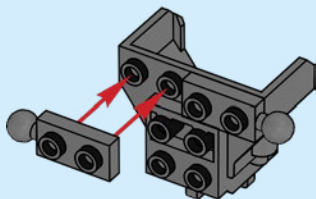

6





1x



1x

2

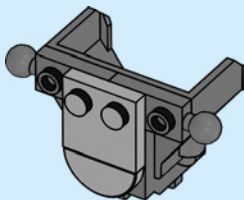

1x

3

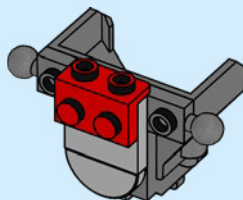



2x

4

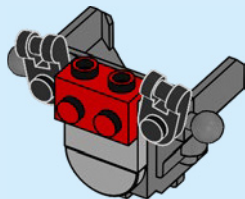

1x

5

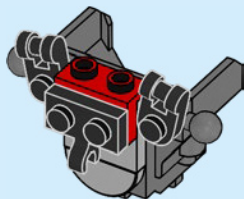



2x

6

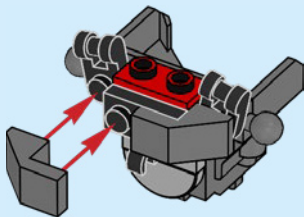



1x

7

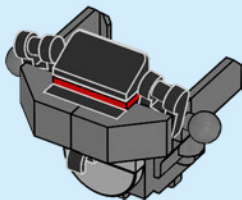

10

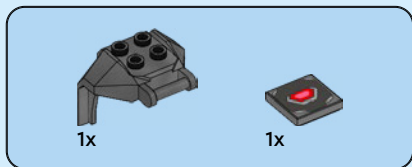

8

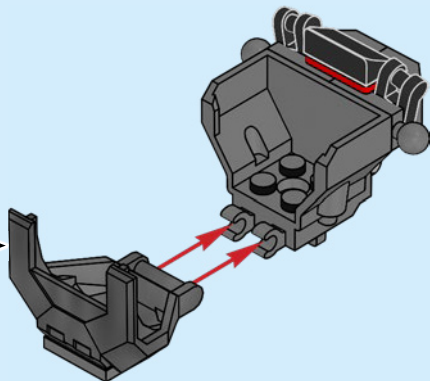
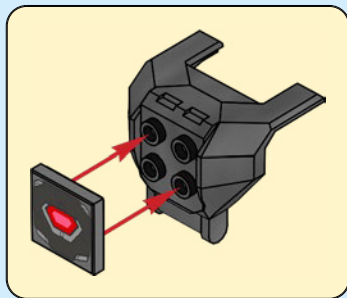



2x

9

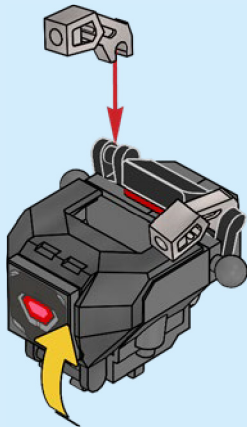



1x

10

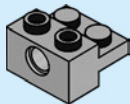

1x

11





2x

12

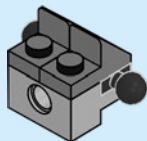

14



2x

13

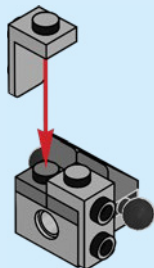



1x

14

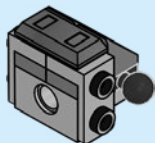

2x

15

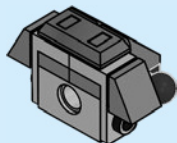



1x



1x



1x



1x

16

1

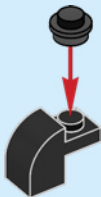

2



3





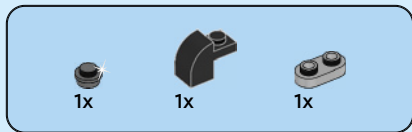

17

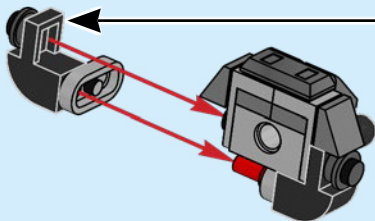
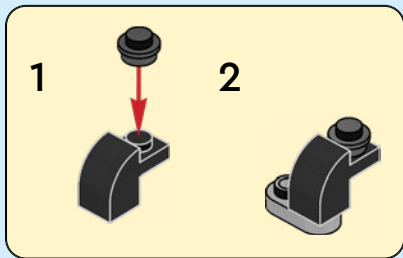

18



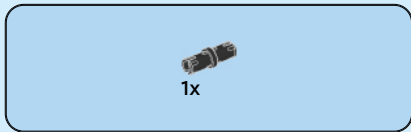

18

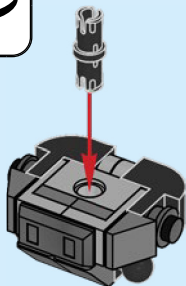
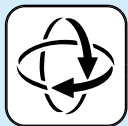

19

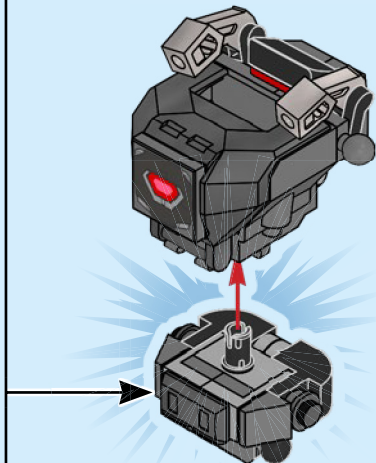

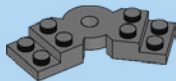

1x

20

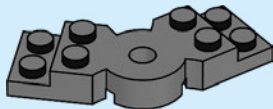

20





2x

21

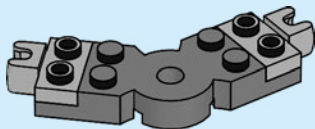

1x



1x

22

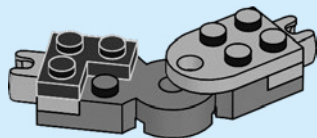



1x

23

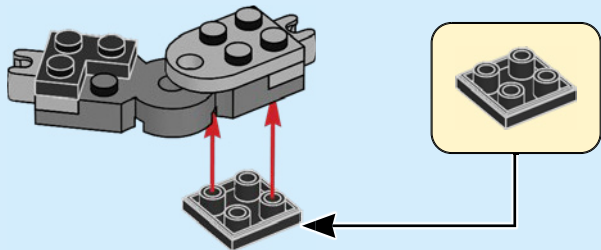



1x

24

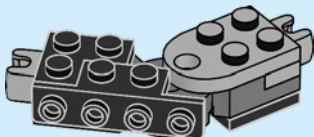

1x

25

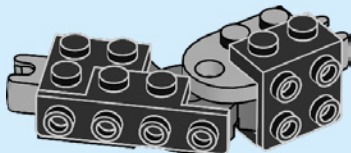



1x



2x

26

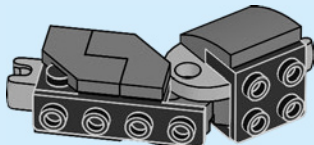



1x



1x



1x

27

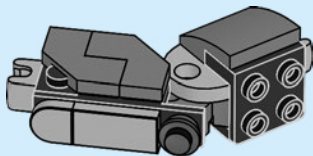

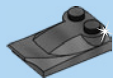

1x



1x

28

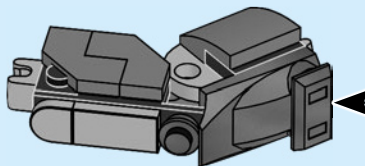
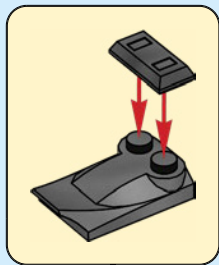

29

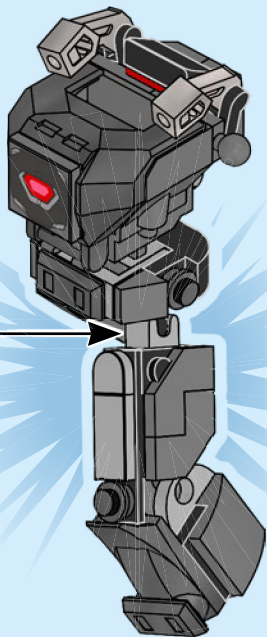

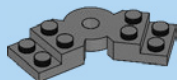

1x

30

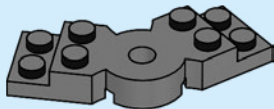



2x

31

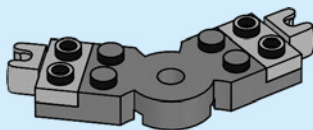

1x



1x

32

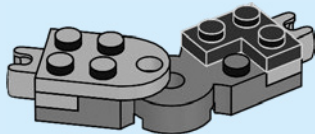



1x

33

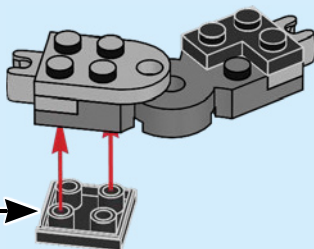
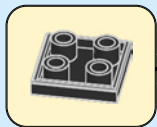



1x

34

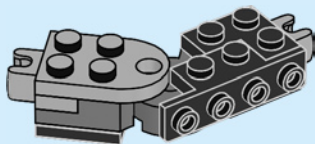

1x

35

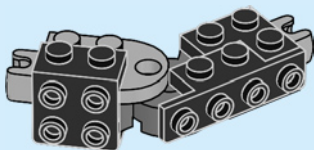



1x



2x

36

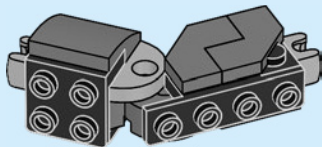



1x



1x



1x

37

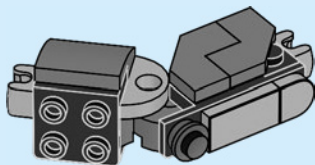

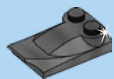

1x



1x

38

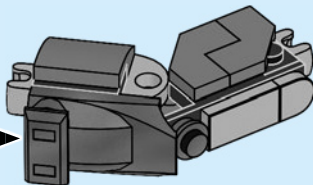
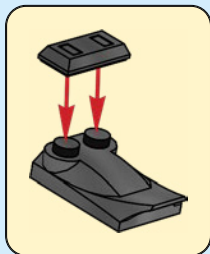

39

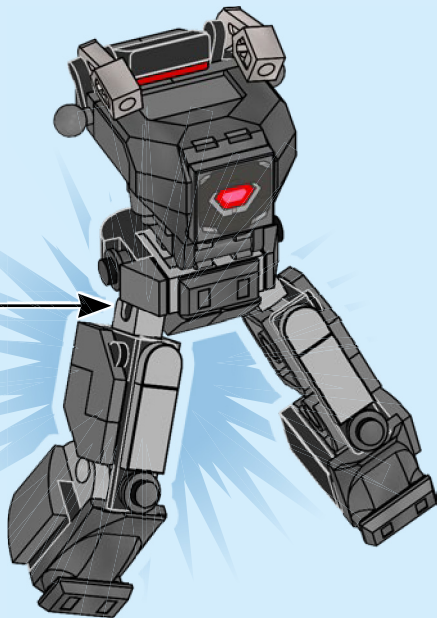



2x

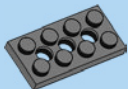

1x



1x

40

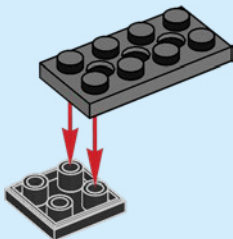

2x

41

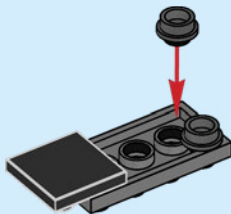



1x

42

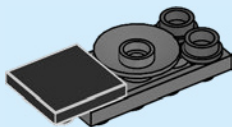

1x



1x

43

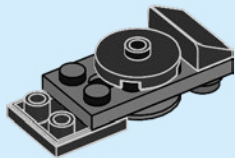



1x

44

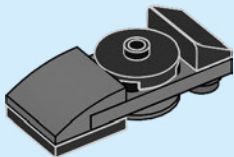

1x

45

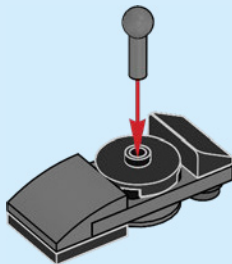

2x

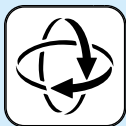

46

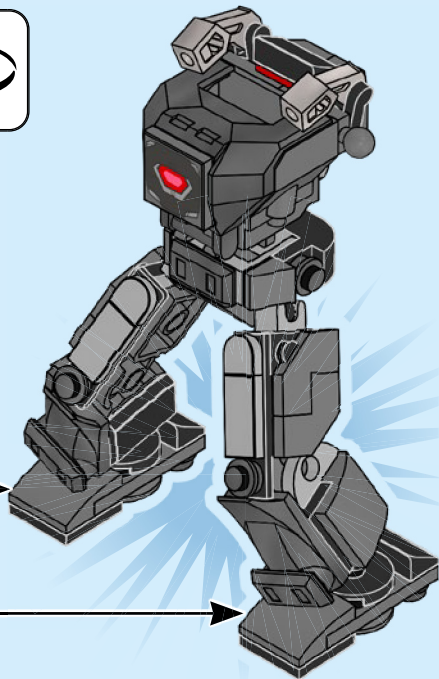

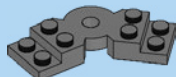

1x

47

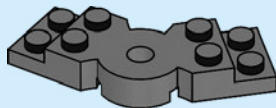



1x



1x

48

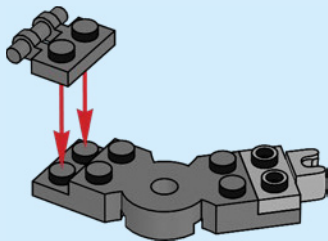

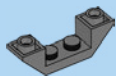

1x



1x

49

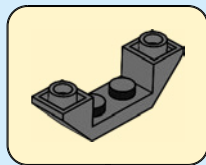
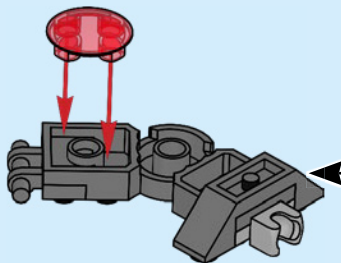



1x



2x

50

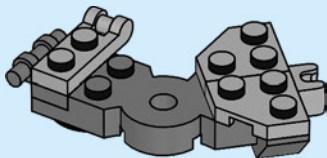



1x



2x

51

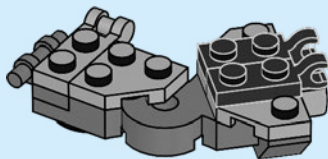



1x

52

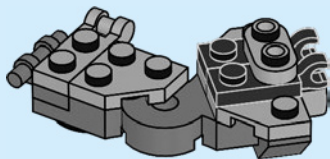

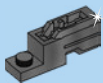

1x



1x

53

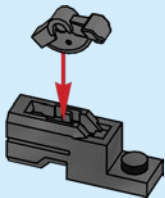

1x

54

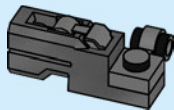

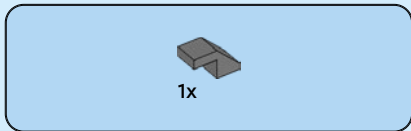

55

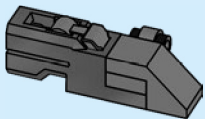

56

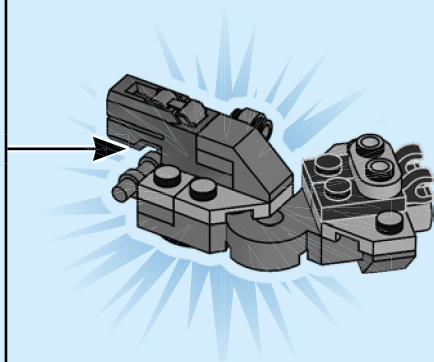



2x

57

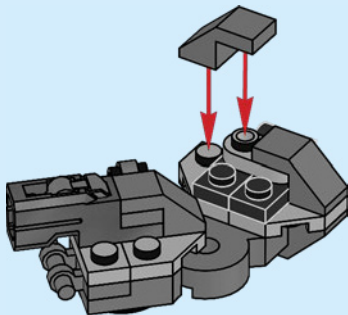



1x



1x

58

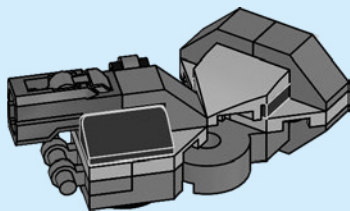



1x

59

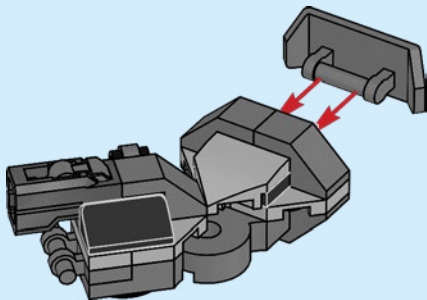



4x

60

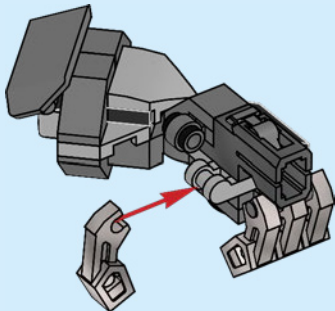

61

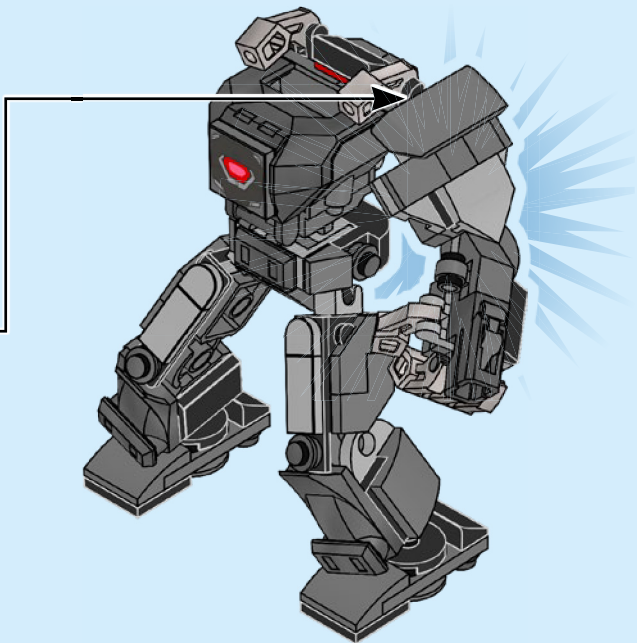

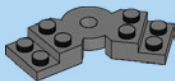

1x

62

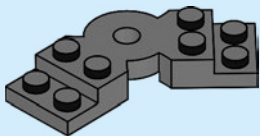



1x



1x

63

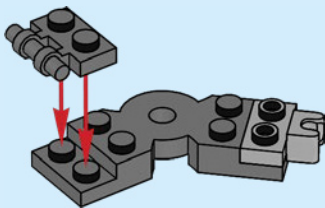

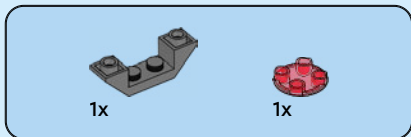

64

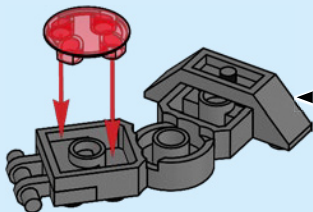
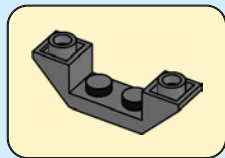



1x



2x

65

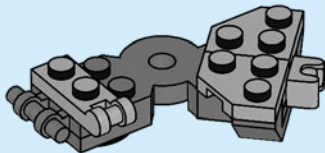



1x

66

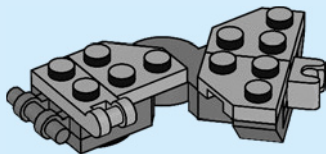

1x

67

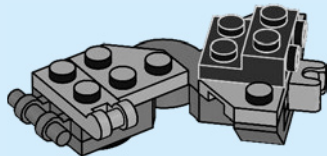



1x



1x

68

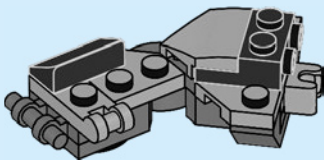



2x

69

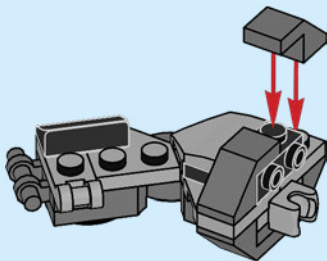

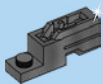

70

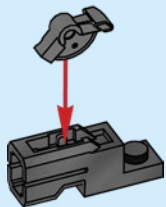

1x

71

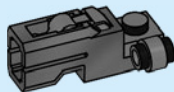

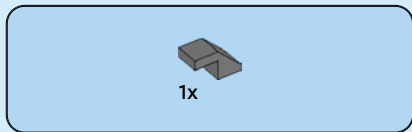

72

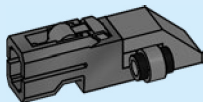

73

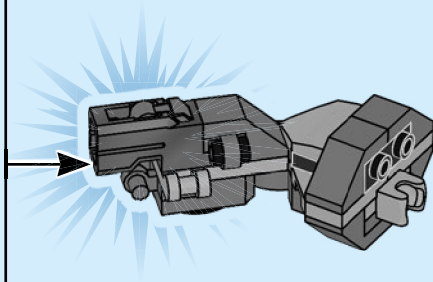

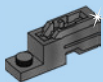

1x



1x

74

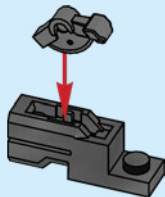

1x

75

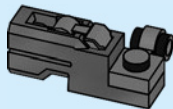



1x

76

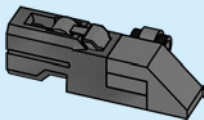

77

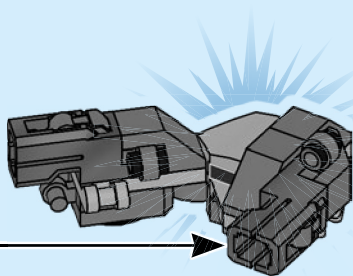



4x

78

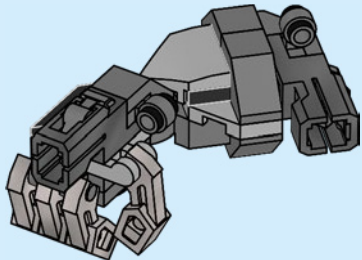

79

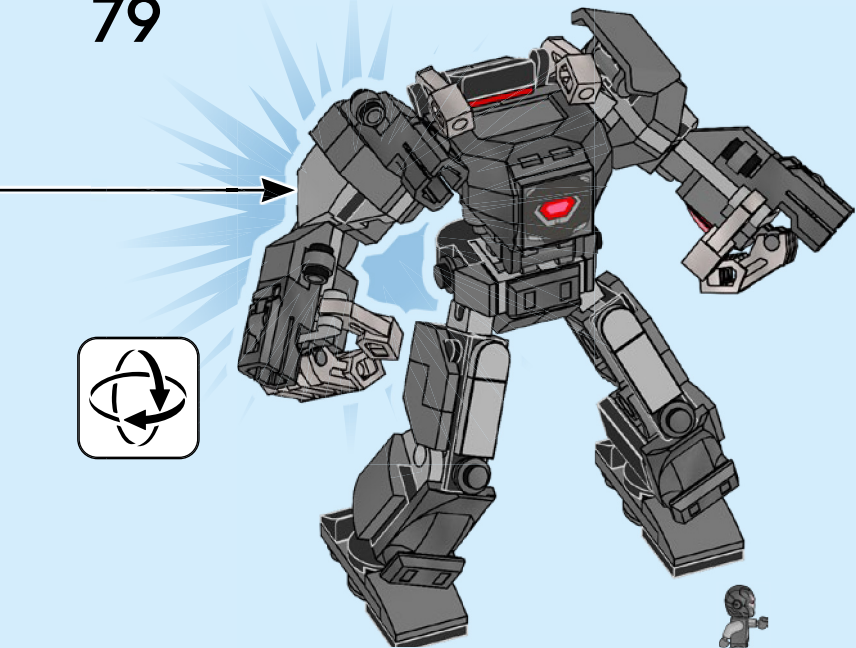



1x

80





1x

81

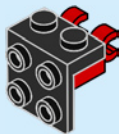

1x



1x

82





1x



1x

83

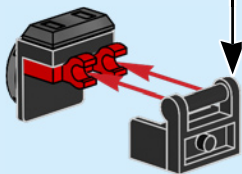
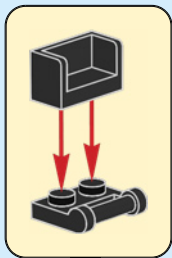

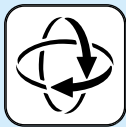

84

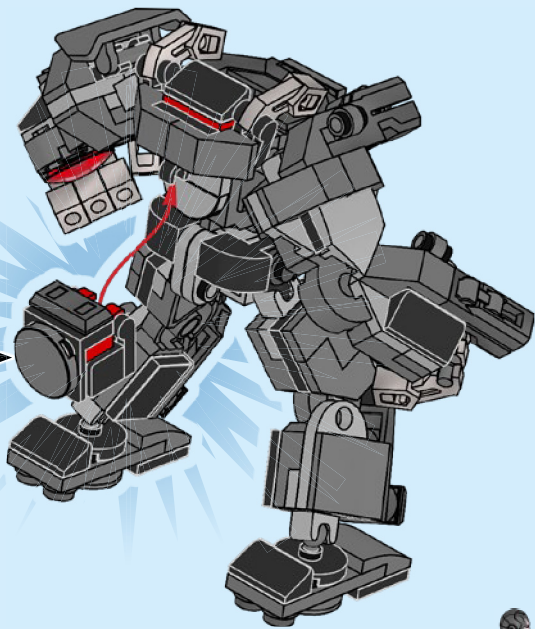

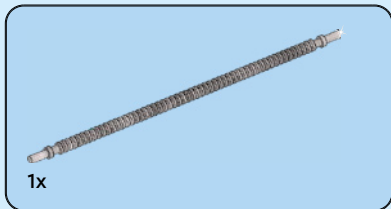

85

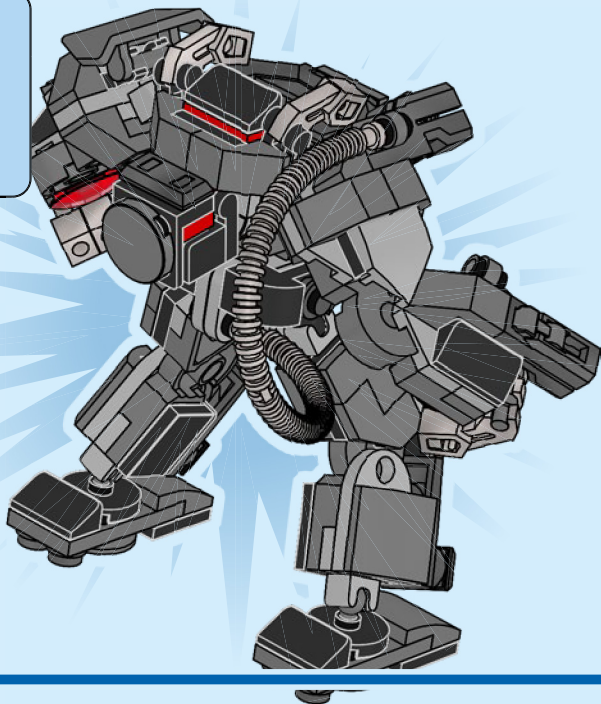

86

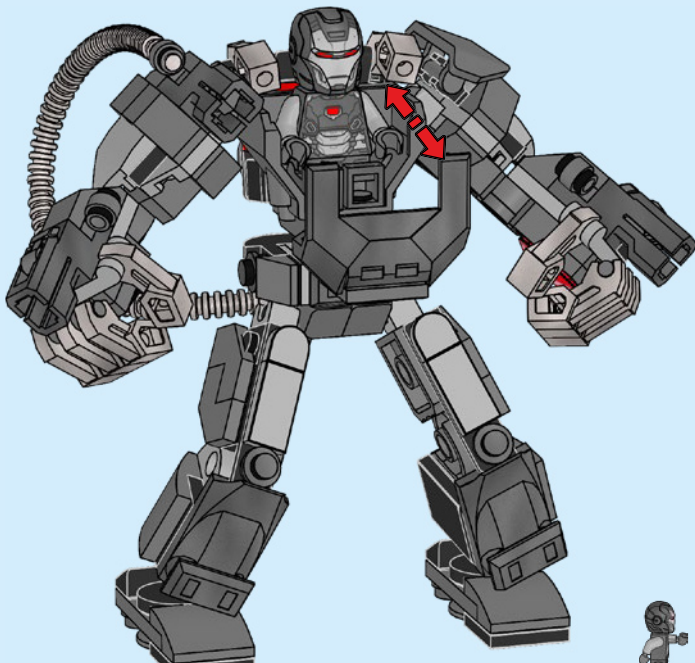



7x

87

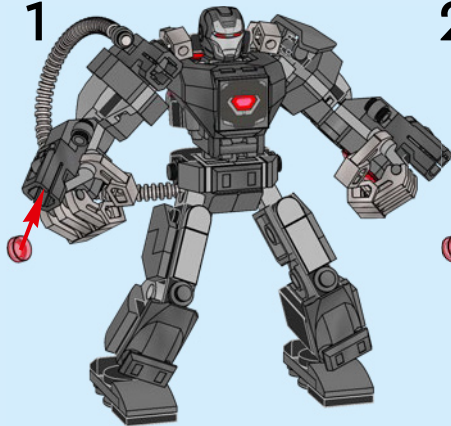
1

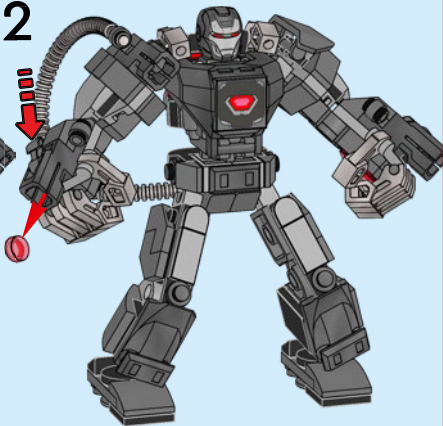

2



88

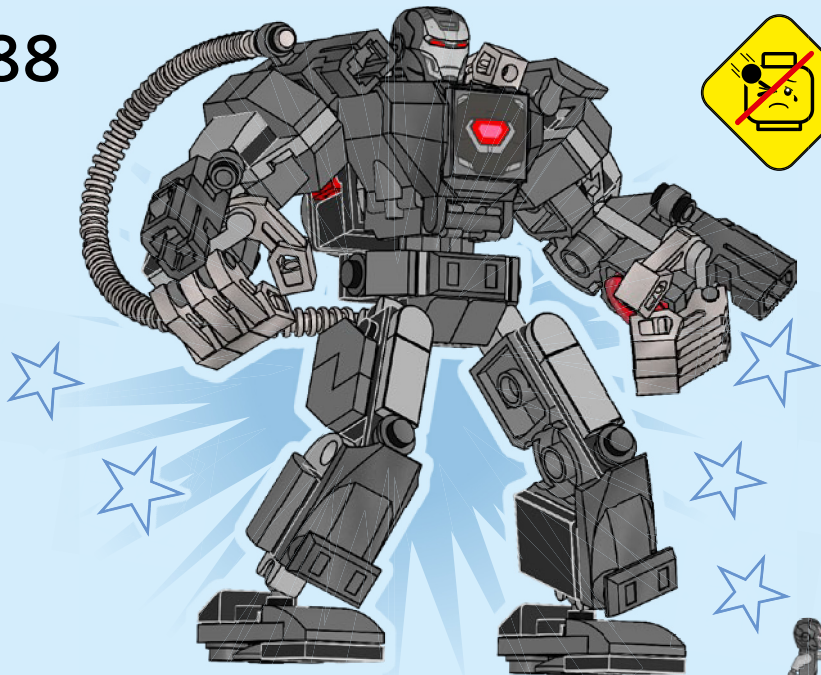

1x
6399645

1x
6319330

1x
6360036

1x
6356861

2x
6157554

5x
4548180

1x
6279875

2x
6195325

2x
6184784

1x
6313116

1x
6248496

3x
6117973

2x
6336989

1x
4225201

4x
6013867

2x
242026

1x
6469445

1x
6416838

2x
6168620

7x
6258607

2x
6254635

1x
6384957

2x
6250597

2x
6362975

1x
6408629

3x
6248890

6x
6043656

2x
4211414

6x
6186657

2x
6305049

1x
6326478

1x
6212077

2x
4515369

2x
4211419

2x
4504378

2x
6364352

3x
6360675

1x
6056296

2x
4211010

3x
6281996

2x
6069164



1x
6467547



9x
6168776



4x
6395097



4x
6208447



2x
6167034



2x
6185675



2x
4210660



10x
6262193



1x
6475975



1x
6466710



2x
4227398



2x
6123814



8x
6038201



3x
6345952



4x
6071261



1x
6467544



1x
6467546



4x
6177079



1x
6405014

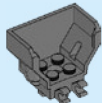

1x
6384443



1x
6044636



1x
6124820

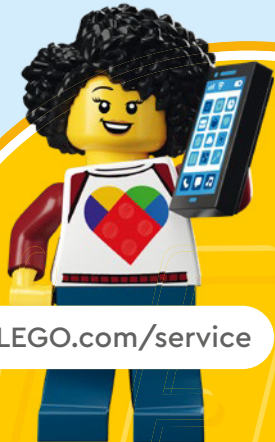

LEGO.com/service

YOU COULD
WIN



Scan this QR code or go to
LEGO.COM/PRODUCTFEEDBACK and give us
your short feedback about this LEGO® set
for a chance to win a cool LEGO prize.

Terms and Conditions apply*

EN: YOU COULD WIN. Terms and Conditions apply* **DE: Du könntest GEWINNEN.** Es gelten die Teilnahmebedingungen* **FR: Tu pourrais GAGNER.** Des conditions s'appliquent* **IT: Potresti VINCERE tu.** Termini e condizioni sono applicabili* **ES: Puedes GANAR.** Aplican términos y condiciones* **PT: Poderá GANHAR.** Aplicam-se termos e condições* **ZH: 轻松获奖.** 条款和条件适用* **PL: Szansa na WYGRANĄ.** Obowiązują warunki korzystania* **CS: Máte šanci VYHRÁT.** Platí všeobecné smluvní podmínky* **SK: Máte šancu VYHRÁT.** Platia všeobecné zmluvné podmienky* **HU: TE IS NYERHETSZ.** Felhasználási feltételek érvényesek* **RO: Ai putea CÂȘTIGA.** Se aplică termenii și condiții* **BG: Можете да СПЕЧЕЛИТЕ.** Има определени правила и условия* **LV: Tu vari LAIMĒT.** Ir spēkā noteikumi un nosacījumi.* **ET: Sul on võimalus VÕITA.** Kehtivad tingimused* **LT: Jūs galite LAIMĖTI.** Taikomos sąlygos*

*[LEGO.com/productfeedback-terms](https://www.lego.com/productfeedback-terms)

LEGO and the LEGO logo are trademarks of the LEGO Group. ©2024 The LEGO Group.

© 2024 MARVEL

6499626