

**LEGO**

**MARVEL**  
**SUPERHEROES**



76048



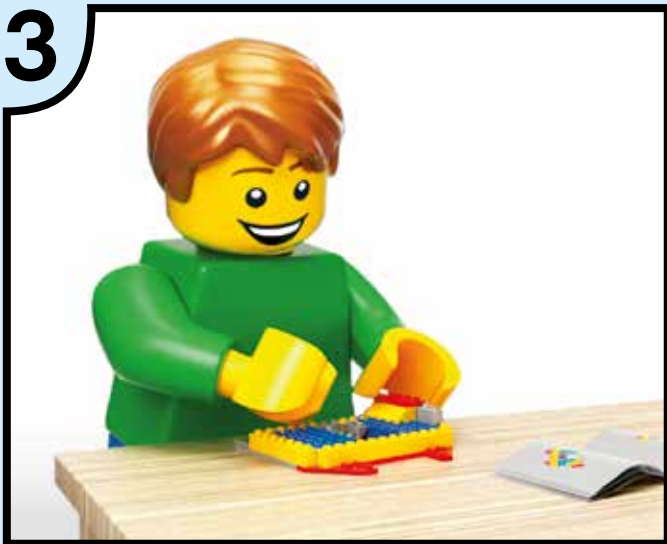

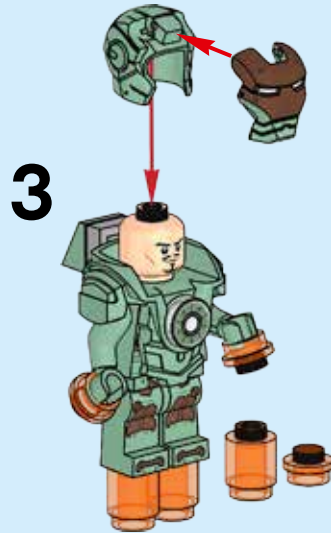
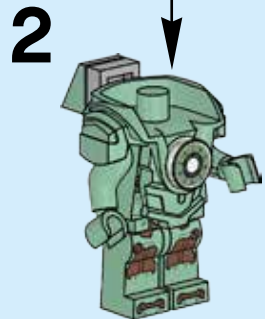
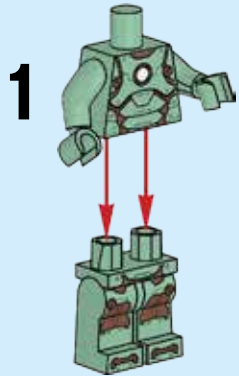
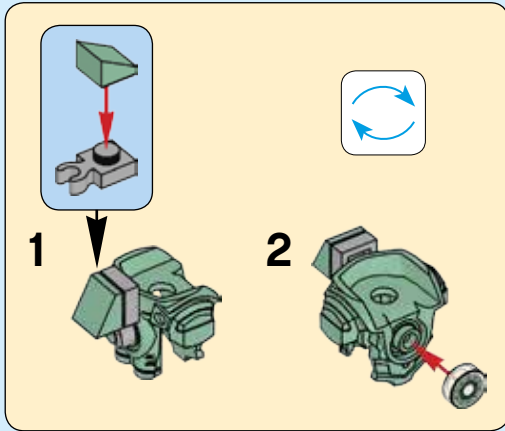



1x

1

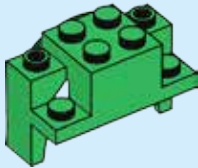

4x

2

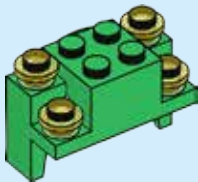

2x



1x

3

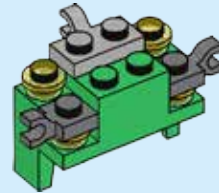

1x

4

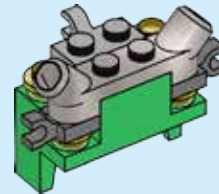



5

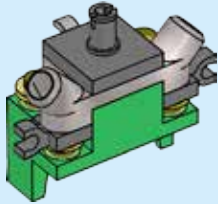

6

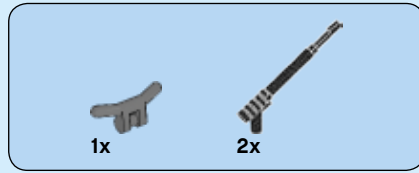
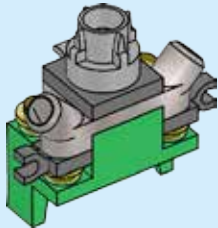

7

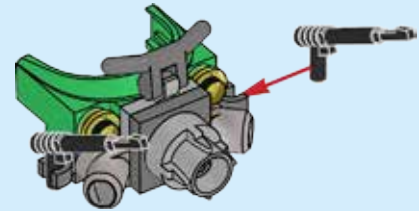
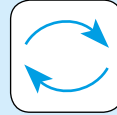

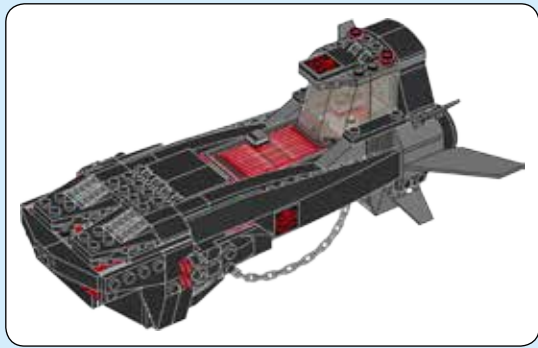

1x

**1**

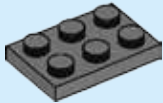

1x

**2**

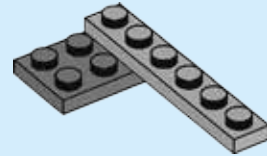



1x

3

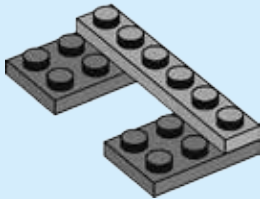

2x

4

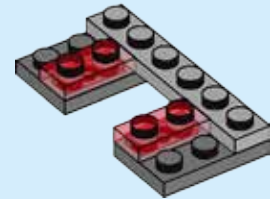

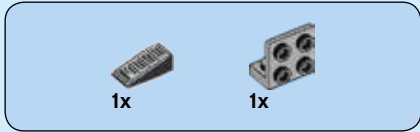

5

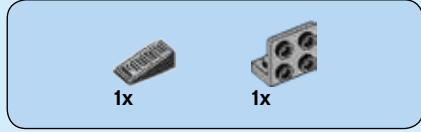
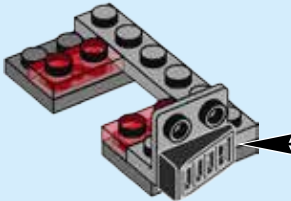
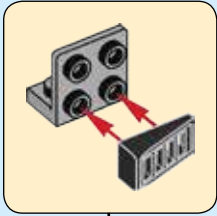

6

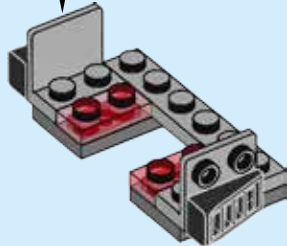
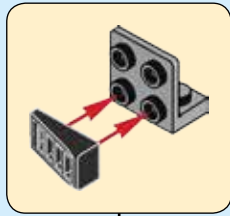





7

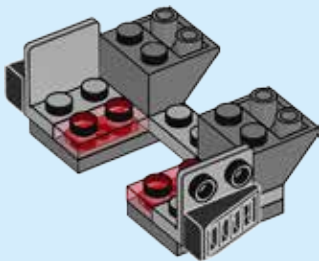

8

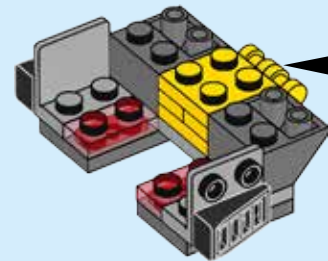
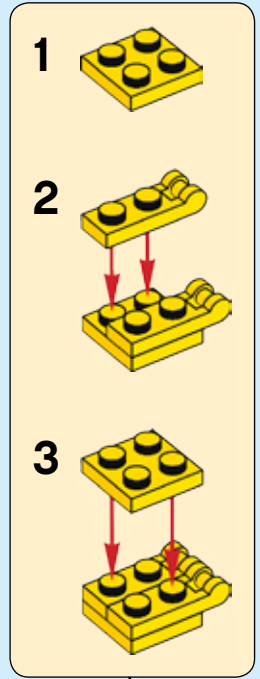

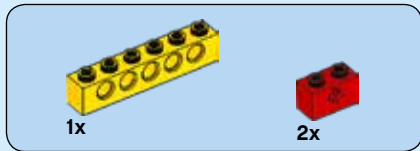

9

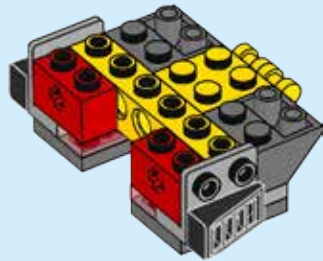

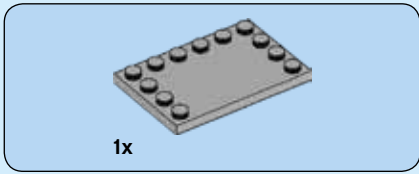

10

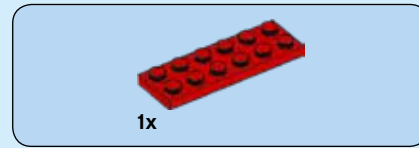
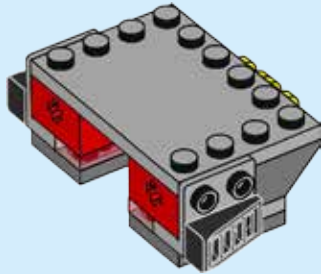

11

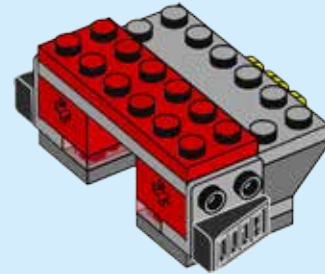



1x



4x

# 12

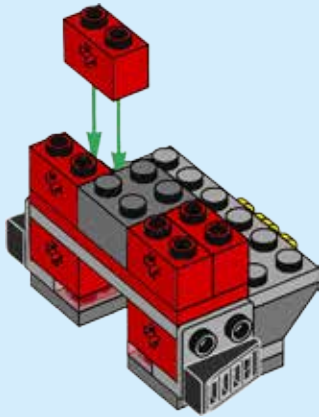

1x

# 13

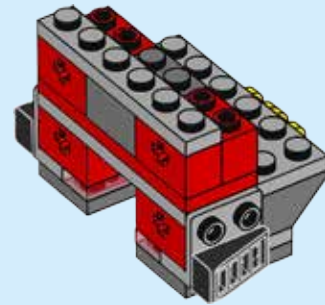

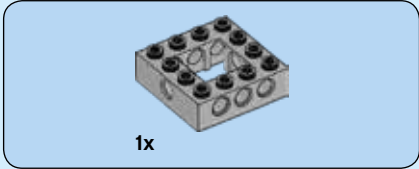
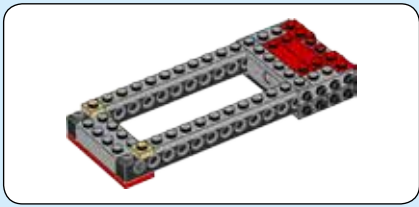

14

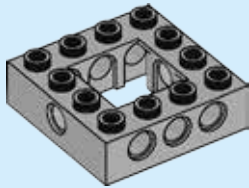

15

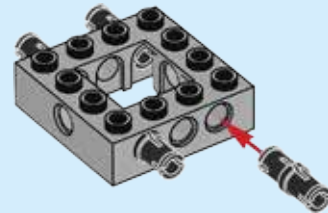

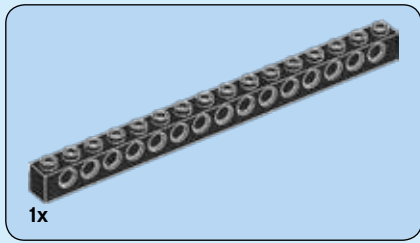

16

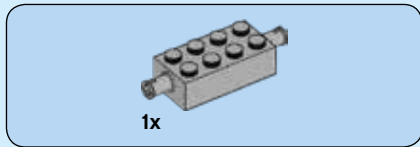
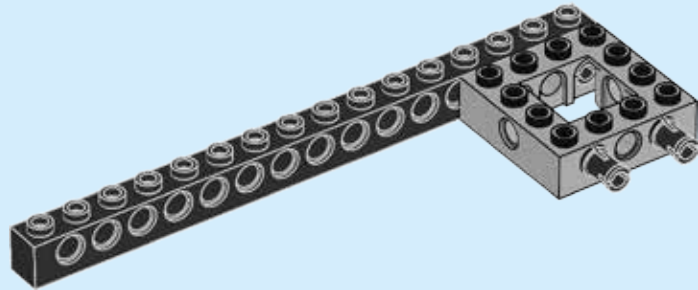

17

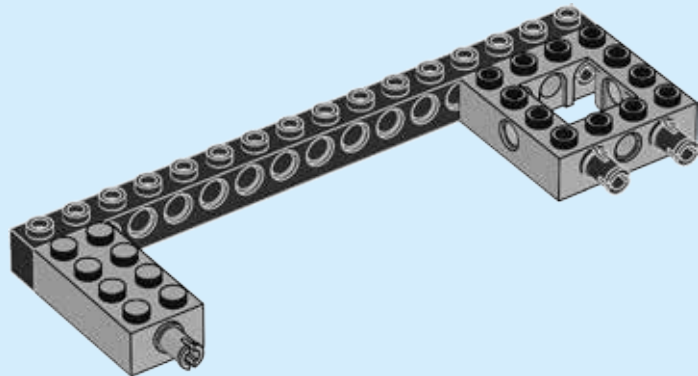

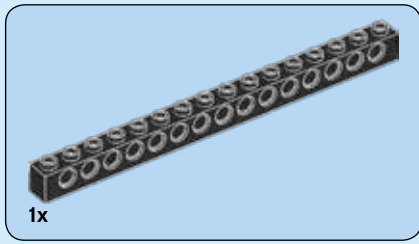

18

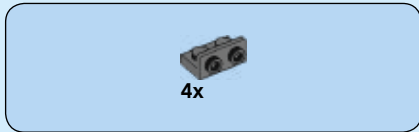
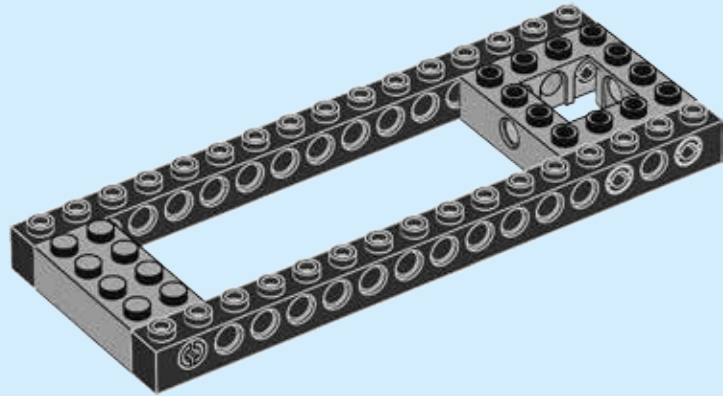

19

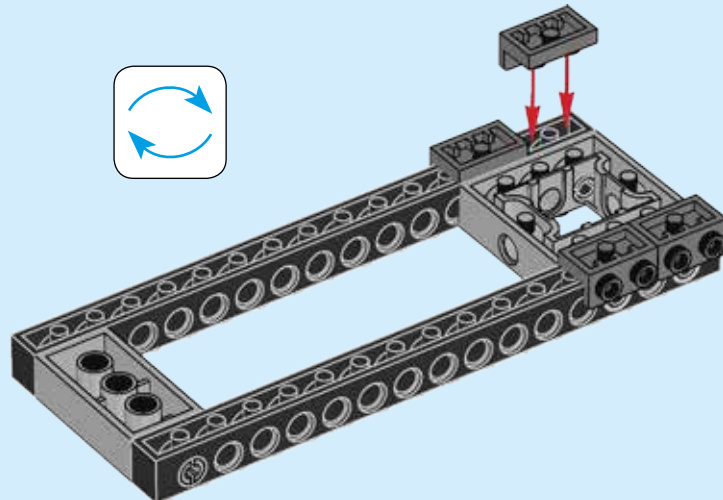
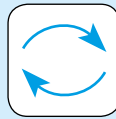

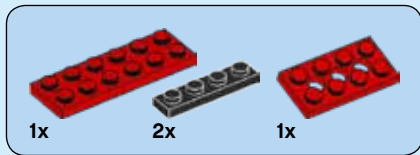

# 20

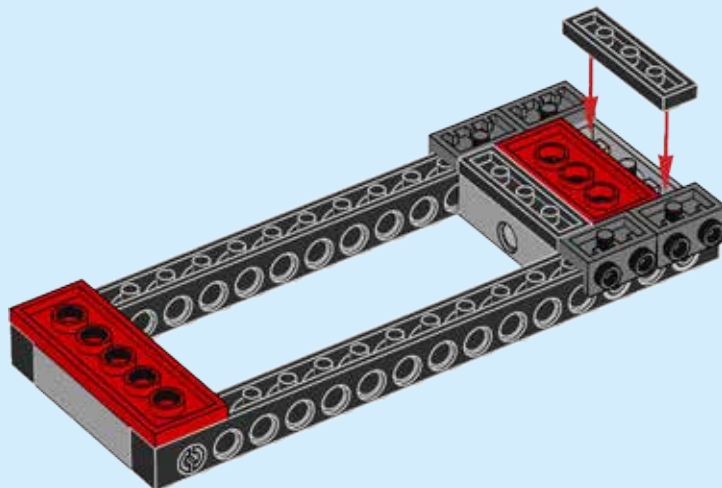

# 21

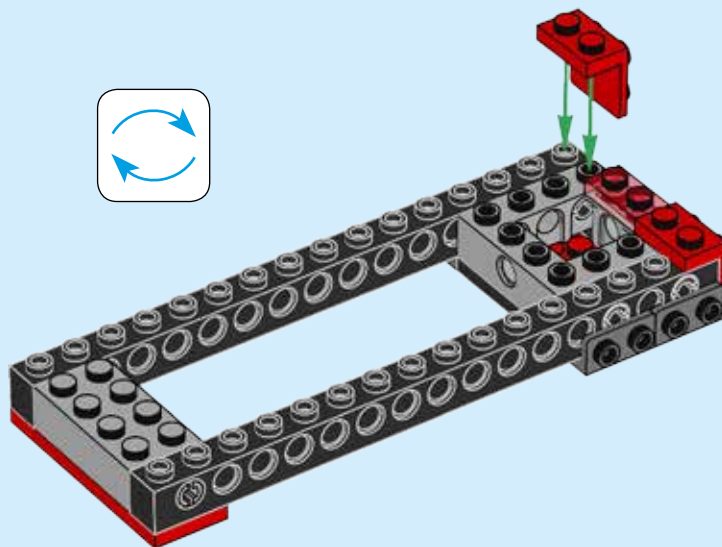
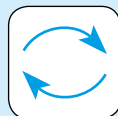





1x

# 22

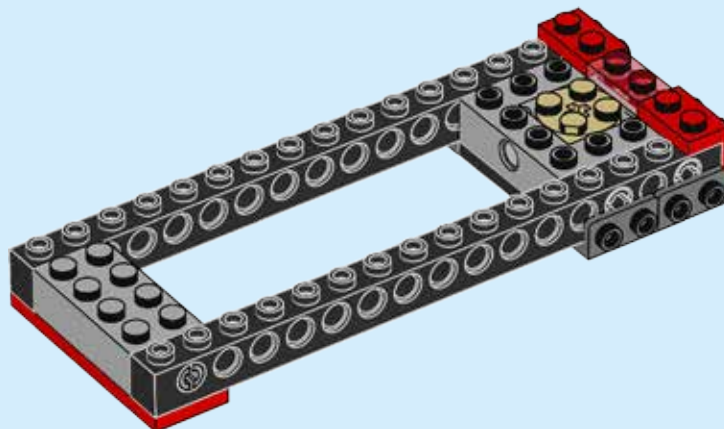

2x

# 23

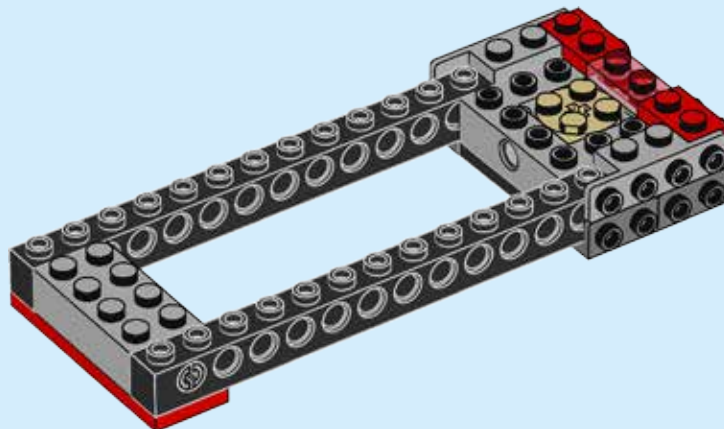

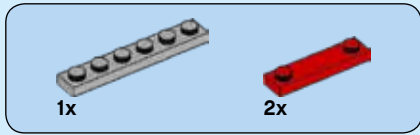

# 24

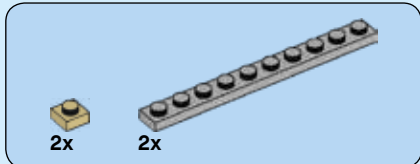
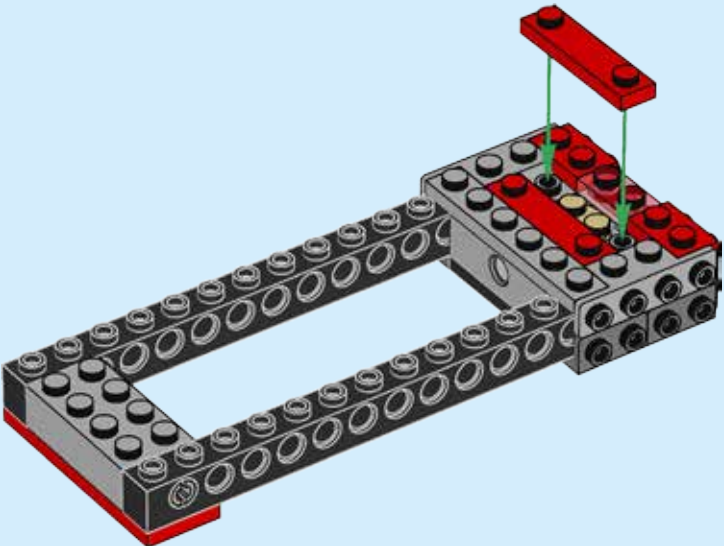

# 25

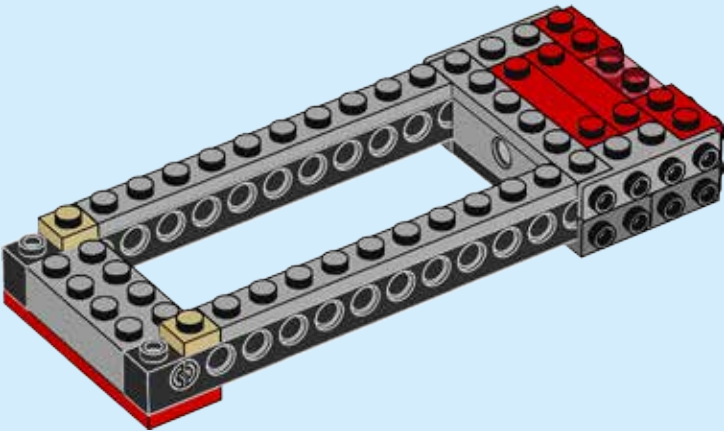

26

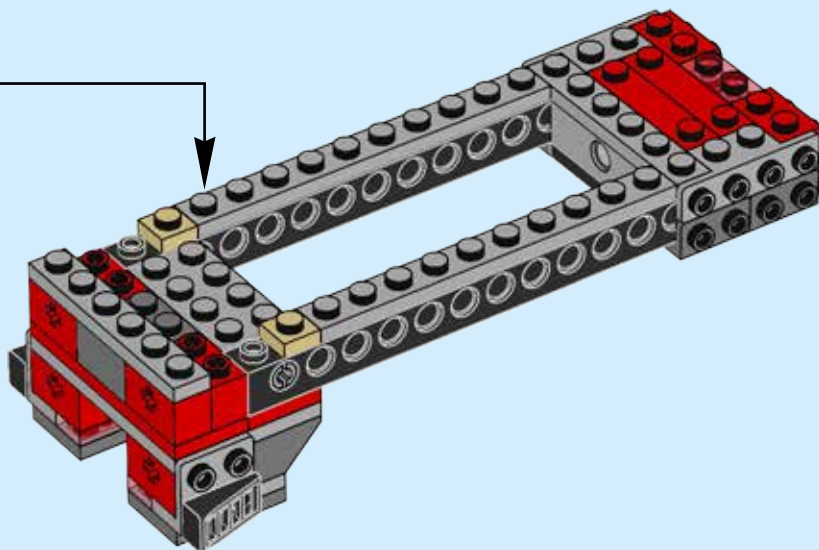

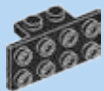

2x

# 27

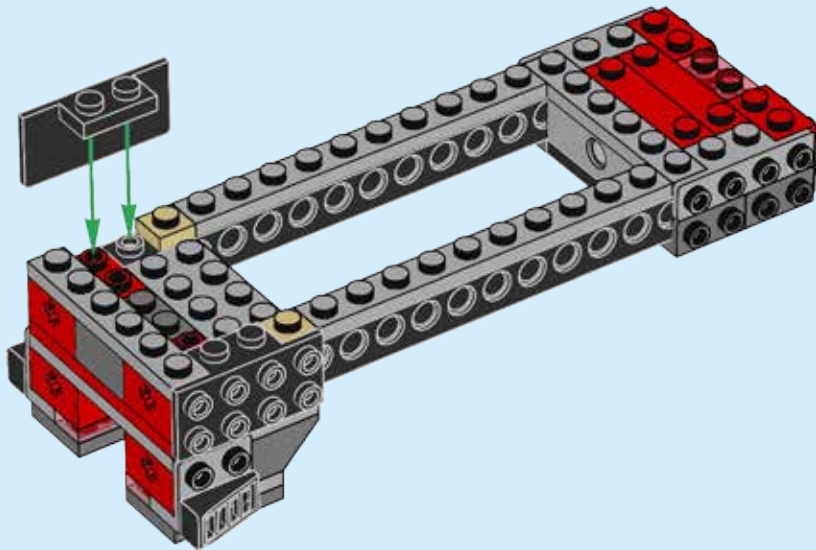

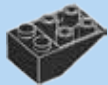

2x

# 28

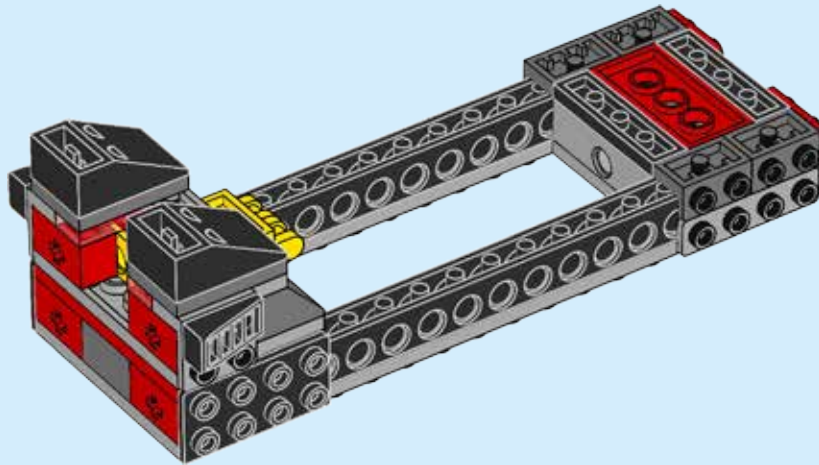
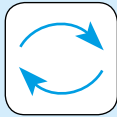



1x

# 29



1x

# 30

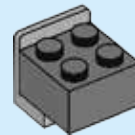



1x

# 31

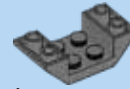
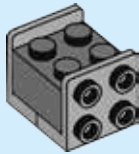

1x

# 32

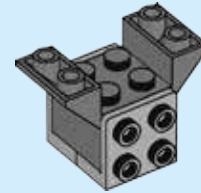



2x

# 33

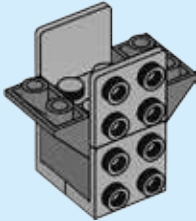

1x



1x

# 34

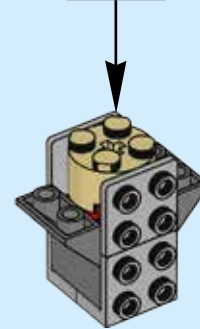





2x



2x

# 35

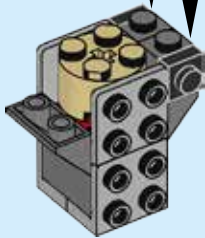
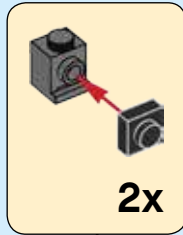

1x



1x

# 36

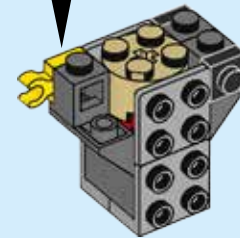
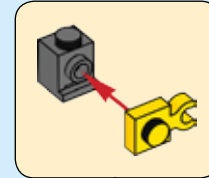



# 37

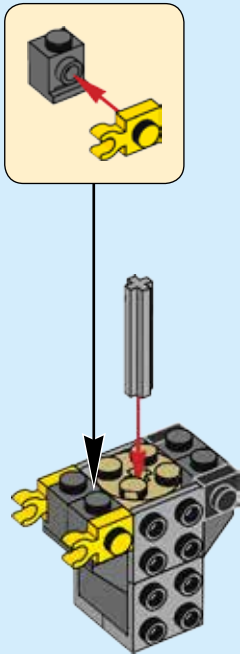

# 38

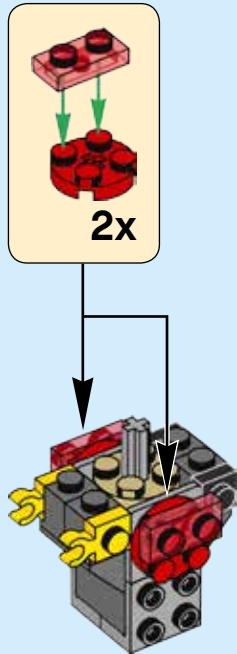

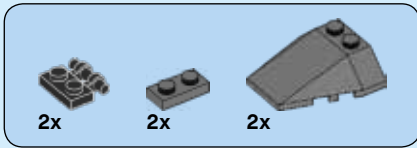

# 39

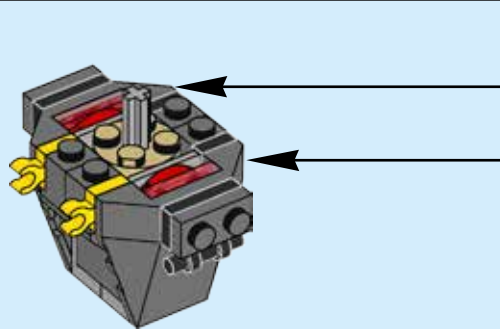
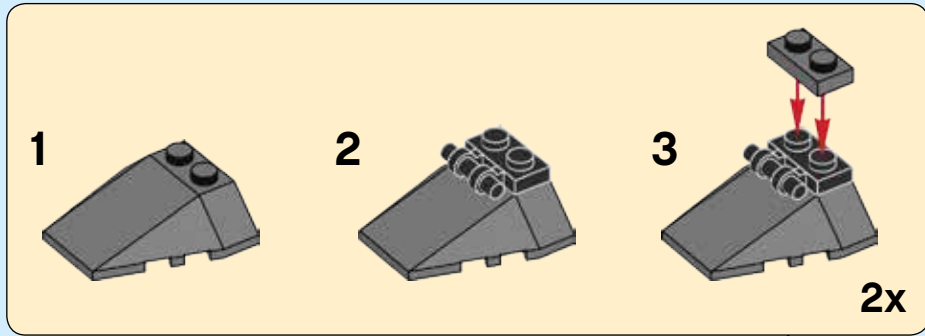



2x



2x

# 40

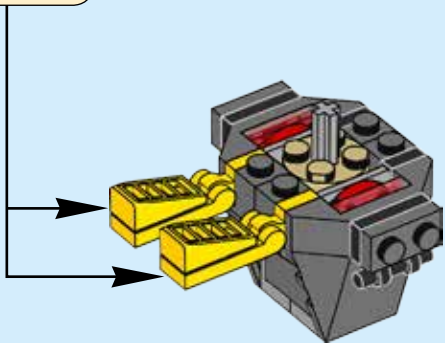
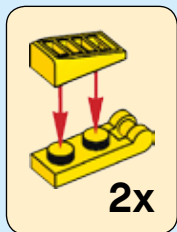

2x

# 41

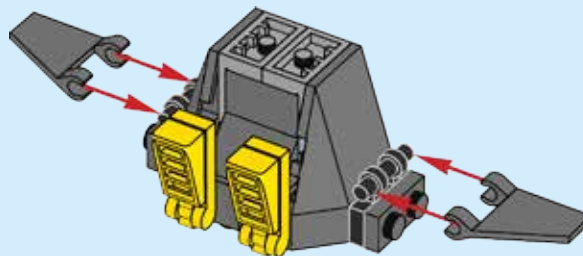
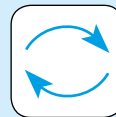

42

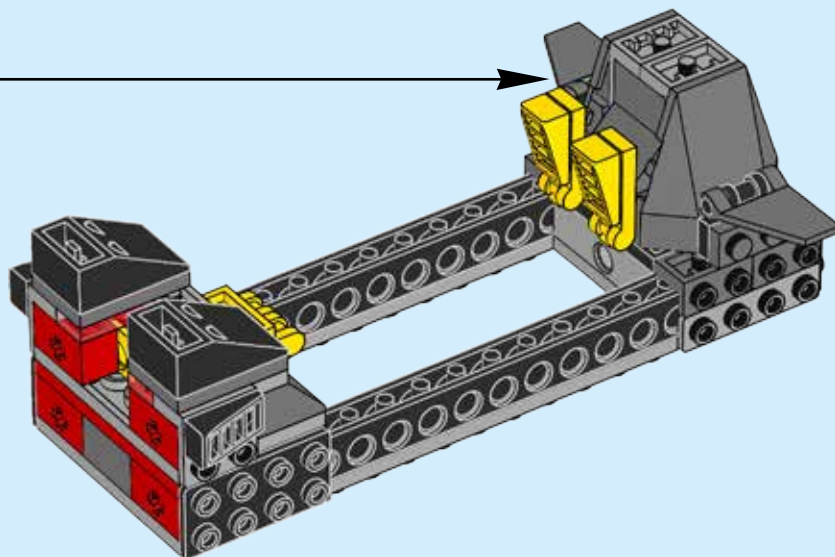



4x

# 43

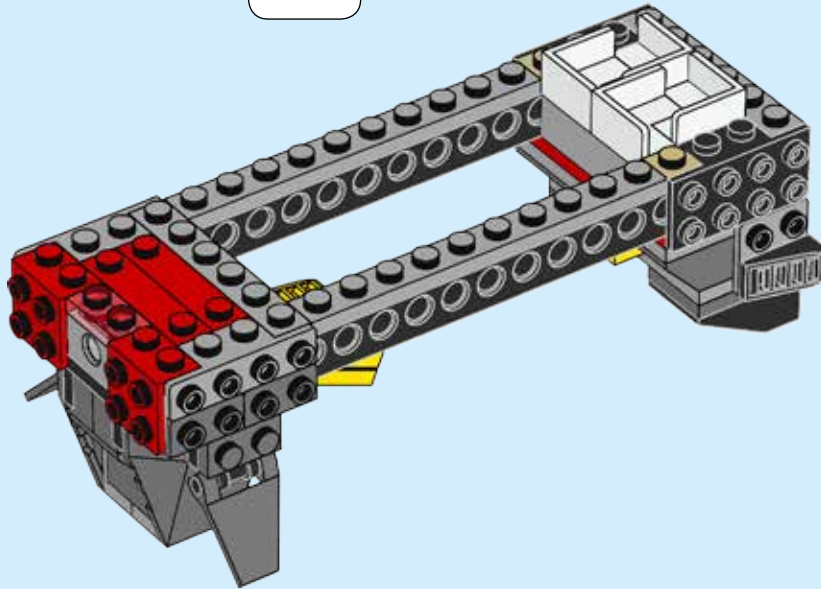
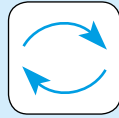

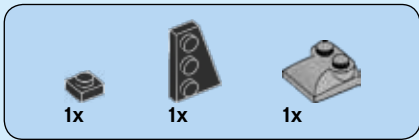

44

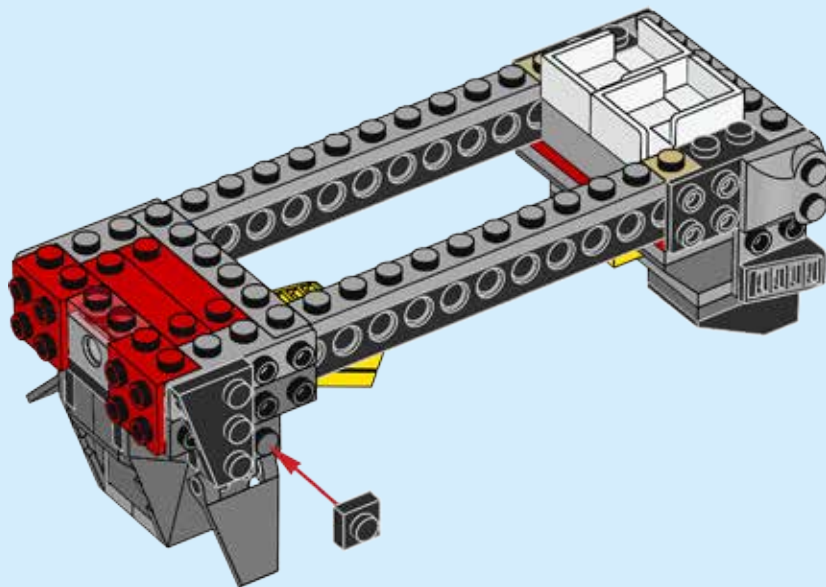

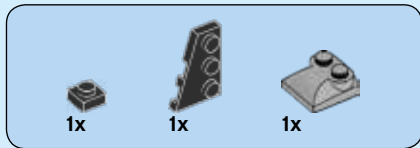

# 45

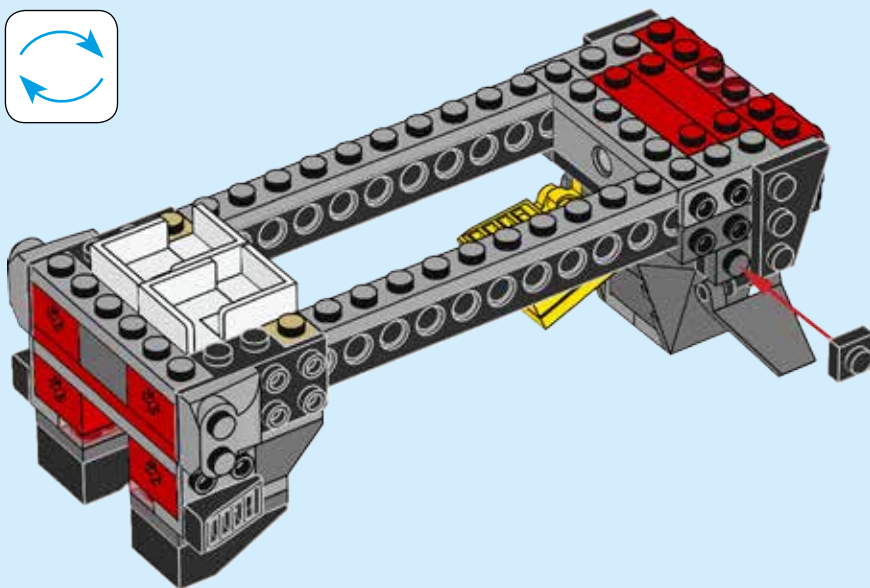
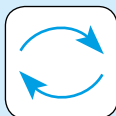





2x

# 46

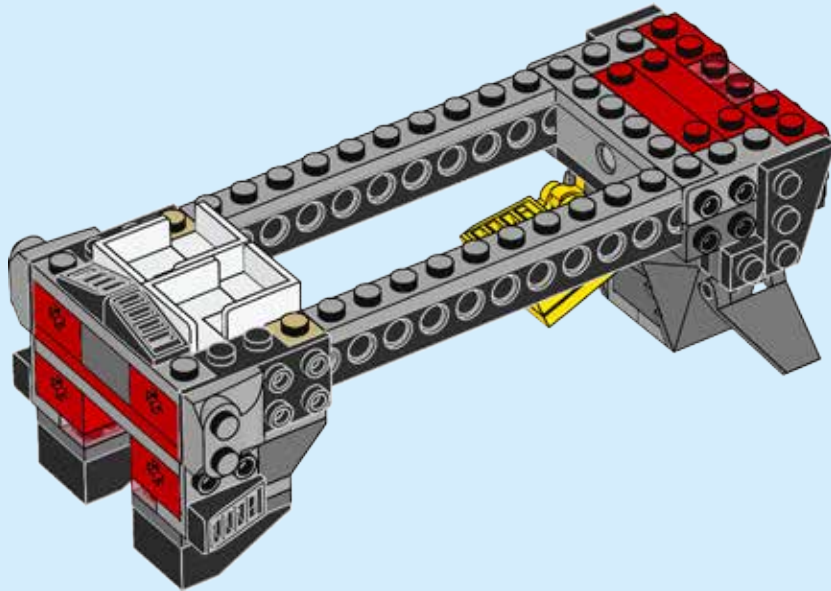



2x



2x

# 47

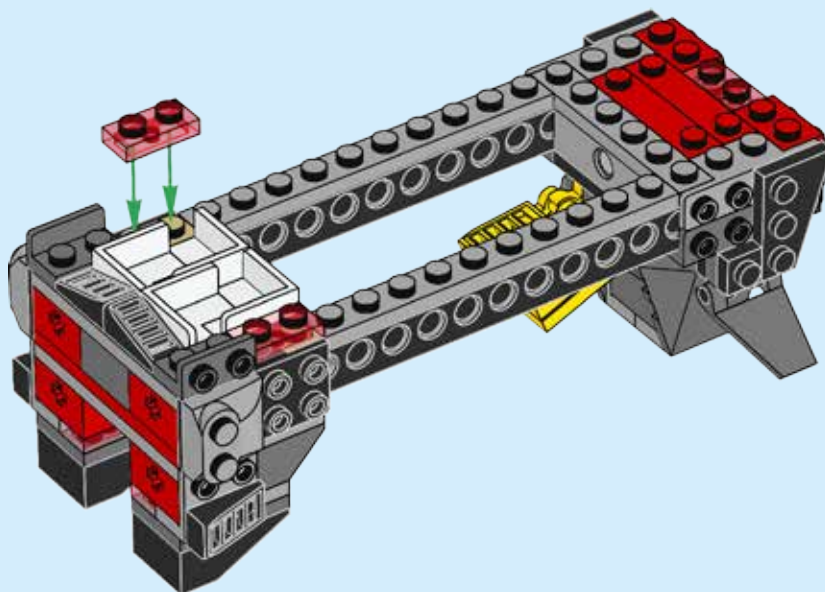

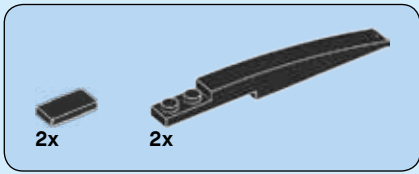

48

