



Disney · PIXAR  
**TOY**  
STORY



7594



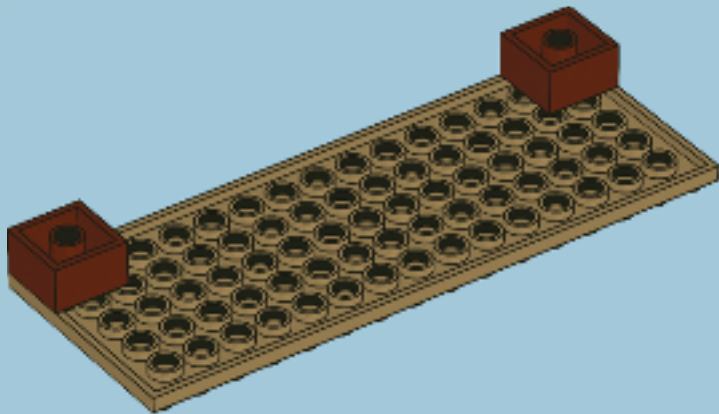
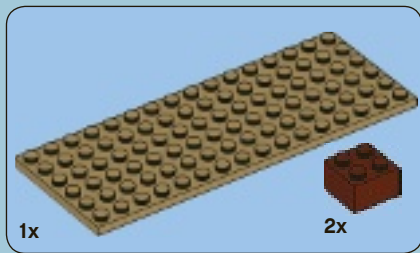
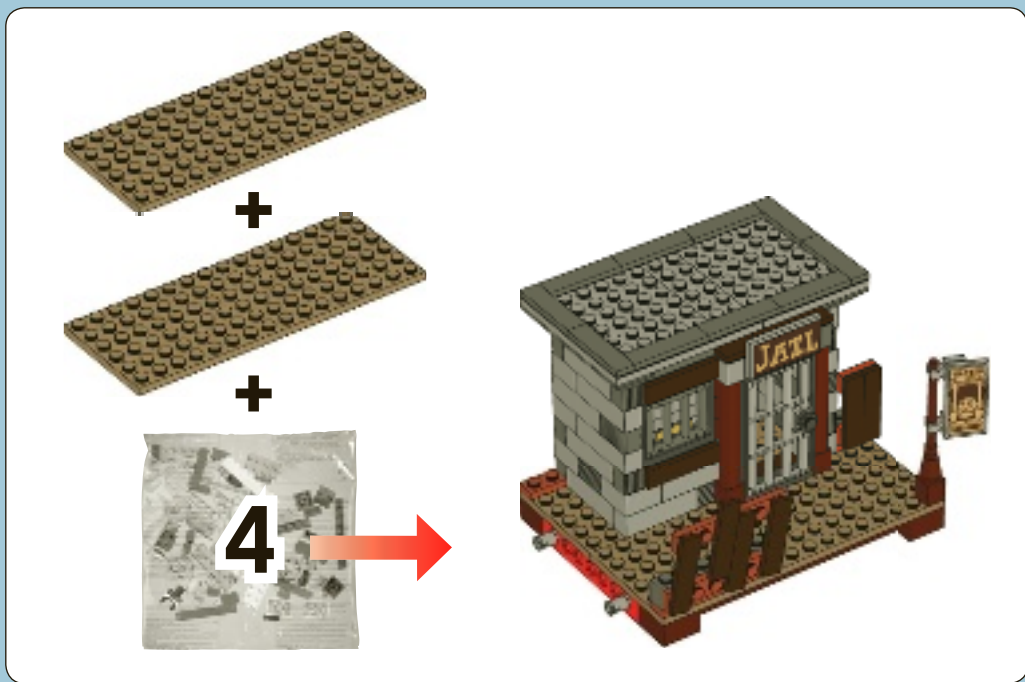

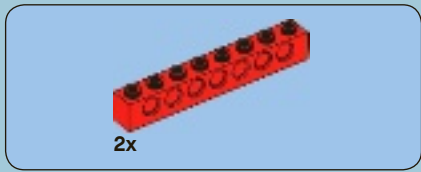

2

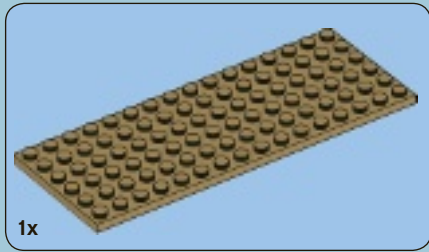
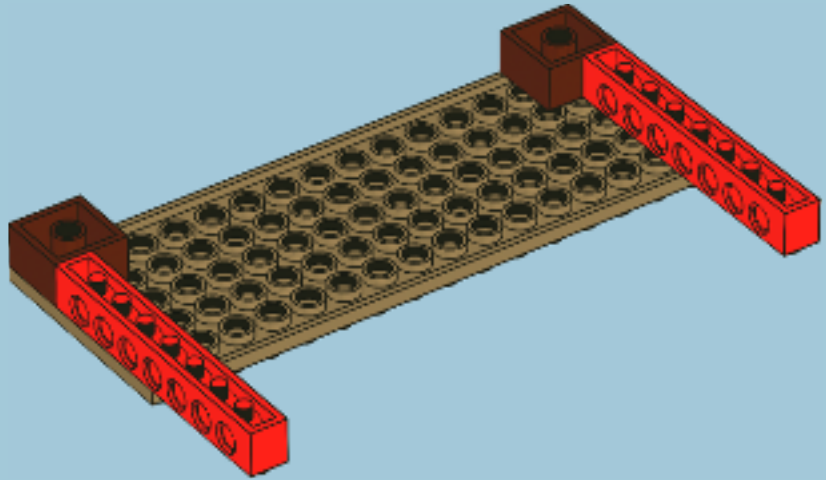

3

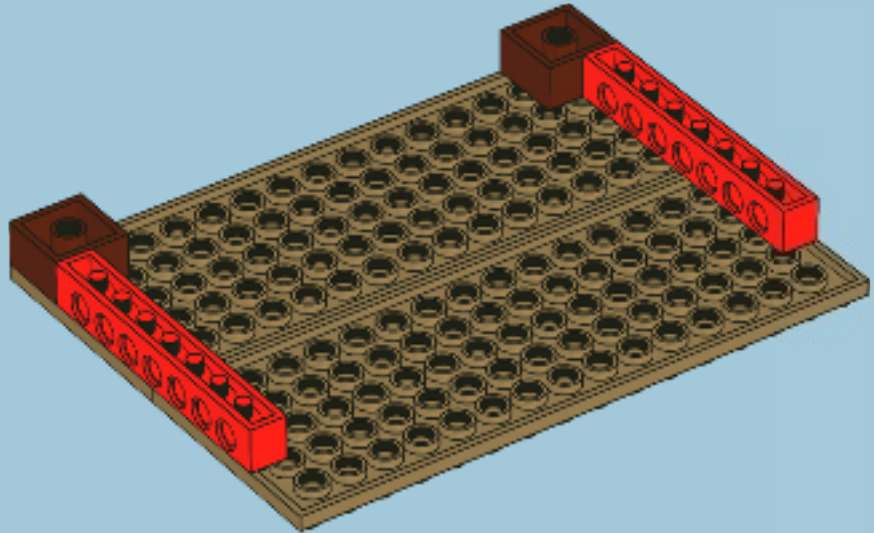



2x

4

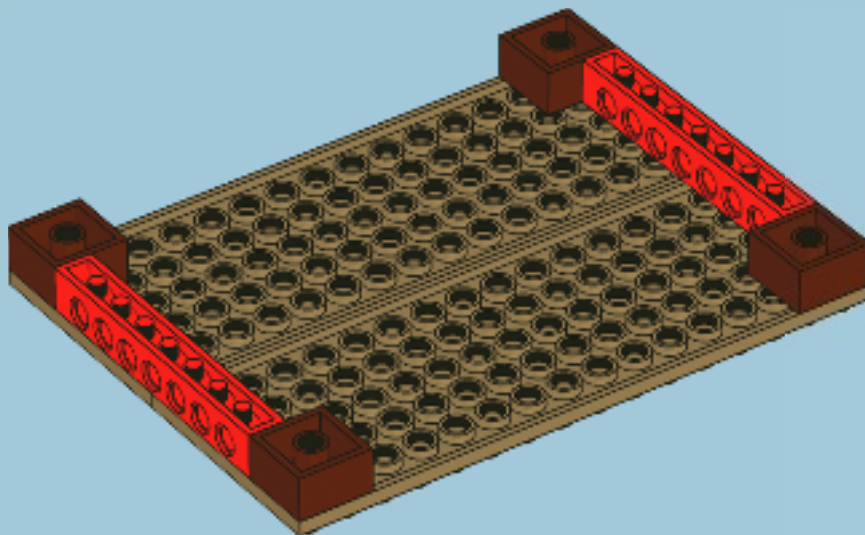

1x



2x

5

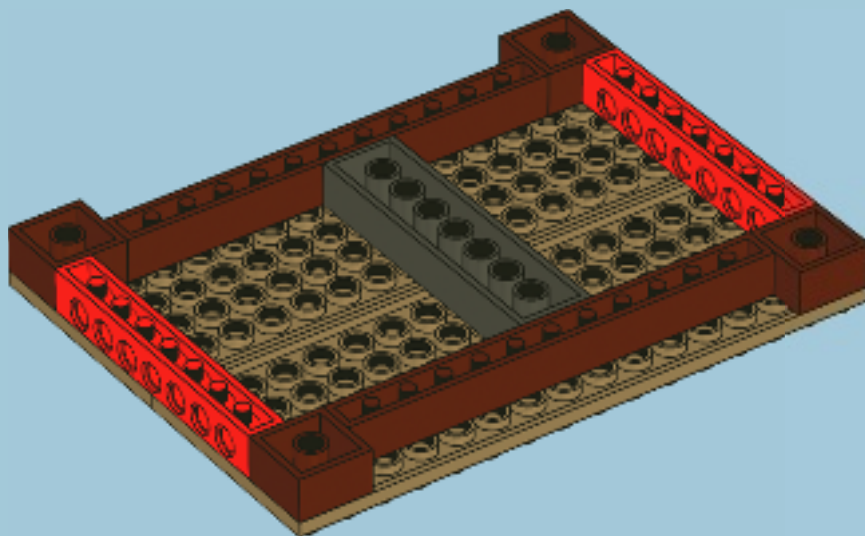



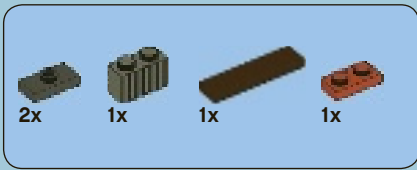

6

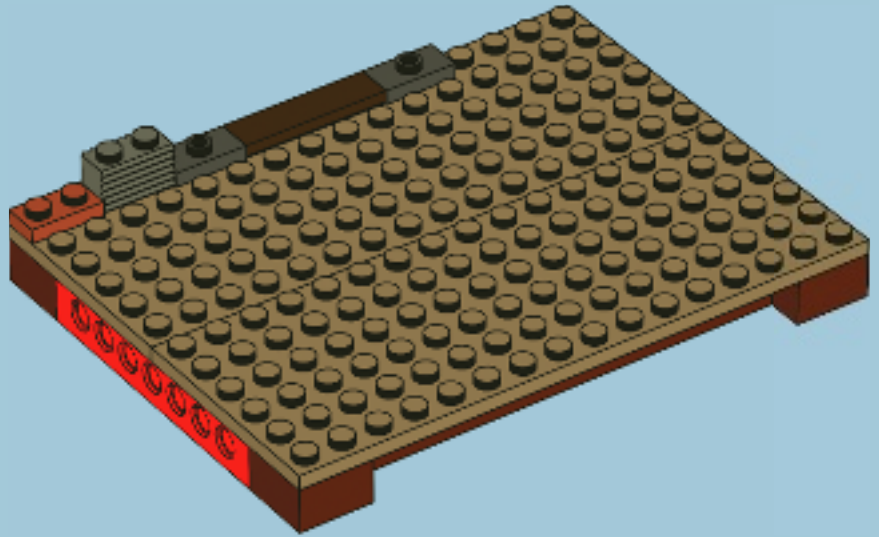

7

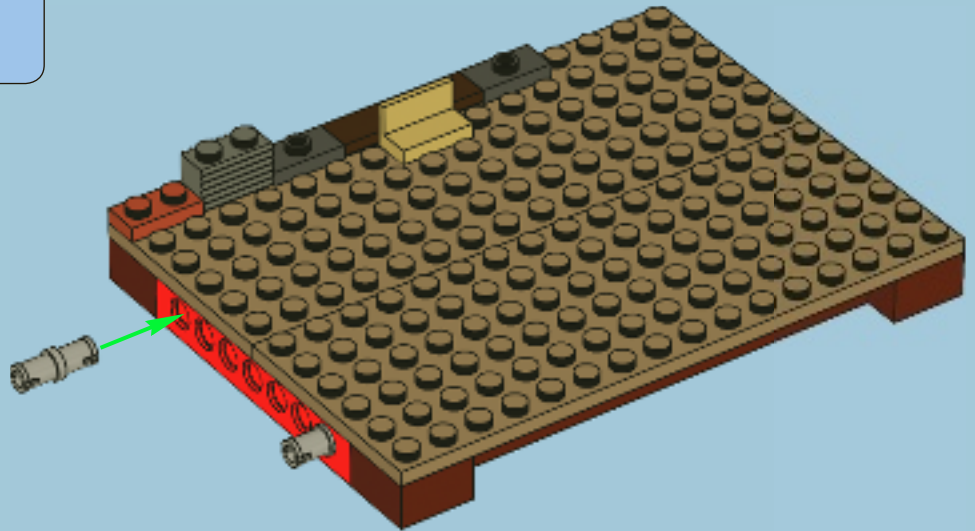



8

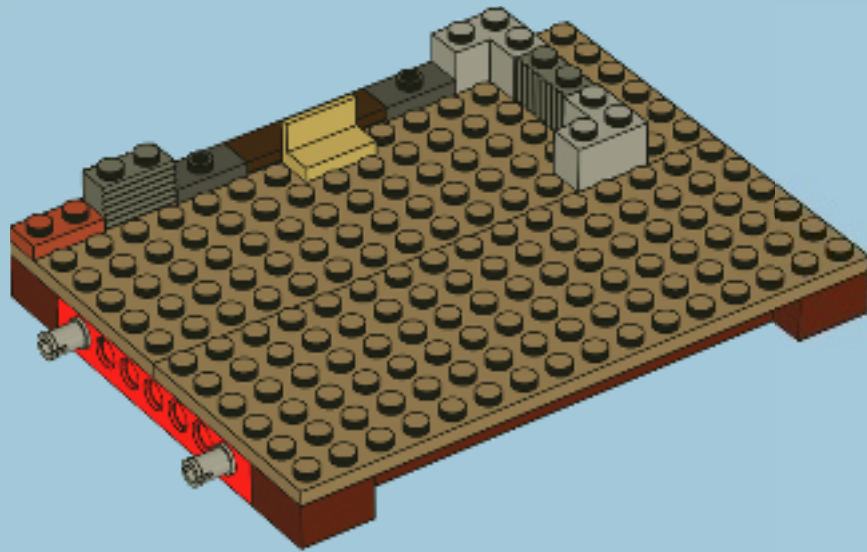

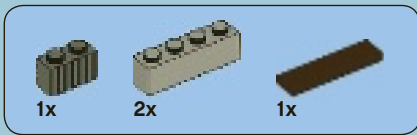

9

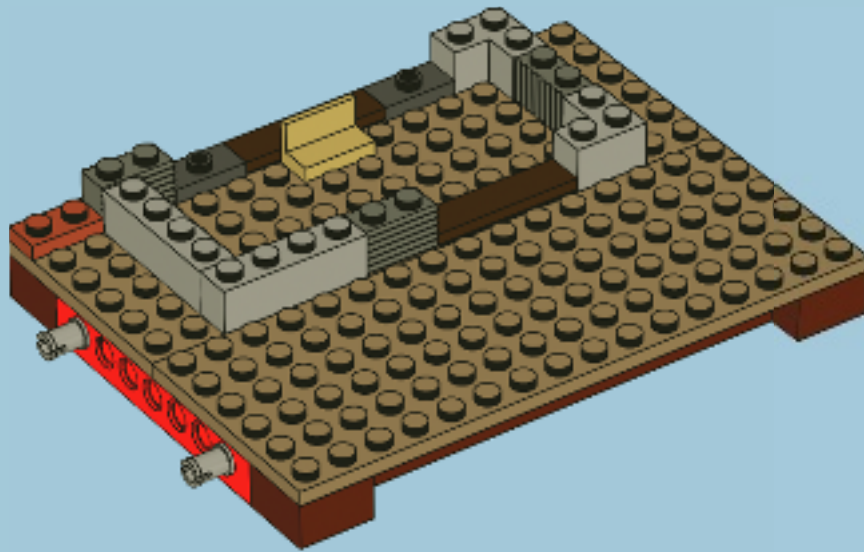



10

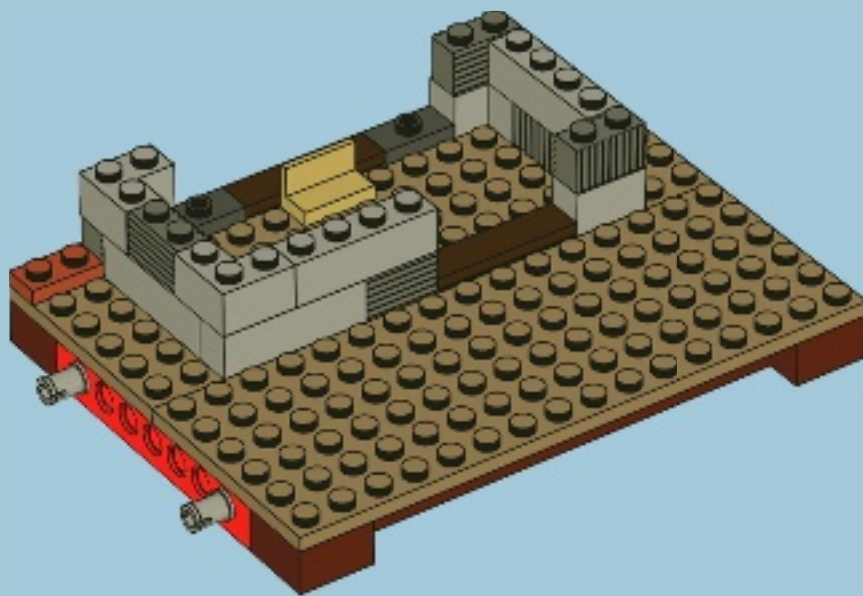



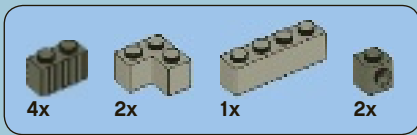

11

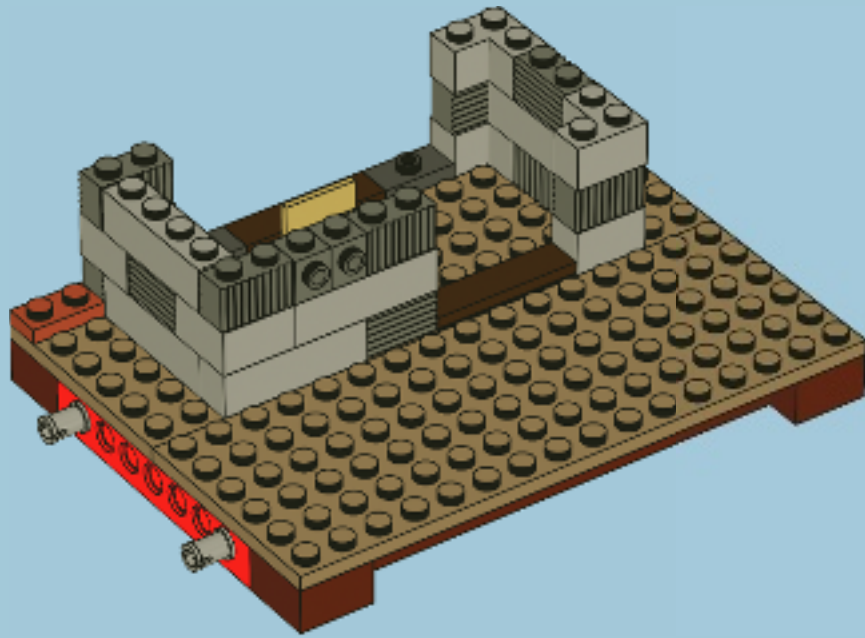

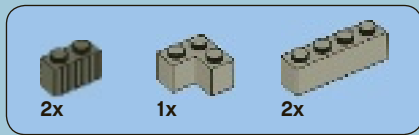

12

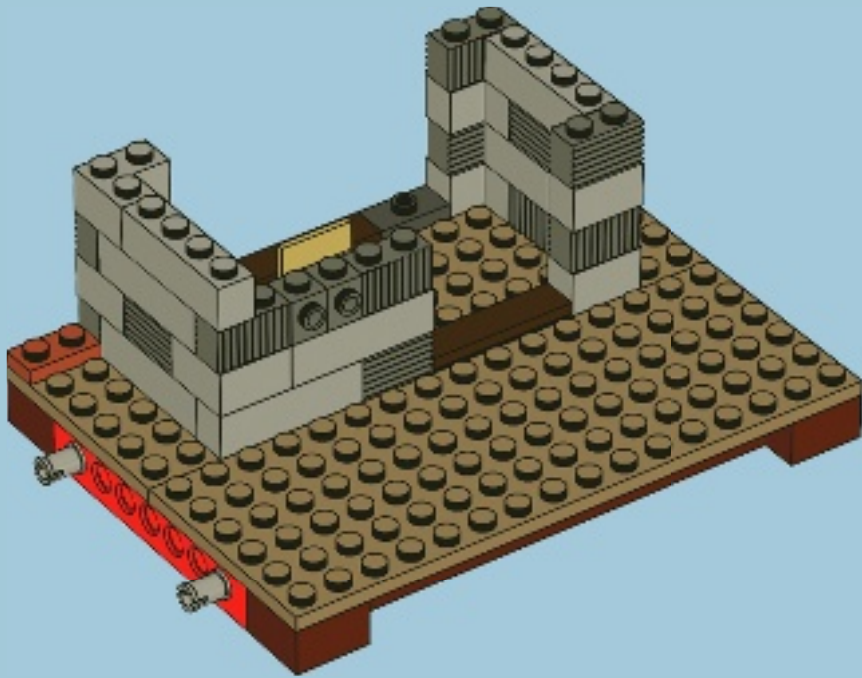

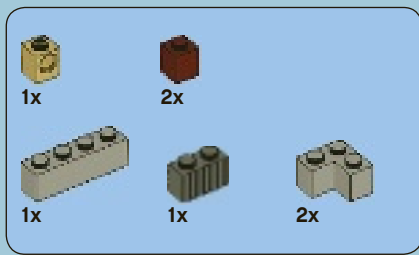

# 13

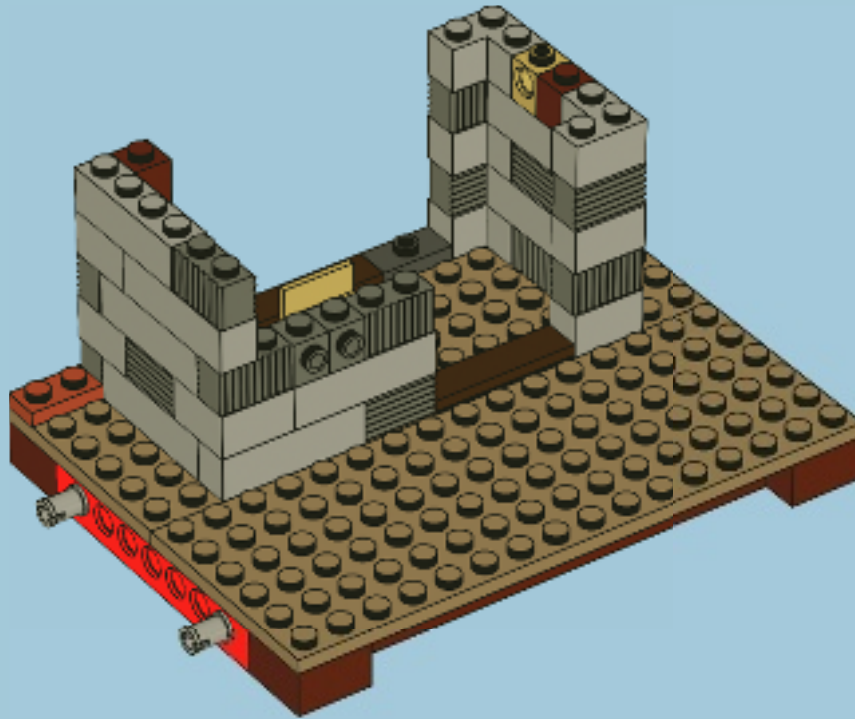

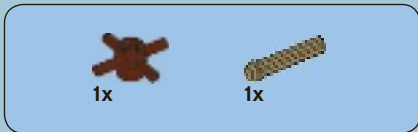

14

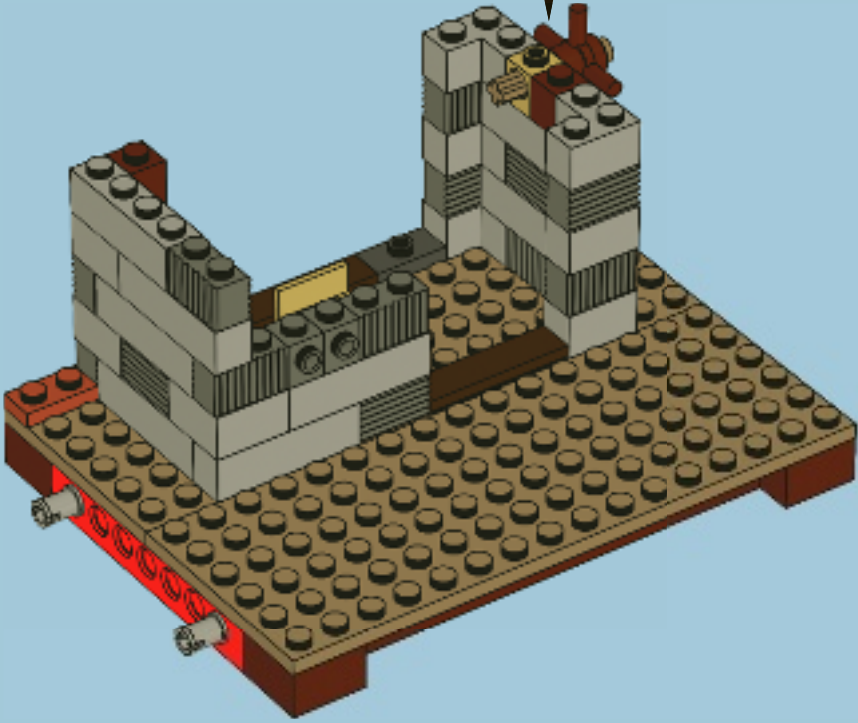
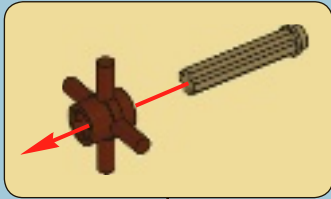



1x



1x

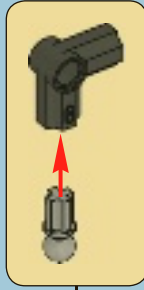

# 15

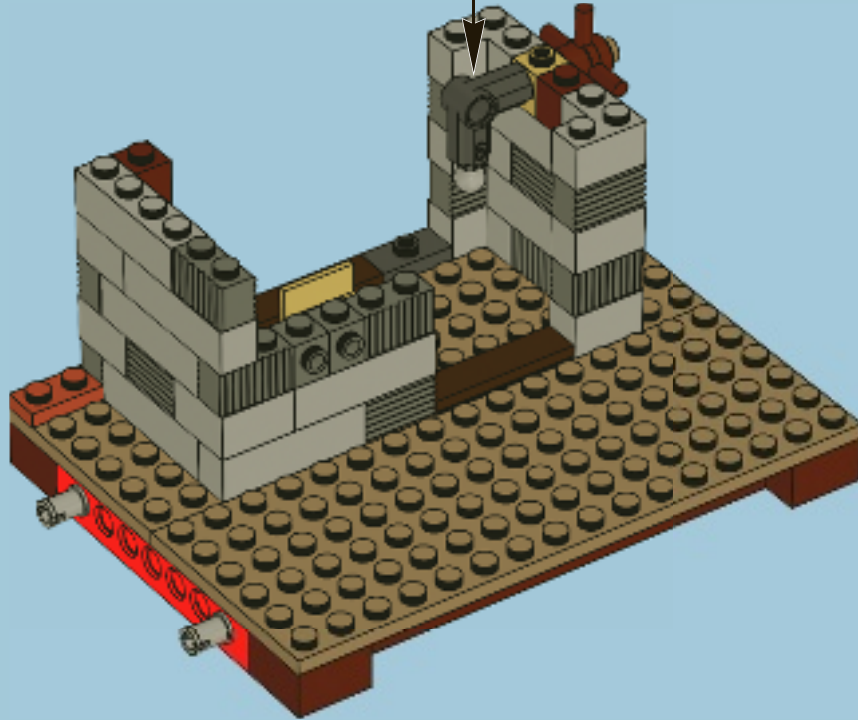





# 16

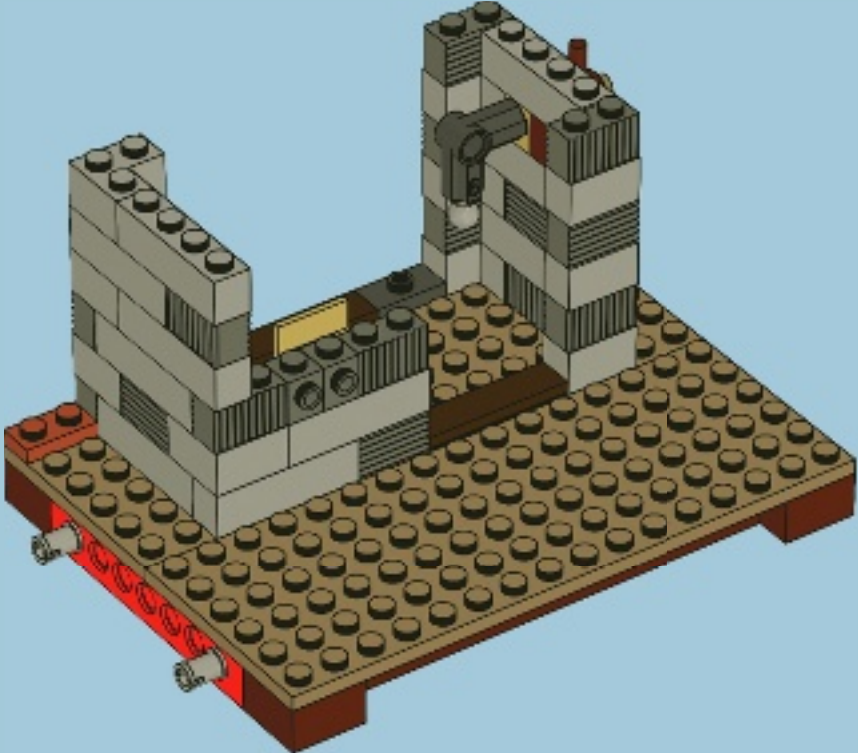

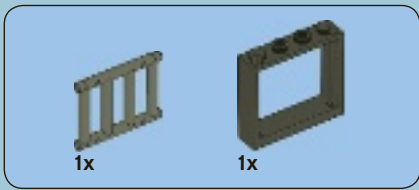

17

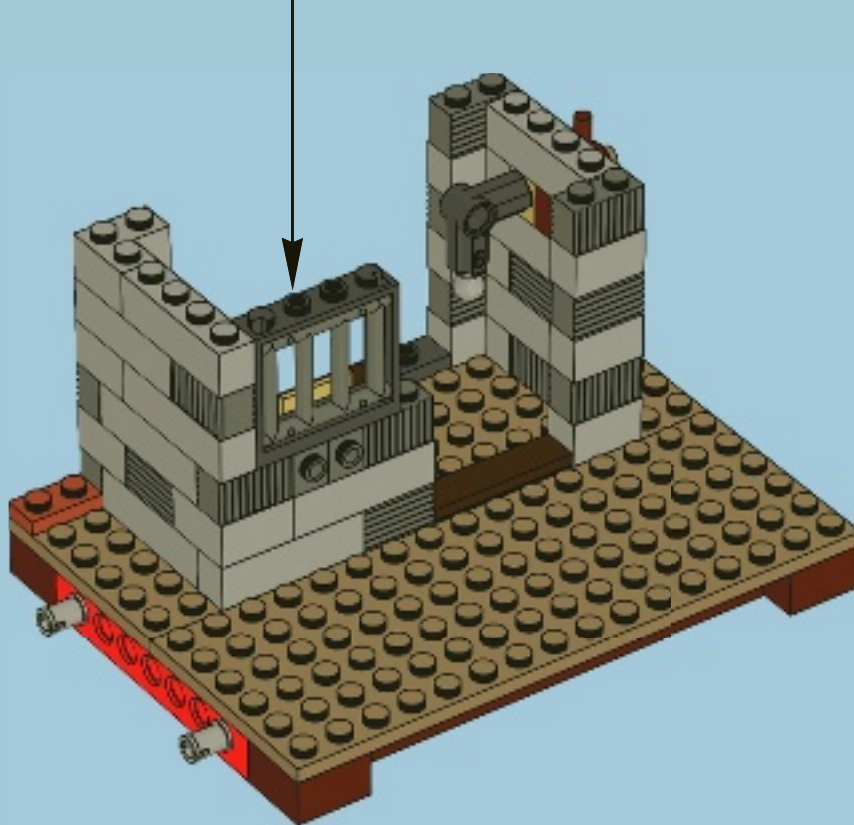
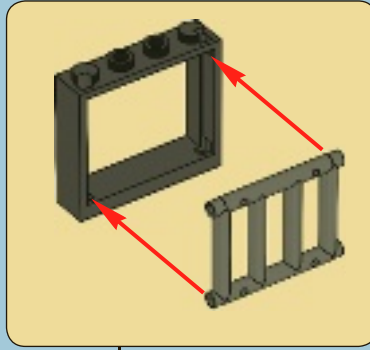



3x

# 18

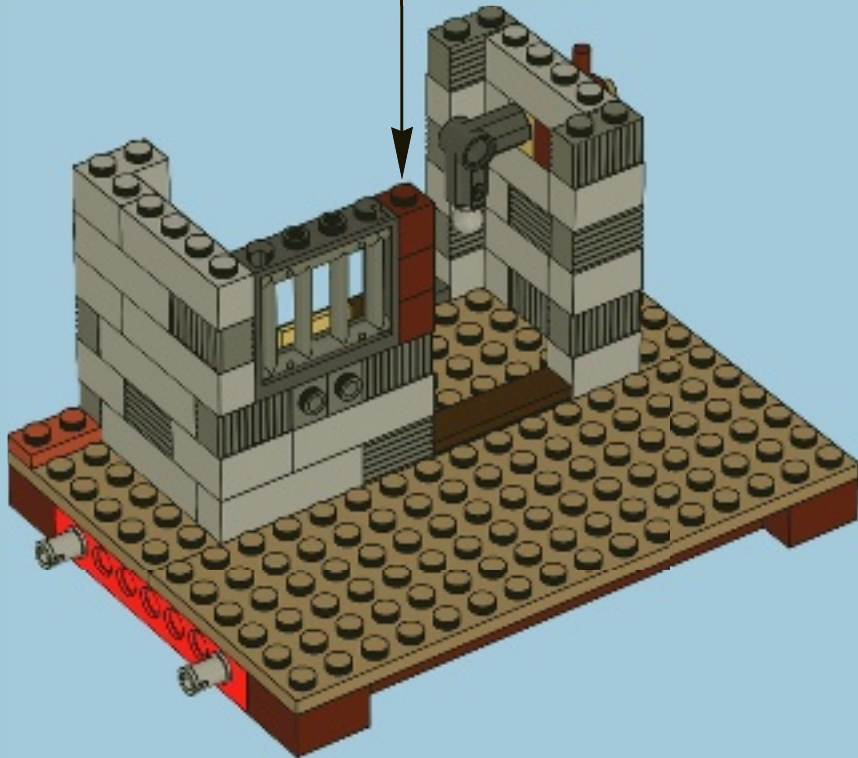
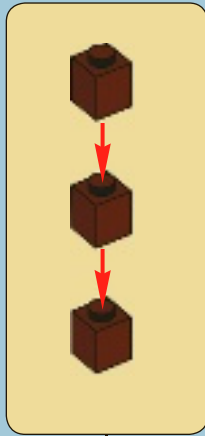

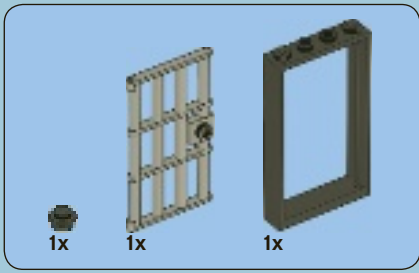

19

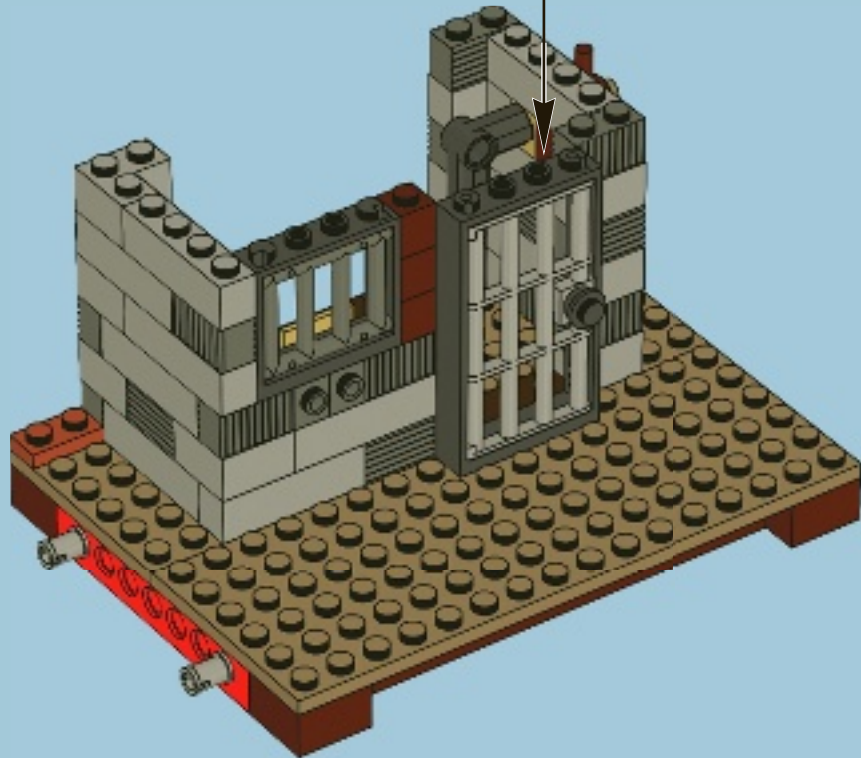
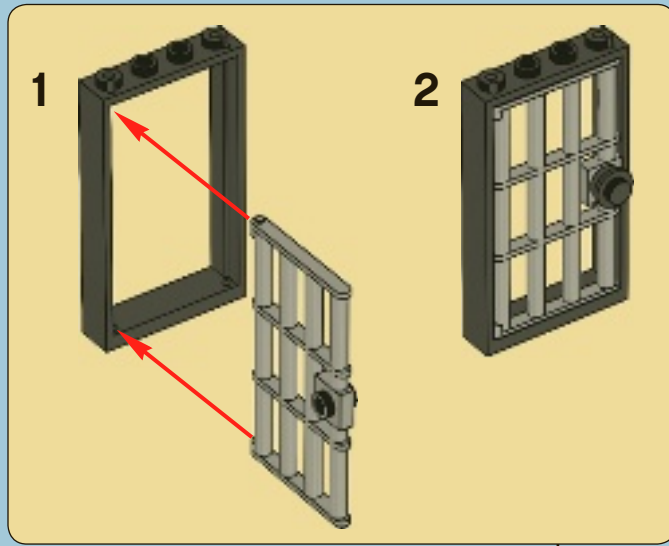

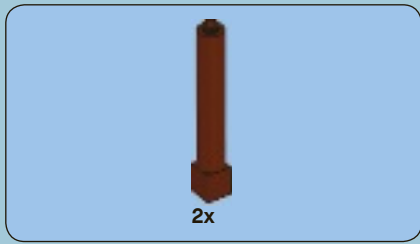

20

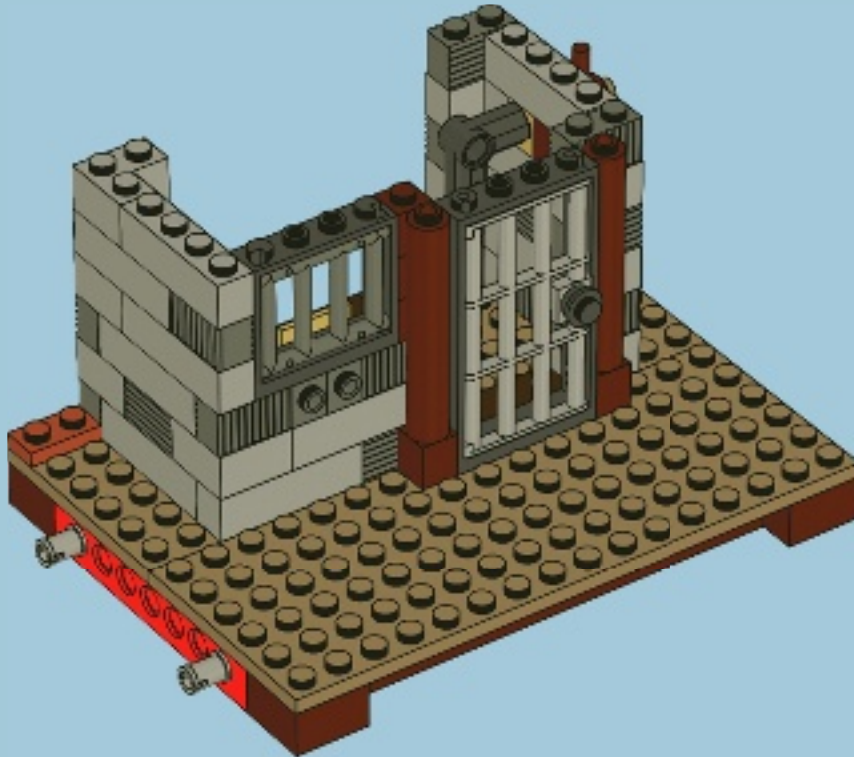



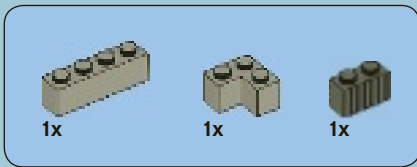

# 21

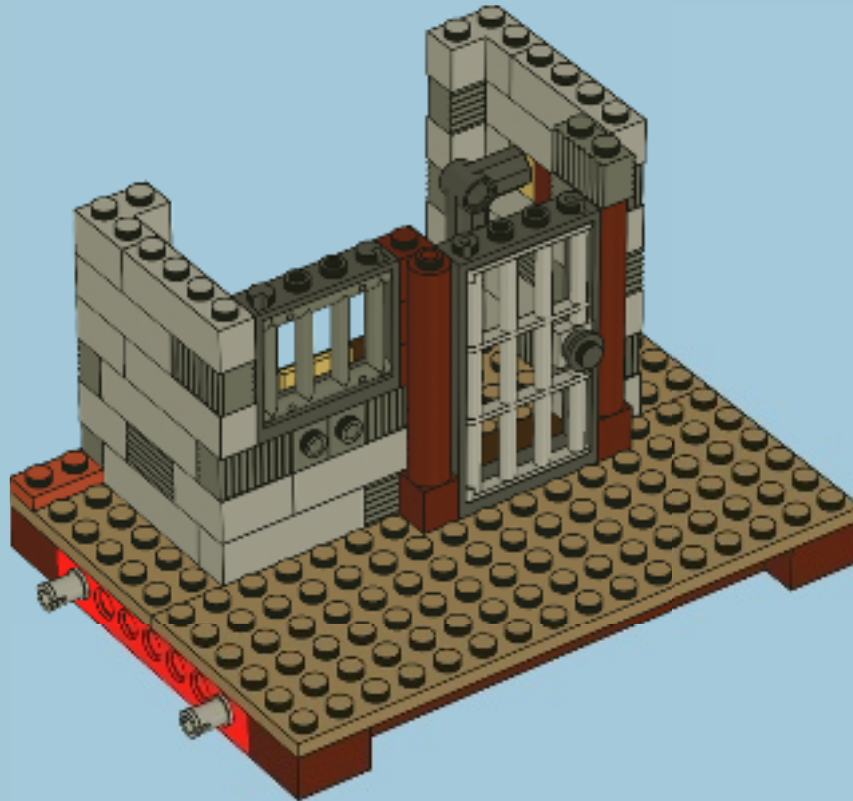



1x



1x

# 22

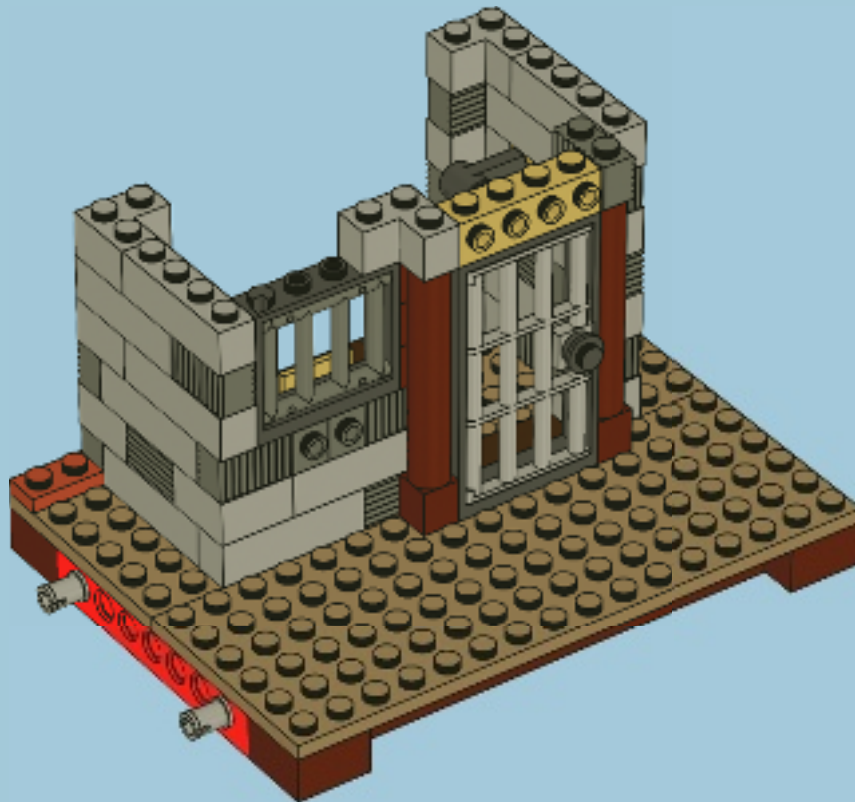

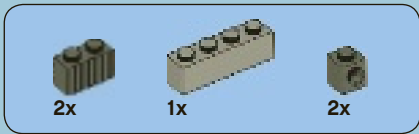

23

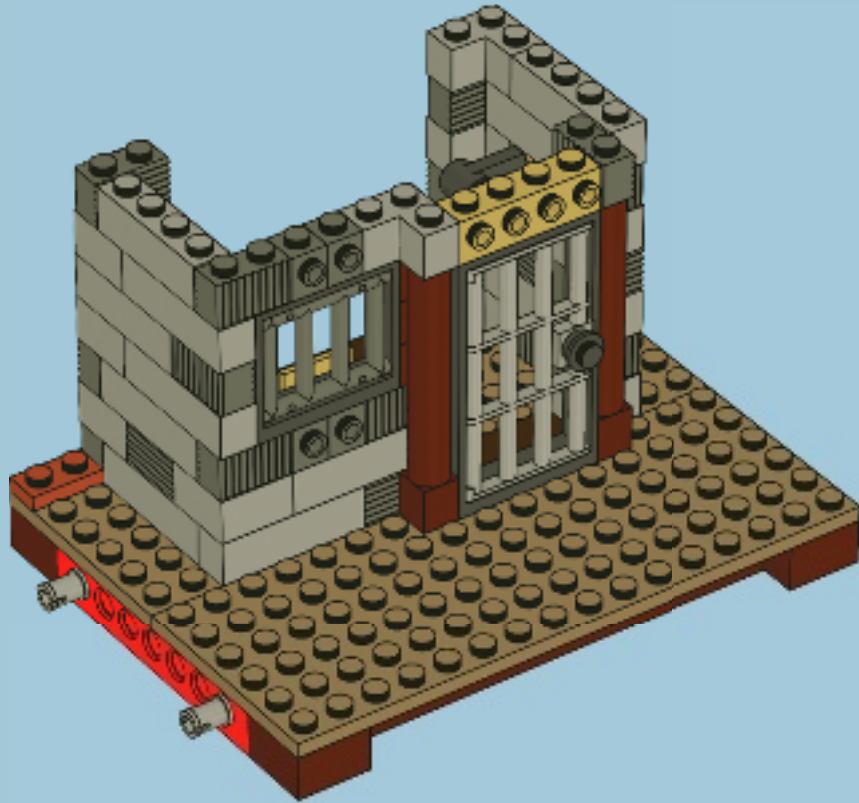



3x

# 24

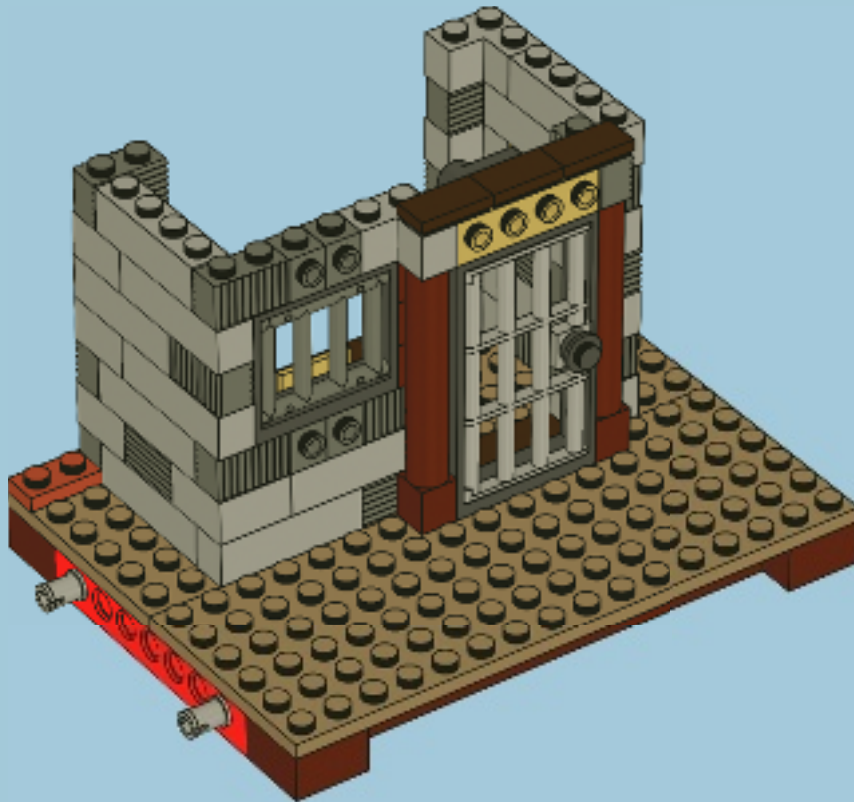

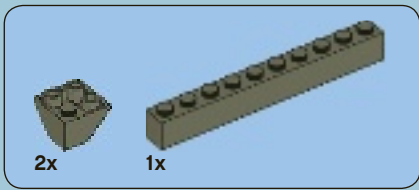

25

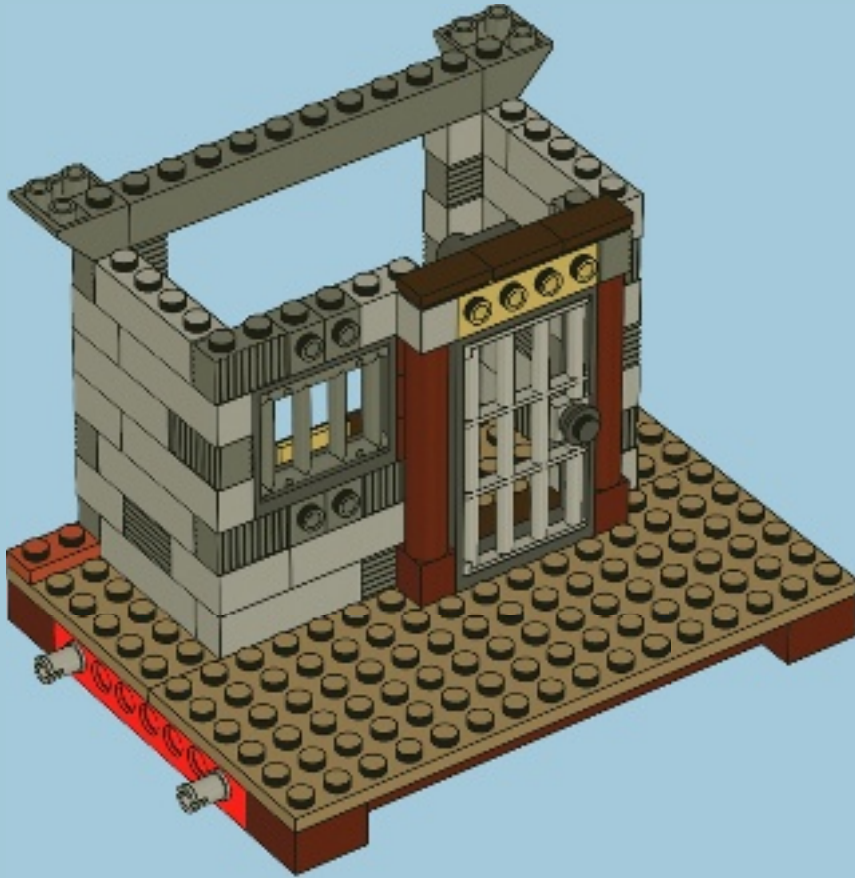





4x

# 26

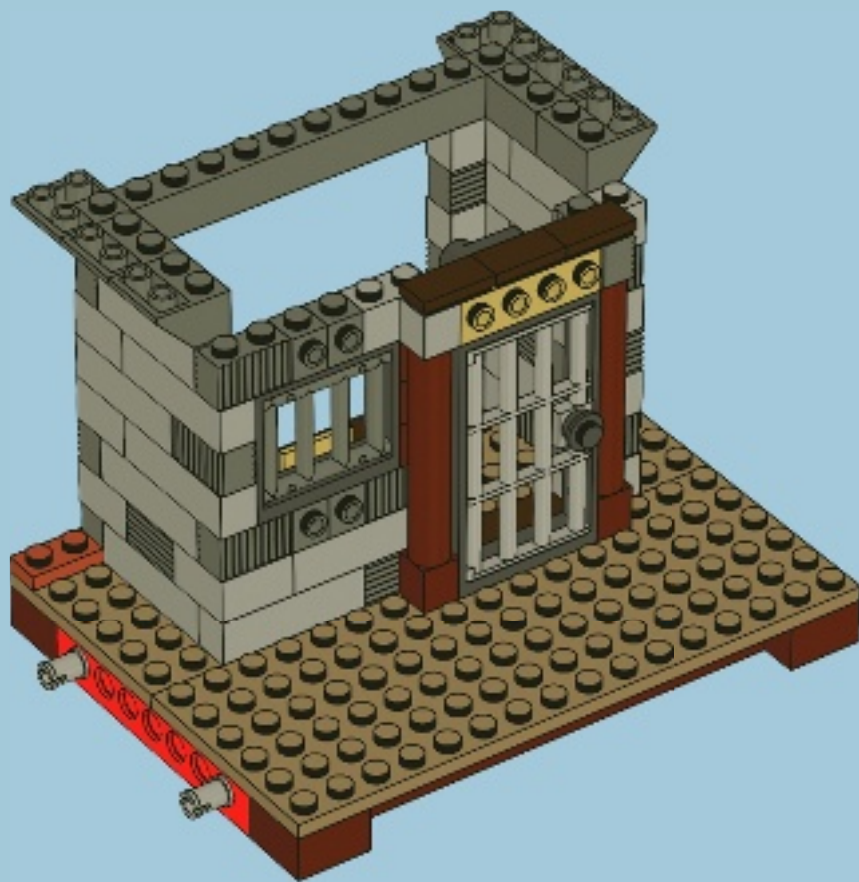

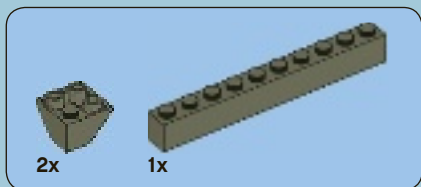

27

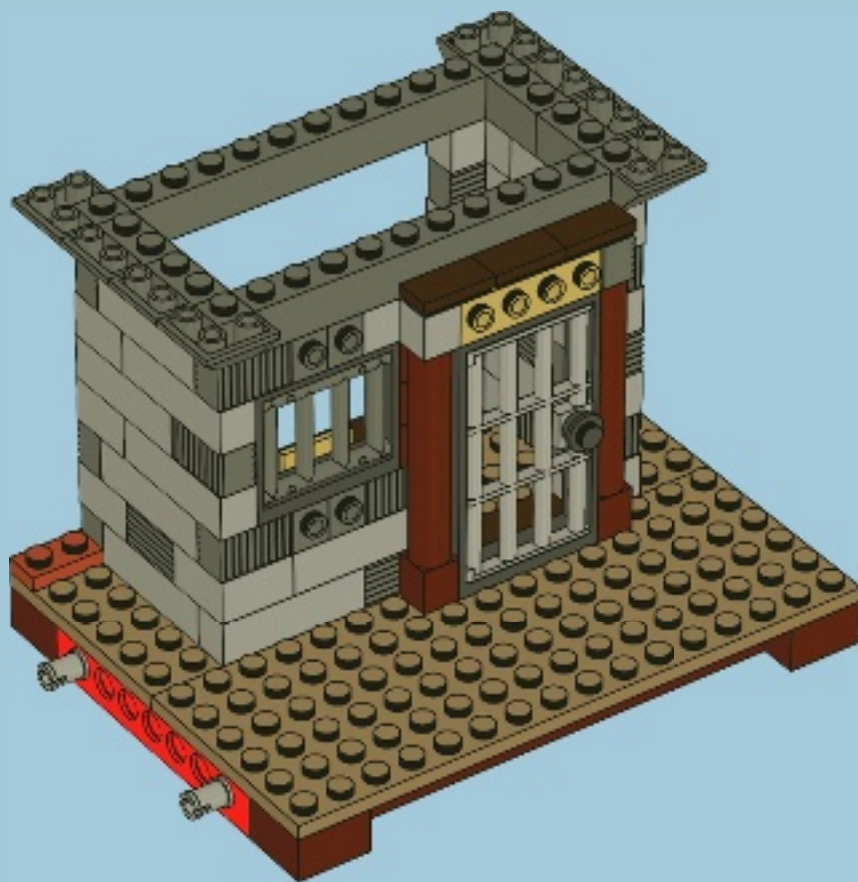

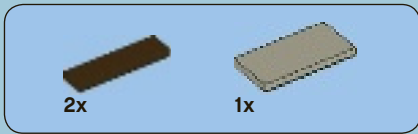

28

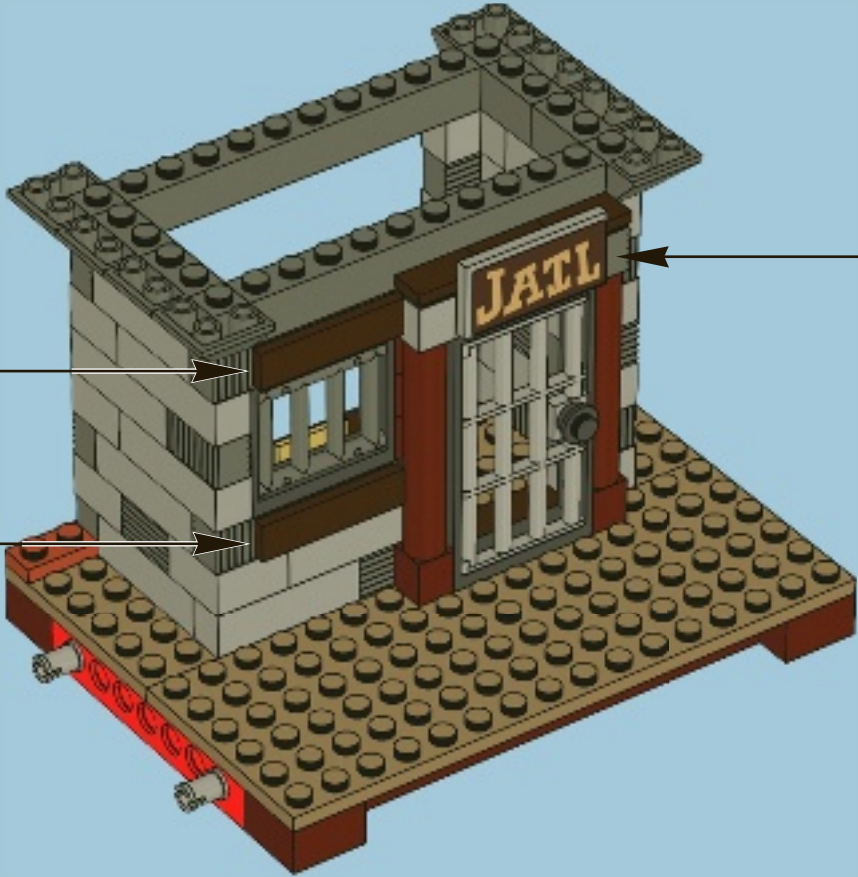
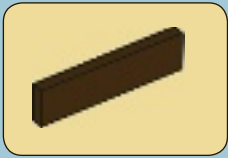
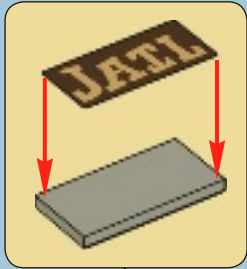

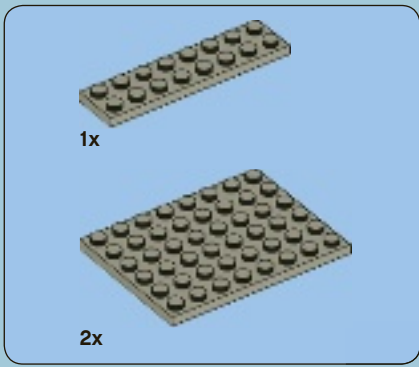

29

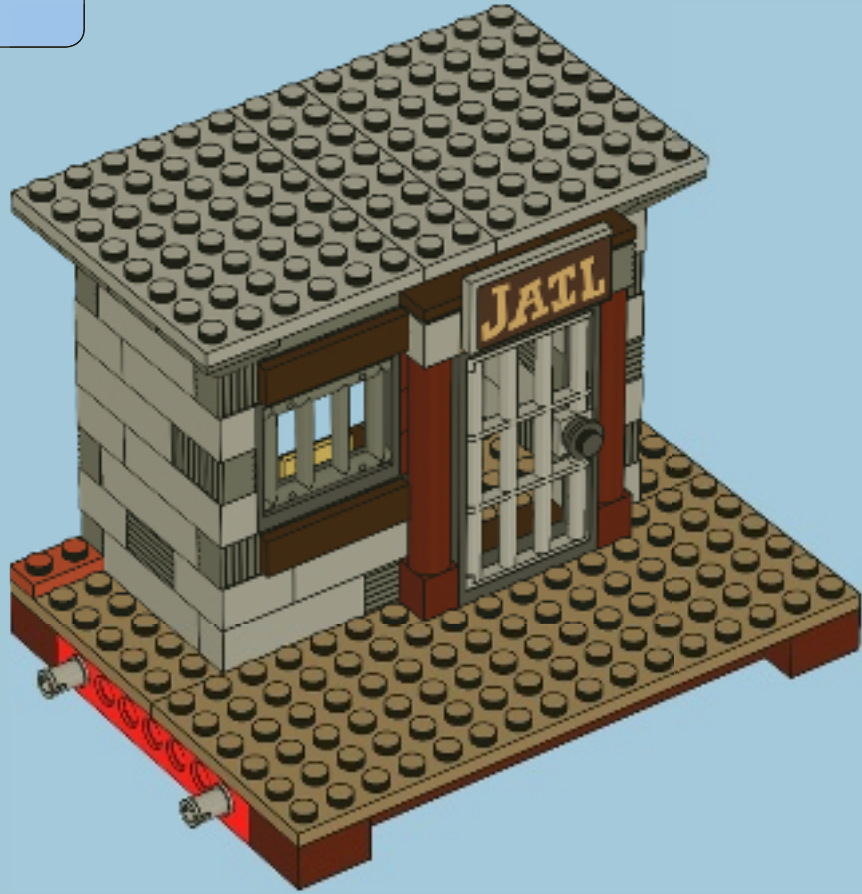



10x

# 30

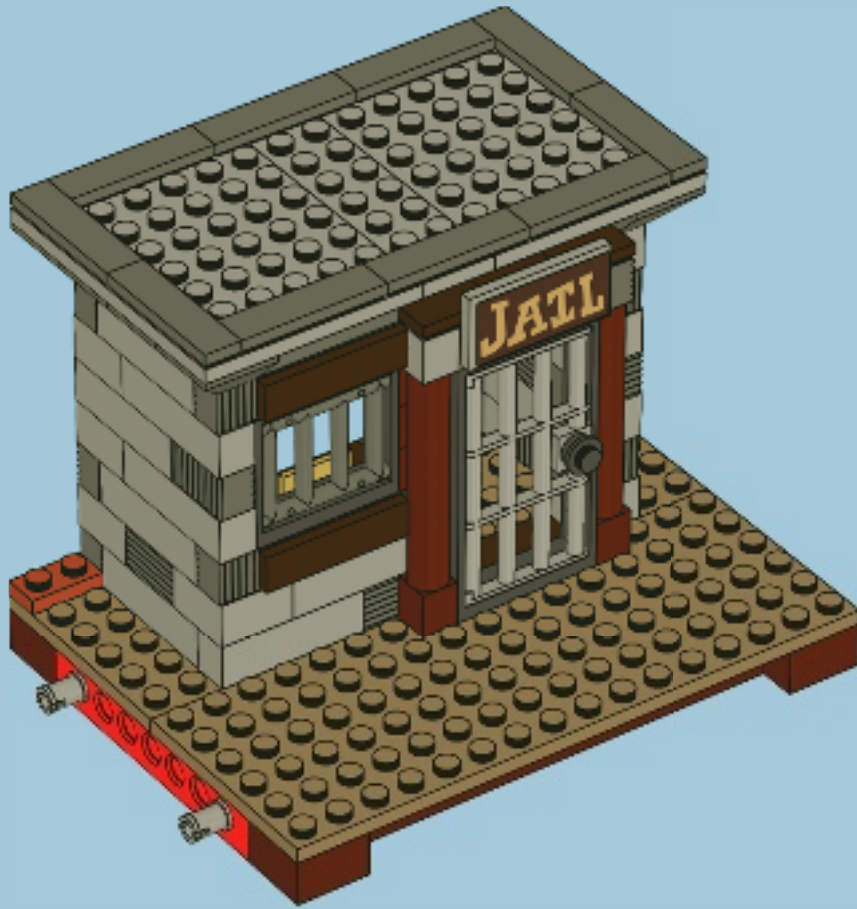



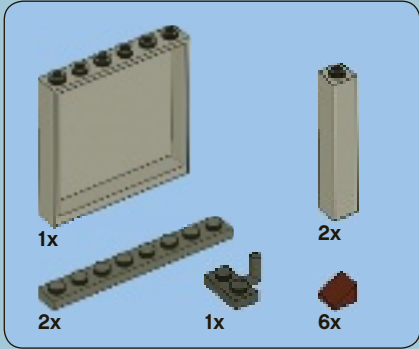
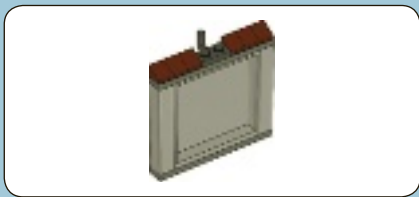

**31**

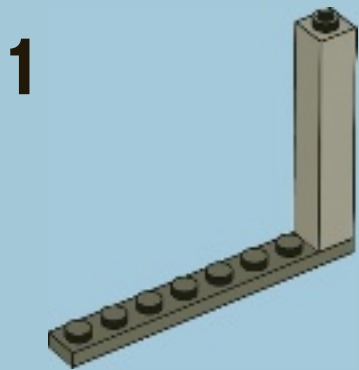

**2**

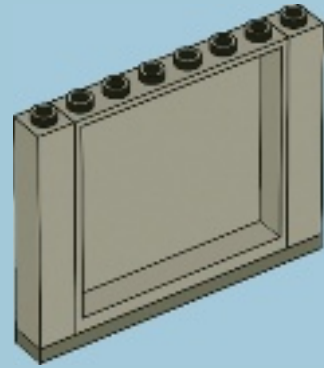

**3**

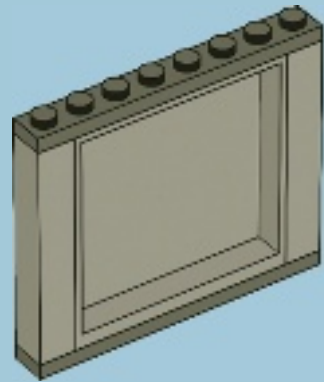

4

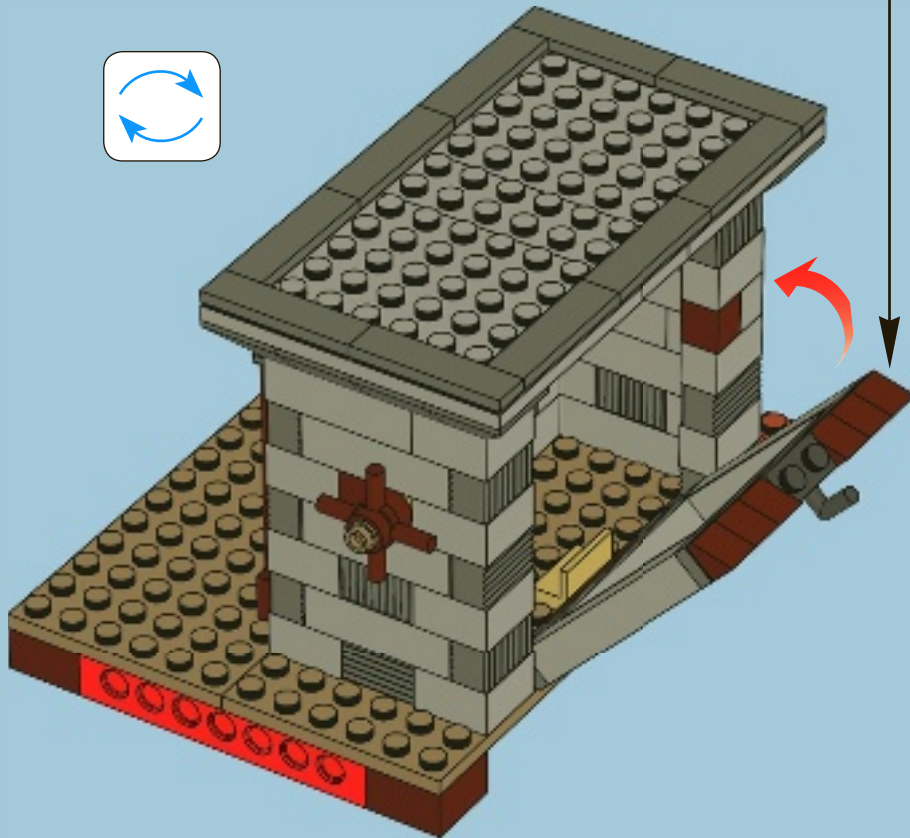
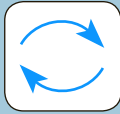
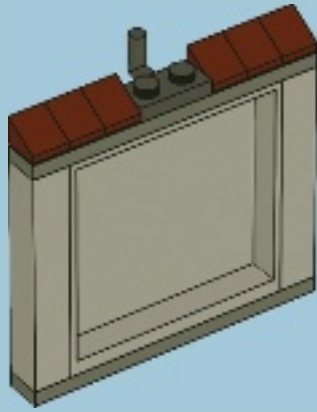

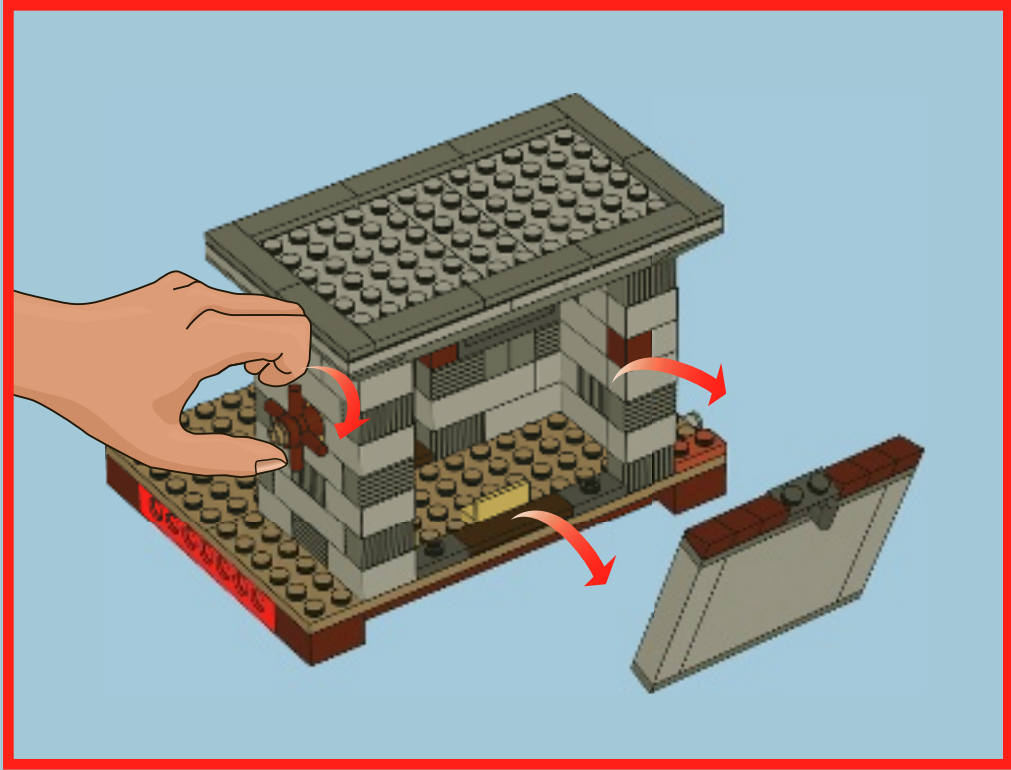



1x



2x

# 32

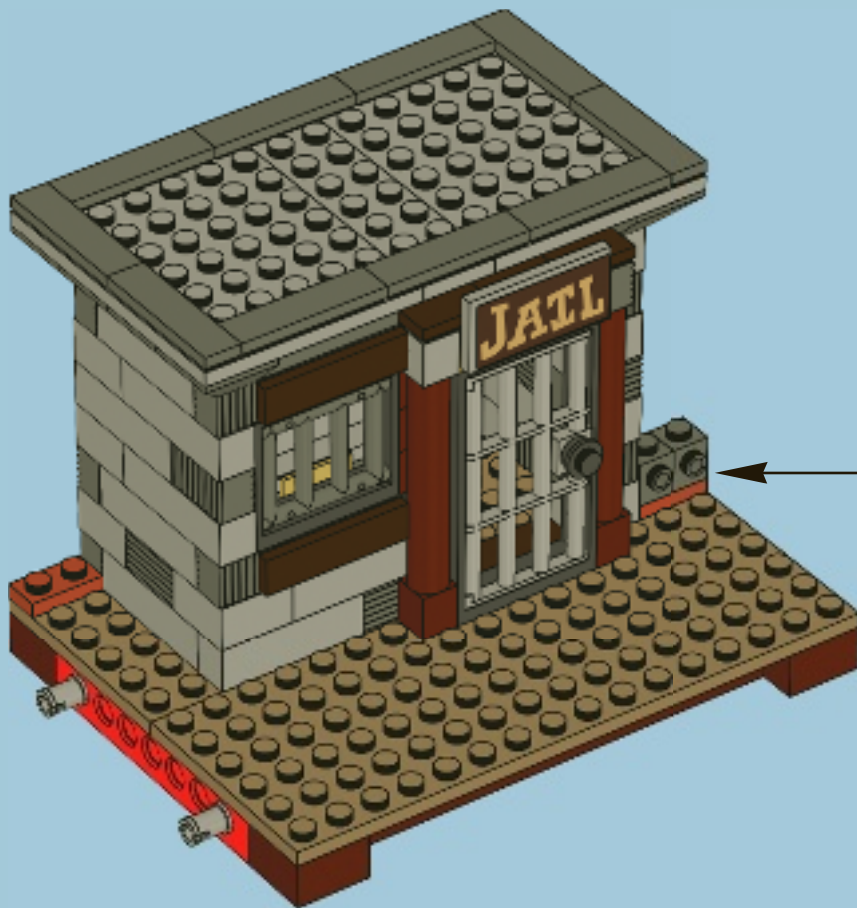

1



2

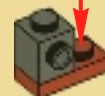



# 33

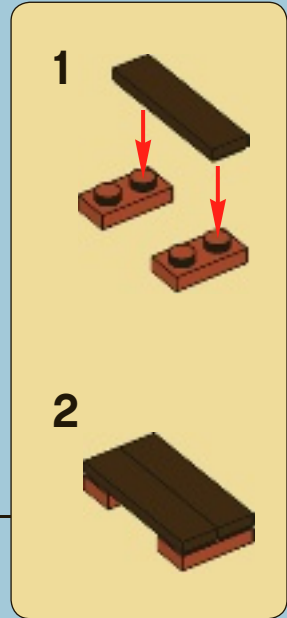
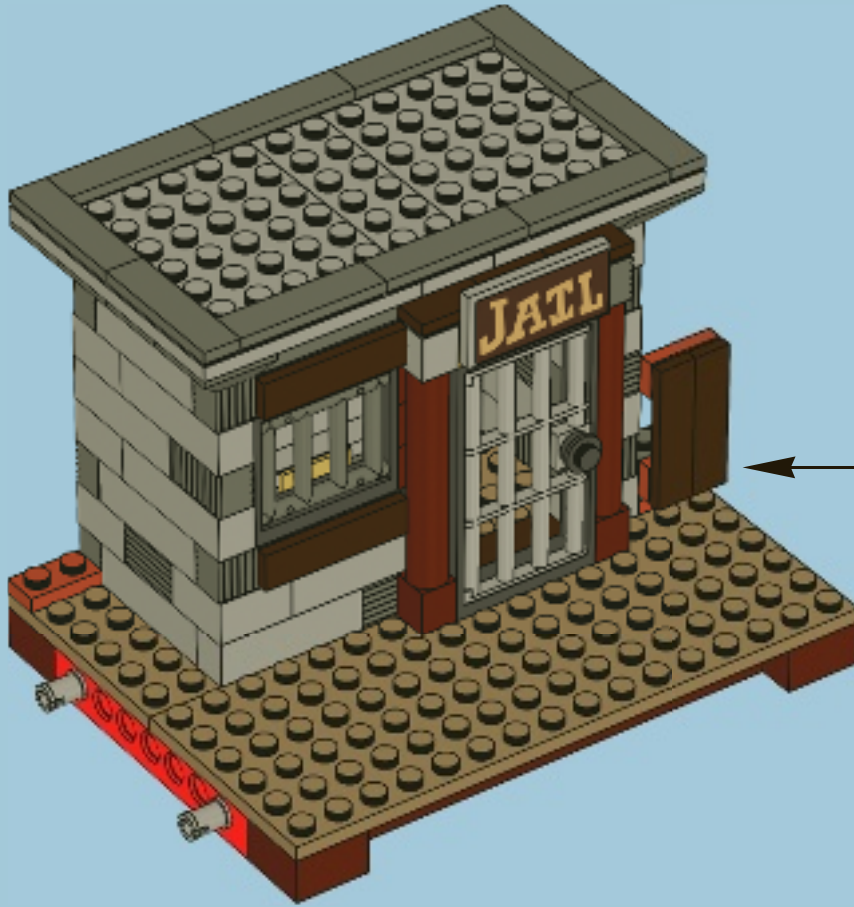

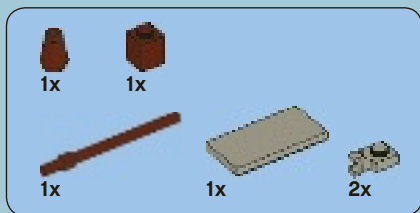

# 34

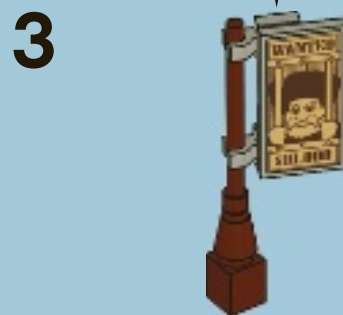
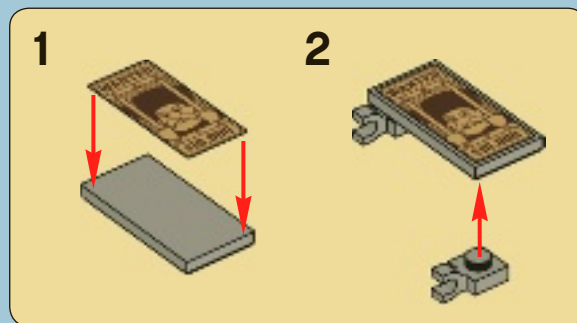
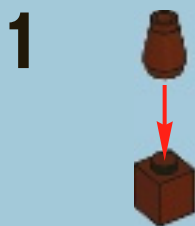

35

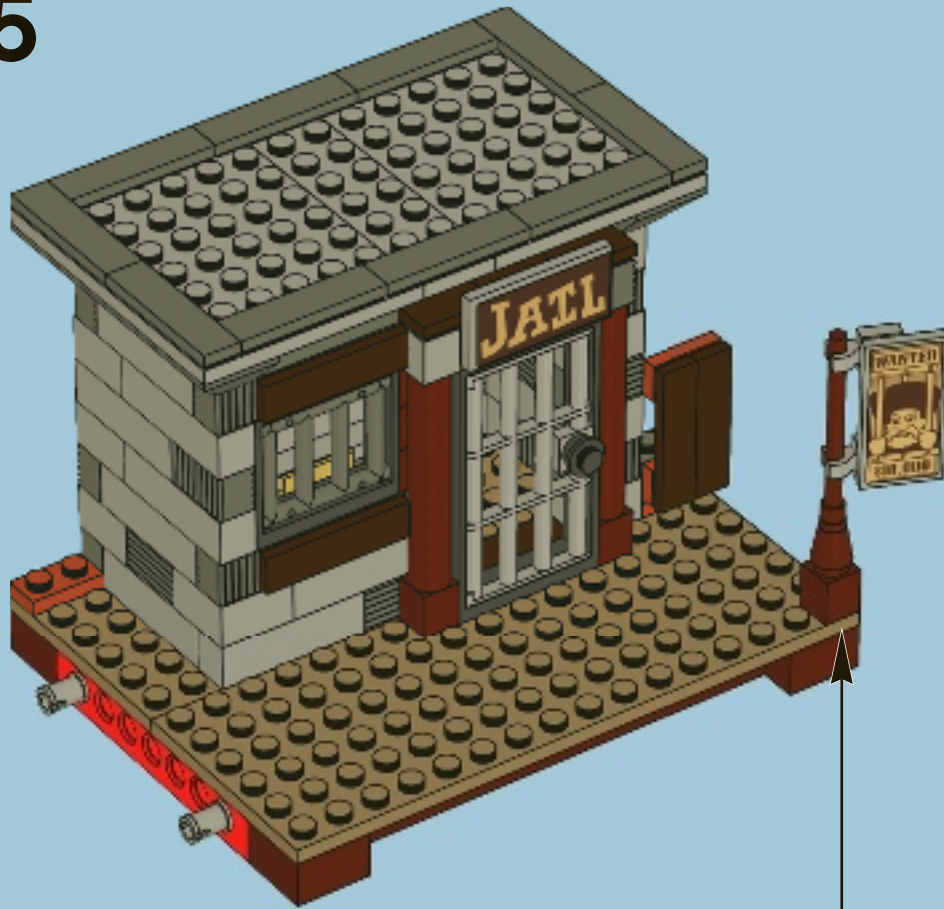





# 36

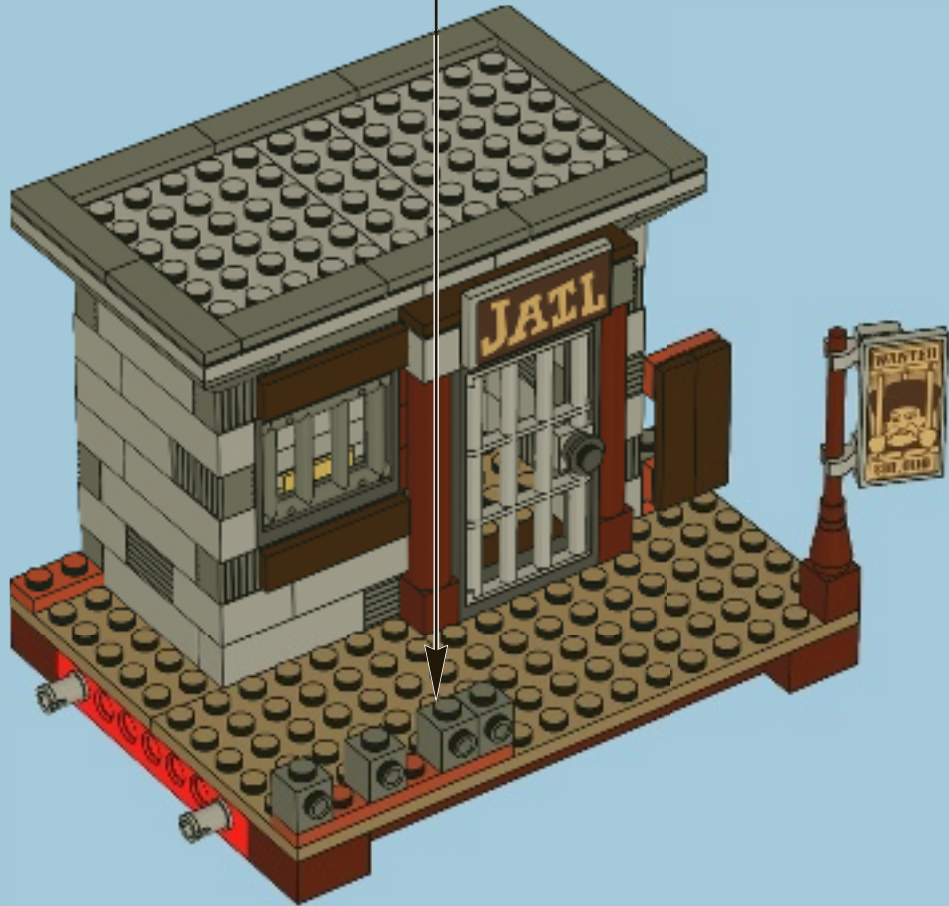
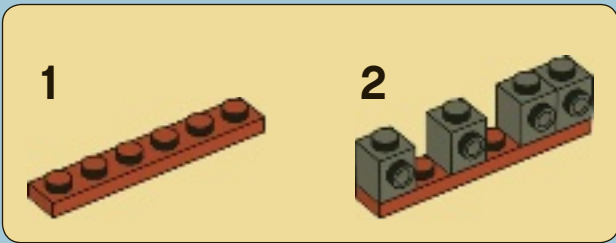



37

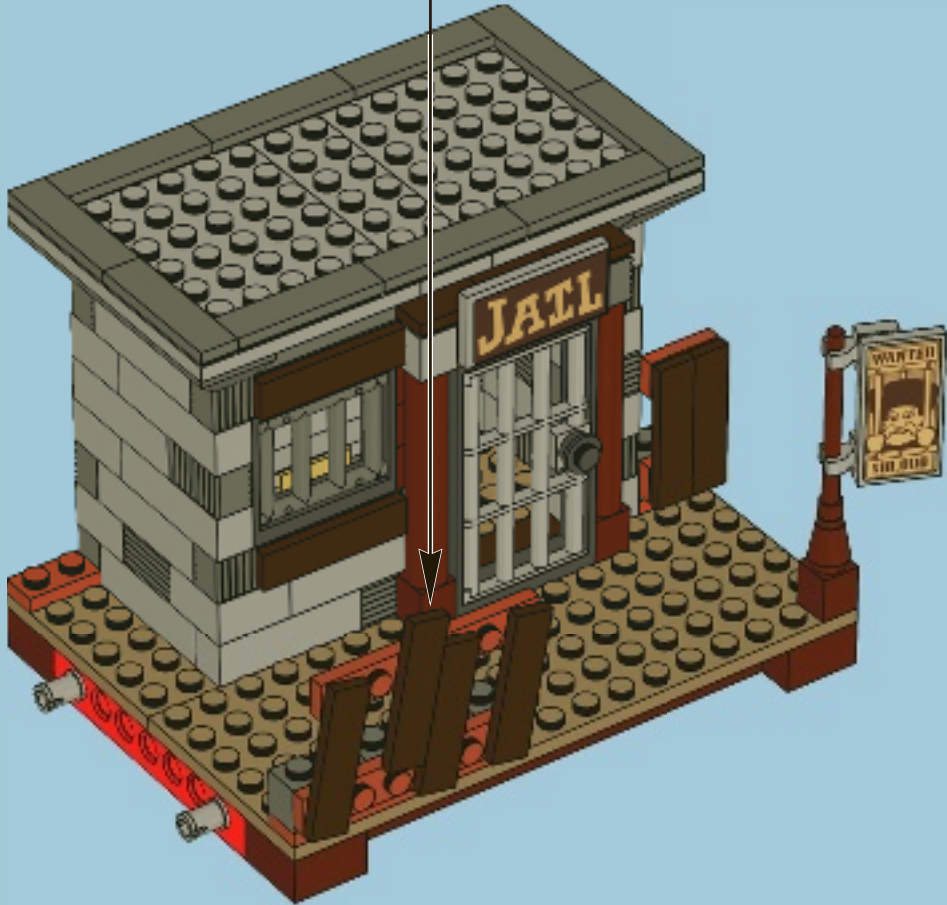
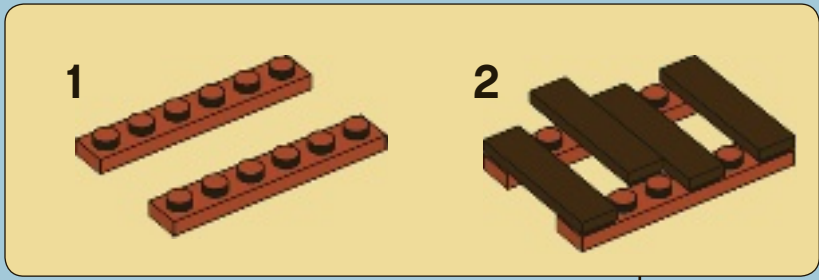

38

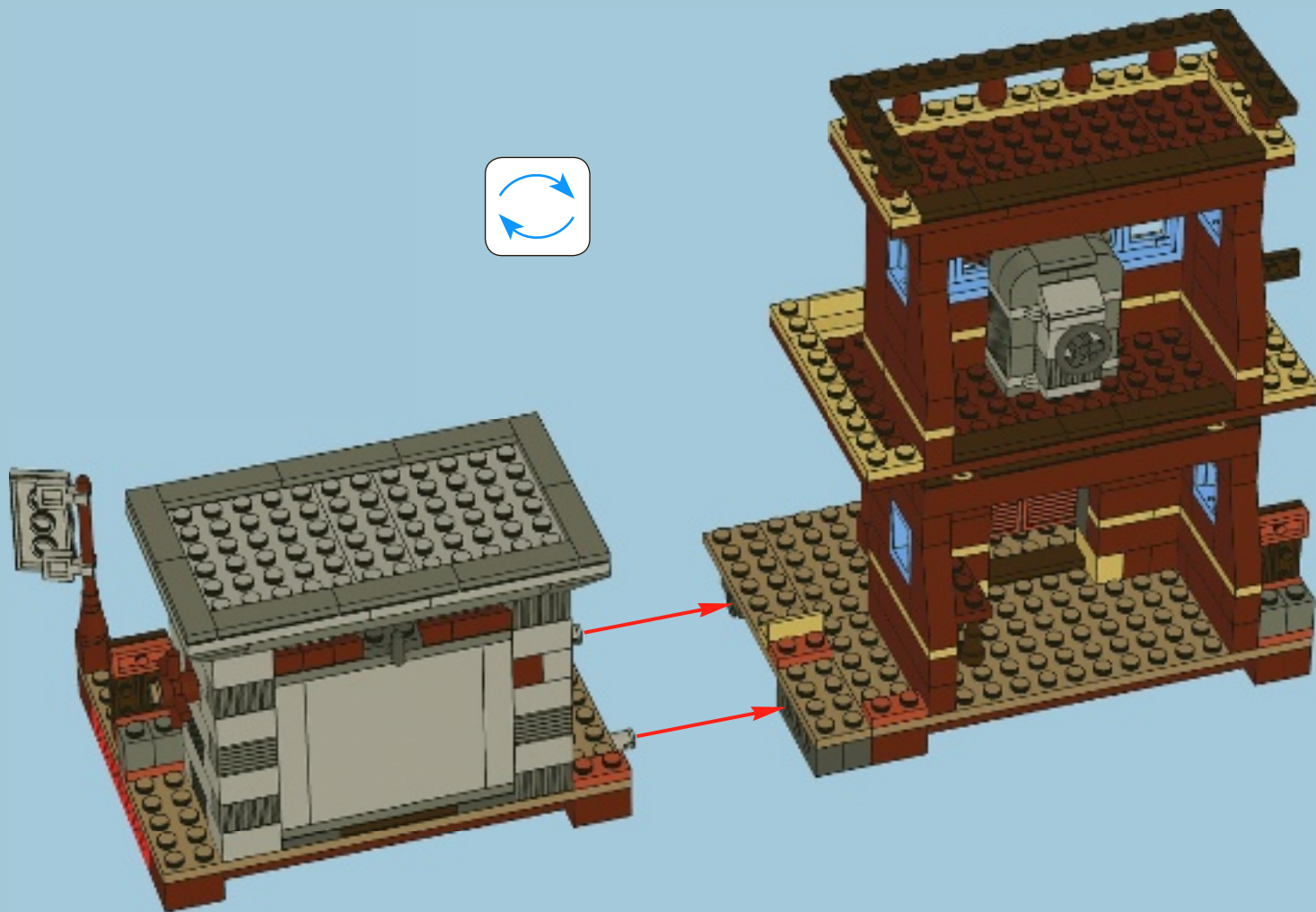
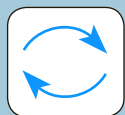

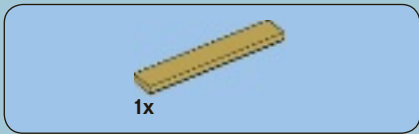

39

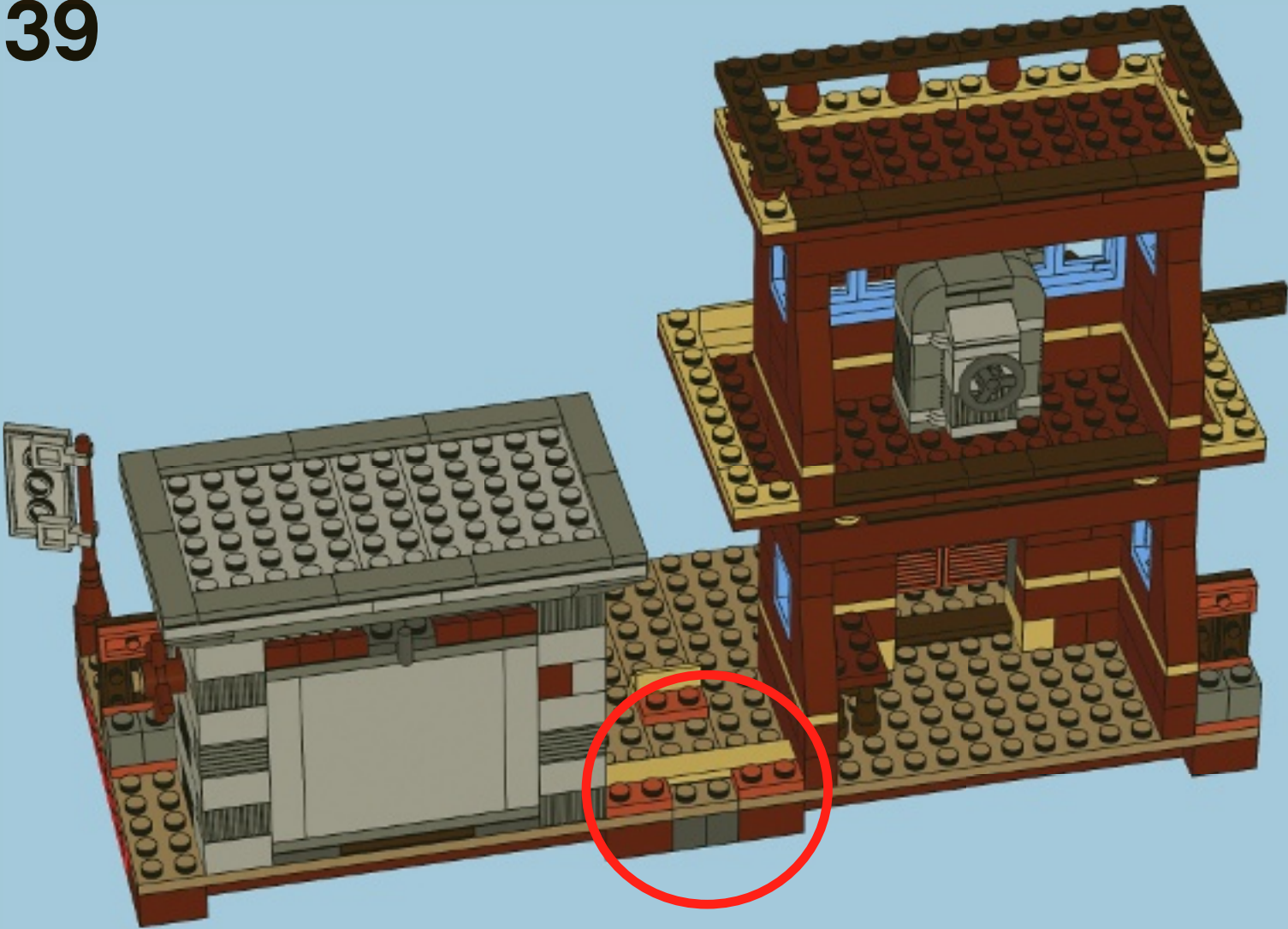





40

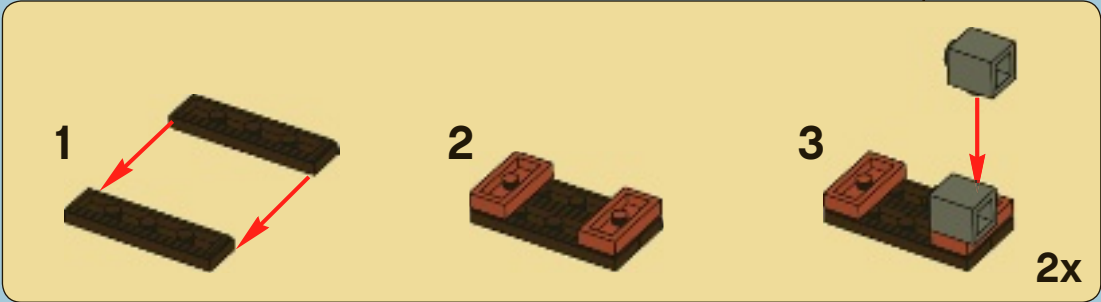
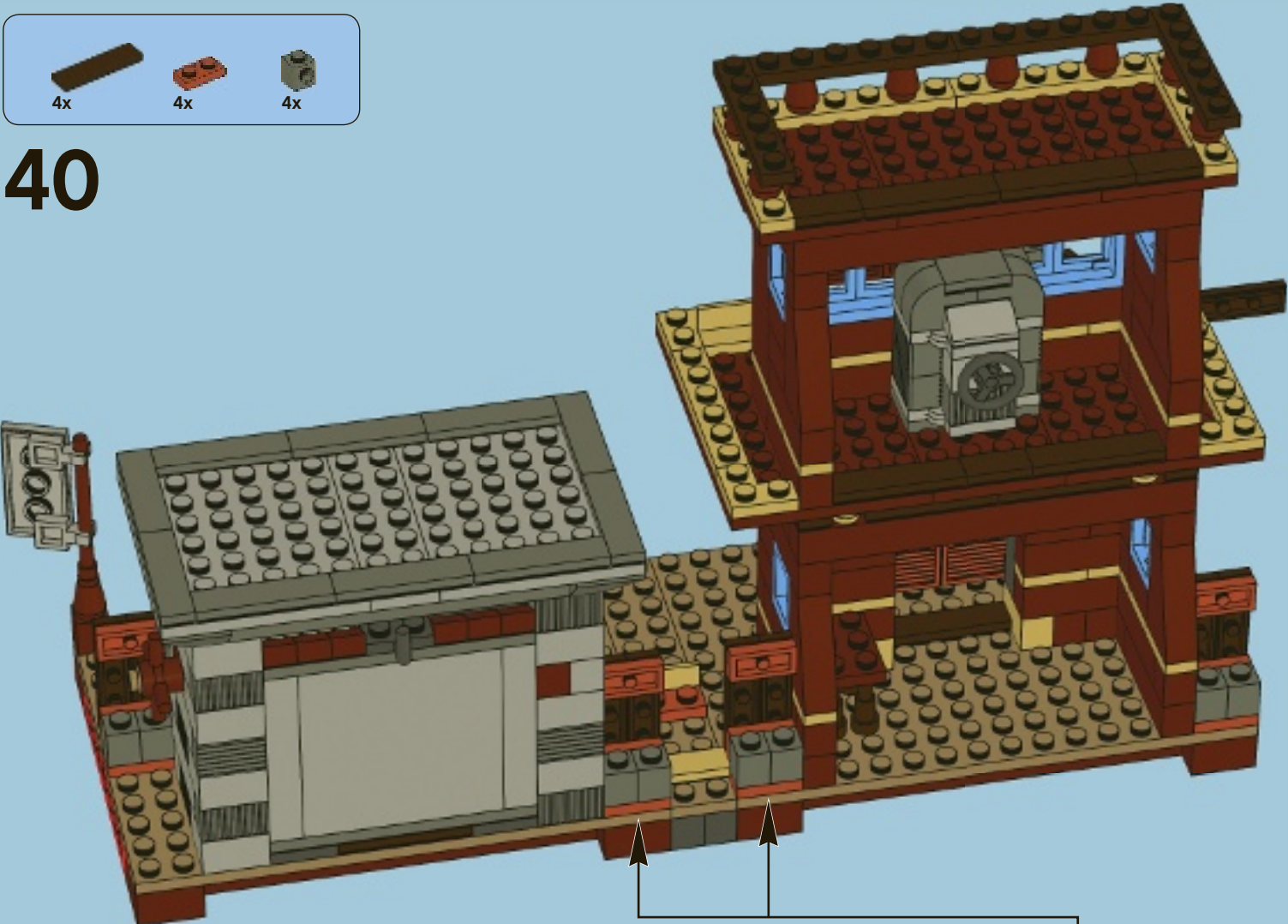









Disney · PIXAR  
**Toy  
STORY**



**7590**



**7593**





Disney · PIXAR  
**Toy  
Story**

LEGO and the LEGO logo are trademarks of the LEGO group.  
©2010 The LEGO group.  
© Disney/Pixar.

**7591**



**7592**





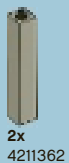

2x  
4211362



4x  
4211389



12x  
4211349



12x  
4211394



1x  
4211440



5x  
4568637



1x  
4211410



3x  
4211398



4x  
4541978



2x  
4219256



1x  
4585429



1x  
4610149



3x  
4211412



2x  
4527174



1x  
4518282



1x  
4211375



4x  
4211807



1x  
4211406

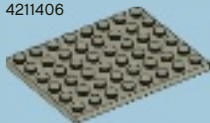

2x  
4211408



2x  
4560183



4x  
4211135



2x  
4221745



4x  
4210862



5x  
4210702



4x  
4211000



4x  
4210797



2x  
4211099



2x  
4211107



2x  
4513326



1x  
4211006



1x  
4211007



1x  
4211055



22x  
4558955



23x  
4210636



1x  
4211065



2x  
4210998



1x  
4521886



1x  
4220973



10x  
4211053



1x  
4528713



10x  
4566688



35x  
4536989



4x  
4566704



1x  
4570876



4x  
4538950



1x  
4267874



1x  
4246957



1x  
4566927

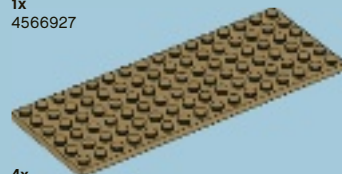

4x  
4570878



Customer Service

Kundenservice

Service Consommateurs

Servicio Al Consumidor

[www.lego.com/service](http://www.lego.com/service) or dial



00800 5346 5555 :



1-800-422-5346 :





FREE! GRATIS! GRATUIT!



club  
MAGAZINE™

www.LEGOclub.com



00800 5346 5555\*

1-866-534-6258 • 1-877-518-5346

US & Canada only

Canada seule ment



VISIT THE WORLD'S  
BIGGEST LEGO® SHOP!

[www.LEGOshop.com](http://www.LEGOshop.com)

\* Freephone. Mobile charges may apply. \* Numéro sans Frais. Des Frais peuvent s'appliquer avec les téléphones cellulaires. \* Gebührenfrei, Kosten für Anrufe aus Mobilfunknetzen können abweichen.  
\* Gratis telefonnummer vanaf vaste lijn. \* Det er ett gratis nummer, när du ringer från Fasttelefon. \* Det är gratis, när du ringer från en Fast telefon.



# WIN!

Go to [www.nielsen.com/LEGO](http://www.nielsen.com/LEGO) to fill out a survey for a chance to win a cool LEGO® Product.

No purchase necessary.

Open to all residents where not prohibited.



## [www.nielsen.com/LEGO](http://www.nielsen.com/LEGO)

### GEWINNE! WIN!

Nimm an der Umfrage auf [www.nielsen.com/LEGO](http://www.nielsen.com/LEGO) teil und hab die Chance ein cooles LEGO® Produkt zu gewinnen!

Die Teilnahme am Gewinnspiel führt zu keinerlei Kaufverpflichtungen. Teilnahme in allen nicht ausgeschlossenen Ländern möglich.

Ga naar [www.nielsen.com/LEGO](http://www.nielsen.com/LEGO), vul een enquêteformulier in en maak kans op een cool LEGO® product.

Geen aankoopverplichting. Iedereen mag deelnemen, uitgezonderd ingezetenden van landen waar een enquêteverbod geldt.

### GAGNE! 当てよう!

Visite [www.nielsen.com/LEGO](http://www.nielsen.com/LEGO) pour répondre à un questionnaire et avoir une chance de gagner un produit LEGO® très cool!

Aucune obligation d'achat. Ouvert à tous les résidents des pays autorisés.

[www.nielsen.com/LEGO](http://www.nielsen.com/LEGO)にアクセスして、アンケートにご記入ください。当選者にはレゴ製品を差し上げます。

お買い上げの必要はありません。

禁止されていない限り、すべての皆様にご利用いただけます。