

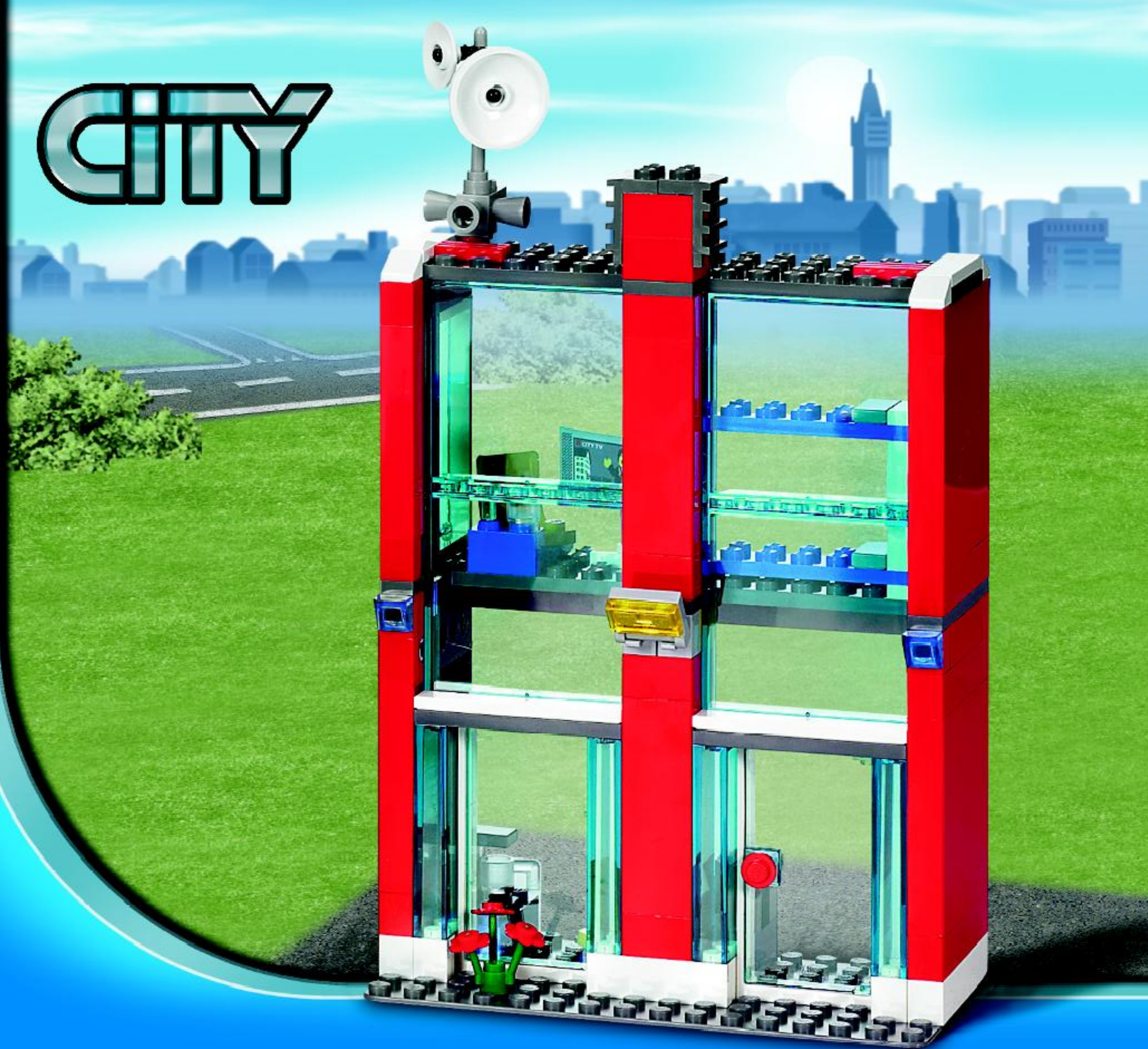

7208

CITY

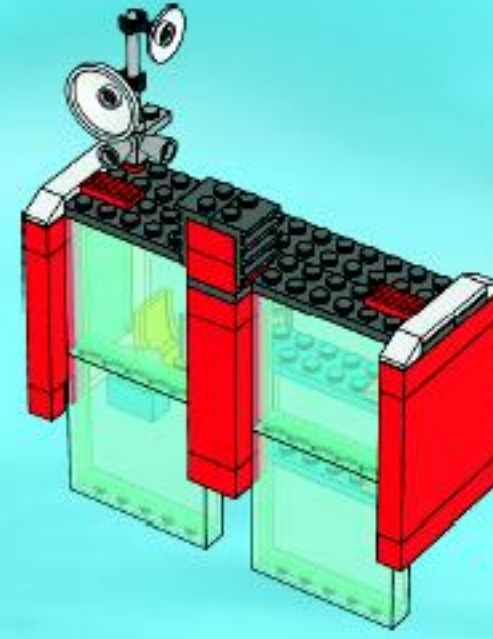

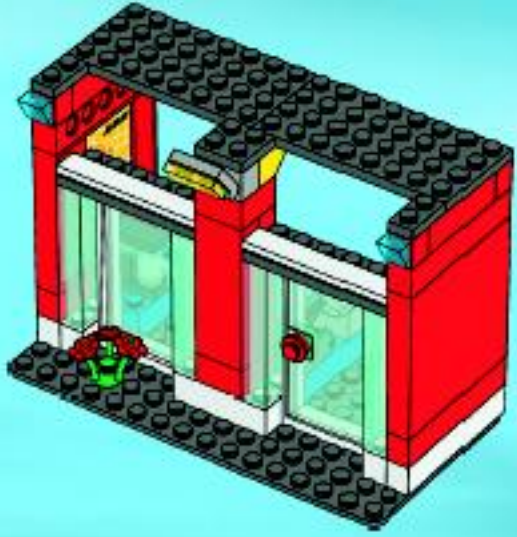

+

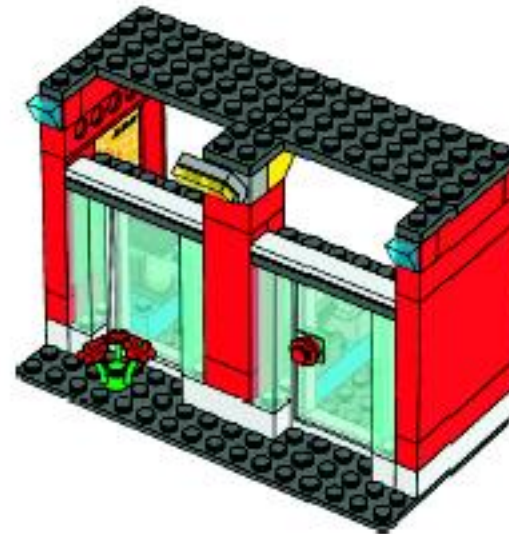

1

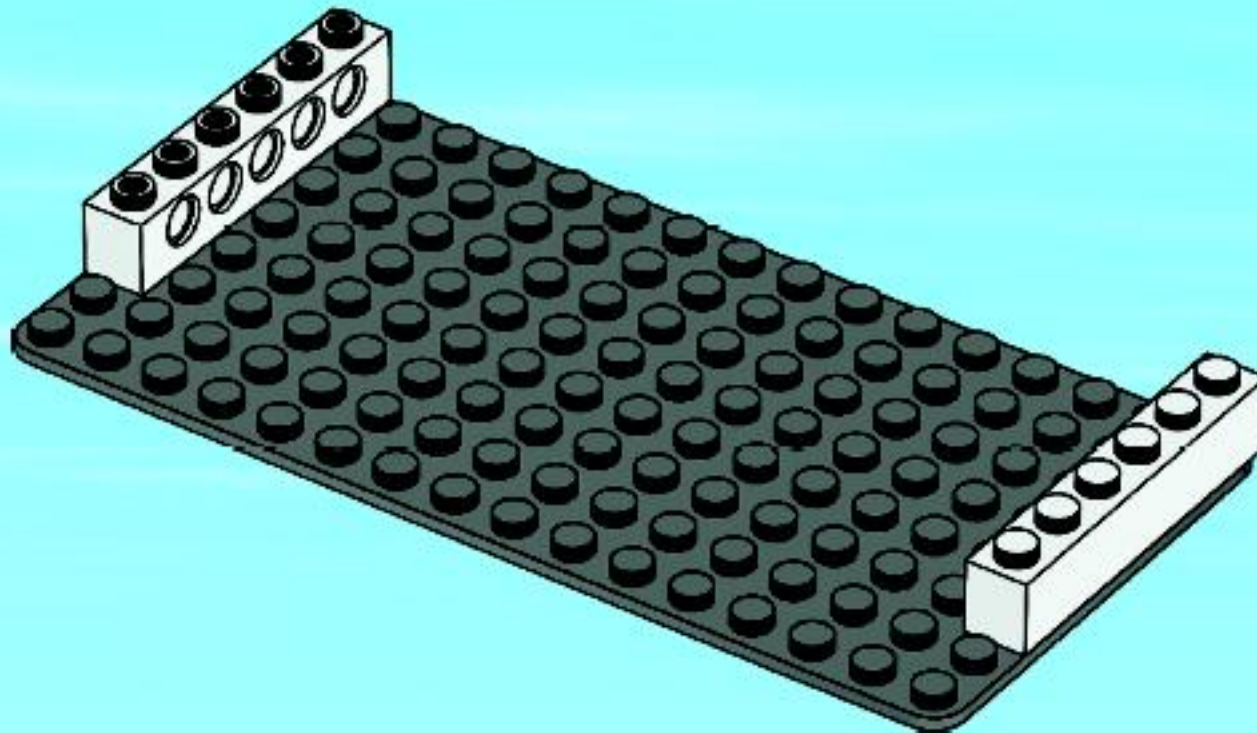

2

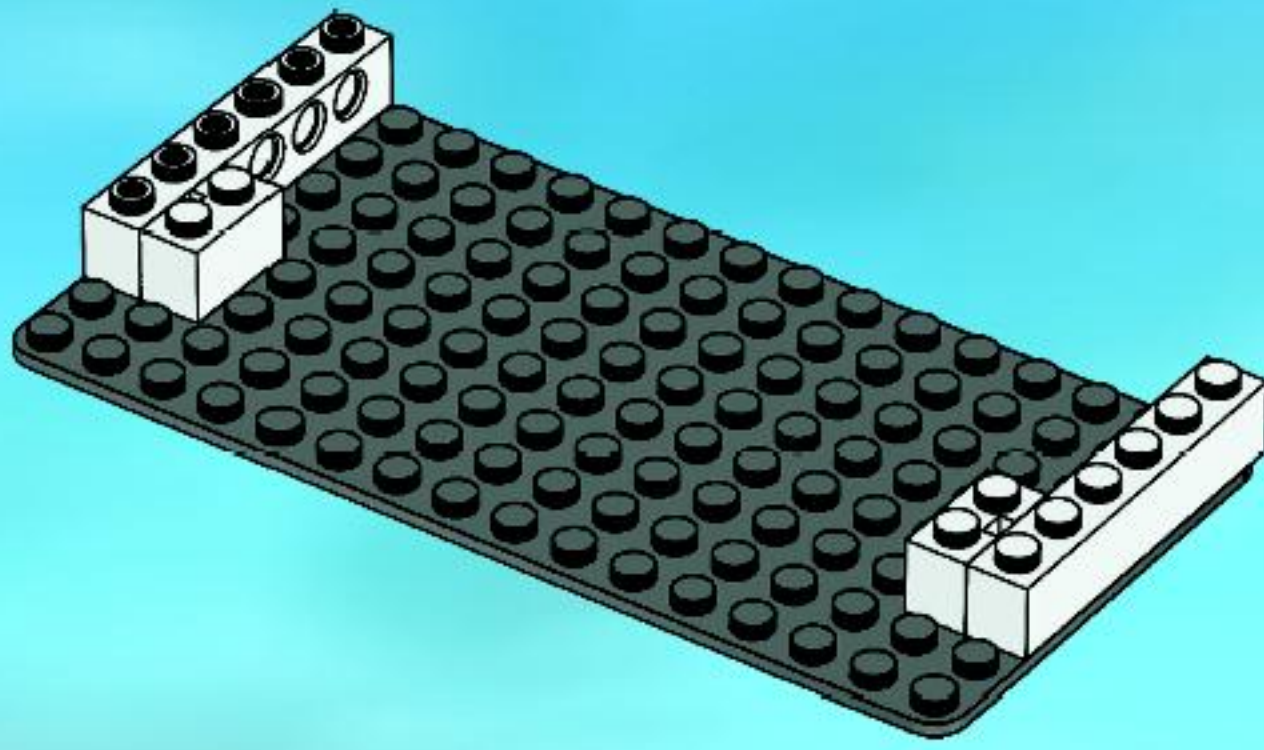

3

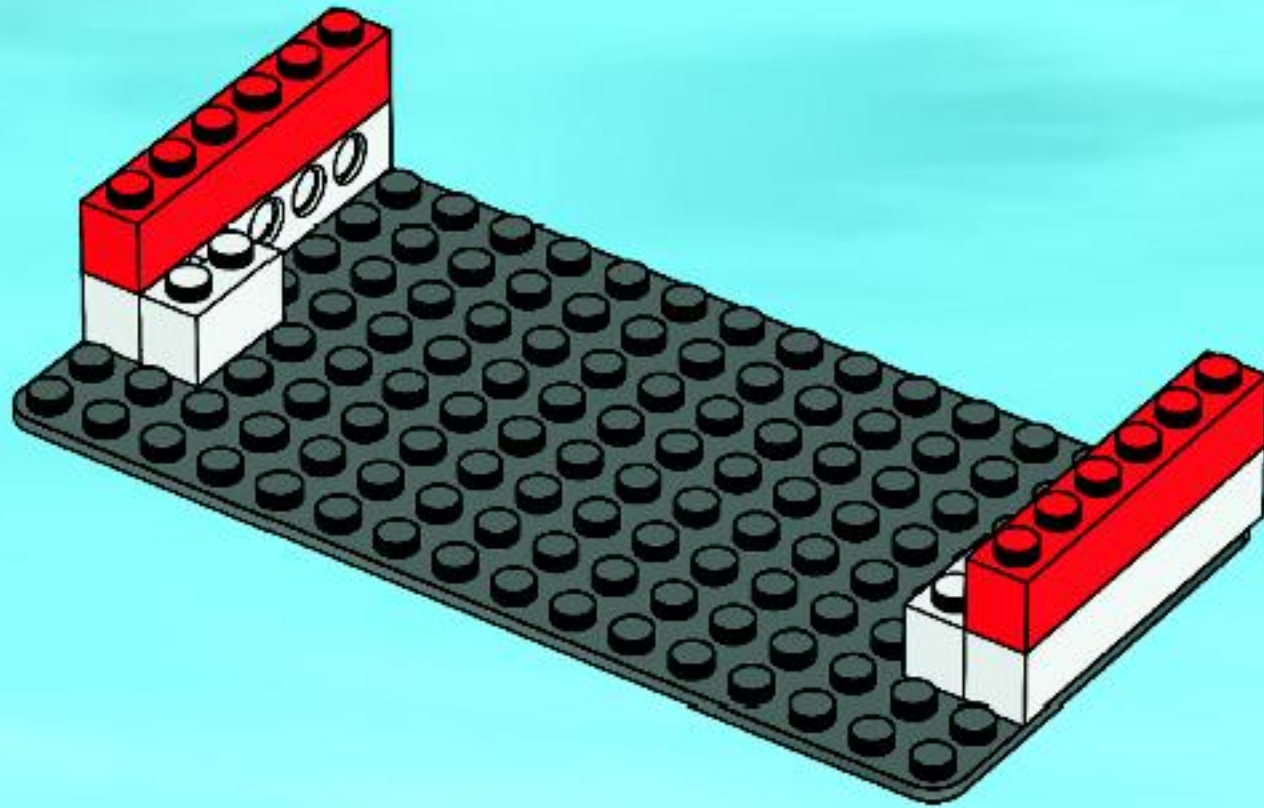

4

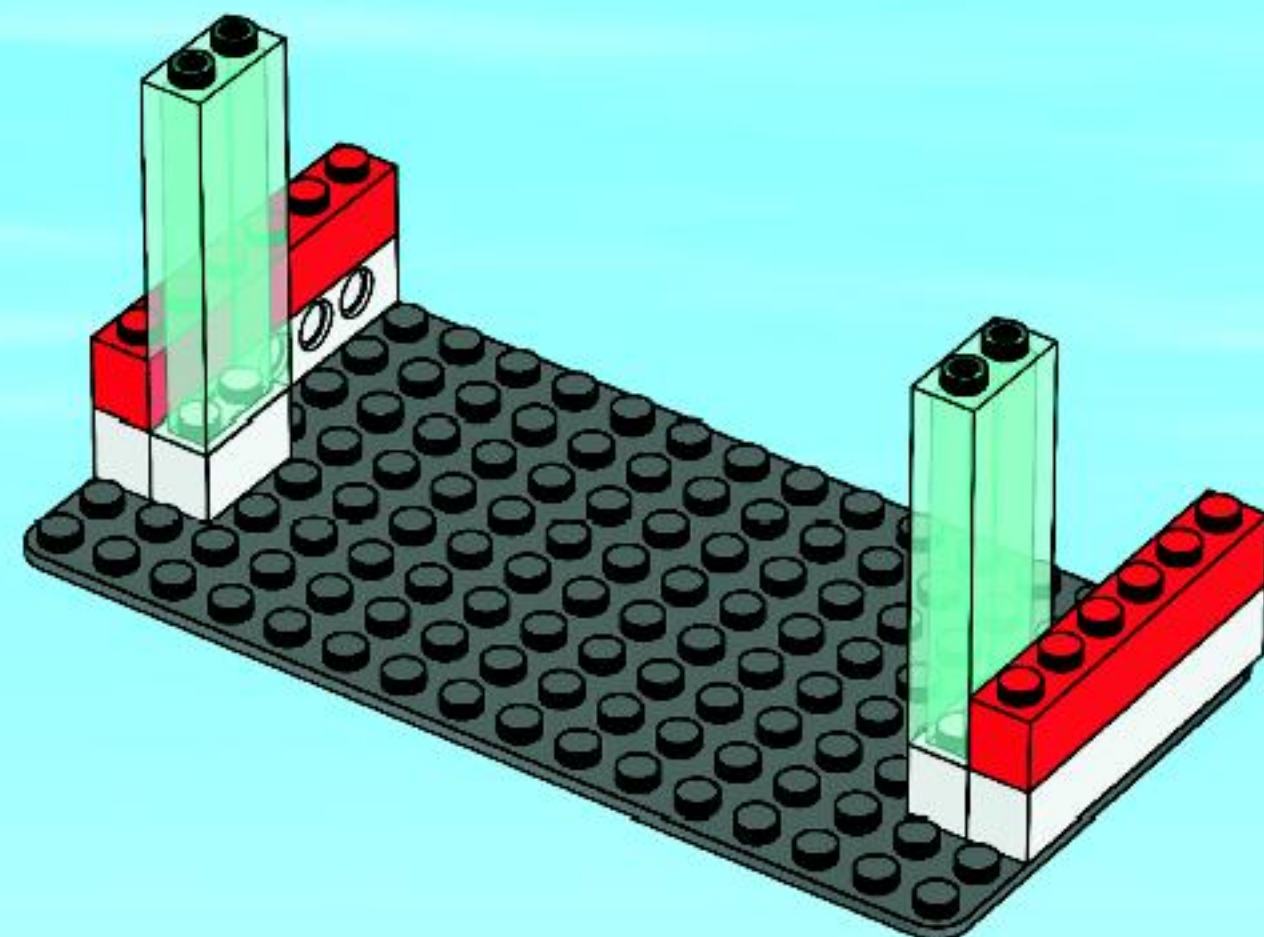

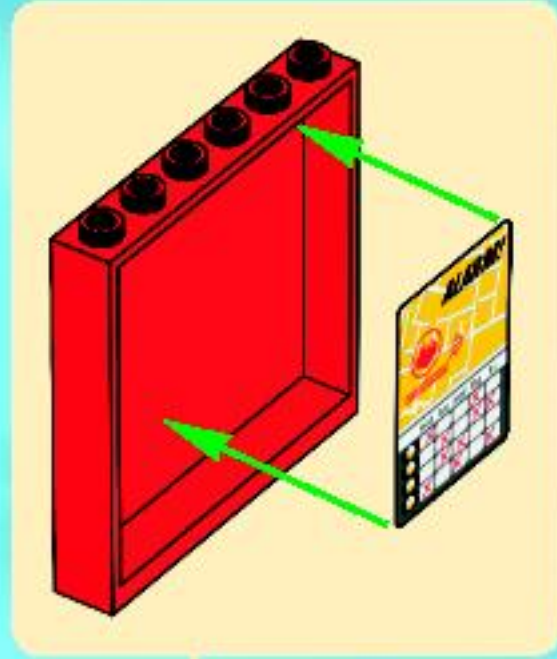

5

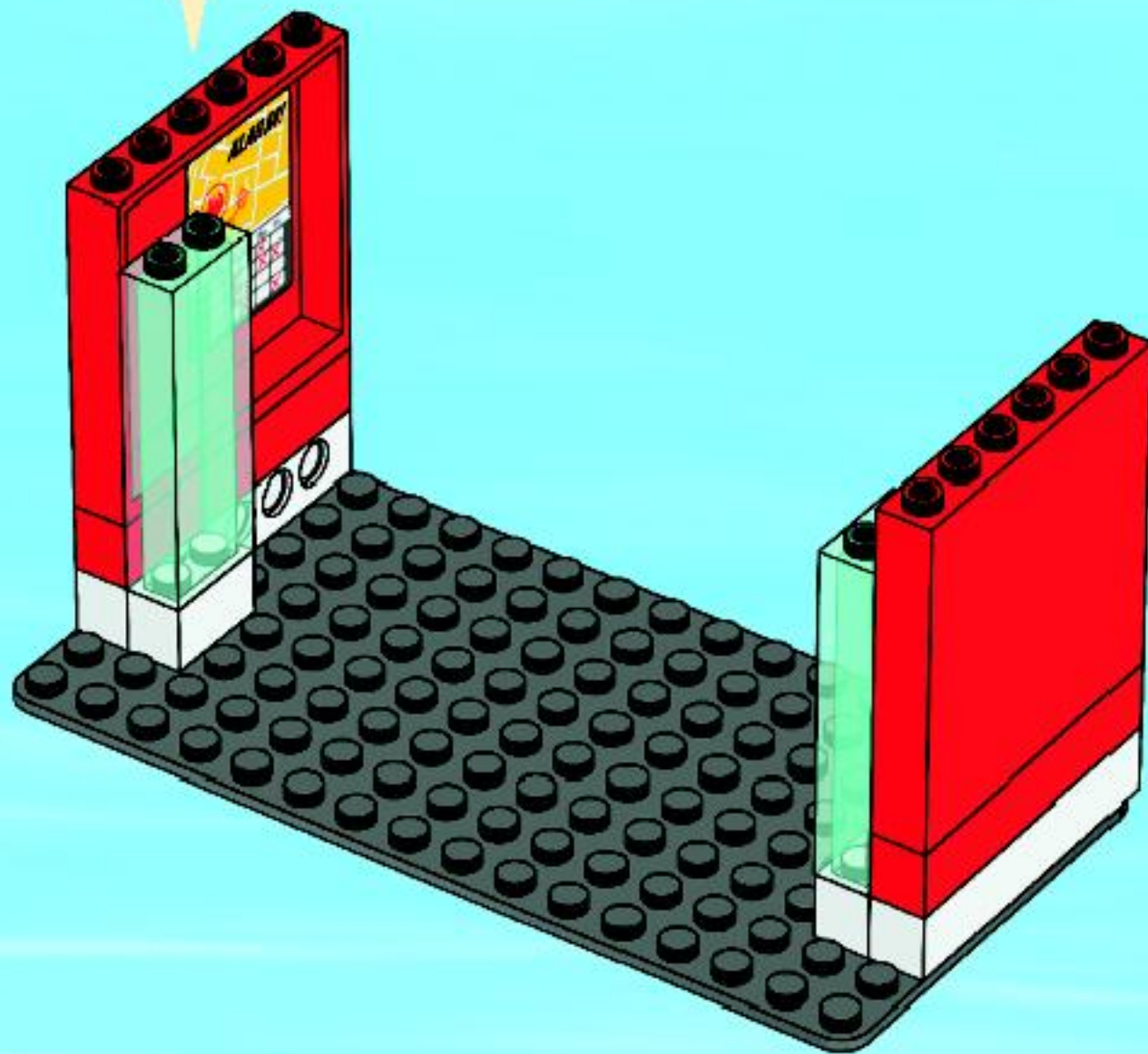

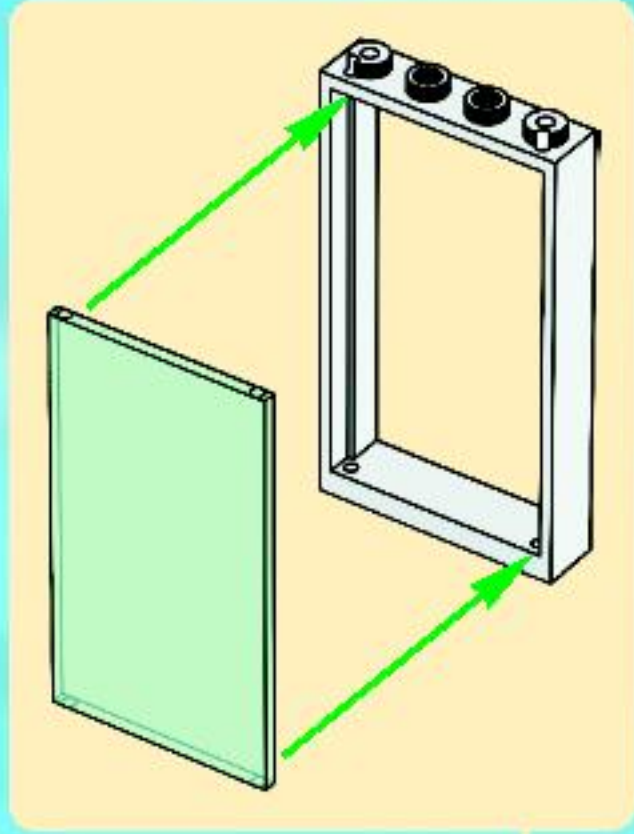

6

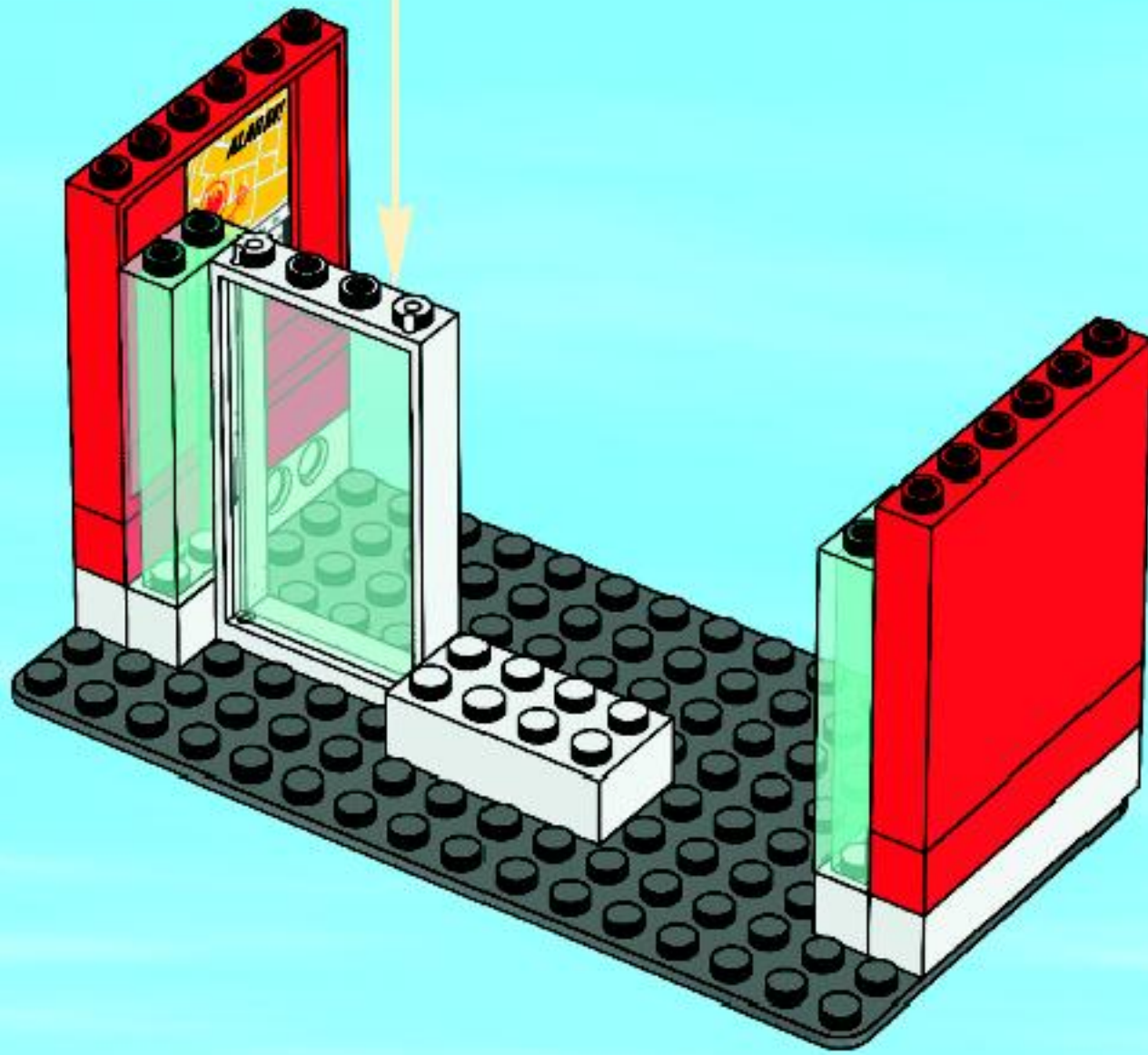

7

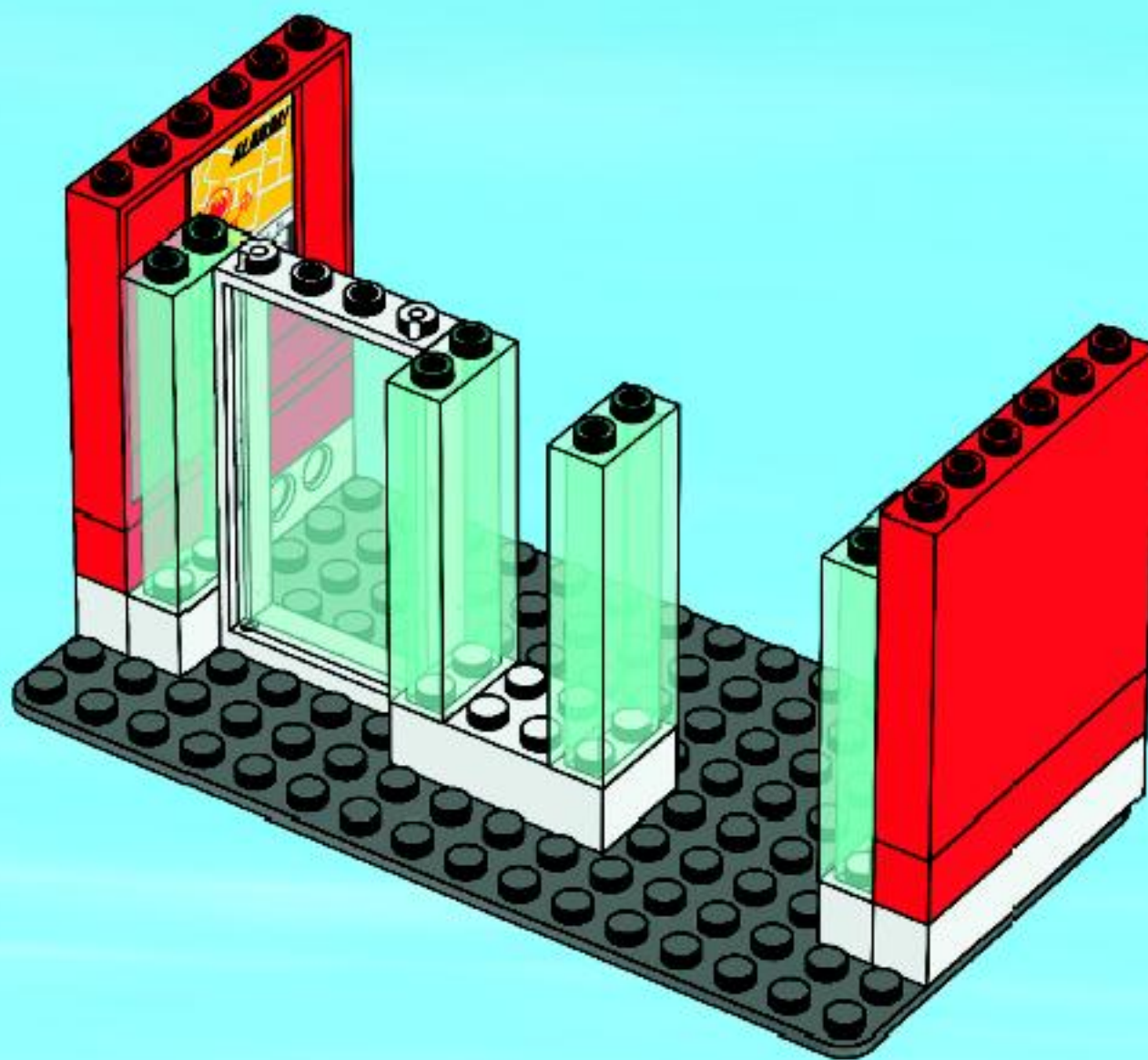

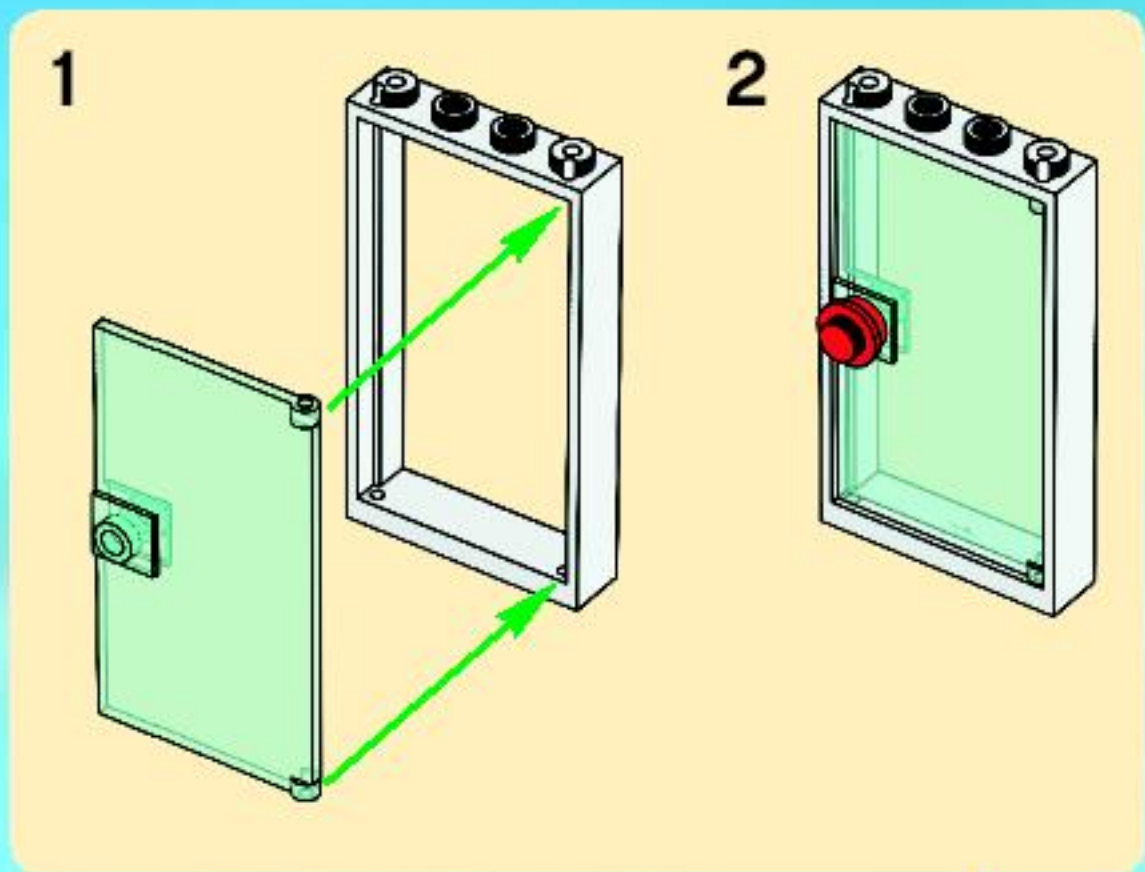

8

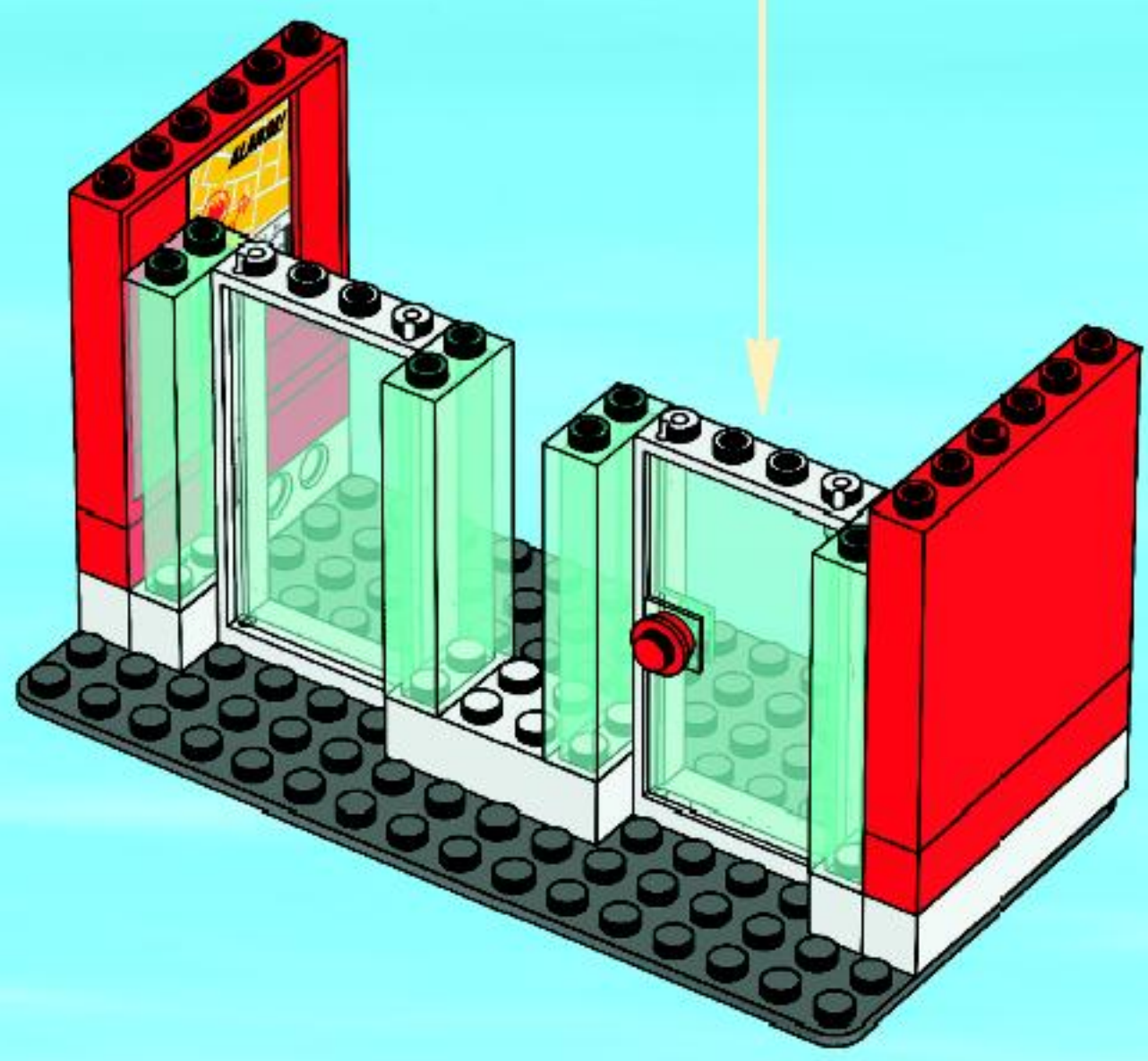

9

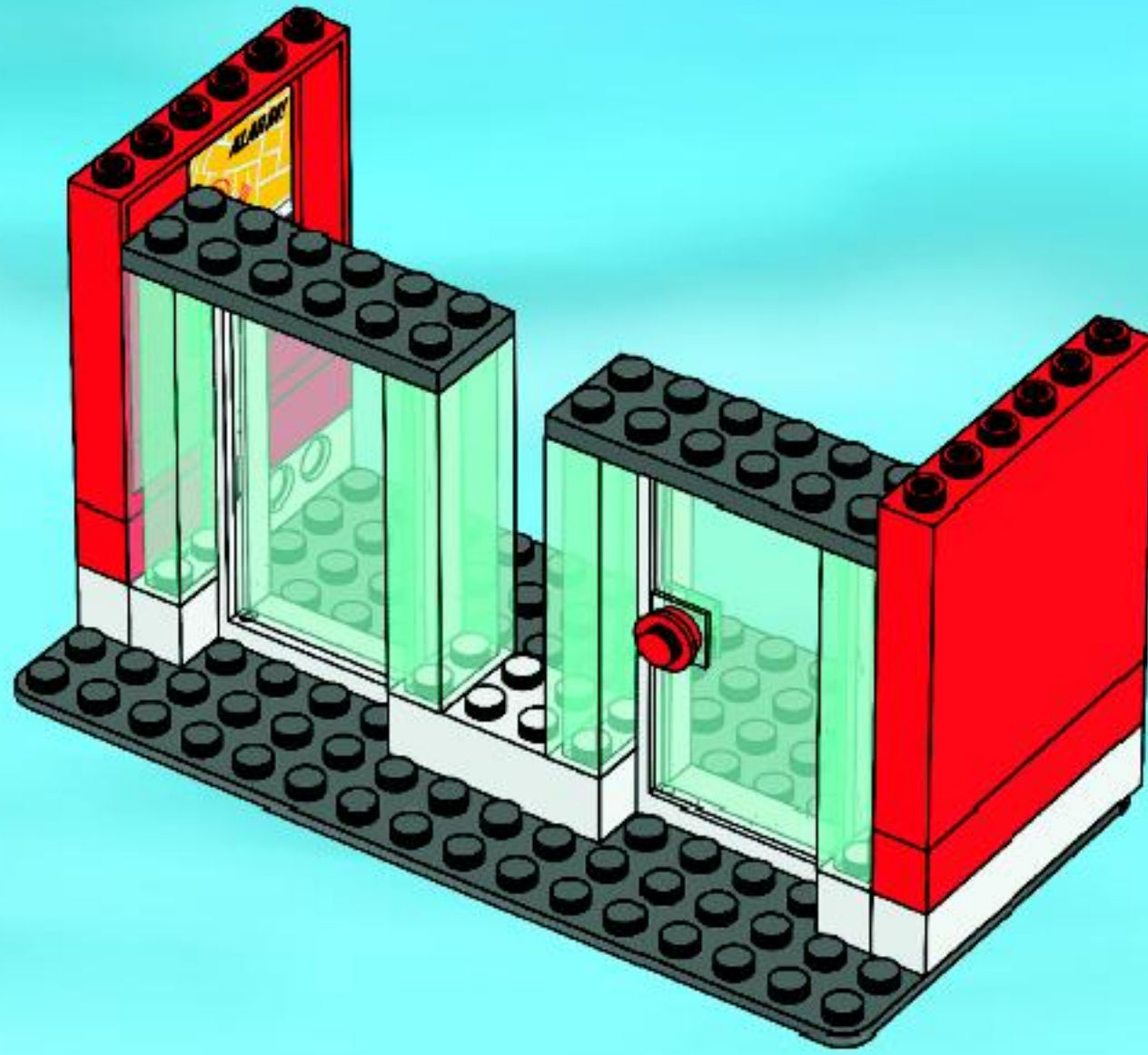

10

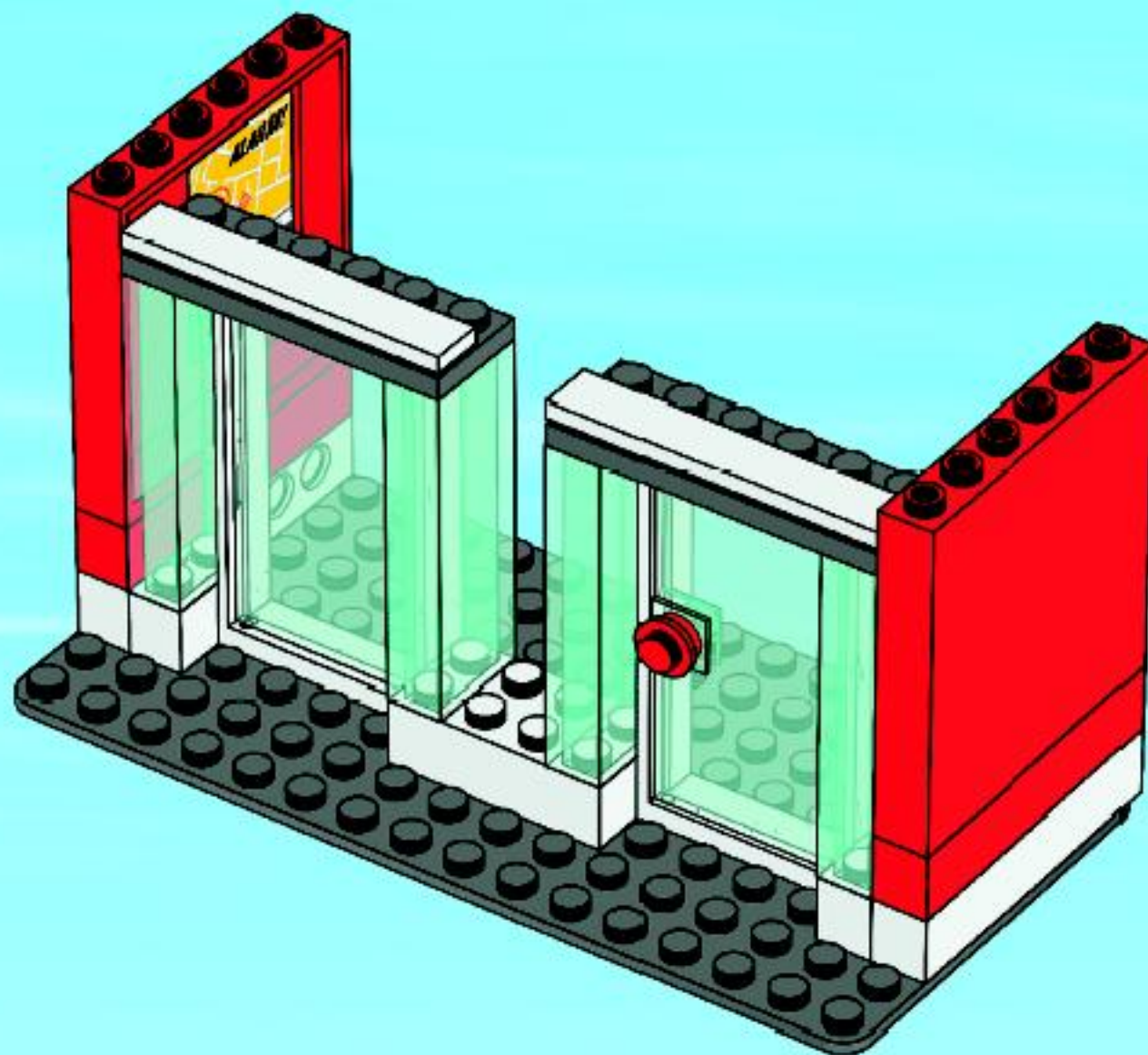

11

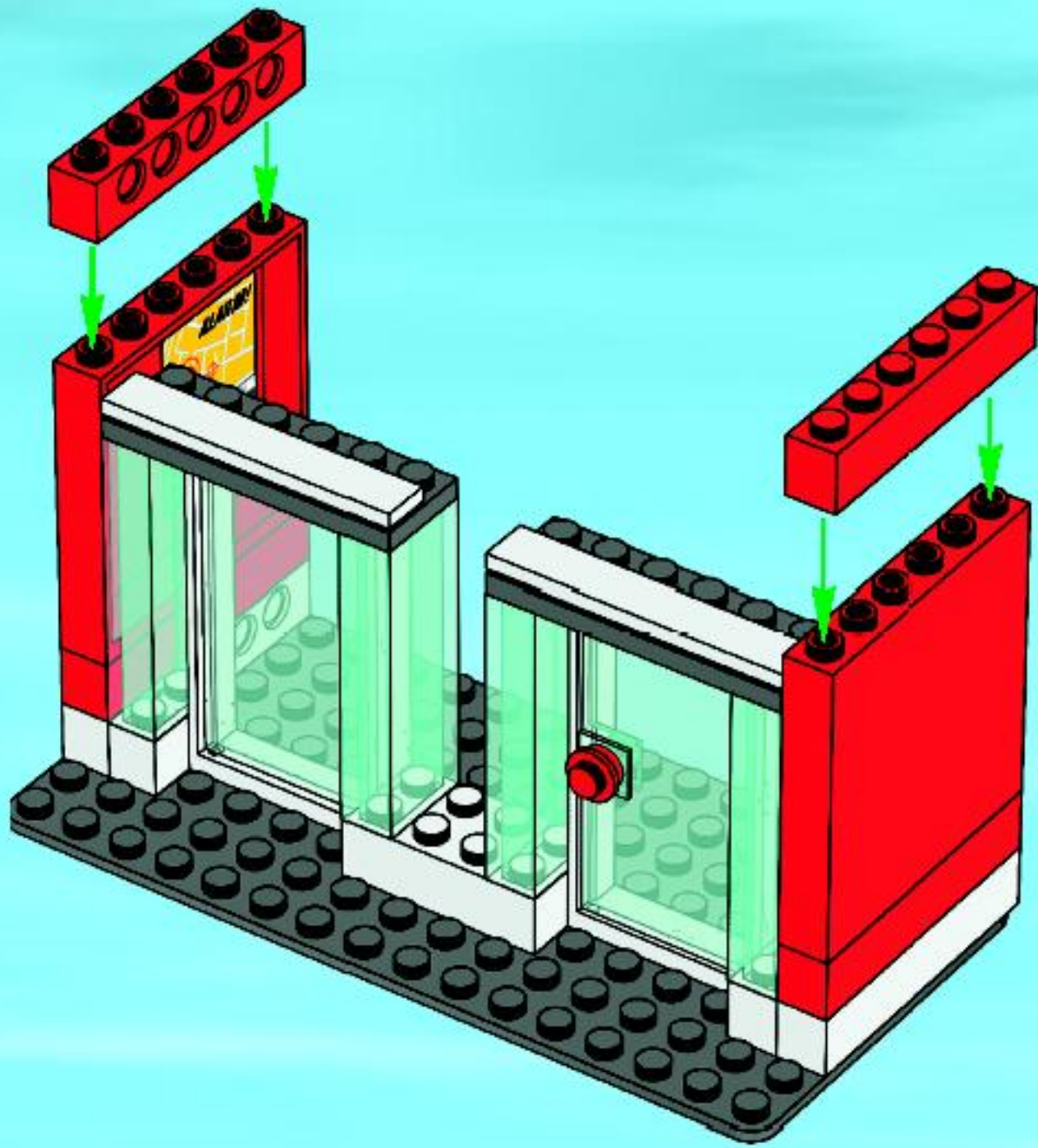

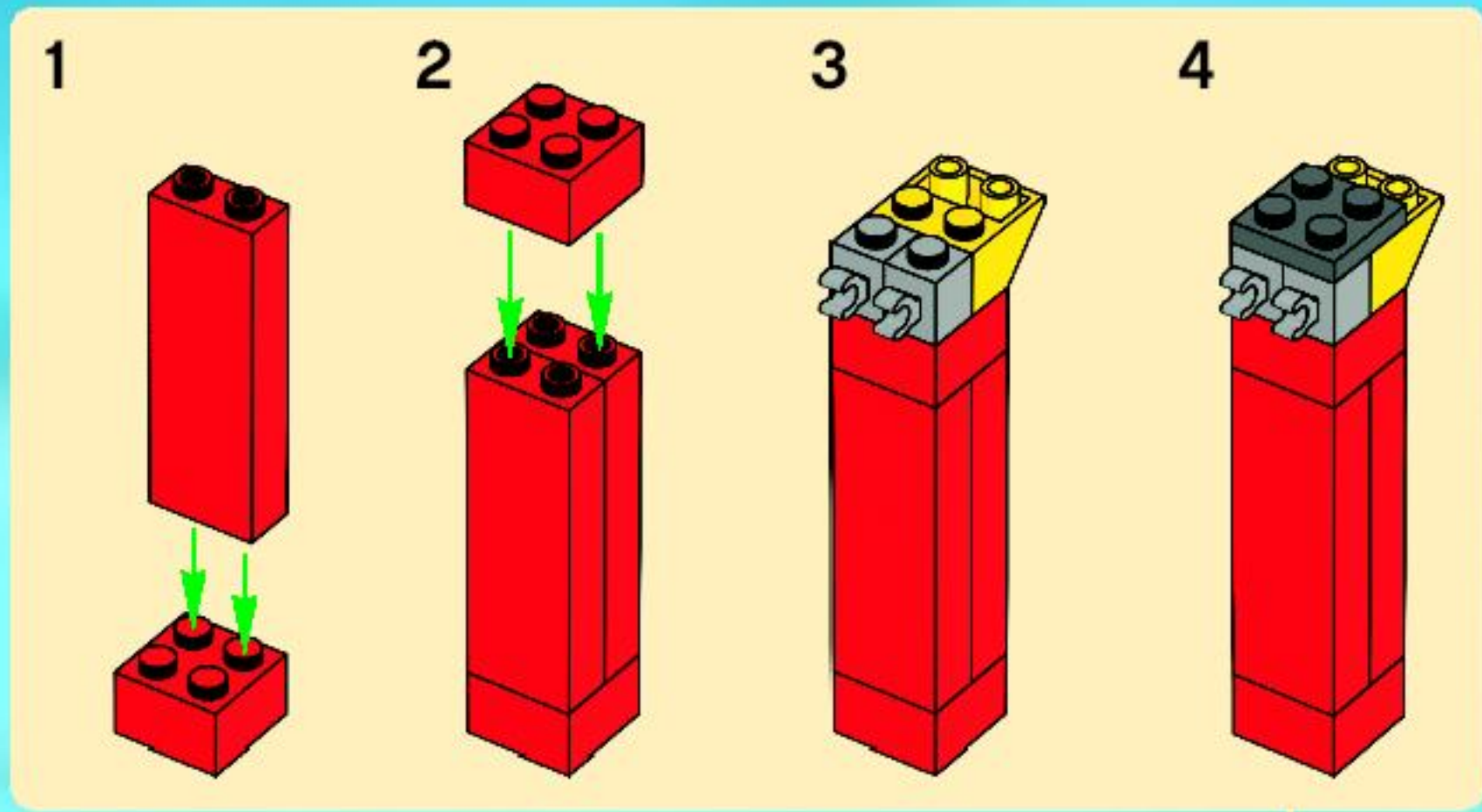

12

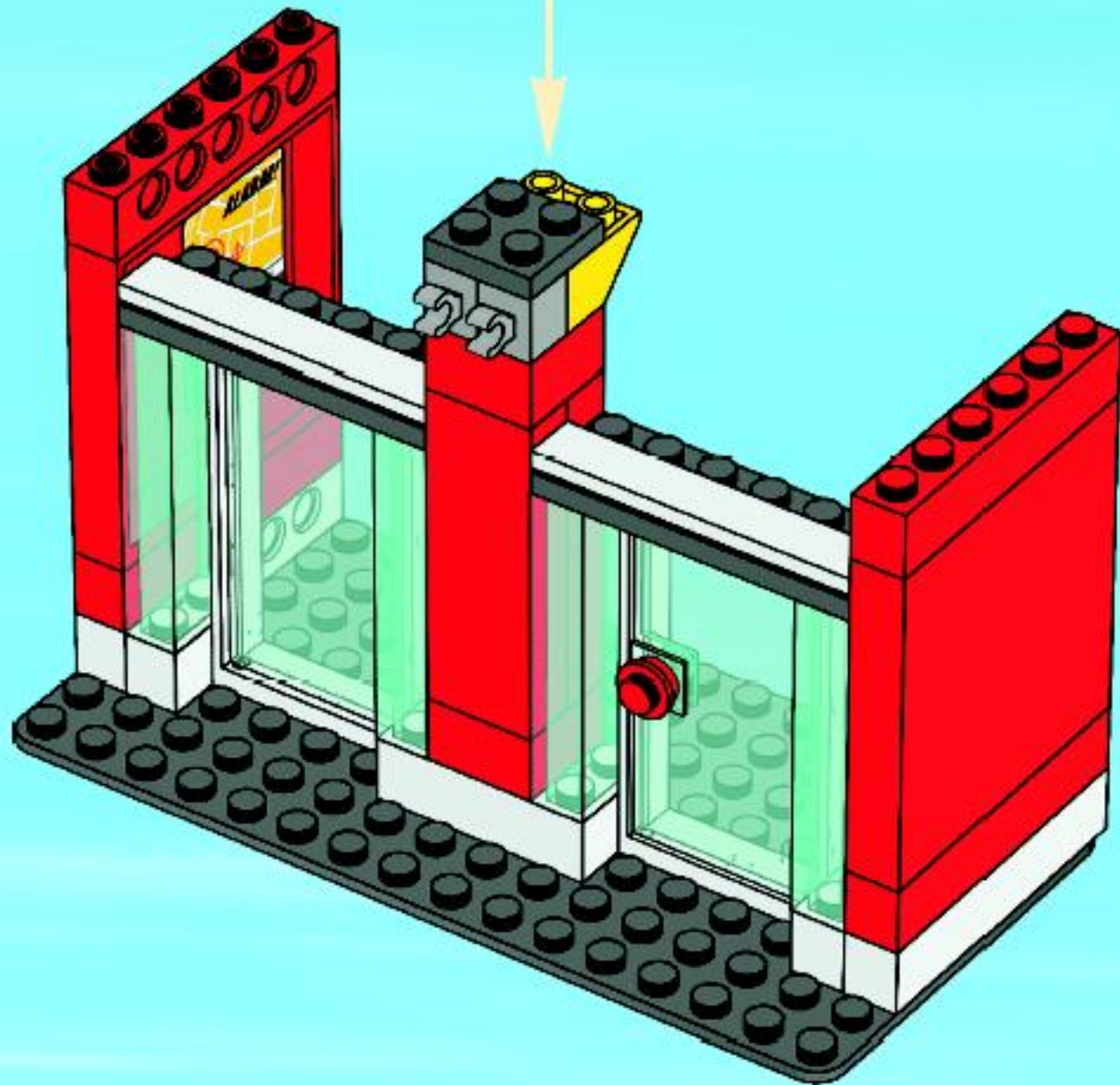

13

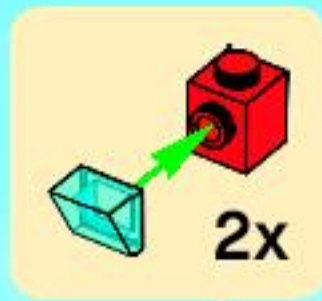
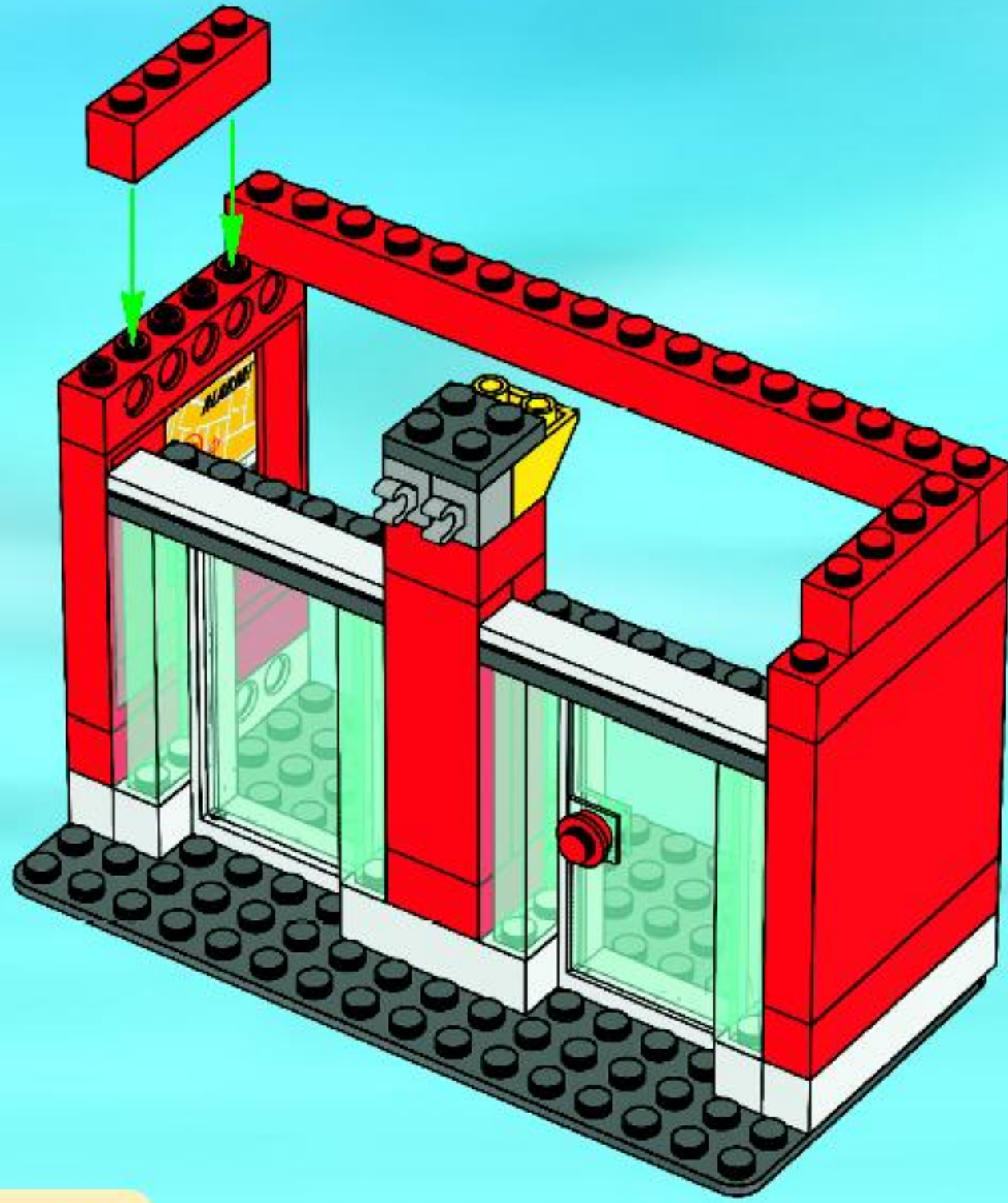

14

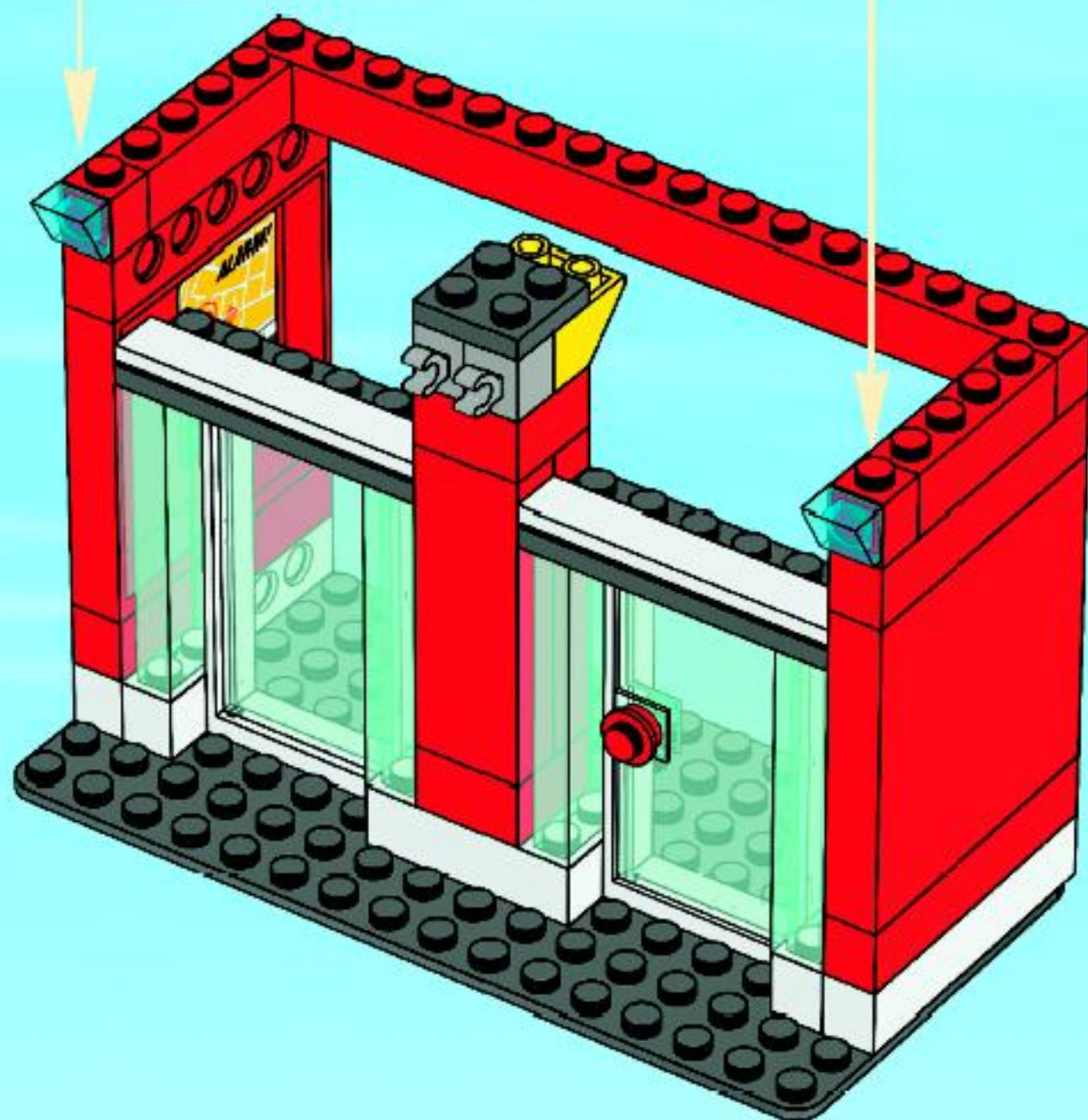

15

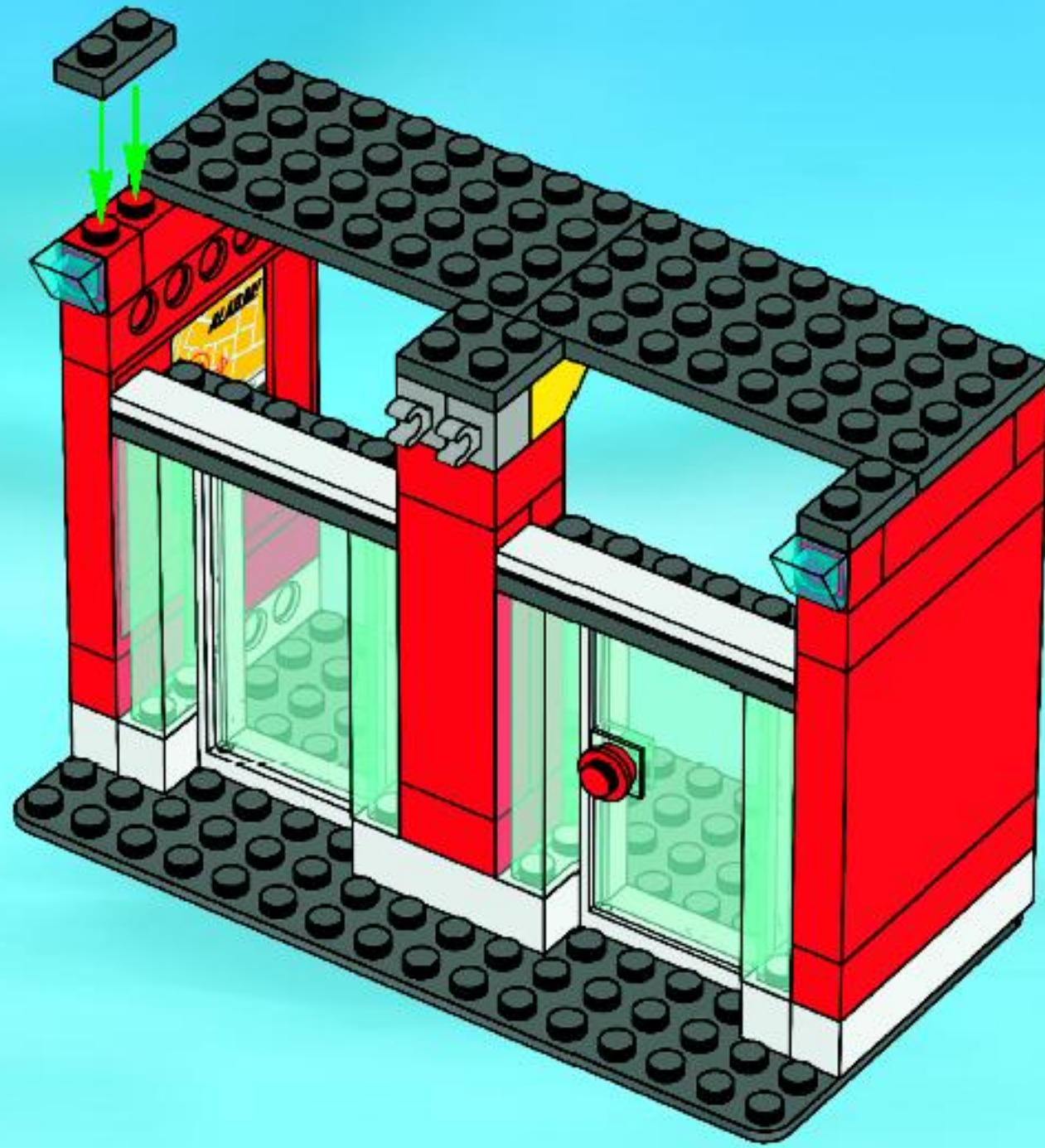

16

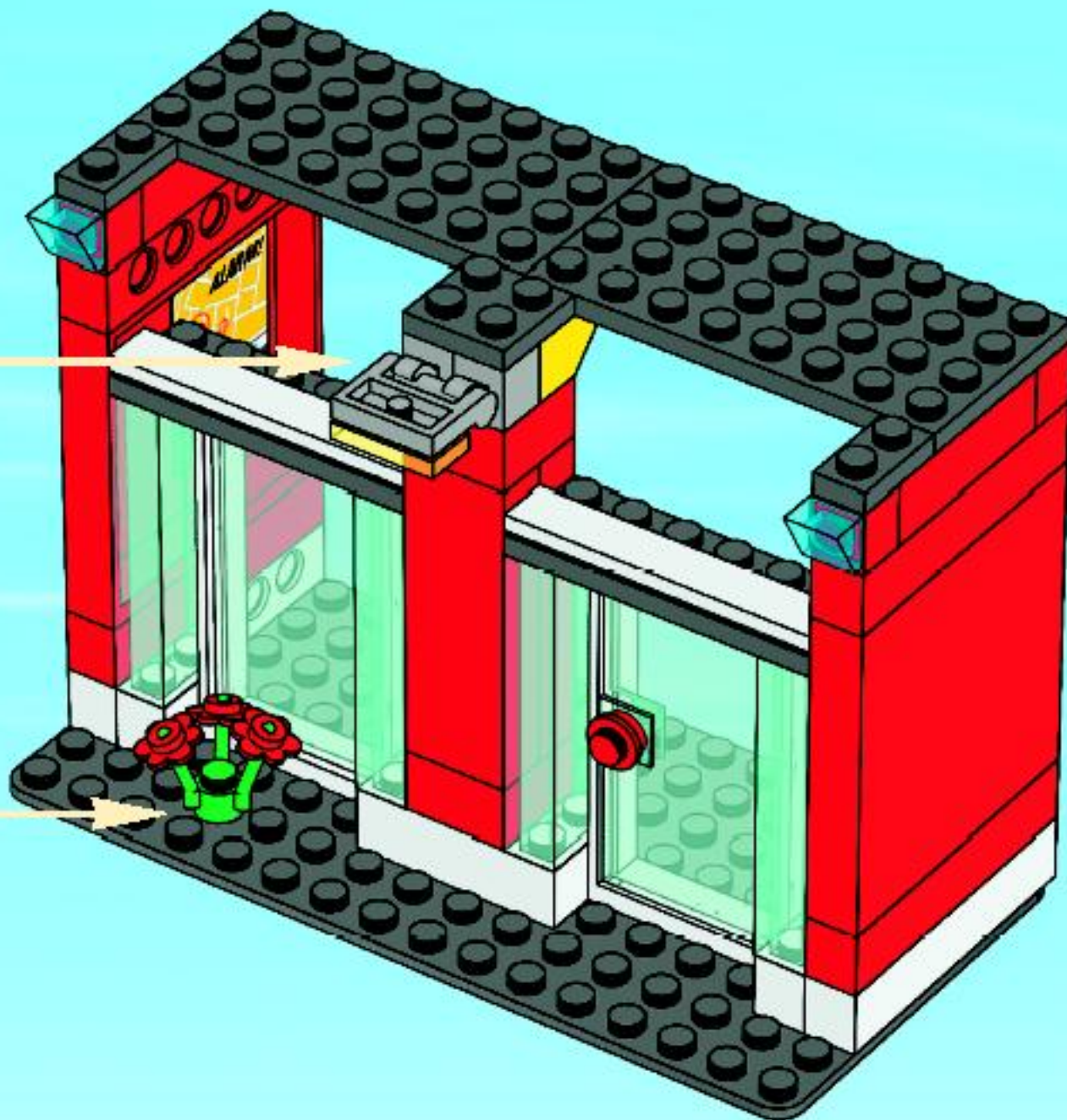
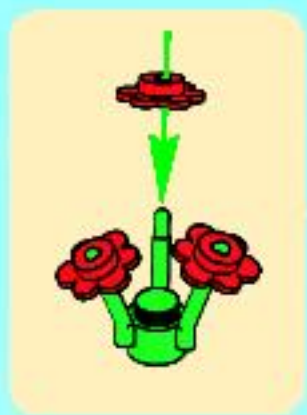
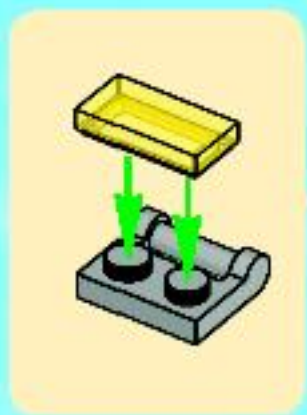

17

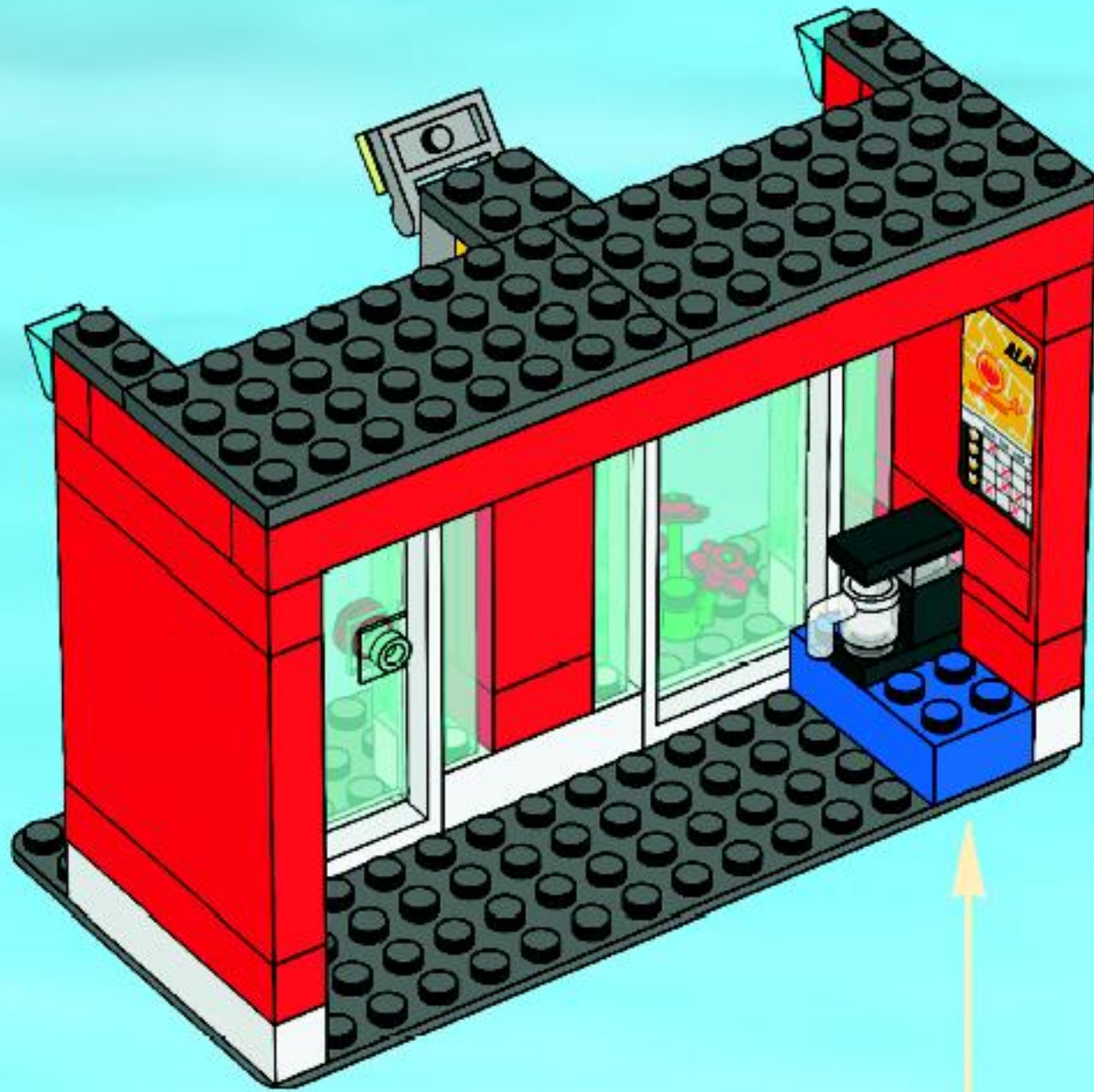

1

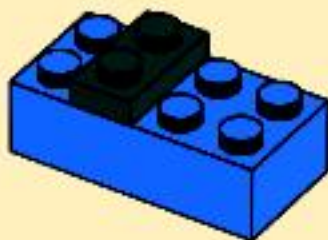

2



3



18

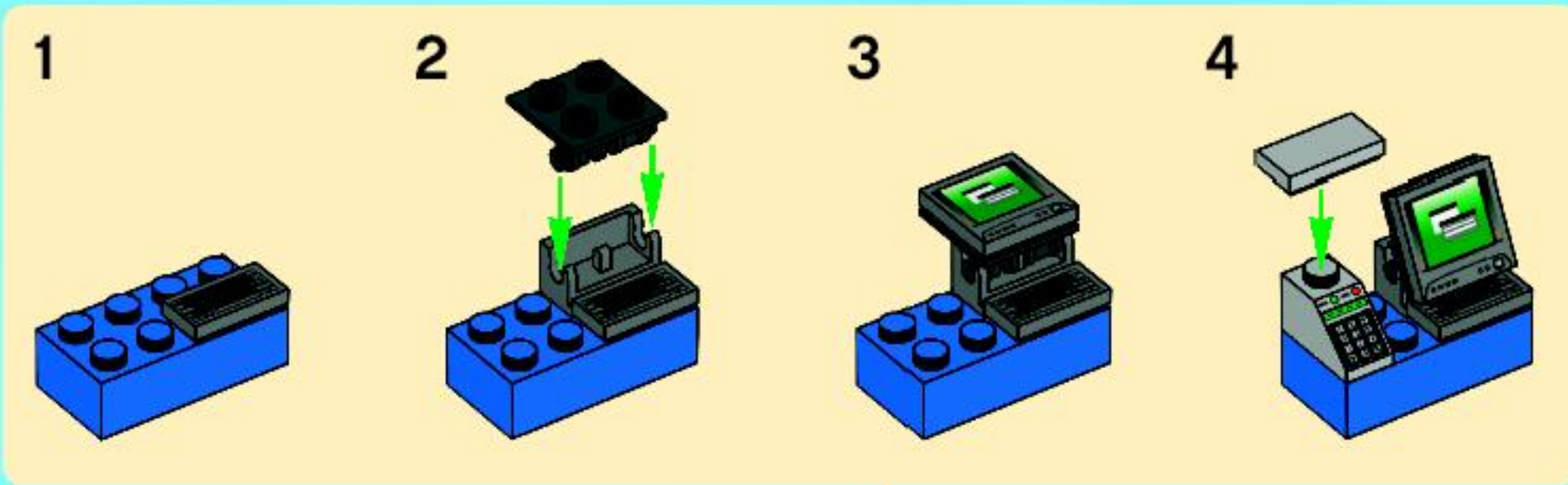

19

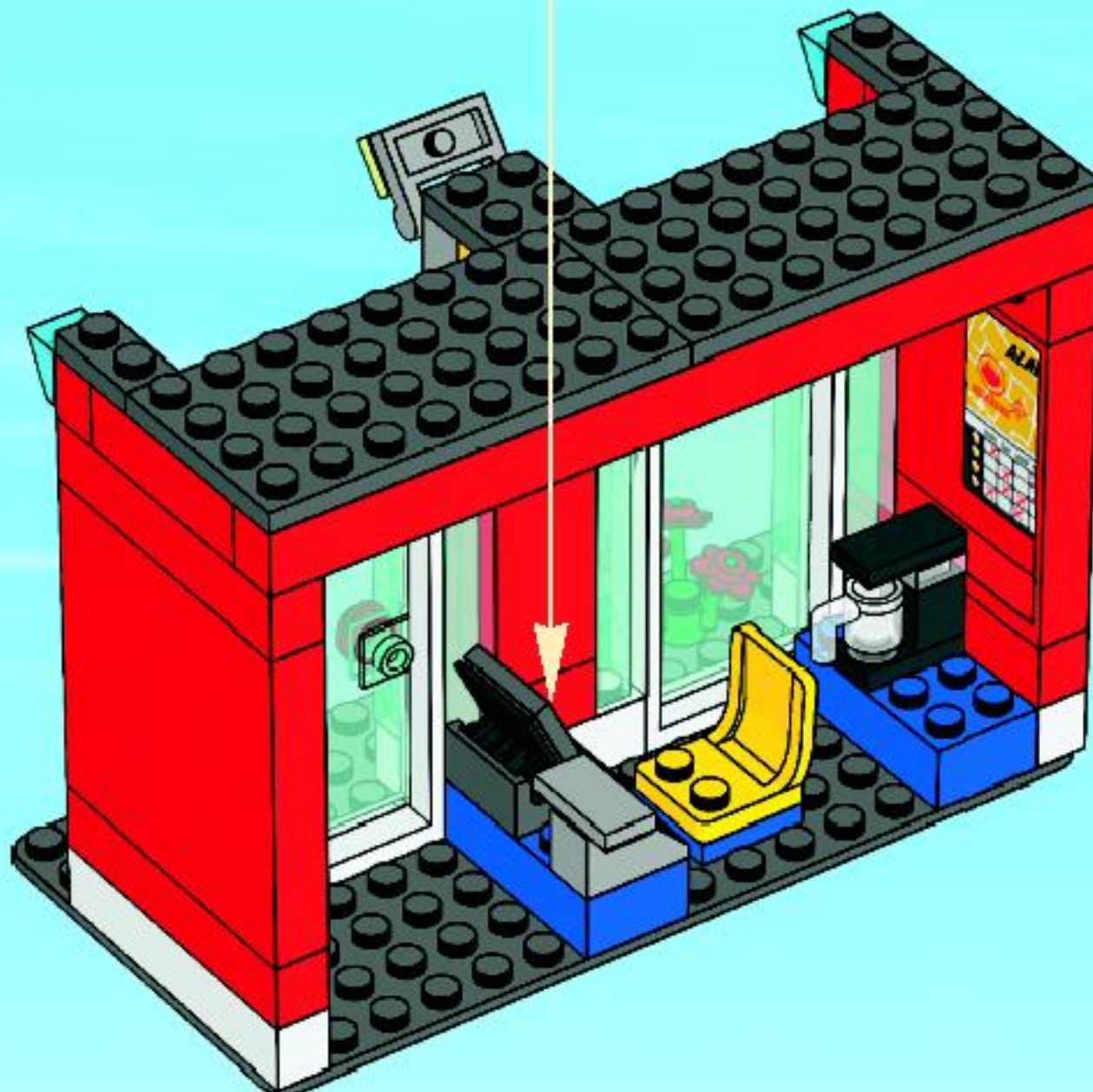

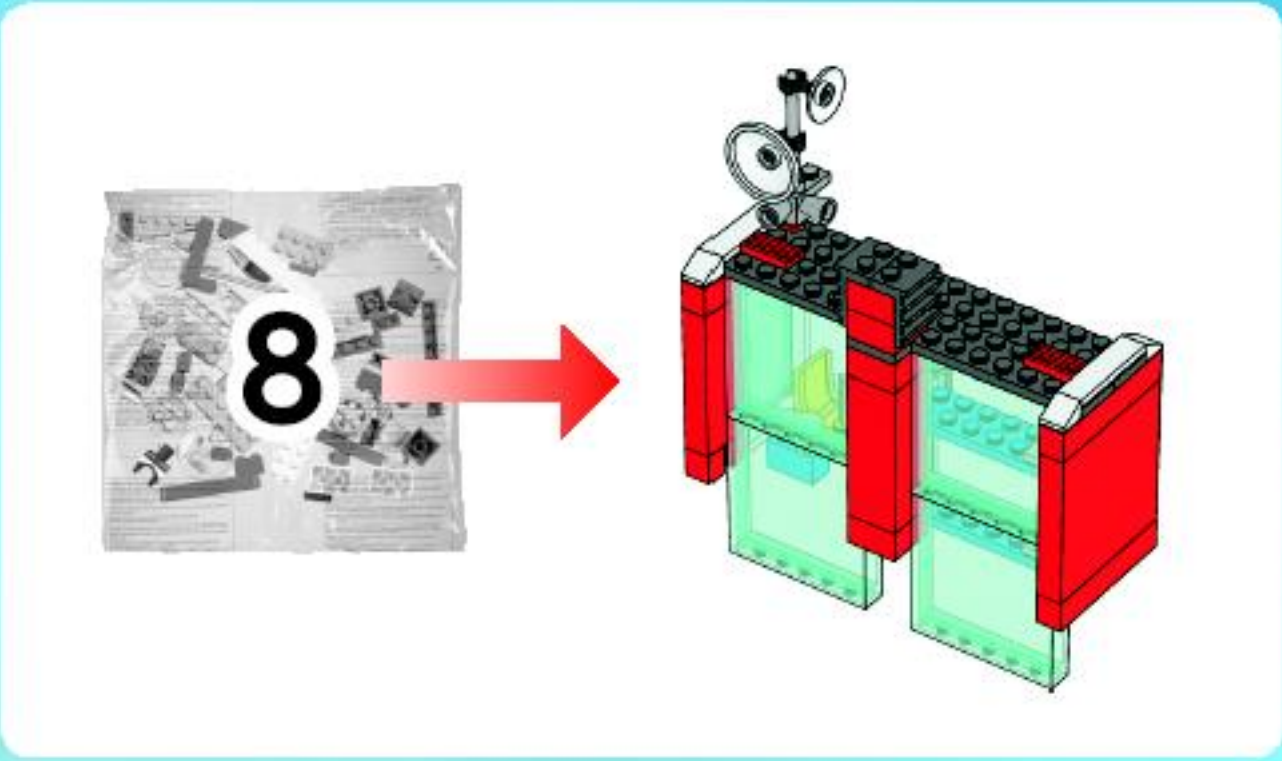

20

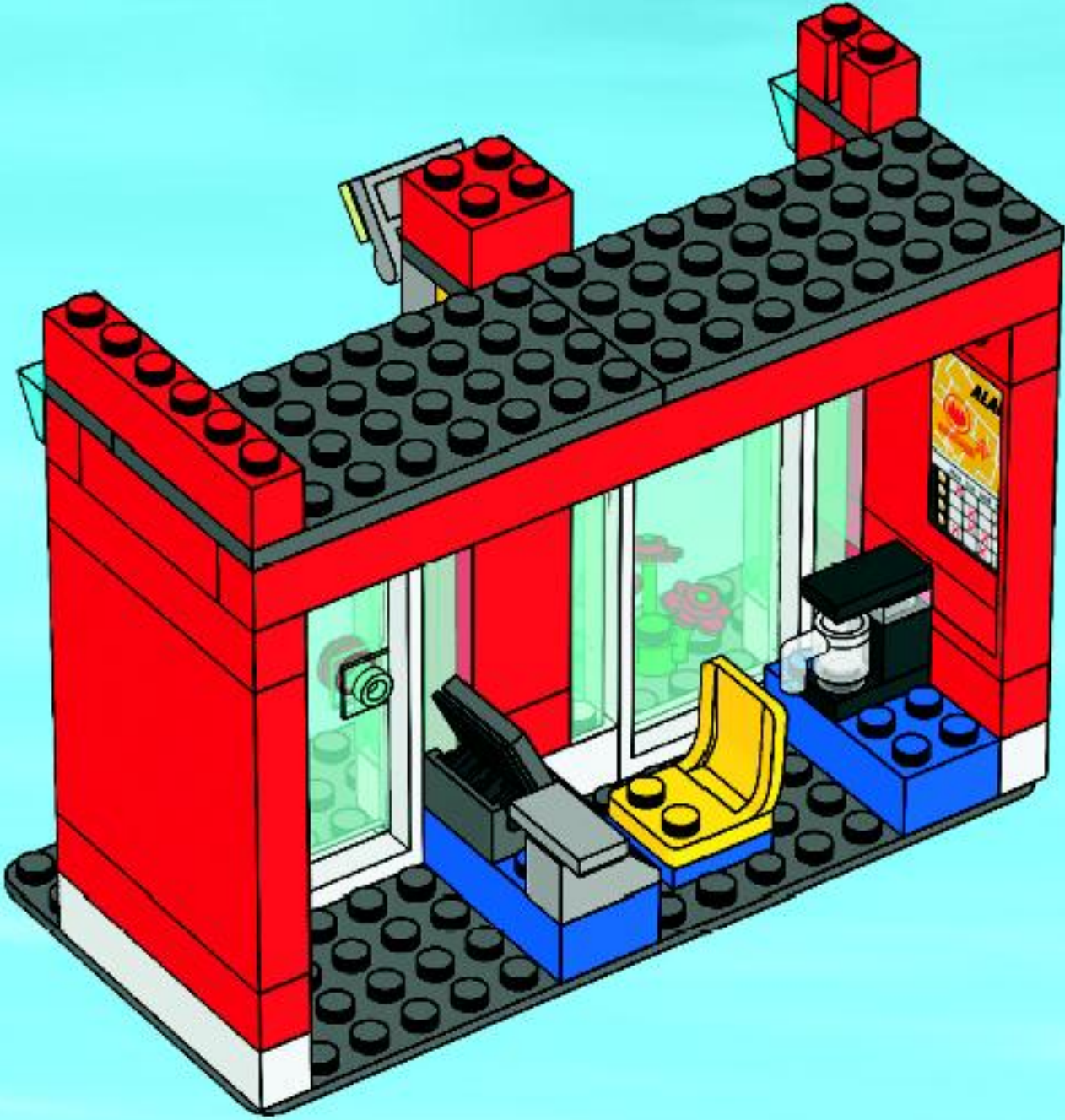

21

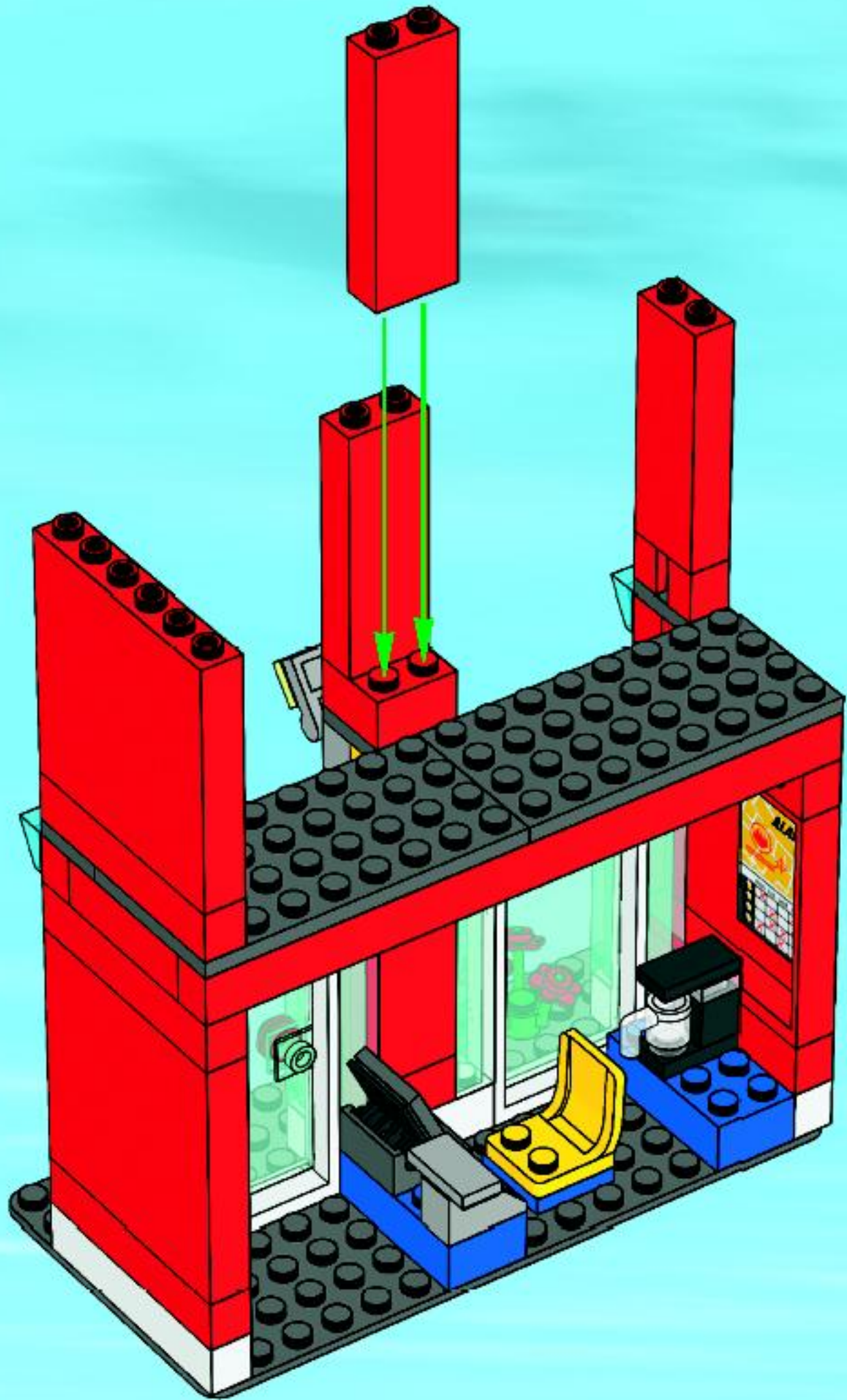

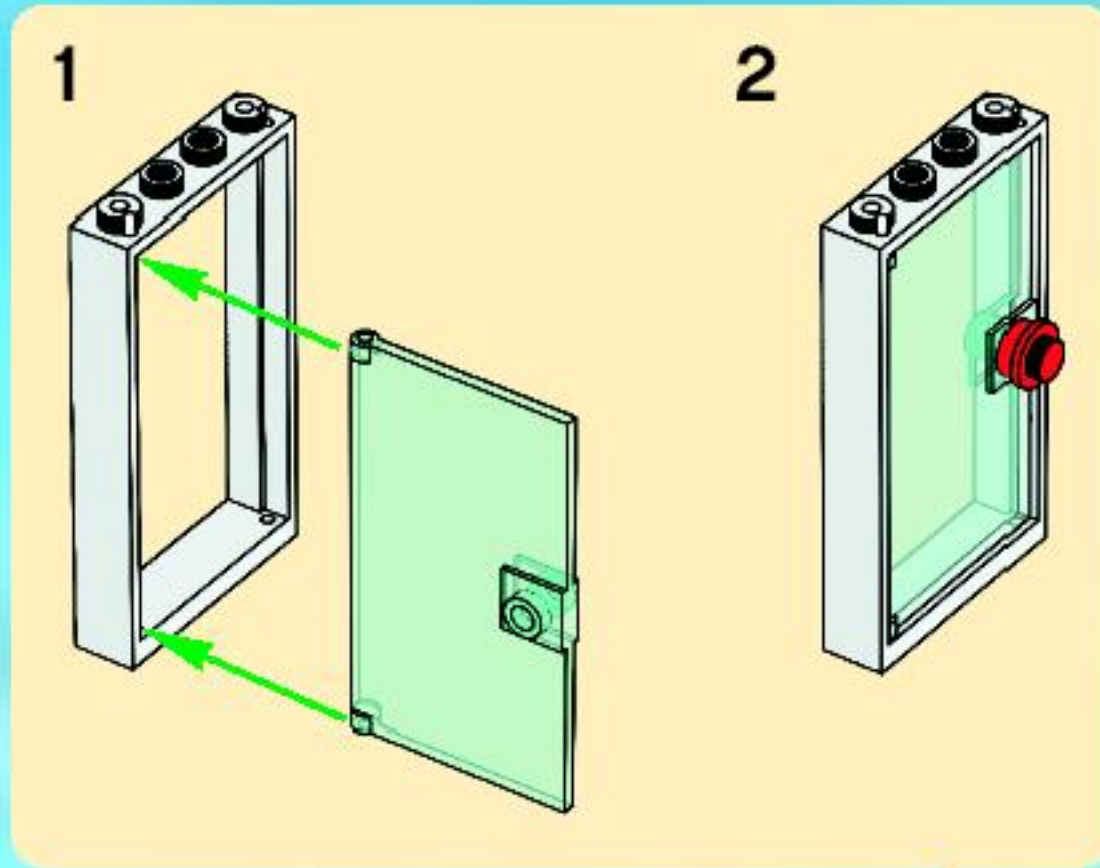

22

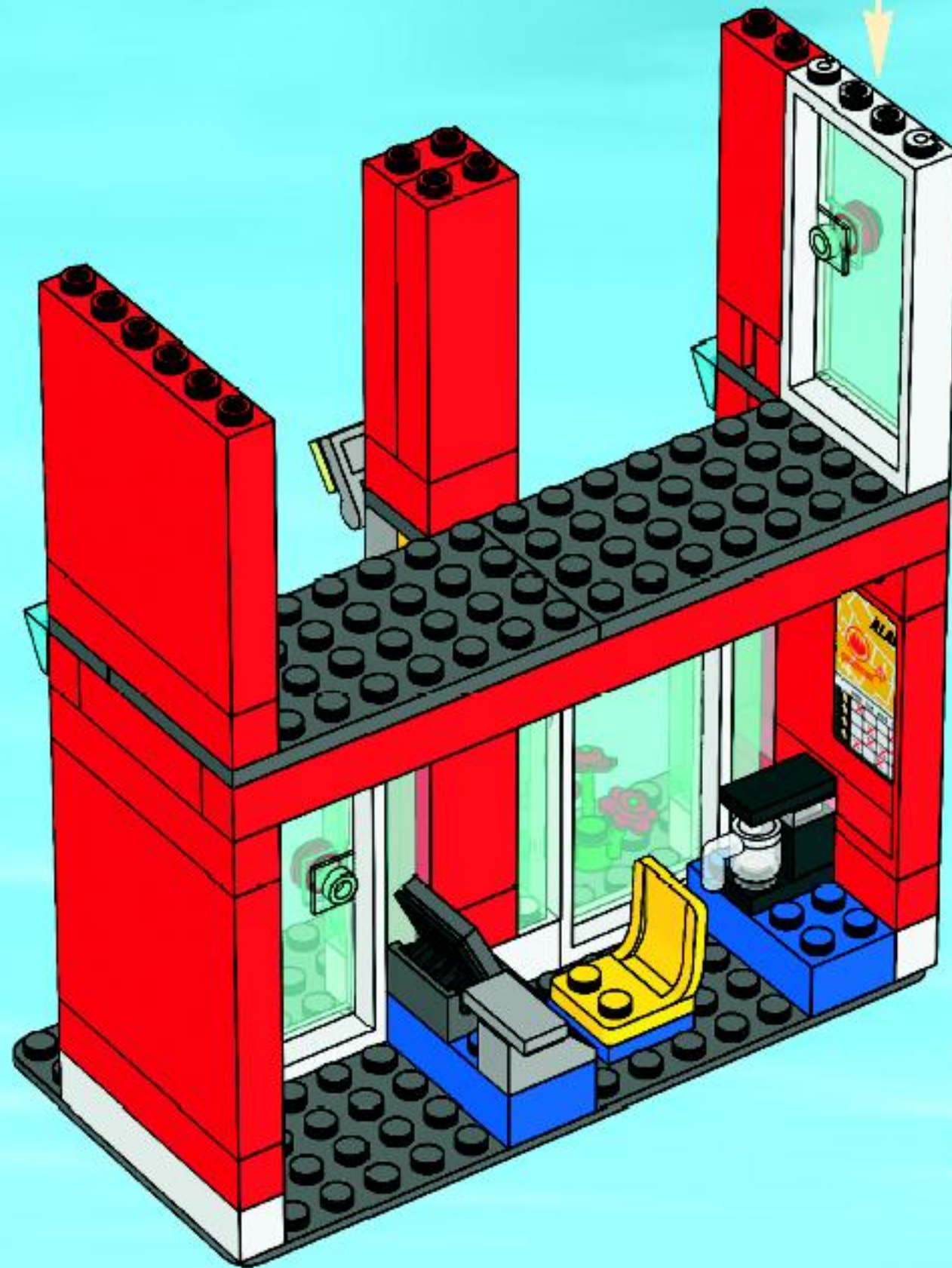

23

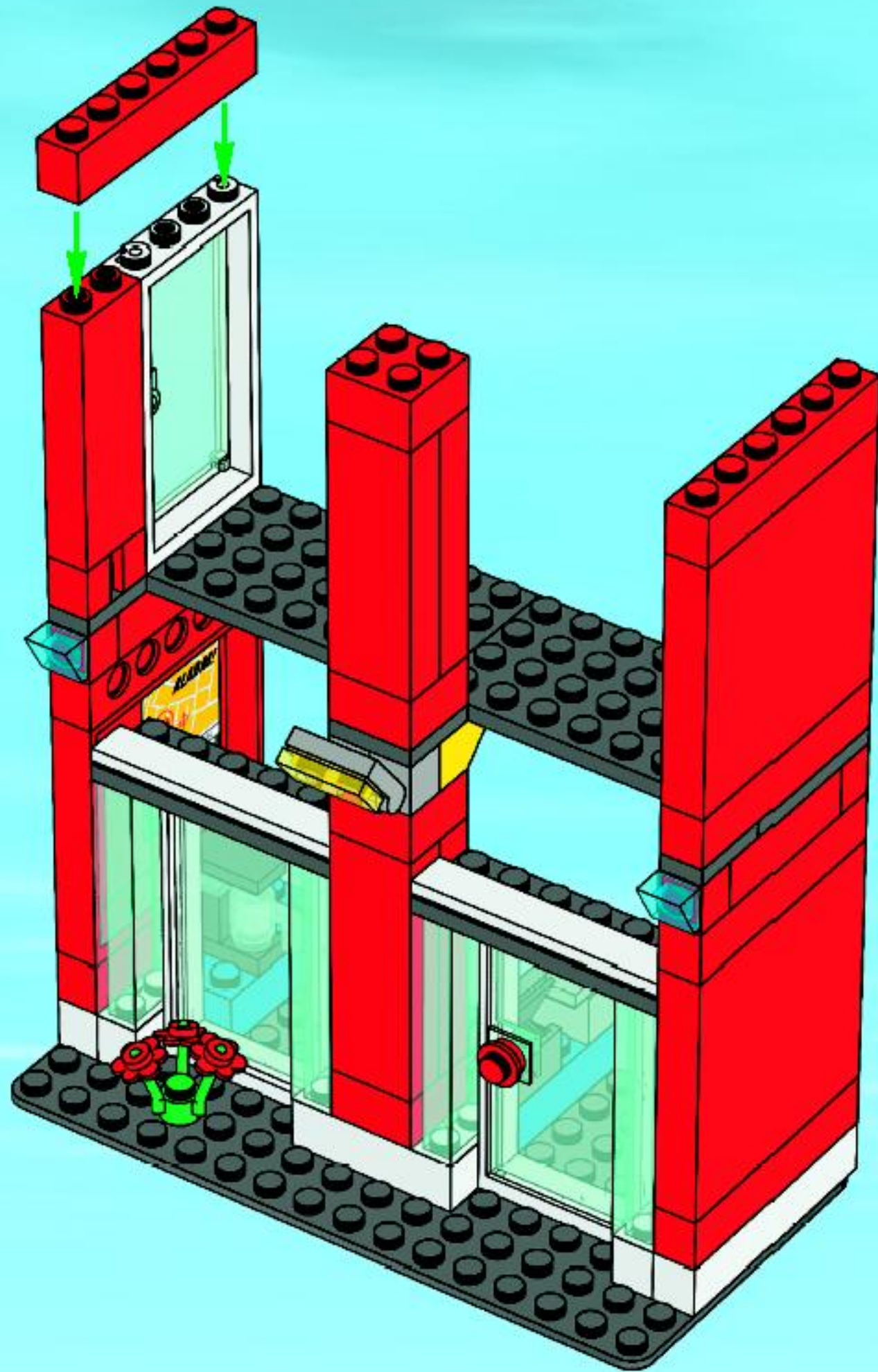

24

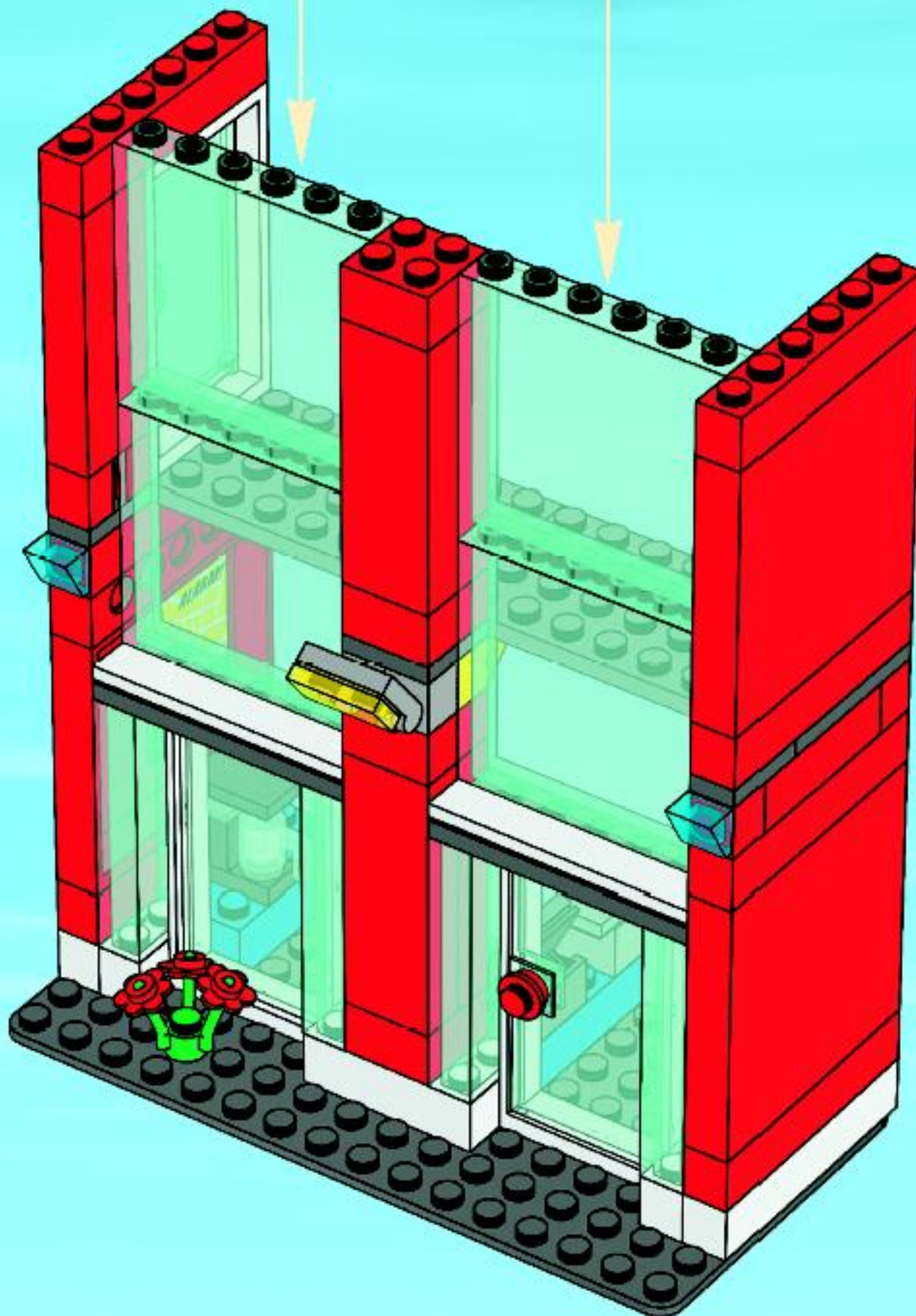
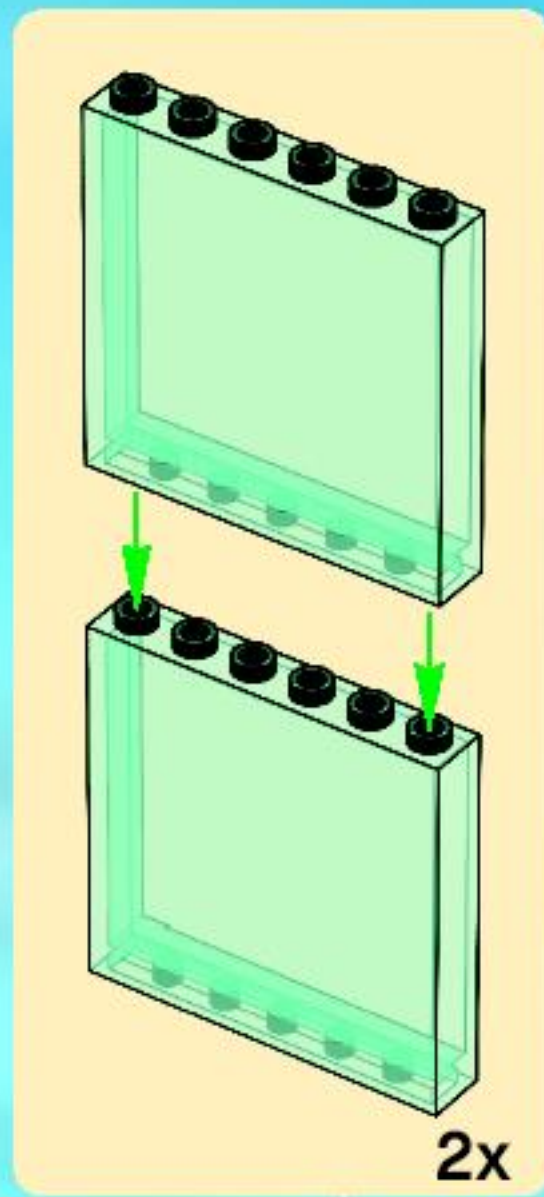

25

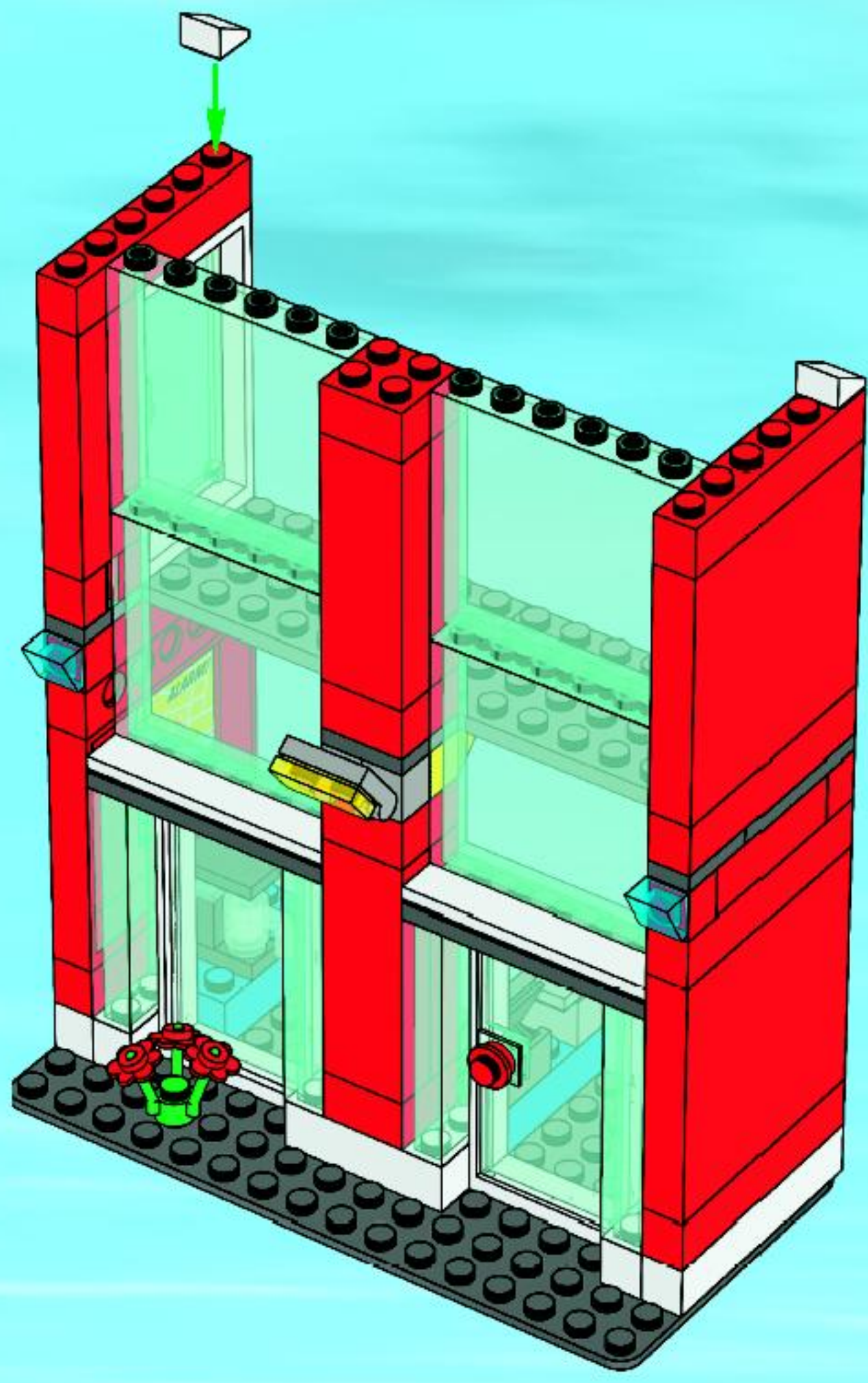

26

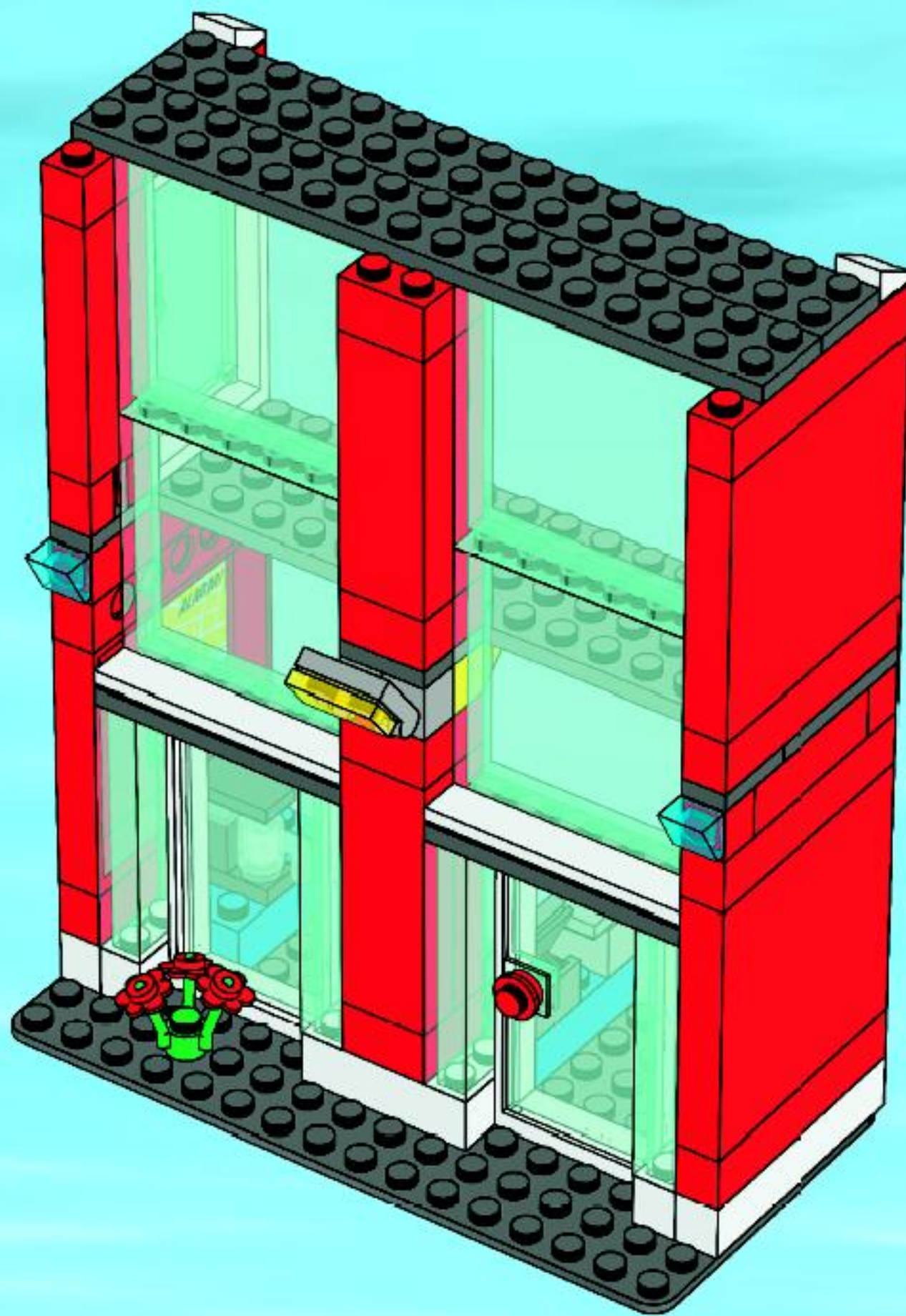

27



28

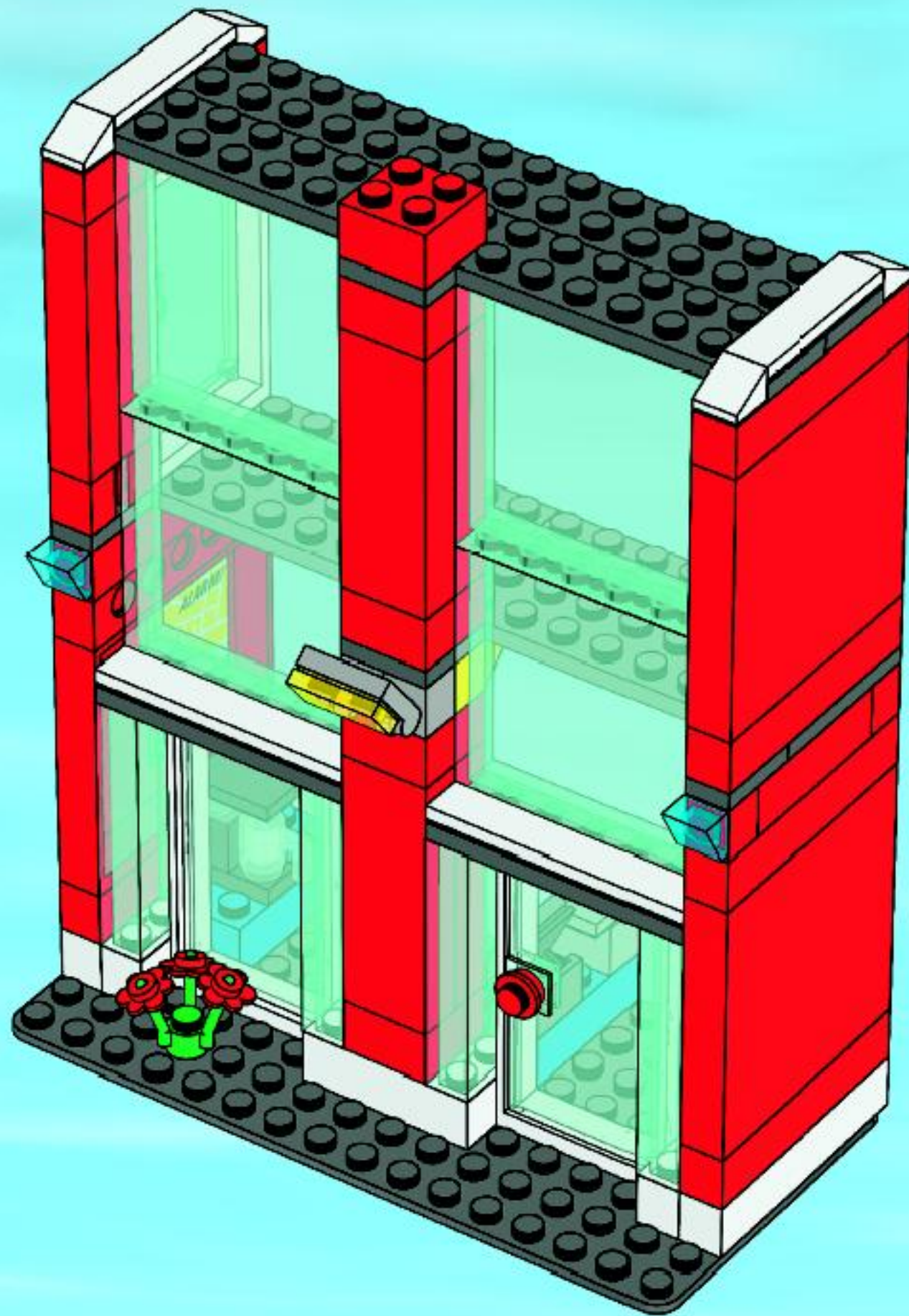

29

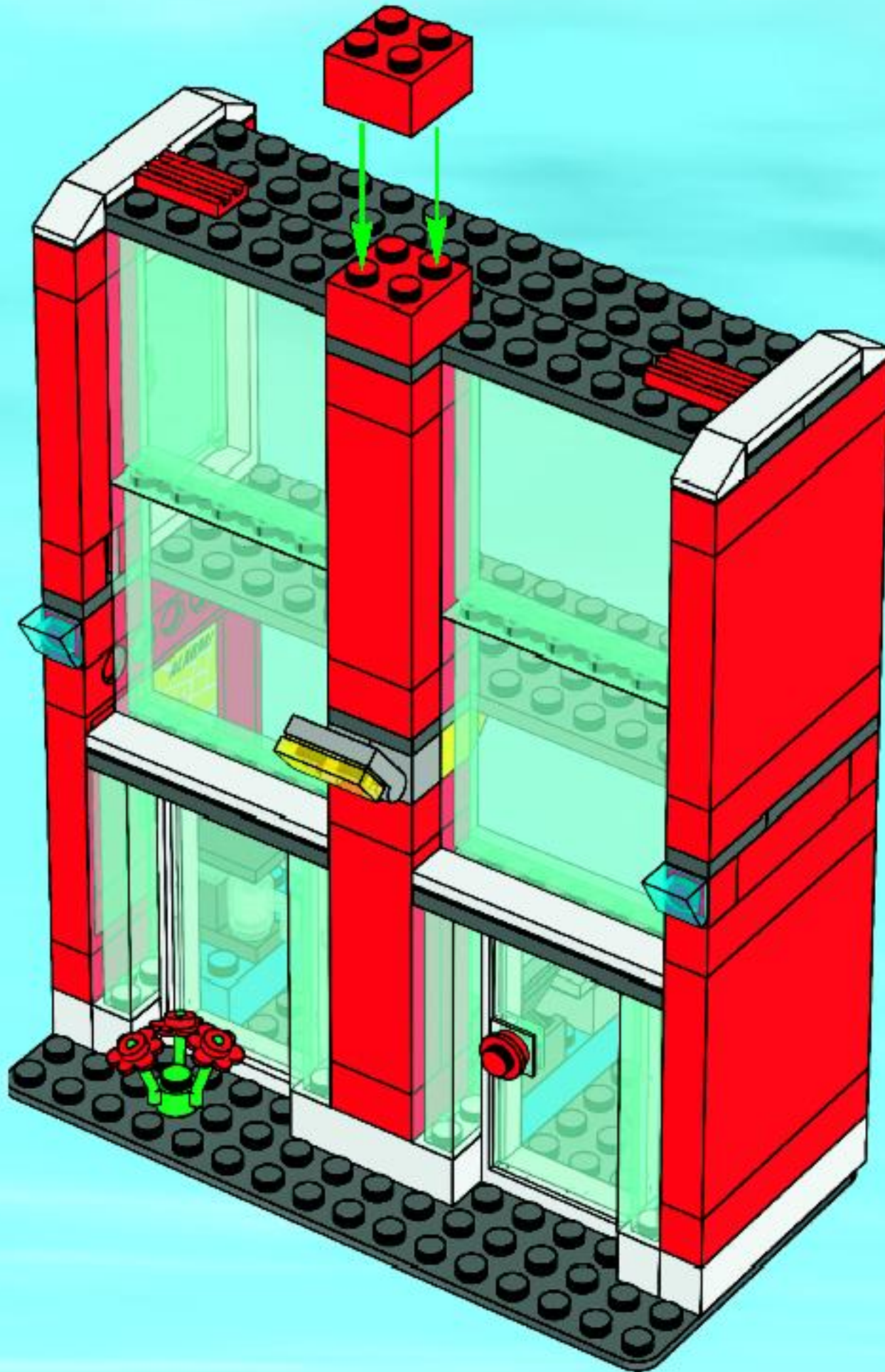

30

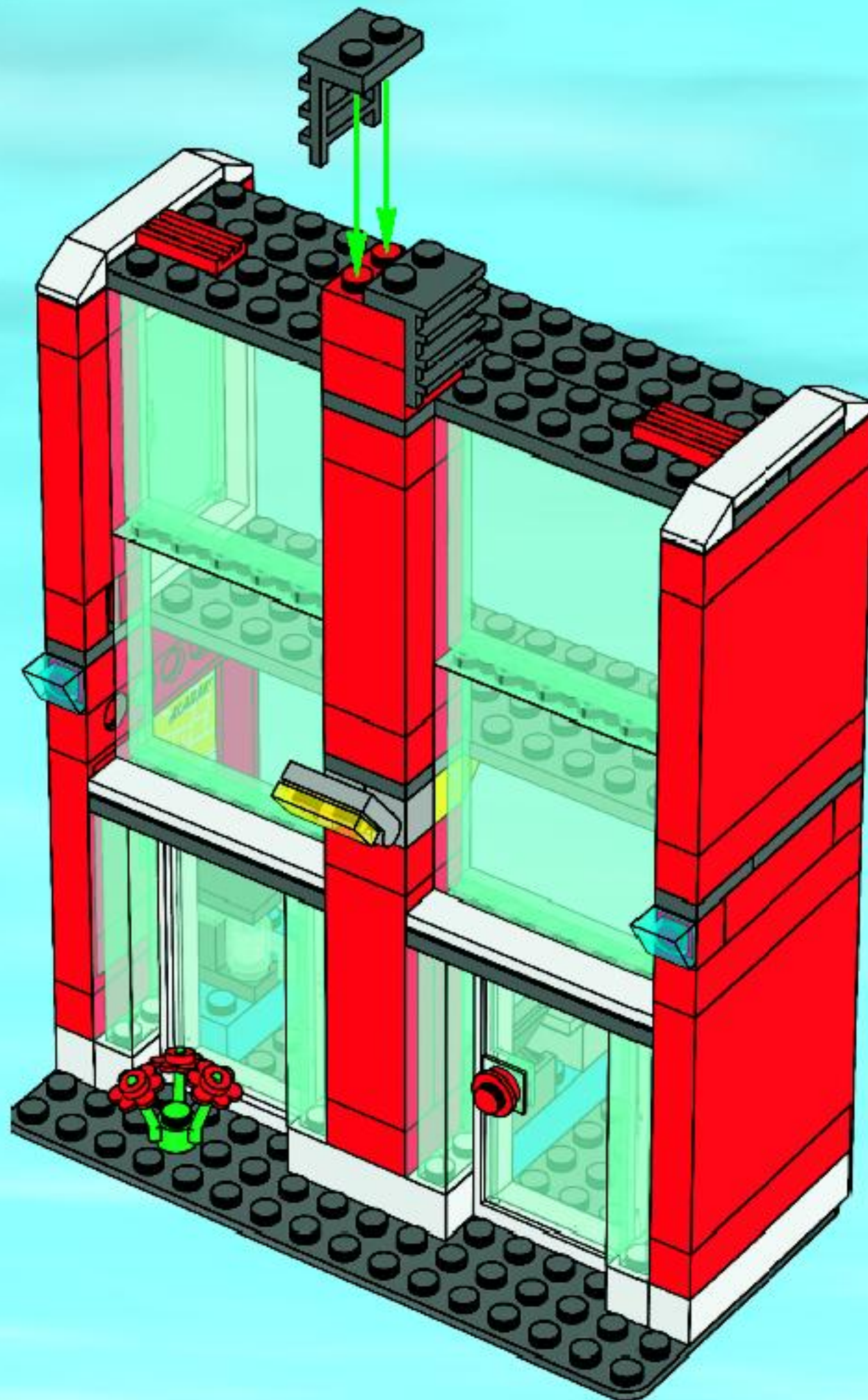

31

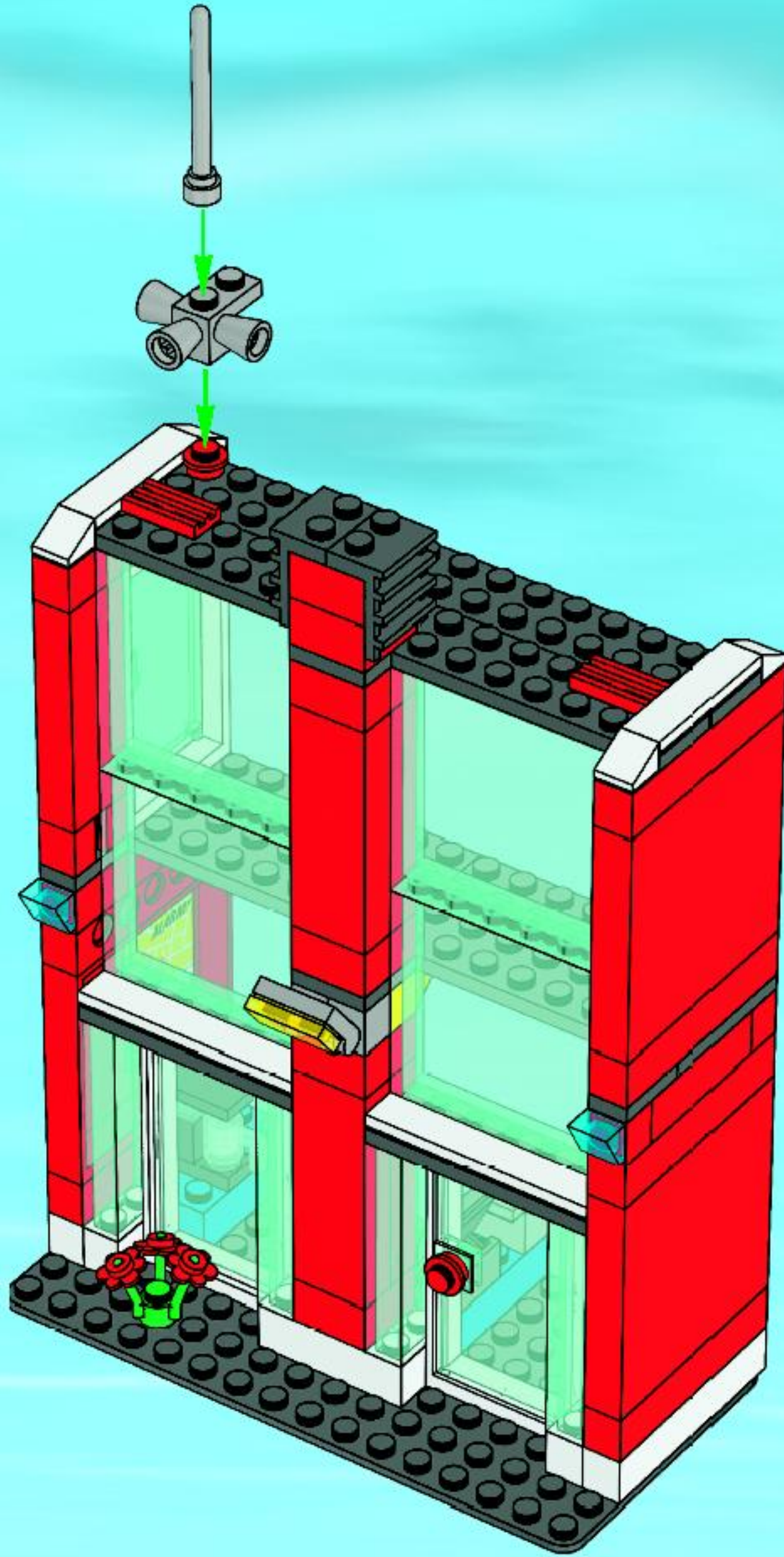

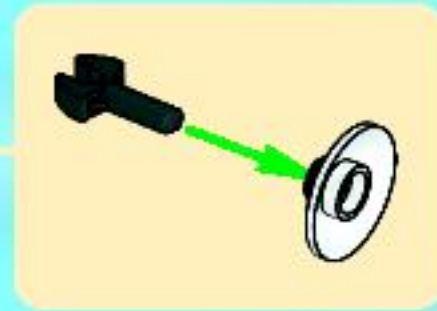
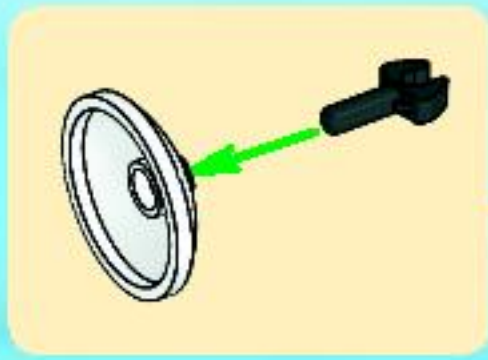

32

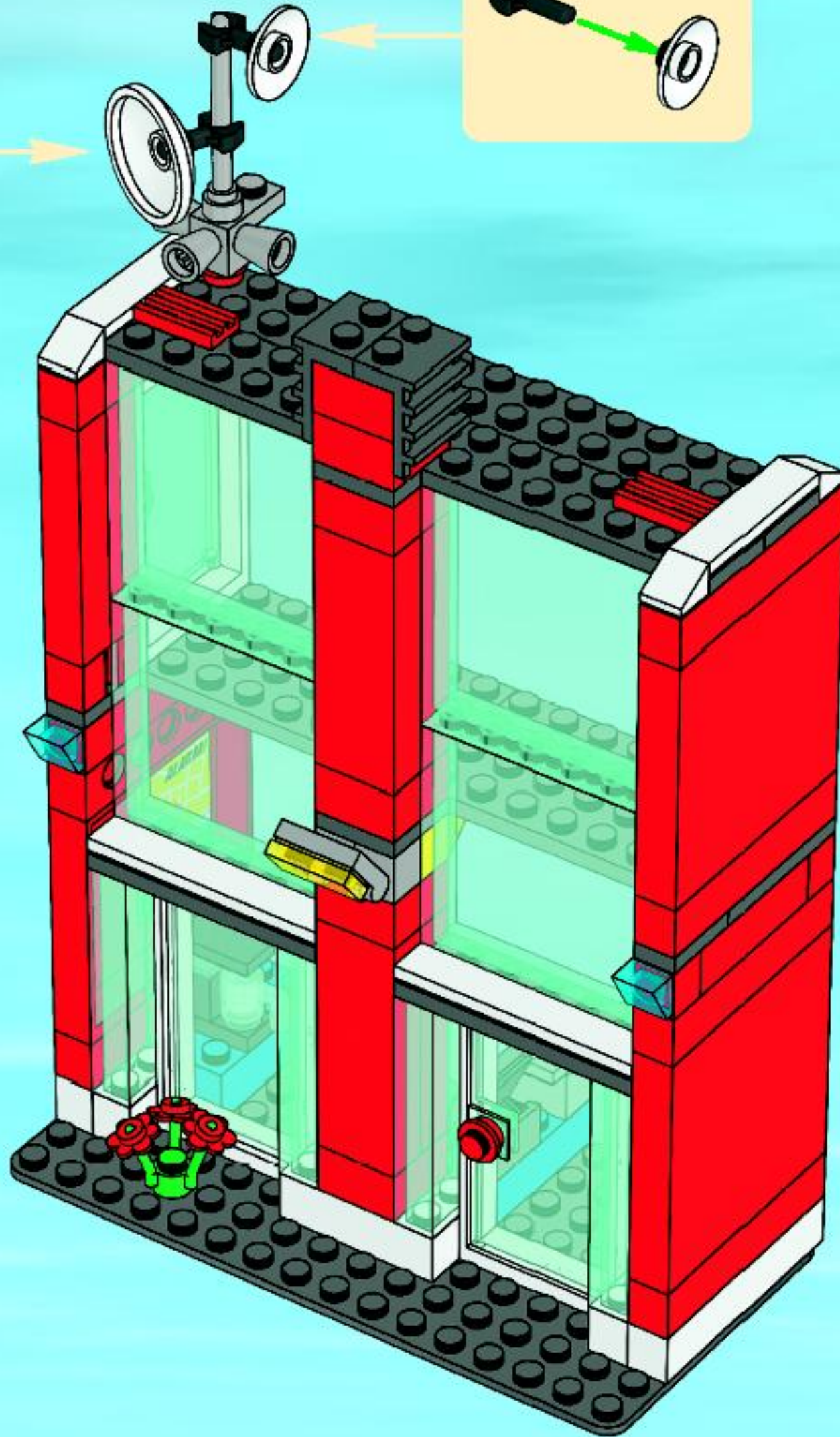

1

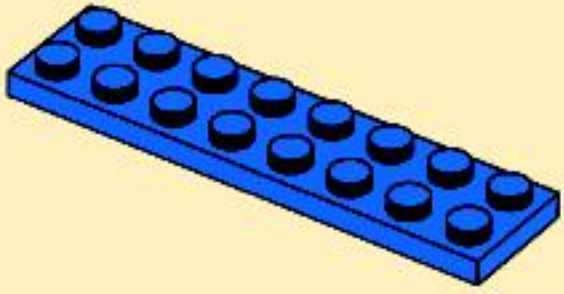

2

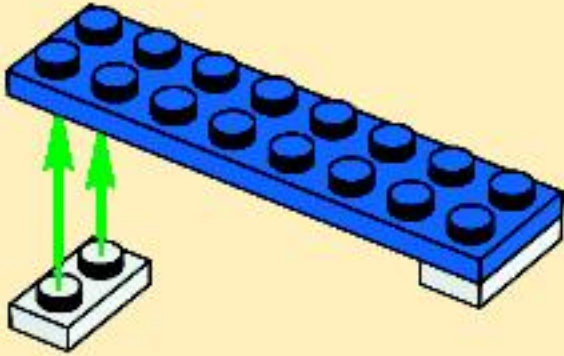

3

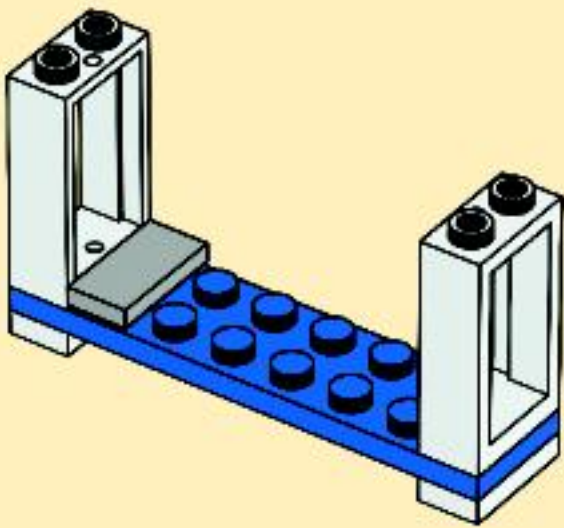

4

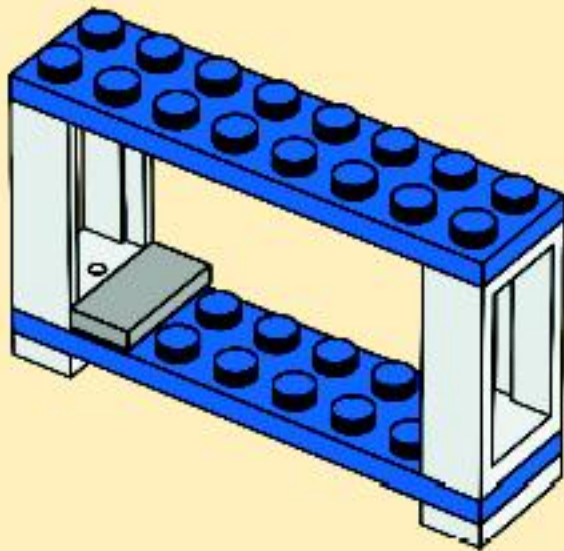

5

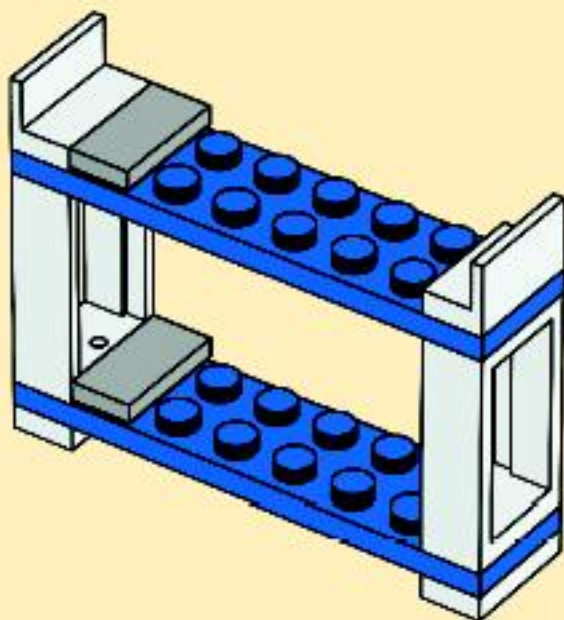

33

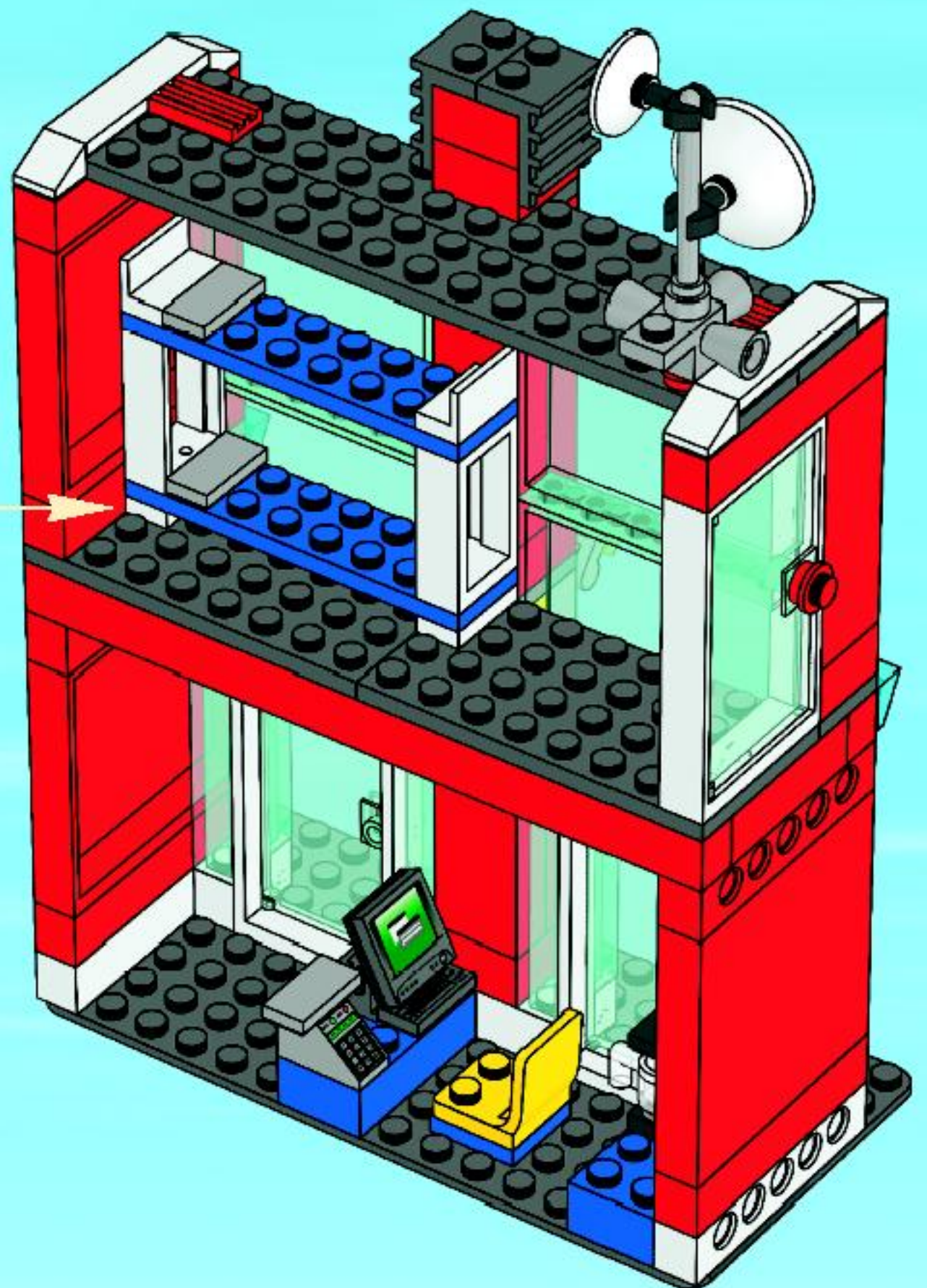

34

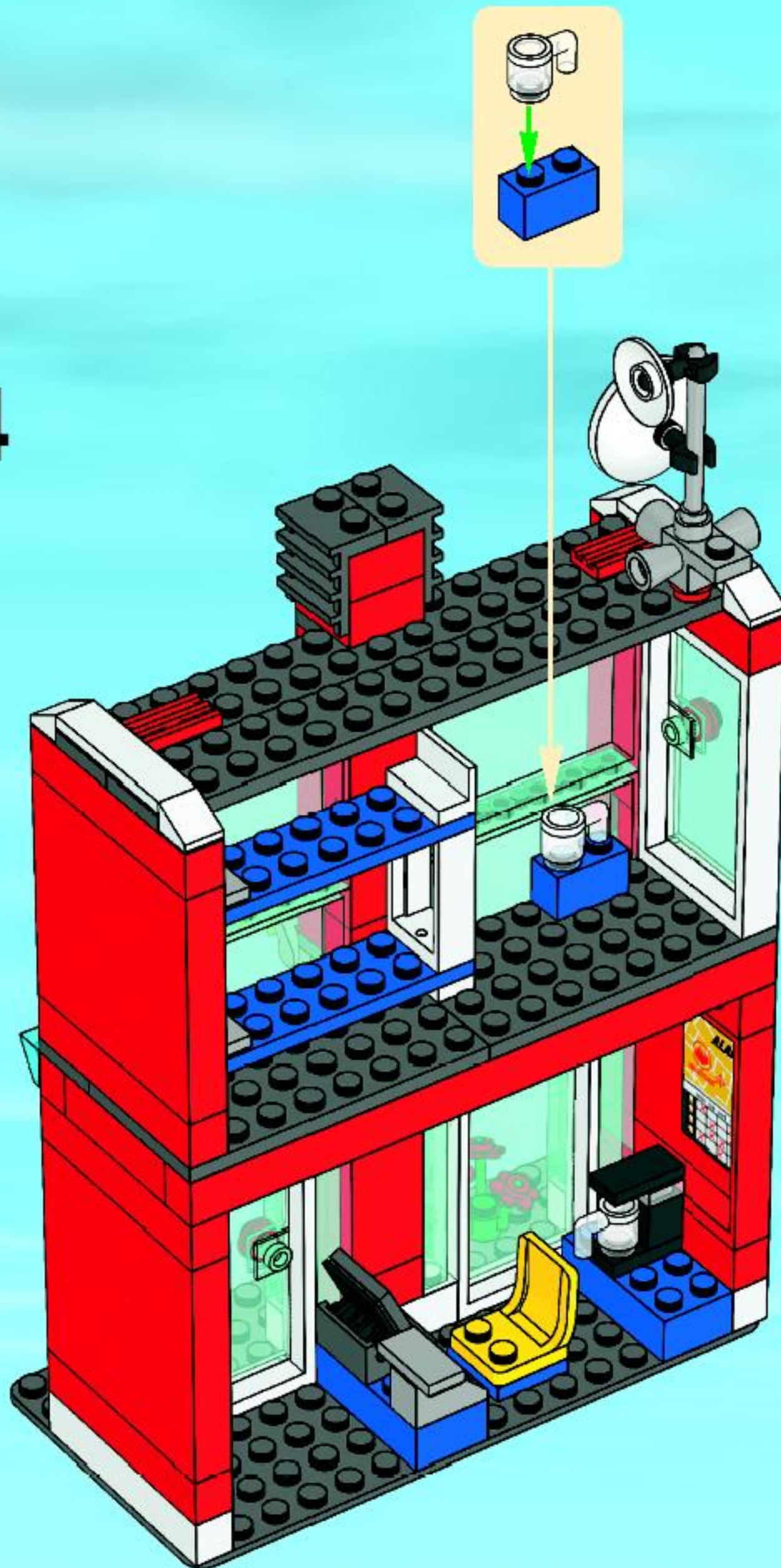

35



36



1

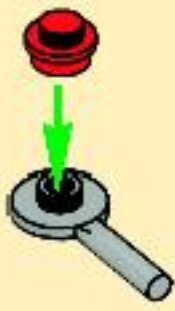

2



3



37

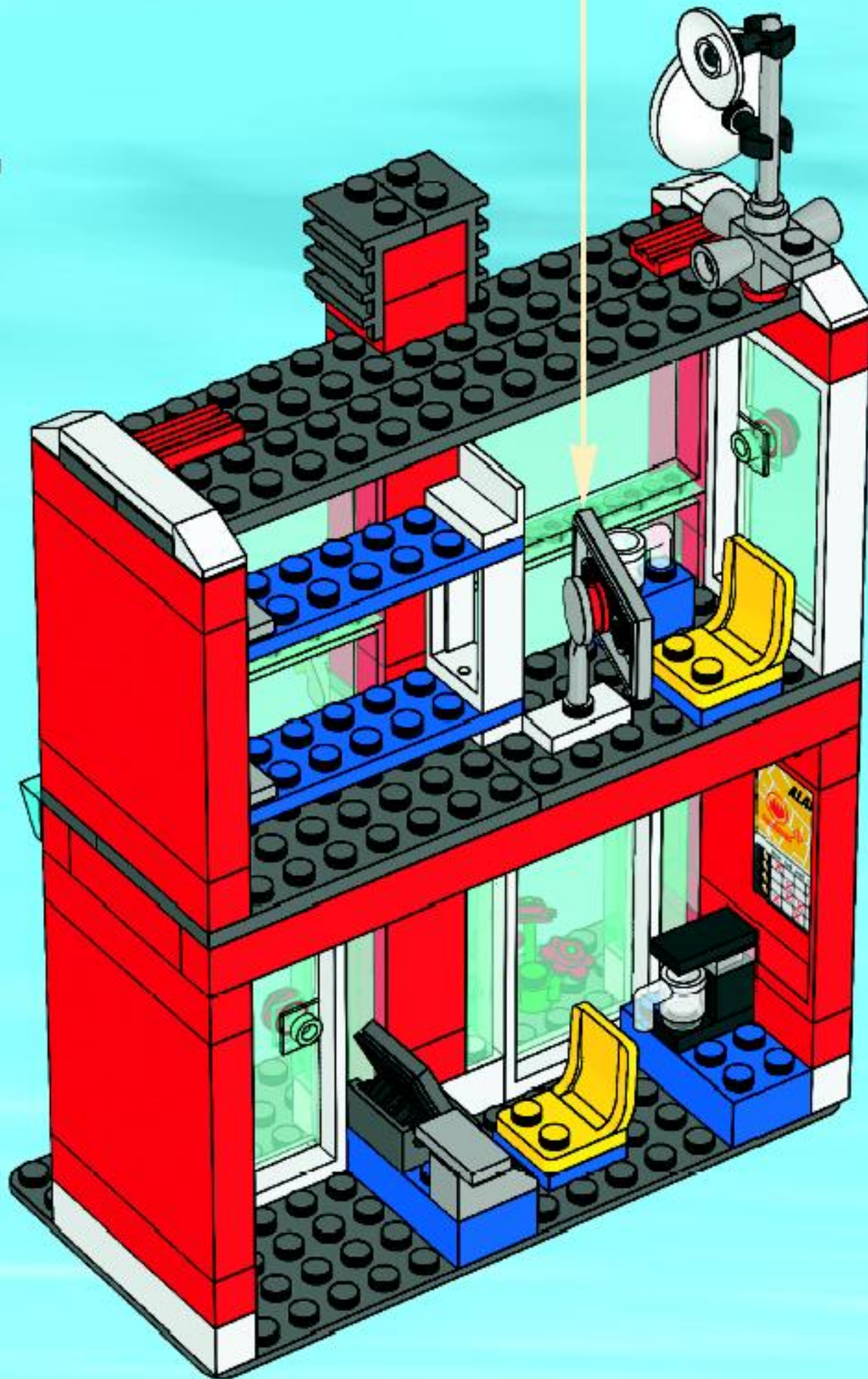

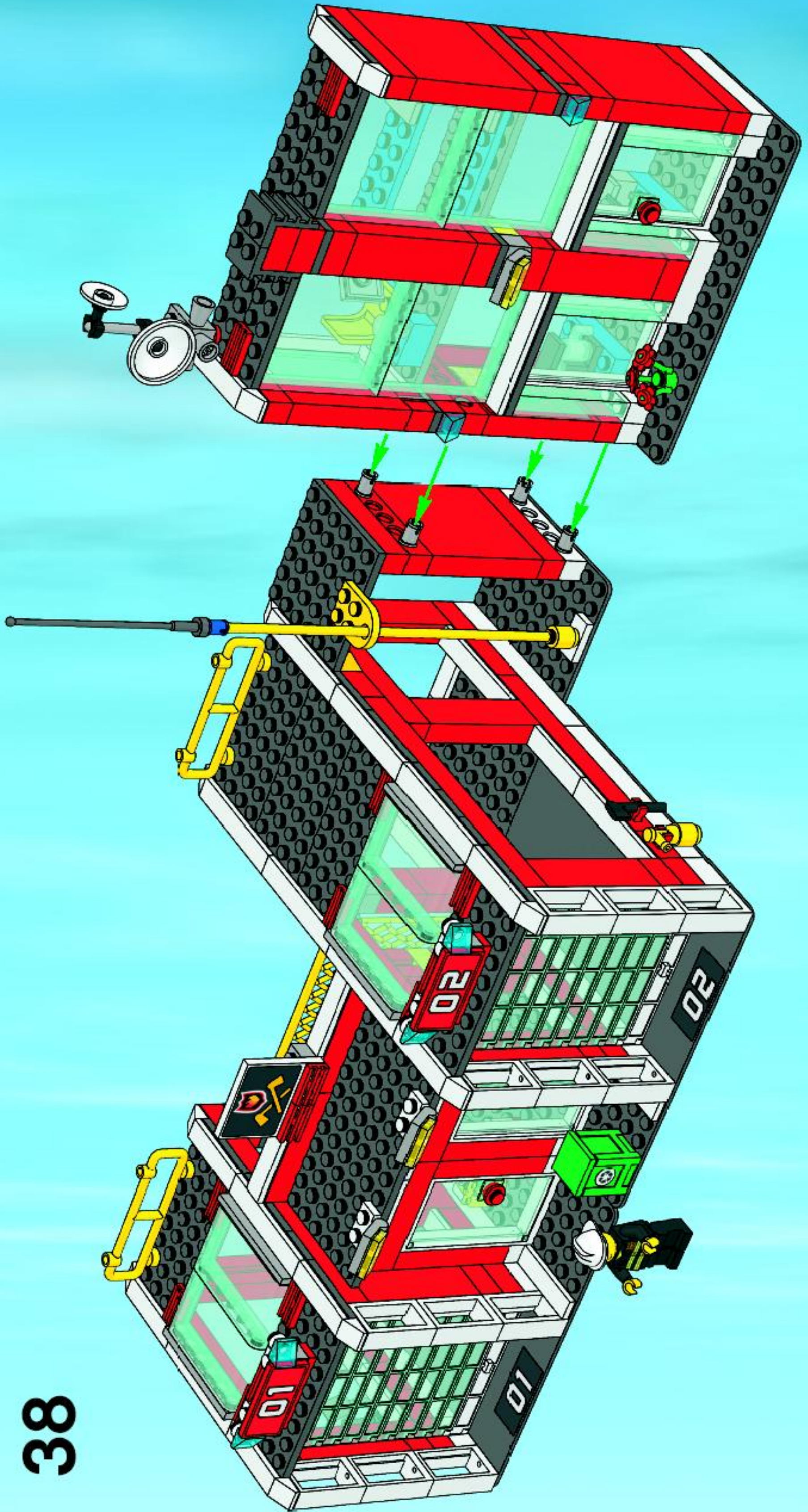

38

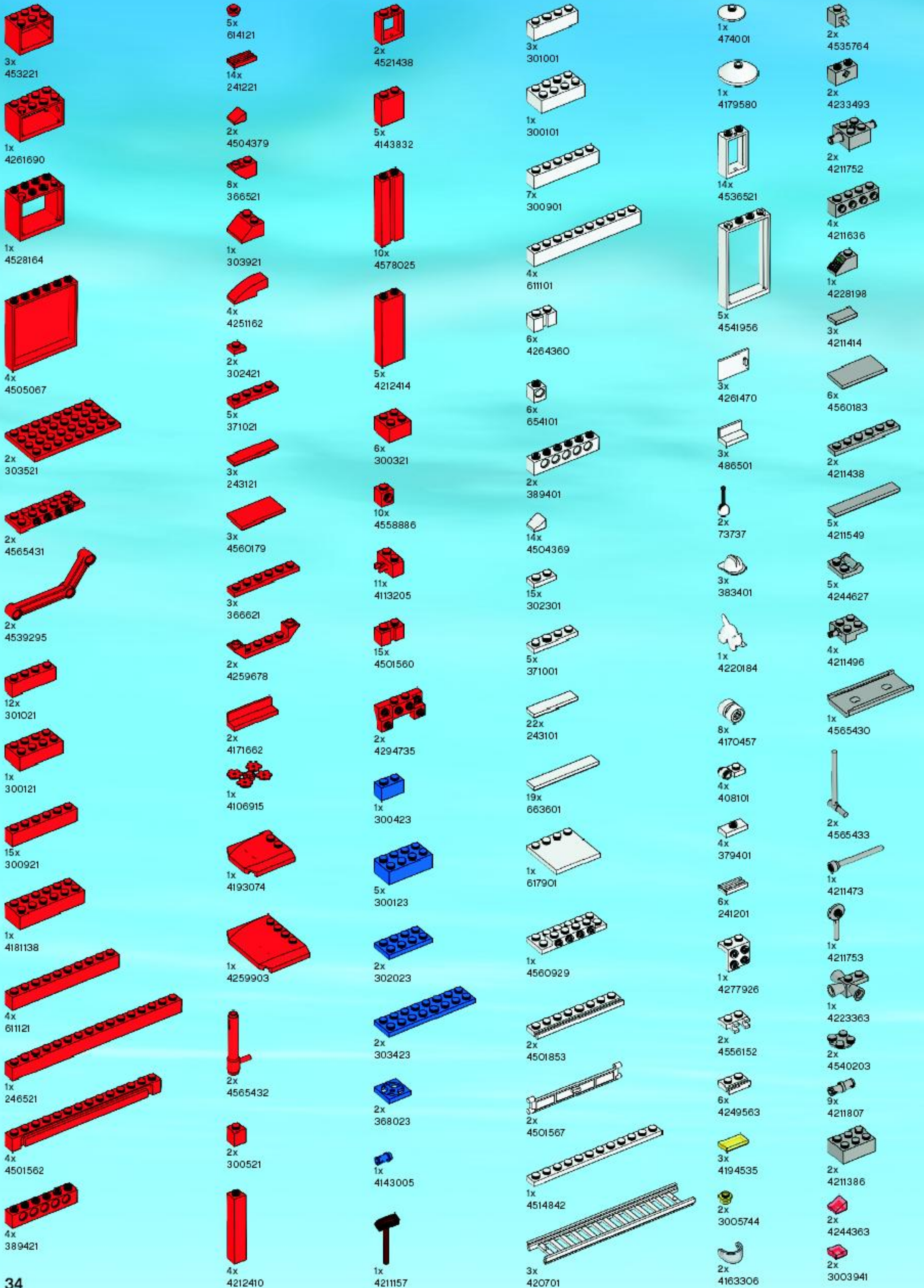

1x
4107762



1x
4548102



1x
374128



1x
347128



3x
383526



2x
396226



8x
4514560



2x
4289538



1x
4124096



1x
4262023



1x
4517986



1x
300526



1x
306926



1x
302326



2x
615726



4x
4275338



4x
9339



6x
383226



1x
4210642



1x
4558959



1x
4259673



5x
4211002



1x
4211134



2x
4211061



1x
4210794



6x
4211122



1x
4256149

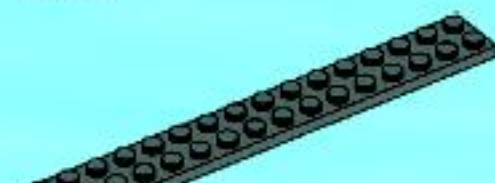

2x
4210796



2x
4226978

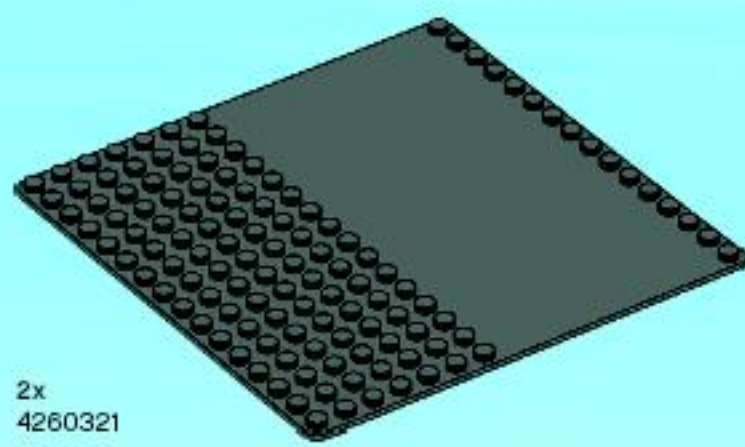

2x
4260321

1x
4493478

3x
4211063

2x
4211094

1x
4288298

2x
4211053

13x
4543086

2x
4210801

1x
4227517

2x
4521386

2x
4261469

1x
4211006

6x
4260124

1x
4211066

2x
4211128

4x
4283915

2x
4552034

2x
4500813

3x
4520866

2x
3000742

4x
4505000

18x
4258476

1x
4228126

5x
4546691

3x
306224

5x
366024

1x
4188313

2x
4256320

4x
407924

2x
243224

1x
4570663

1x
4578503

1x
4261301

1x
4194017

2x
383824

2x
9553

2x
4189225

1x
4562530

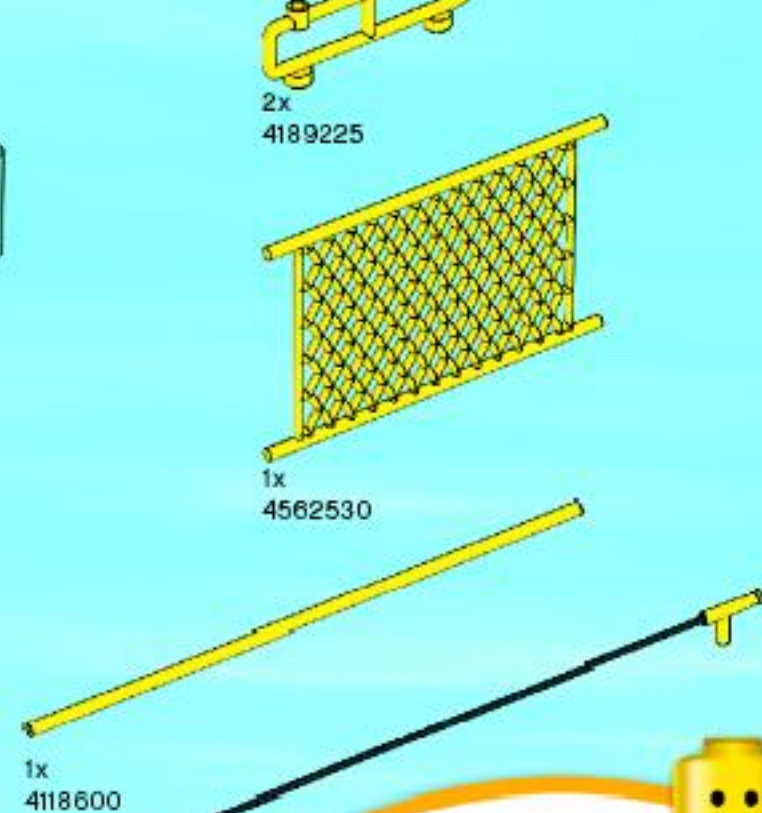

1x
4118600

1x
4262022

4x
4244362

1x
3000840

1x
3001140

2x
626440

12x
4244366

6x
4113854

8x
3005743

2x
4244369

1x
4260036

Customer Service
Kundenservice
Service Consommateurs
Servicio Al Consumidor

www.lego.com/service or dial



: 00800 5346 5555
: 1-800-422-5346



WIN!

Go to www.nielsen.com/LEGO to fill out a survey for a chance to win a cool LEGO® Product. No purchase necessary. Open to all residents where not prohibited.

 www.LEGO.com



www.nielsen.com/LEGO

GEWINNE!

Nimm an der Umfrage auf www.nielsen.com/LEGO teil und hab die Chance ein cooles LEGO® Produkt zu gewinnen!
Die Teilnahme am Gewinnspiel führt zu keinerlei Kaufverpflichtungen. Teilnahme in allen nicht ausgeschlossenen Ländern möglich.

WIN!

Ga naar www.nielsen.com/LEGO, vul een enquêteformulier in en maak kans op een cool LEGO® product.
Geen aankoopverplichting. Iedereen mag deelnemen, uitgezonderd in gebieden van landen waar een enquêteverbod geldt.

GAGNE!

Visite www.nielsen.com/LEGO pour répondre à un questionnaire et avoir une chance de gagner un produit LEGO® très cool!
Aucune obligation d'achat. Ouvert à tous les résidents des pays autorisés.

当てよう!

www.nielsen.com/LEGOにアクセスして、アンケートにご記入ください。当選者にはLEGO製品を差し上げます。
お買い上げの金額はありませぬ。禁止されていない限り、すべての情報にご利用いただけます。