



# NINJAGO

DRAGONS RISING

71790





### **Get excited about our new packaging!**

We're switching from plastic to paper-based packaging. That's why you might find a mix of paper and plastic in our boxes!

### **Nos nouveaux emballages vous emballeront !**

Nous passons des emballages en plastique aux emballages à base de papier. C'est pourquoi vous pourriez trouver un mélange de papier et de plastique dans nos boîtes !

### **¡Te presentamos nuestros nuevos empaques!**

Estamos sustituyendo las bolsas de plástico por bolsas con base de papel. ¡Por eso, puedes encontrar una mezcla de papel y de plástico en nuestras cajas!

**[LEGO.com/sustainable-packaging](https://www.lego.com/sustainable-packaging)**



# BUILDER



Apple and the Apple logo are trademarks of Apple Inc., registered in the U.S. and other countries and regions. App Store is a service mark of Apple Inc. Google Play and the Google Play logo are trademarks of Google LLC. Tencent and the Tencent logo are trademarks of Tencent Inc.

Q [LEGO.com/devicecheck](https://www.lego.com/devicecheck)

**EN** Ask parents' permission before going online | **DE** Eltern um Erlaubnis bitten, bevor du online gehst | **FR** Demande l'autorisation d'un parent avant d'aller en ligne | **IT** Chiedi il permesso ai tuoi genitori prima di andare online | **ES** Pídeles permiso a tus papás antes de conectarte a Internet | **PT** Pede autorização aos pais antes de acederes online | **ZH** 上网前应先征得父母的同意 | **PL** Poproś rodziców o zgodę, zanim wejdiesz do Internetu | **CS** Než půjdeš na internet, požádej rodiče o svolení | **SK** Skôr než pôjdeš na internet, vypýtaj si povolenie od rodičov | **HU** Kérj szülői engedélyt, mielőtt online csatlakoznál! | **RO** Cere permisiunea părinților înainte de a te conecta online | **BG** Поискайте разрешение от родител, преди да влезете онлайн | **LV** Pirms došanās tiešsaistē palūdz atļauju vecākiem | **ET** Enne Interneti kasutamist küsi vanematelt luba | **LT** Prieš prisijungdami prie interneto, atsilkauskite tėvų









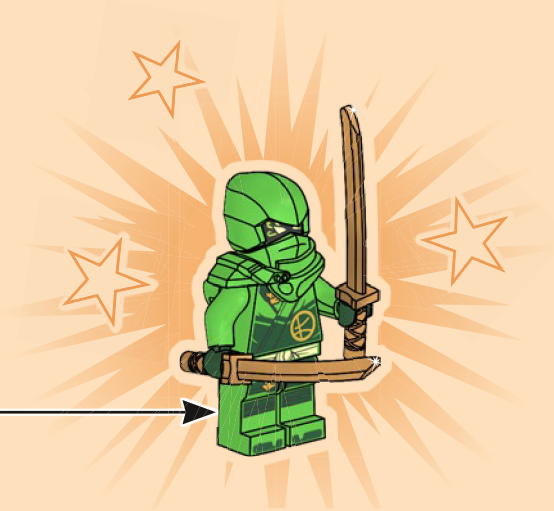
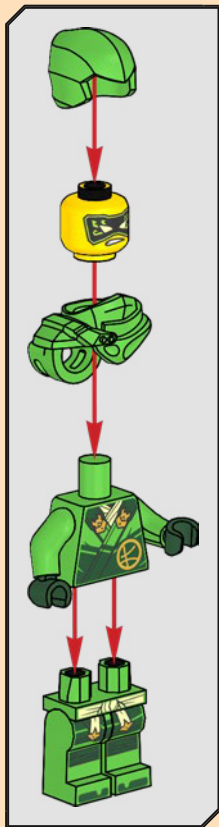

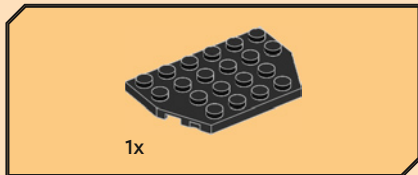

1x

1

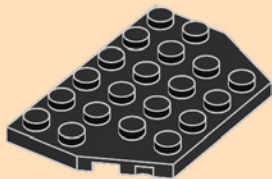

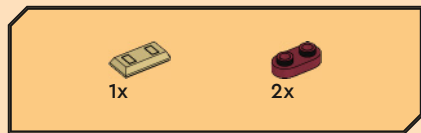

2

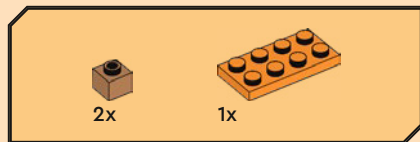
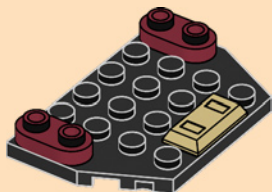

3

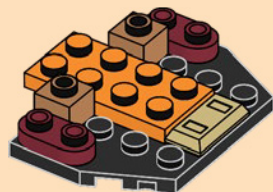



4

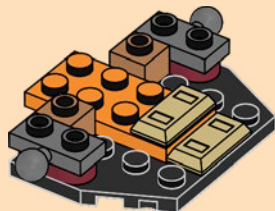



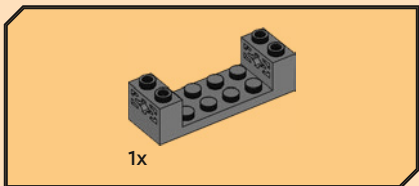
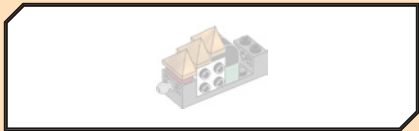

5

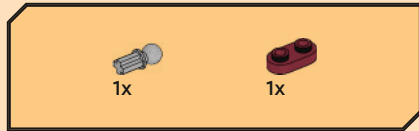
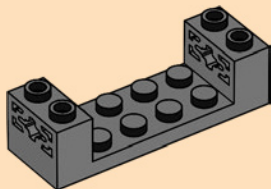

6

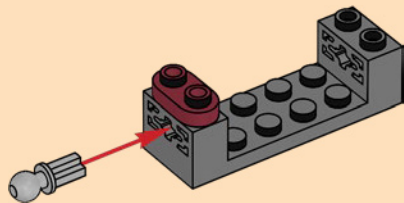

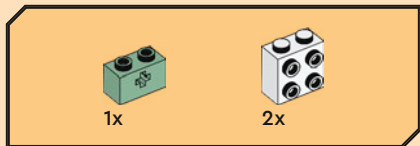

7

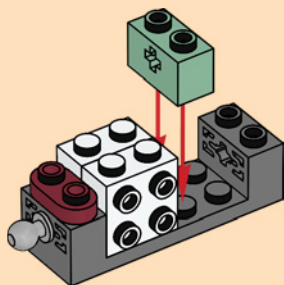

8

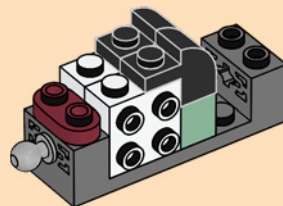

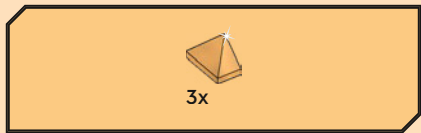

9

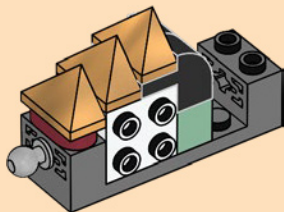

10

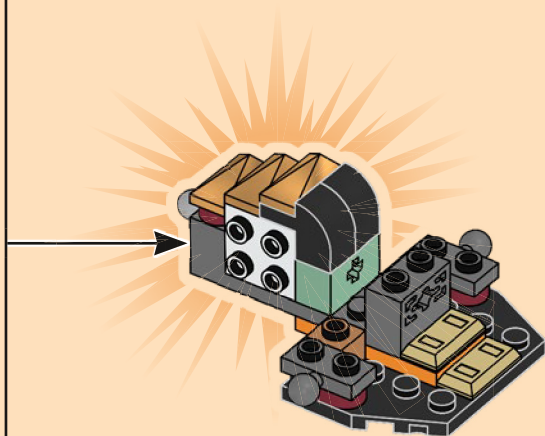

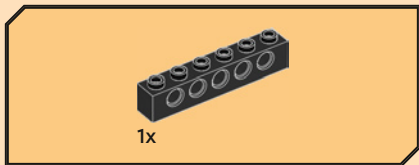

11

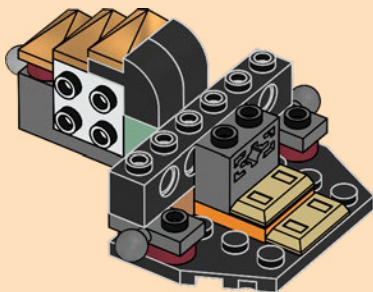

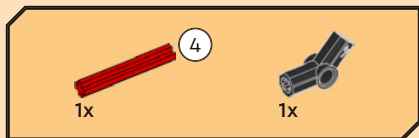

12

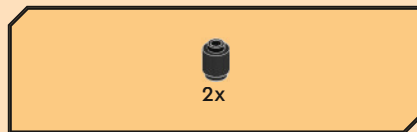
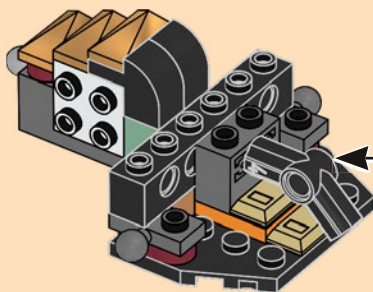
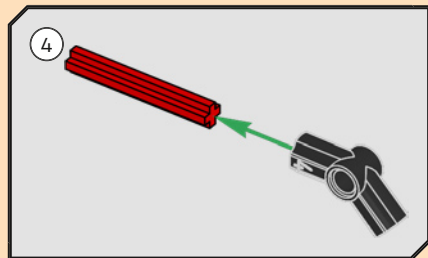

13

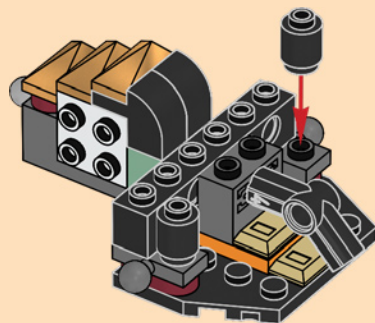



14

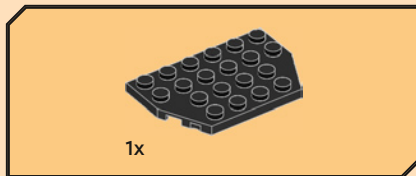
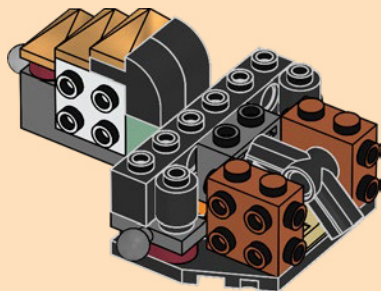

15

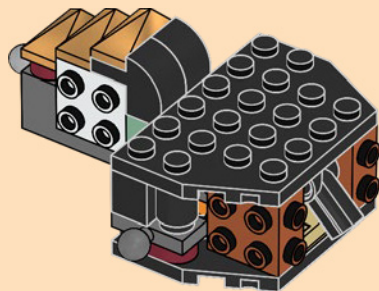



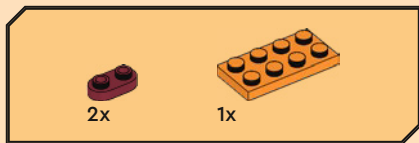

16

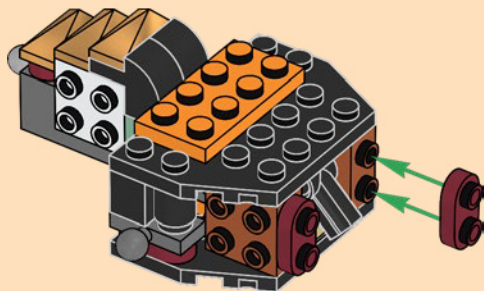

17

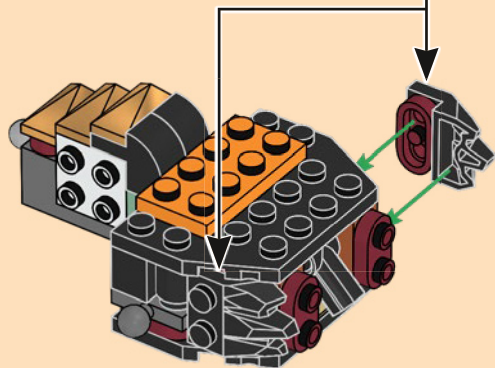
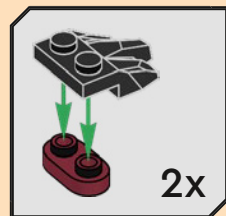

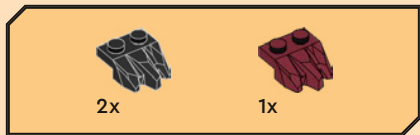

18

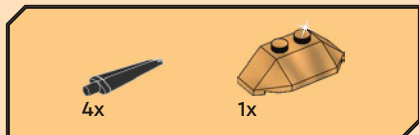
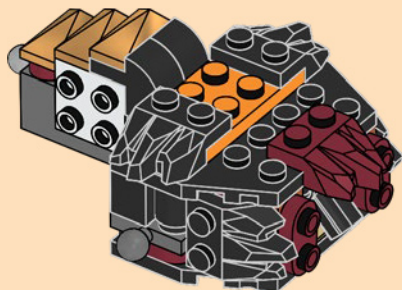

19

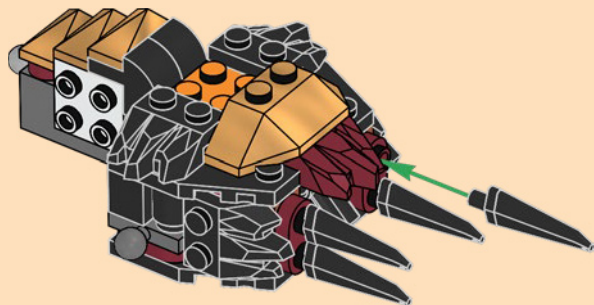

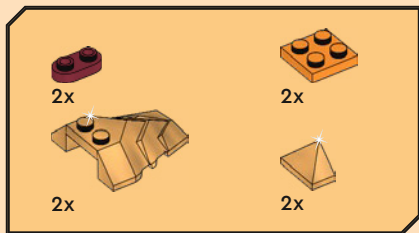

20

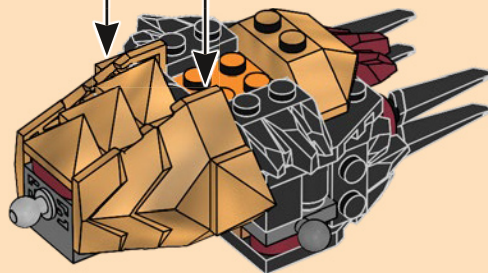
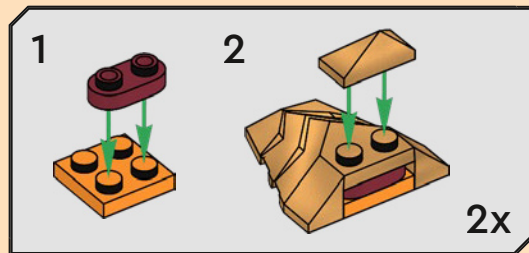



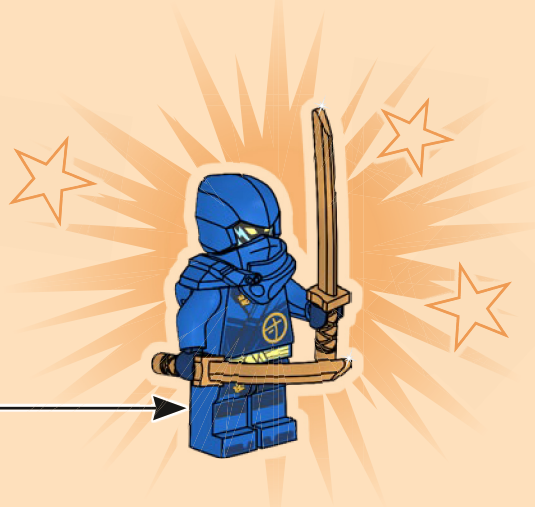
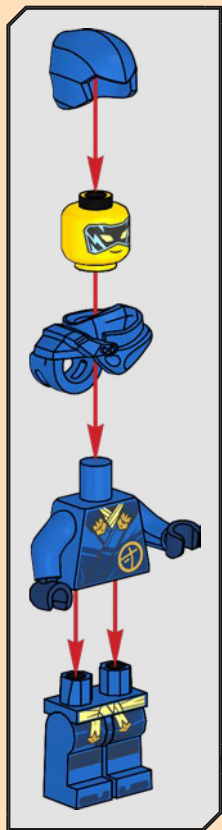

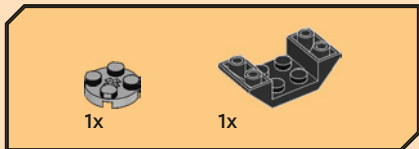
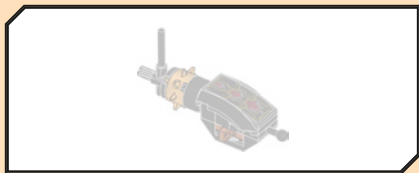

21

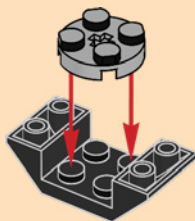

22

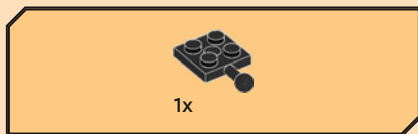
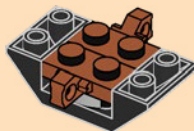

23

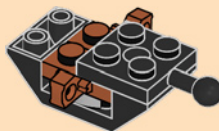





24

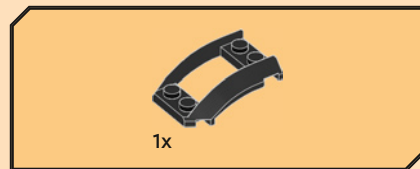
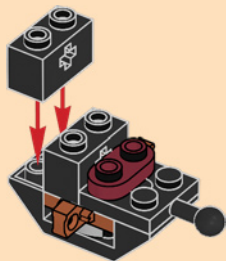

25

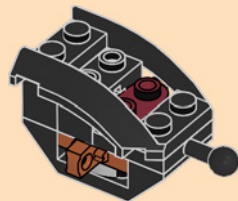

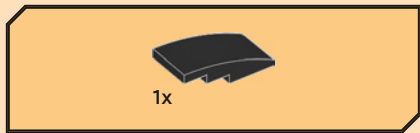

26

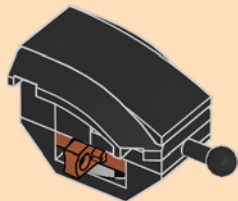

27

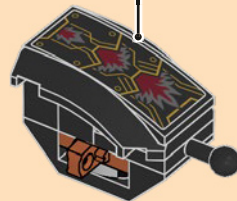

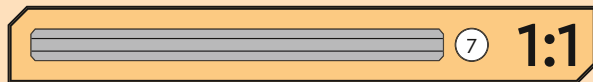
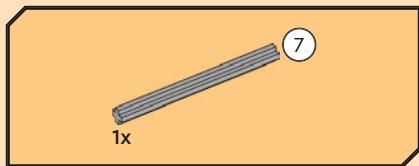

28

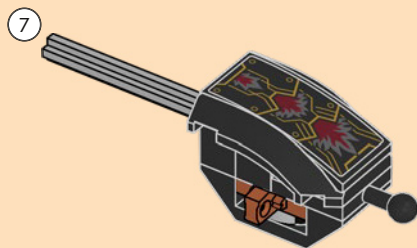

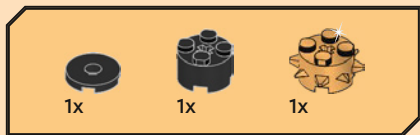

29

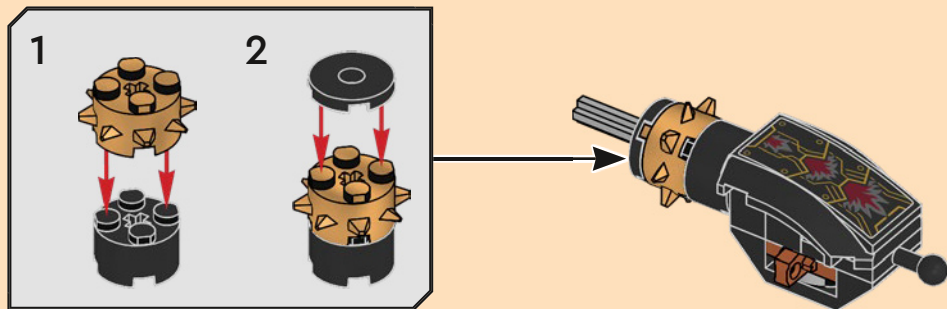



30

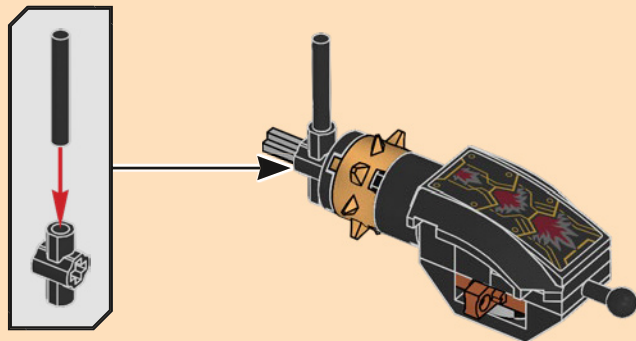

31

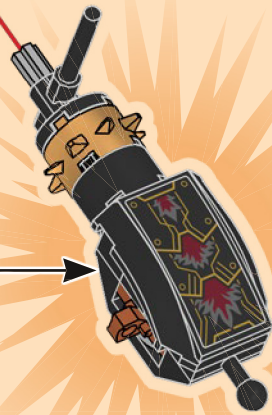
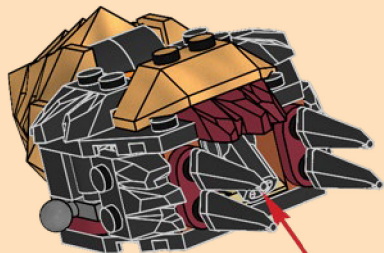



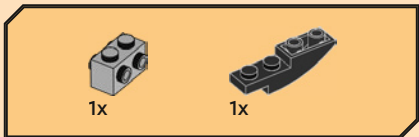

32

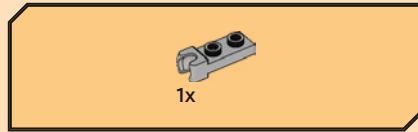
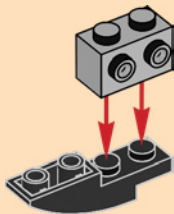

33

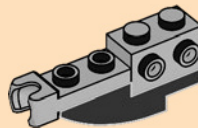



2x

34

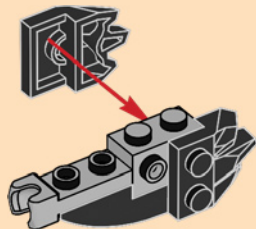

2x

35

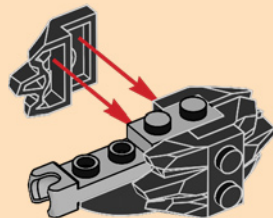



1x



1x

# 36

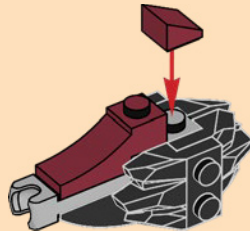

37

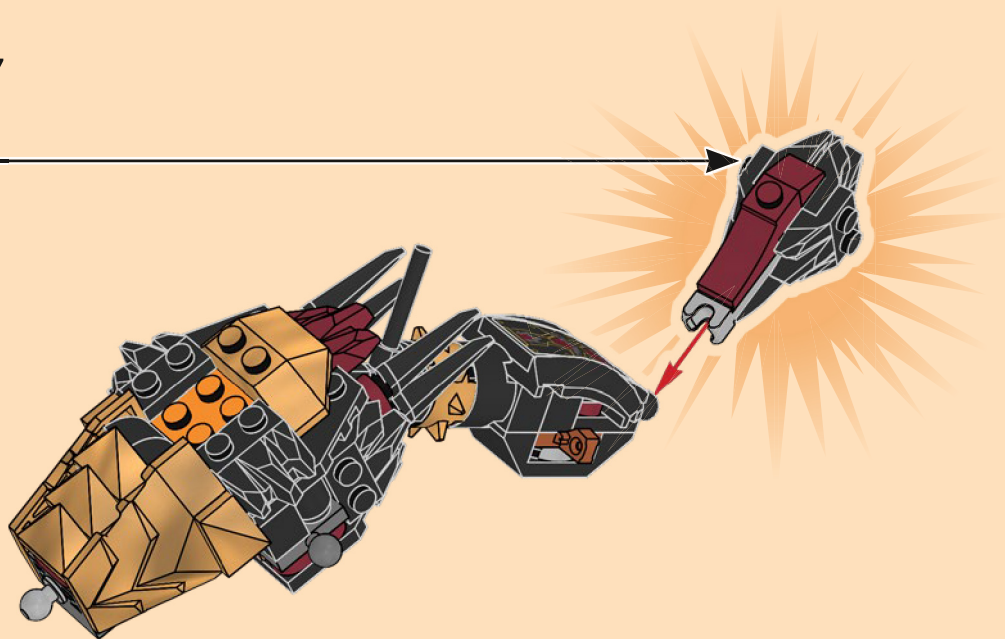

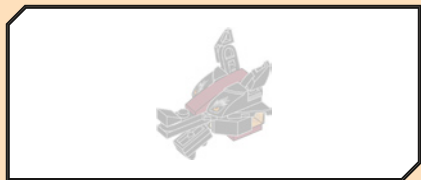

1x

38

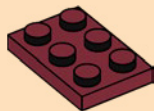

1x

1x

39

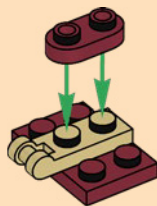

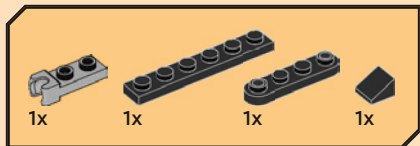

40

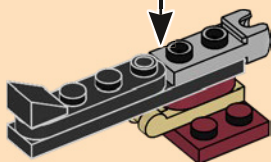
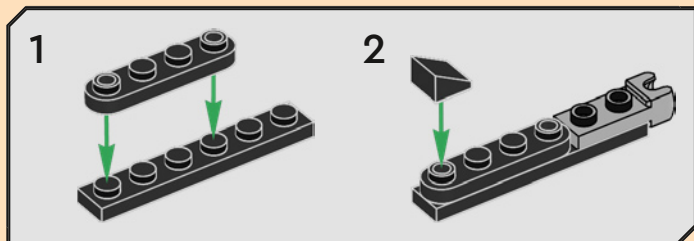

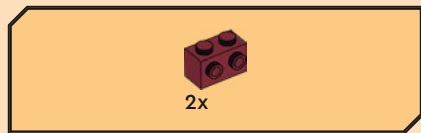

41

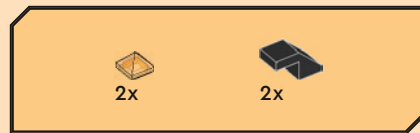
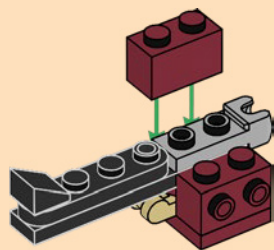

42

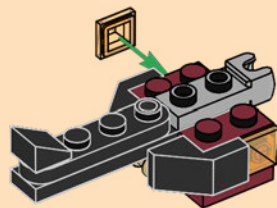

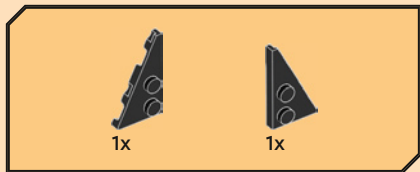

43

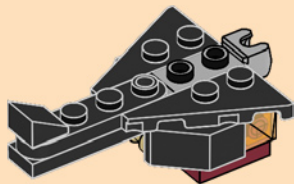

44

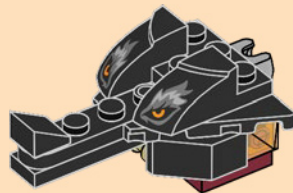



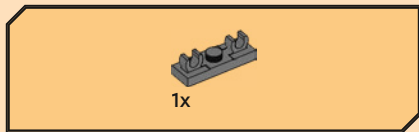

45

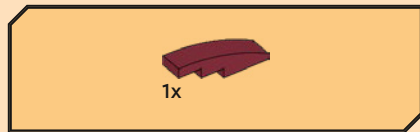
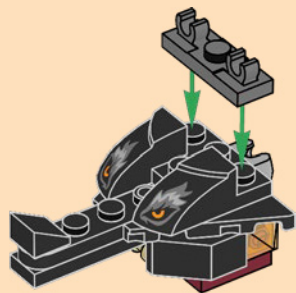

46

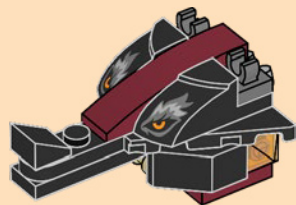



47

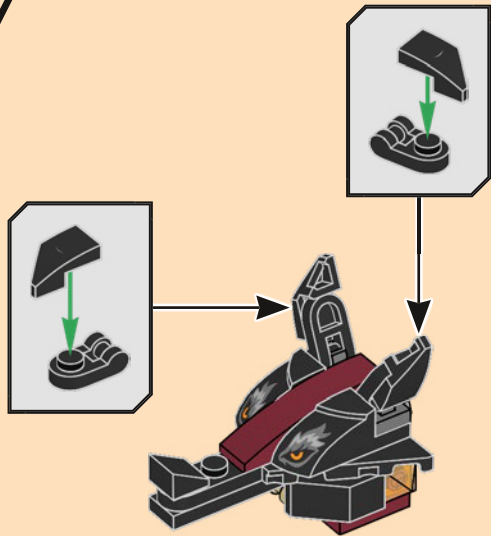

48

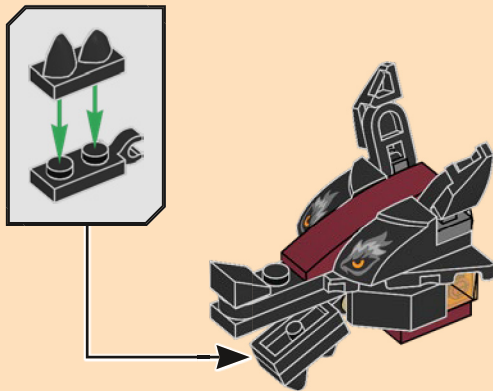

49

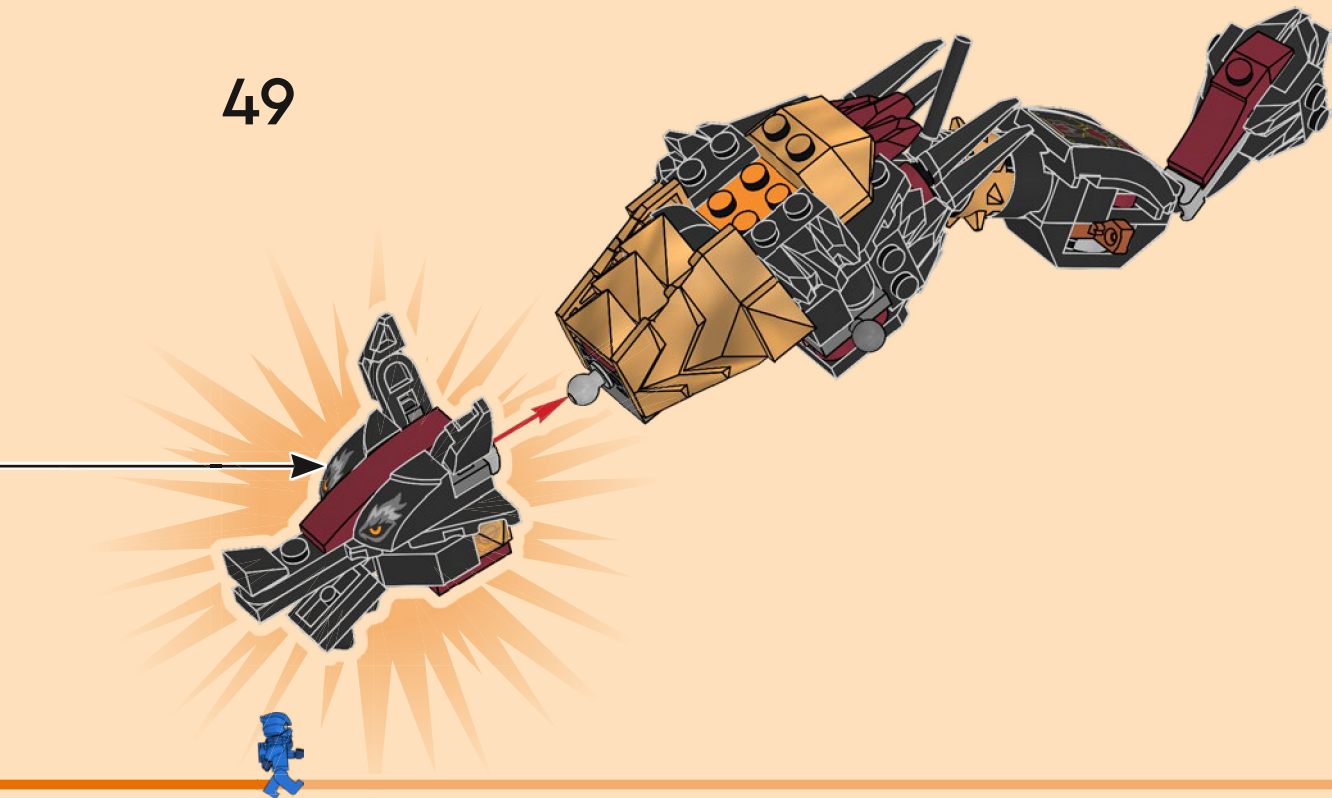





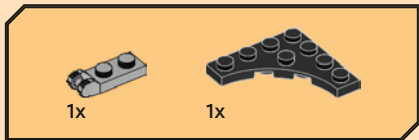
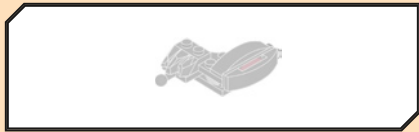

50

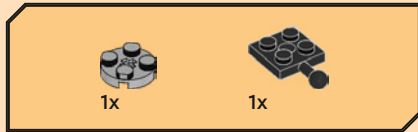
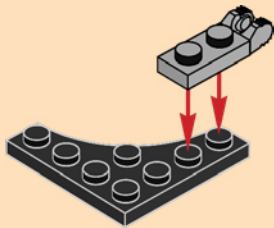

51

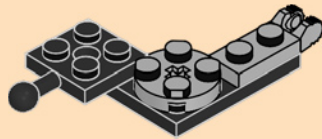

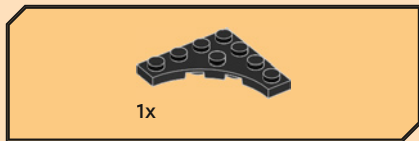

52

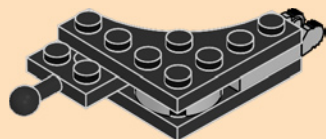

53

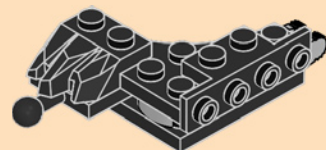



54

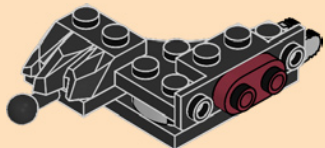

55

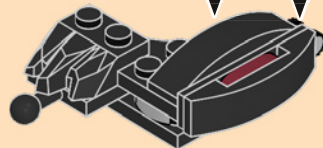



56

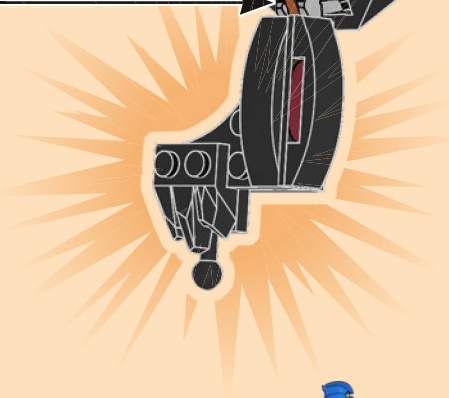
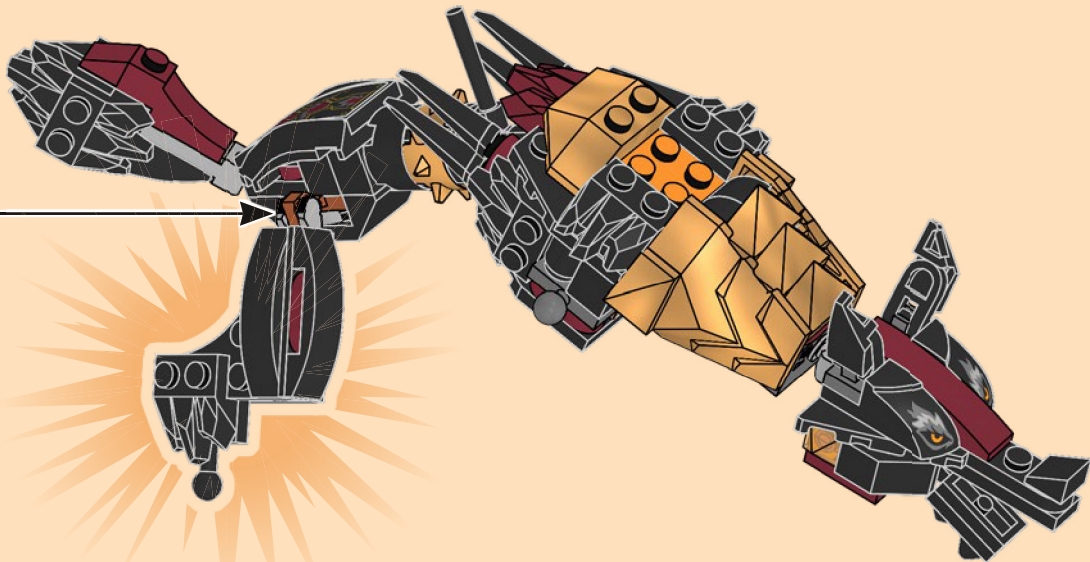

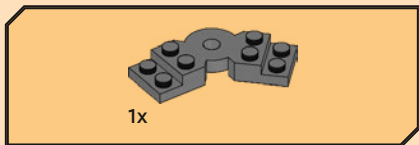
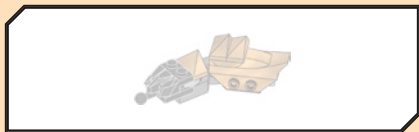

1x

57

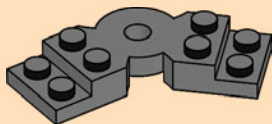

1x

1x

58

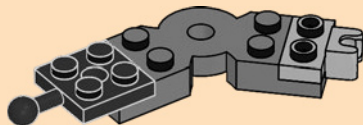

1x

1x

59

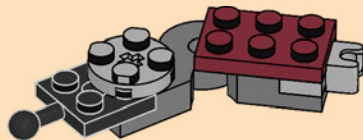

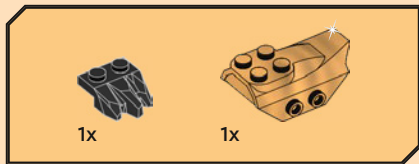

60

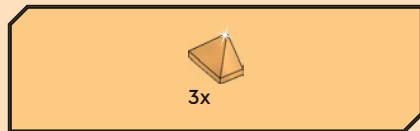
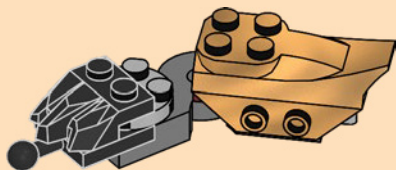

61

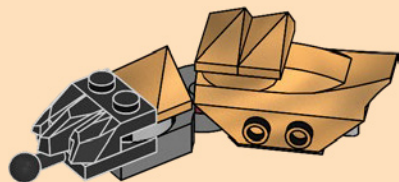

62

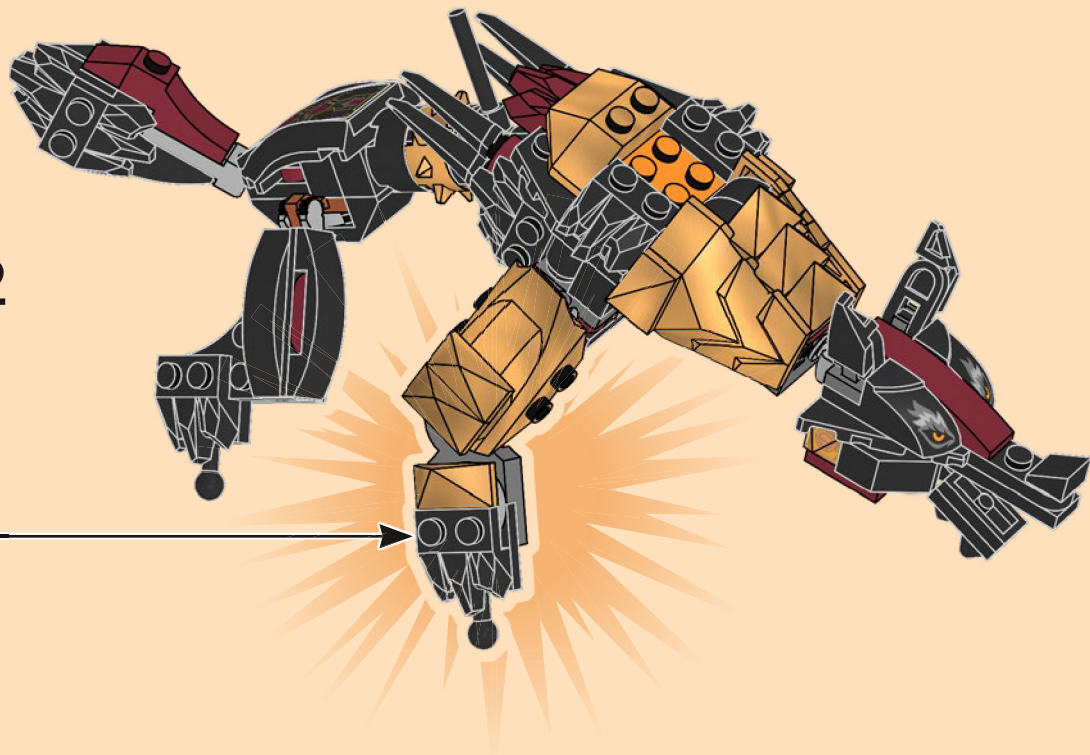

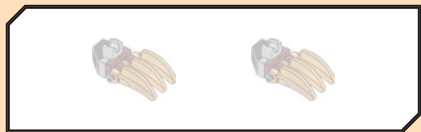

63



64

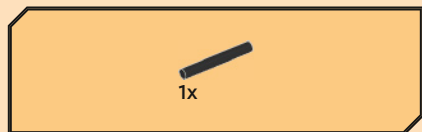
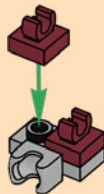

65

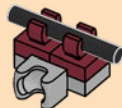

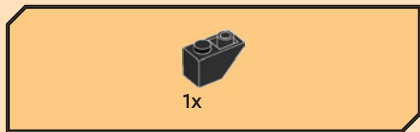

66

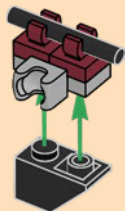

67

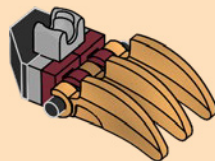
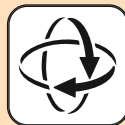

2x

68

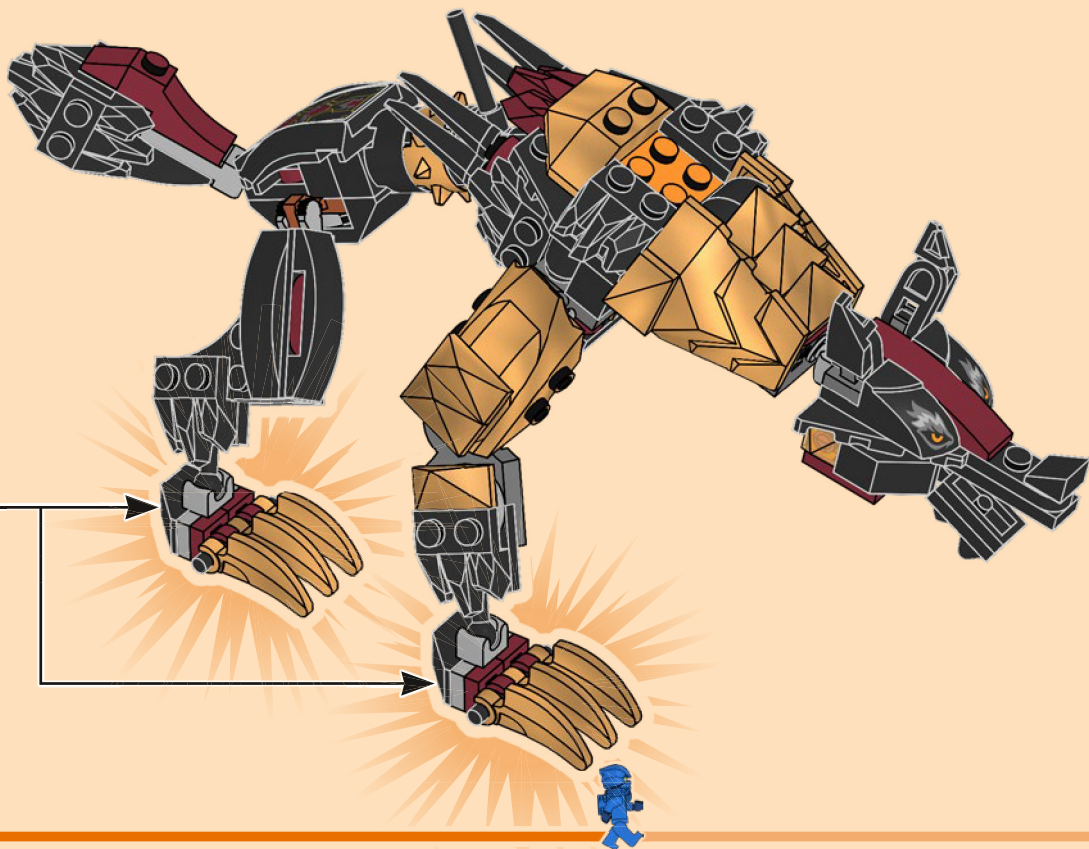

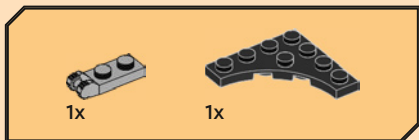
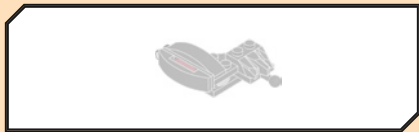

69

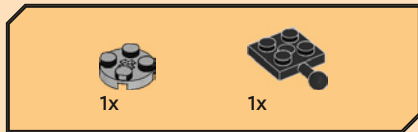
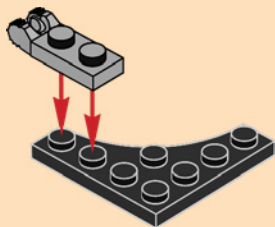

70

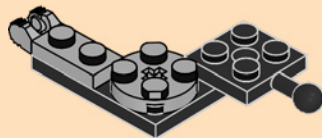



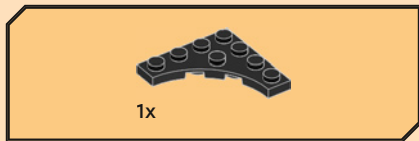

71

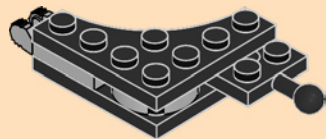

72

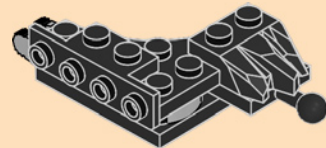



73

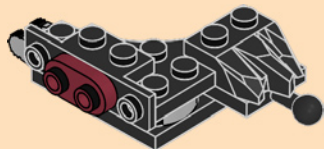

74

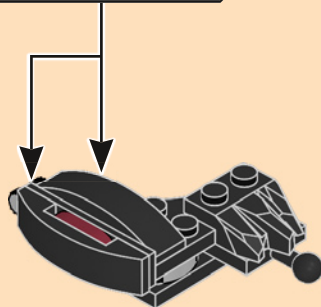

75

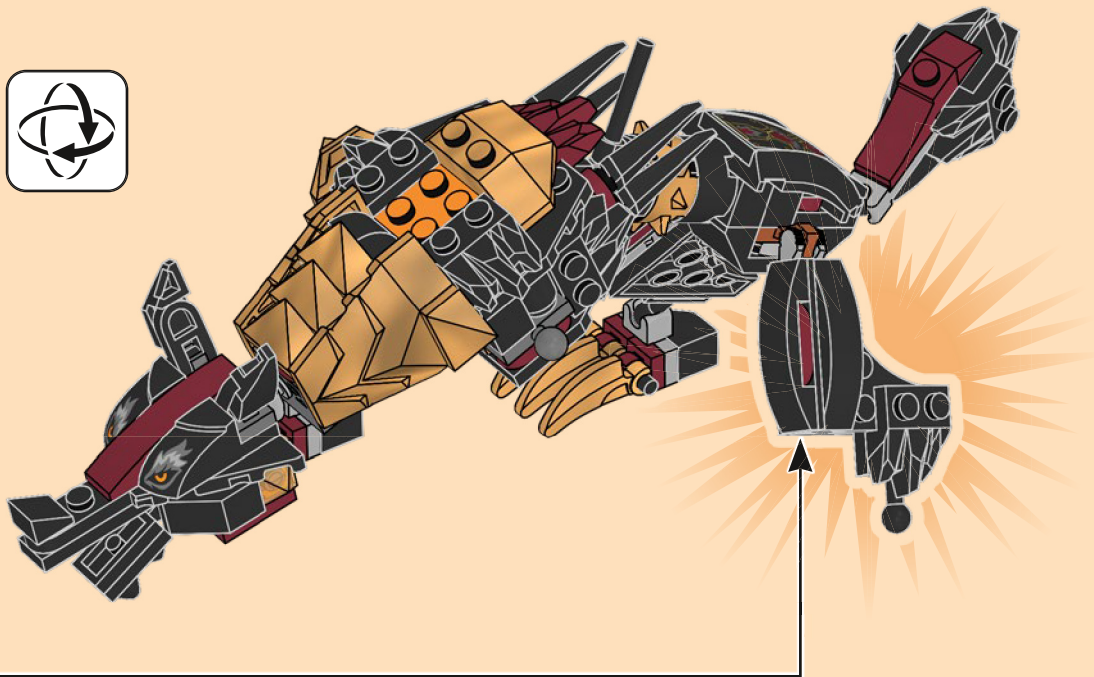

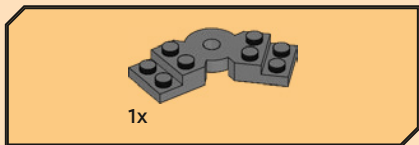

76

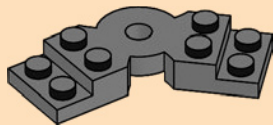

77

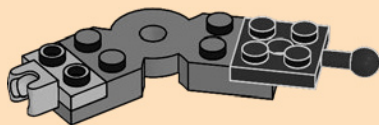

78

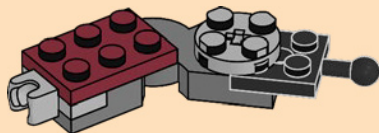

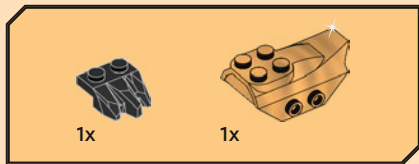

79

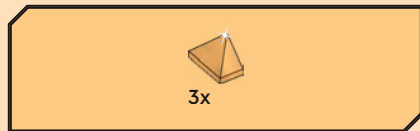
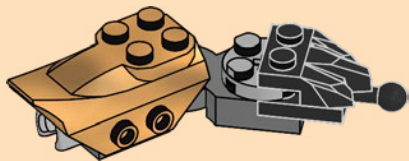

80

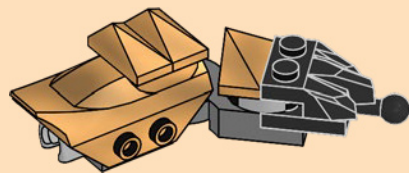

81

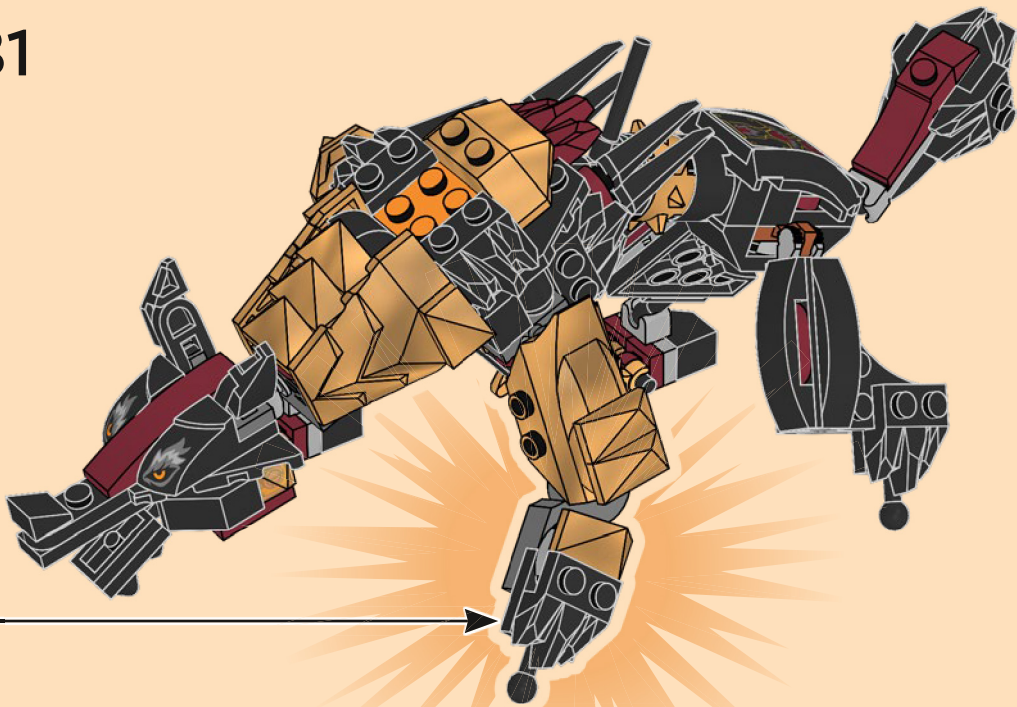

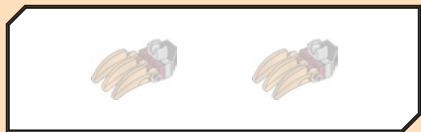

82



83

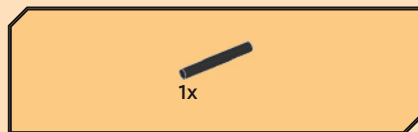

84



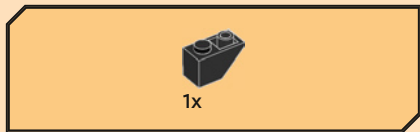

85

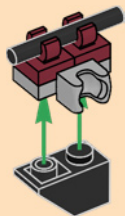

86

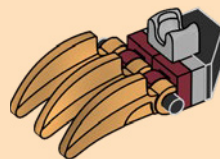

2x



87

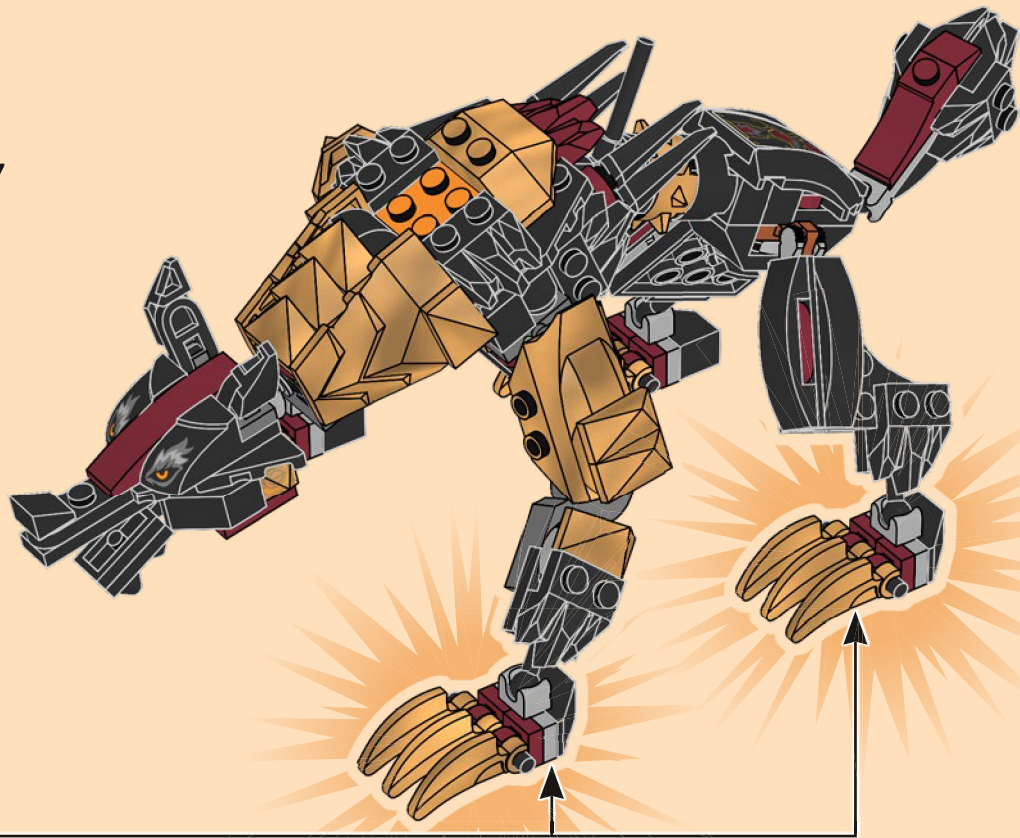

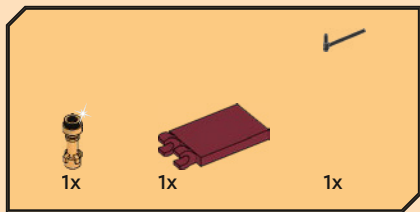

88

1

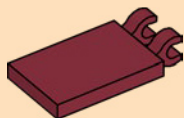

2



3

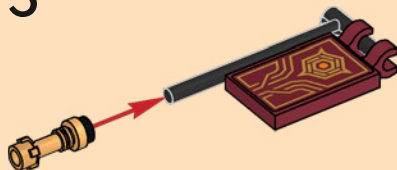

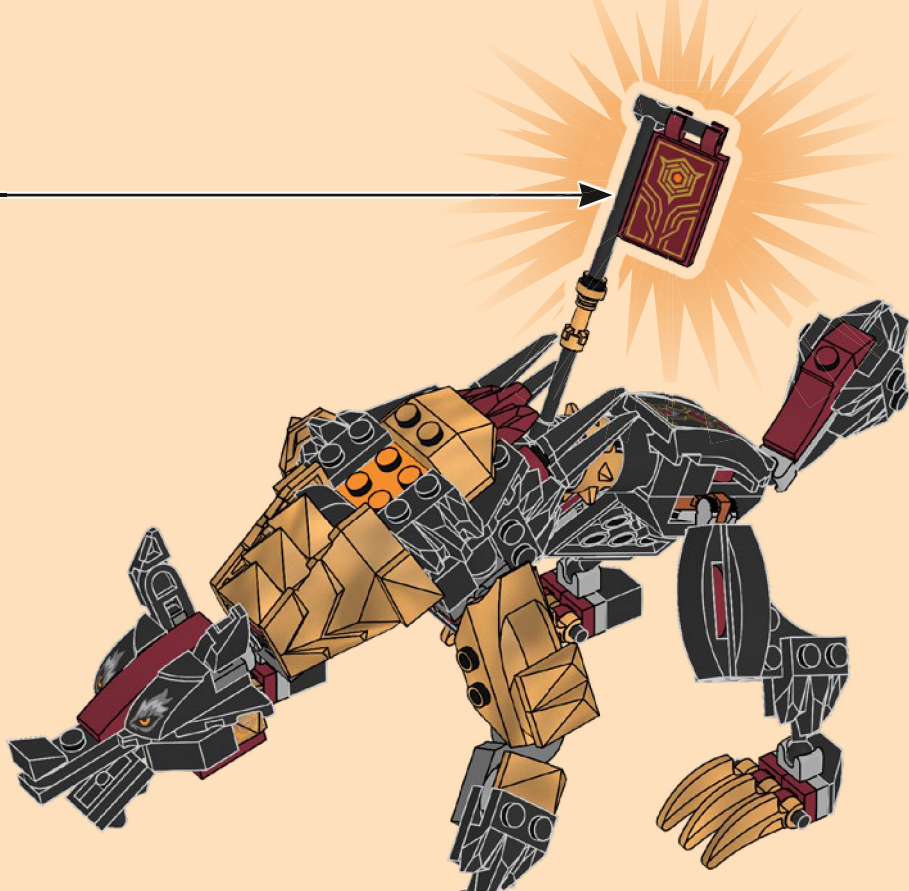





**LEGO**

# NINJAGO

**DRAGONS RISING**





2x  
6218823



2x  
6271228



1x  
6211975



1x  
6434435



1x  
6434447



1x  
6437693



1x  
6437692



1x  
6437698



1x  
6434449



4

1x  
6129995



2x  
306226



1x  
4504382



1x  
6181720



1x  
6280097



2x  
6157554



1x  
6181713



2x  
6267487



1x  
6127506



2x  
6178922



1x  
6143850



1x  
614326



2x  
6184784



4x  
366526



1x  
6336989



12x  
6195185



1x  
4623113



1x  
6295295



1x  
6295293



1x  
6295293



5x  
6093525



4x  
6270085



1x  
6262897



5x  
6448318



1x  
6437169



1x  
6437582



1x  
6437582



1x  
6437168



2x  
6168620



1x  
6428167



4x  
4613153



1x  
6039869



1x  
6434495



1x  
4647286



1x  
4188534



1x  
4525236



1x  
366626



1x  
389426



2x  
6345166



2x  
6345166



4x  
6208787

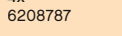

2x  
4129572

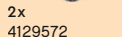

1x  
6437162



1x  
6437164



1x  
6438252



1x  
6434437

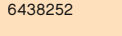

2x  
6398380



2x  
6345166

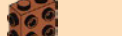

2x  
6345166

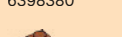

2x  
6345166

8x  
6360079

1x  
4531415

13x  
6212040

2x  
6252545

1x  
6329652

1x  
6337786

3x  
6264030

1x  
6042953

1x  
6374443

1x  
6250172

2x  
4159007

2x  
4158355

2x  
6250584

1x  
6430281

1x  
6443149

5x  
4211475

1x  
4657459

6x  
6043656

2x  
6043639

2x  
6267048

1x  
4211805

2x  
6383946

2x  
6039479

1x  
6365692

1x  
6454959

2x  
6395097

1x  
6003147

1x  
6434472

1x  
6434474

11x  
6075079

12x  
6293489

4x  
6116596

1x  
6170470

1x  
6327879

1x  
6357783

2x  
6376233

2x  
6371694

 [LEGO.com/service](https://www.LEGO.com/service)



YOU COULD  
**WIN**



Scan this QR code or go to  
**LEGO.COM/PRODUCTFEEDBACK** and give us  
your short feedback about this LEGO® set for  
a chance to win a cool LEGO prize.

Terms and Conditions apply\*



**EN: YOU COULD WIN.** Terms and Conditions apply\* **DE: Du könntest GEWINNEN.** Es gelten die Teilnahmebedingungen\* **FR: Tu pourrais GAGNER.** Des conditions s'appliquent\* **IT: Potresti VINCERE tu.** Termini e condizioni sono applicabili\* **ES: Puedes GANAR.** Aplican términos y condiciones\* **PT: Poderá GANHAR.** Aplicam-se termos e condições\* **ZH: 轻松获奖. 条款和条件适用\*** **PL: Szansa na WYGRANĄ.** Obowiązują warunki korzystania\* **CS: Máte šanci VYHRÁT.** Platí všeobecné smluvní podmínky\* **SK: Máte šancu VYHRAŤ.** Platia všeobecné zmluvné podmienky\* **HU: TE IS NYERHETSZ.** Felhasználási feltételek érvényesek\* **RO: Ai putea CÂȘTIGA.** Se aplică termenii și condiții\* **BG: Можете да СПЕЧЕЛИТЕ.** Има определени правила и условия\* **LV: Tu vari LAIMĒT.** Ir spēkā noteikumi un nosacījumi.\* **ET: Sul on võimalus VÕITA.** Kehtivad tingimused\* **LT: Jūs galite LAIMĖTI.** Taikomos sąlygos\*

\*[LEGO.com/productfeedback-terms](https://www.lego.com/productfeedback-terms)

LEGO, the LEGO logo, NINJAGO and the NINJAGO logo are trademarks of the/son des marques de commerce du/son marcas registradas de LEGO Group. ©2023 The LEGO Group.

6478142