



HEROFACTORY



7156

CORRODER



HEROFACTORY



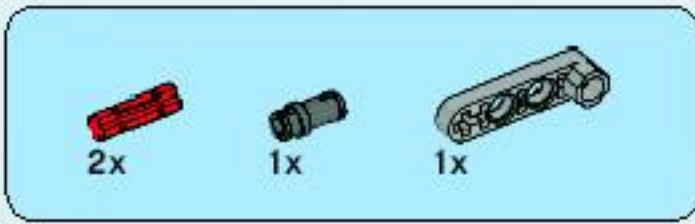

1

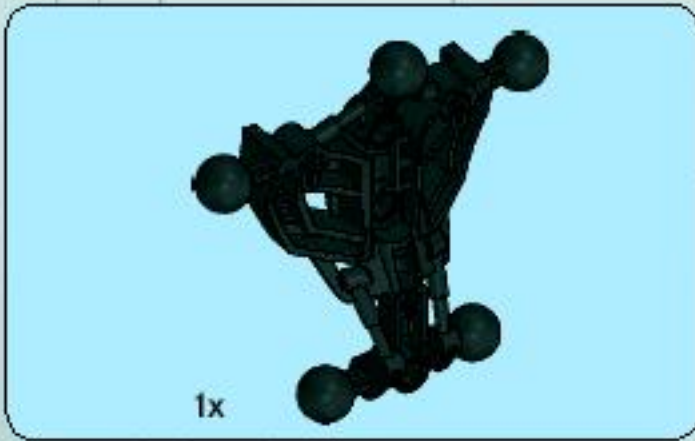
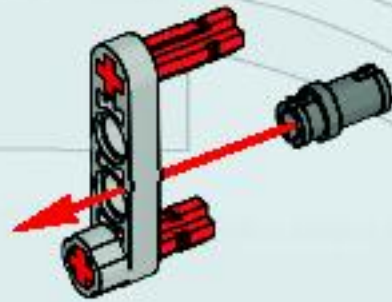

2

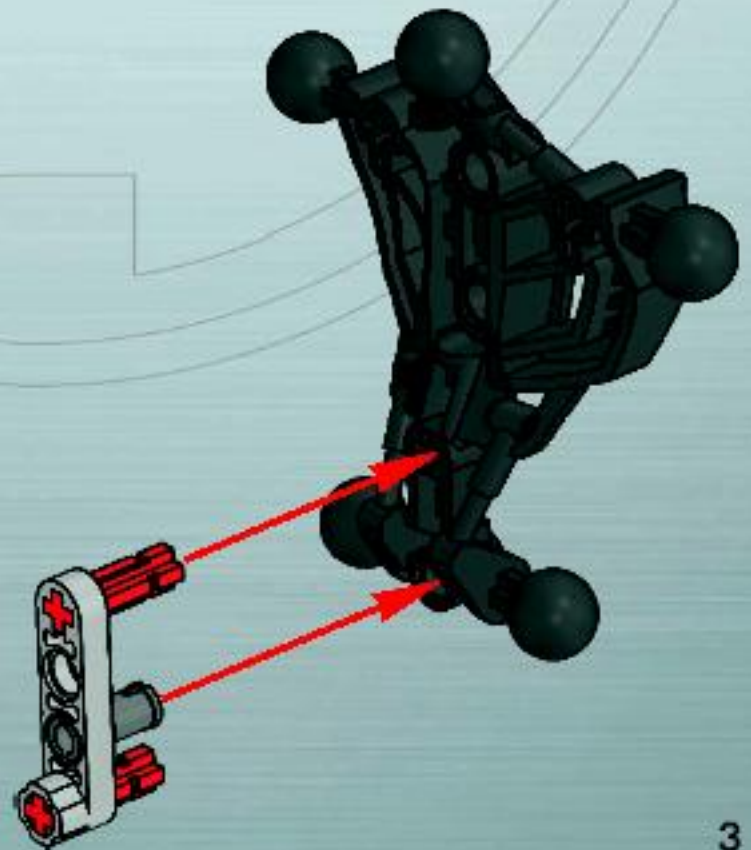

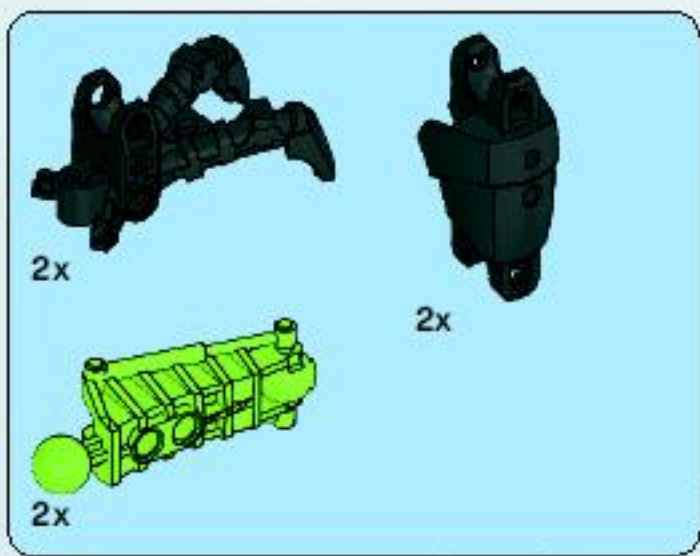

3

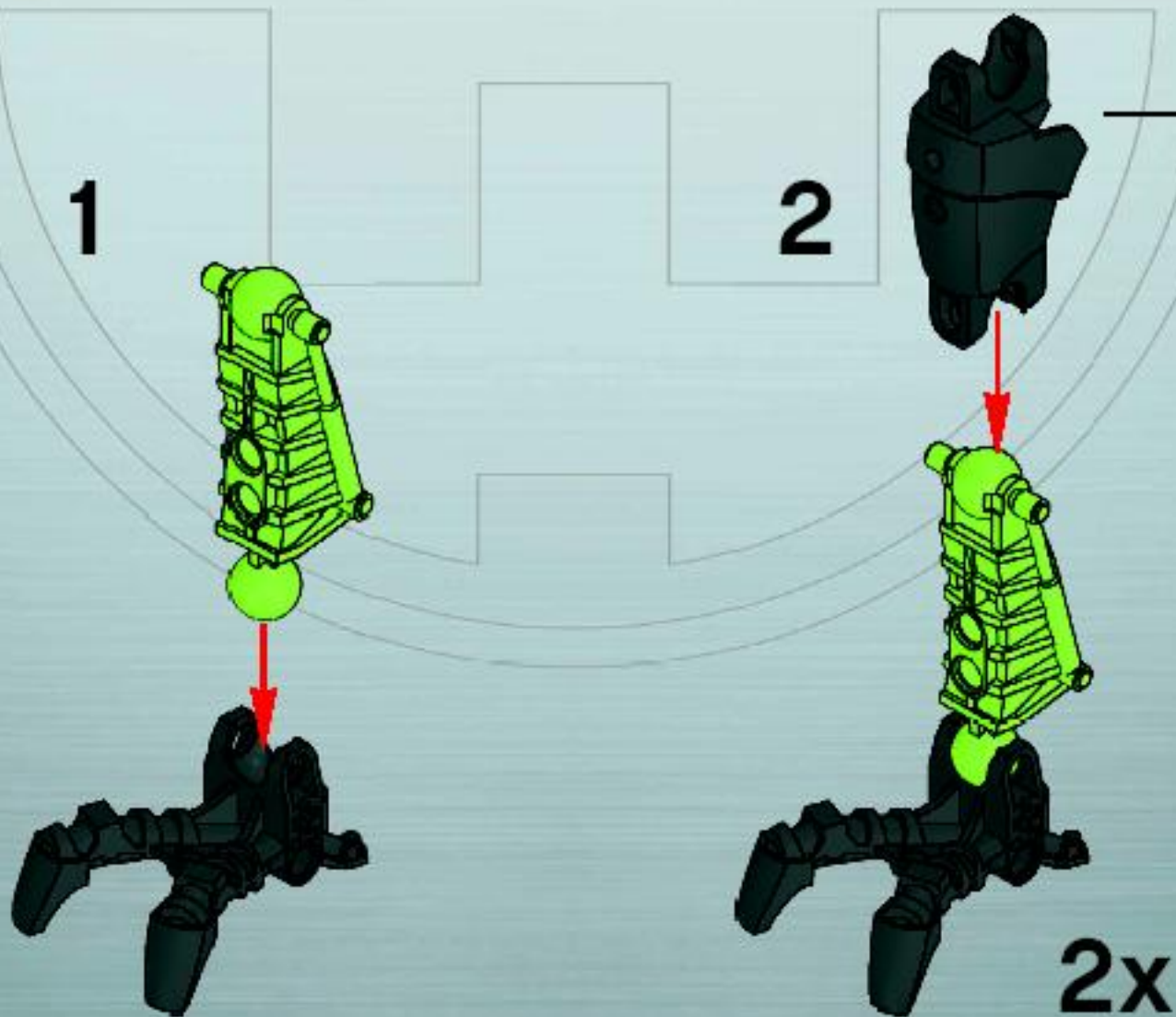



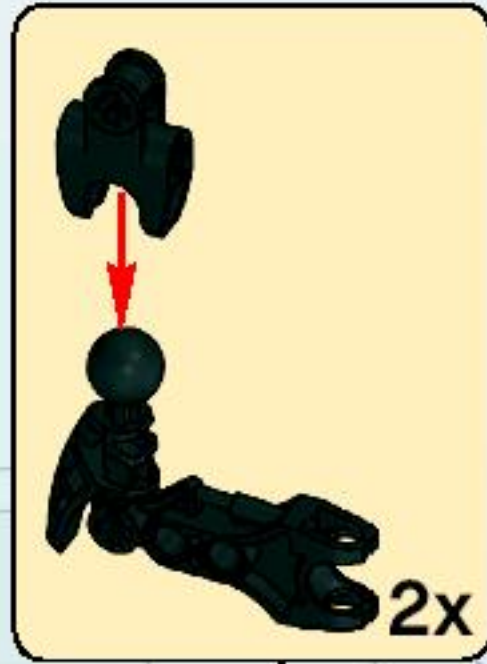
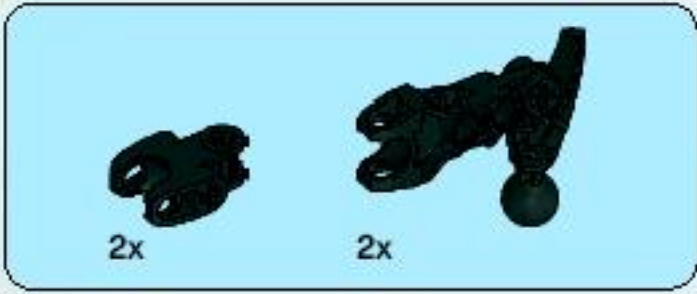

4

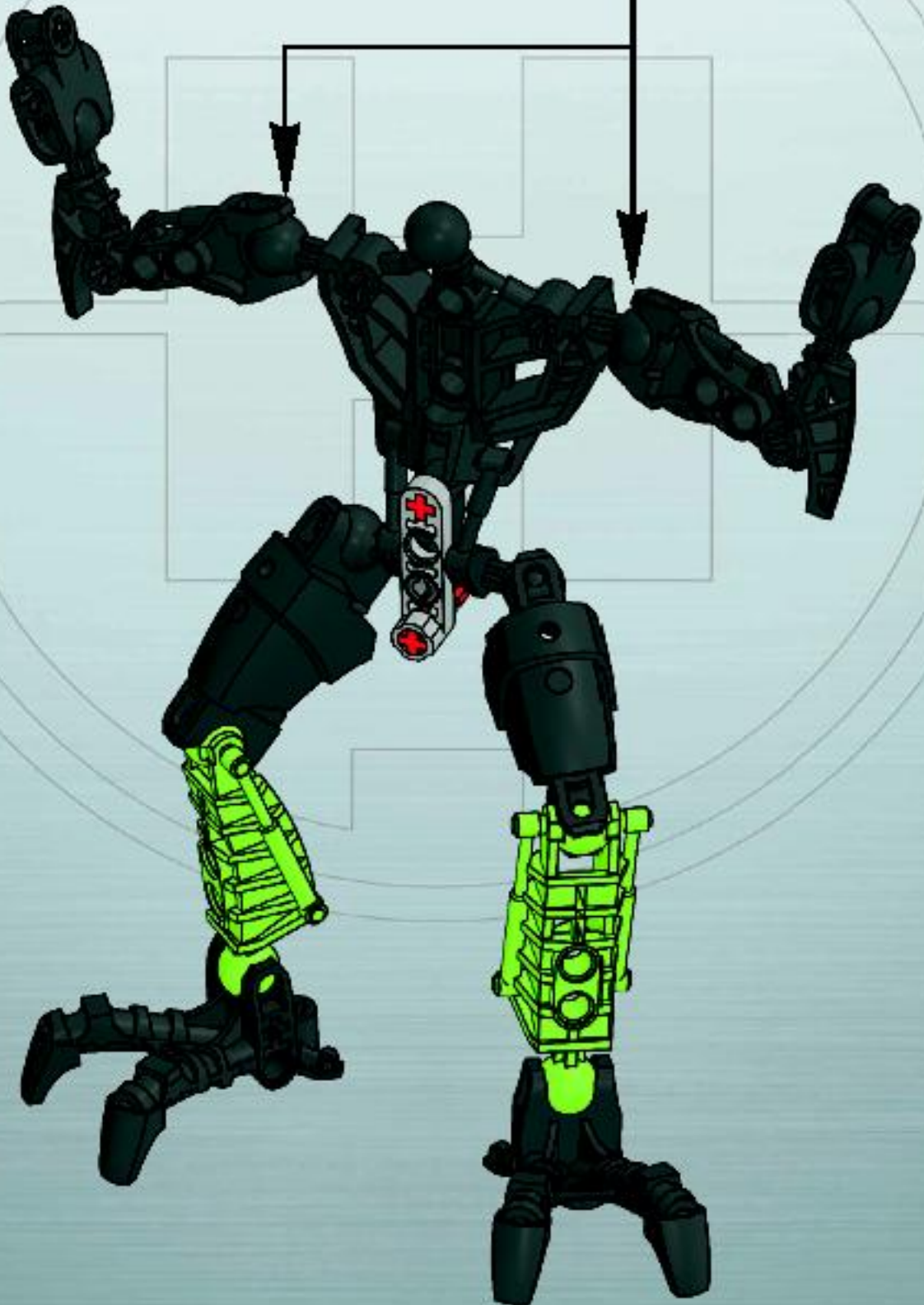

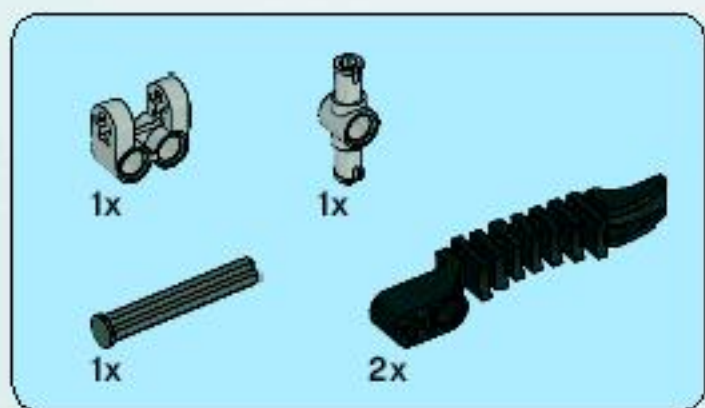

5

1

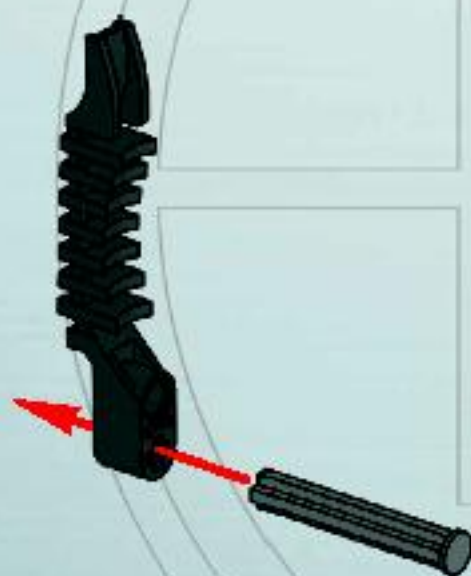

2

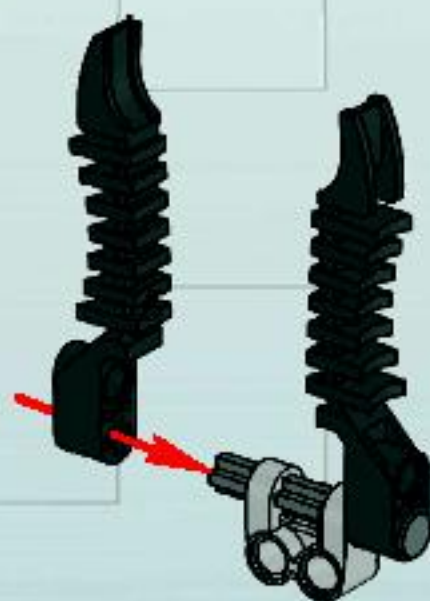

3



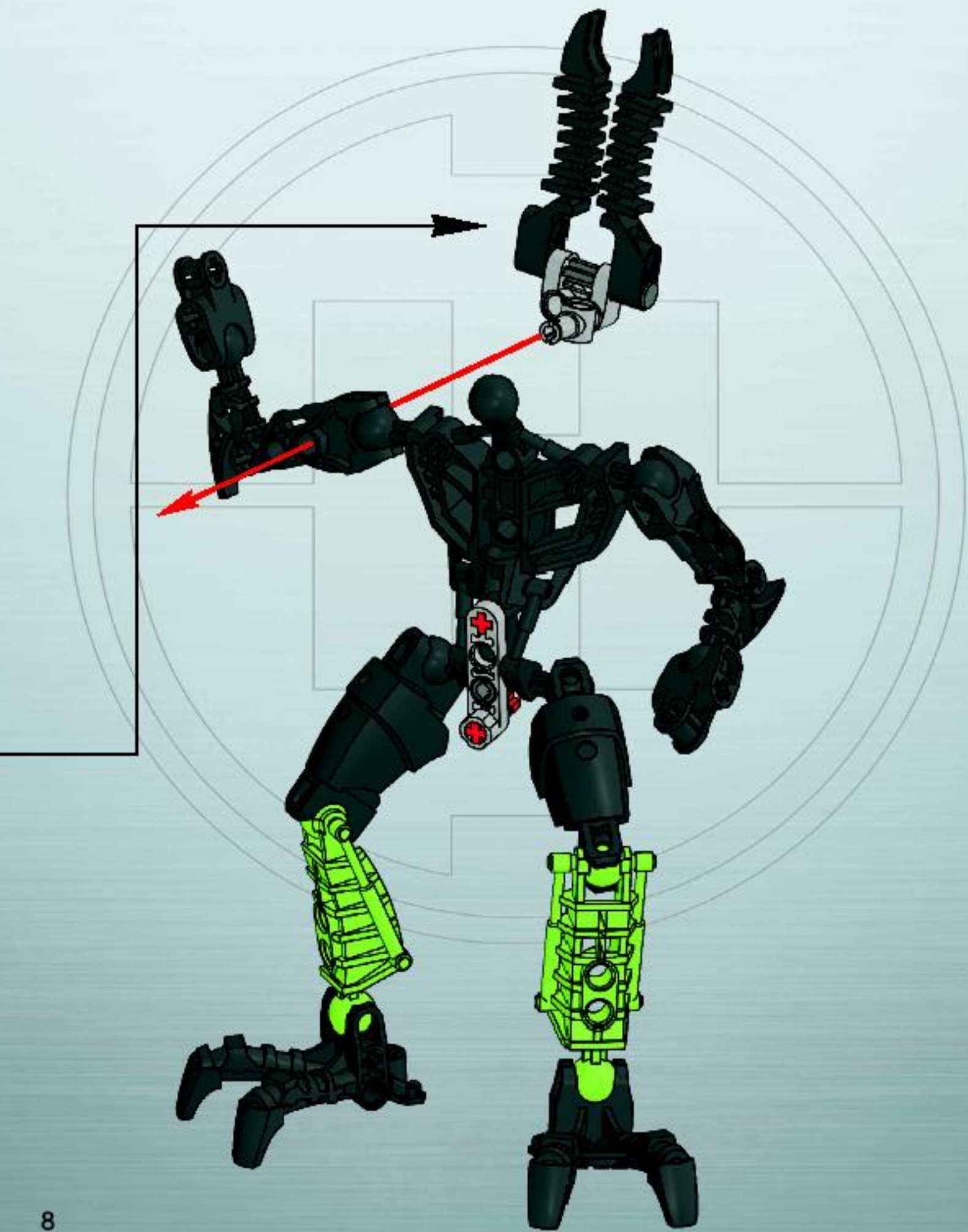



1x

6

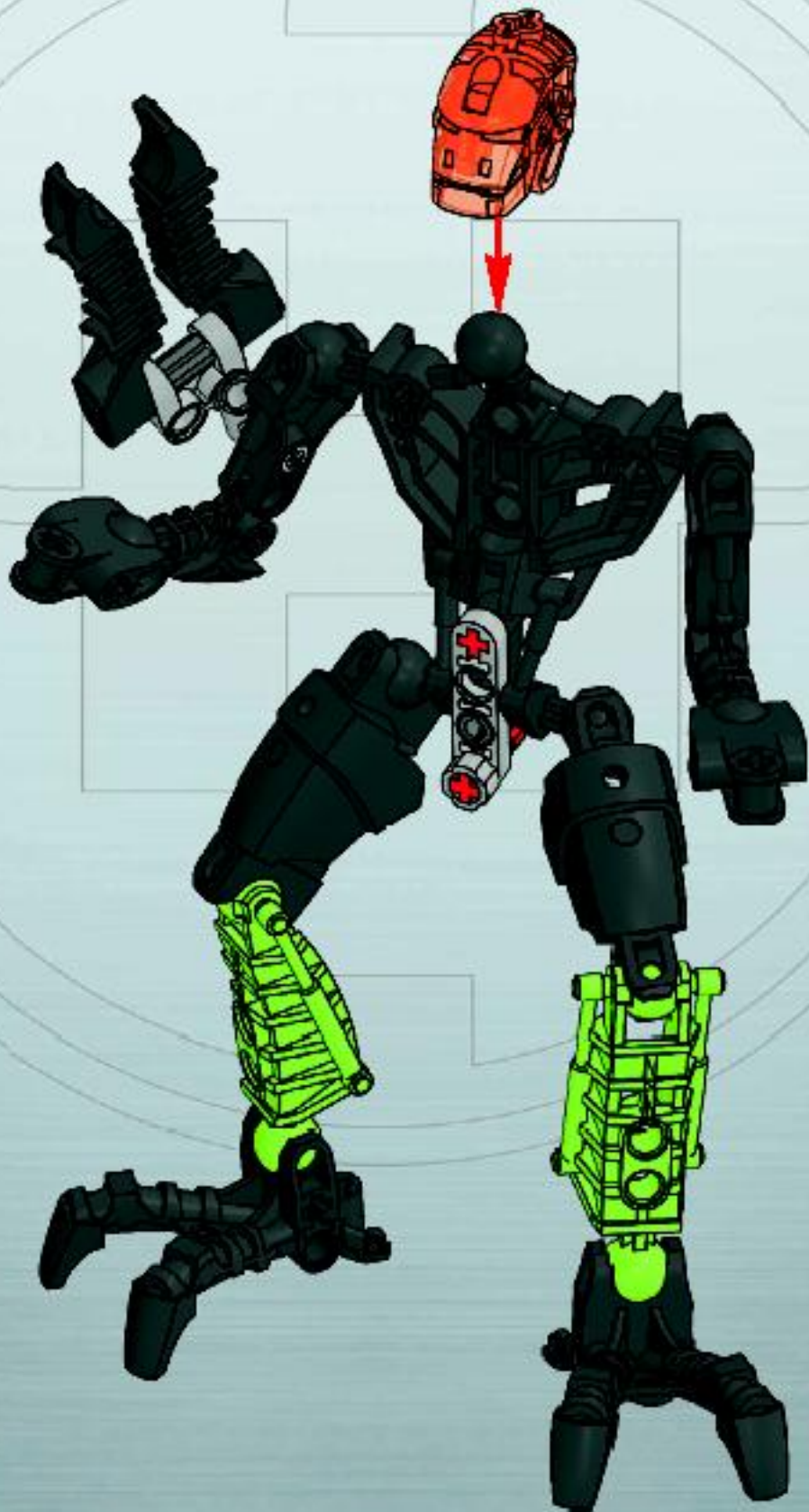

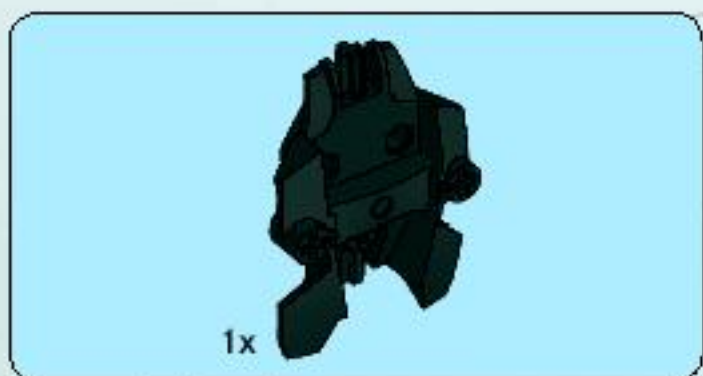

1

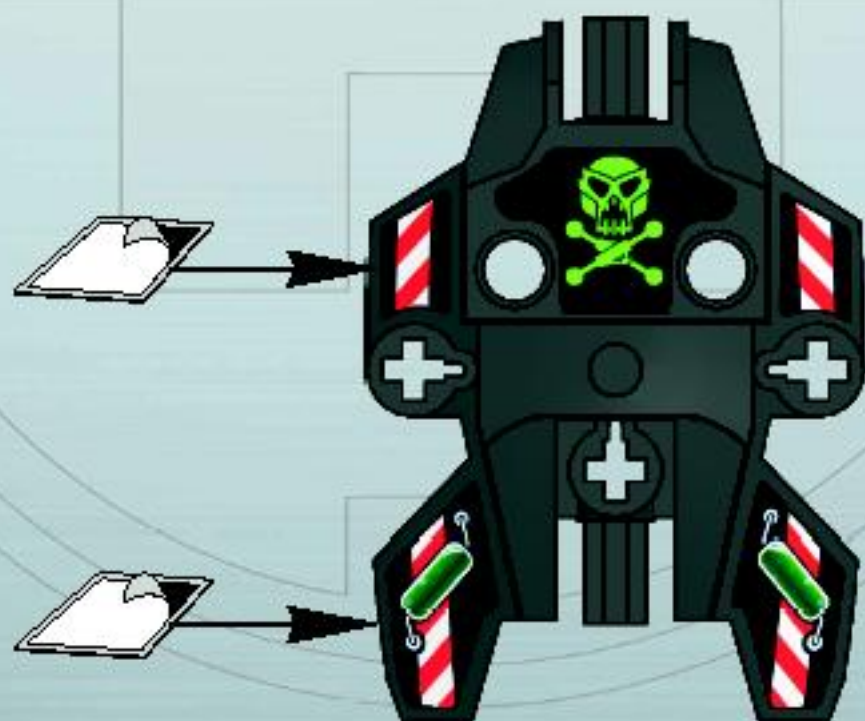



2

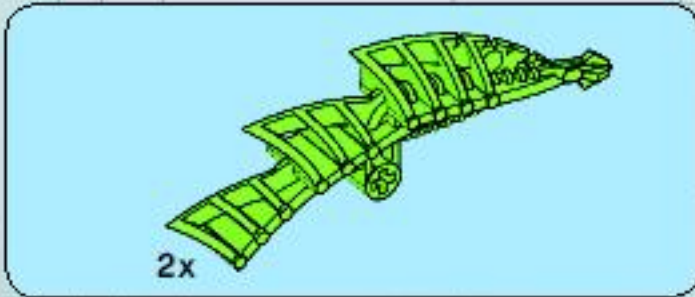

3

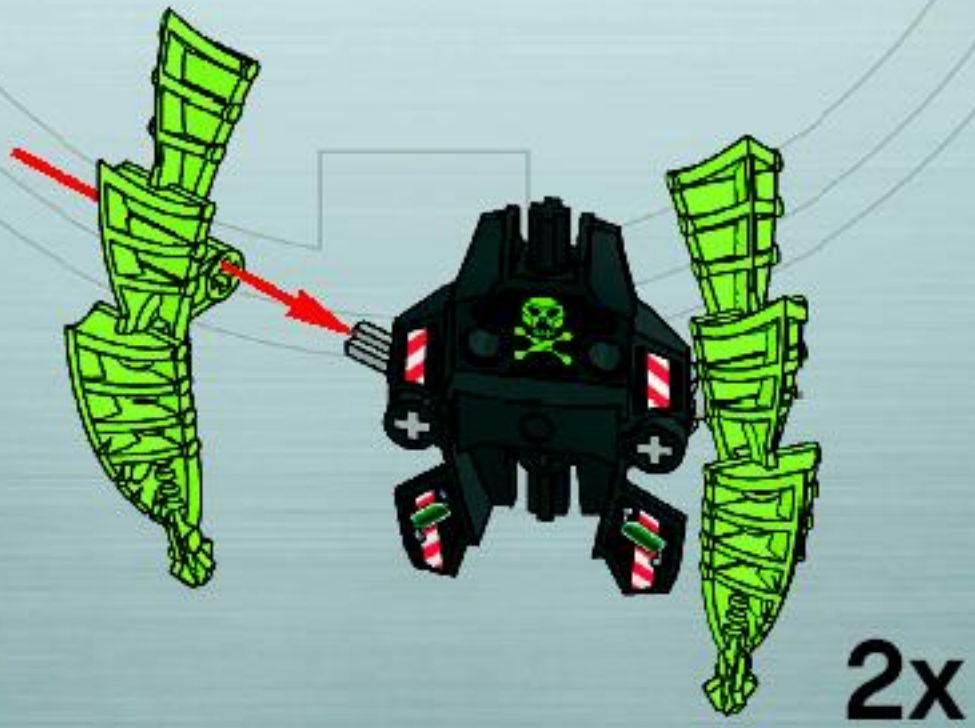

7



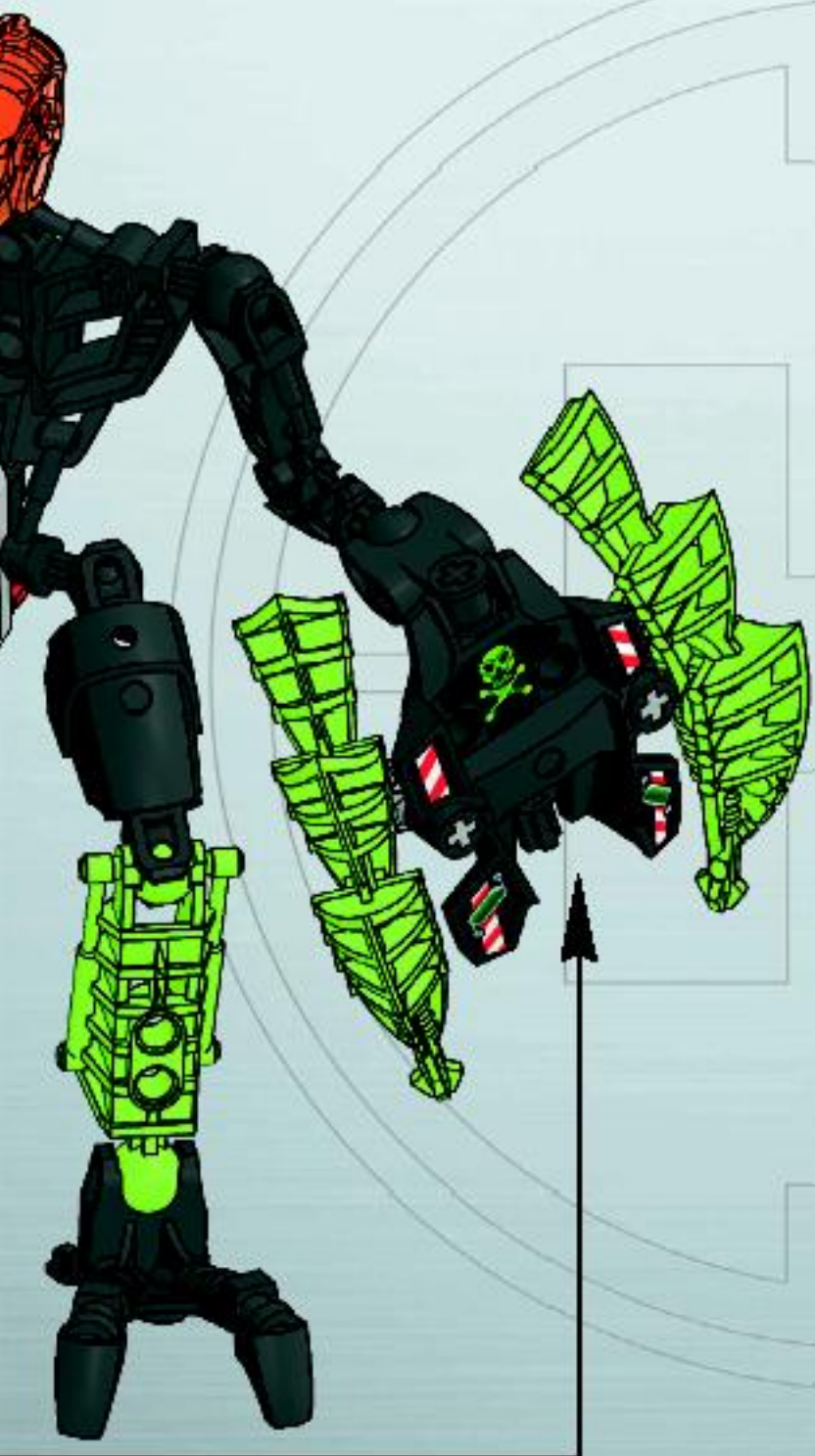



1x

8

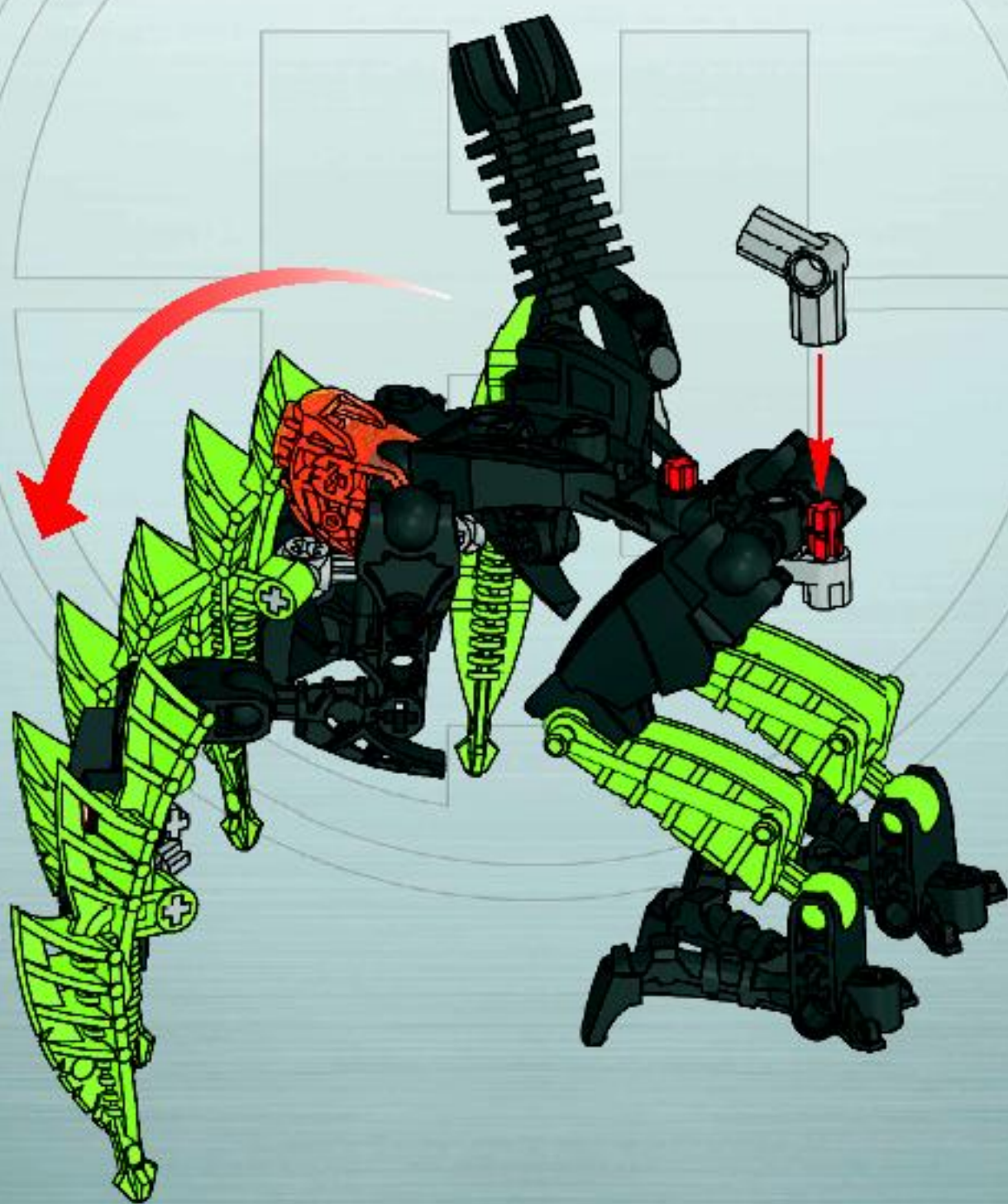

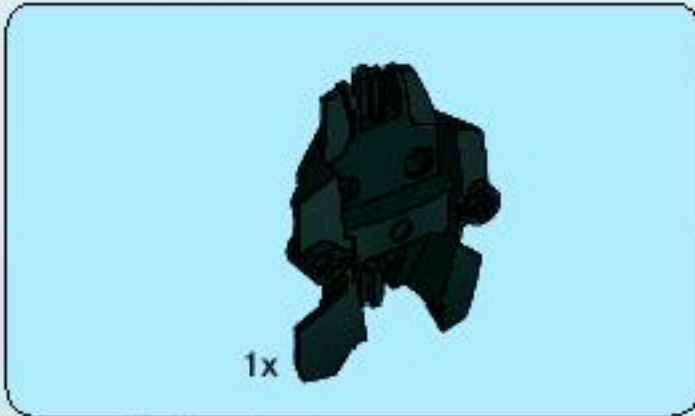
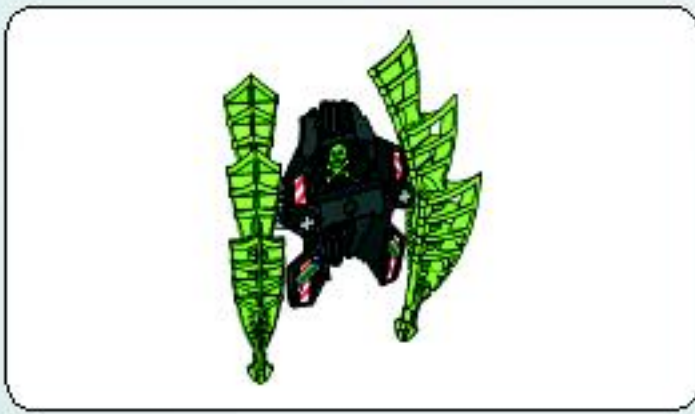

1

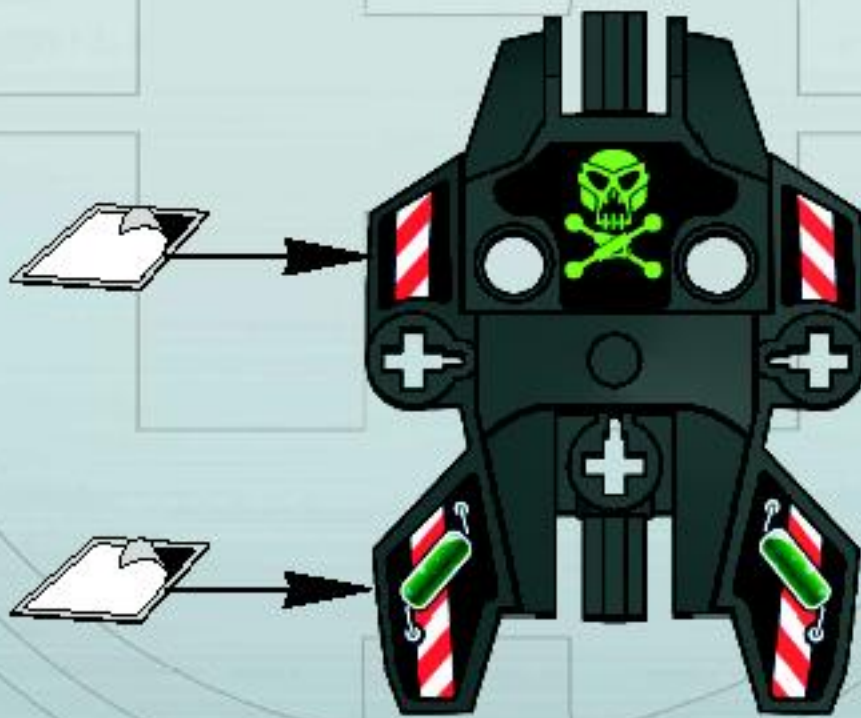



2

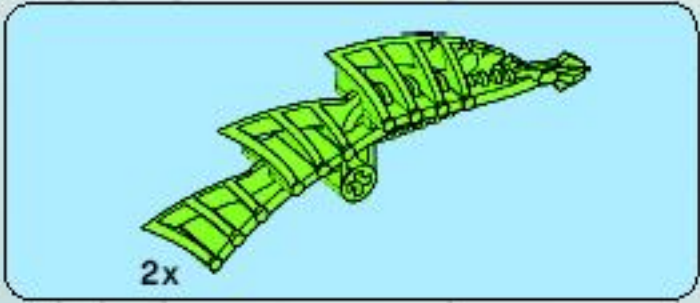
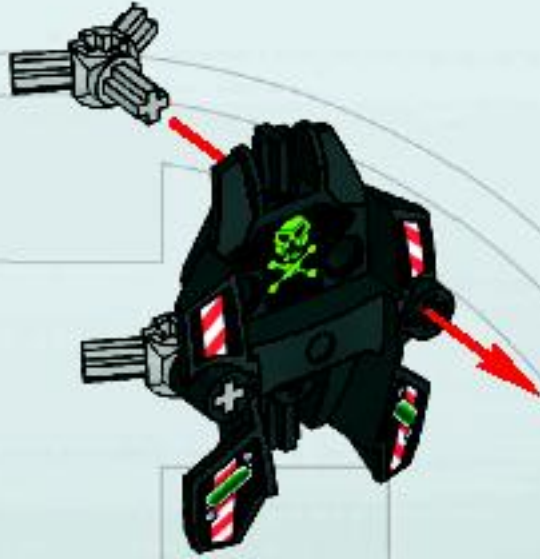

3

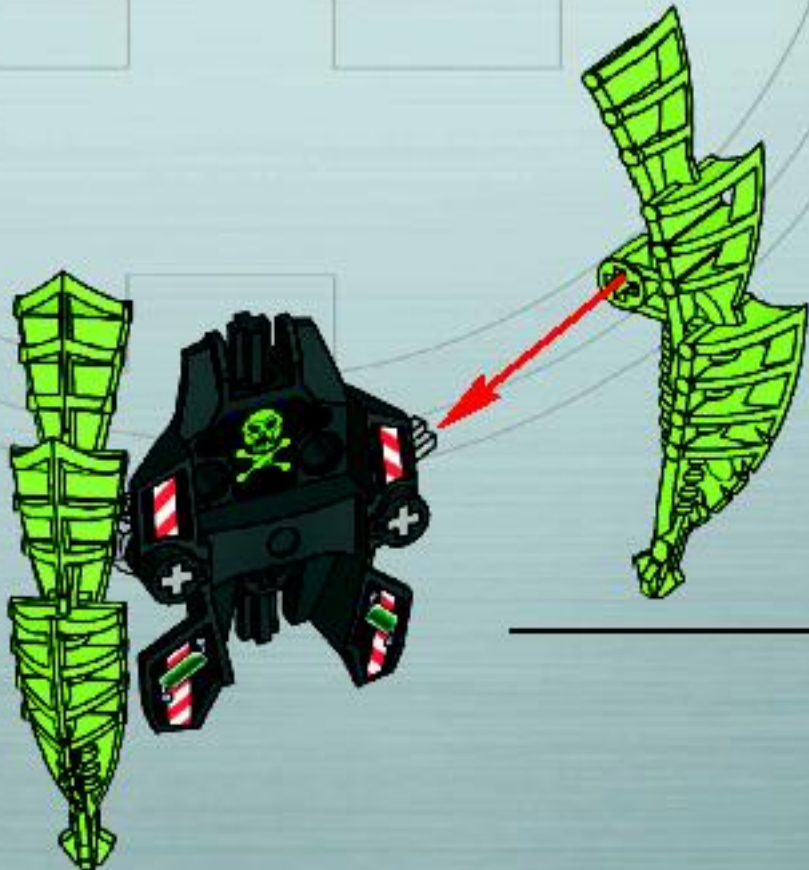

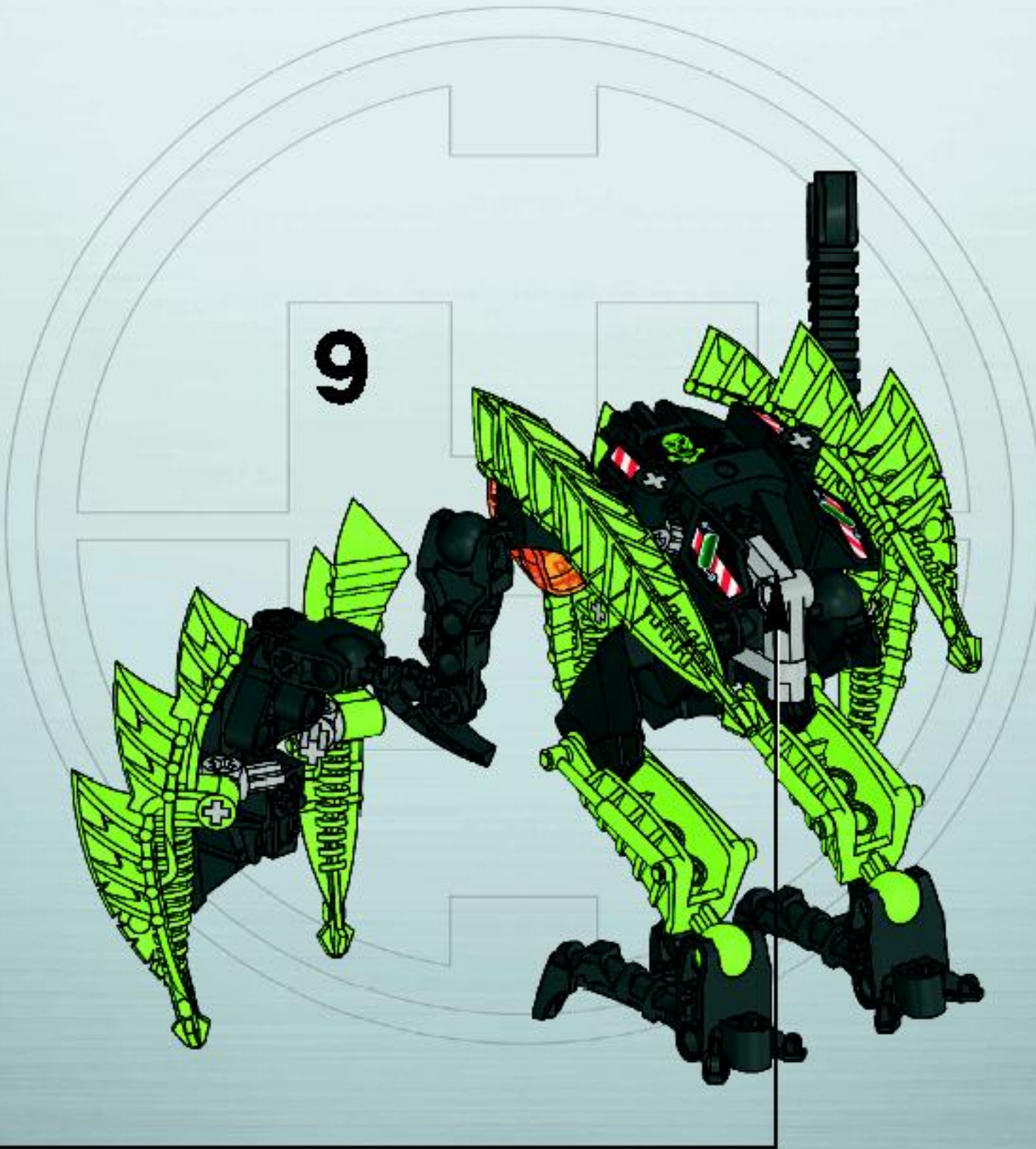

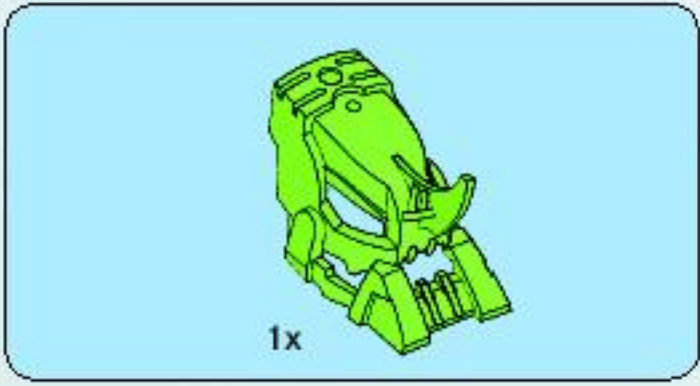

10



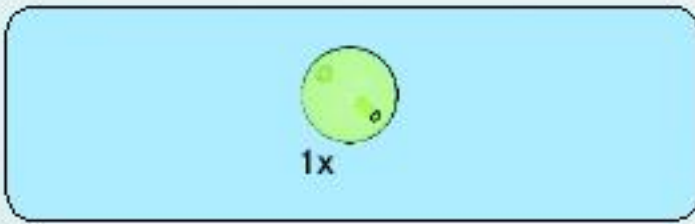

11

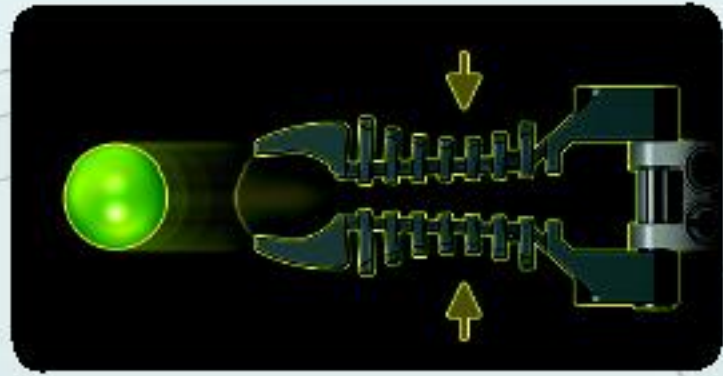



1x
4540702



2x
4581740



2x
4566781



6x
4502595



2x
4548164



2x
4526578



1x
4211551



1x
4579141



2x
4598442



1x
4578958

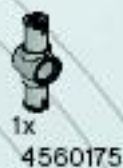

1x
4560175



2x
4142865



1x
4211889



2x
4516407



1x
4211050



1x
4211561

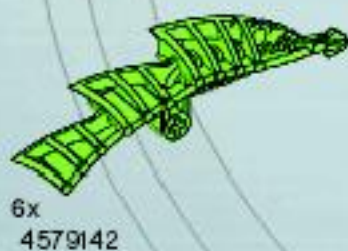

6x
4579142



3x
4581828



1x
4560177



1x
4583979



Customer Service

Kundenservice

Service Consommateurs

Servicio Al Consumidor

www.lego.com/service or dial



00800 5346 5555 :

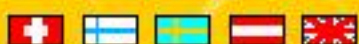

1-800-422-5346 :



7169



7157



7165



HEROFACTORY

we build heroes™

FREE! GRATIS! GRATUIT!



club
MAGAZINE™

www.LEGOclub.com



00800 5346 5555*



1-866-534-6258 • 1-877-518-5346

US & Canada only

Canada seulement

* FreePhone. Mobile charges may apply. * Numéros sans frais. Les frais peuvent s'appliquer avec les téléphones cellulaires.
* Gebührenfrei. In den Pflichtnetzen Mobilfunknetze können abwickeln. * Gratis Telefonnummern und Fixstarke Lijn.
* Nummer gratis nummer, når du ringer Pro Postbetjener. * Debtor gratis, når du ringer Pro Postbetjener.



VISIT THE WORLD'S
BIGGEST LEGO® SHOP!

www.LEGOshop.com



WIN!

Go to www.nielsen.com/LEGO to fill out a survey for a chance to win a cool LEGO® Product. No purchase necessary. Open to all residents where not prohibited.



www.nielsen.com/LEGO

GEWINNE!

Nimm an der Umfrage auf www.nielsen.com/ LEGO teil und hab die Chance ein cooles LEGO® Produkt zu gewinnen! Die Teilnahme am Gewinnspiel führt zu keinerlei Kaufverpflichtungen. Teilnahme in allen nicht ausgeschlossenen Ländern möglich.

WIN!

Ga naar www.nielsen.com/LEGO, vul een enquêteformulier in en maak kans op een cool LEGO® product. Geen aankoopverplichting. Iedereen mag deelnemen, uitgezonderd ingezetenden van landen waar een enquêteverbod geldt.

GAGNE!

Visite www.nielsen.com/LEGO pour répondre à un questionnaire et avoir une chance de gagner un produit LEGO® très cool! Aucune obligation d'achat. Ouvert à tous les résidents des pays autorisés.

当てよう!

www.nielsen.com/LEGO にアクセスして、アンケートにご記入ください。当選者にはレゴ製品を差し上げます。お買い上げの必要はありません。禁止されていない限り、すべての情報にご利用いただけます。