



**GEWINNE**

Ezítélj nekünk a [www.LEGO.com/productfeedback](http://www.LEGO.com/productfeedback) oldalunkon a tapasztalataidról, és megkapod a lehetőséget arra, hogy nyerj egy csodás LEGO® készletért. Résztvehetsz a nyeremény sorsolásban, és nyerhetsz egy csodás LEGO® ajándékot!

**GAGNE**

Rendezd el a [www.LEGO.com/productfeedback](http://www.LEGO.com/productfeedback) oldalunkon a tapasztalataidról, és megkapod a lehetőséget arra, hogy nyerj egy csodás LEGO® készletért. Résztvehetsz a nyeremény sorsolásban, és nyerhetsz egy csodás LEGO® ajándékot!

**GANNA**

Vaše mnenje o izdelku lahko sporočite na [www.LEGO.com/productfeedback](http://www.LEGO.com/productfeedback) in s tem dobite možnost, da dobite zanimivo nagrado. Sodelujete v tekmovanju za zanimivo nagrado LEGO®. Če boste dobili zanimivo nagrado, boste prejeli zanimivo nagrado LEGO®.

**获取奖品**

请登录 [www.LEGO.com/productfeedback](http://www.LEGO.com/productfeedback) 网站，告诉我们关于此乐高®套装的简短反馈，就有机会获得炫酷乐高奖品。

(条款及条件) 适用

**경품 당첨 기회**

[www.LEGO.com/productfeedback](http://www.LEGO.com/productfeedback) 페이지를 방문하여 이 레고® 세트에 대한 간단한 피드백을 남겨주시면 경품 당첨 기회를 얻을 수 있습니다.

약관 적용

**ЗАПОЛНИ АНКЕТУ И ПОЛУЧИ ПРИЗ**

Перейдите по ссылке [www.LEGO.com/productfeedback](http://www.LEGO.com/productfeedback) и ответьте на несколько вопросов об этом наборе LEGO®. И у вас появится шанс выиграть замечательный приз от компании LEGO.

Применяются условия и правила участия

1

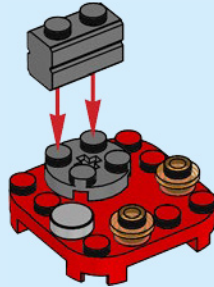

2

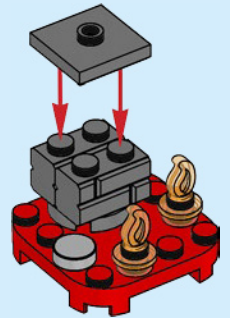

1



3

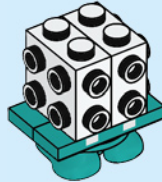

5

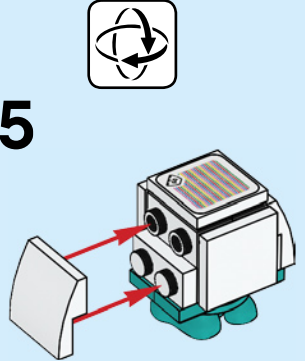

2

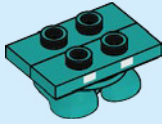

4

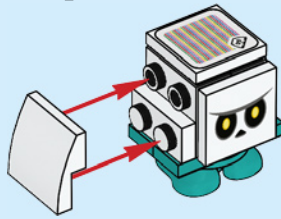

6

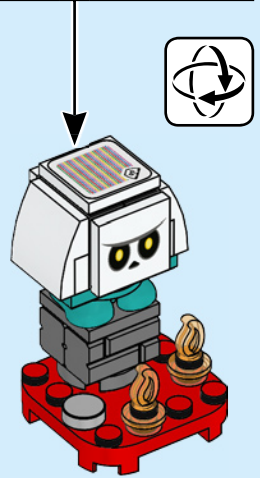

71386  
6356297



71360



Starter Course 71360 needed  
Niveau de départ 71360  
nécessaire  
Se necesita el set Recorrido  
Inicial (71360)



71386



# Get the latest version of the app! Téléchargez la dernière version de l'appli ! ¡Descarga la versión más reciente de la app!

Check for compatibility  
Vérifier la compatibilité  
Comprueba tu compatibilidad

[LEGO.com/devicecheck](https://www.lego.com/devicecheck)



LEGO® Super Mario™



Poison Mushroom  
Champignon poison  
Champiñón venenoso



Bone Goomba  
Goomb'os  
Goombuesitos



Ninji



Thwimp  
Ka-Bing  
Chillón Píston



Huckit Crab  
Crabincheux  
Rocangrejo



Fly Guy  
Maskache Hélico  
Helicoguy



Para-Beetle  
Parabindule  
Parabuzzy



Parachute Goomba  
Goomba parachute  
Goomba Paracaidista



Foo  
Nébulouf  
Nublina



Spiny Cheep Cheep  
Aquazo épineux  
Cheep Espinoso

LEGO.com/service  
LEGO, the LEGO logo and the Brick and Knob configurations are trademarks of  
the/son des marques de commerce du/son marcas registradas de LEGO Group.  
©2021 The LEGO Group. All rights reserved/tous droits réservés/Todos los  
derechos reservados.

TM & © 2021 Nintendo.

6356297