

The LEGO logo is displayed in its characteristic white font with a black outline, set against a red rectangular background.

BIONICLE[®]

71313



 LEGO.com/bionicle



WARNING: CHOKING HAZARD.
Toy contains small parts and a small ball.
Not for children under 3 years.



AVERTISSEMENT :

RISQUE D'ÉTOUFFEMENT. Le jouet contient des petites pièces ainsi qu'une petite boule. Il ne convient pas aux enfants de moins de 3 ans.



ADVERTENCIA:

PELIGRO DE ASFIXIA.

Juguete que contiene partes pequeñas y una pelota pequeña. No recomendado para niños menores de 3 años.

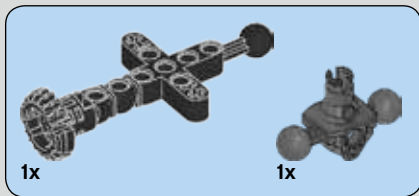

1

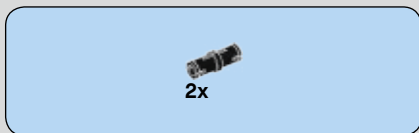
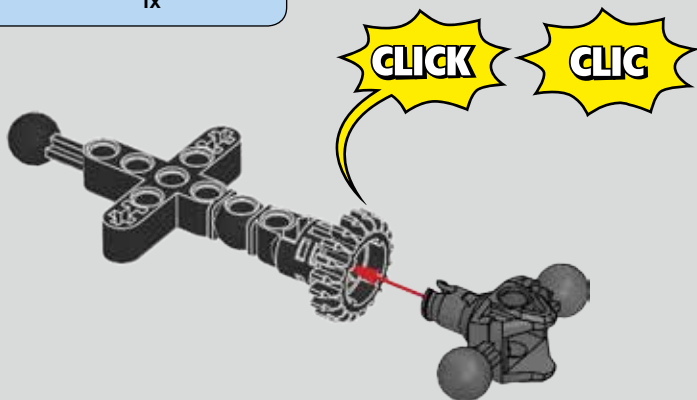

2

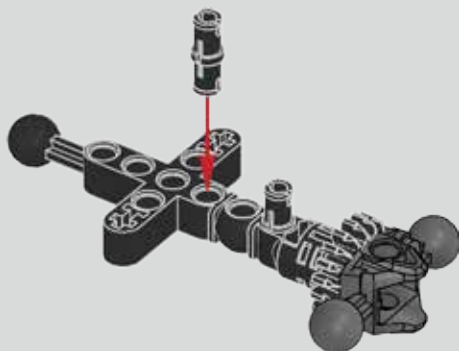

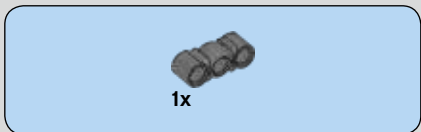

3

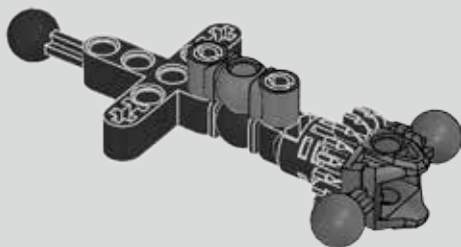

4

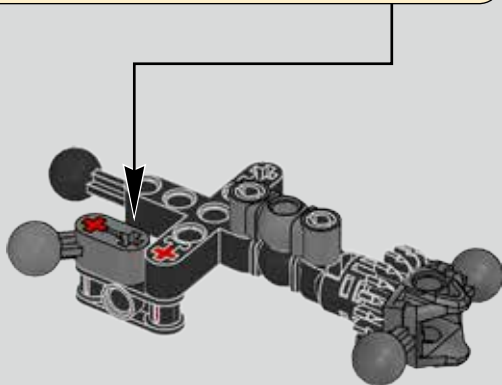



5

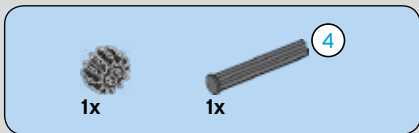
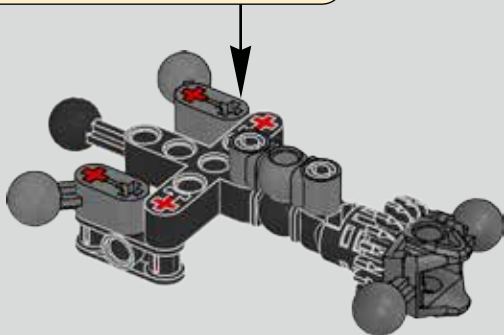
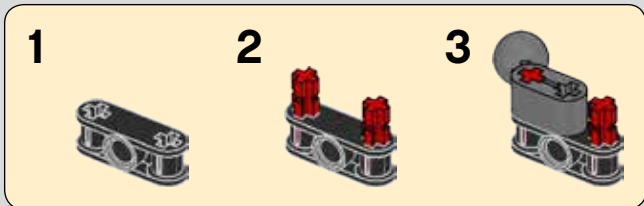

6

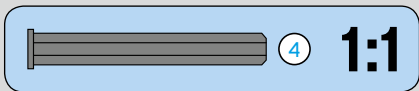
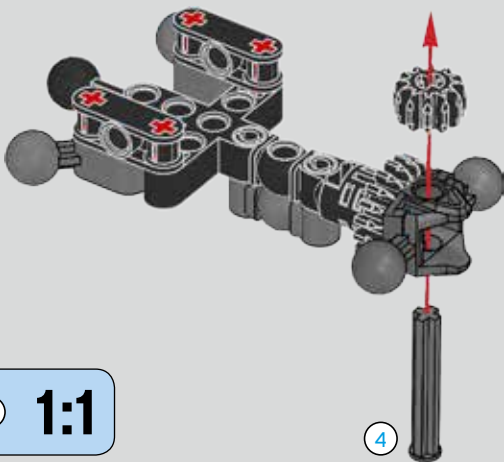
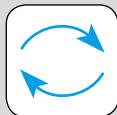



1x

7

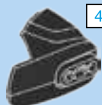
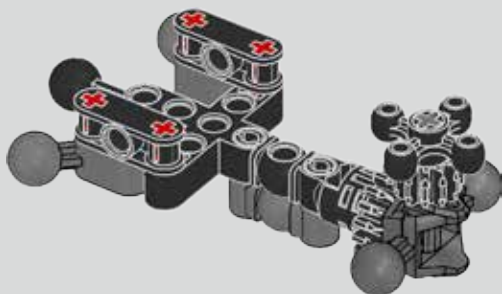

4

1x

8

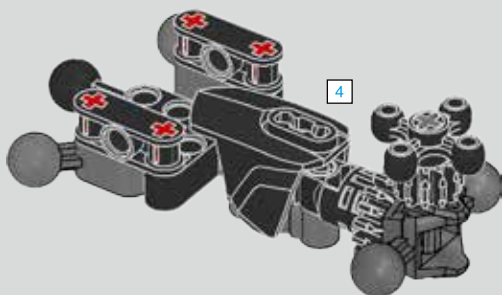

4

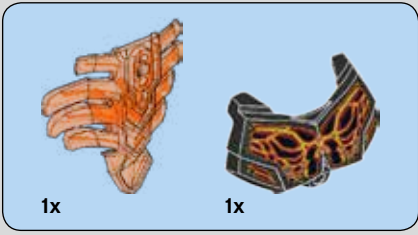

9

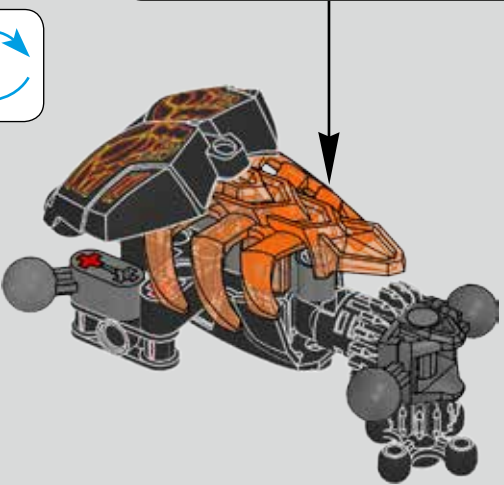



2x



1x



1x

10

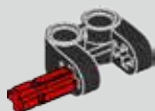

1x

11

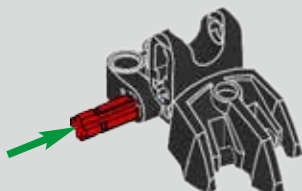



2x

12



1x

13

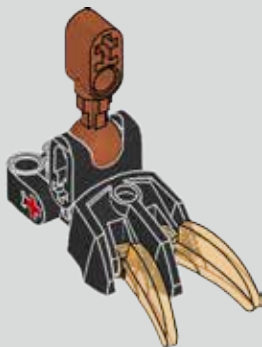



14

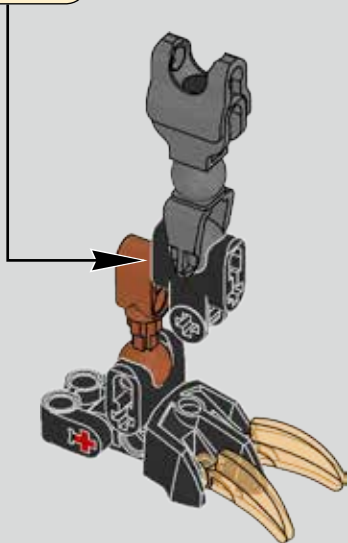
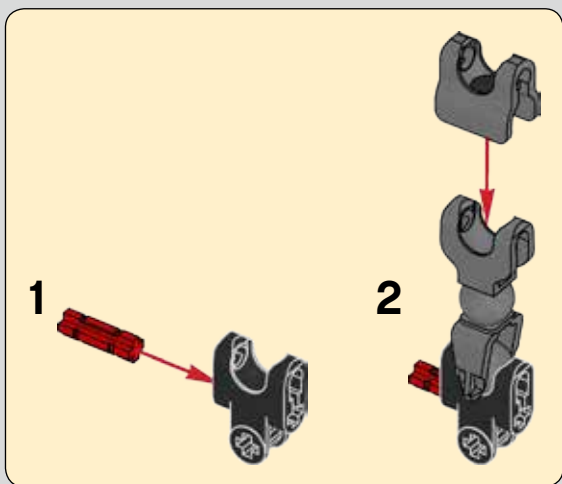



15

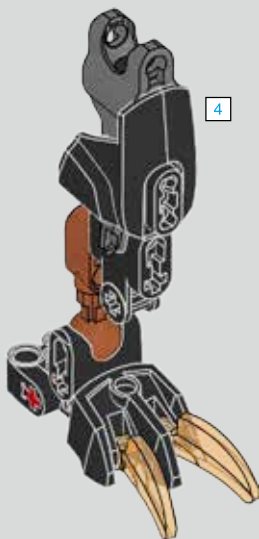

2x

16

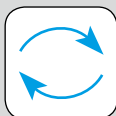



2x



1x



1x

17

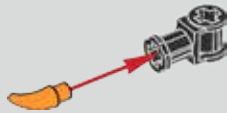

1x



1x

18





19

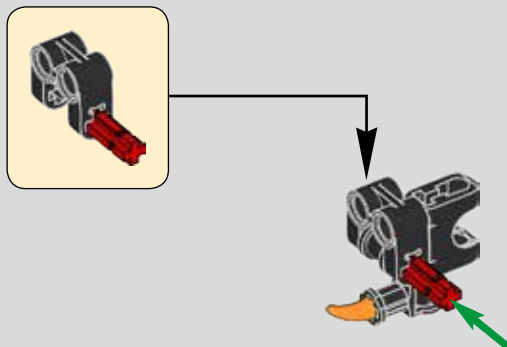

20

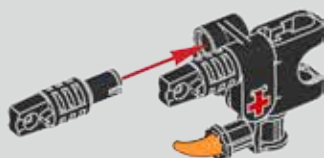



2x

21

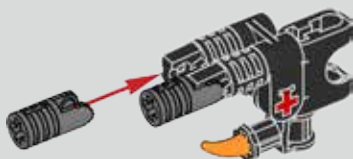

2x

1x

22

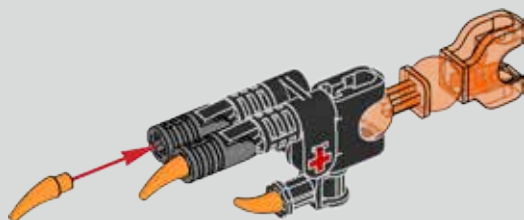

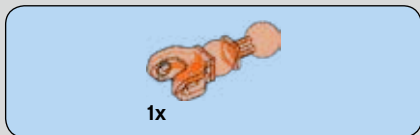

23

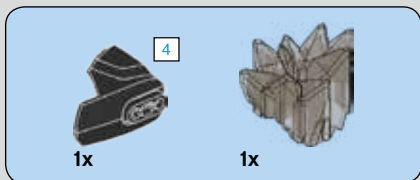
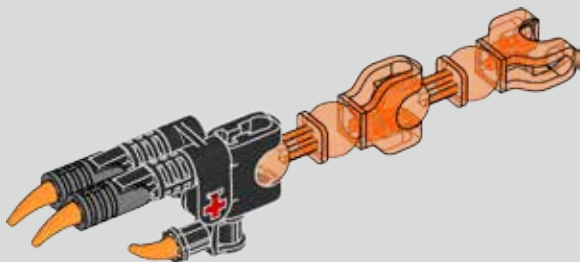

24

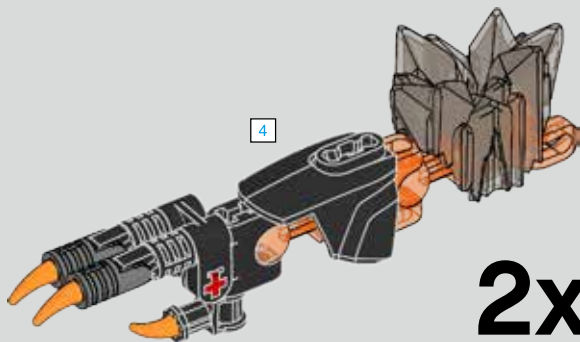

25

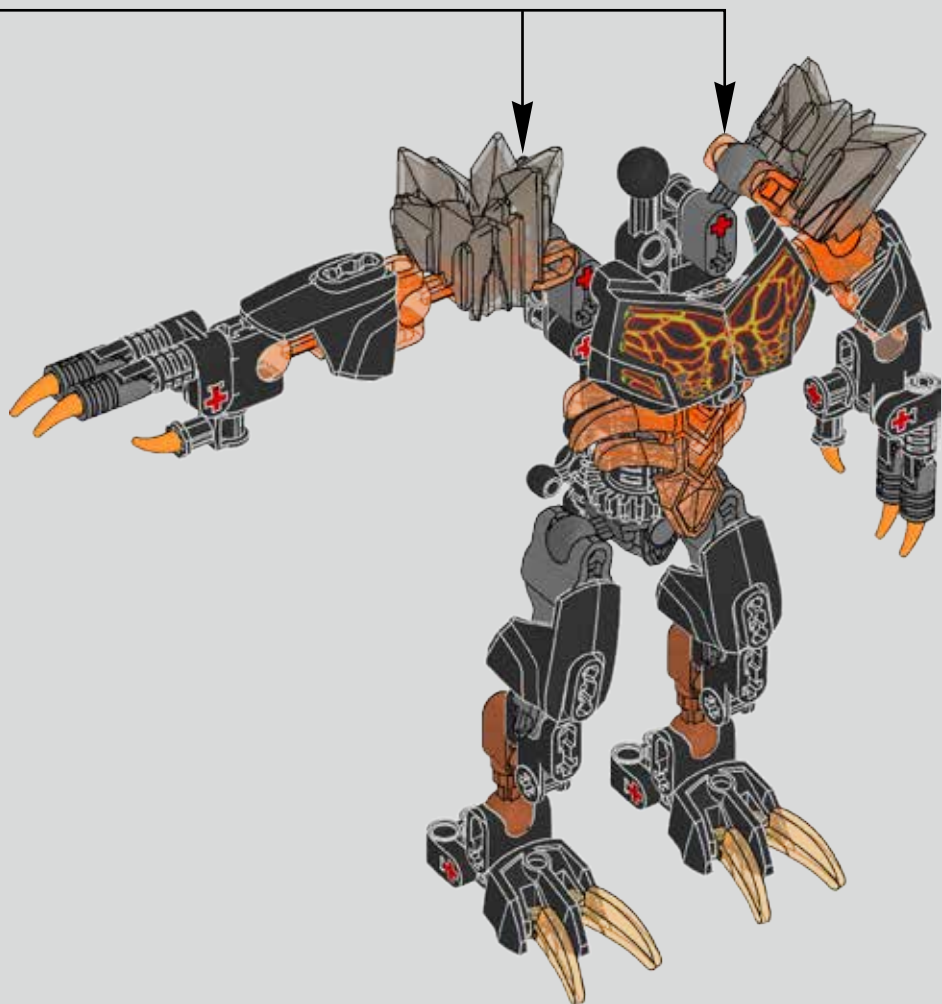

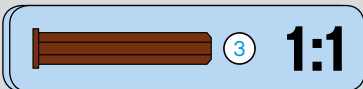
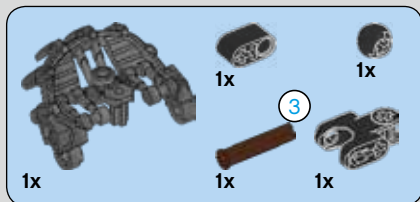

26

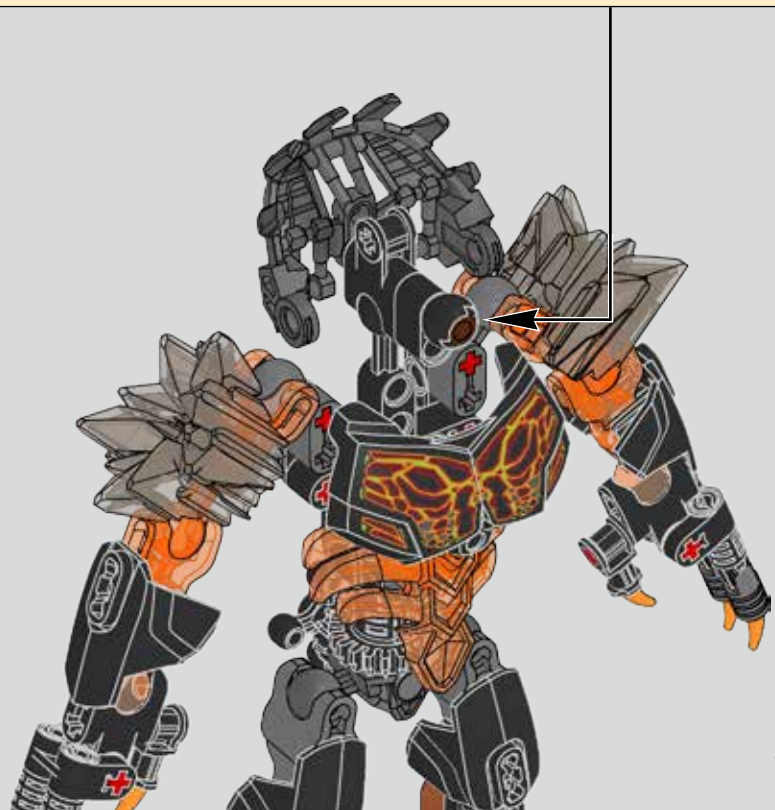
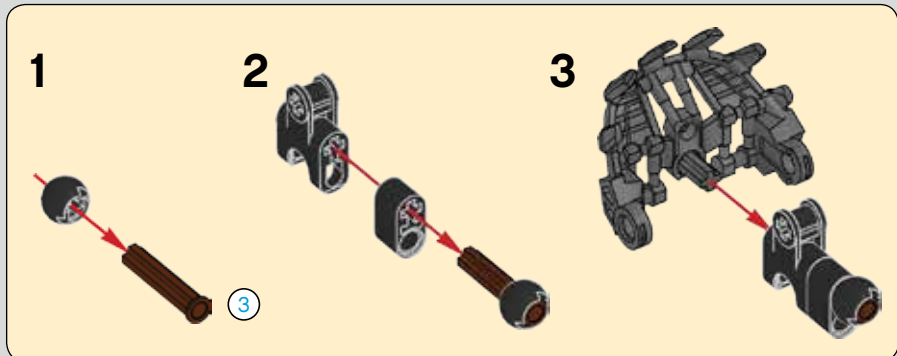

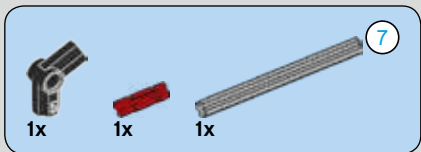

27

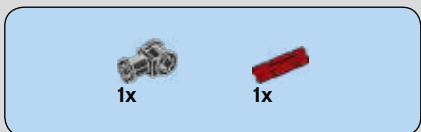
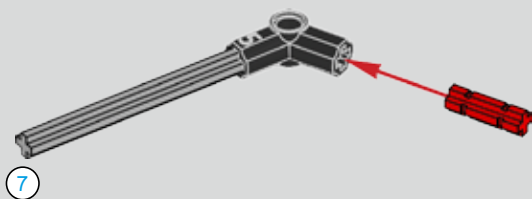

28

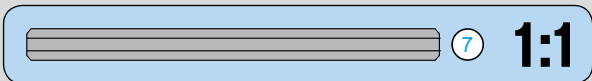
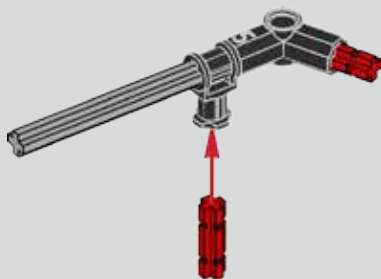

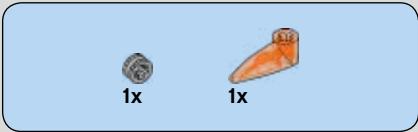

29

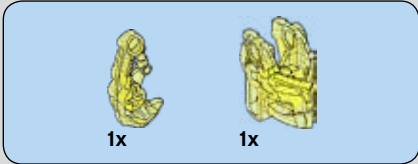
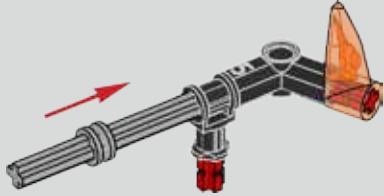

30

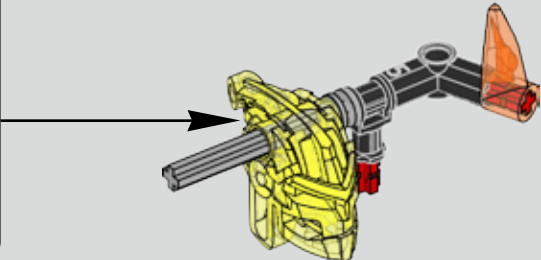
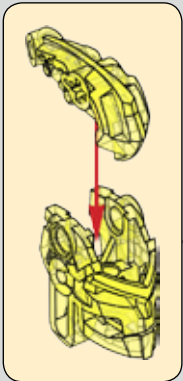



31

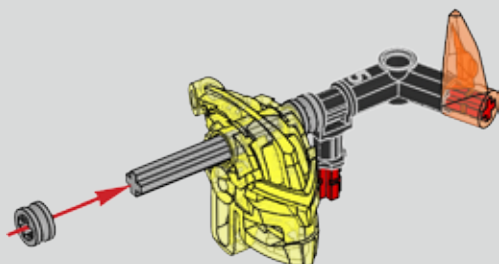

32

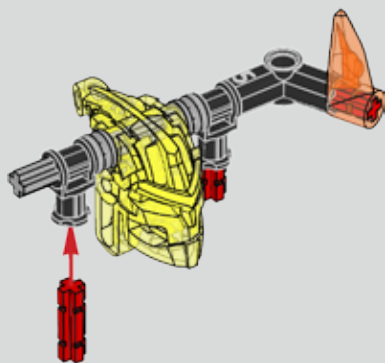

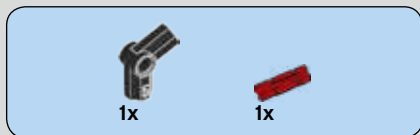

33

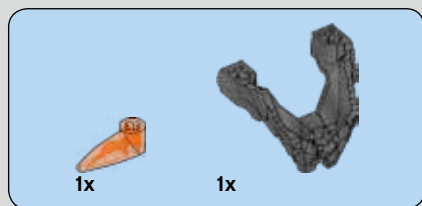
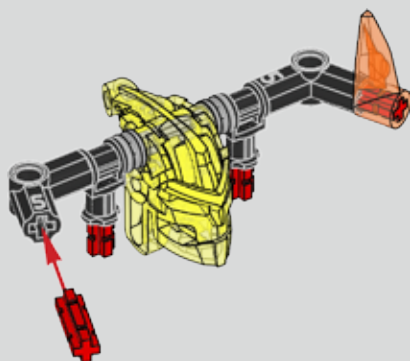

34

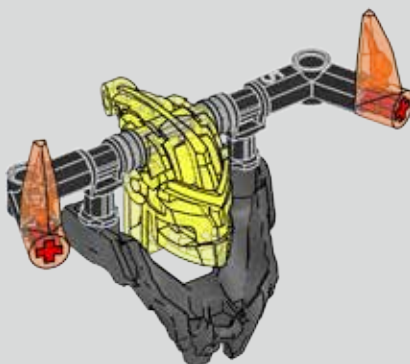

35

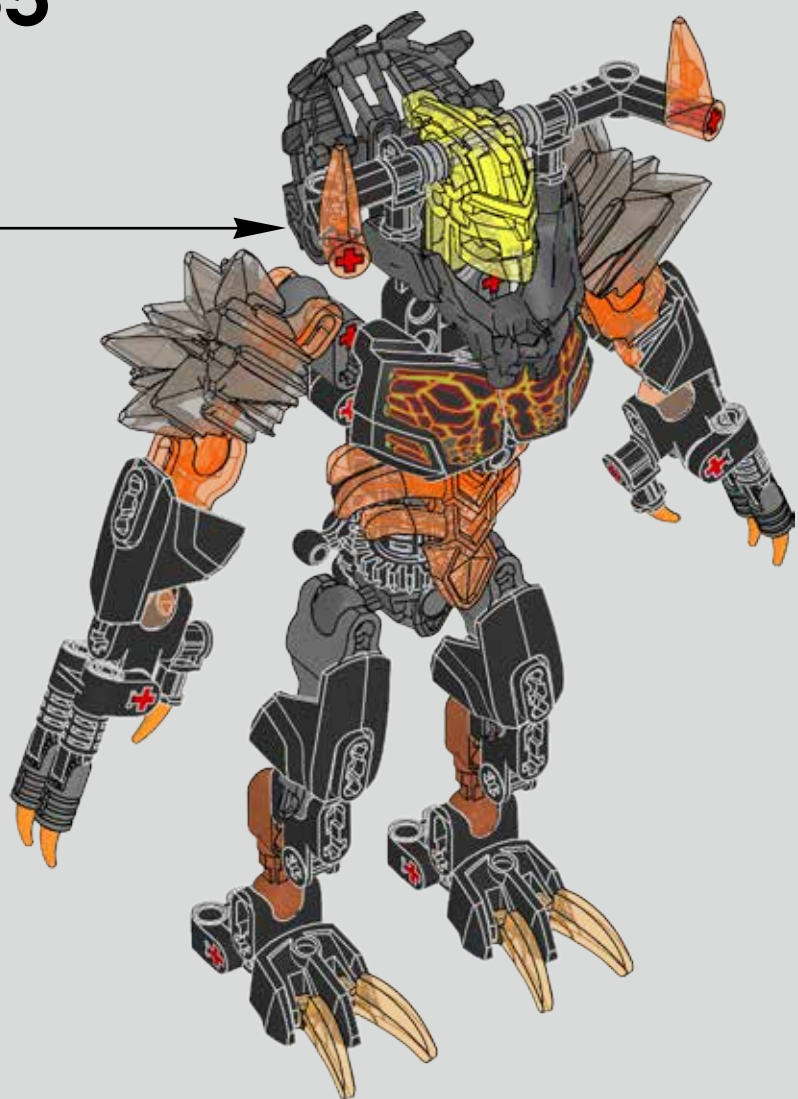

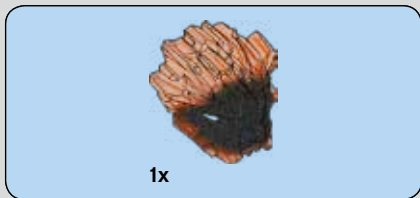

36





37

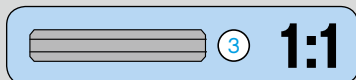
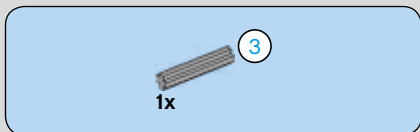
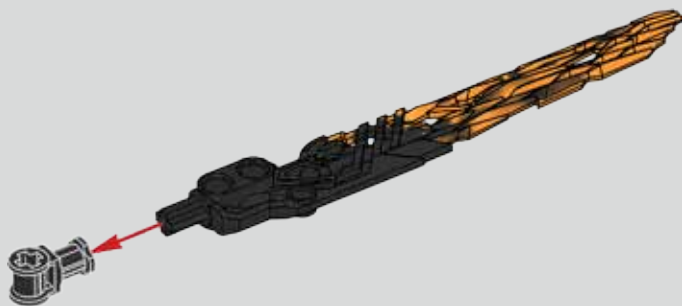

38

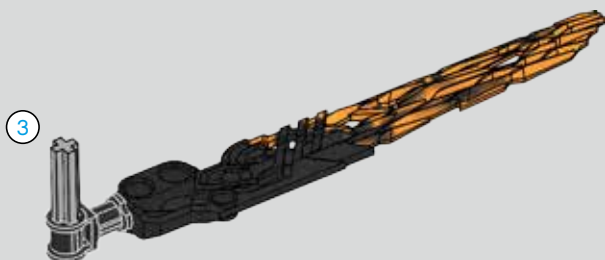

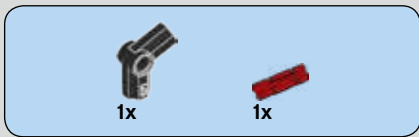

39

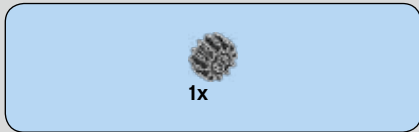
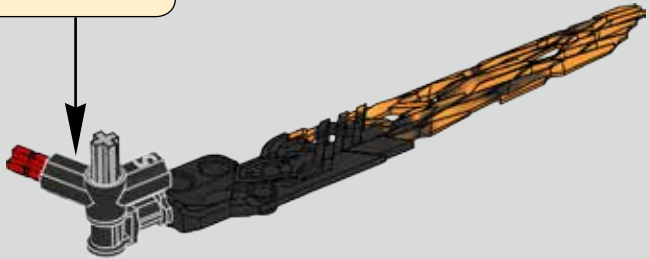
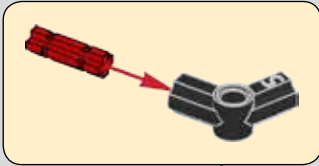

40

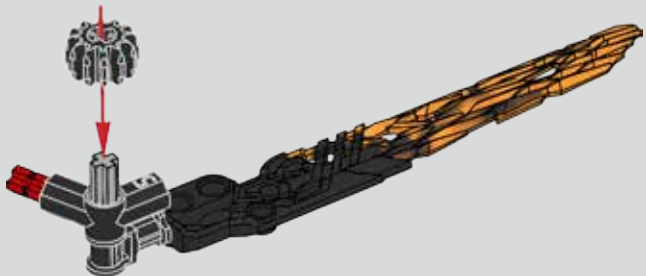



41

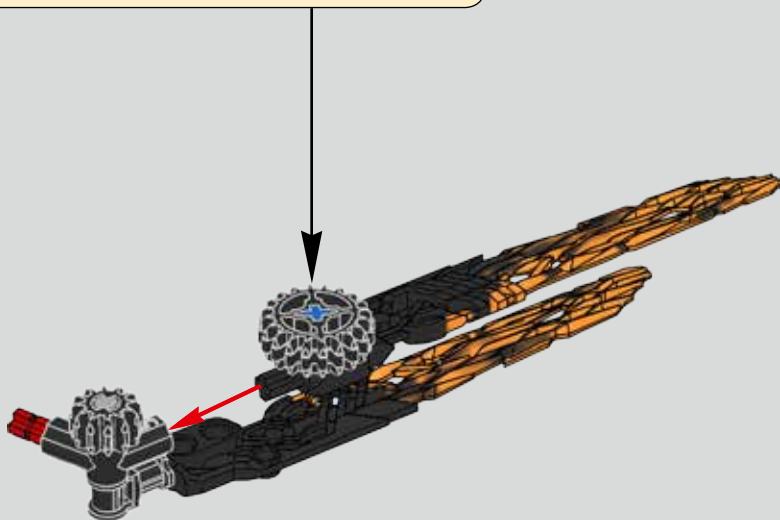
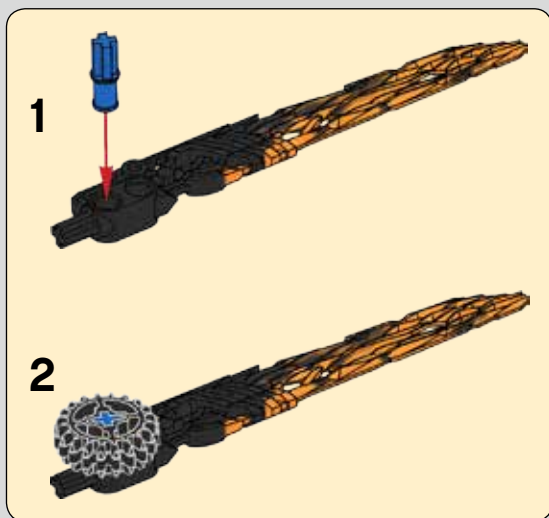

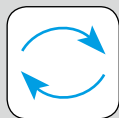

42

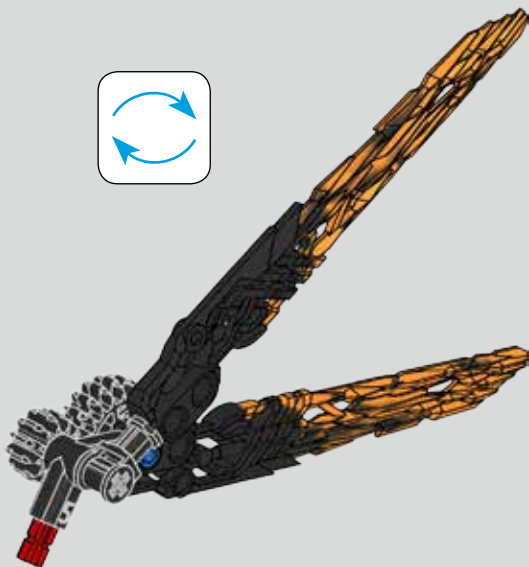

43

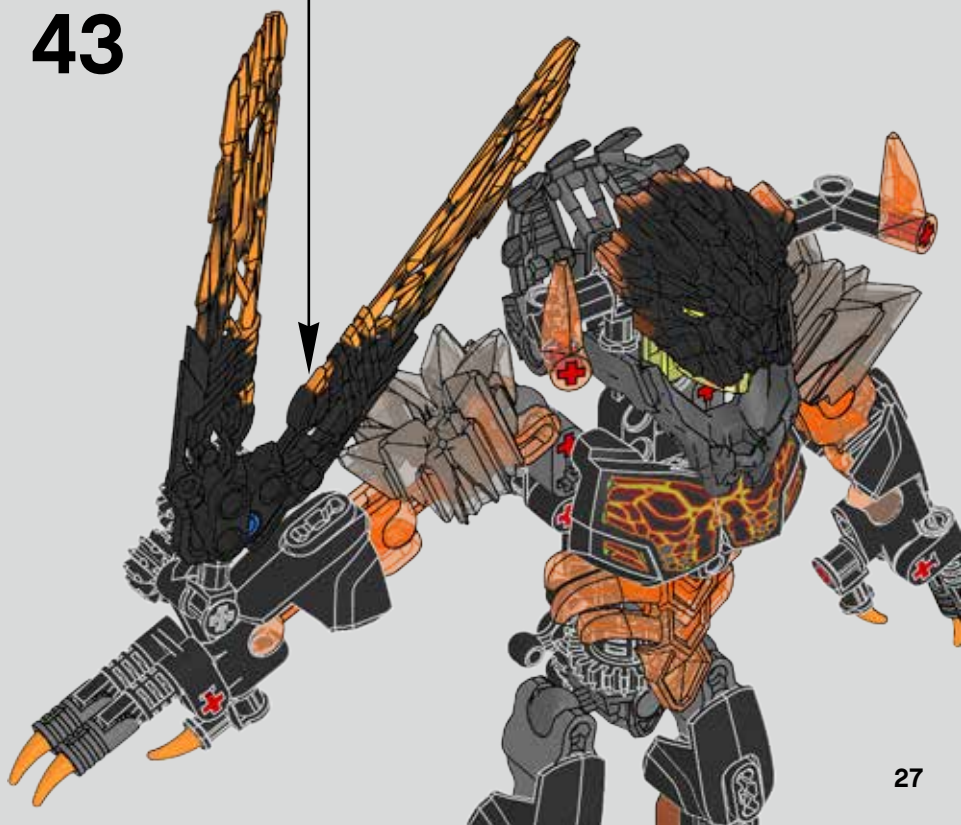



44

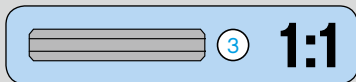
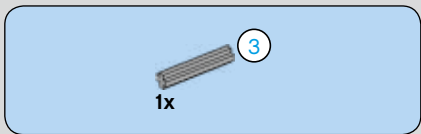

45





1x



1x

46

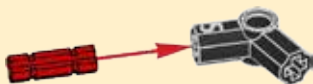

1x

47

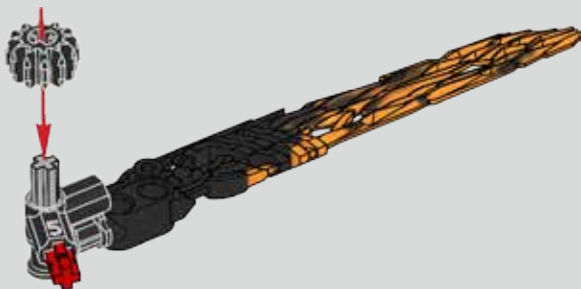

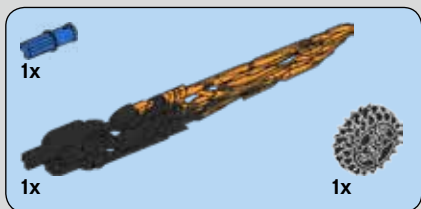

48

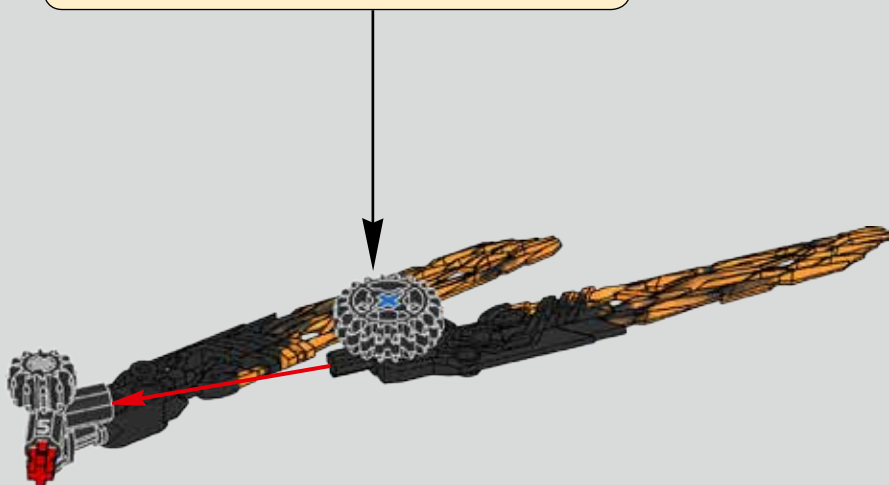
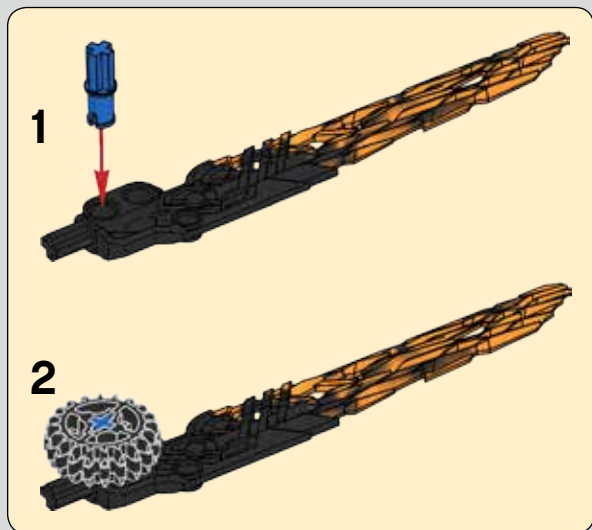

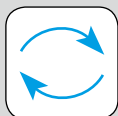

49



50

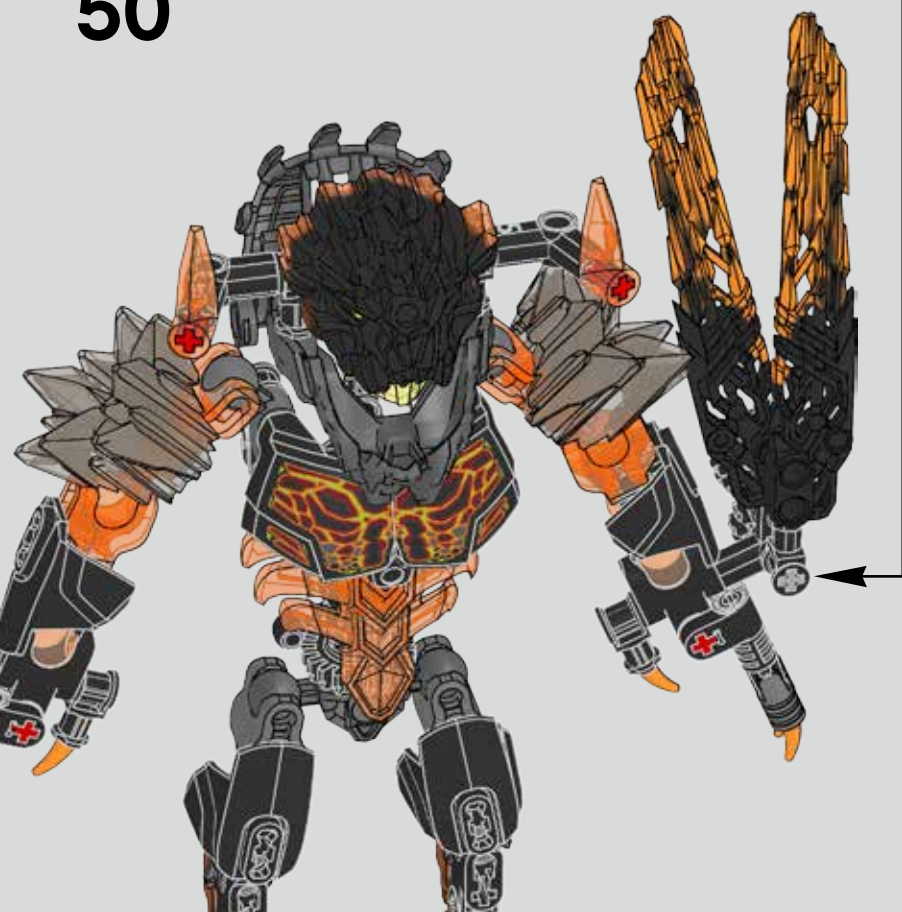



1x

51





2x
6106472



2x
4289258



4x
4210695



1x
6083620



2x
4622903



1x
6001085



1x
6102639



1x
6145450



18x
4142865



2x
4121715



3x
4177431



2x
6093977



6x
4107081



1x
4286267



4x
4107084



4x
4159335



4x
4162857



2x
4121667



2x
6057727



5x
6044720



1x
4248204



1x
6006140



5x
4610948



1x
6151229



1x
6135125



1x
6151197



1x
6158055



2x
4211573

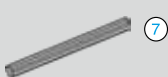

1x
4211805



2x
4211815



4x
6070057



2x
6111281



1x
6114324



4x
6138823

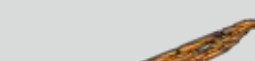

4x
6152476



6x
6096683



2x
6150587



1x
6139106



1x
6135124



1x
6150531



2x
6139208



2x
4206482



1x
6135494

Customer Service

Kundenservice

Service Consommateurs

Servicio Al Consumidor

LEGO.com/service or dial



00800 5346 5555

1-800-422-5346





BIONICLE







71313



71315

 LEGO.com/BIONICLE

71313 + 71314 + 71315 + 71316

Download App
Télécharger l'application
Descarga la App



Apple and the Apple logo are trademarks of Apple Inc., registered in the U.S. and other countries.

App Store is a service mark of Apple Inc.

Google Play is a trademark of Google Inc.



71314



71316





STAR WARS™



75113



75115



75116



BUILDABLE FIGURES
FIGURINES À CONSTRUIRE
FIGURAS PARA CONSTRUIR



75114



75118



75117