



NINJAGO

Masters of Spinjitzu



70750



LEGO.com/ninjago



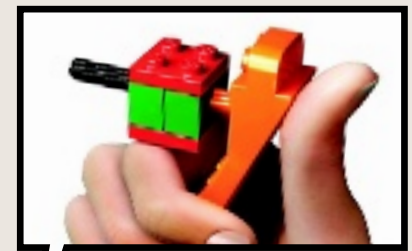
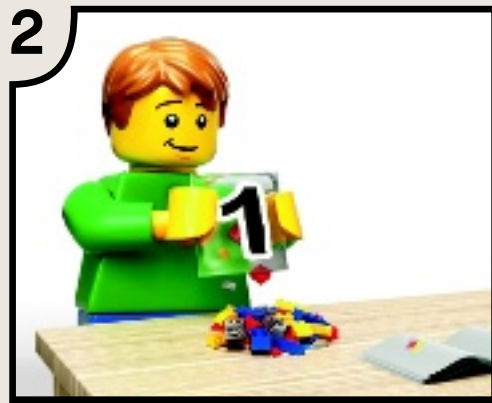

LEGO.com/brickseparator

EN IMPORTANT: Never modify the elements or use other projectiles than provided with this toy.
 DE WICHTIG: Die Elemente dürfen nicht verändert werden. Es dürfen ausschließlich die mit dem Spielzeug mitgelieferten Geschosse verwendet werden.
 FR IMPORTANT : Ne jamais modifier les éléments ni utiliser d'autres projectiles que ceux fournis avec ce jouet.
 IT IMPORTANTE: non modificare gli elementi o utilizzare proiettili non forniti con questo prodotto.
 NL BELANGRIJK! Verander niets aan de elementen en gebruik geen andere projectielen dan de bij het speelgoed geleverde.
 ES IMPORTANTE: No modifique los elementos ni utilice otros proyectiles diferentes a los suministrados junto con este juguete.
 DA VIGTIG: Elementerne må ikke ændres, og der må ikke bruges andre projektiler end dem, der følger med legetøjet.
 FI TÄRKEÄÄ: Älä koskaan tee osiin muutoksia tai käytä lelussa muita kuin sen sisältämiä ammuksia.
 SV VIKTIGT: Modifiera aldrig delarna och använd aldrig andra projektiler än de som medföljer denna leksak.
 PT IMPORTANTE: Nunca modifique os elementos nem utilize projecteis que não tenham sido fornecidos com este brinquedo.
 EL ΣΗΜΑΝΤΙΚΟ: Ποτέ μην τροποποιείτε τα στοιχεία του παιχνιδιού και μην χρησιμοποιείτε άλλα βλήματα εκτός από αυτά που συνοδεύουν αυτό το παιχνίδι.
 JA 重要：部品を改造したり、本製品に付属の発射体以外のものを使用しないようにしてください。
 ZH 重要提示：切勿更改组件或使用并非由本玩具附带的弹丸。
 KO 중요할: 이들 부품을 수정하거나 이 완구와 함께 제공된 것이 아닌 발사체는 결코 사용하지 마십시오.
 RU ВАЖНО: запрещается вносить изменения в элементы или использовать другие снаряды, отличные от тех, которые поставляются с данной игрушкой.
 PL WAŻNE: Nigdy nie modyfikować elementów zabawki ani nie używać pocisków innych niż dostarczone z zabawką.
 CZ UPOZORNĚNÍ: Nikdy neupravujte součástky a nepoužívejte jiné projektily než ty, které jsou dodávány s touto hračkou.
 SK UPOZORNENIE: Nikdy neupravujte súčasti a nepoužívajte iné projektily než tie, ktoré sú dodávané s touto hračkou.
 HU FONTOS: Az elemeket nem szabad módosítani, és a játékhöz adott lövedékek helyett sem szabad mást használni.
 UA ВАЖЛИВО: забороняється вносити зміни до елементів або використовувати інші снаряди на відміну від тих, що поставляються з цією іграшкою.
 HR VAŽNO: Nemojte nikad mijenjati elemente ili koristiti druge projektile osim onih koji su bili priloženi uz ovu igračku prilikom kupnje.
 SR Важно: Немојте да модификујете елементе и не користите друге пројектиле осим оних који долазе уз ову играчку.
 SL POMEMBNO: Nikoli ne spreminjajte elementov in uporabljajte le izstrelke, ki so bili priloženi tej igrači.
 RO IMPORTANT: Nu modificați niciodată elementele și nu utilizați alte proiectile decât cele furnizate cu această jucărie.
 BG ВАЖНО: Не видоизменяйте елементите и не използвайте други снаряди освен приложените към тази играчка.
 LV SVARĪGLI Nekad nepārveidojiet rotallietas elementus, vienmēr izmantojiet tikai tās komplektā iekļautās lodītes.
 ET OLULINE: Mänguasja osi ei tohi teistega asendada, kasutada võib ainult kaasasolevat heitkeha.
 LT DĖMESIO! Niekuomet nekeiskite elementų ir naudokite tik tuos šovinius, kurie yra pridėti prie šio žaislo.
 TR ÖNEMLİ: Hiçbir zaman parçalarda değışiklik yapmayın veya bu oyuncakla sağlananlar dışında mermiler kullanmayın.





1



2



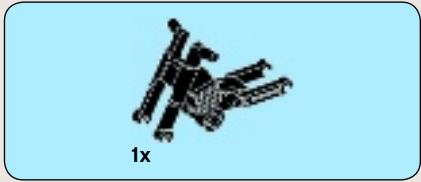

1

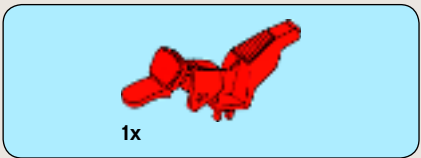

2



3

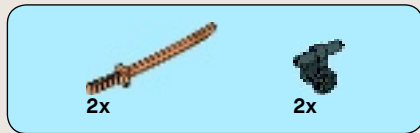
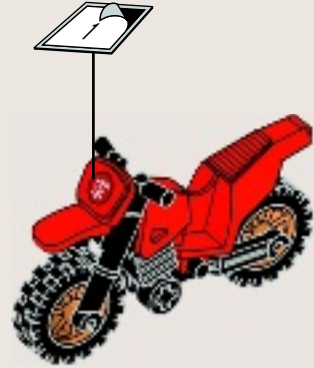

4



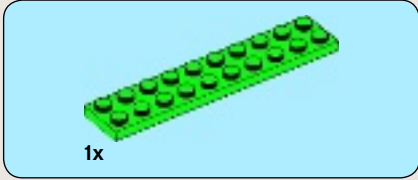

1x

1

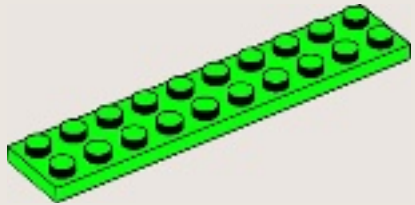

2x

2

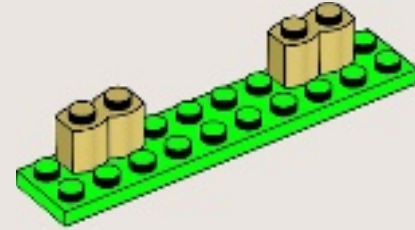

2x

2x

3

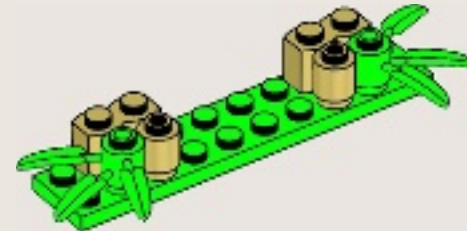



4

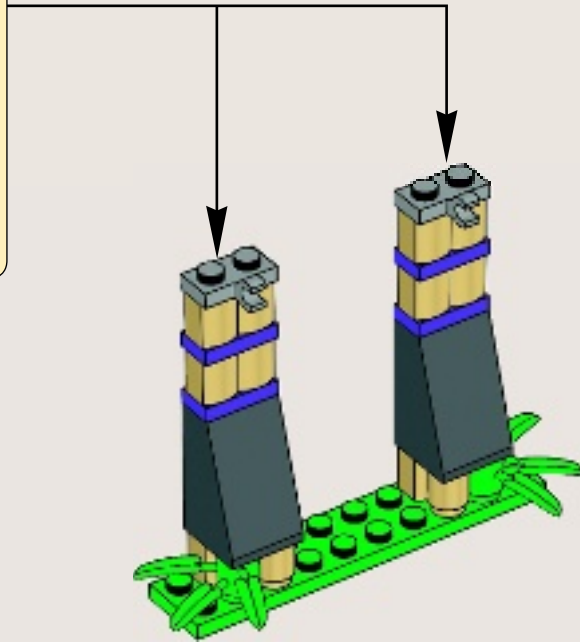
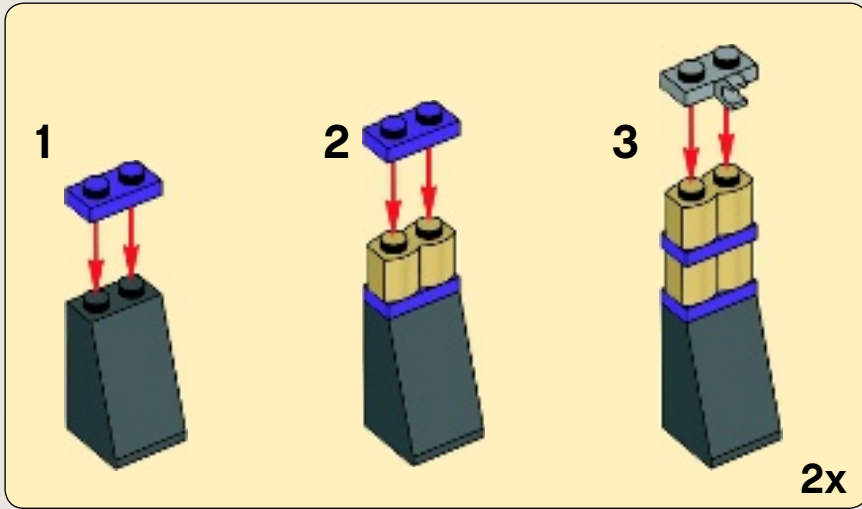

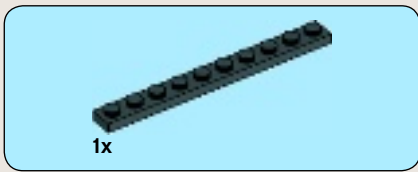

5

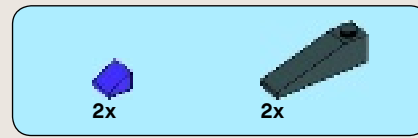
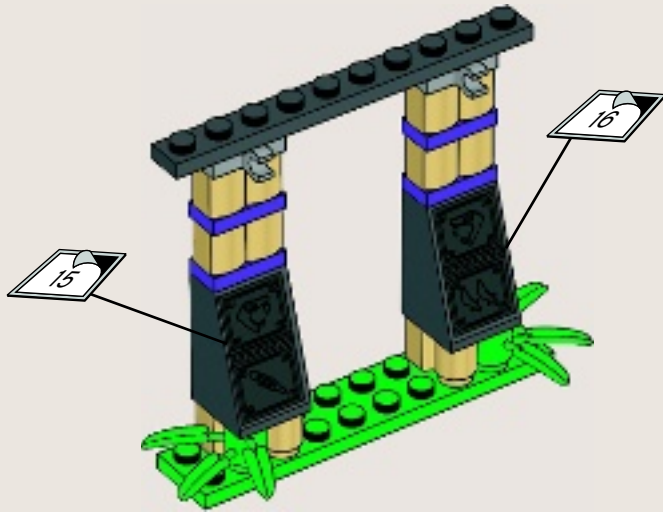

6

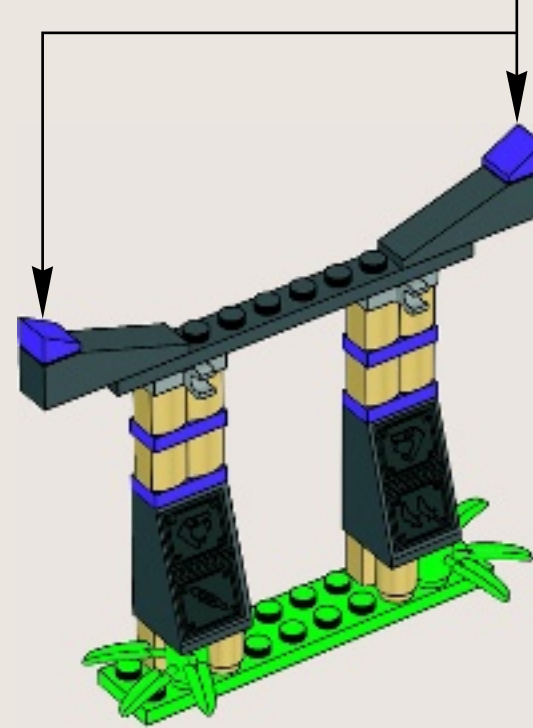
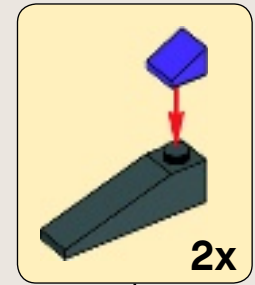

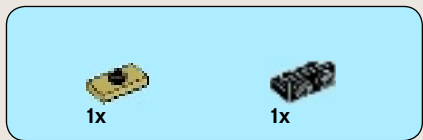

7

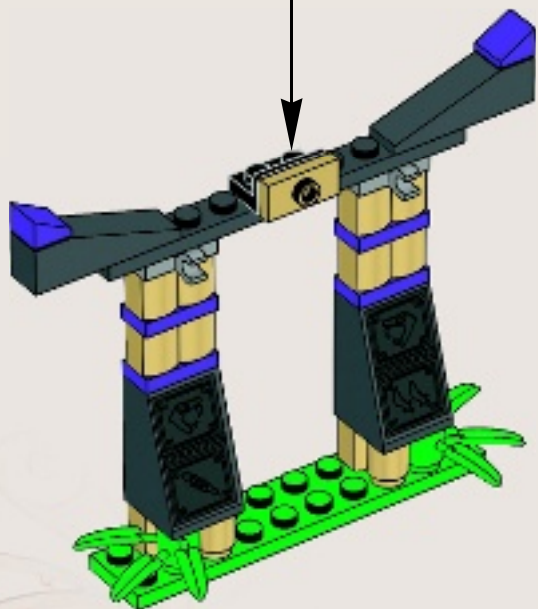
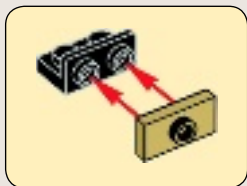

8



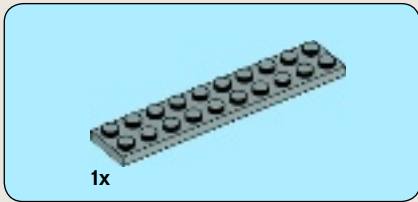
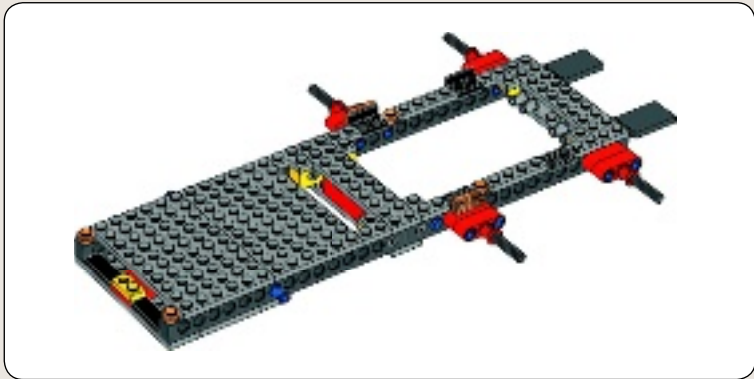

1

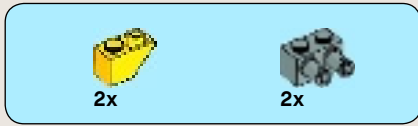
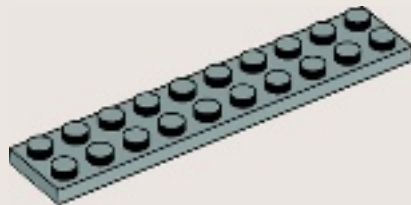

2

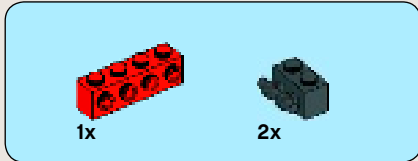
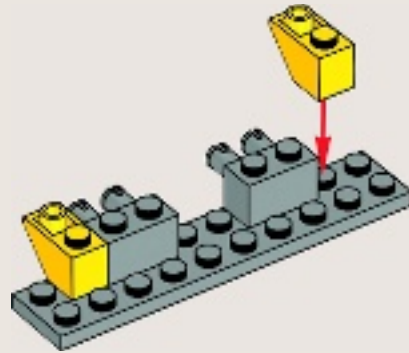

3

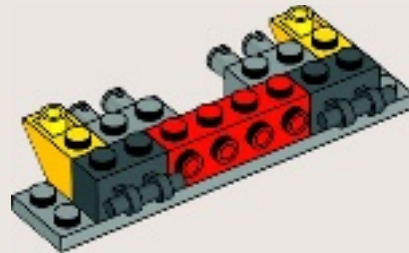

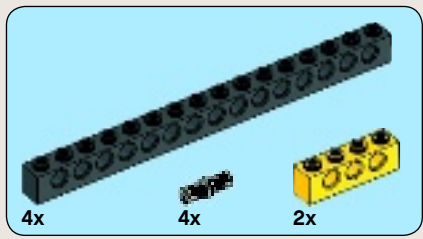

4

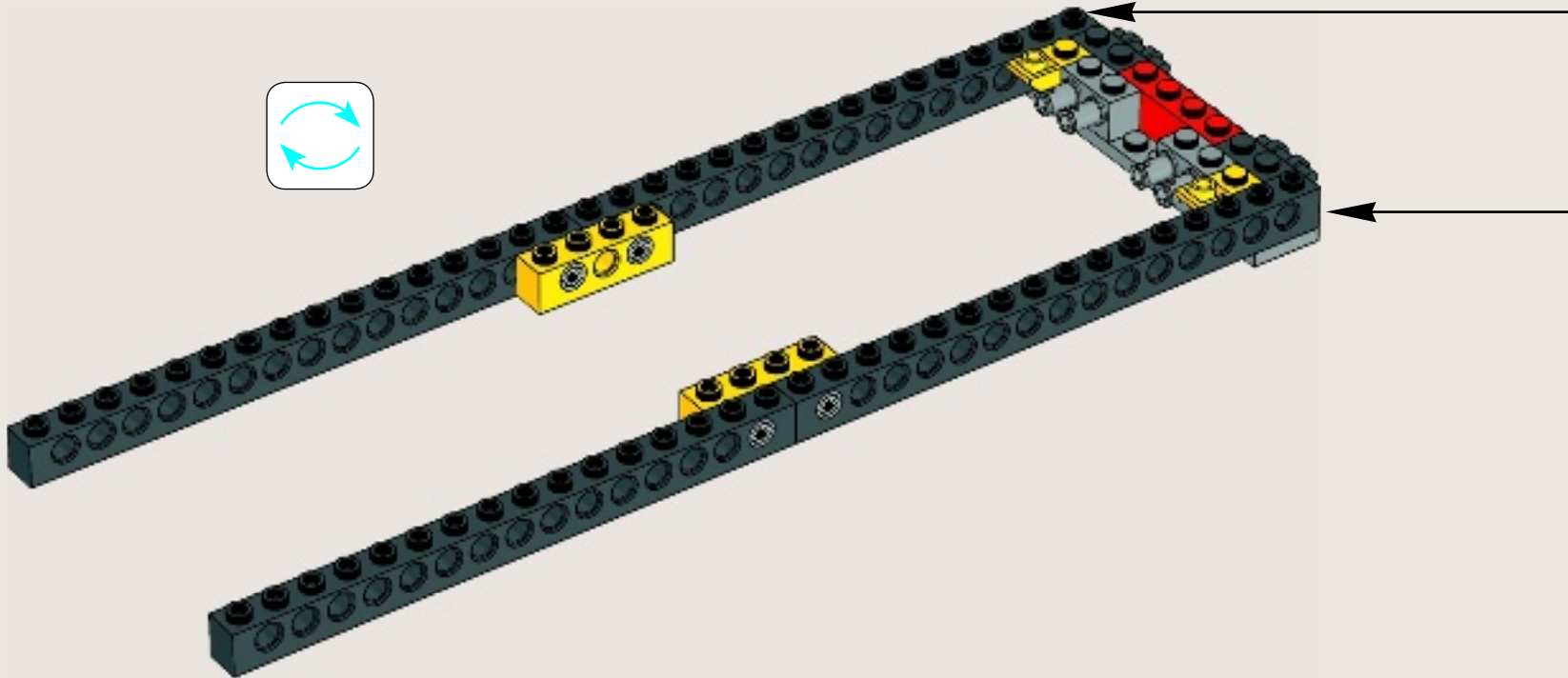
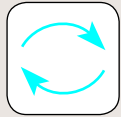
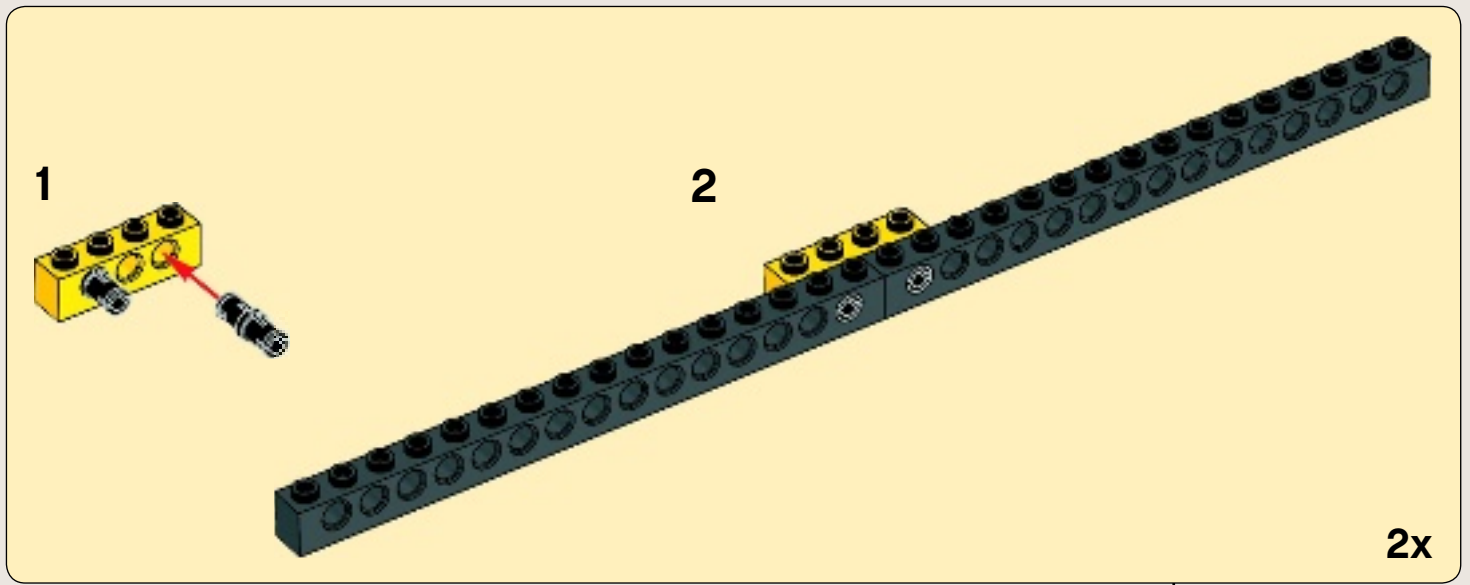

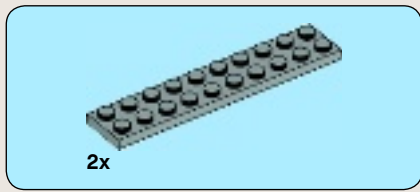

5

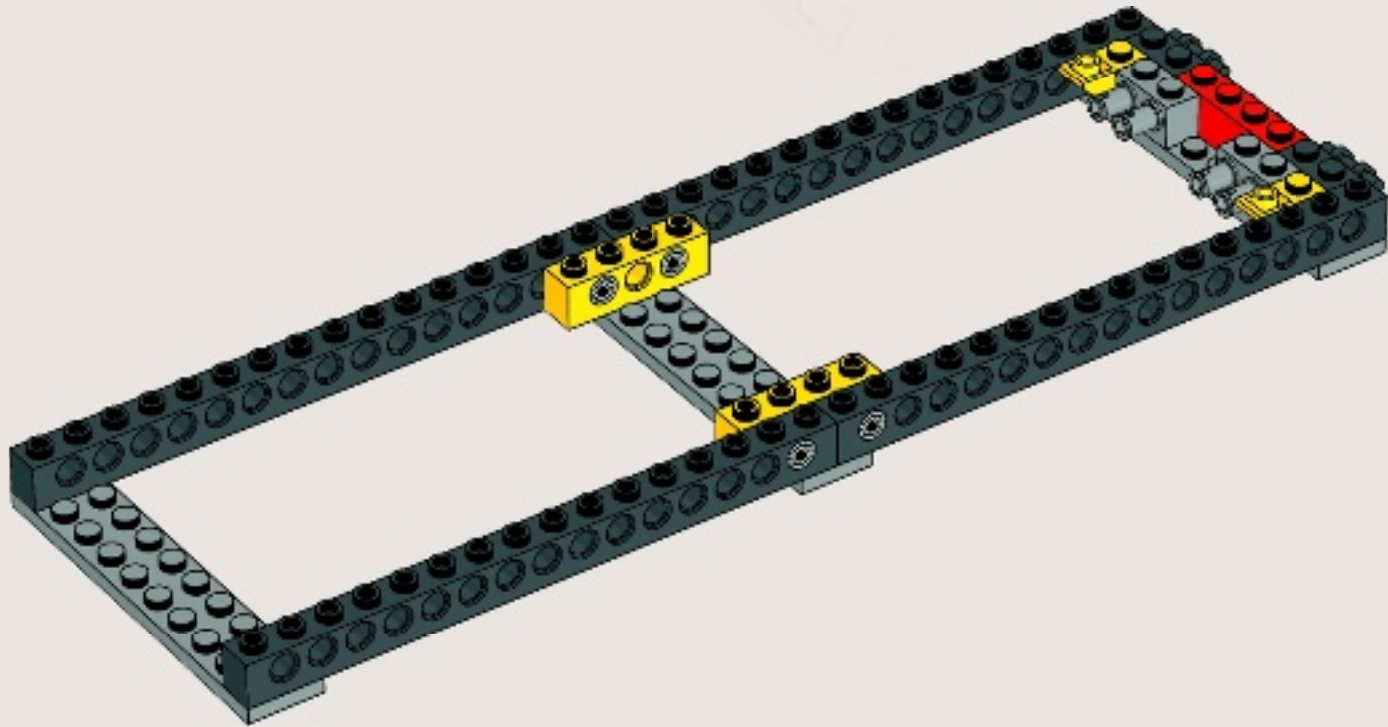

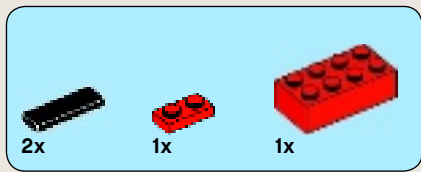

6

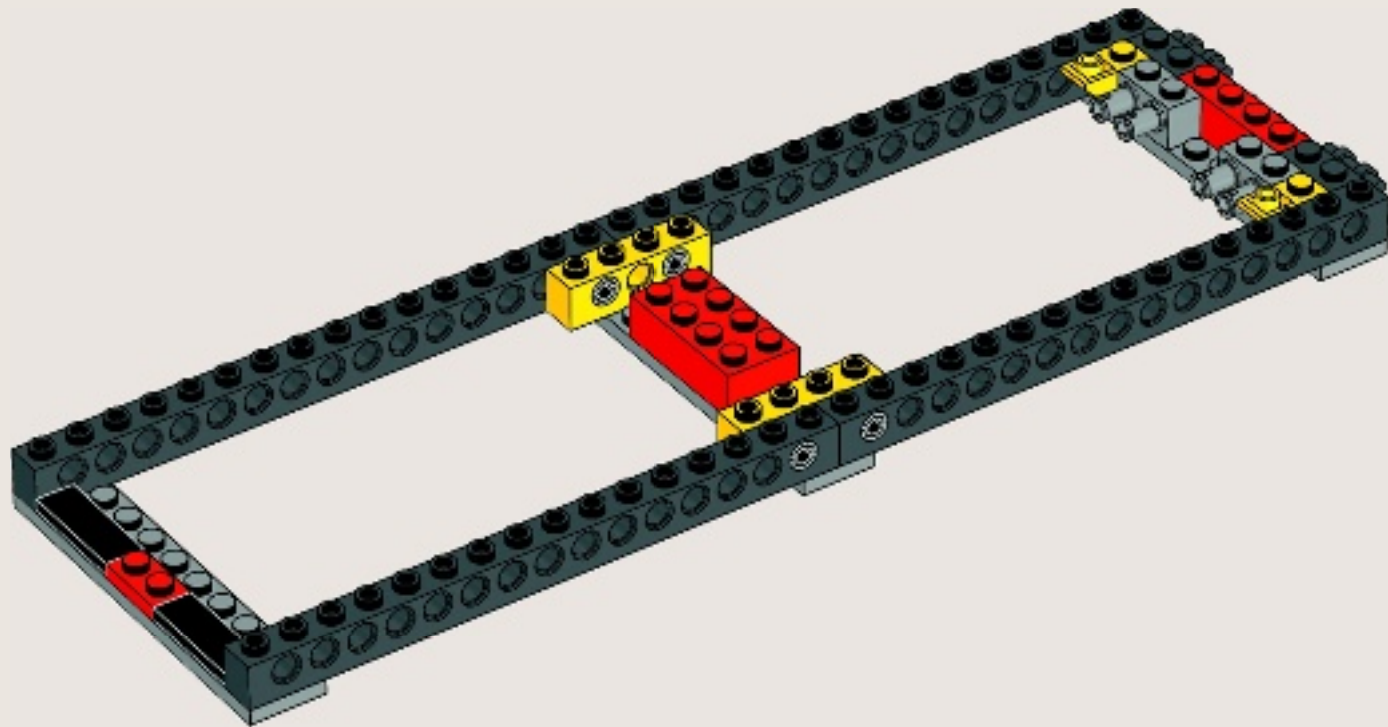

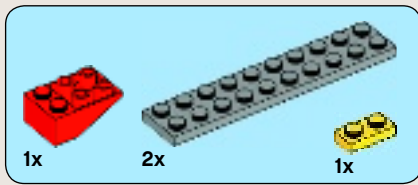

7

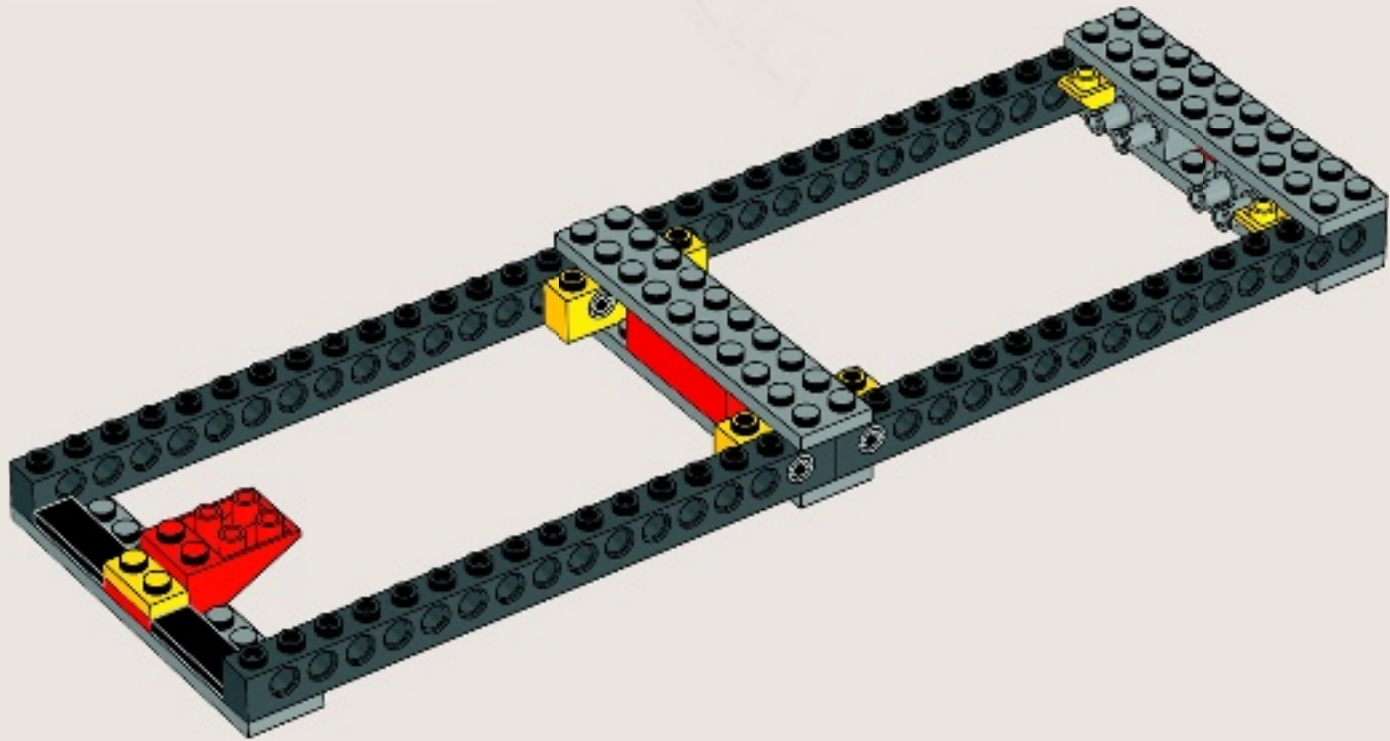



6x

8

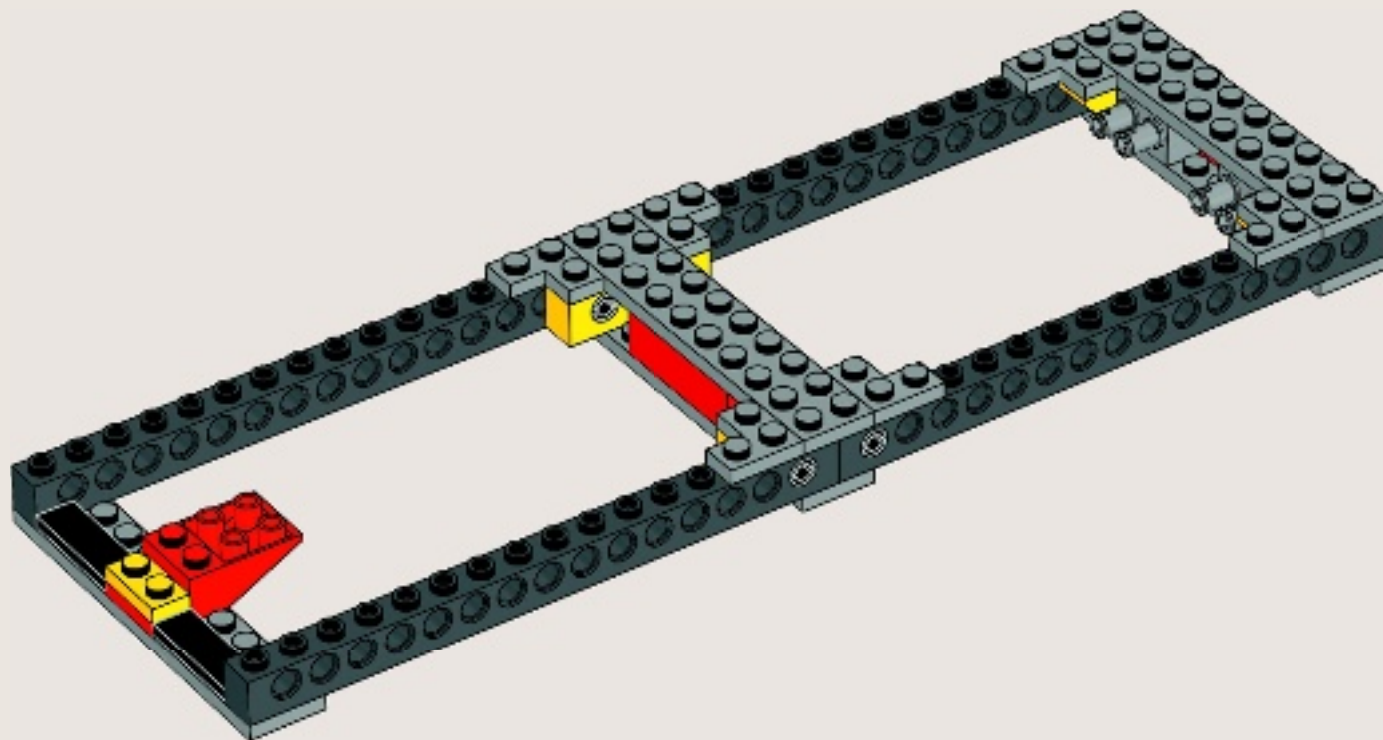

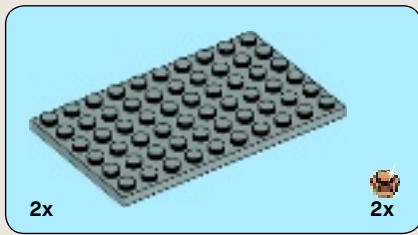

9

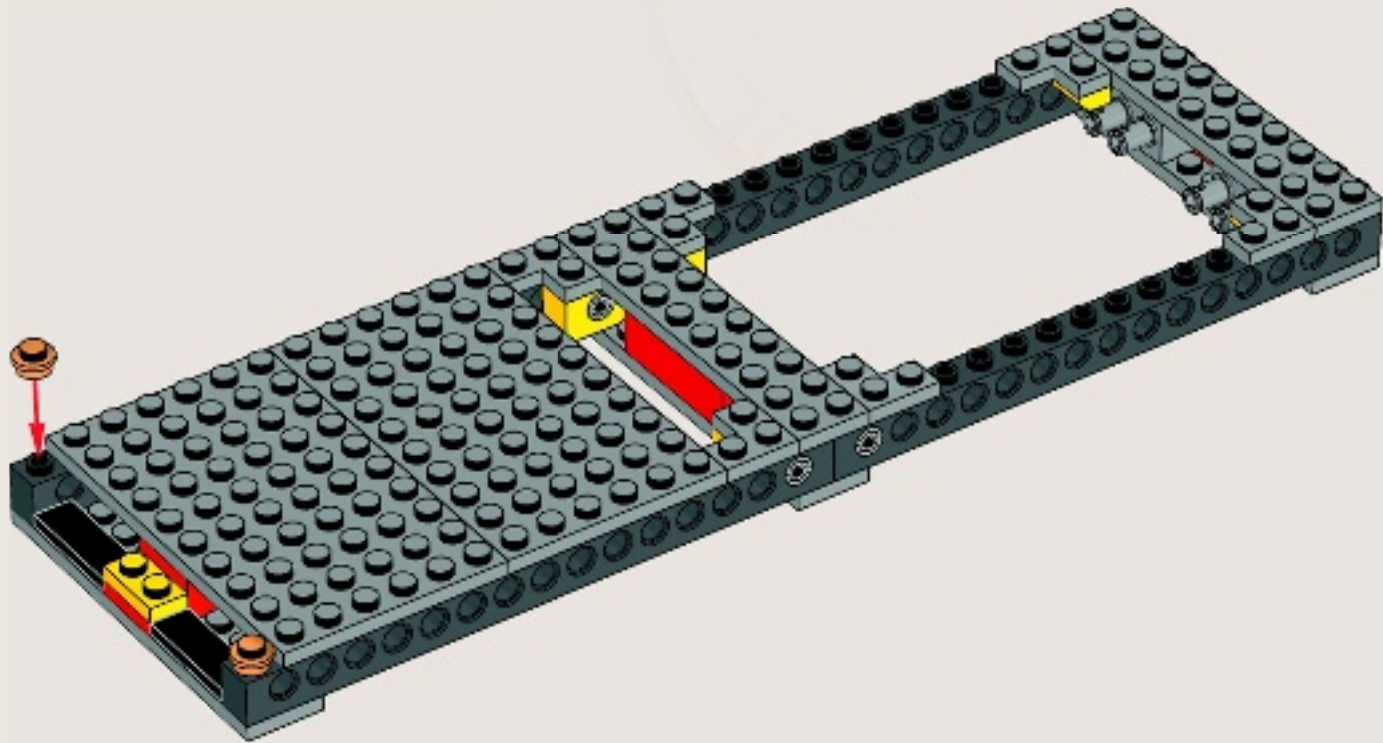

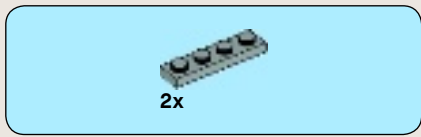

10

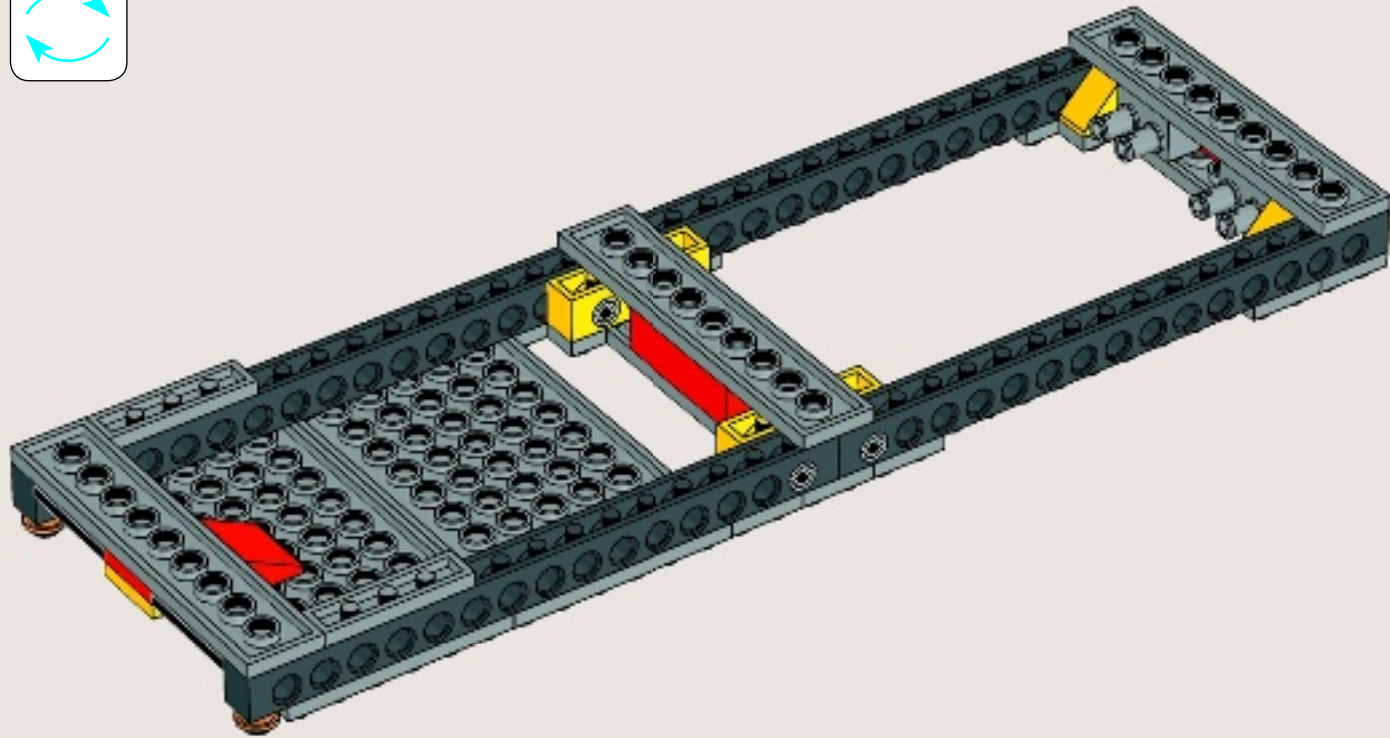
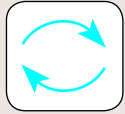

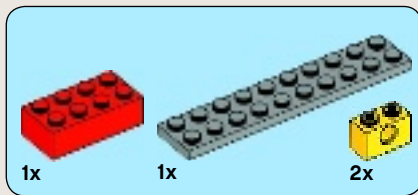

11

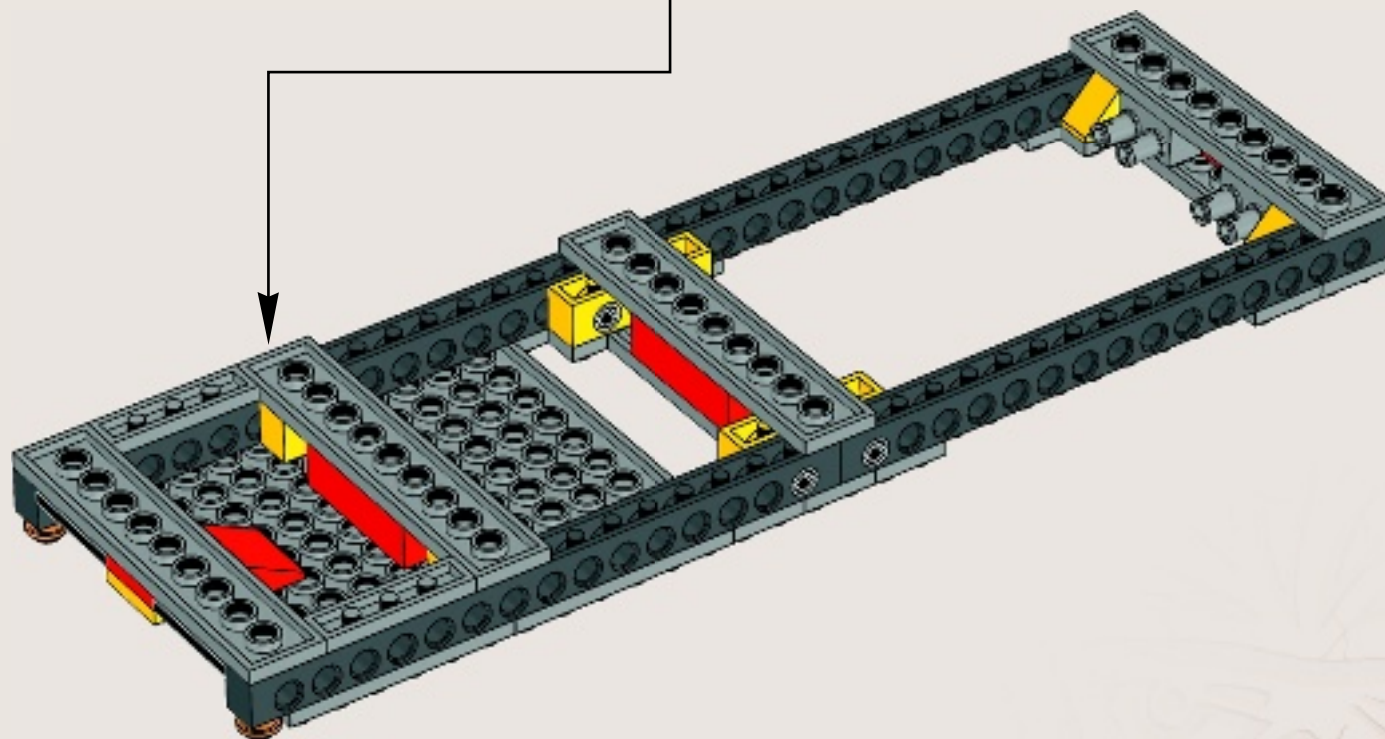
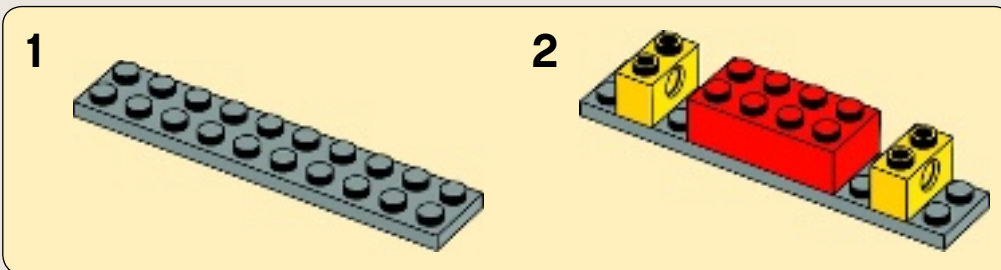

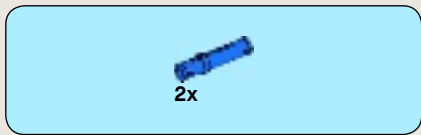

12

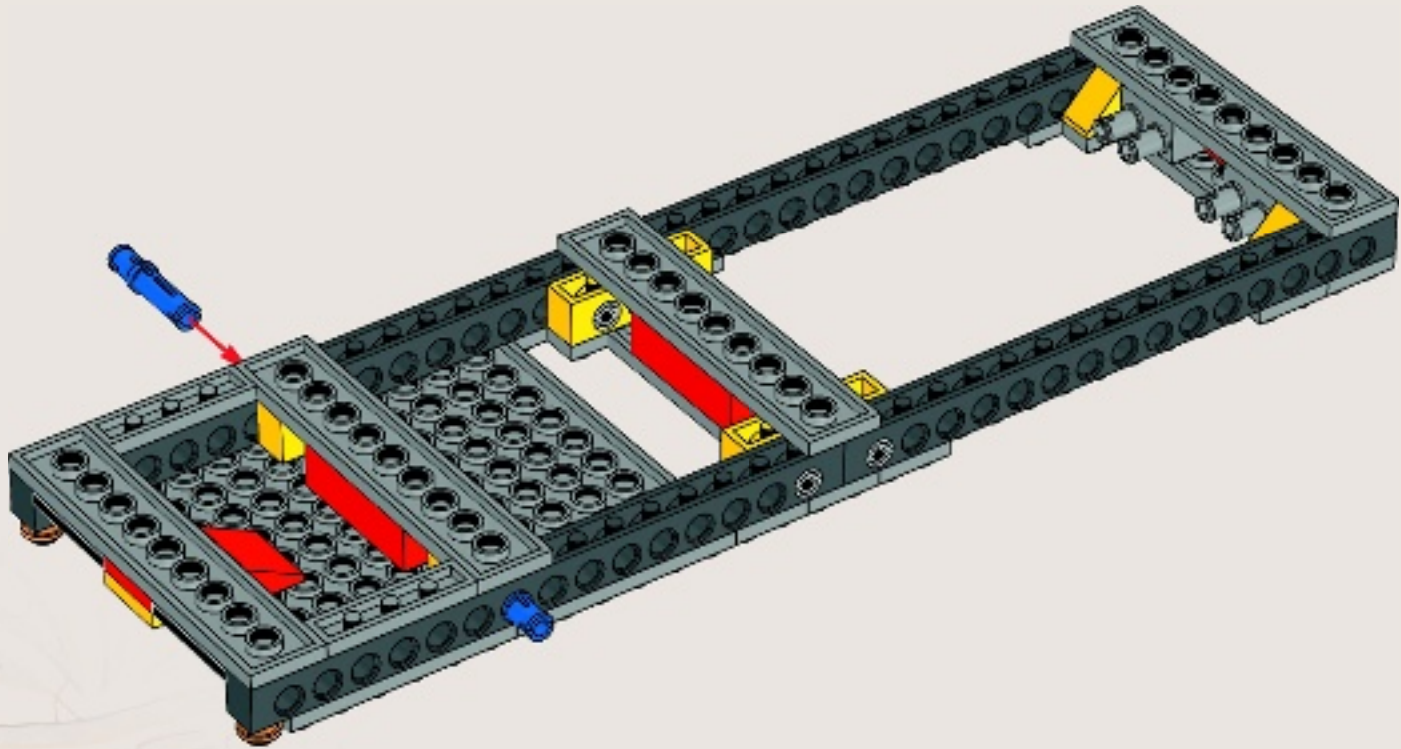



13

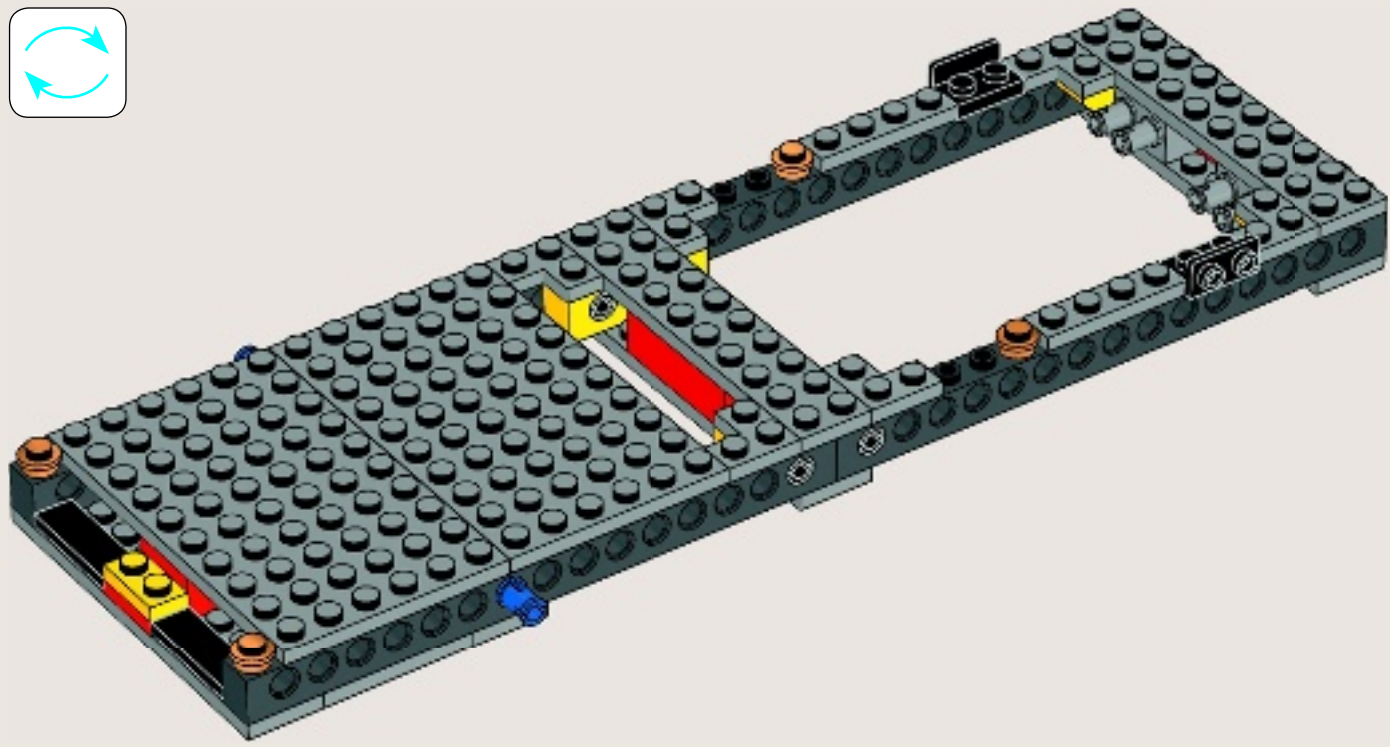
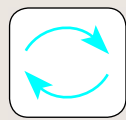

2x

2x

14

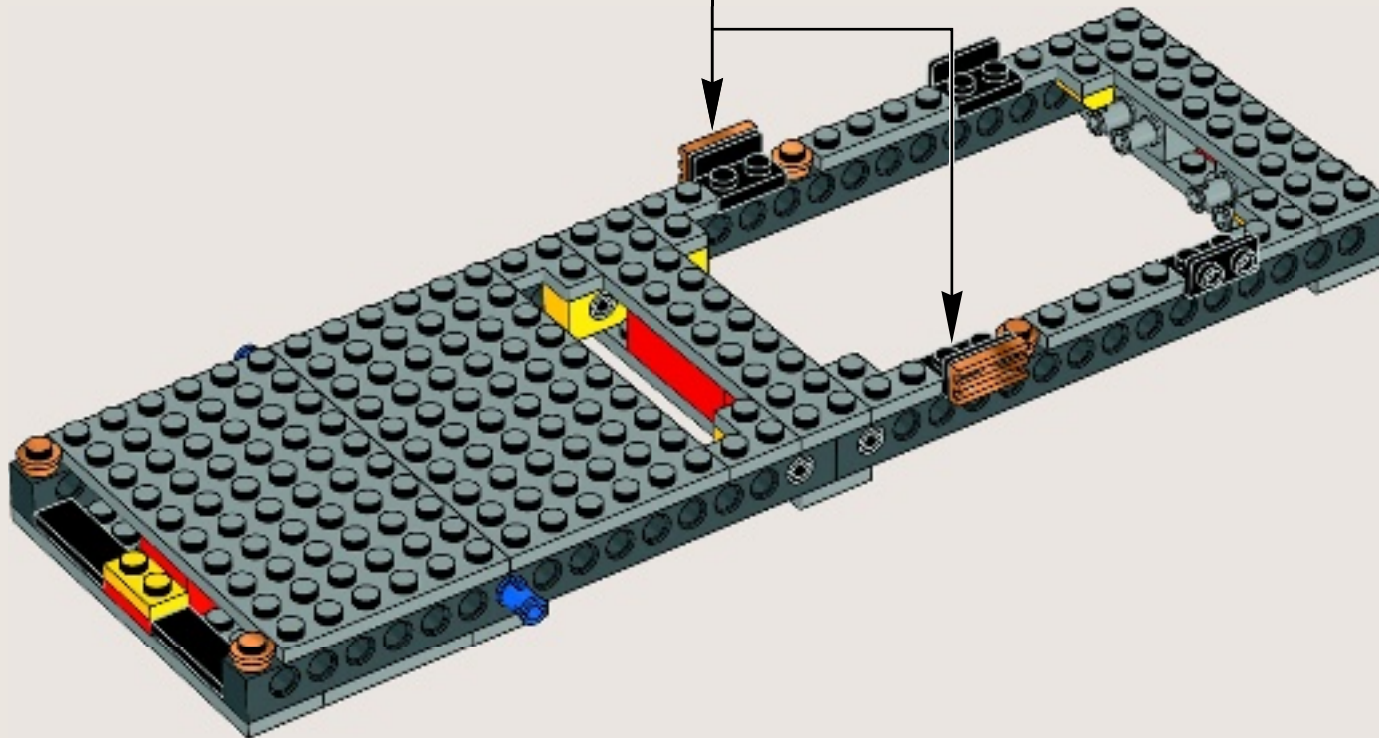
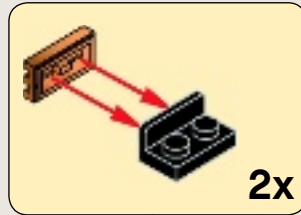

2x

15

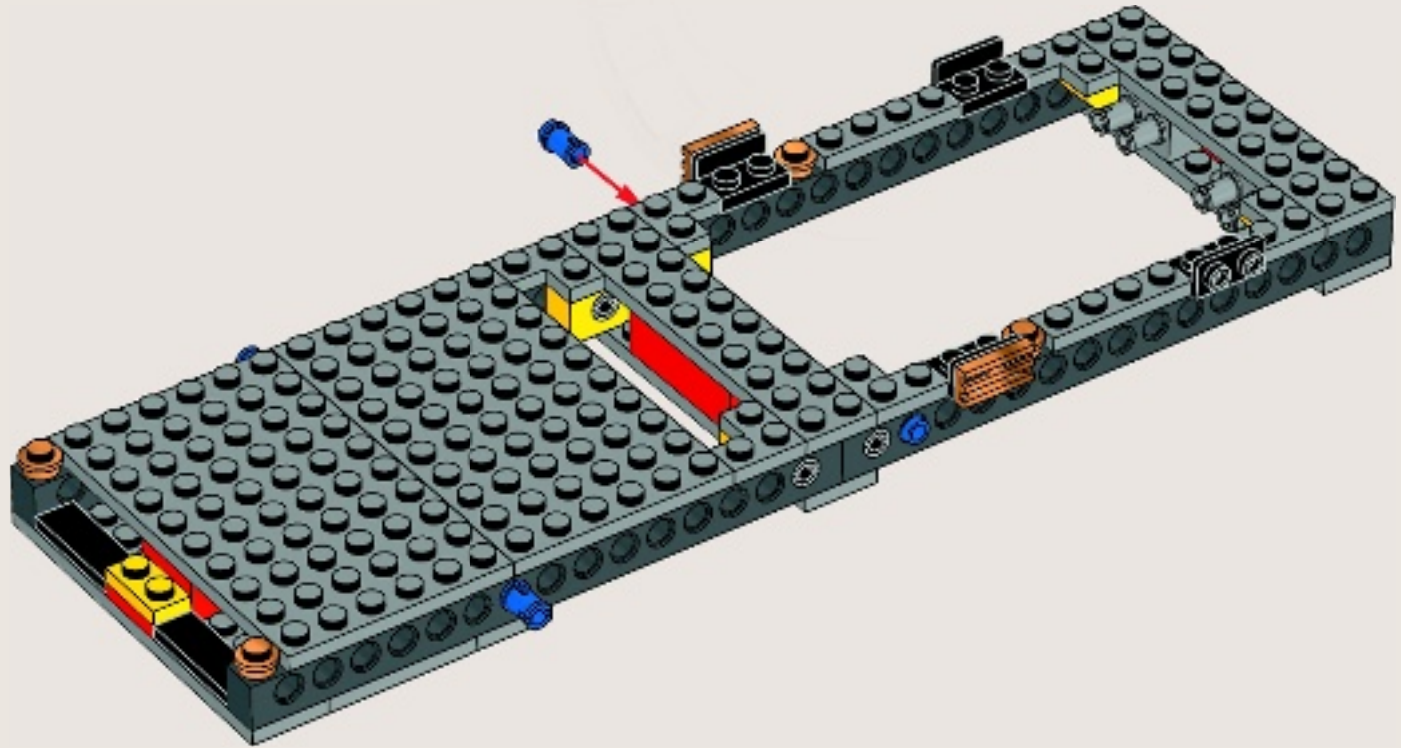

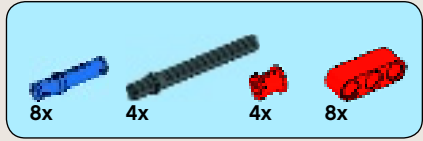

16

1



2

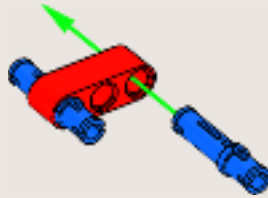

3

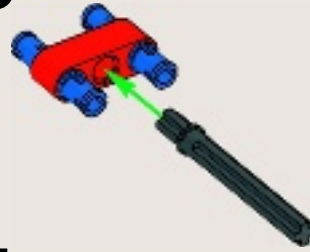

4



5

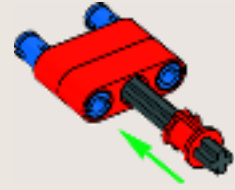

4x

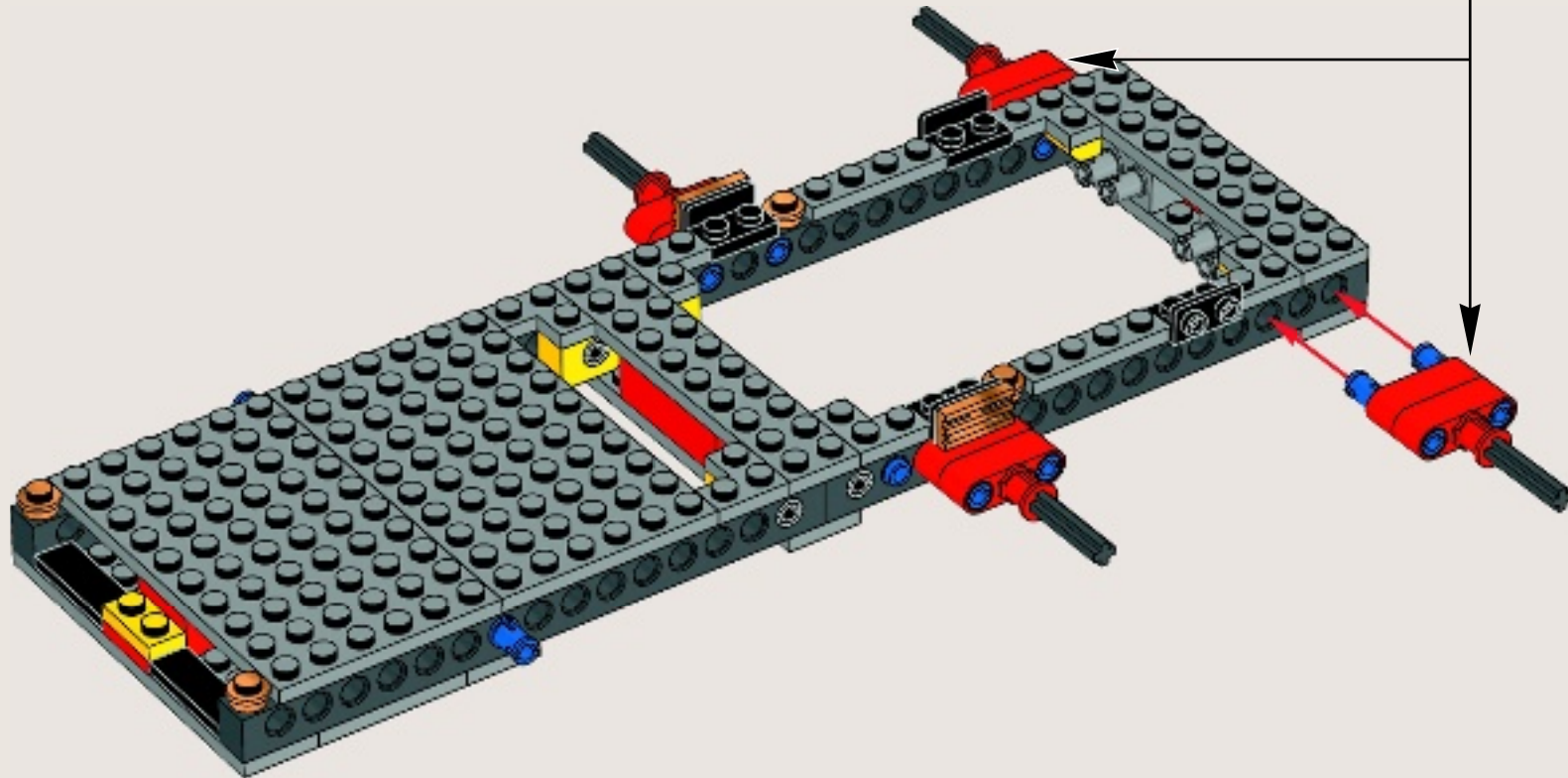



17

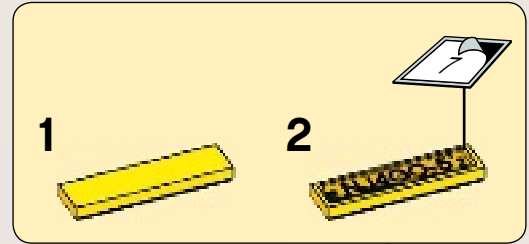
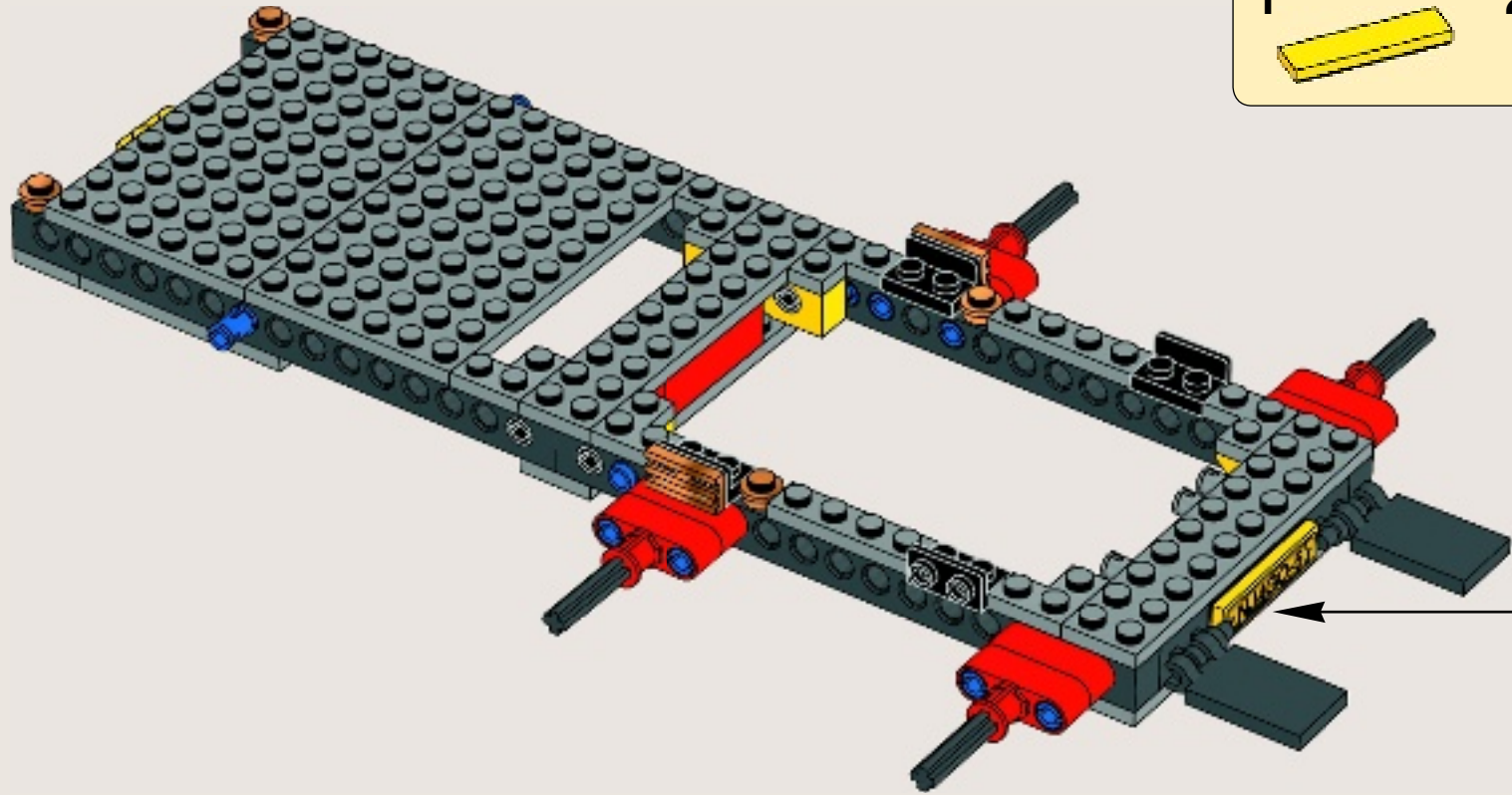

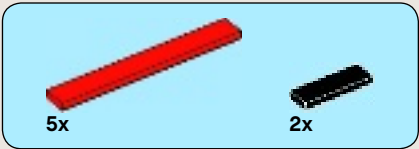
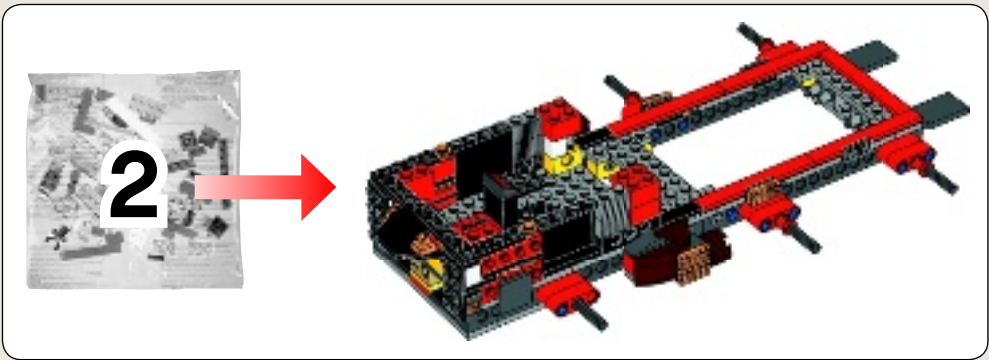

18

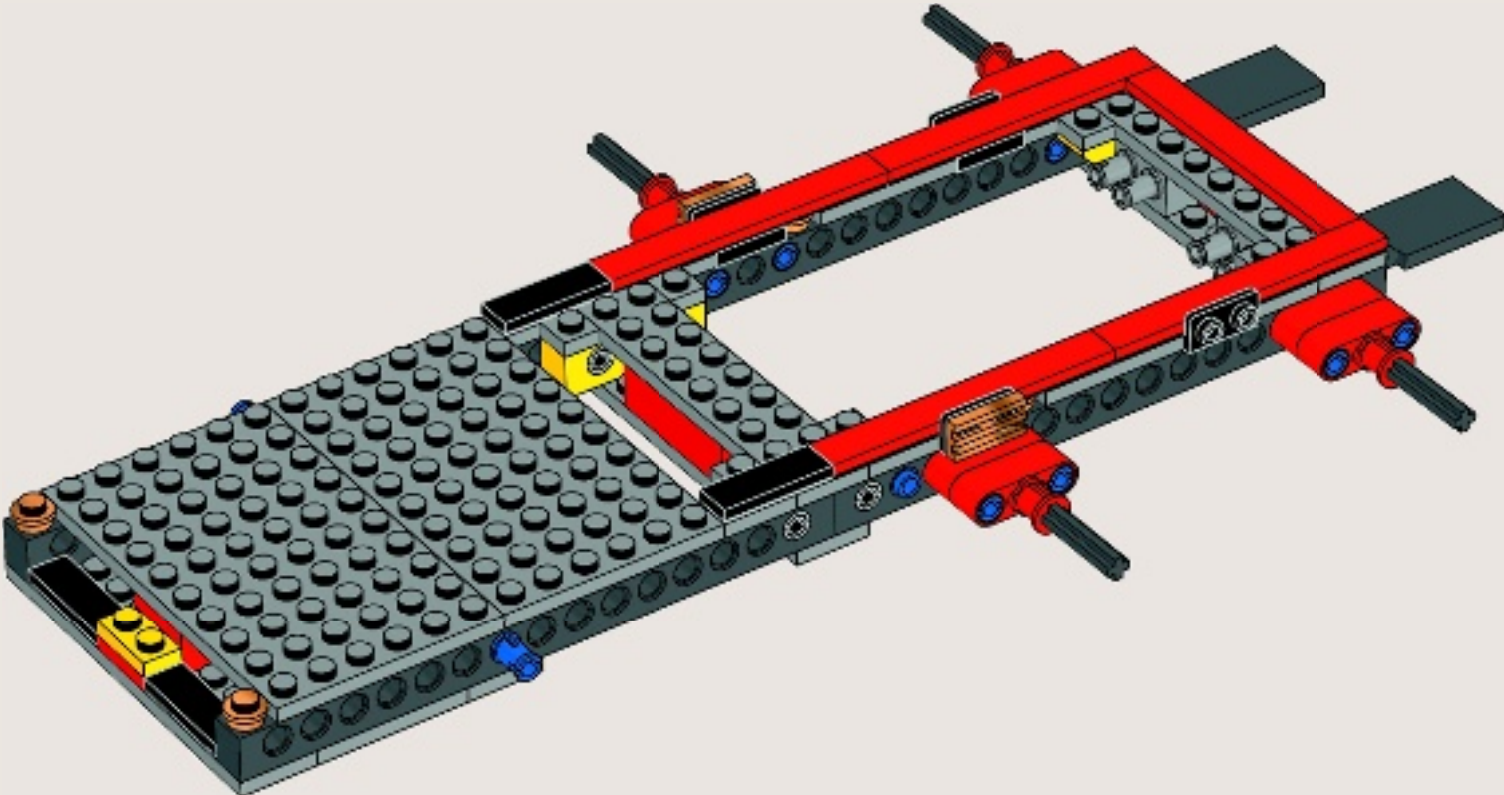



19

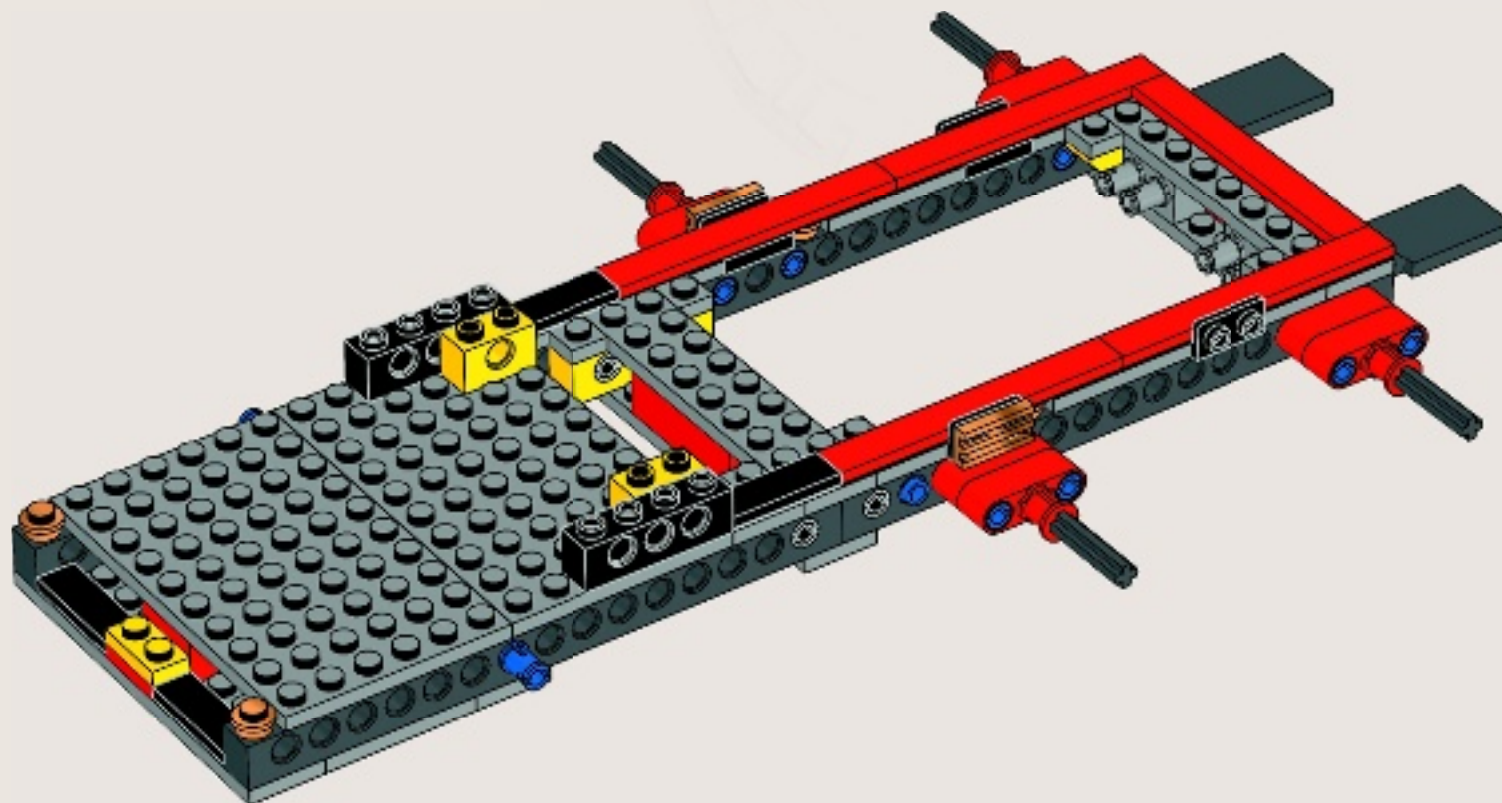

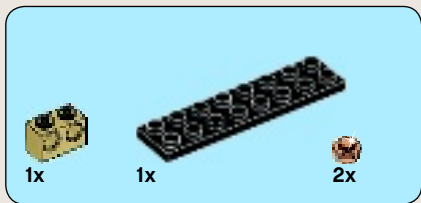

20

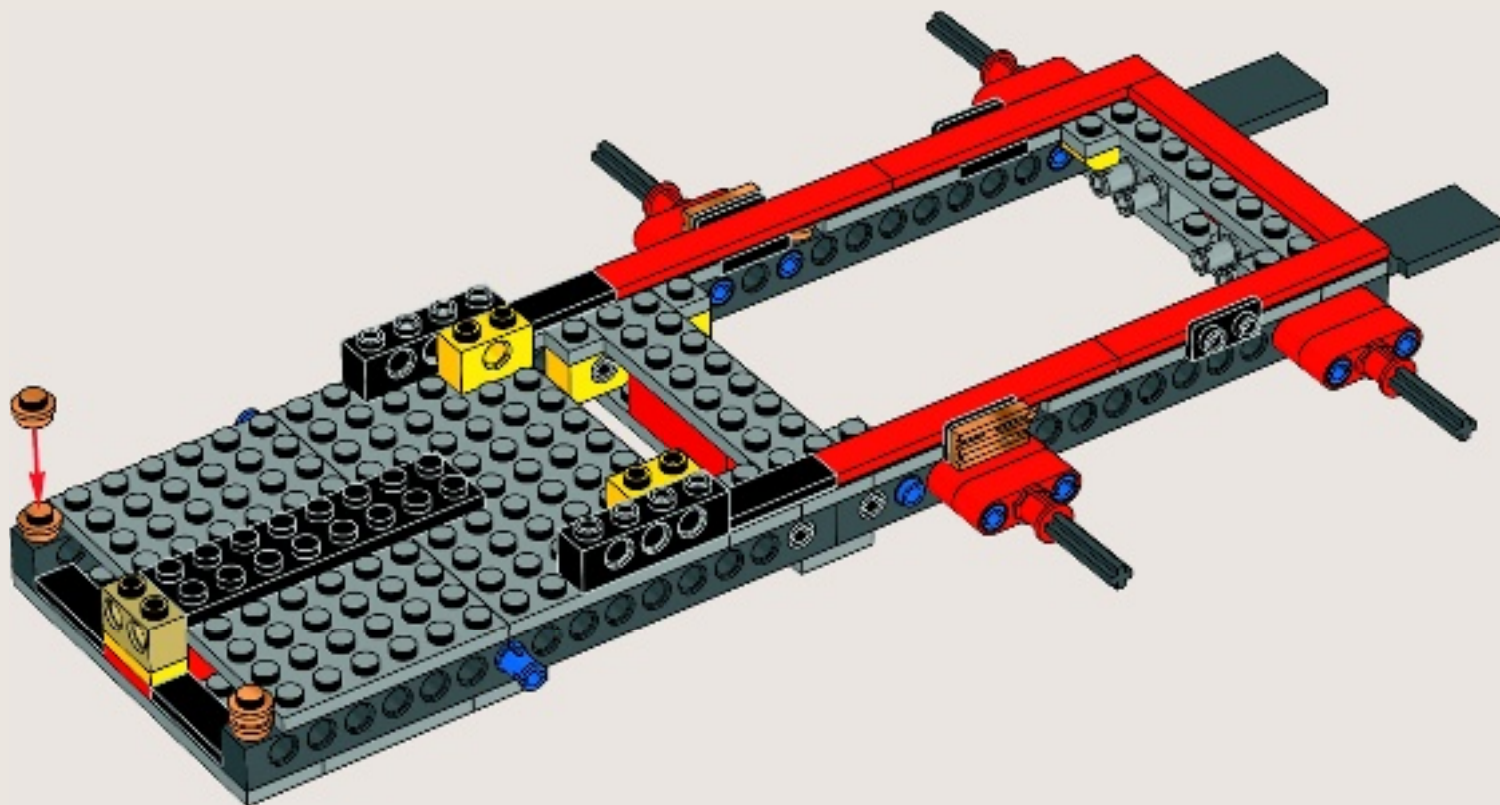

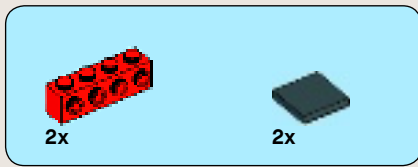

21

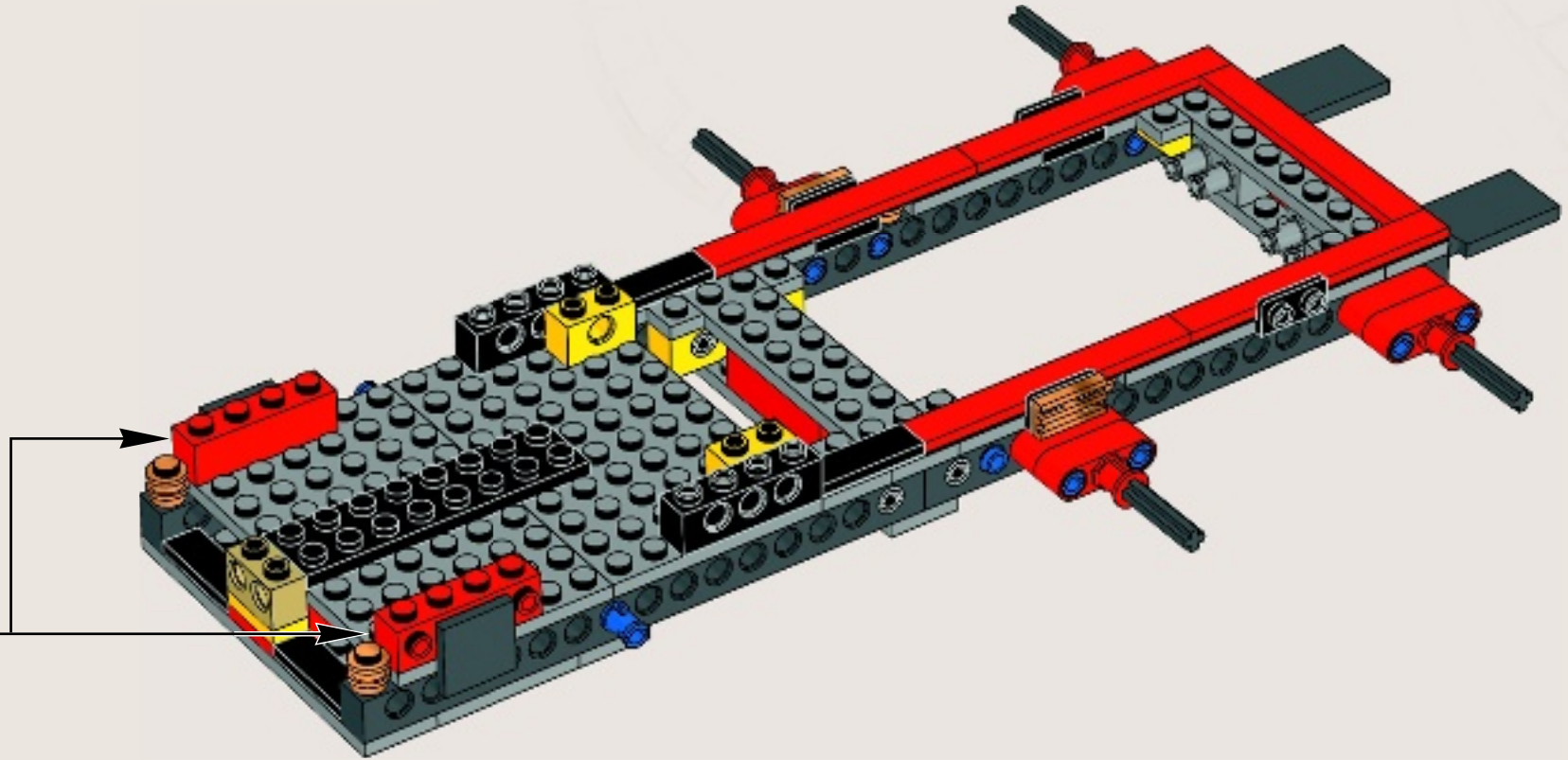
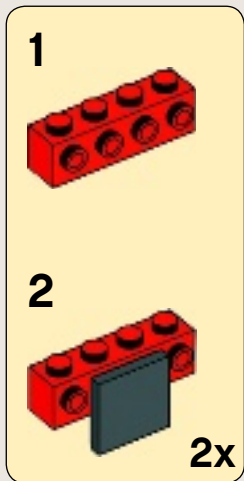

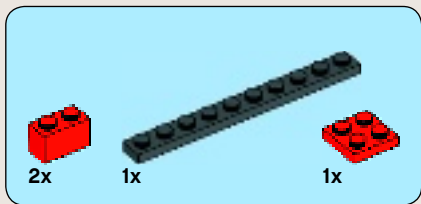

22

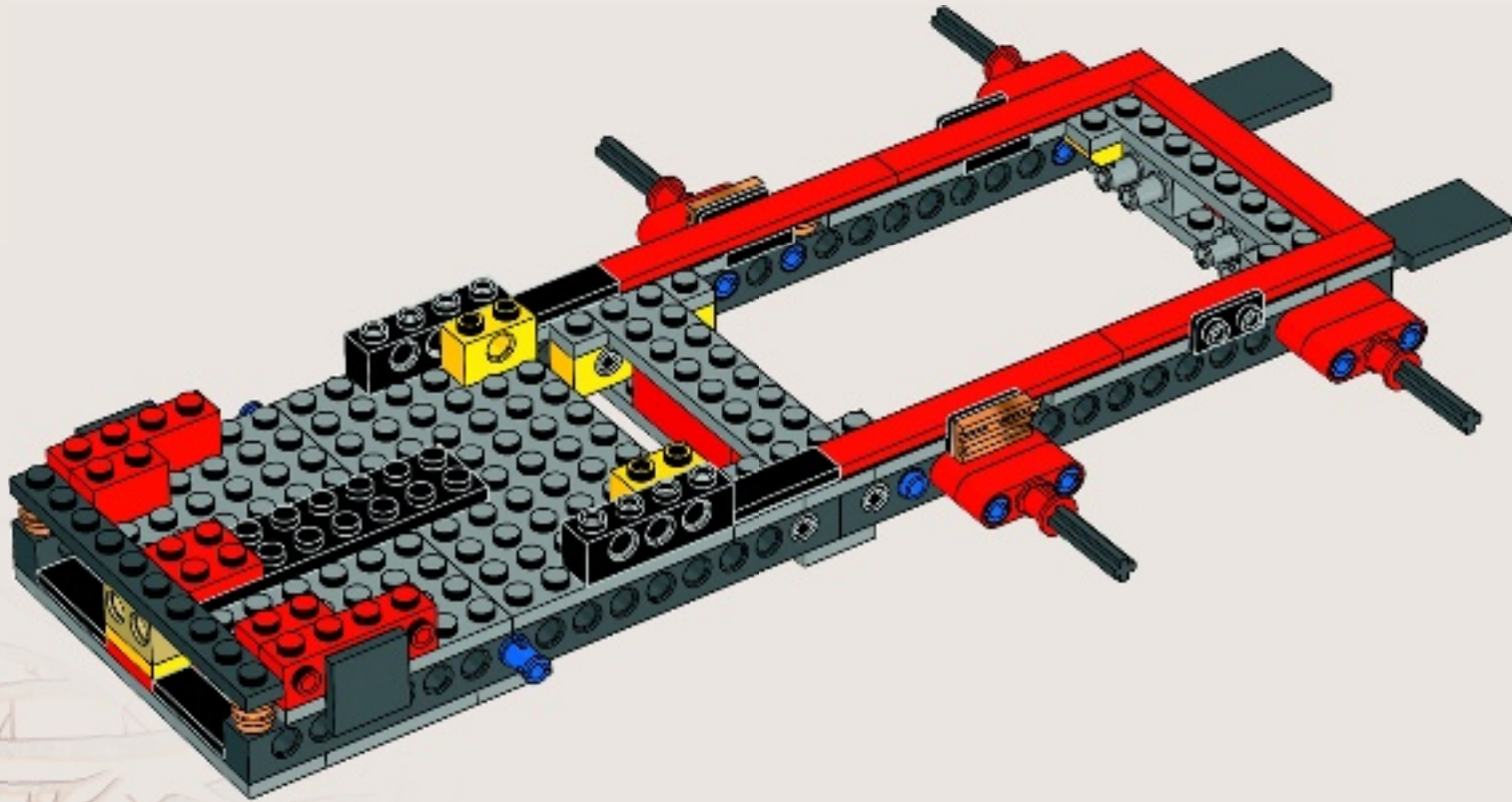



23

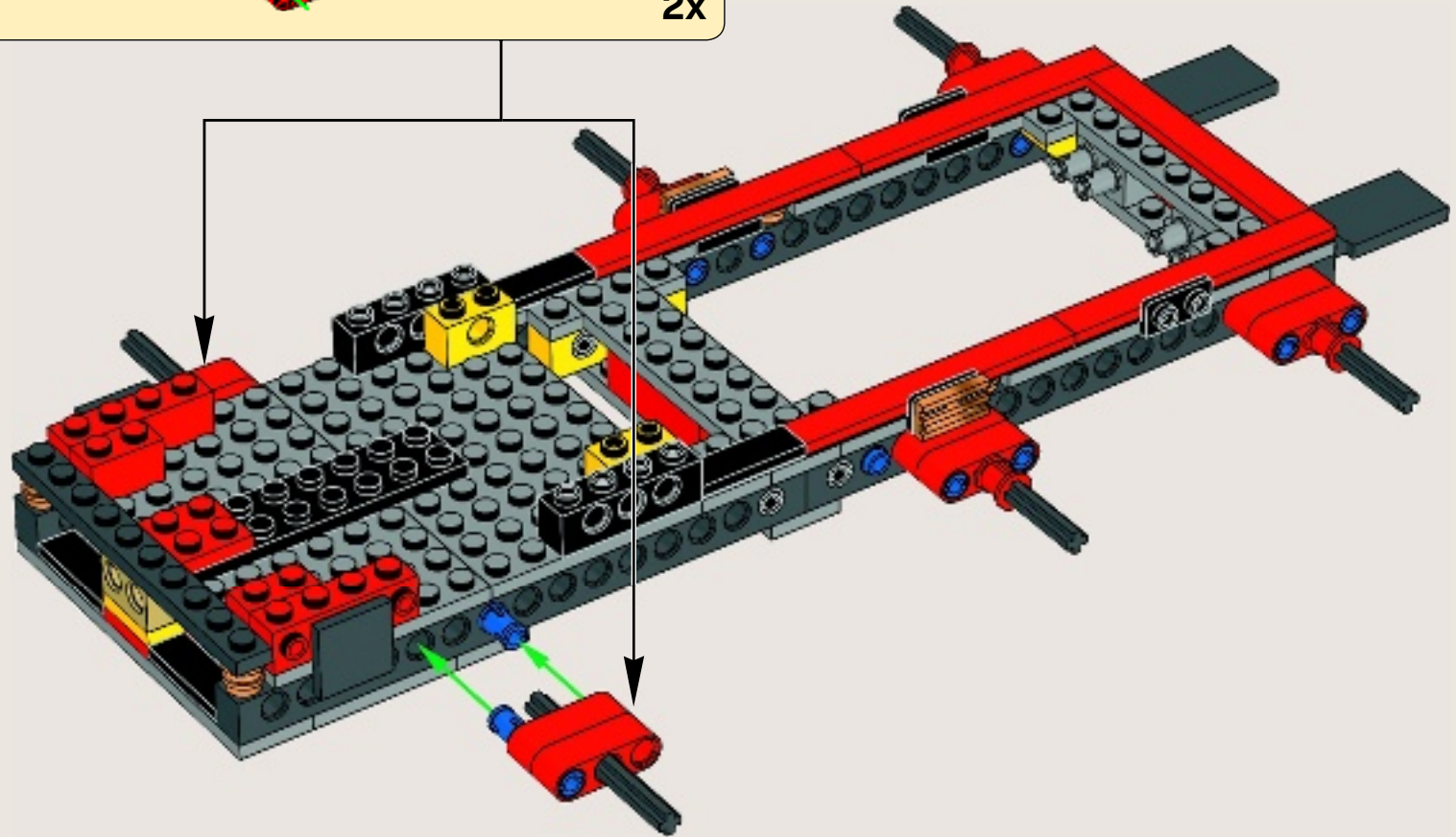
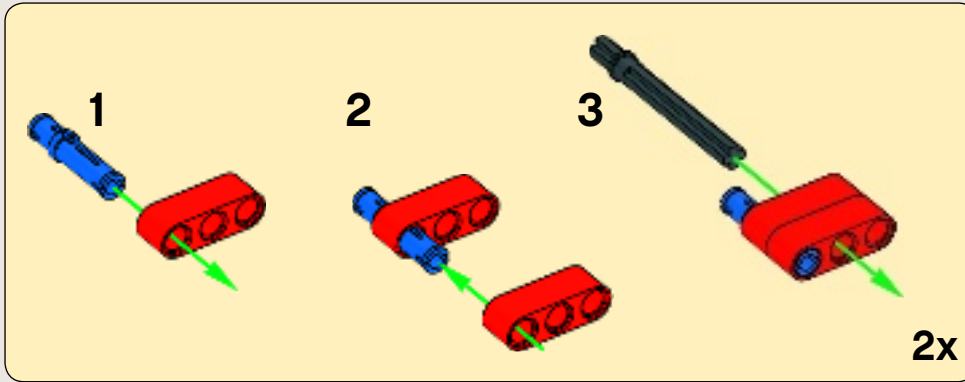

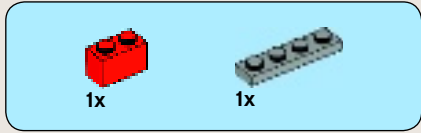

1

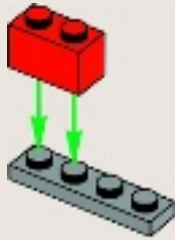

2

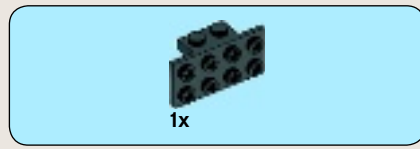
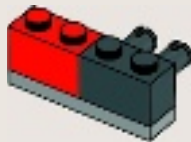

3



4

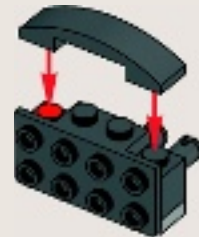



5

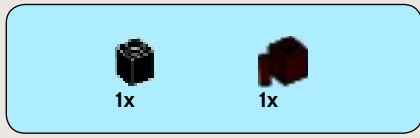
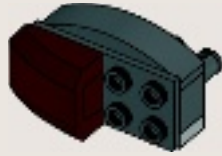

6

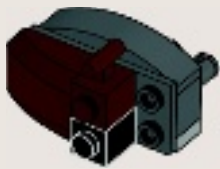

7

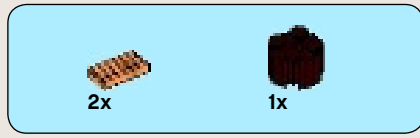
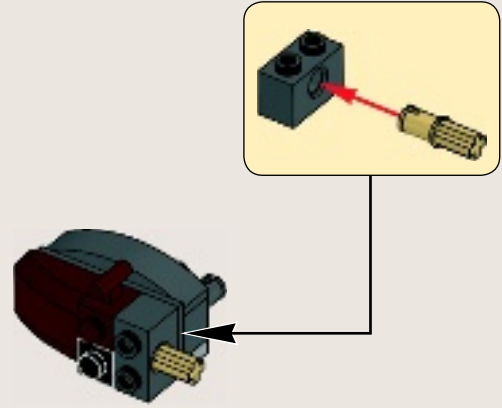

8

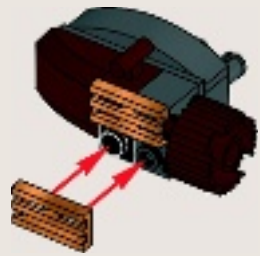

24

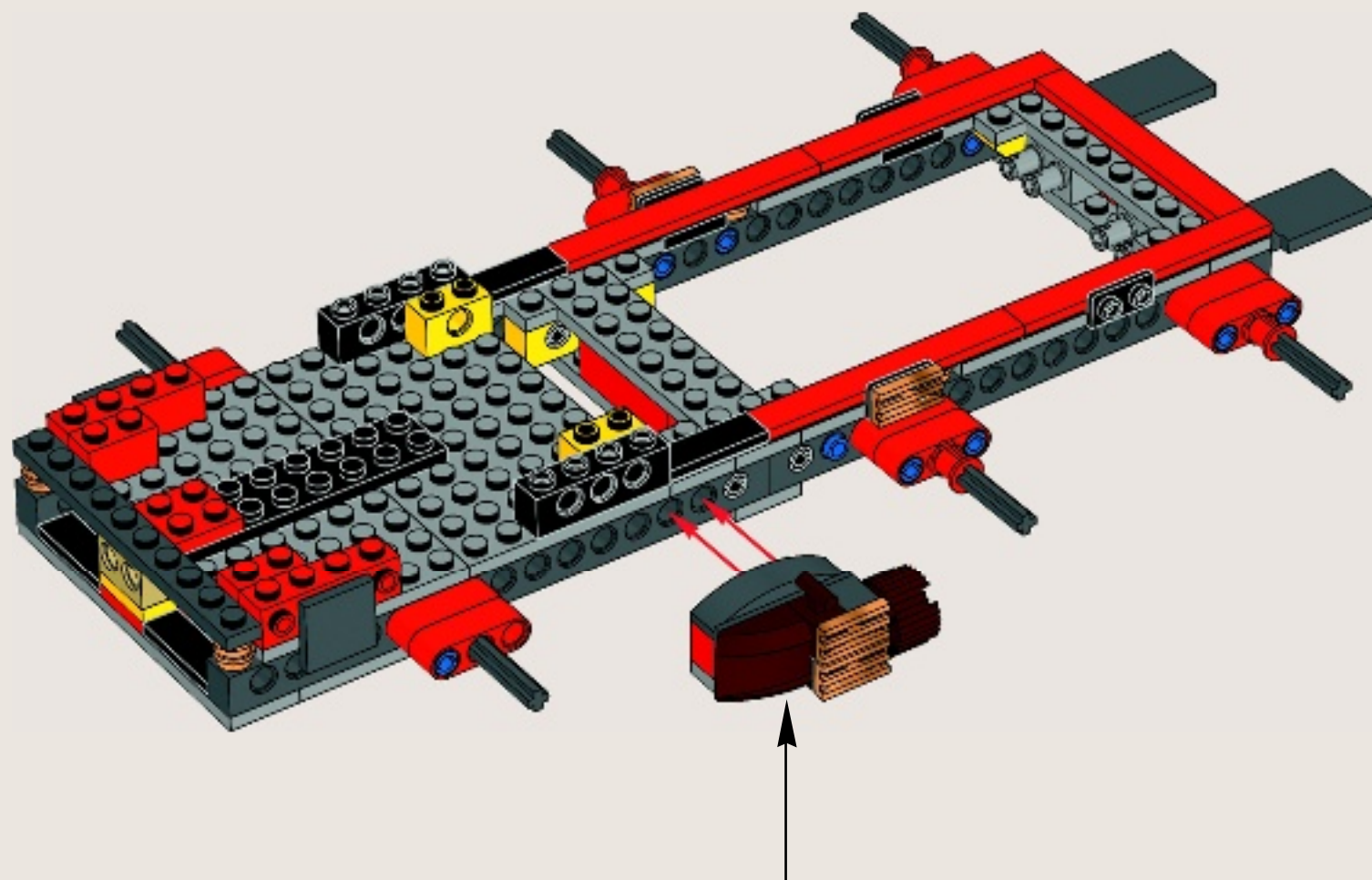



1

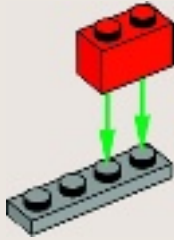

2

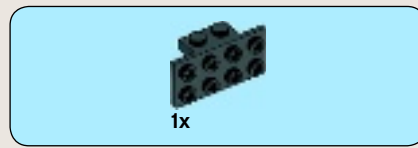
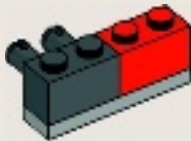

3



4

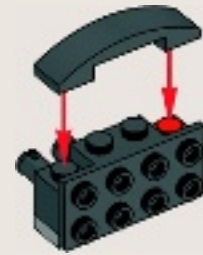



5

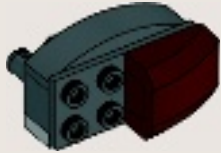

6



7

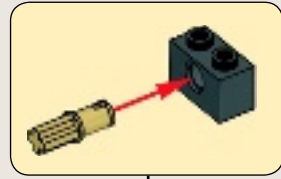

8

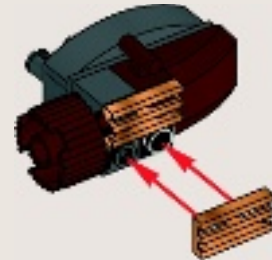

25

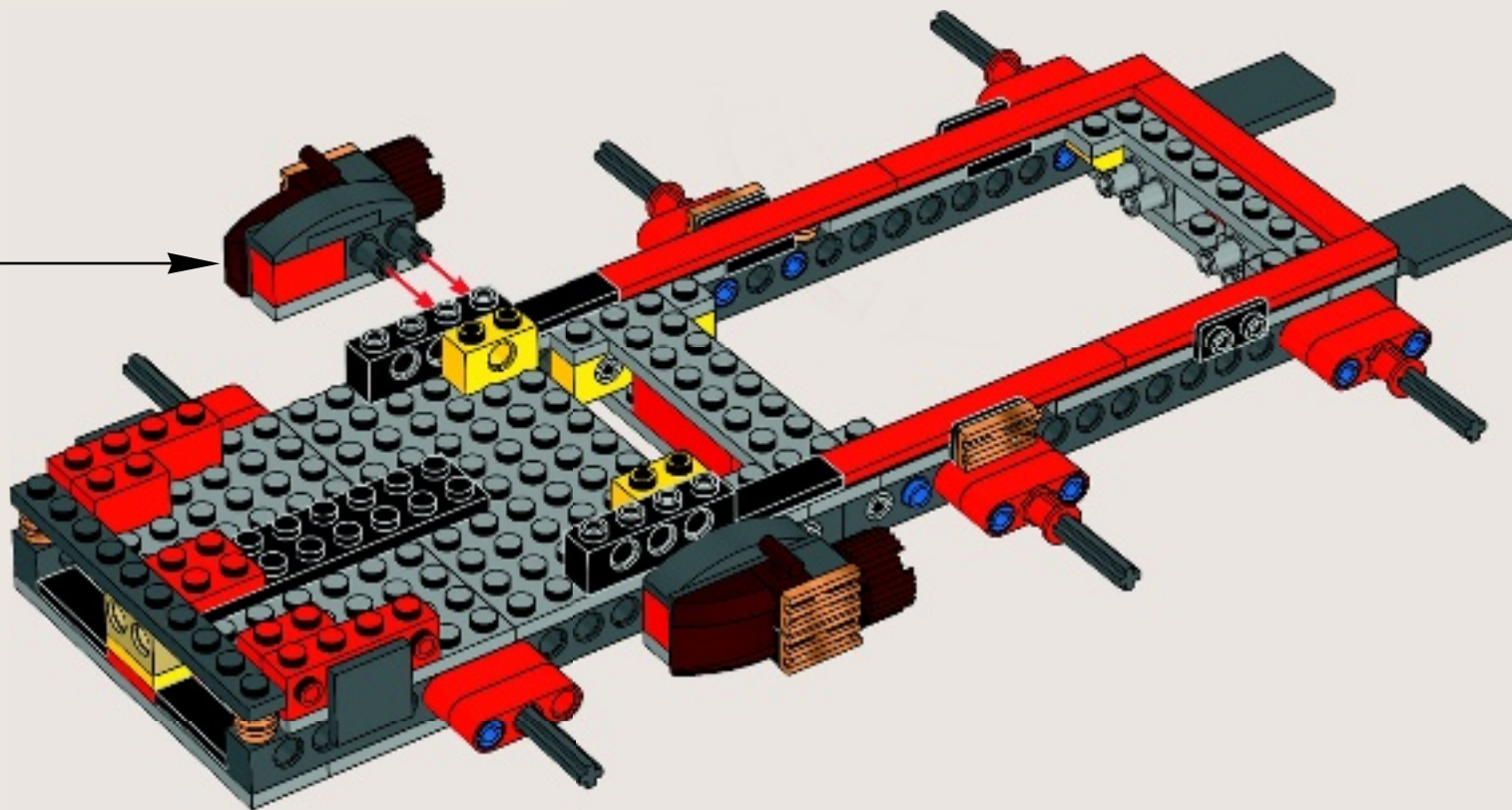

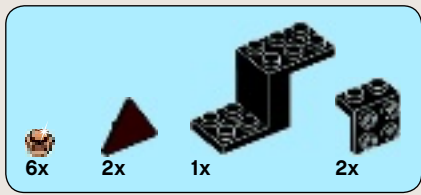

26

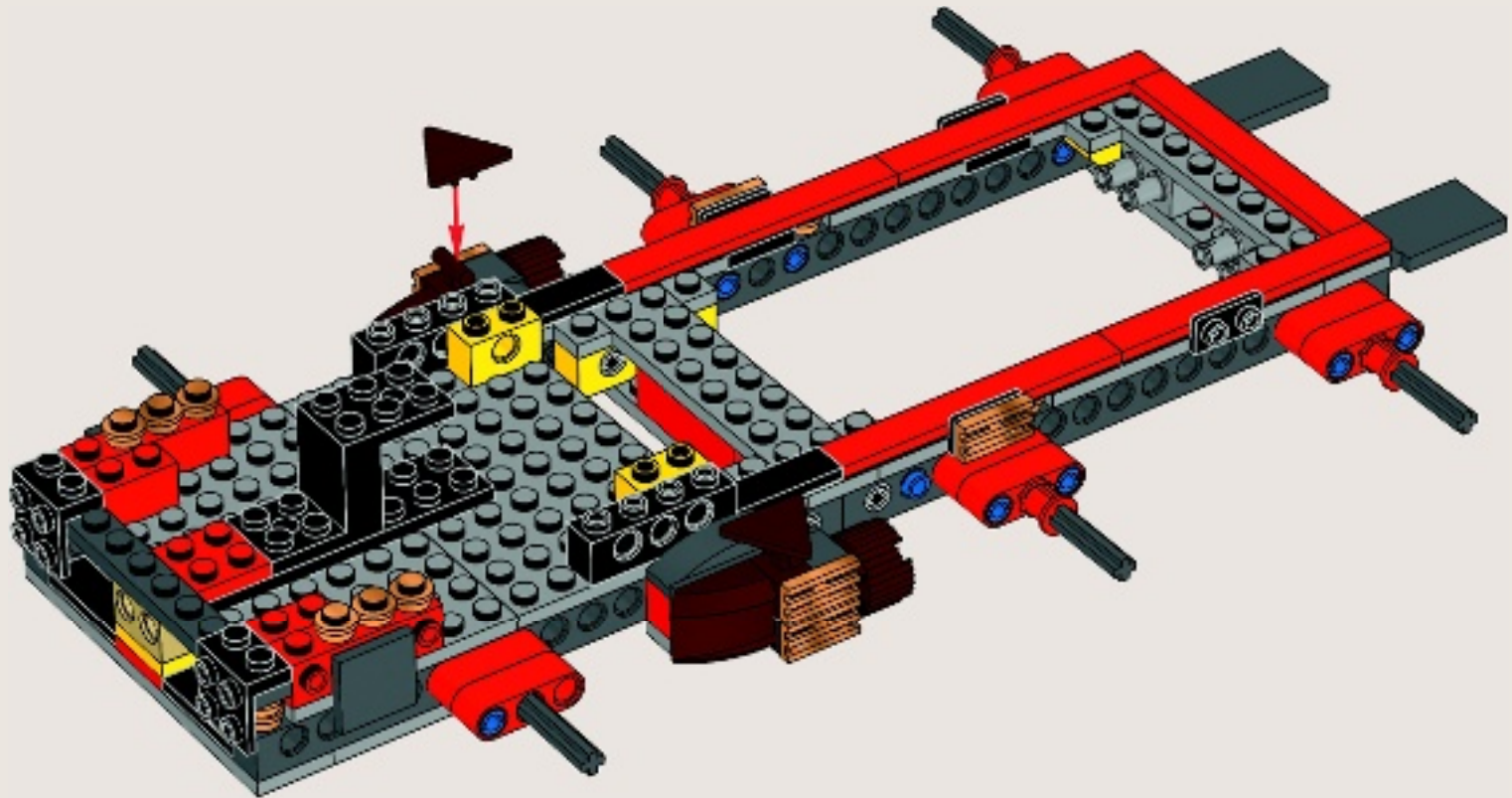



27

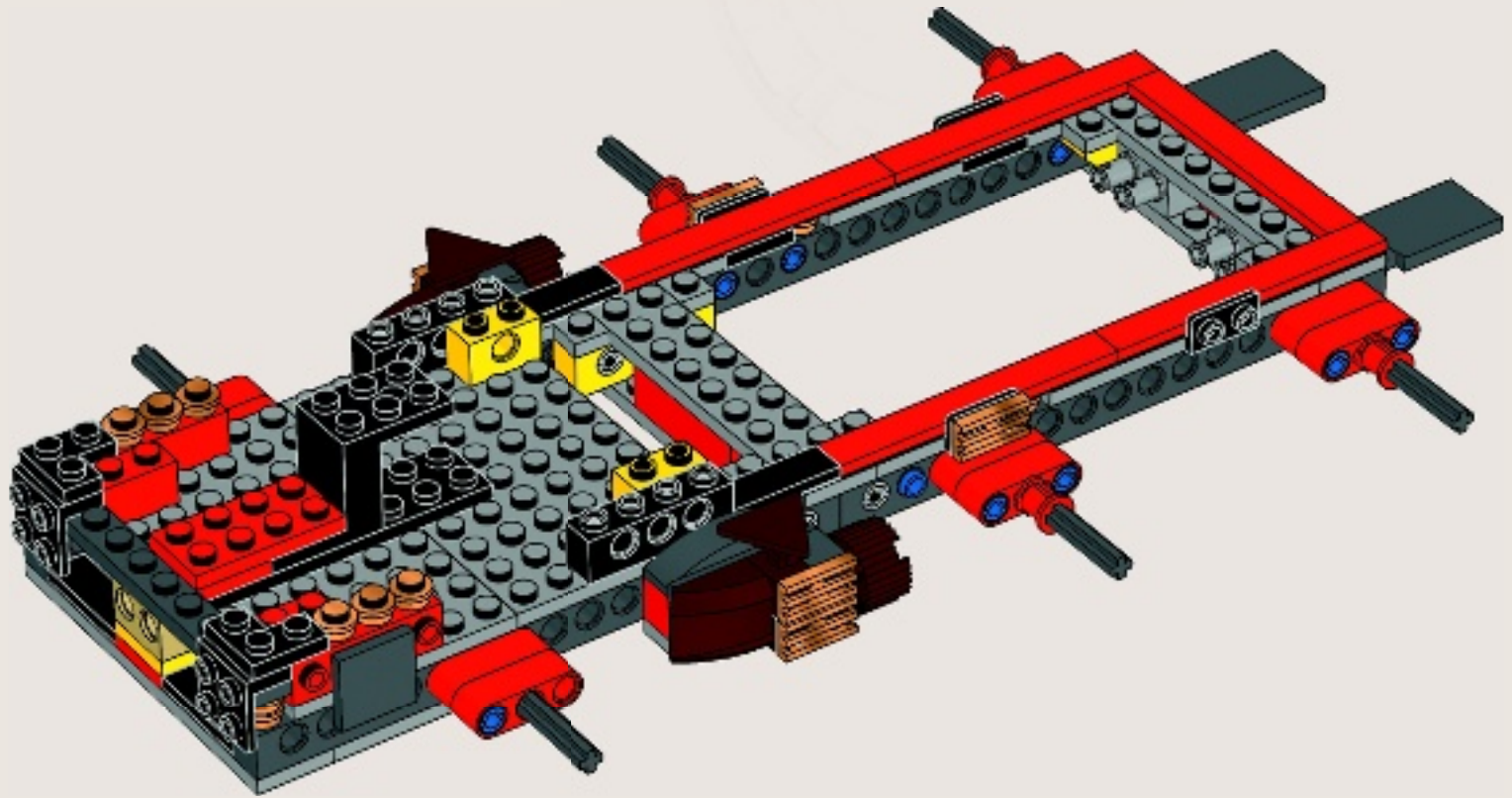

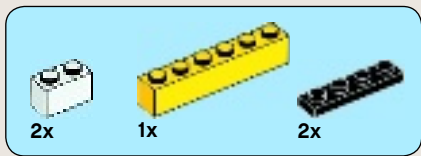

28

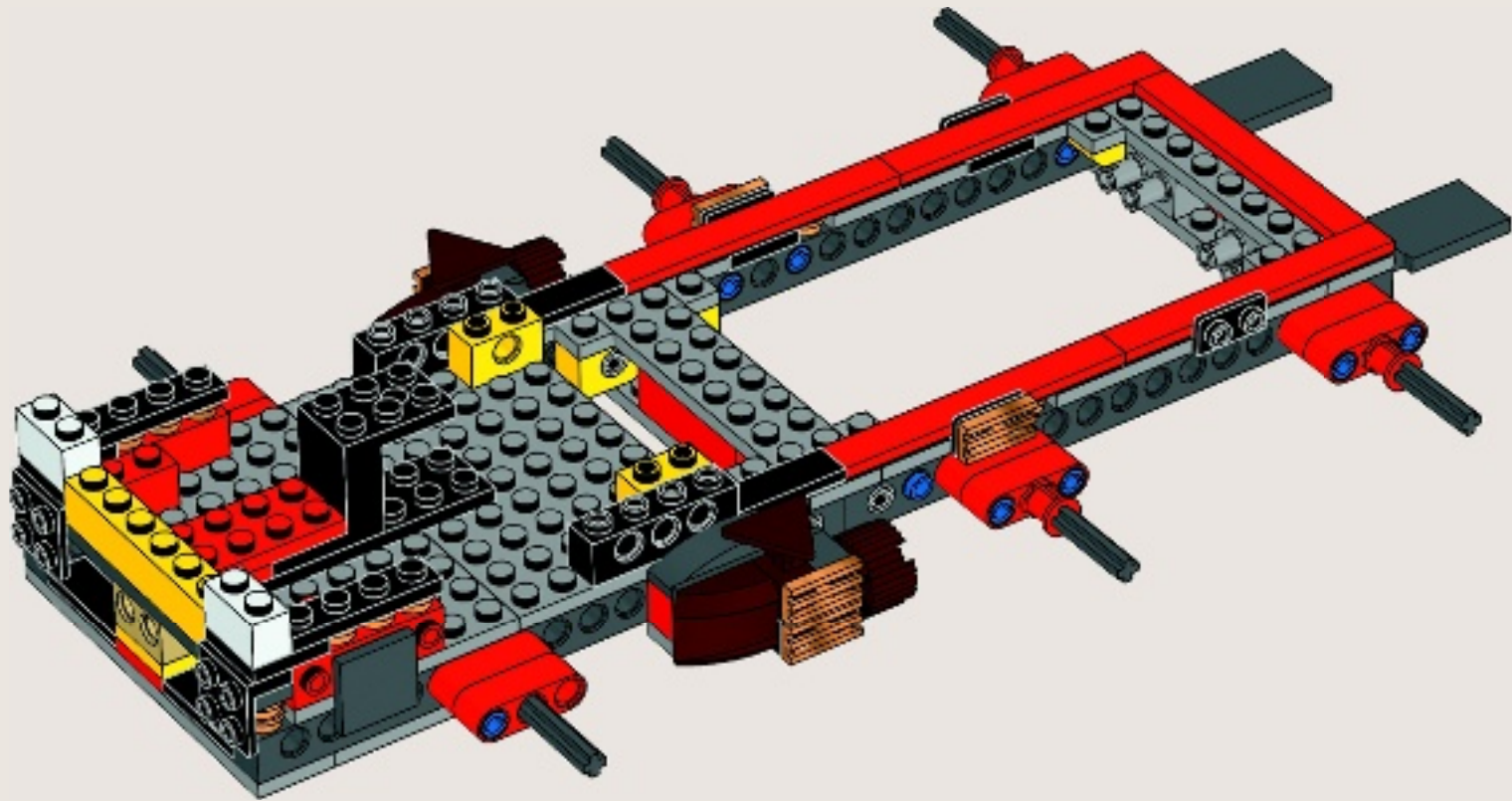



29

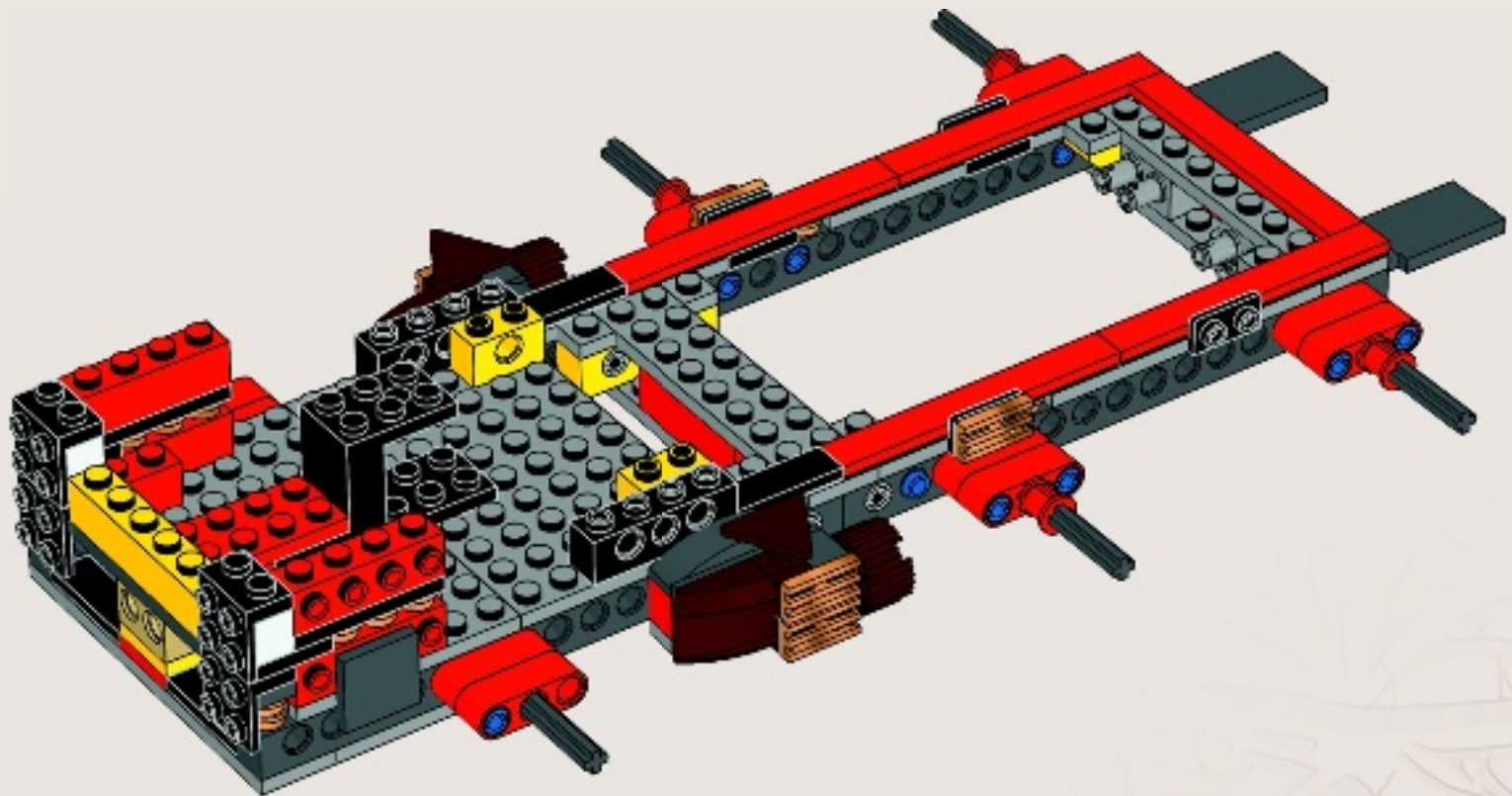



2x

30

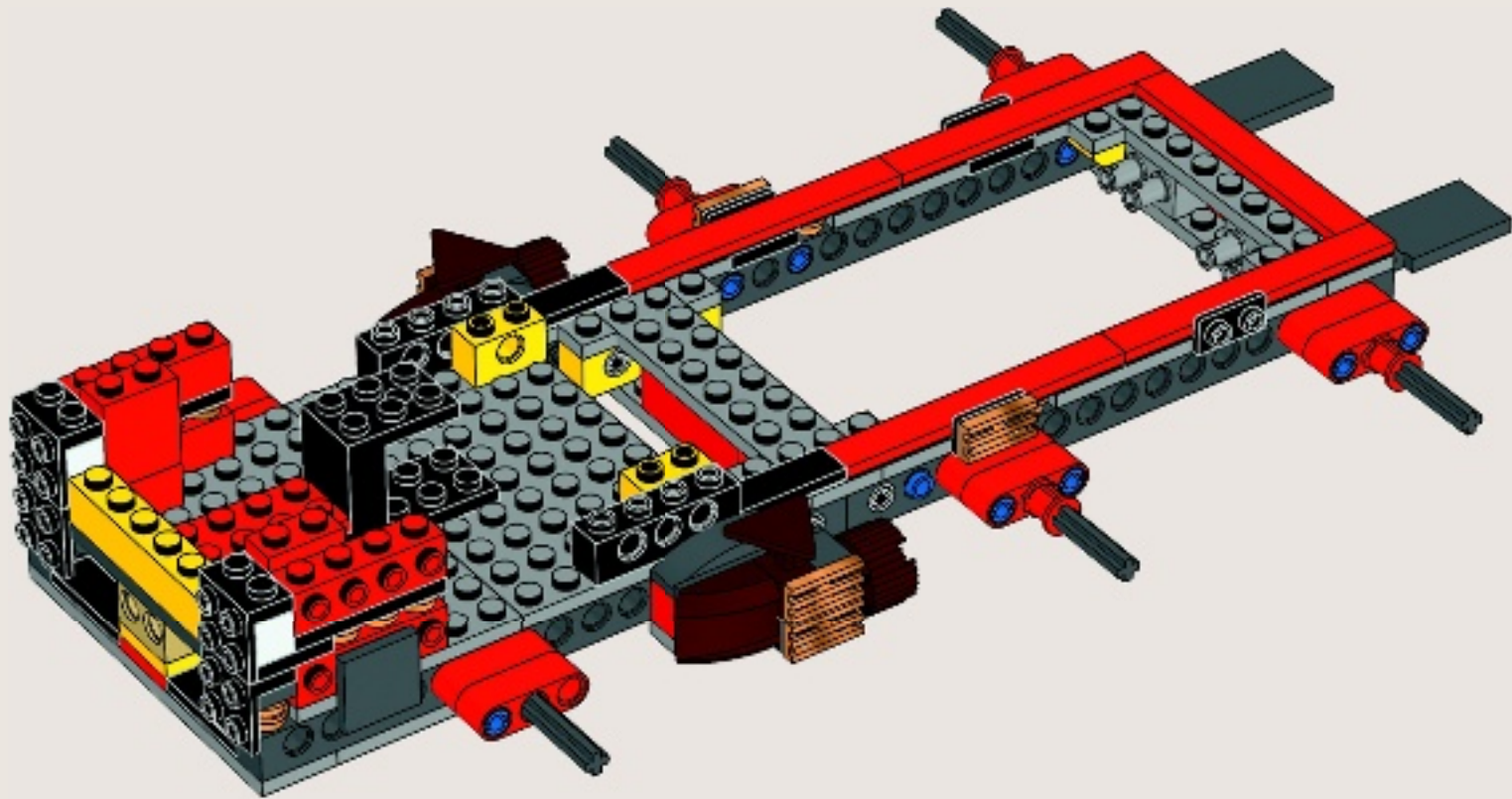



31

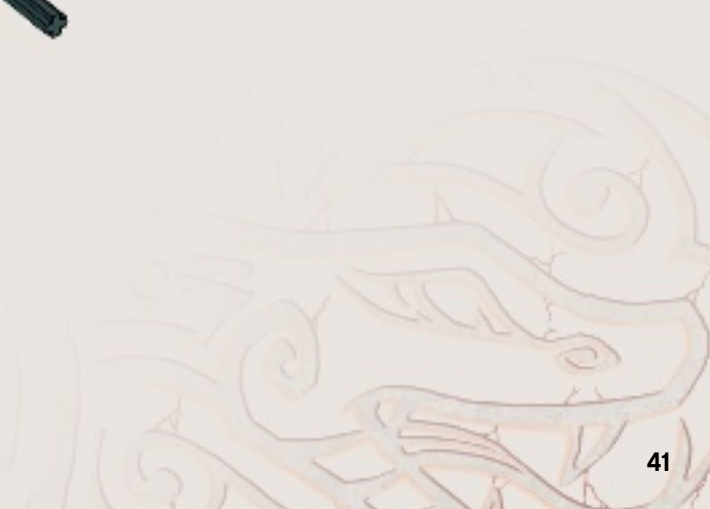
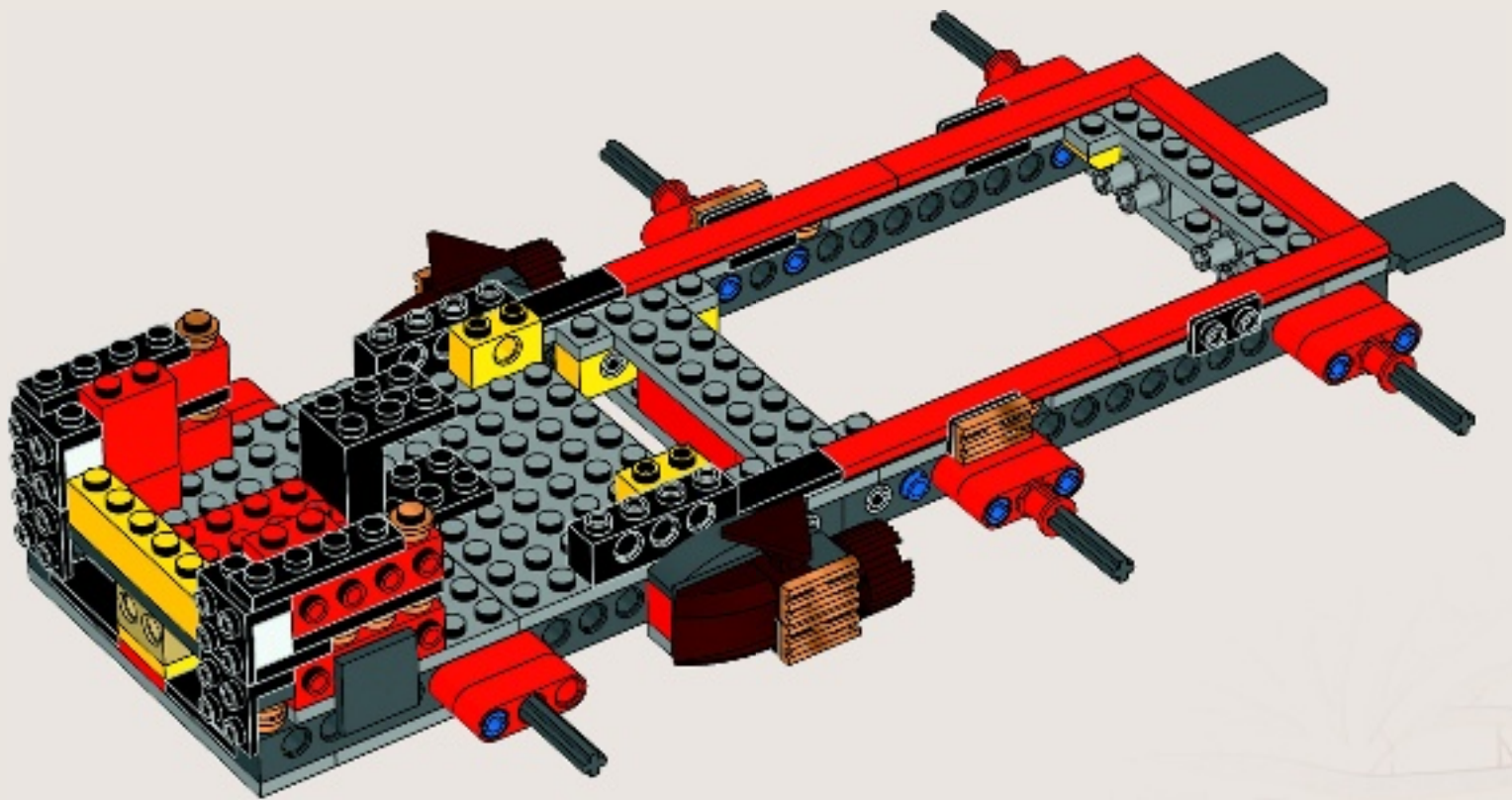



32

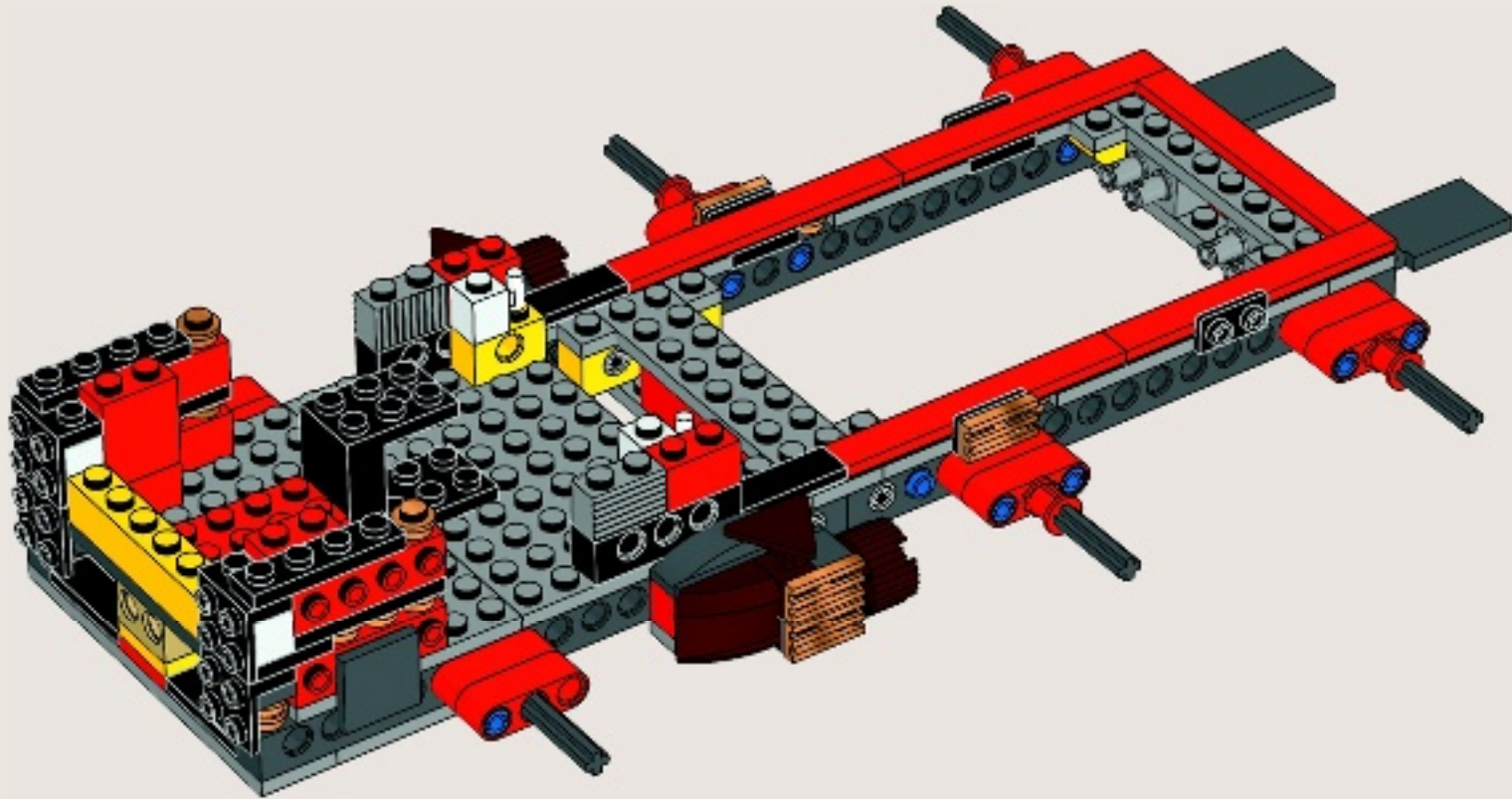



33

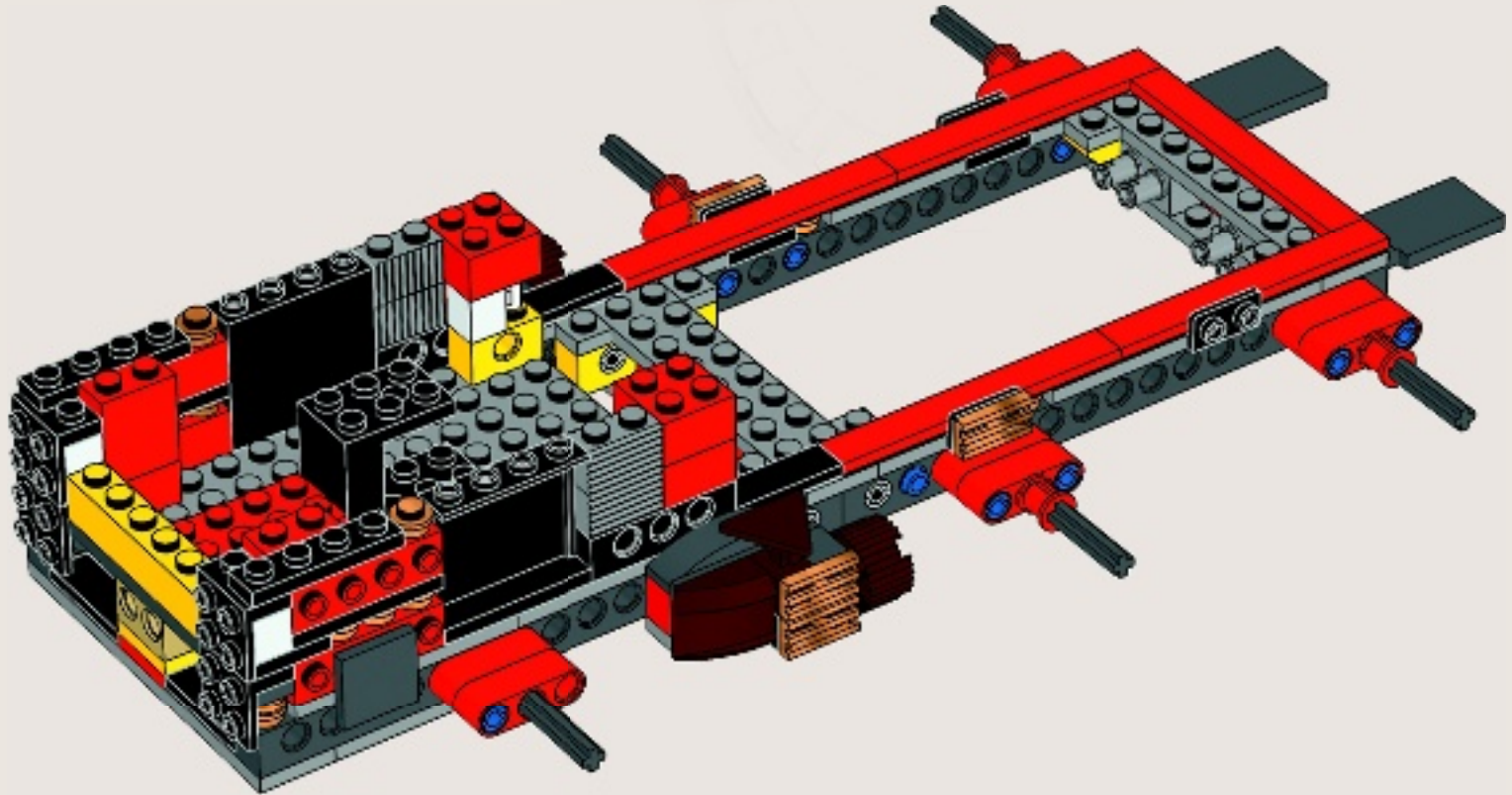



1

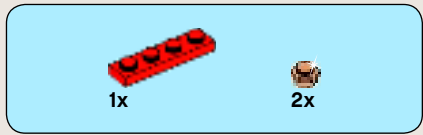

2





3



4



2x  2x 

5



34

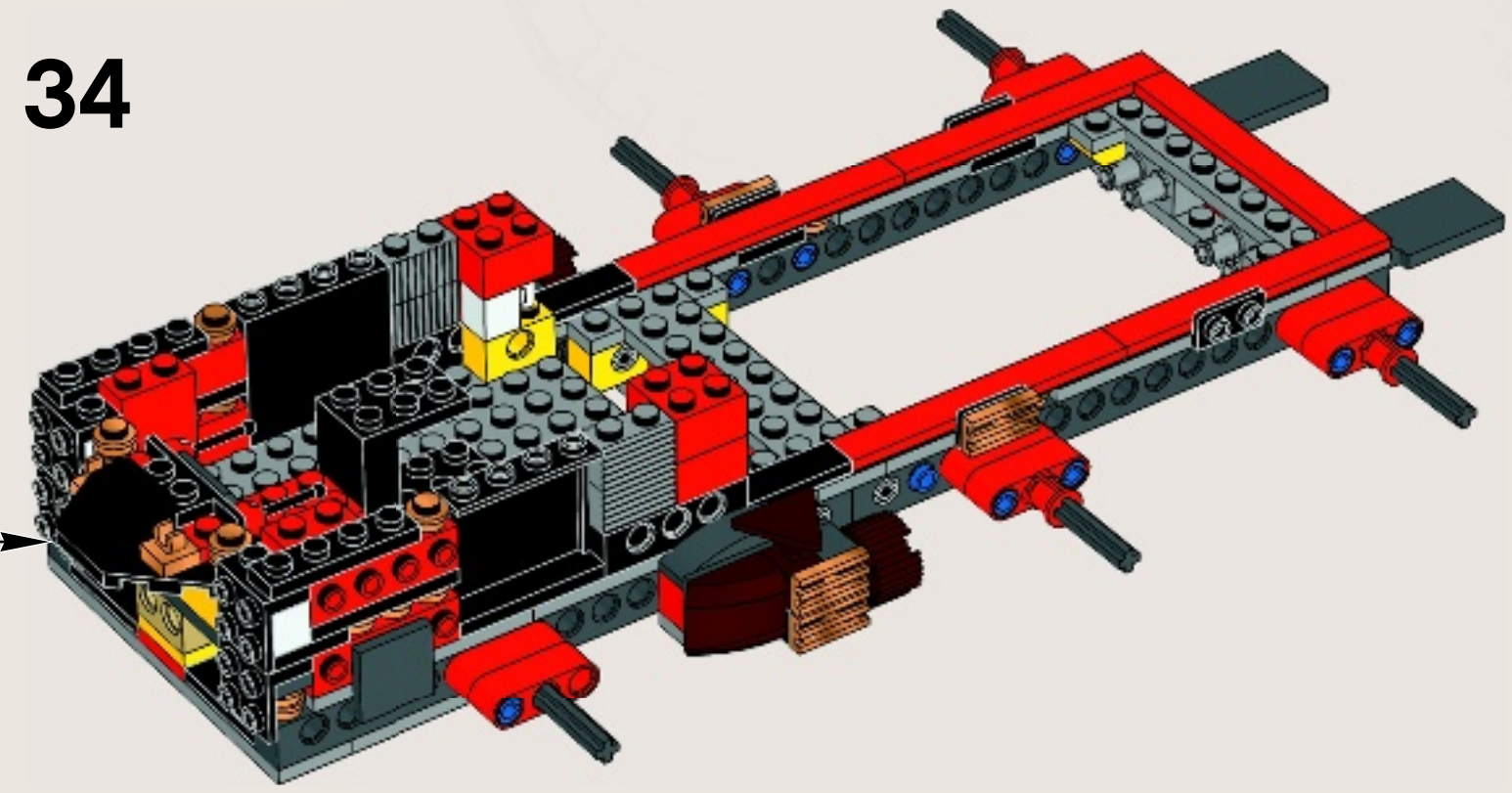



35

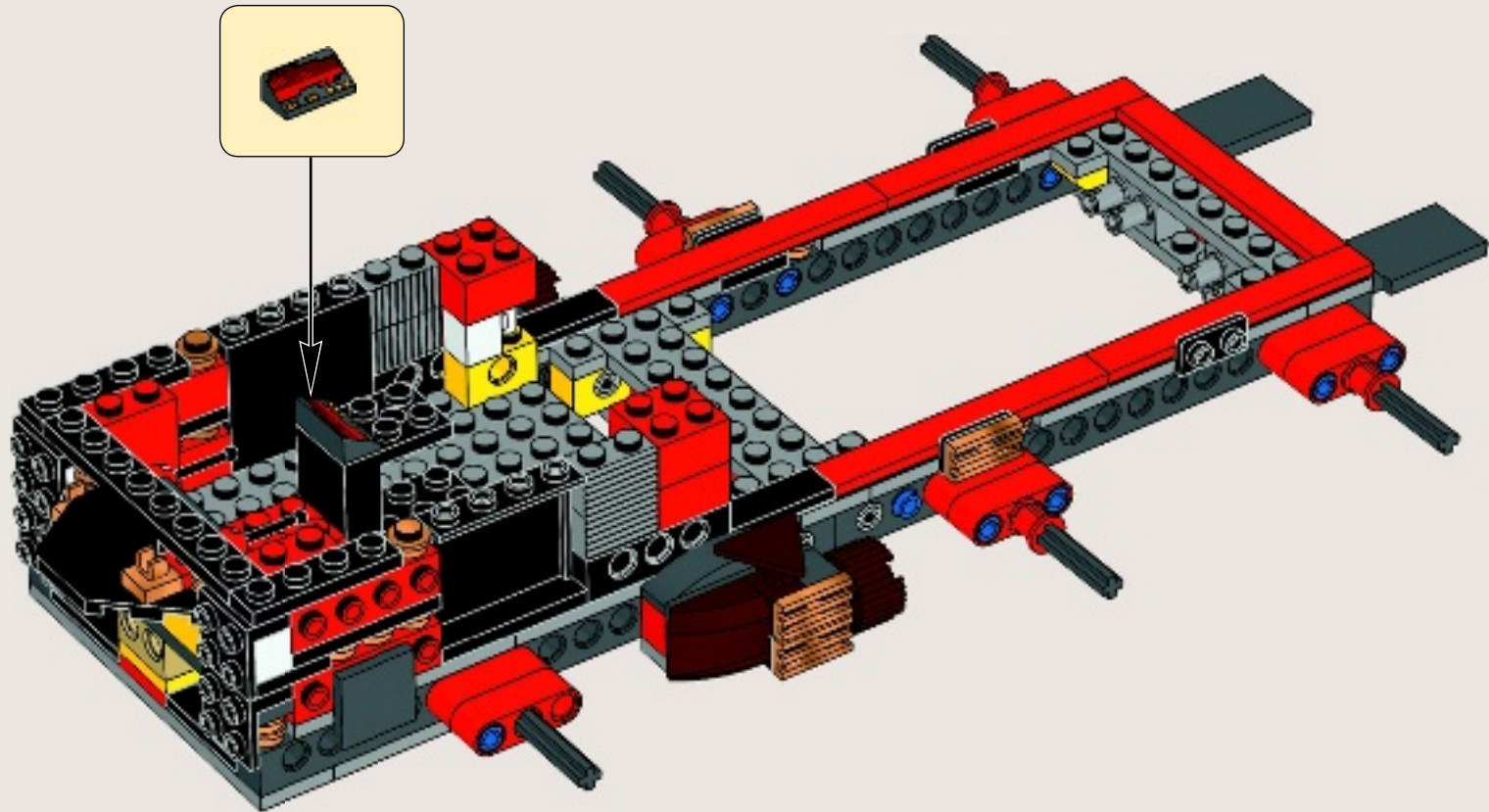

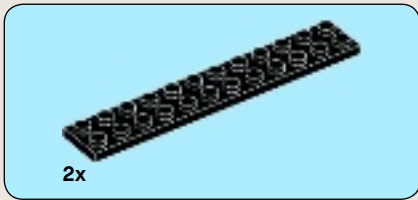
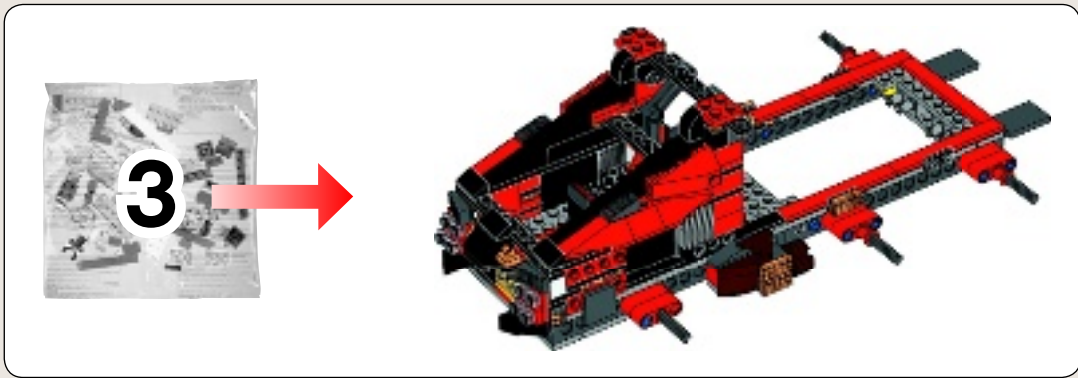



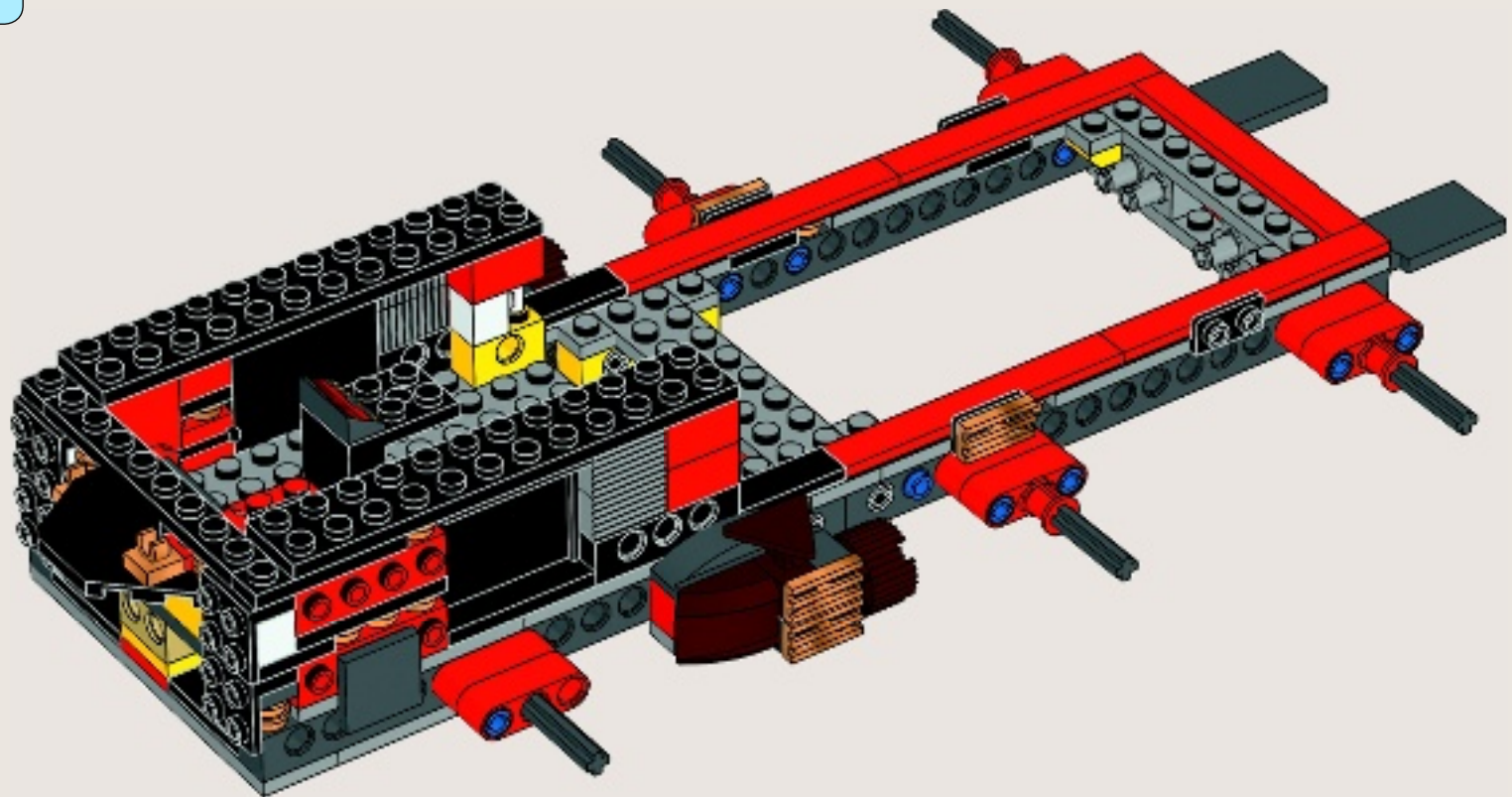

36



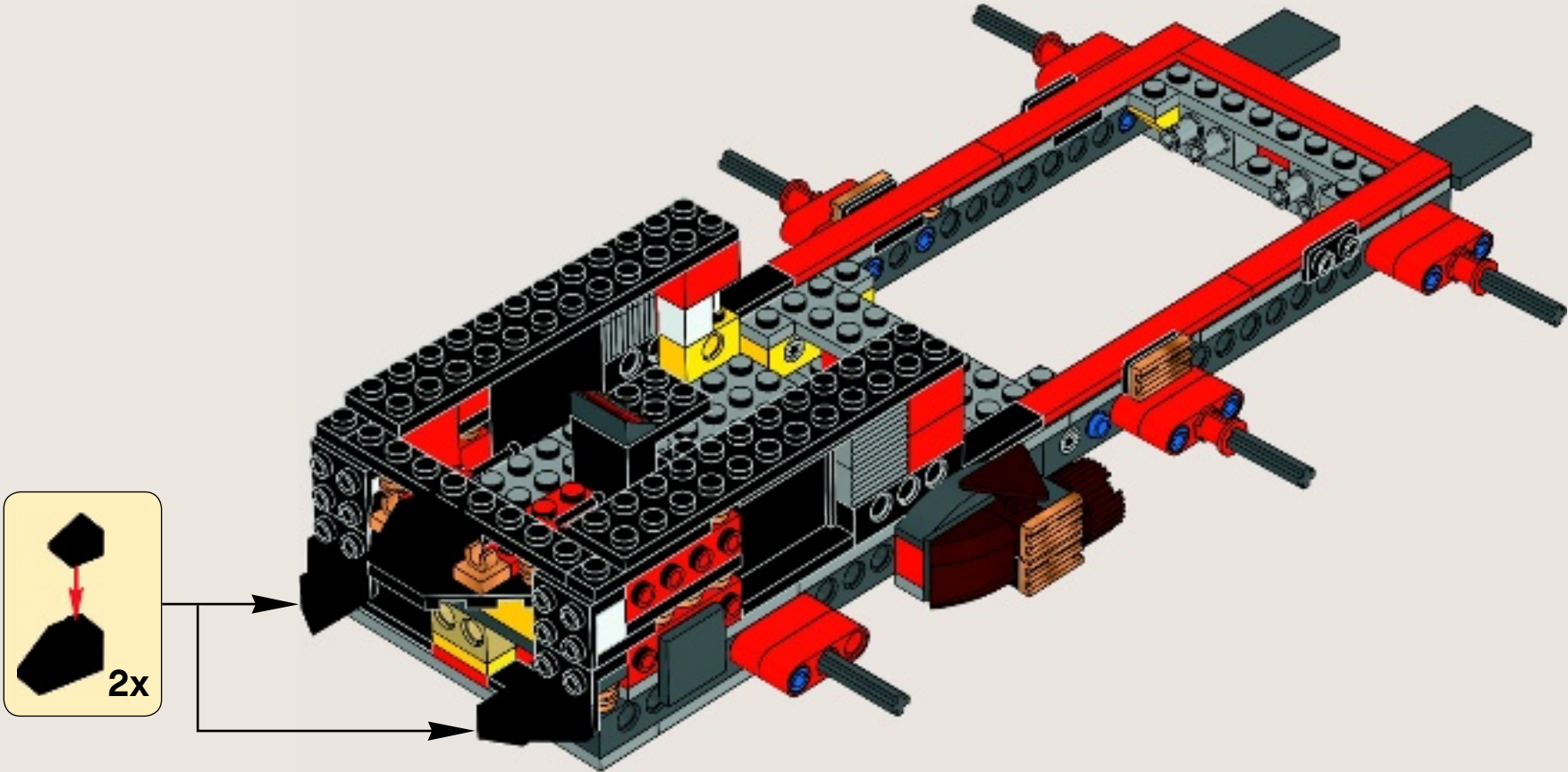





37



 2x
 2x
 8x

38

1

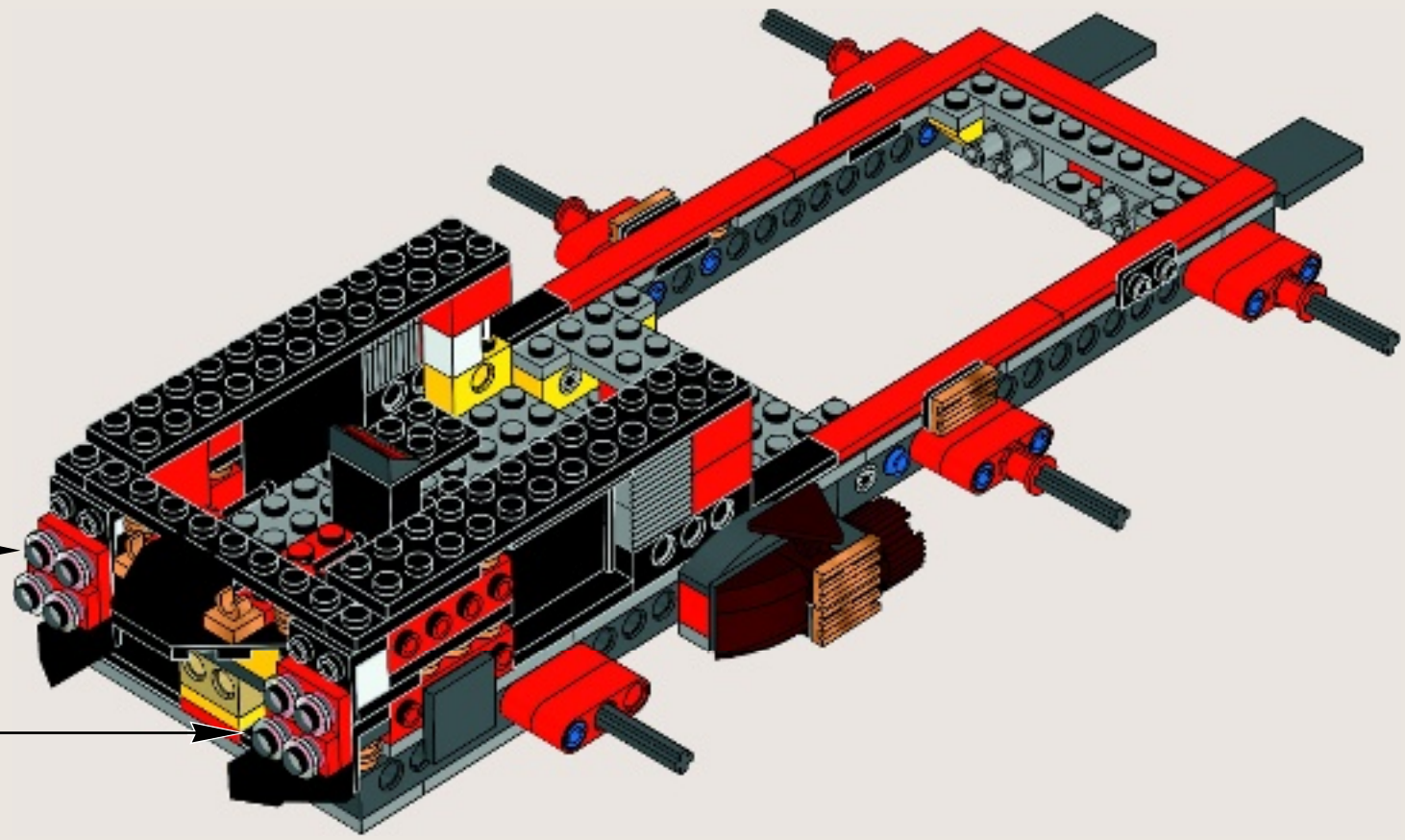
2

3

 2x

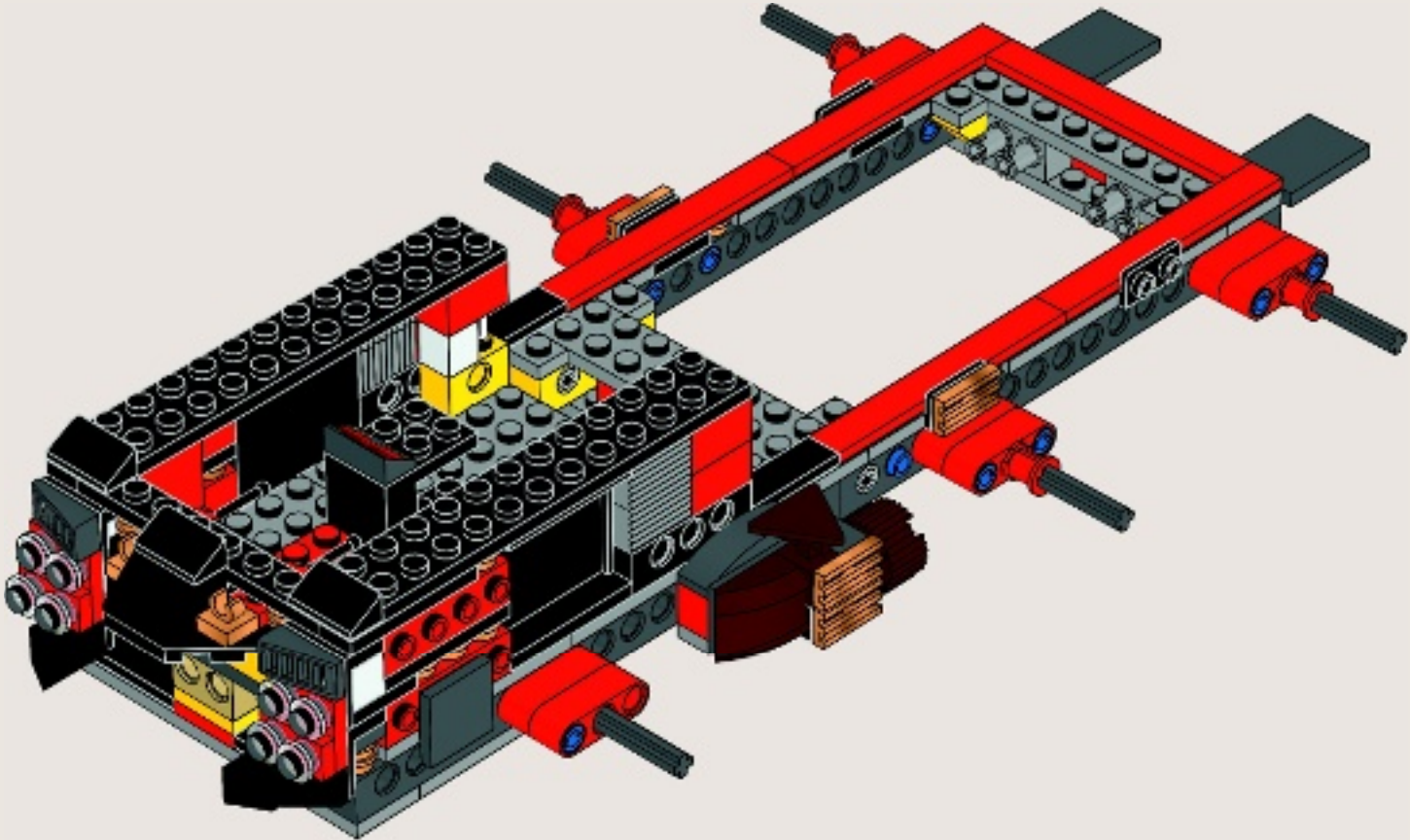

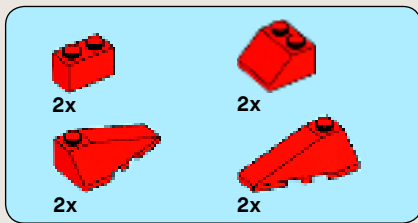
2x  3x 

39





40

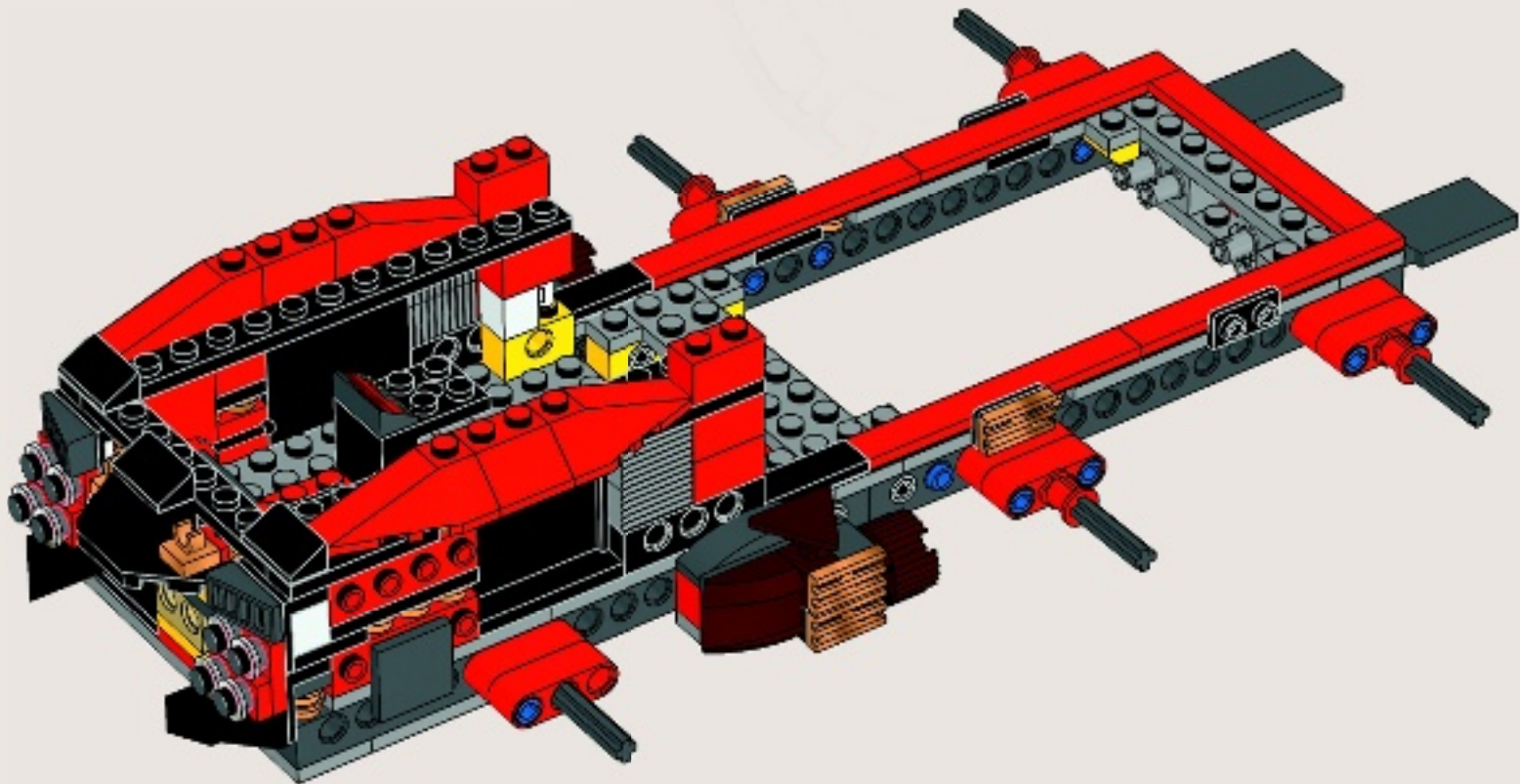

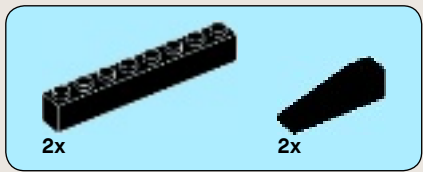

41

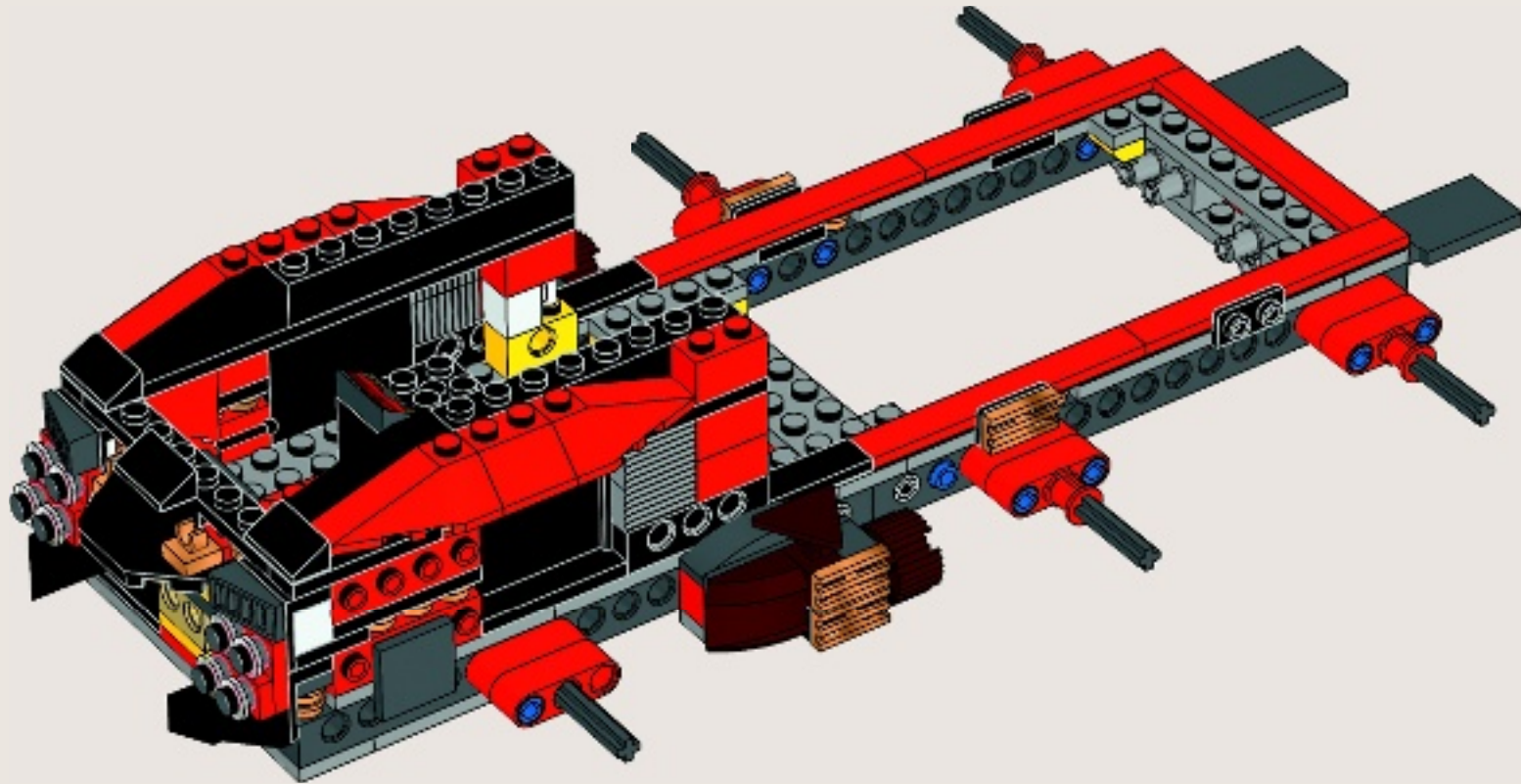



42

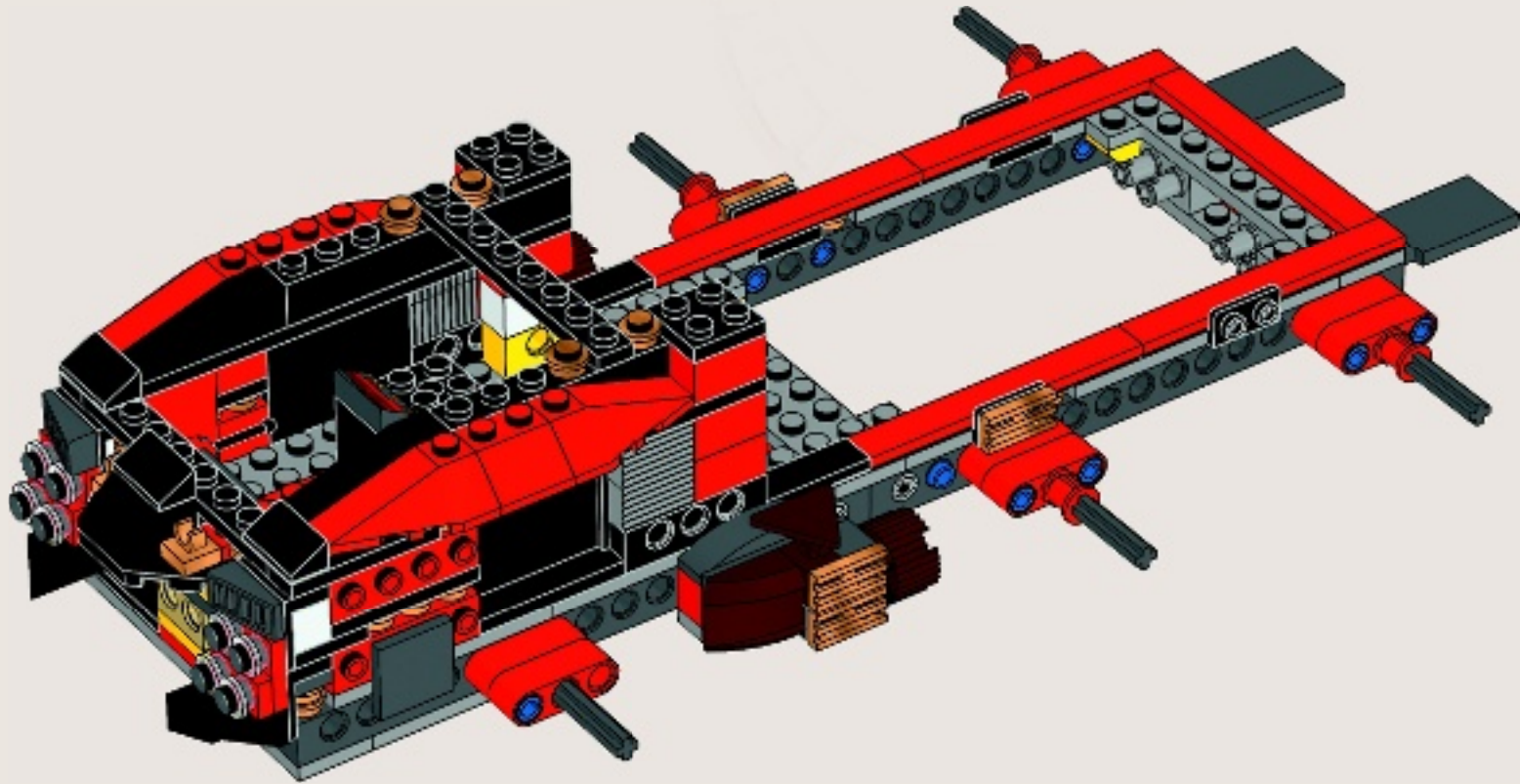

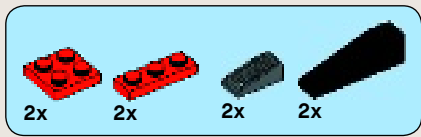

43

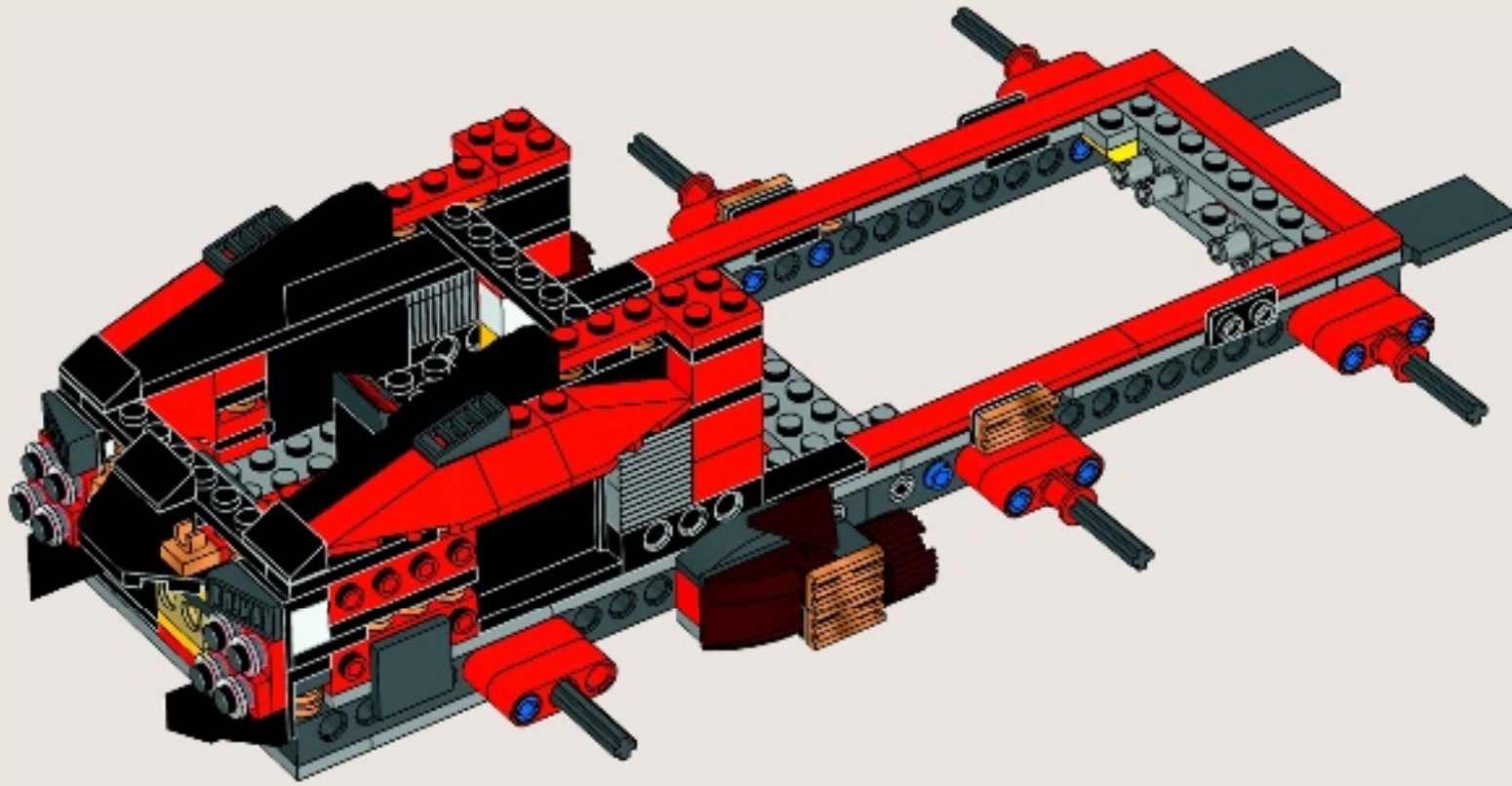



44

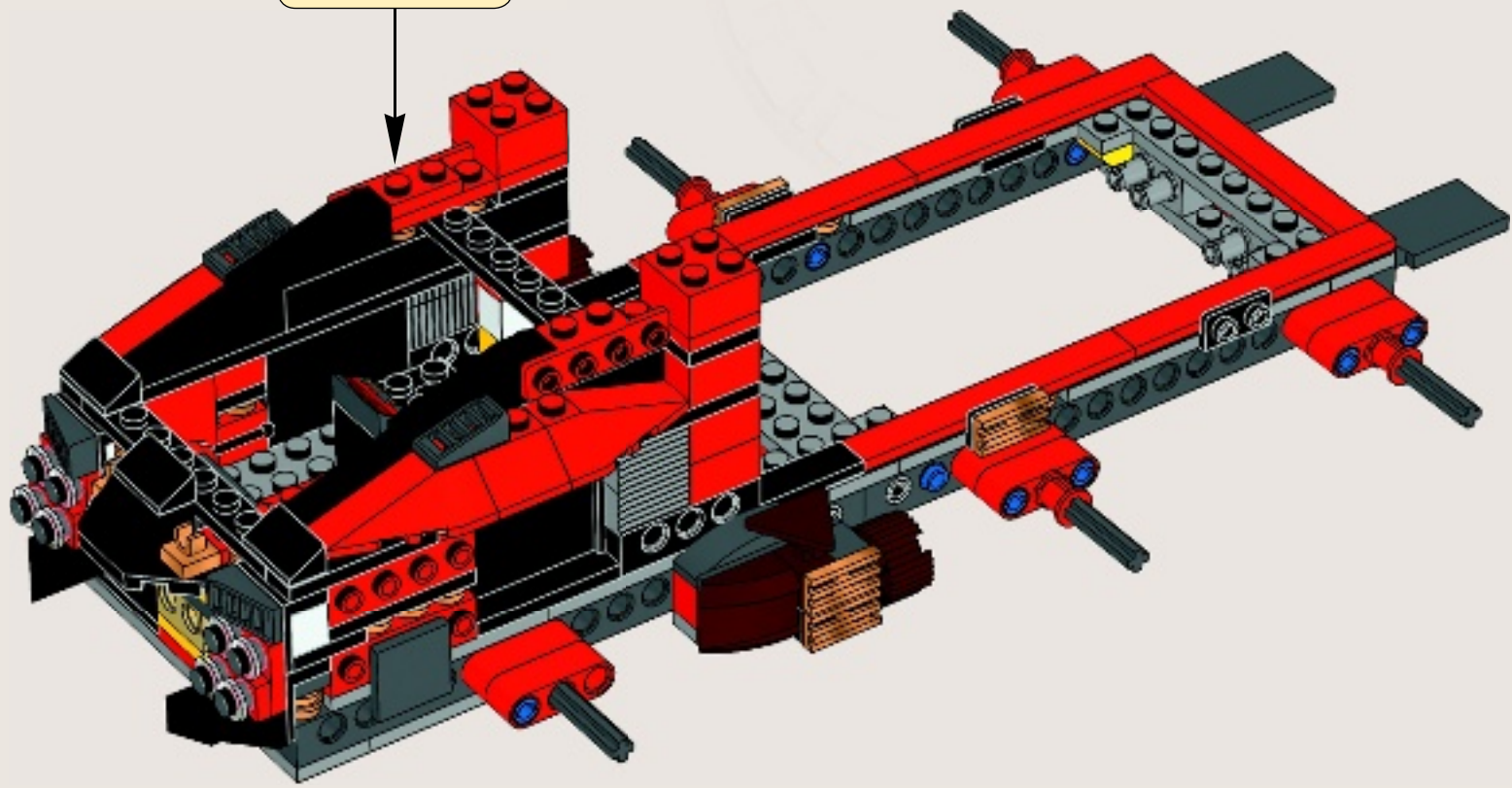



45

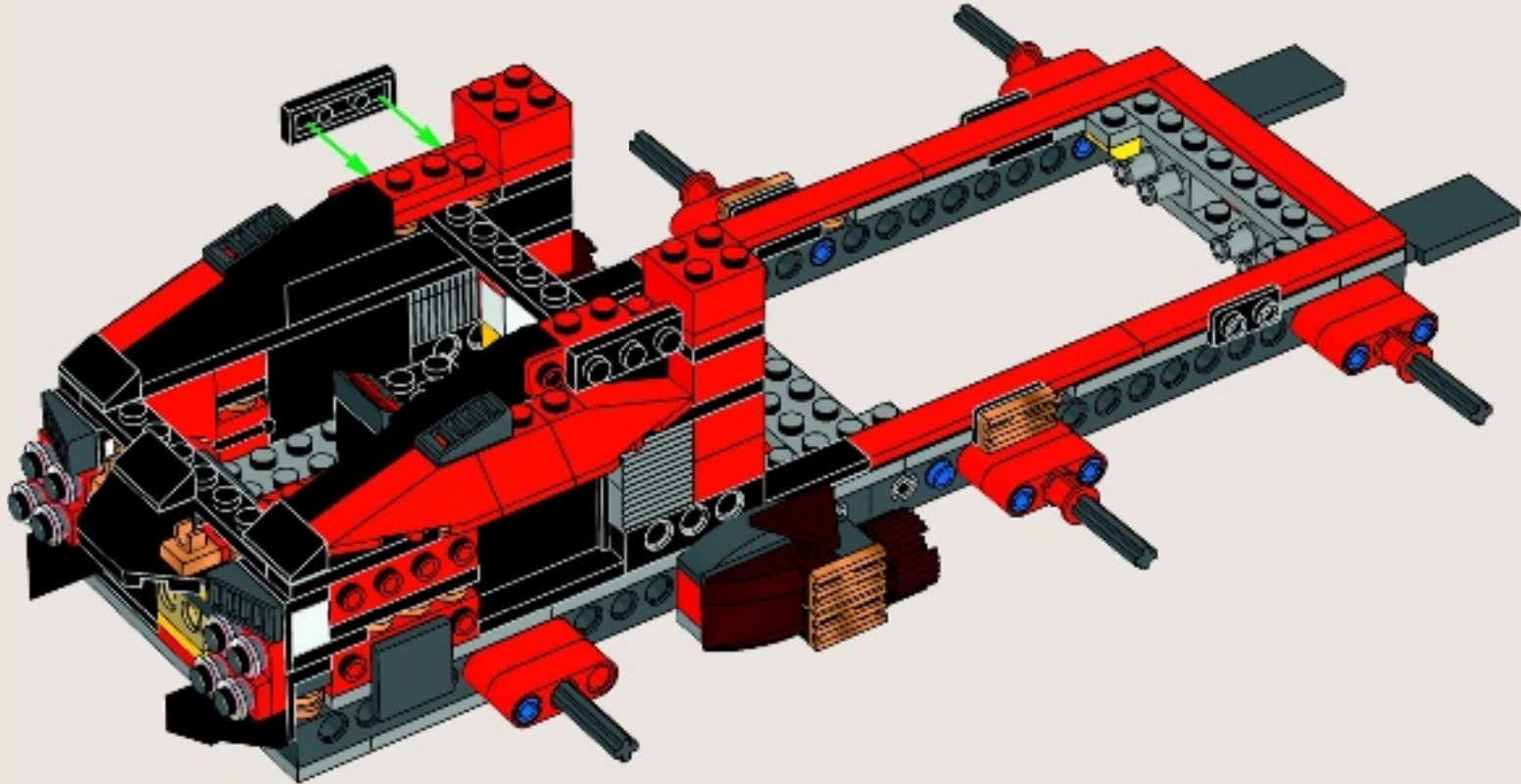

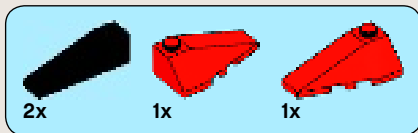

46

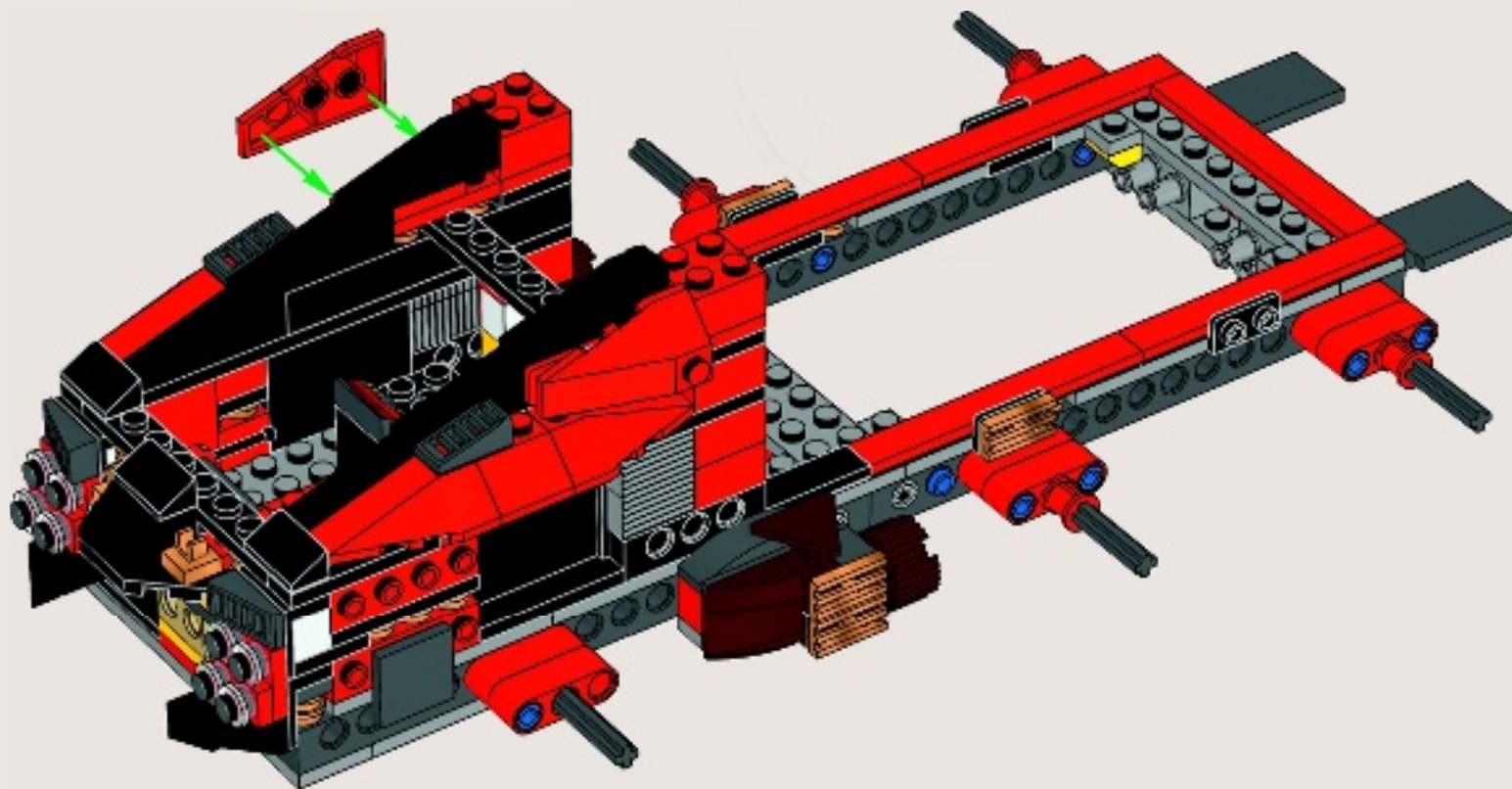

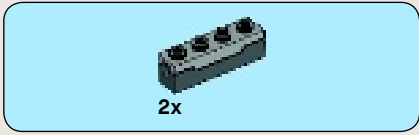

1

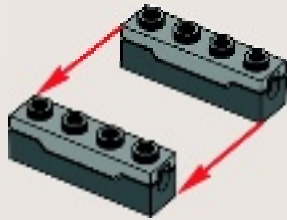

2

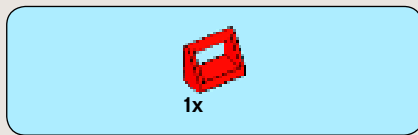

3





4

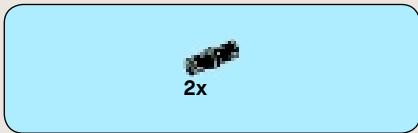
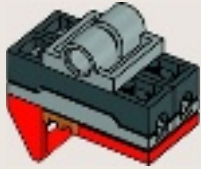
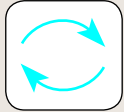

5

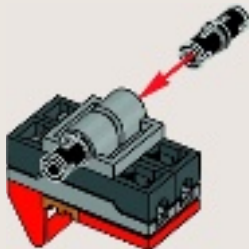

6

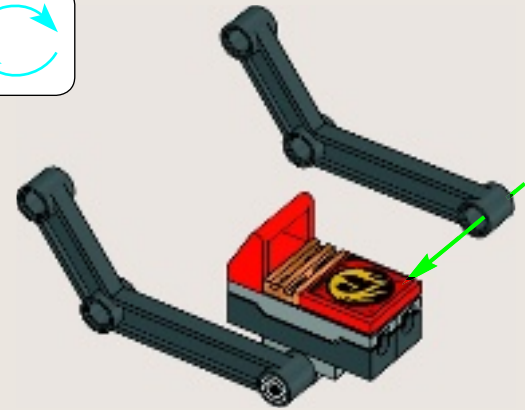
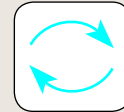



2x

7

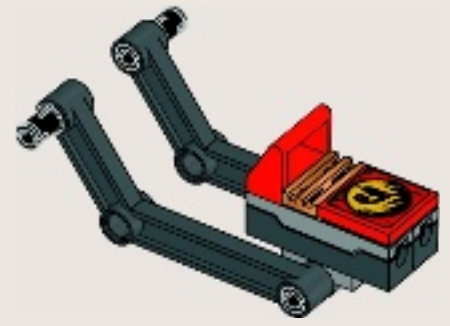

2x

8

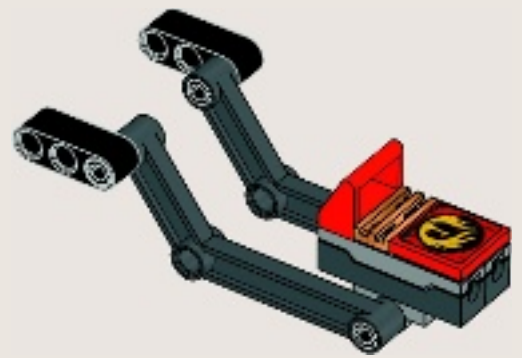

2x

9

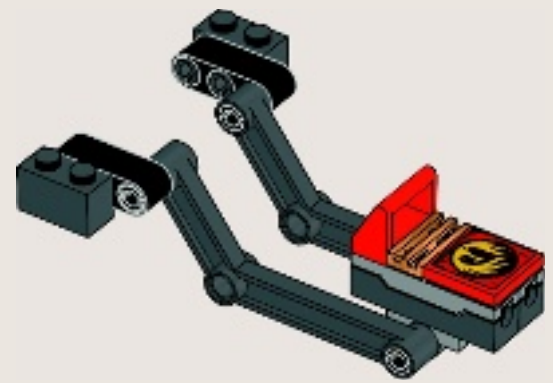

47

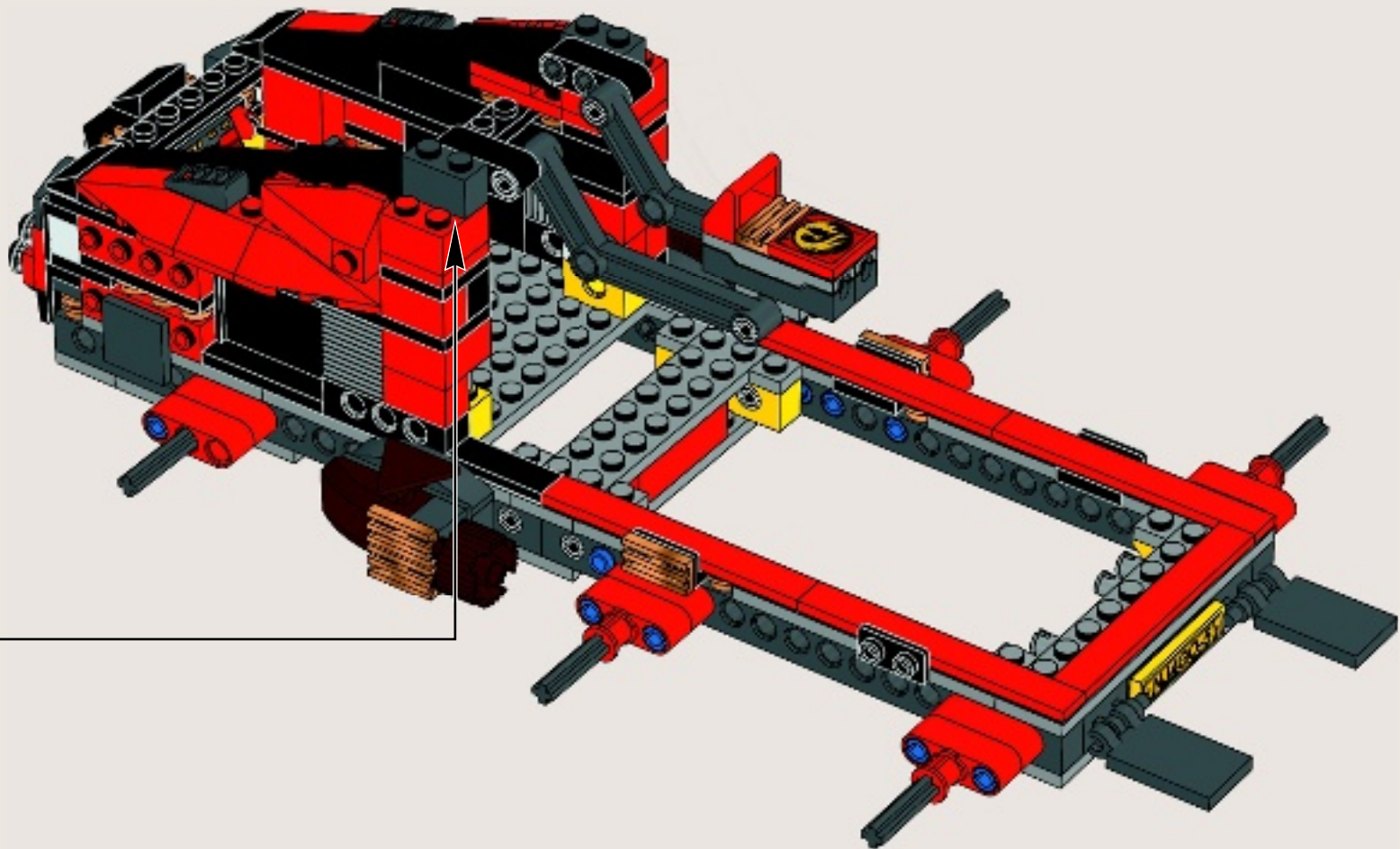





2x

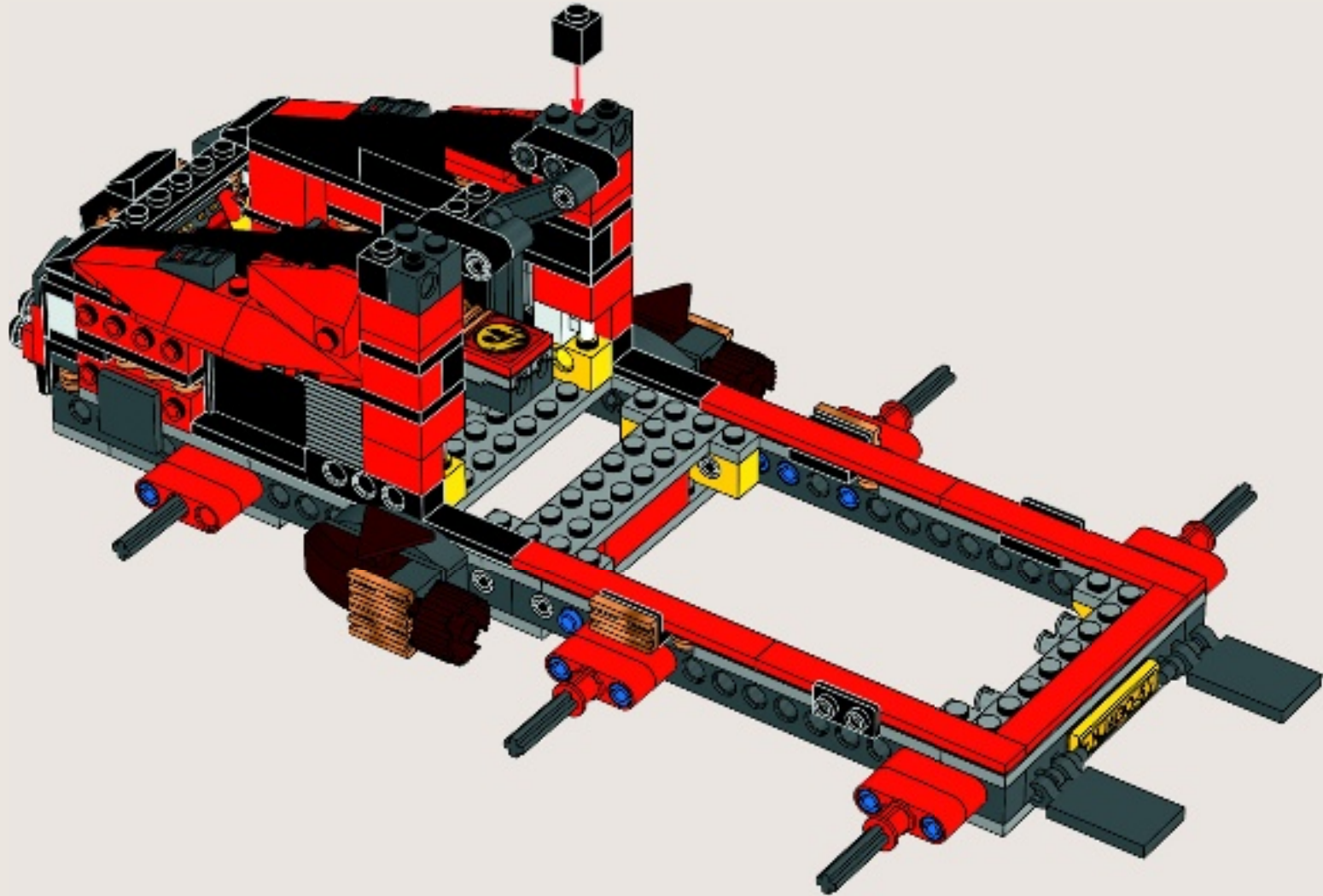

2x

48



2x  2x 

49

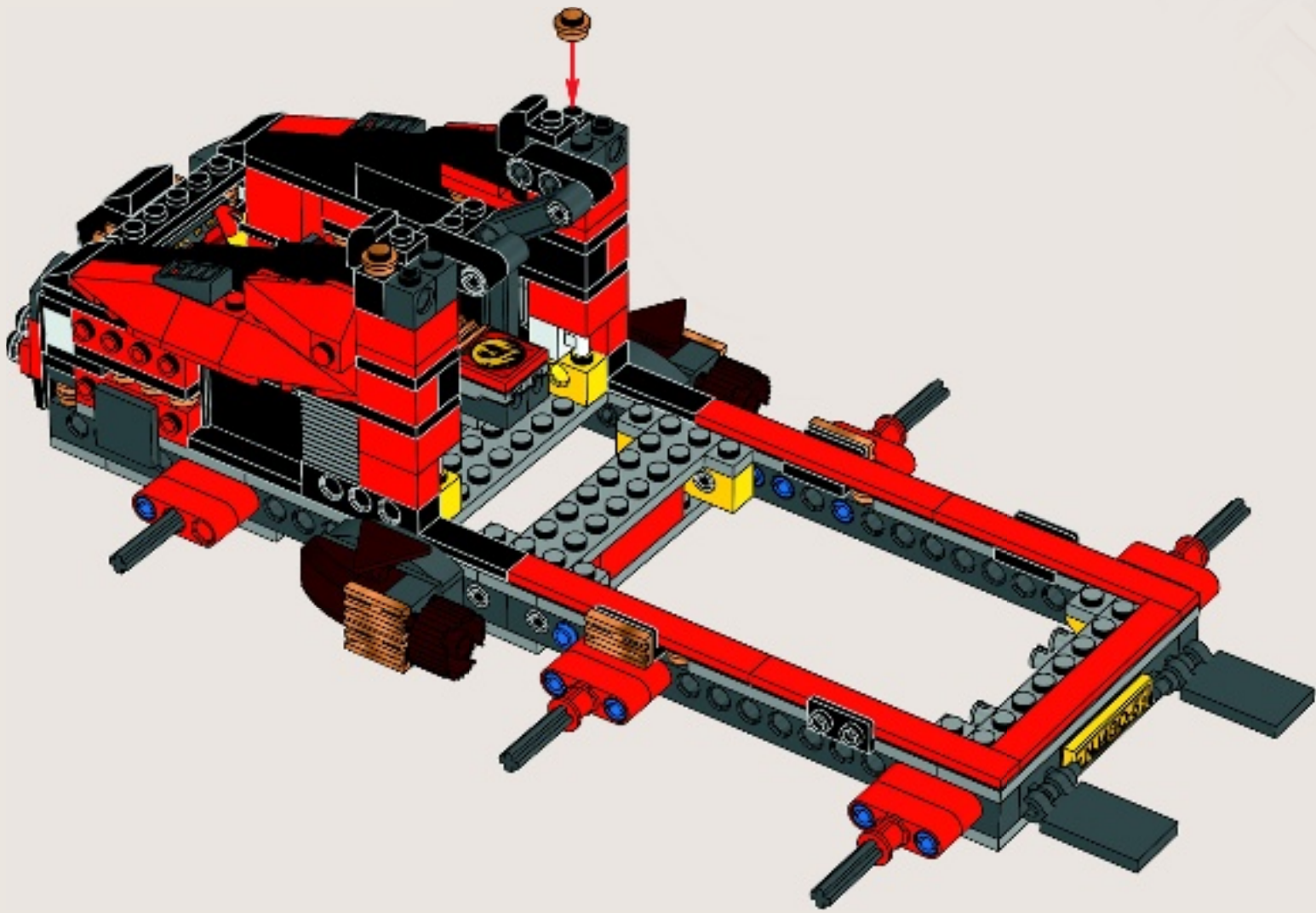

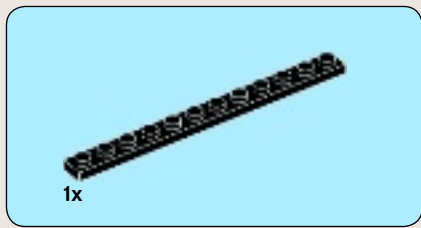

50

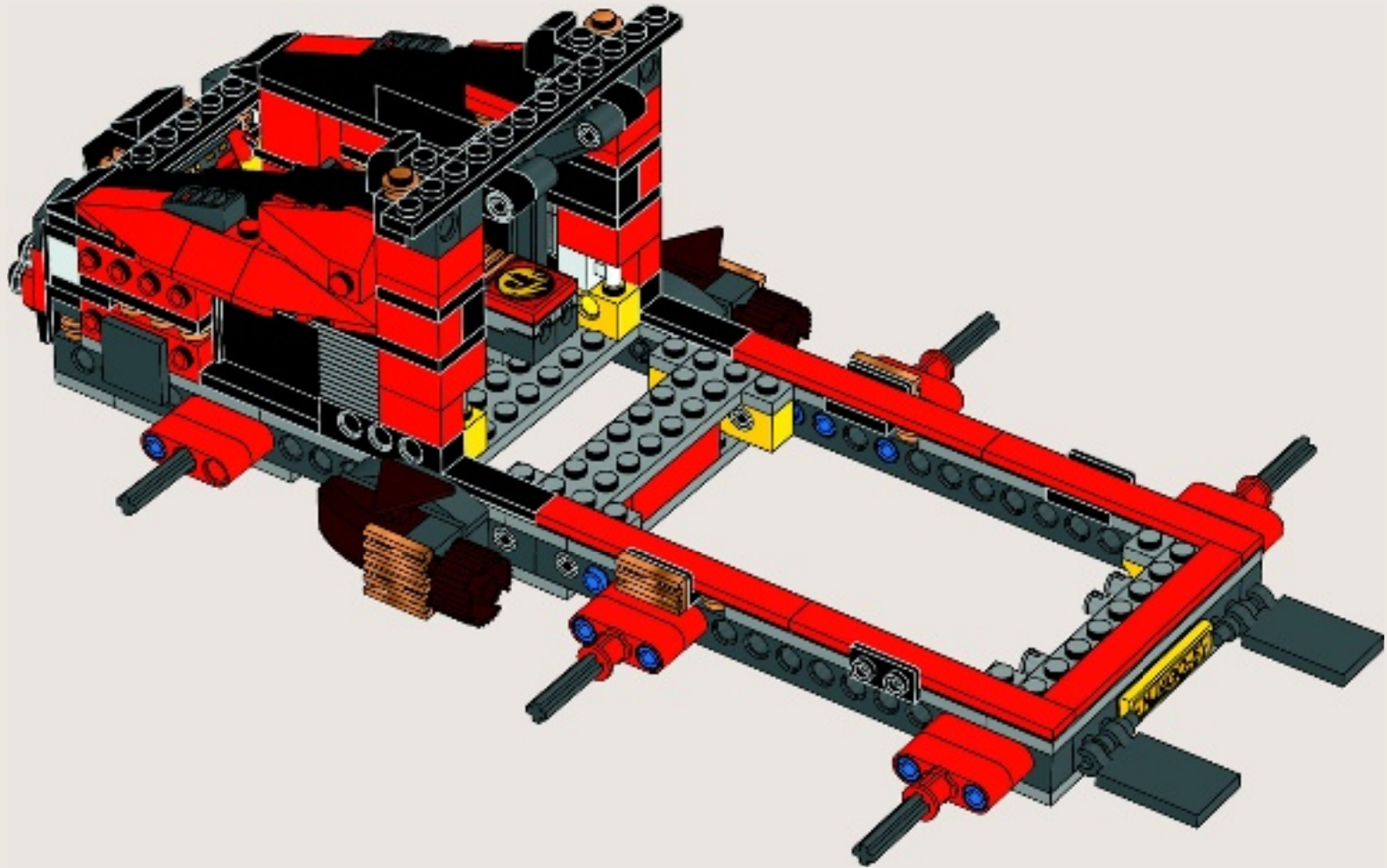

2x  2x 

51

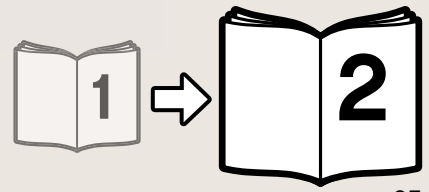
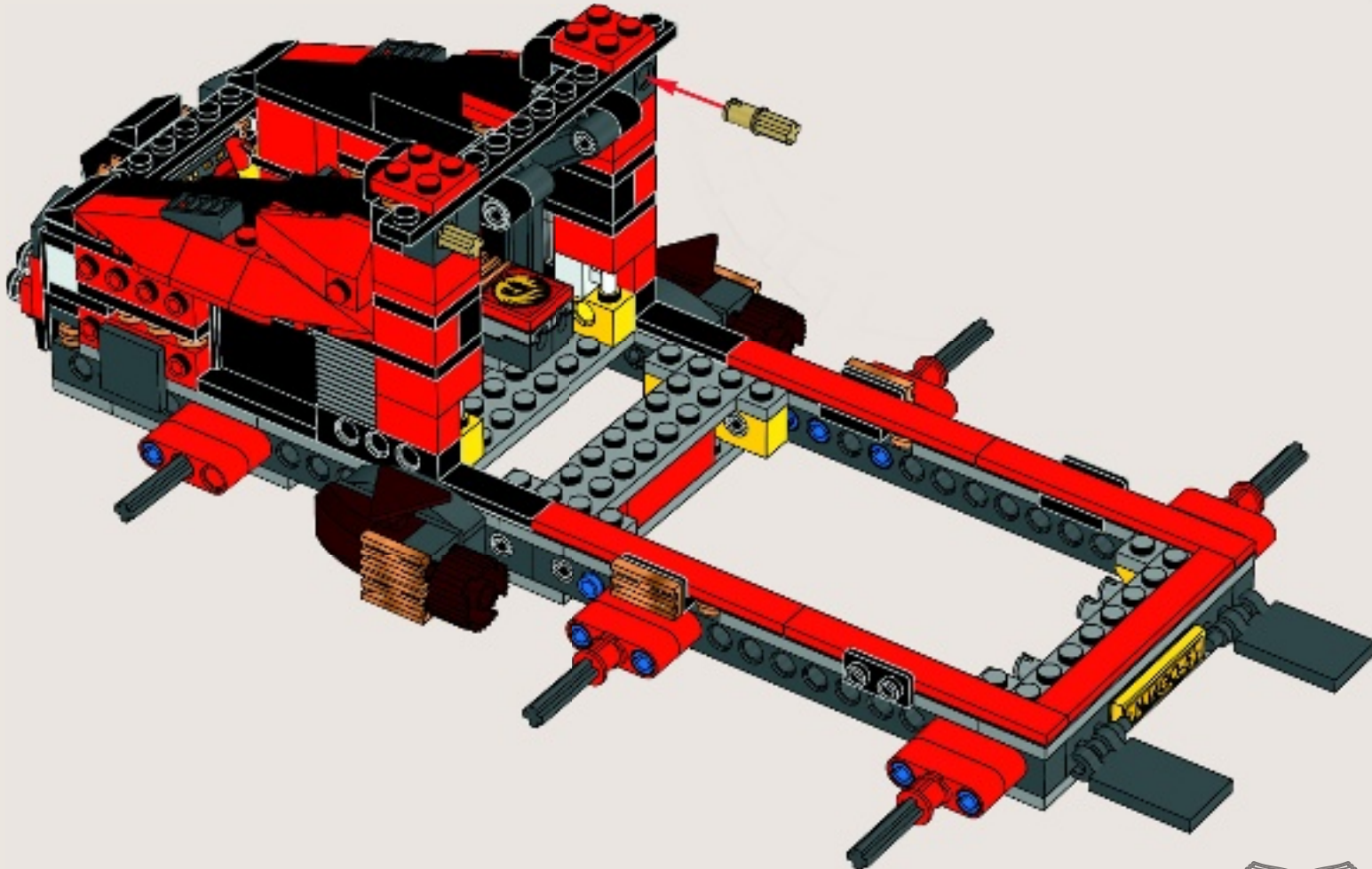



NINJAGO

Masters of Spinjitzu



70752



70753



70754



70755



70745



70746



70745



70746



70746



70747



70748



70749



70750



NINJAGO™

SHADOW OF RONIN

IN 2015, A SHADOW EMERGES



©2015 THE LEGO GROUP.™ & © WARNER BROS. ENTERTAINMENT INC. (S15). LEGO, THE LEGO LOGO AND THE MINIFIGURE ARE TRADEMARKS AND/OR COPYRIGHTS OF THE LEGO GROUP. NINTENDO TRADEMARKS AND COPYRIGHTS ARE PROPERTIES OF NINTENDO. "PLAYSTATION" AND THE "PS" FAMILY LOGO ARE REGISTERED TRADEMARKS AND THE PLAYSTATION NETWORK LOGO IS A TRADEMARK OF SONY COMPUTER ENTERTAINMENT INC. THE "PSVITA" LOGO IS A TRADEMARK OF THE SAME COMPANY. ALL OTHER TRADEMARKS AND COPYRIGHTS ARE THE PROPERTY OF THEIR RESPECTIVE OWNERS.