



# NINJAGO™

Masters of Spinjitzu

70741

# AIRJITZU™

# COLE



1



2



3



4





1



2

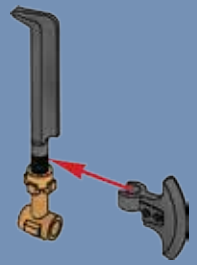

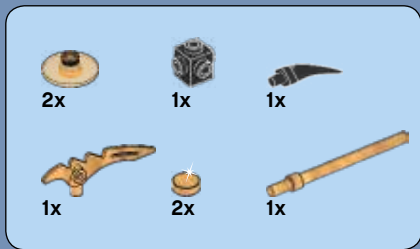

1



2



3



4



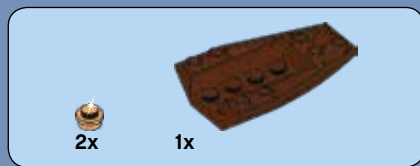

1

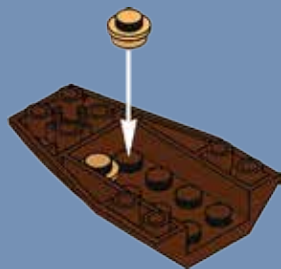

2





1x

3



6



1x

4

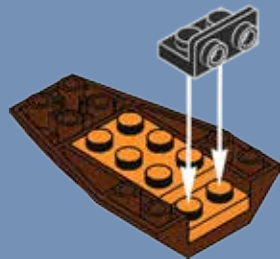

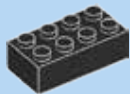

1x

5

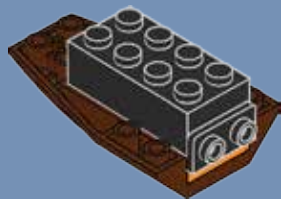

1x

6

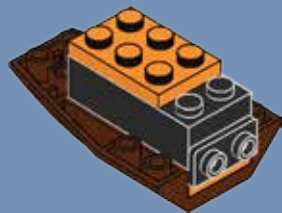



1x

7

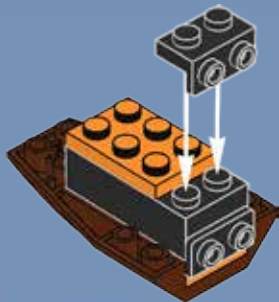

8



2x



2x

8

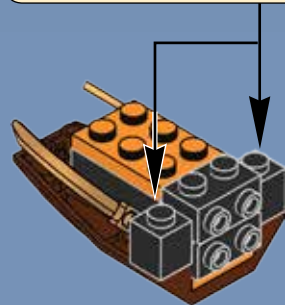
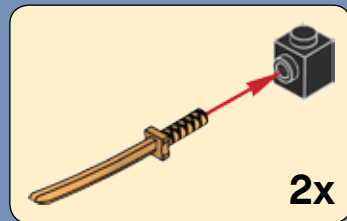





1x

9

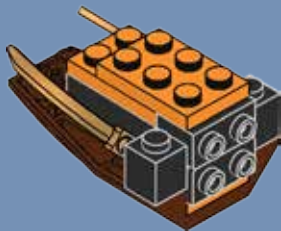

1x

10



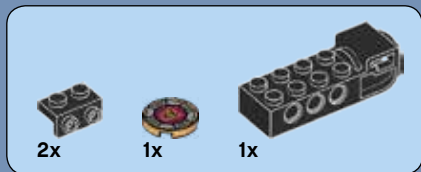

# 11

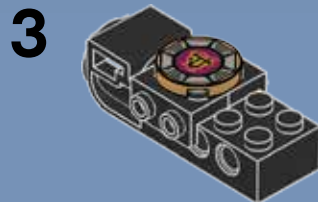
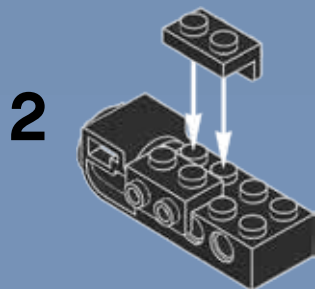
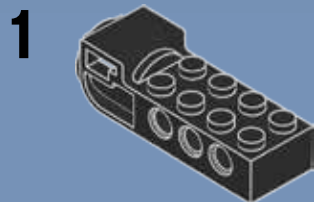

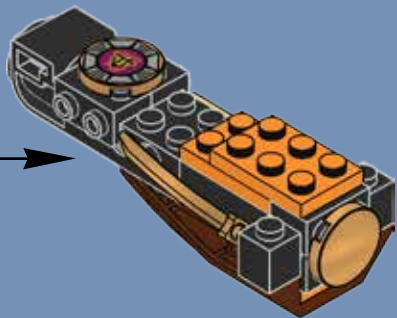

12





2x

# 13

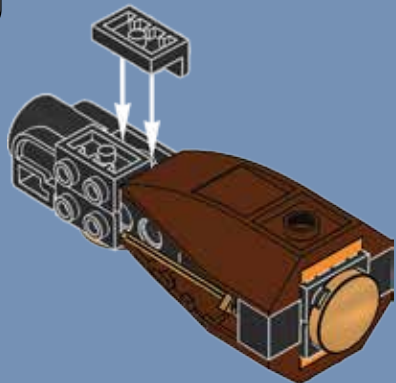
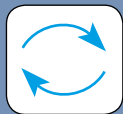

1x

# 14

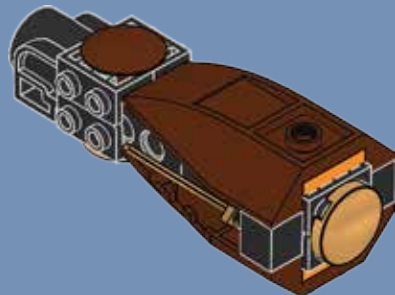



2x

# 15

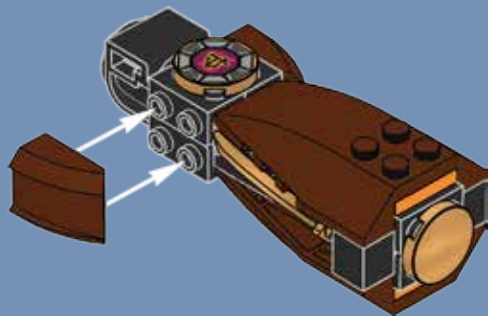

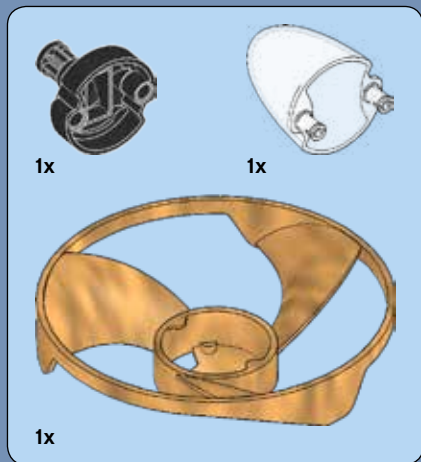

16

1



2



3

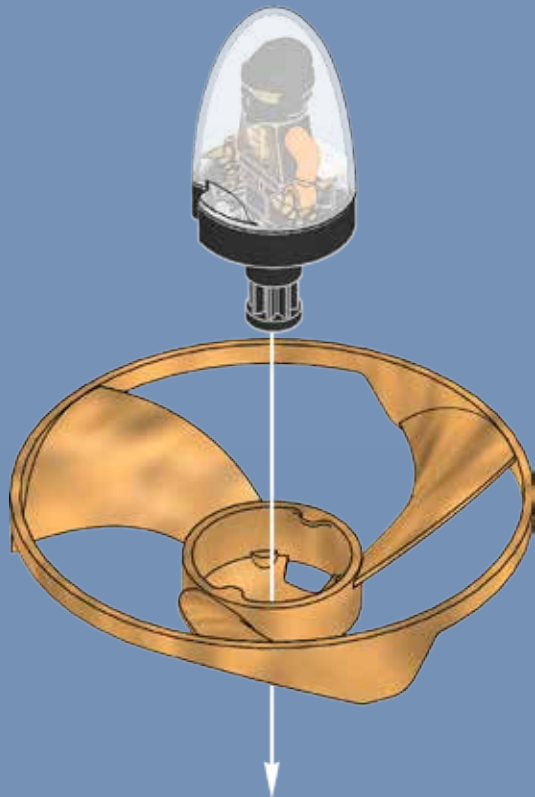

4

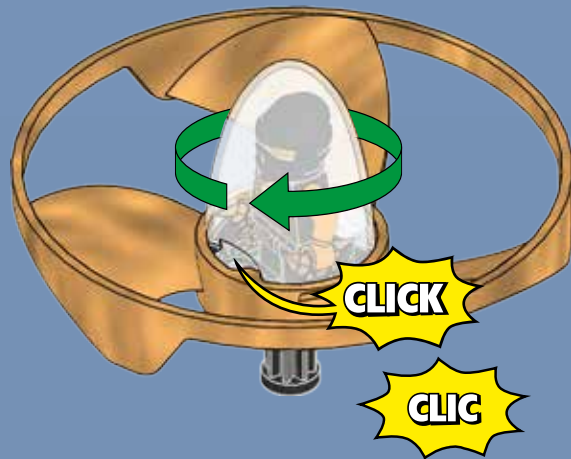

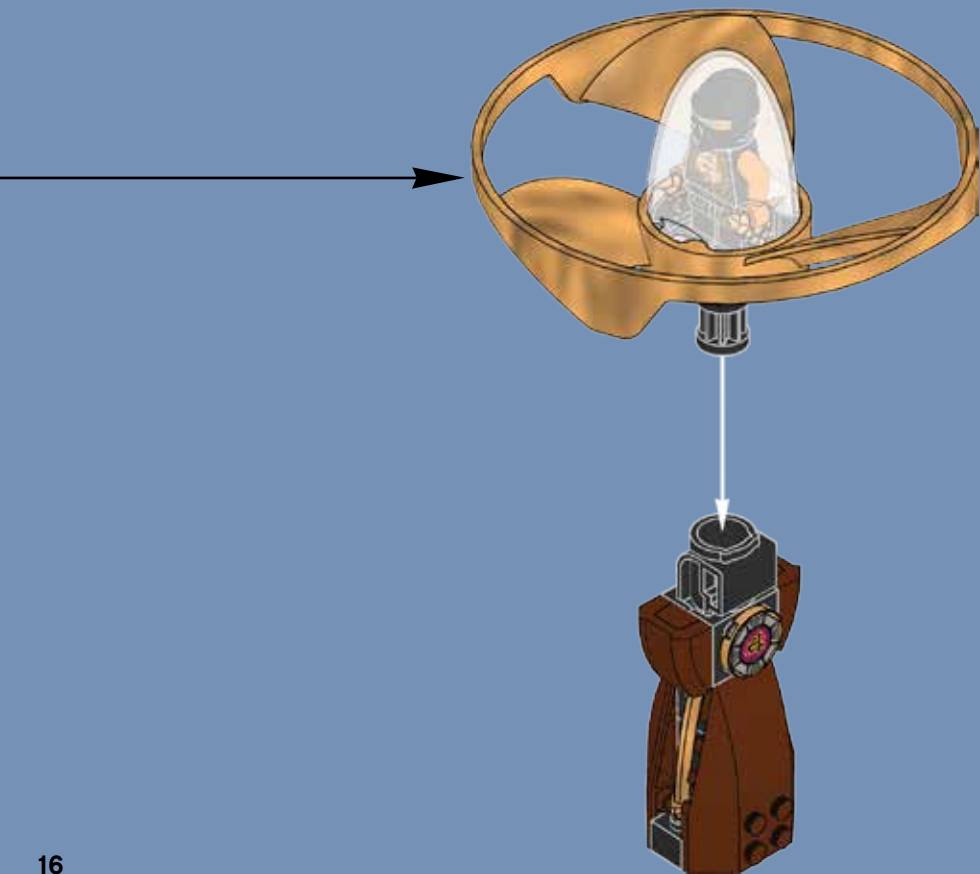



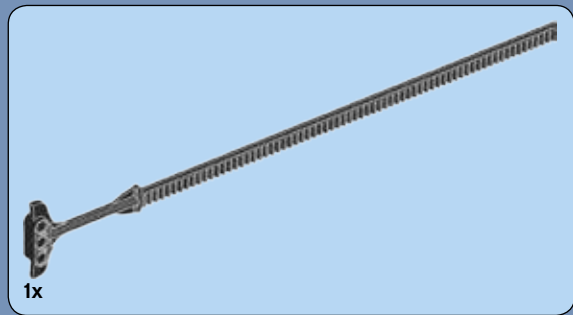

17





# NINJAGO™

Masters of Spinjitzu



# AIRJITZO™



**3** FLY  
VOLE  
VUELA

**2** RIP  
LANCE  
TIRA

**1** BUILD  
CONSTRUIS  
CONSTRUYE



# NINJAGO™

Masters of Spinjitzu

**COOL TRICKS ONLINE**  
**DES ASTUCES COOL EN LIGNE**  
**LOS MEJORES TRUCOS ONLINE**



[WWW.LEGO.COM/AIRJITZU](http://WWW.LEGO.COM/AIRJITZU)





# NINJAGO™

Masters of Spinjitzu



70739



70740



70741



70742



70743



70744



# NINJAGO™

Masters of Spinjitzu



**LEGO**

# NINJAGO™

Masters of Spinjitzu



**70738**



**70735**



**70736**





4x  
4125278



1x  
6115162



2x  
6109454



1x  
6109924



1x  
6109997



1x  
6037289



2x  
6037241



2x  
4523159



2x  
4649422



1x  
6066345



1x  
6115728



1x  
6081992



1x  
4640843



1x  
4646871



1x  
6114925



2x  
6116596

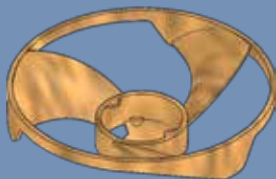

1x  
6119134



2x  
4520952



1x  
6115679



1x  
6115113



1x  
4646824



1x  
6110042



1x  
6110044



1x  
6109891



2x  
4558954



1x  
473326



3x  
6020193



1x  
4563477



1x  
300126



3x  
6016172



1x  
4613958



1x  
6002758



1x  
6108477



**Customer Service**

**Kundenservice**

**Service Consommateurs**

**Servicio Al Consumidor**

**LEGO.com/service or dial**



**: 00800 5346 5555**

**: 1-800-422-5346**