

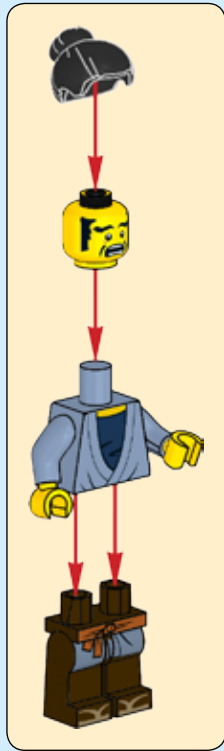

THE NINJAGO MOVIE

70610

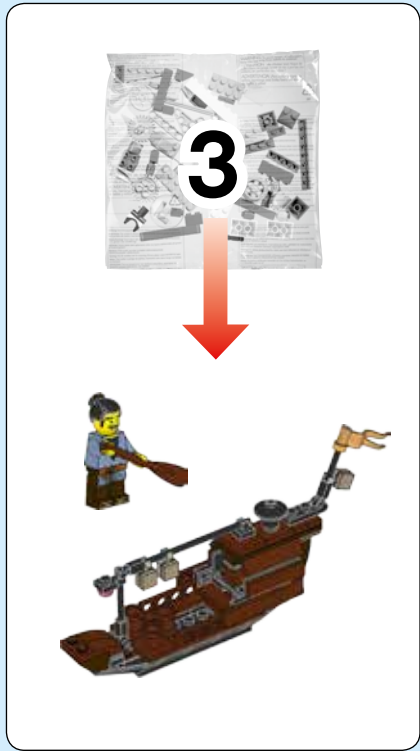



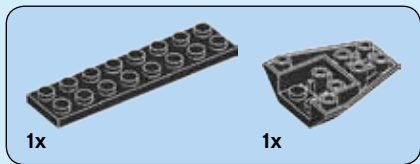

1

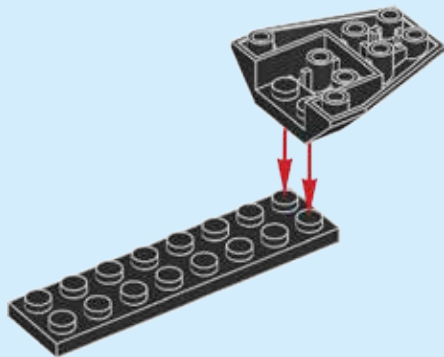

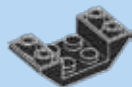

3x

2

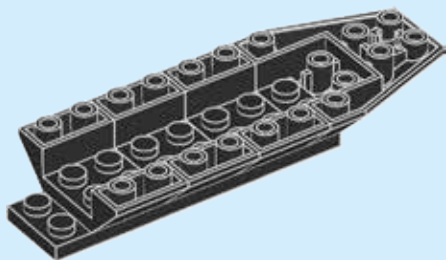

4

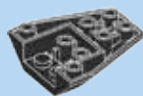

1x

3

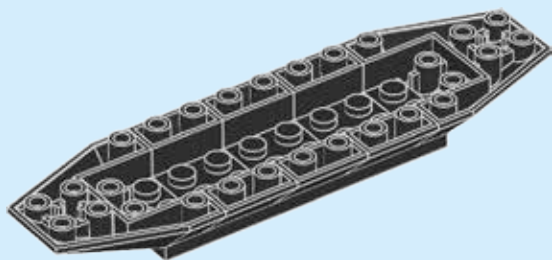

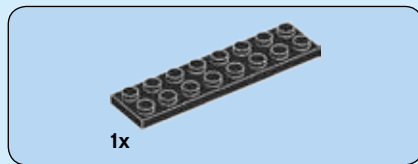

4

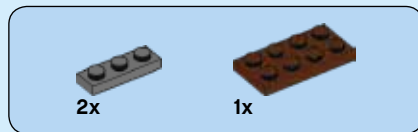
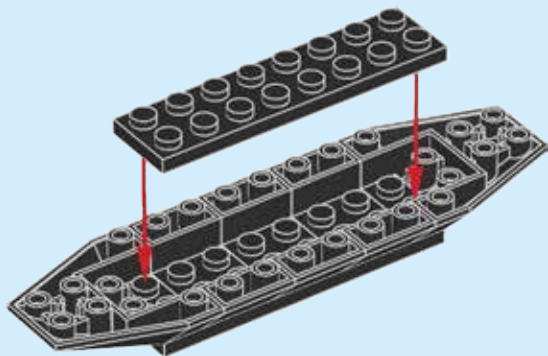

5

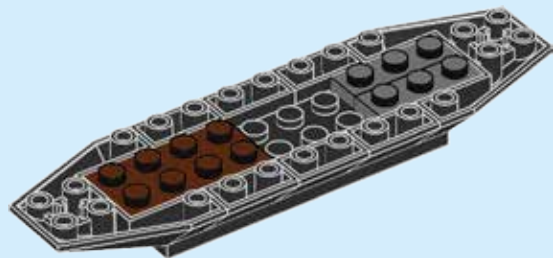

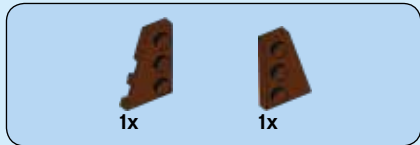

6

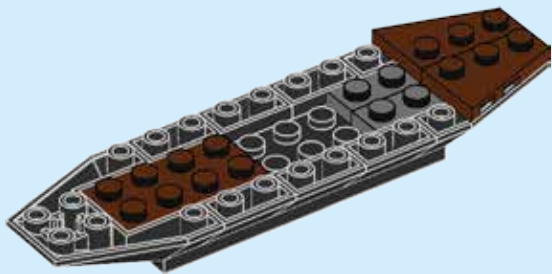

6



7

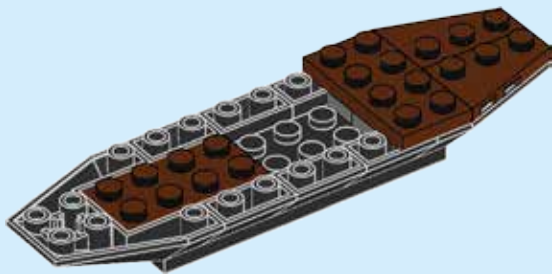



8

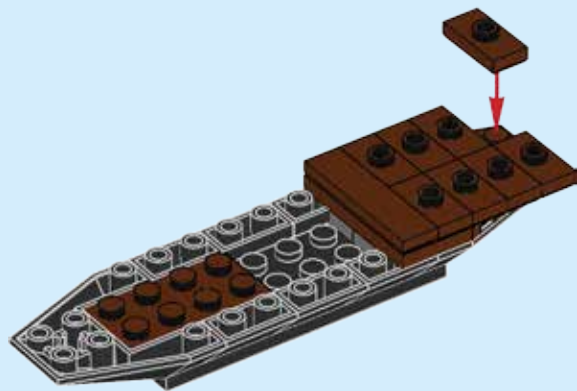

9

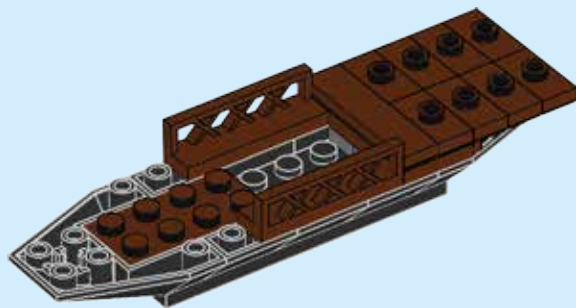

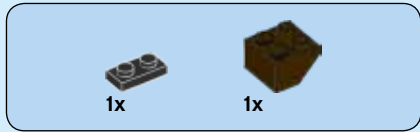

10

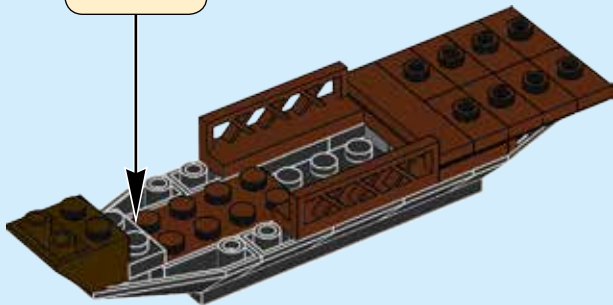

8



11

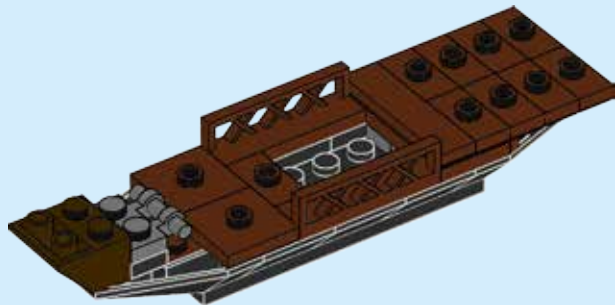



2x

12

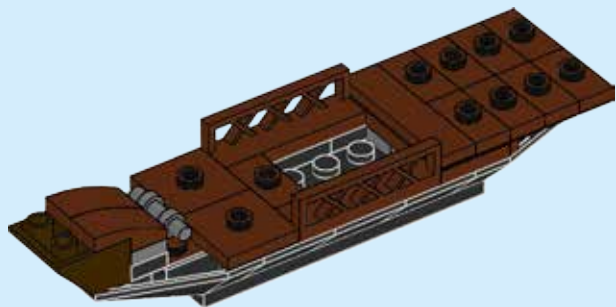

1x

13

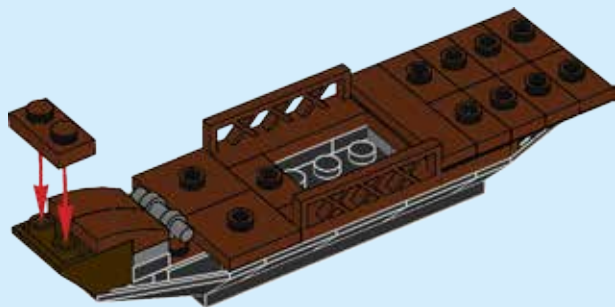



4x

14

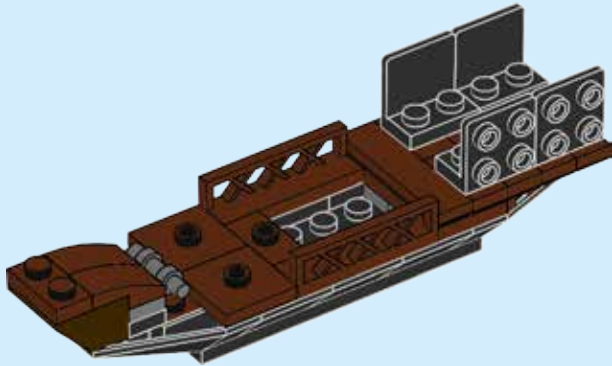

10



1x

15

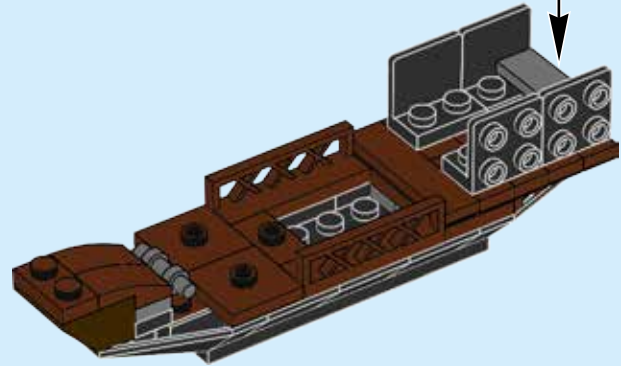
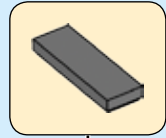



1x

16

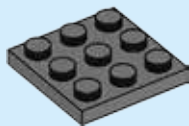

2x

17

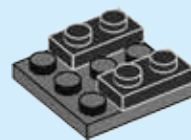



18

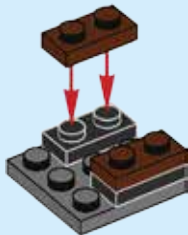

12



19

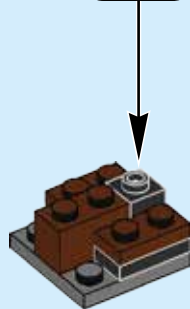



1x

20

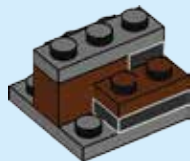

1x



1x

21

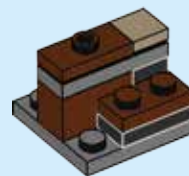



2x



2x

22

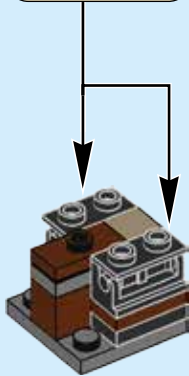
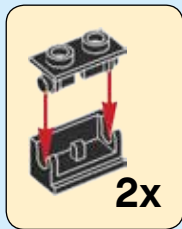

23

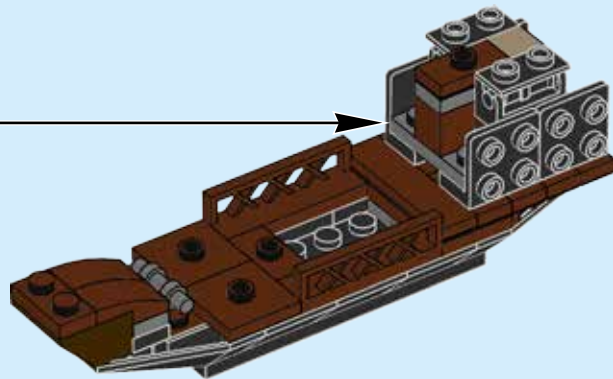

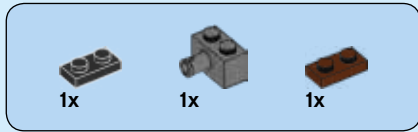

24

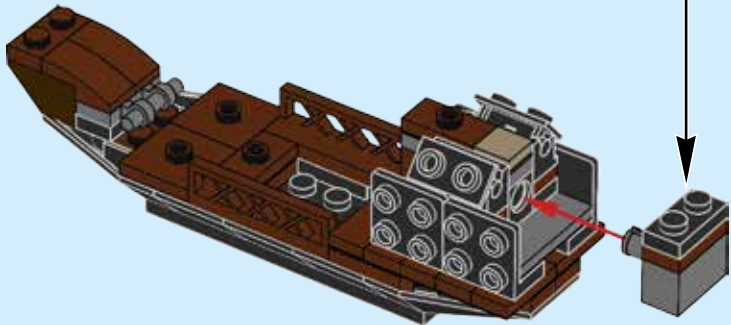
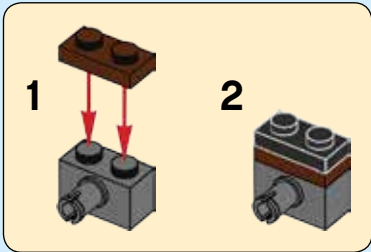

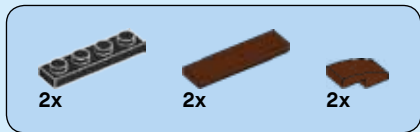

25

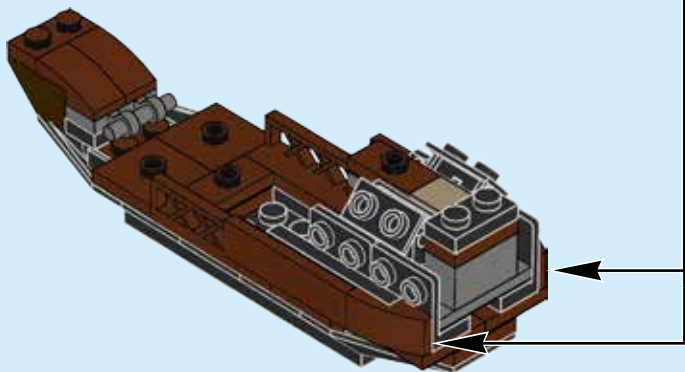
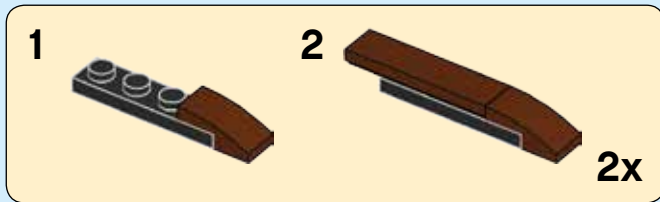



26

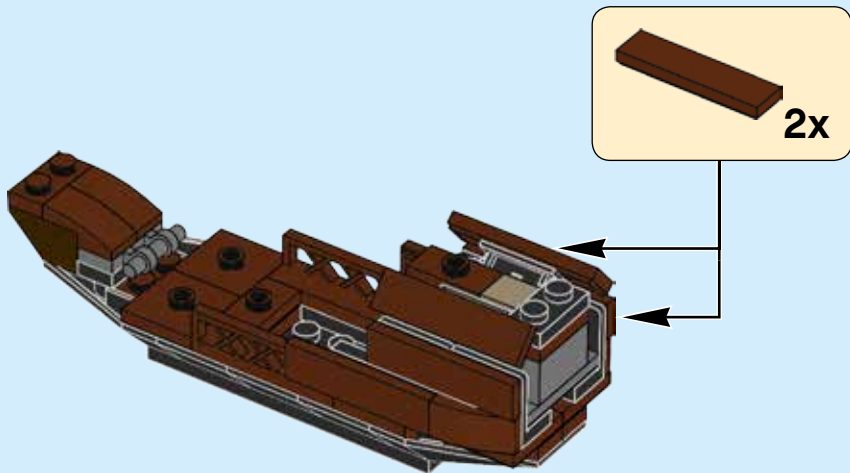



27

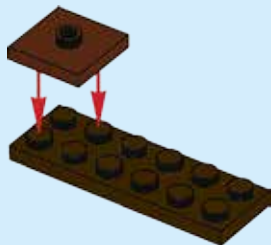

28





1x



1x



1x

29



1x



1x

30

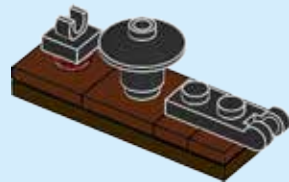

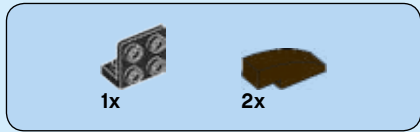

31

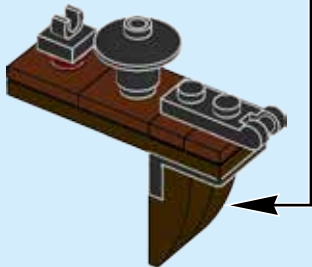
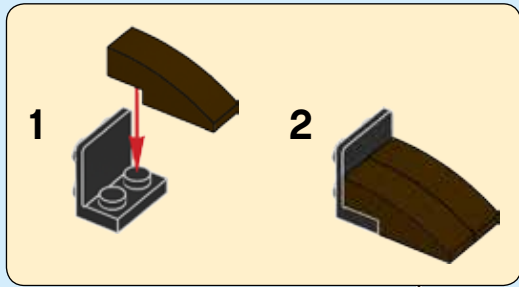

32

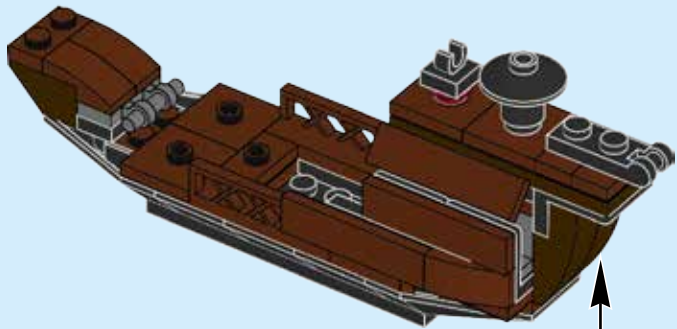



33

1



2

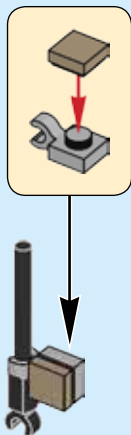

3

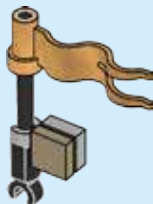

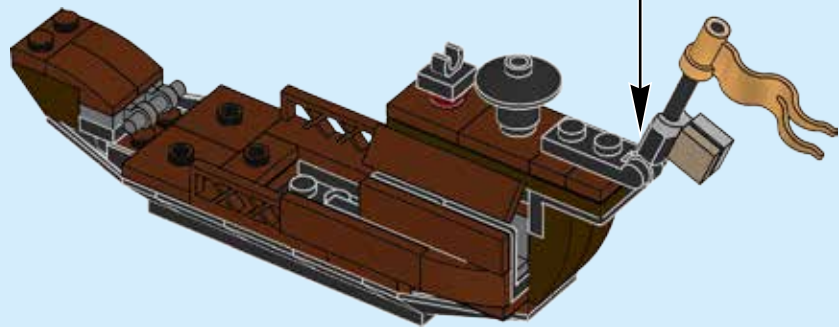



3x

34





1x



1x

35

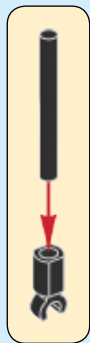



1x



1x

36



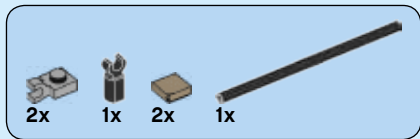

37

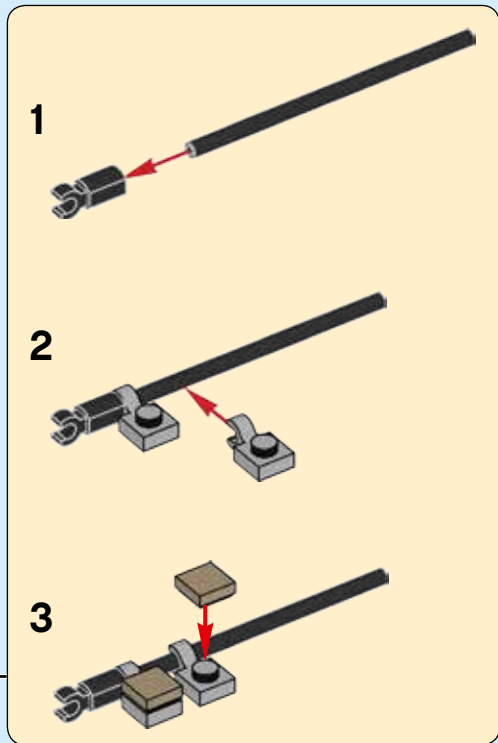
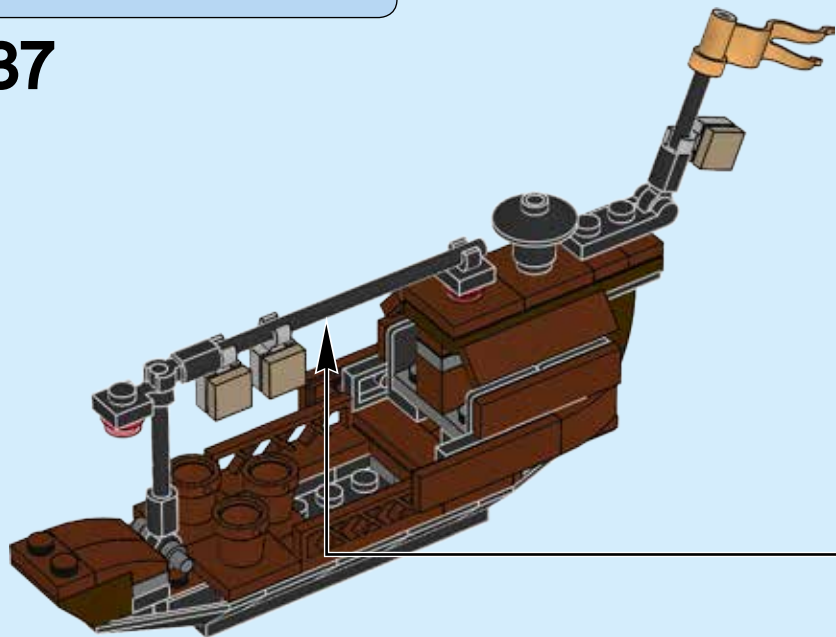

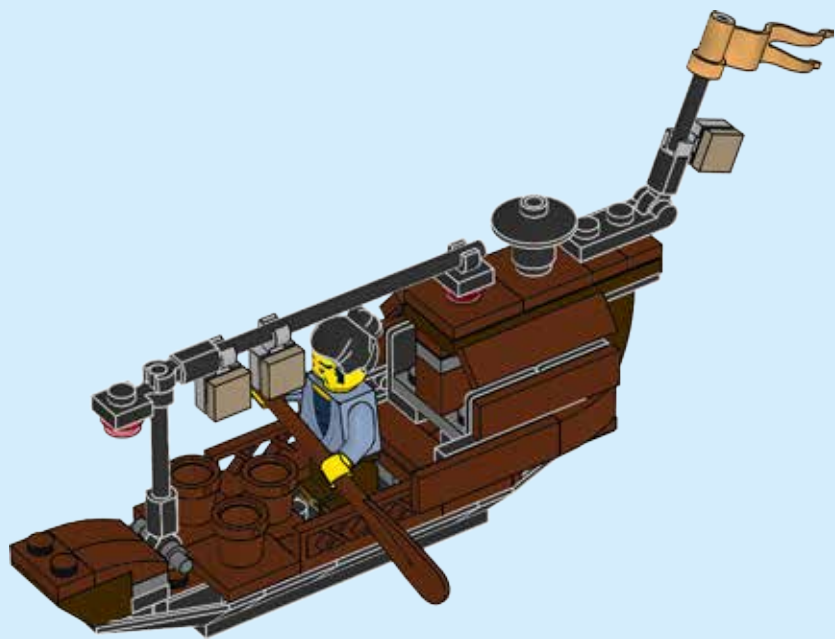



THE
NINJAGO
MOVIE

LEGO.COM/NINJAGOMOVIE



THE NINJAGO MOVIE

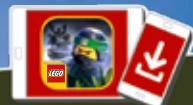

LEGO® WU-CRU
LEGO.com/apps



LEGO.COM/NINJAGOMOVIE



THE NINJAGO MOVIE



70606



70607



70608



70609



70611

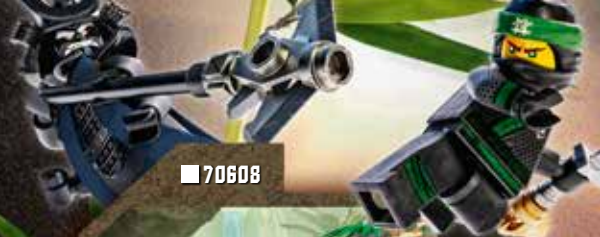

70612



70614



70618



70615



70617



AVAILABLE
FALL 2017



DISPONIBLE
AUTOMNE 2017

DISPONIBLE
OTOÑO 2017



THE NINJAGO MOVIE VIDEOGAME



RATING PENDING
COTE EN ATTENTE



Visit esrb.org for
rating information
Visiter esrb.org
pour les classifications

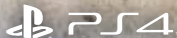

LEGO.com/videogames

The LEGO logo is displayed in its classic white font with a black outline, set against a red rectangular background.The title "LEGO WORLDS" is rendered in a pixelated, blocky font. The letters are white with black outlines, set against a background of green and brown pixelated terrain, all enclosed within a glowing blue border.

UNLOCK MODEL IN GAME / Separate purchase required
MODÈLE À DÉVERROUILLER EN JEU / Achat séparé requis
DESBLOQUEAR MODELO EN EL JUEGO / Se requiere la compra por separado

PPA72V



LEGO.com/worlds

EVERYONE 10+







































































Cartoon Violence

LEGO WORLDS software © 2017 TT Games Ltd. Produced by TT Games under license from the LEGO Group. LEGO, the LEGO logo, the Brick and the Knob configurations and the Minifigure are trademarks of the LEGO Group. © 2017 The LEGO group. All other trademarks and copyrights are the property of their respective owners. All rights reserved. WB GAMES LOGO, WB SHIELD: ™ & © Warner Bros. Entertainment Inc. (s17)

Logiciel LEGO WORLDS © 2017 TT Games Ltd. Produit par TT Games avec l'autorisation du Groupe LEGO. LEGO, le logo LEGO, les configurations de briques et tenons et la minifigurine sont des marques de commerce du Groupe LEGO. © 2017 Le Groupe LEGO. Tous les autres droits d'auteur et marques de commerce sont la propriété de leurs propriétaires respectifs. Tous droits réservés. LOGO WB GAMES, LOGO WBIE, BOUCLIER WB : ™ et © Warner Bros. Entertainment Inc. (s17)

LEGO WORLDS software © 2017 TT Games Ltd. Producido por TT Games bajo licencia de LEGO Group. LEGO, el logotipo de LEGO, la configuración del Ladrillo y de la Perilla, y la Minifigura son marcas comerciales de LEGO Group. © 2017 The LEGO Group. Todas las demás marcas comerciales y derechos de autor son propiedad de sus respectivos propietarios. Todos los derechos reservados. LOGOTIPO DE WB GAMES, LOGOTIPO DE WBIE, ESCUDO DE WB: ™ y © Warner Bros. Entertainment Inc. (s17)

 3x 4626196	 7x 4211194	 6x 6020189	 1x 4222192	 1x 4211065	 1x 6192758	 4x 4211483	 2x 4211029
 1x 6021336	 2x 6192371	 1x 6194290	 6x 4211094	 1x 4600437	 1x 6192565	 2x 6071229	 1x 6195495
 1x 6021339	 2x 4211186	 6x 6115080	 3x 4211133	 1x 4243831	 1x 6191864	 2x 4211375	 1x 4616840
 4x 6069984	 1x 6159763	 2x 4210655	 1x 4568734	 4x 4243831	 1x 6195487	 3x 4541978	 2x 4211815
 12x 6092590	 1x 4609635	 1x 4210631	 2x 6086709	 8x 6166865	 1x 4648296	 2x 4529241	 2x 4520320
 1x 4211149	 2x 6034044	 2x 4210762	 1x 4549886	 12x 6166868	 2x 6022199	 2x 4211551	 2x 4211396
 4x 4211150	 2x 4613762	 6x 6000606	 1x 4211097	 4x 6166870	 1x 4518687	 2x 6192577	 1x 6105964
 1x 6075208	 1x 6132212	 1x 4211087	 1x 4211097	 1x 6195406	 1x 6192605	 2x 6043656	 1x 4211725
 4x 4565394	 2x 4210639	 1x 6174161	 1x 6039176	 6x 4244627	 8x 4654582	 6x 4244627	 1x 4211462



2x
6088638



2x
6089119



1x
4515368



2x
371026



3x
4188534

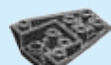

2x
6092952



1x
6193640



2x
303426



2x
6116604



2x
614326



4x
4121715



1x
6191921



2x
6006140



4x
302326



2x
393826



2x
393726



5x
6000650



13x
4556158



3x
6015891



1x
306226



2x
6121485



1x
6066102



1x
654126



1x
6099429



1x
6173926



1x
6191714



1x
4550017



1x
474026



2x
6057397



8x
4206482



6x
4650498



1x
626440



2x
6192645



3x
4497943



2x
3005741



4x
6055172



2x
6195347



1x
4504649



3x
6162578



4x
4216656



1x
243224



2x
306224



1x
6191858



1x
6194799



1x
6192818



1x
6195253



6x
6014033



2x
4169960



2x
74156



2x
6168644



12x
302324



2x
4515367



1x
300224



1x
371024



1x
4515349



2x
6100888



1x
6178629



3x
6121436



2x
4646865



8x
4278409



4x
6132438



Customer Service

Kundenservice

Service Consommateurs

Servicio Al Consumidor

LEGO.com/service or dial



: 00800 5346 5555

: 1-800-422-5346



THE LEGO NINJAGO MOVIE © & ™ Warner Bros. Entertainment Inc. & The LEGO Group. LEGO, the LEGO logo, NINJAGO and the Brick and Knob configurations are trademarks of the/sont des marques de commerce du/son marcas registradas de LEGO Group. ©2017 The LEGO Group. All rights reserved/Tous droits réservés/Todos los derechos reservados. (s17)



CALIFORNIA • FLORIDA

EXCLUSIVELY! • EXCLUSIVEMENT ! • ¡EN EXCLUSIVA! • EXCLUSIVELY!



Arizona • Atlanta • Boston • Chicago
Dallas/Fort Worth • Kansas City
Michigan • Toronto • Westchester



LEGO, the LEGO logo, NINJAGO, the NINJAGO logo, the Minifigure and LEGOLAND are trademarks and/or copyrights of the/sont des marques de commerce et/ou copyrights du/son marcas registradas, algunas de ellas protegidas por derechos de autor, de LEGO Group. ©2017 The LEGO Group. LEGOLAND is part of Merlin Entertainments plc.

LEGOLAND.COM

6207802