

1

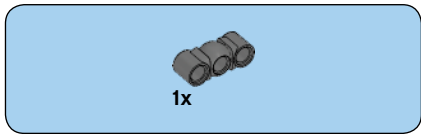

2

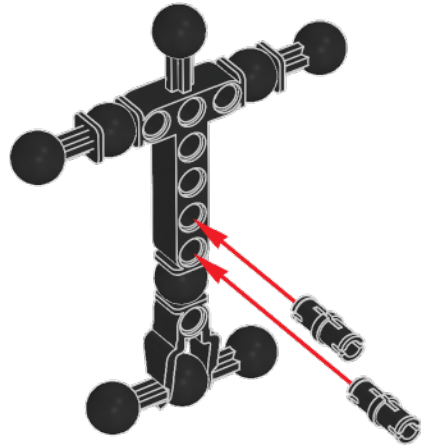

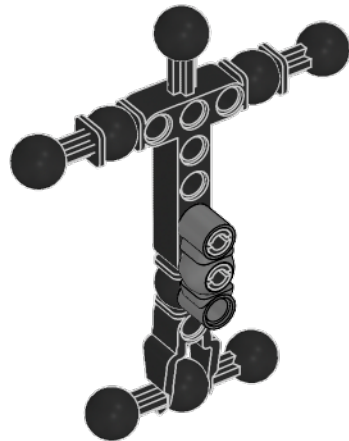
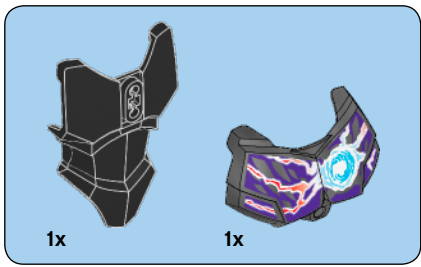

3

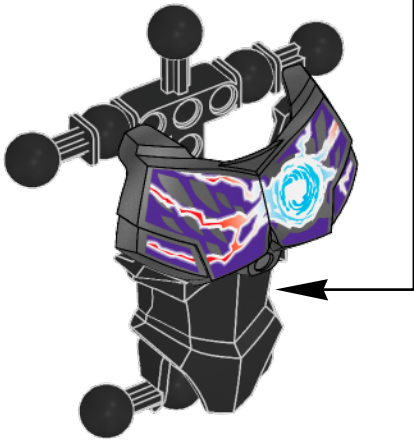
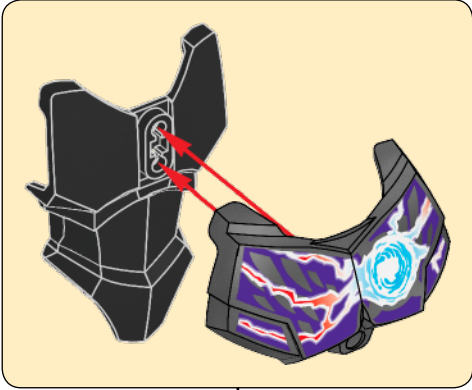

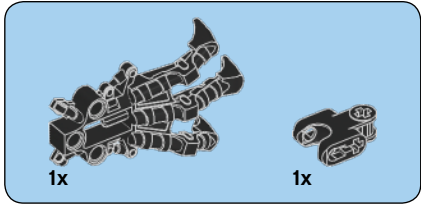
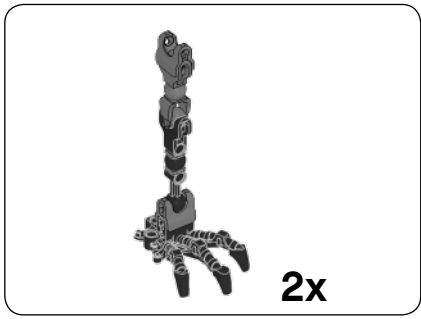

1

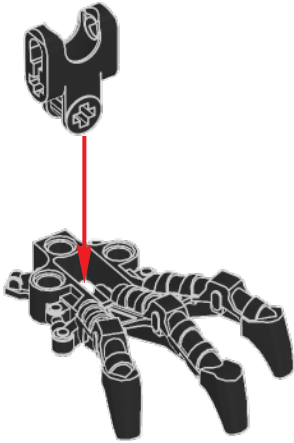



2

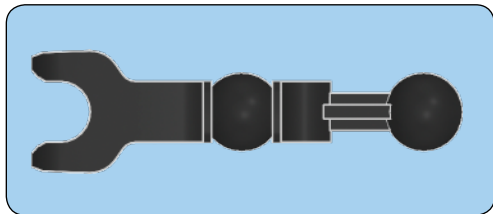
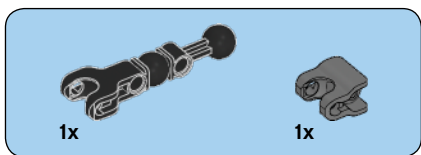
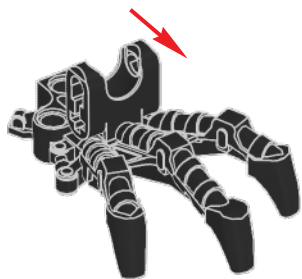

3

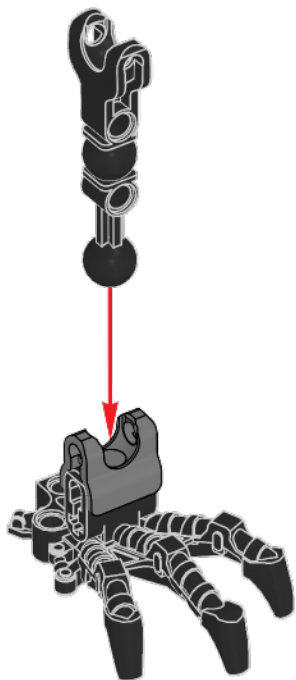

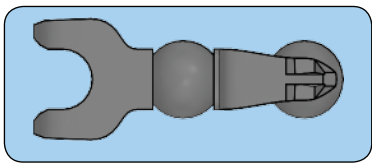
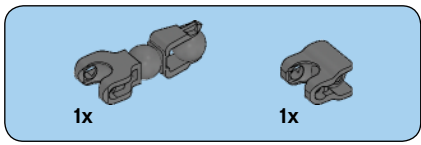

4

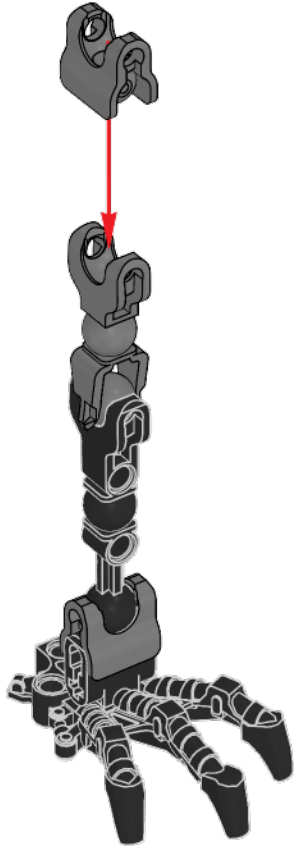

2x

4

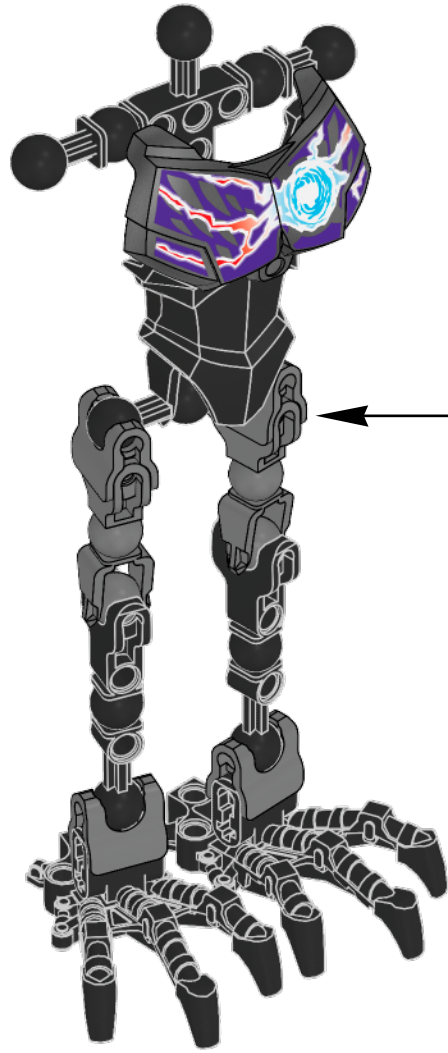

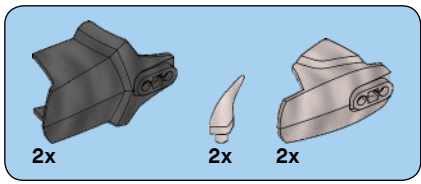

5

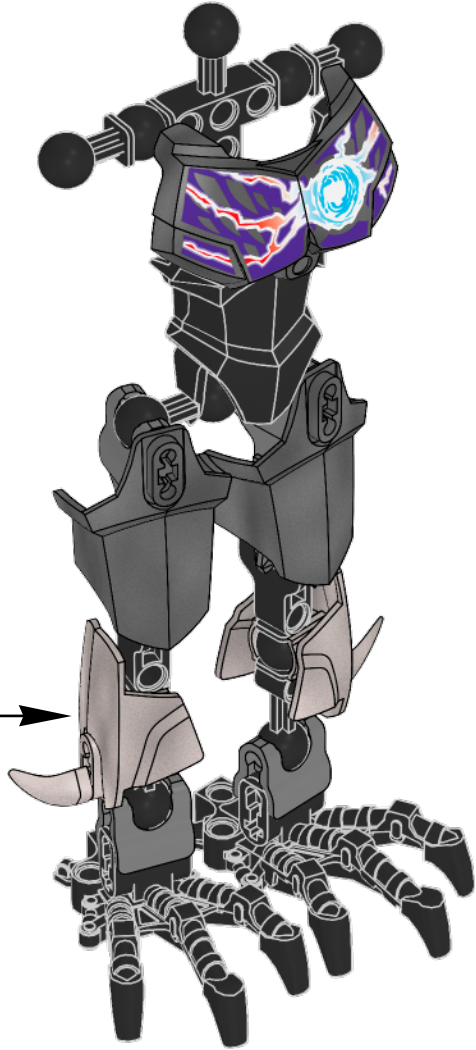
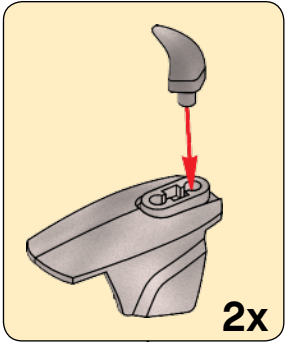

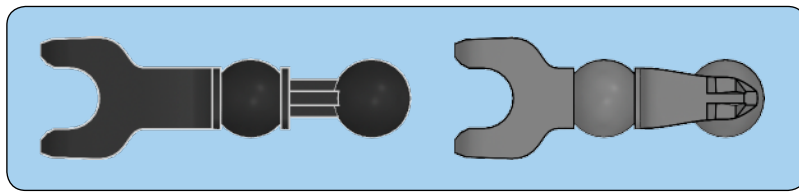
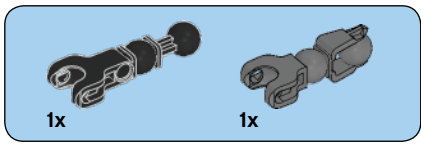

1

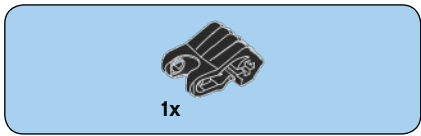
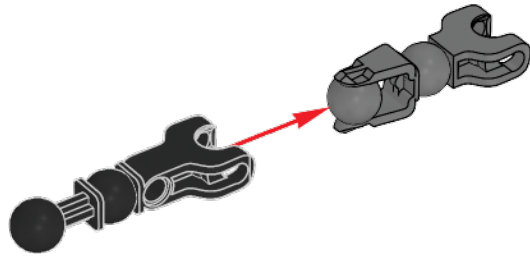

2

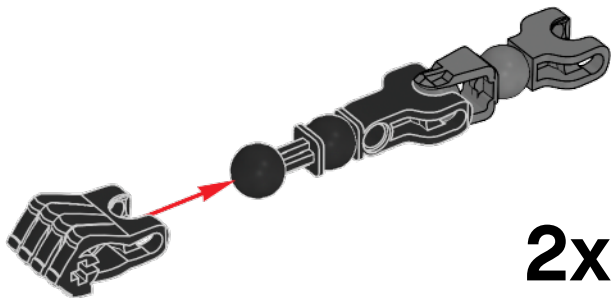

6

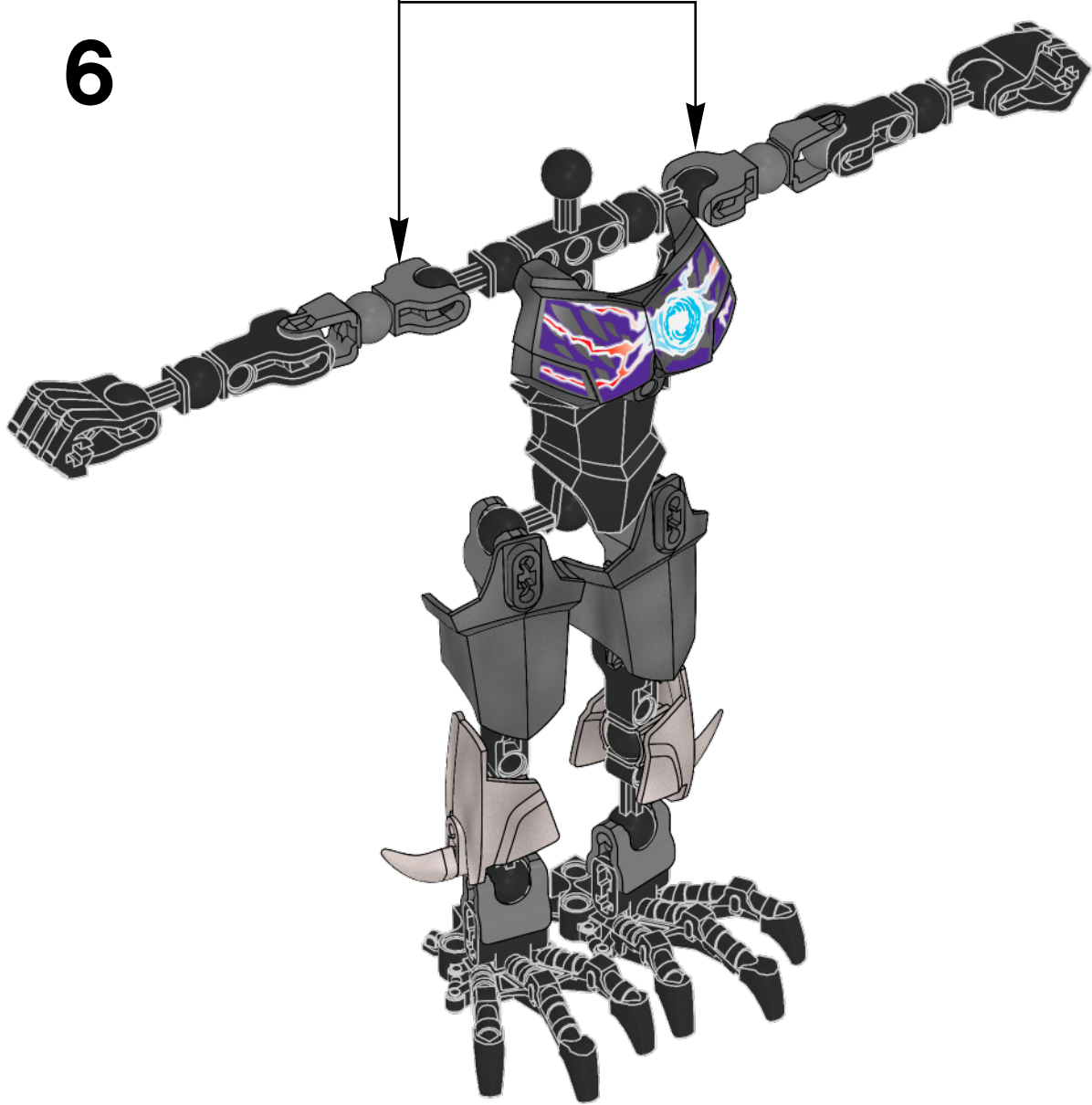

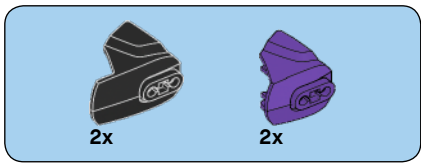

7

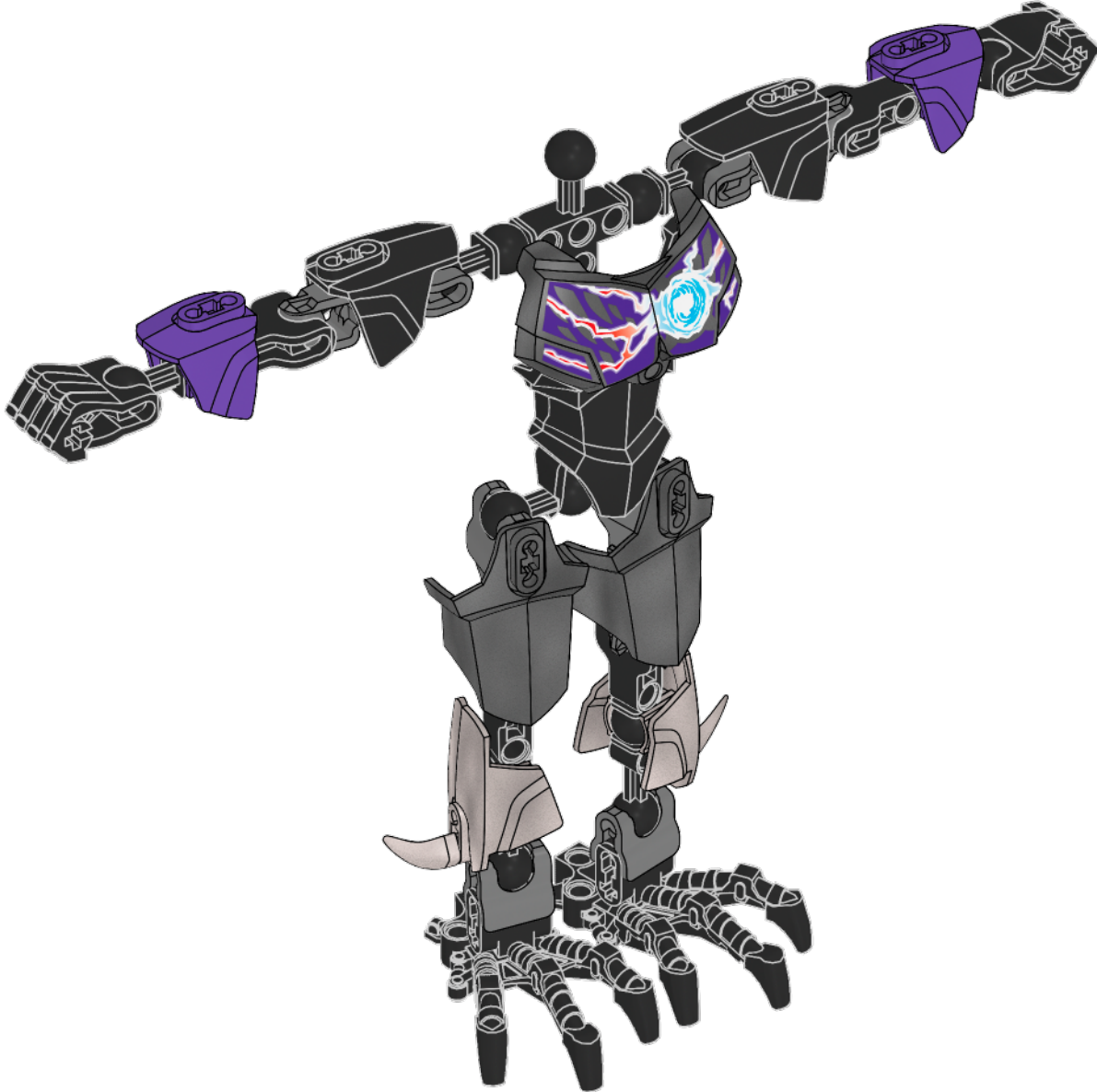

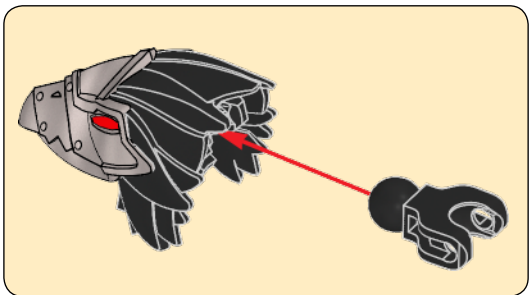
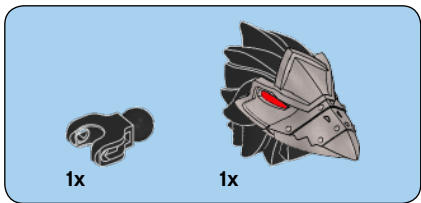

8

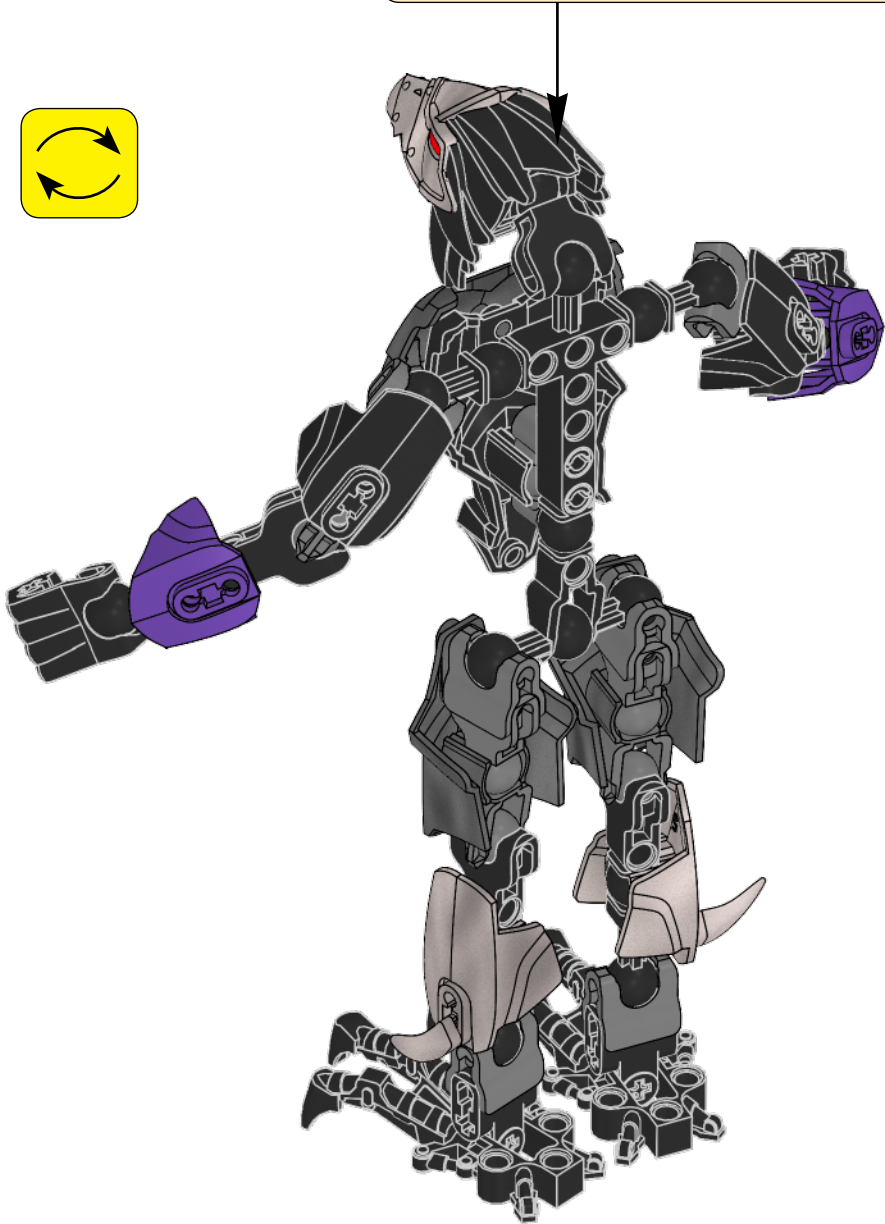



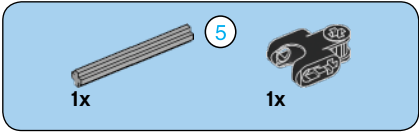
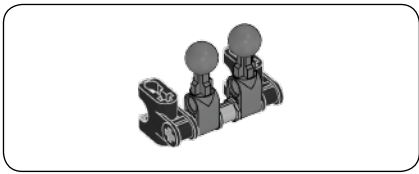

1

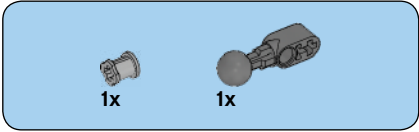
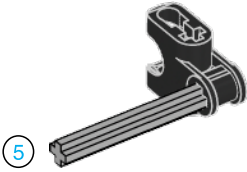

2

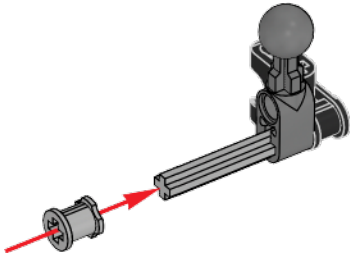

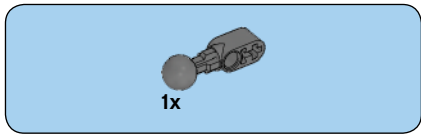

3

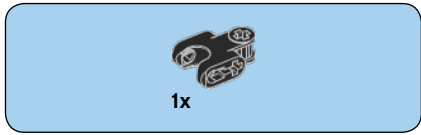
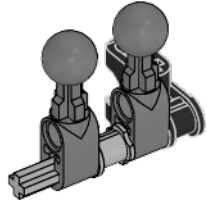

4

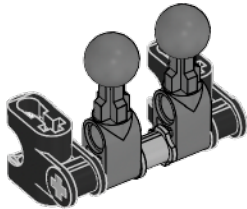

9

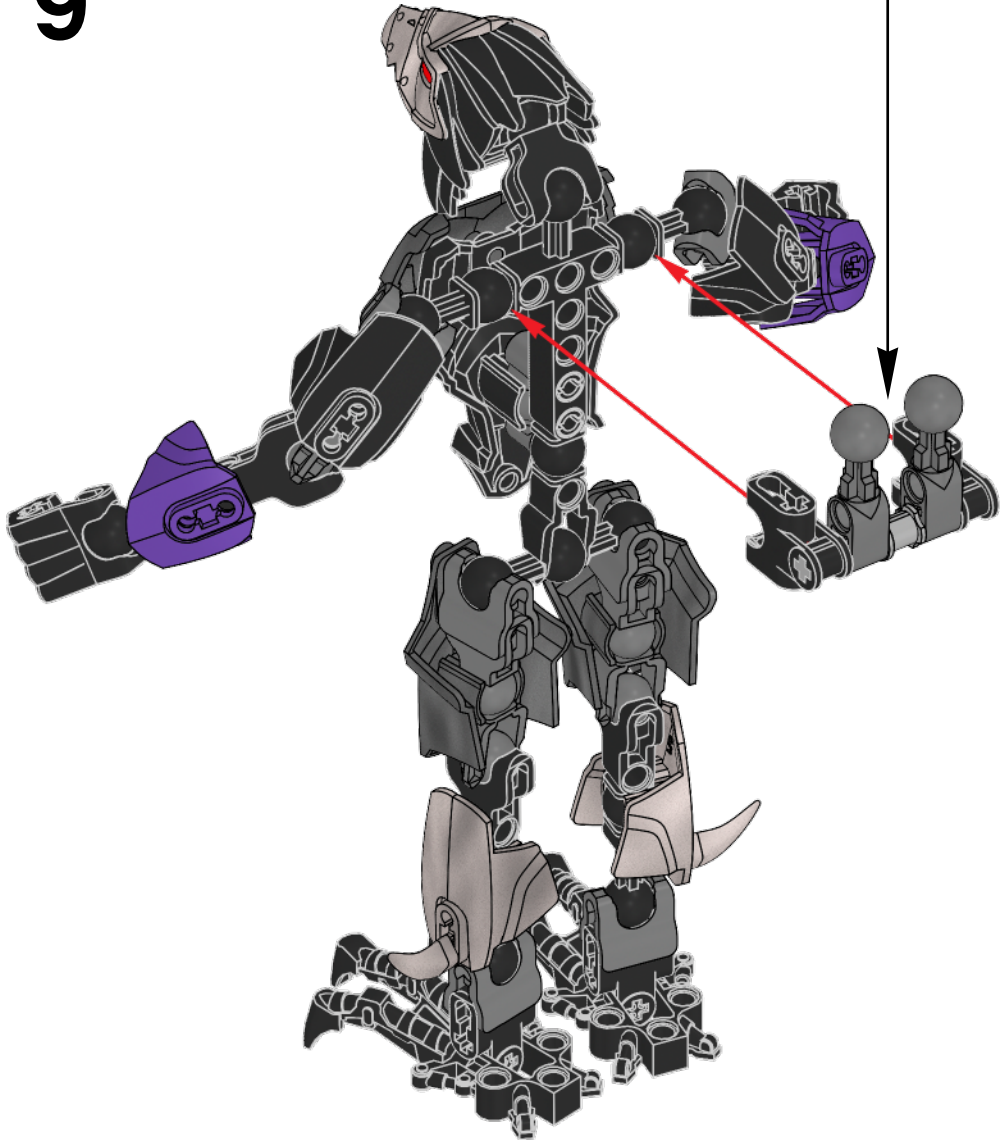

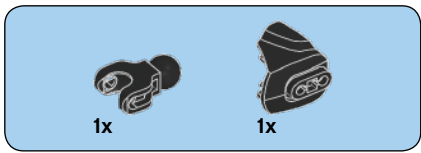

10

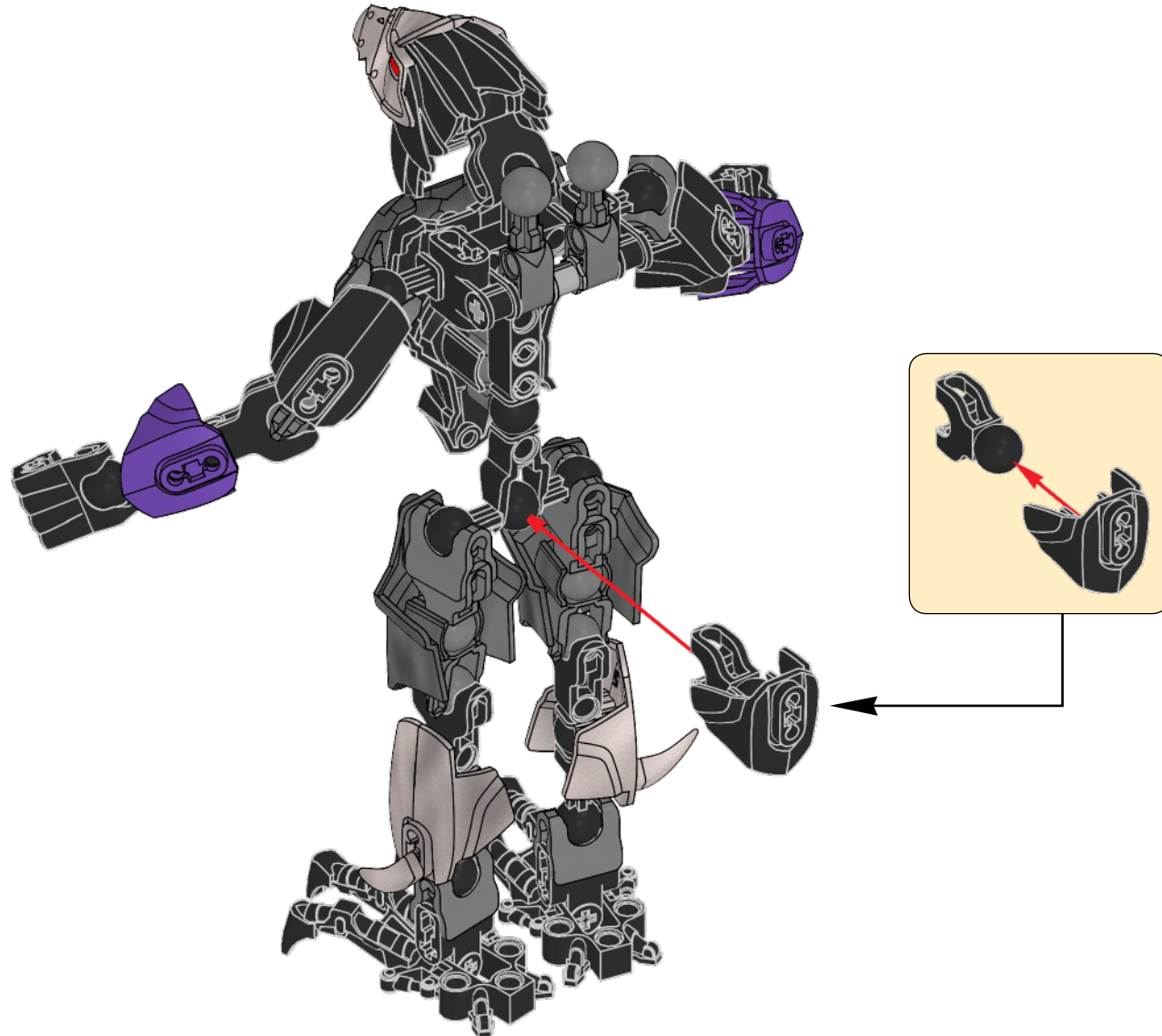

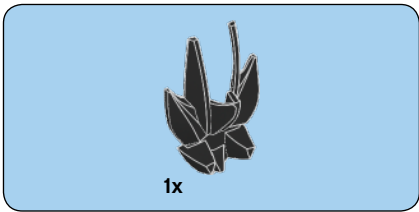

11

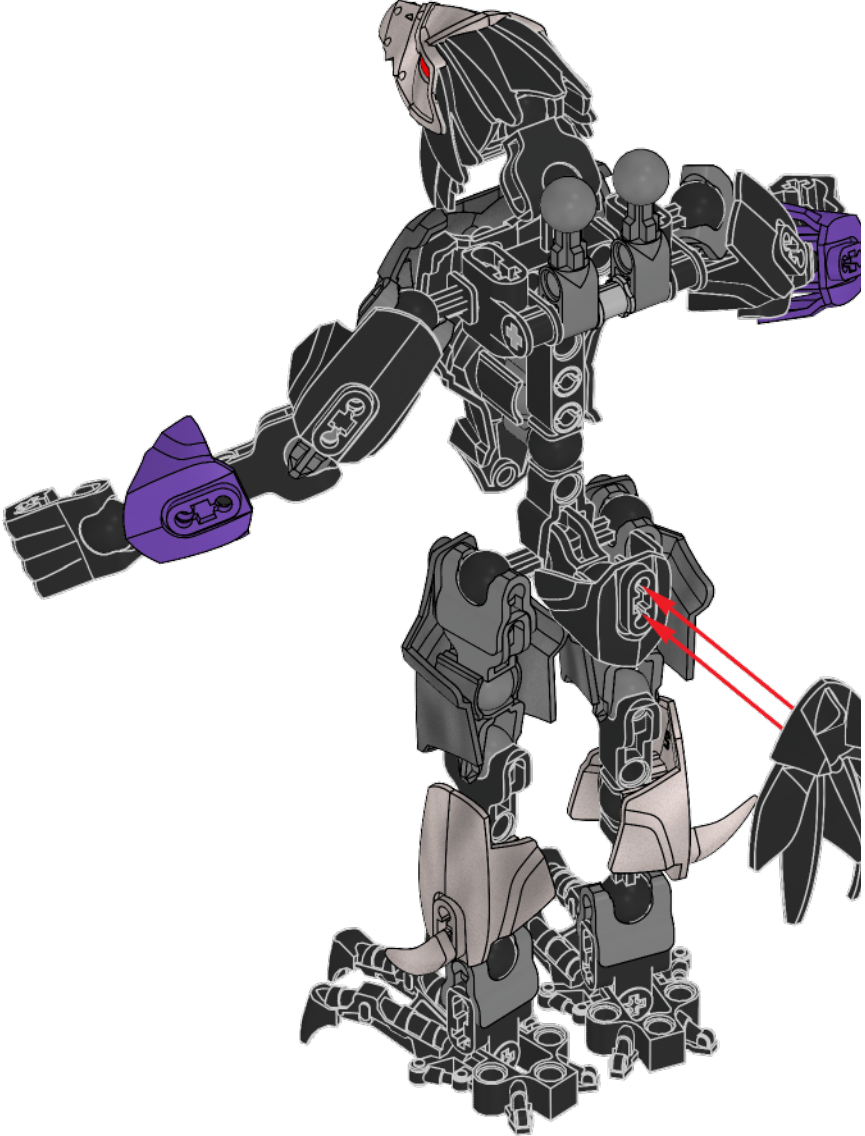

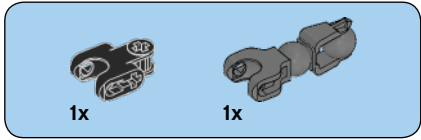
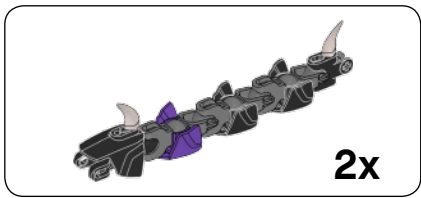

1

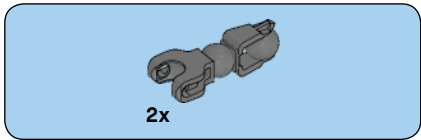
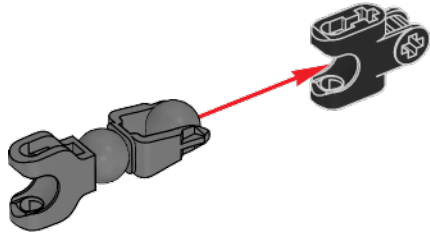

2

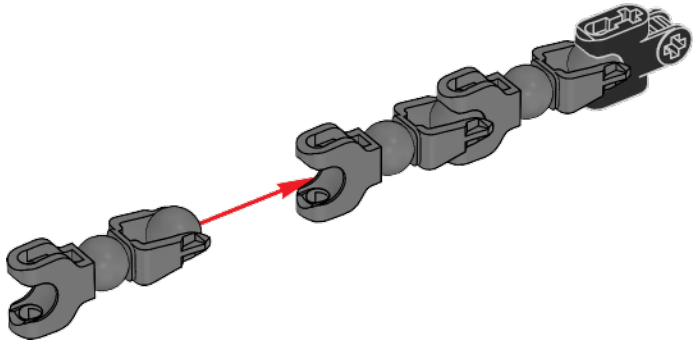

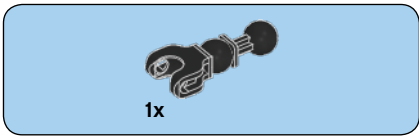

3

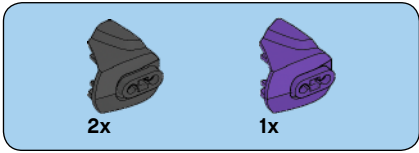
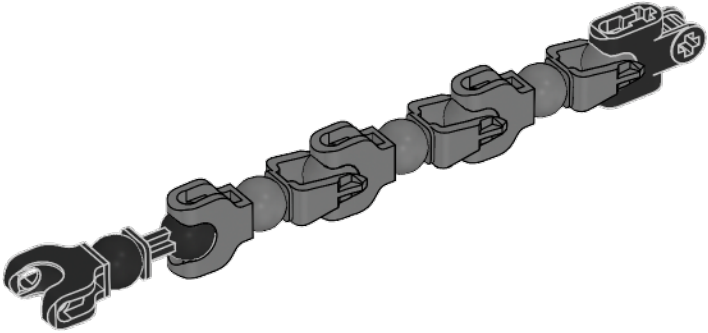

4

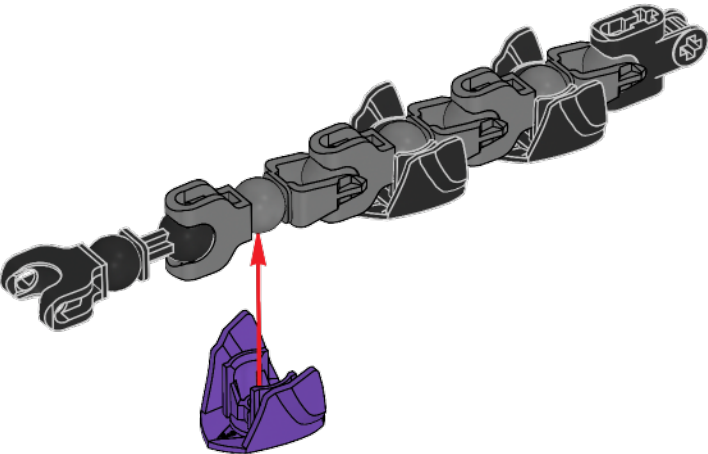

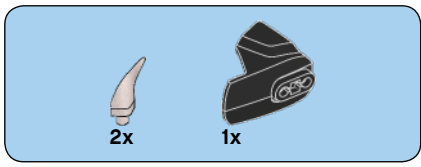

5

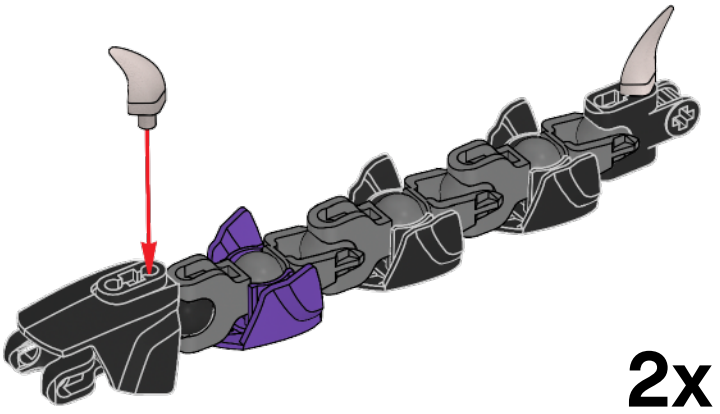



12

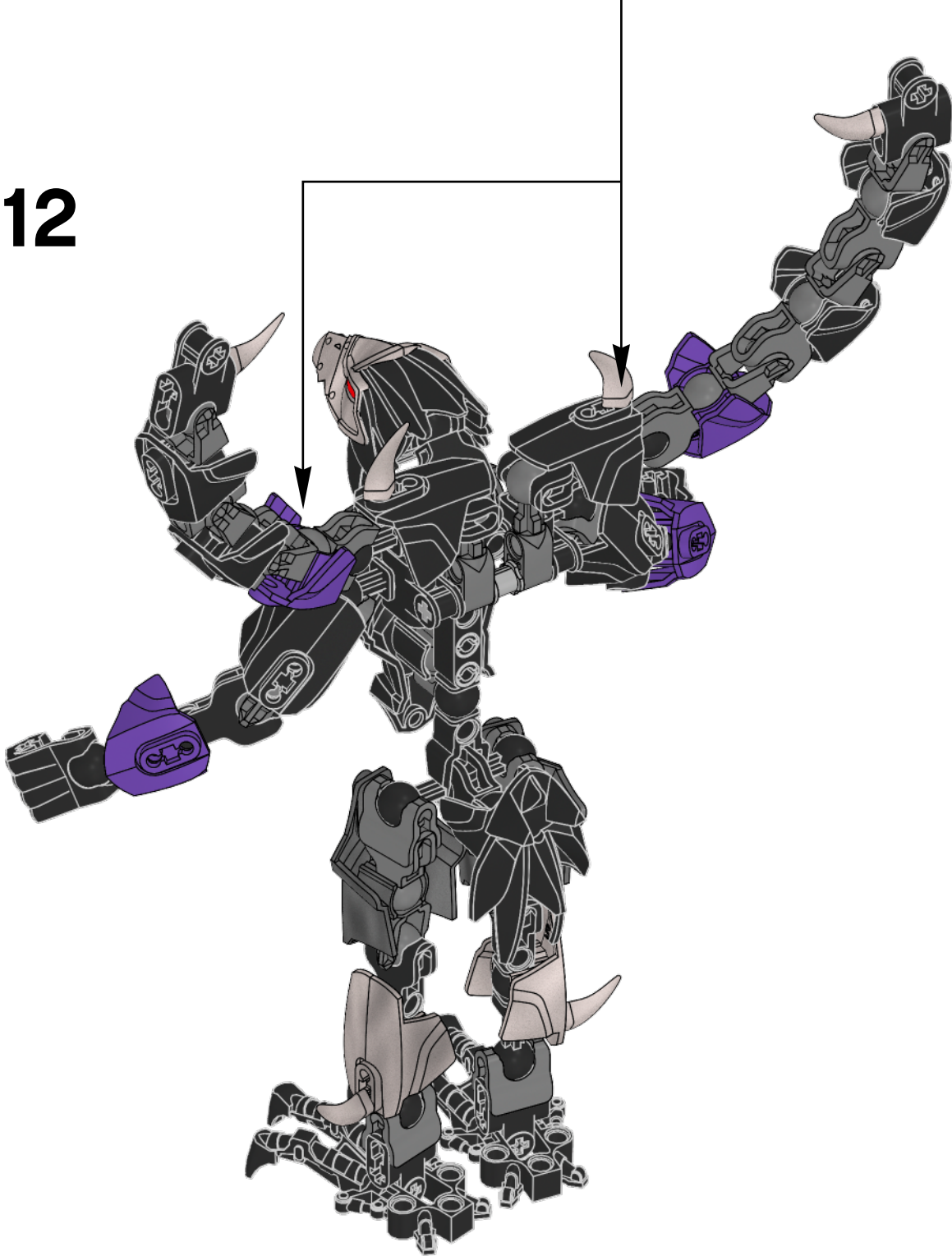

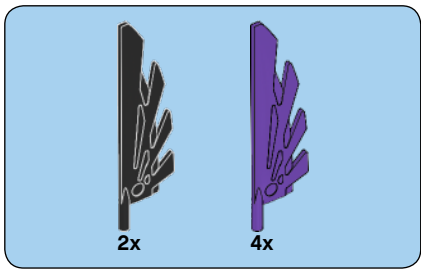

13

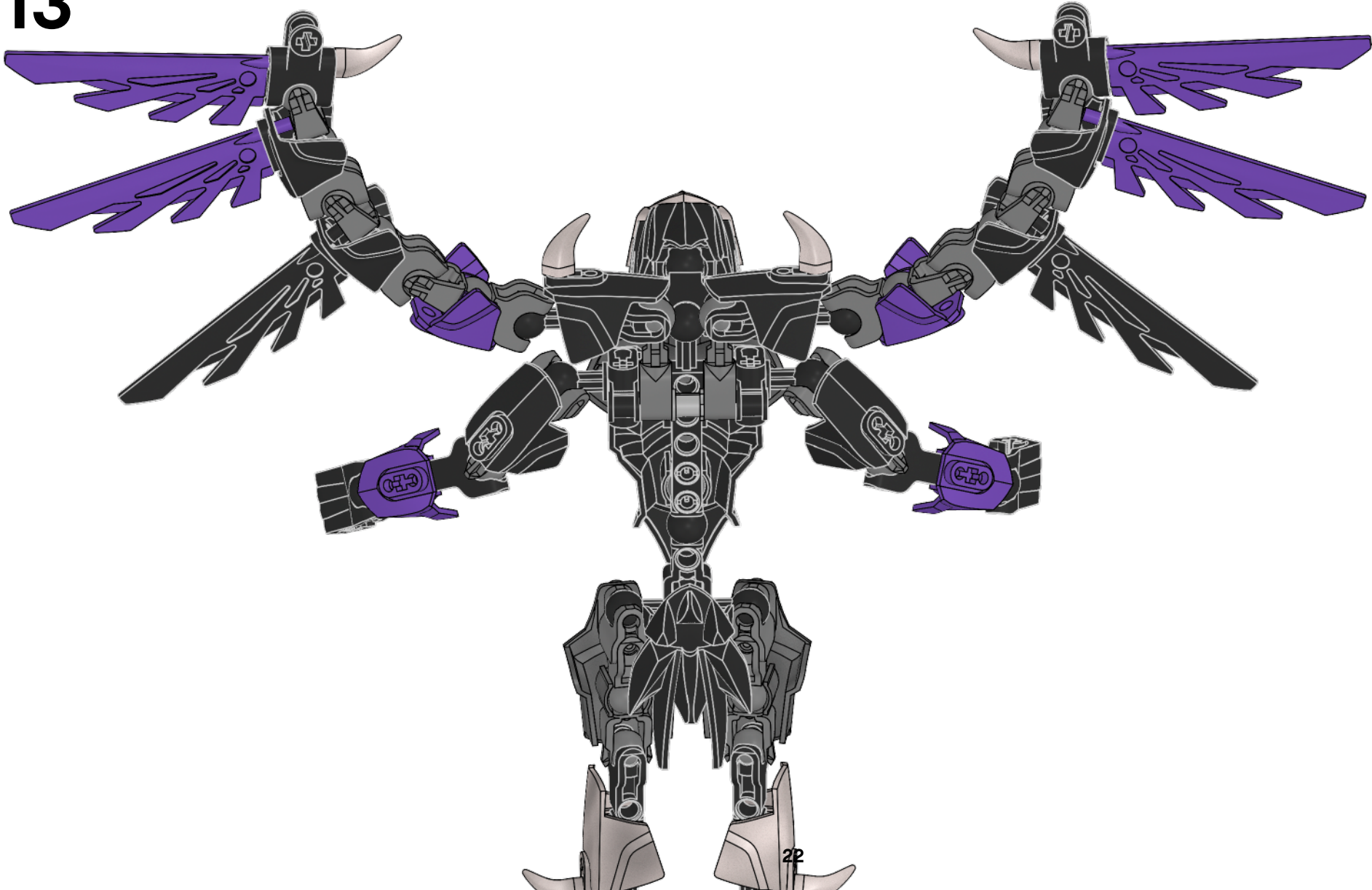

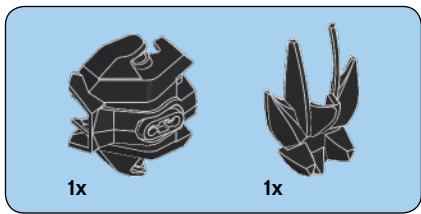

14

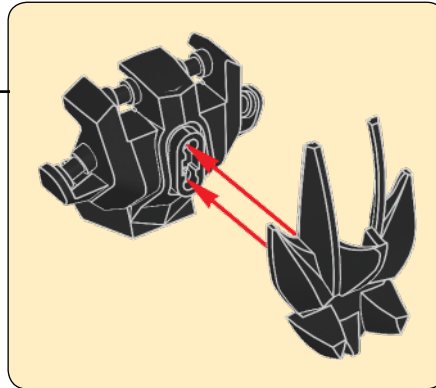
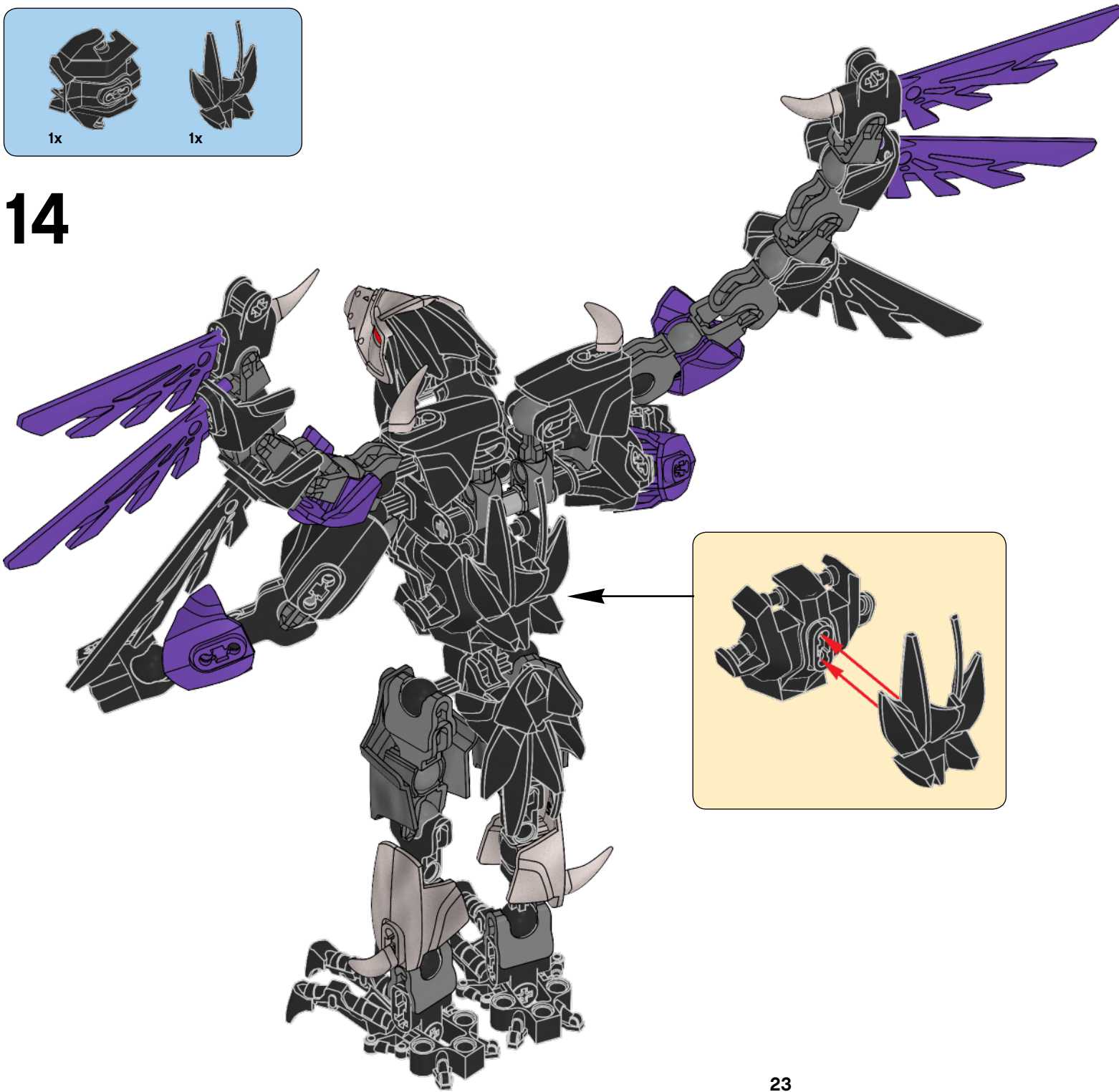

2x 1x 1x

15

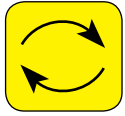

1 2



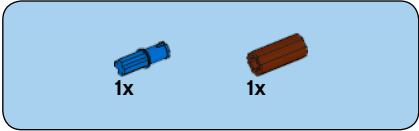
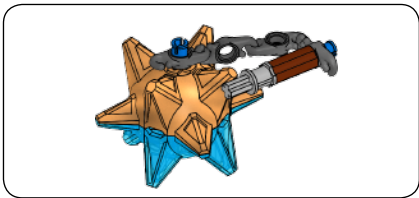

1

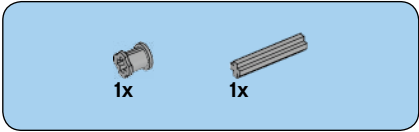
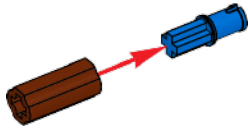

2

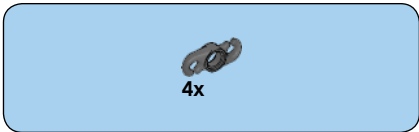
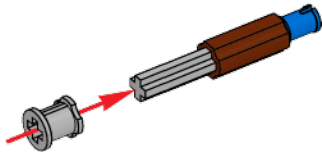

4

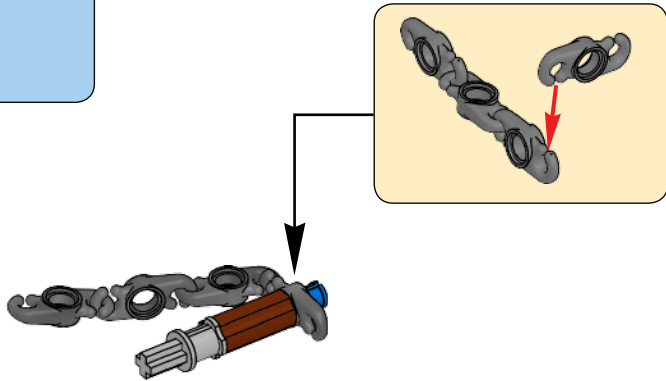

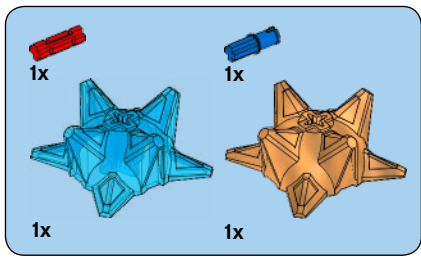

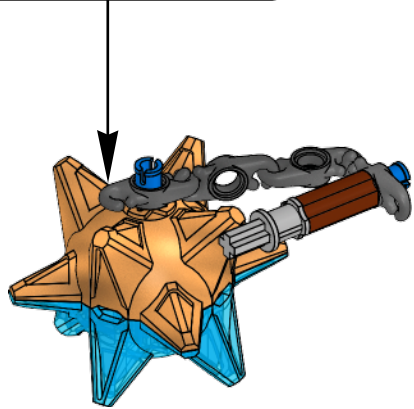
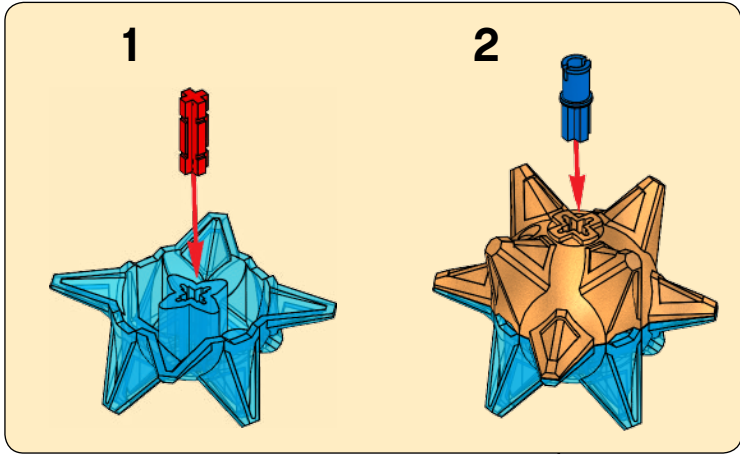

5



16



1x  1x  3

17





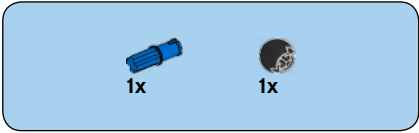
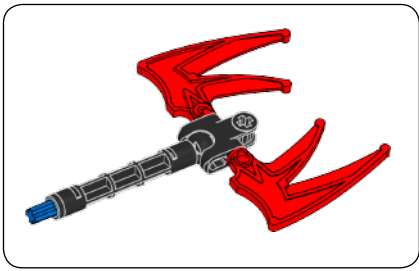

1

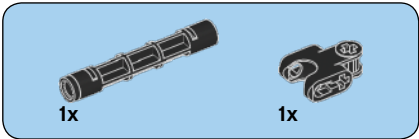
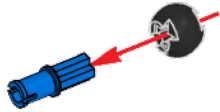

2

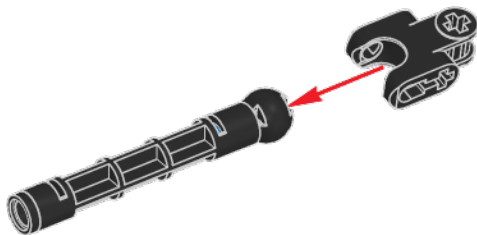

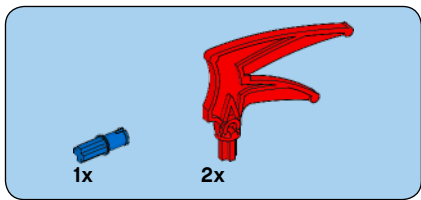

3

