



MARVEL SUPER HEROES



6867



1

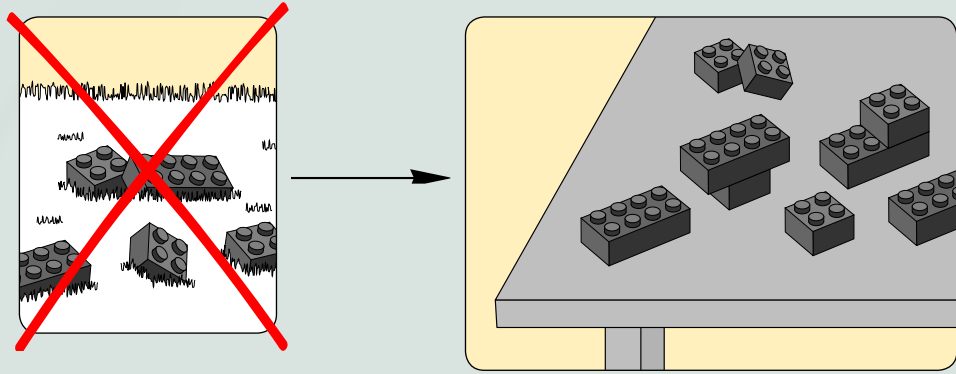

2

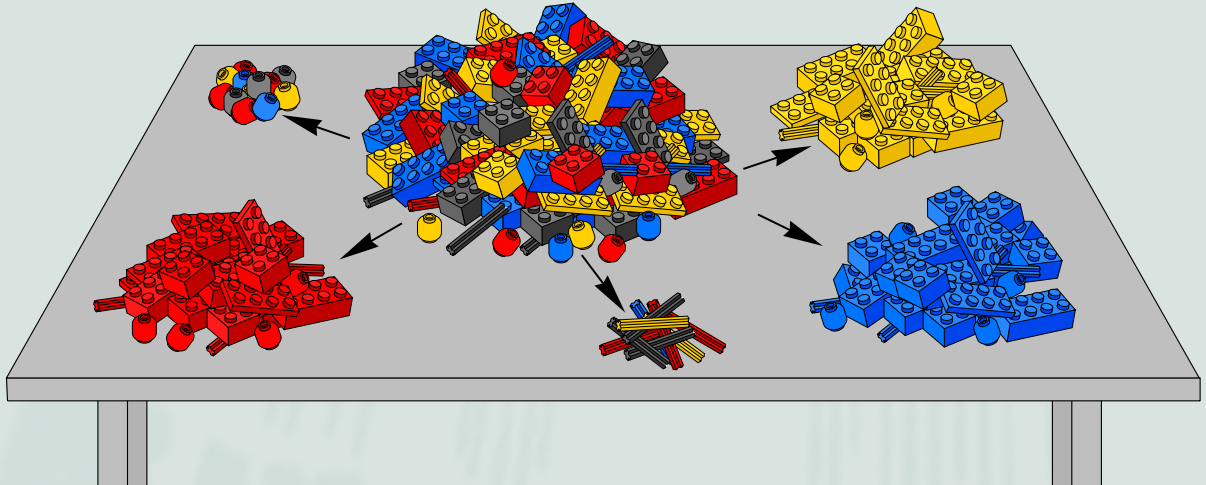

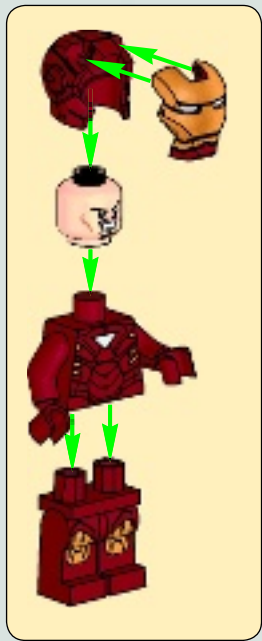

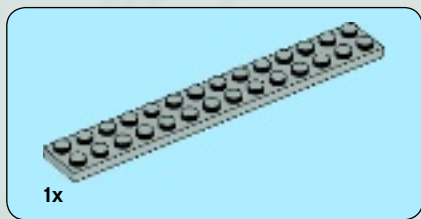

1x

1

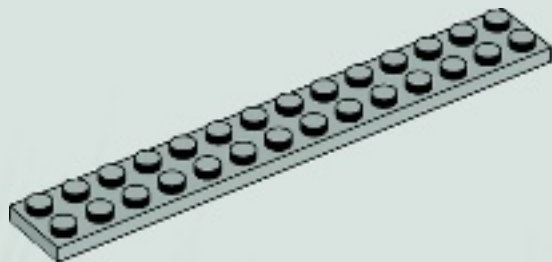



2

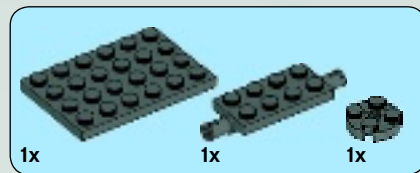
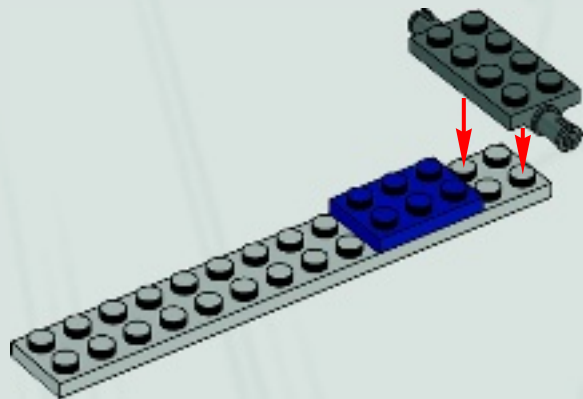

3

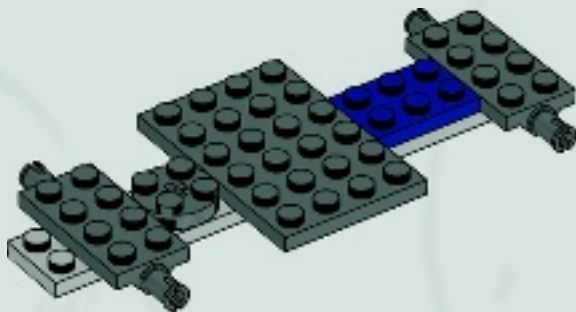



4

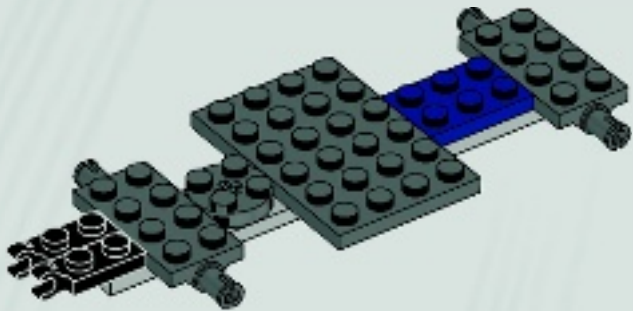

6

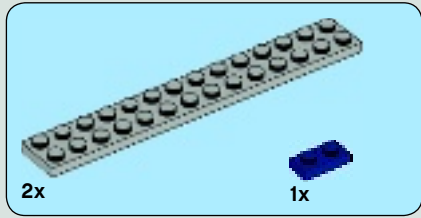

5





2x

6

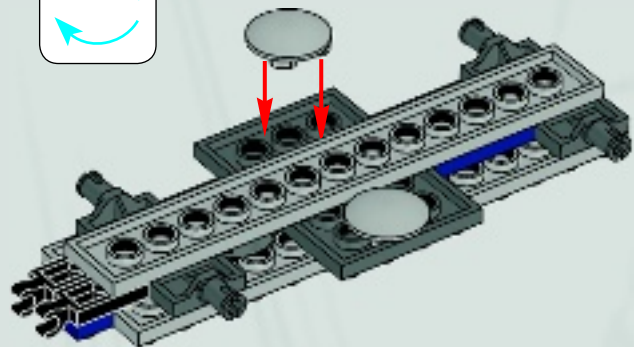
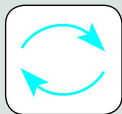

4x

7

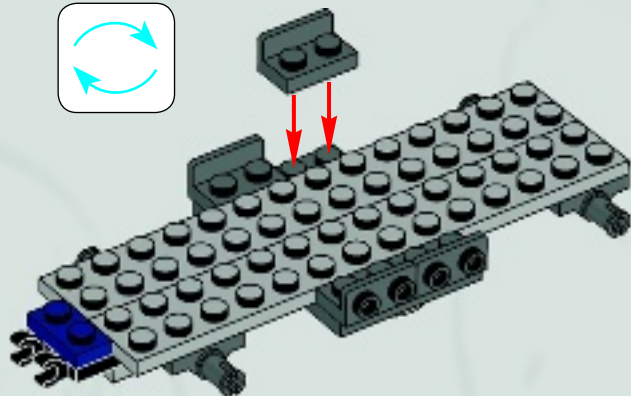
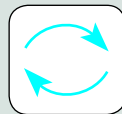



8

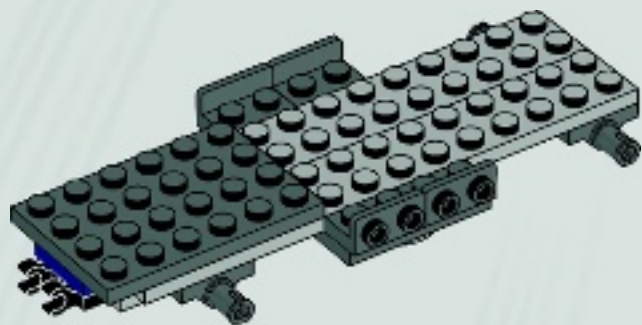

8



9

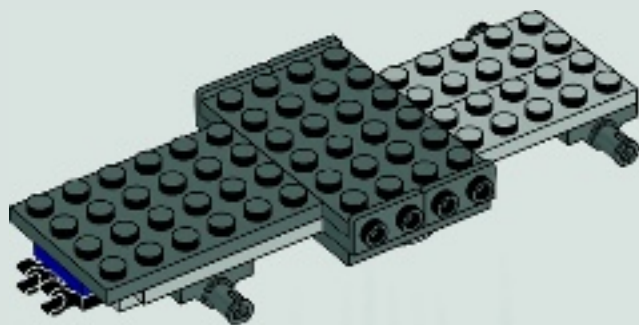

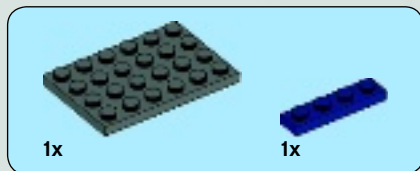

10

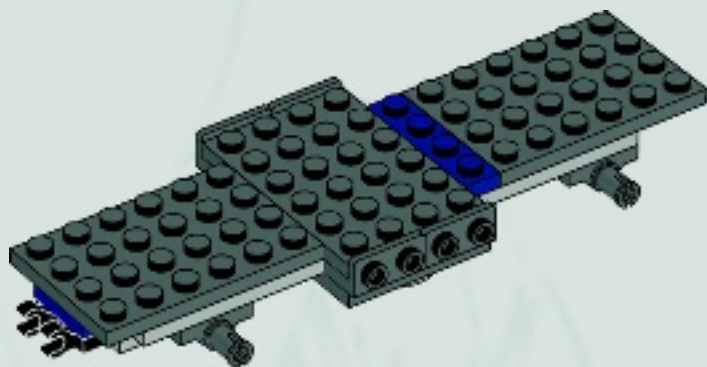



1x

11

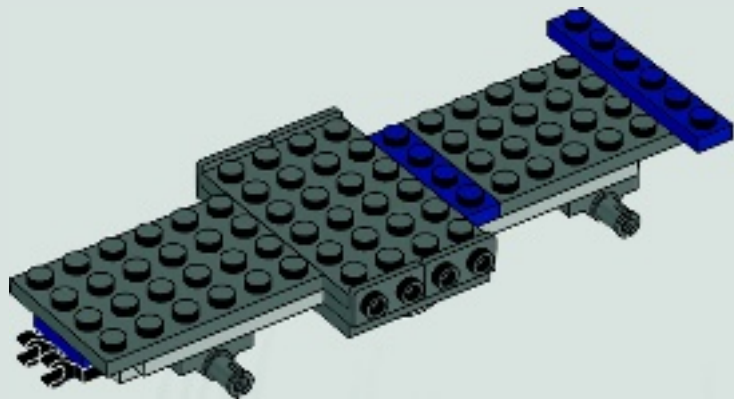



1x



2x



2x

12

1



2

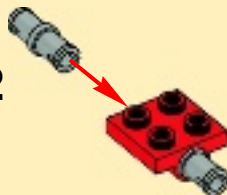

3

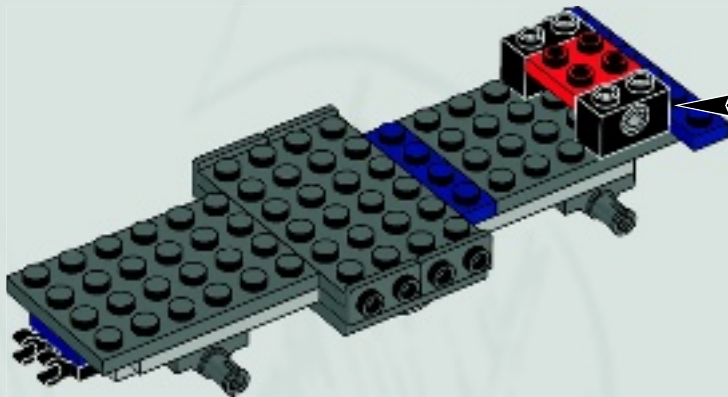
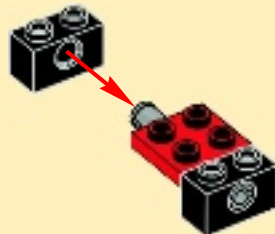



2x



1x



1x

13

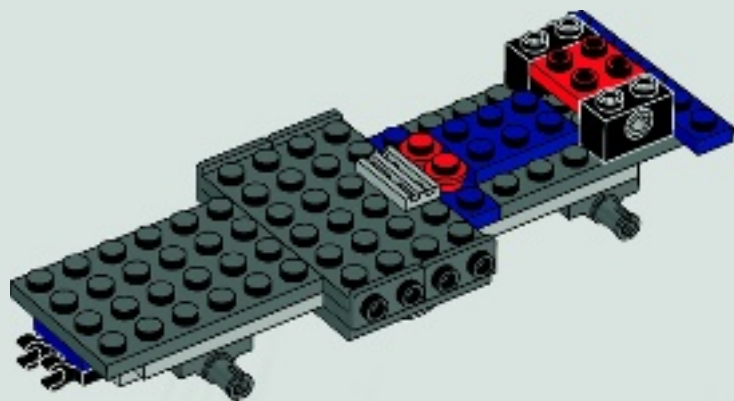



2x



2x

14

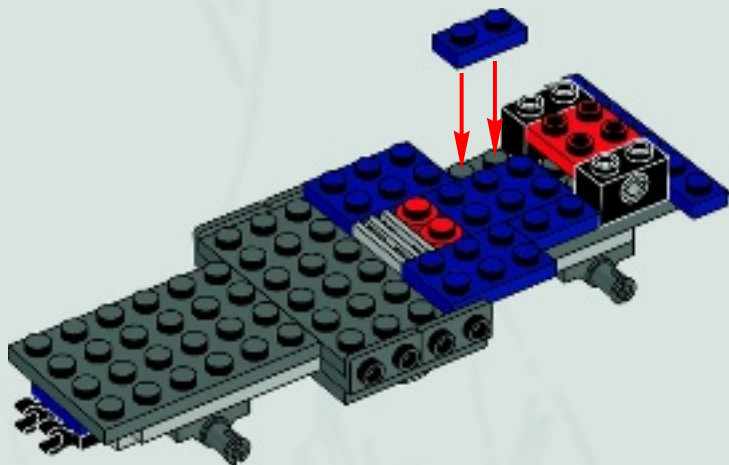



2x



2x

15

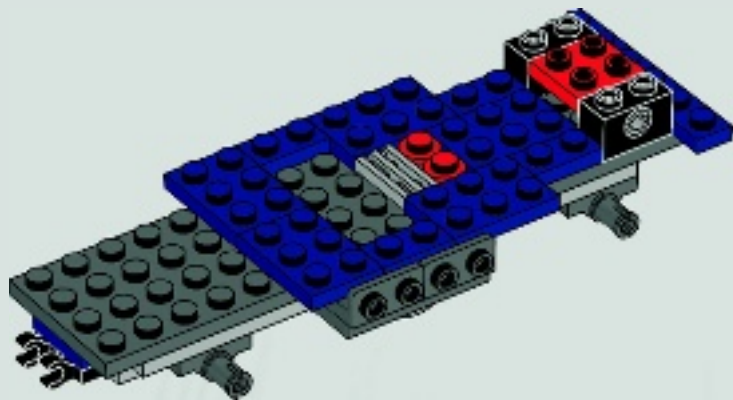



16

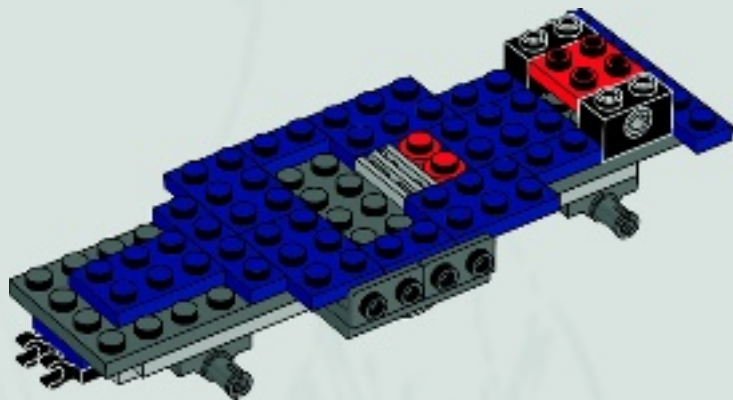



1x

17

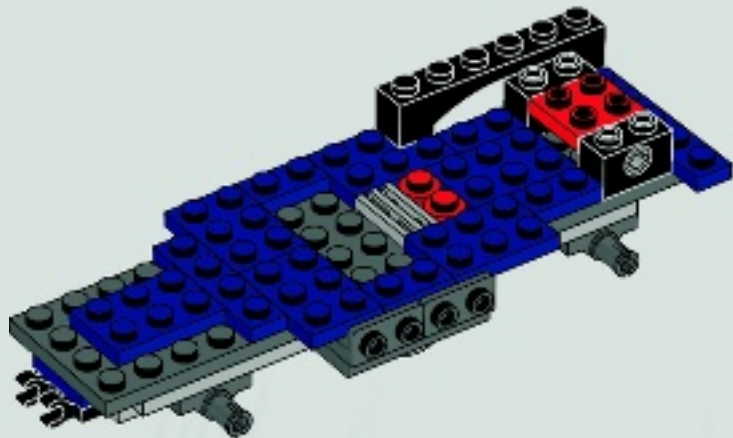



4x

18

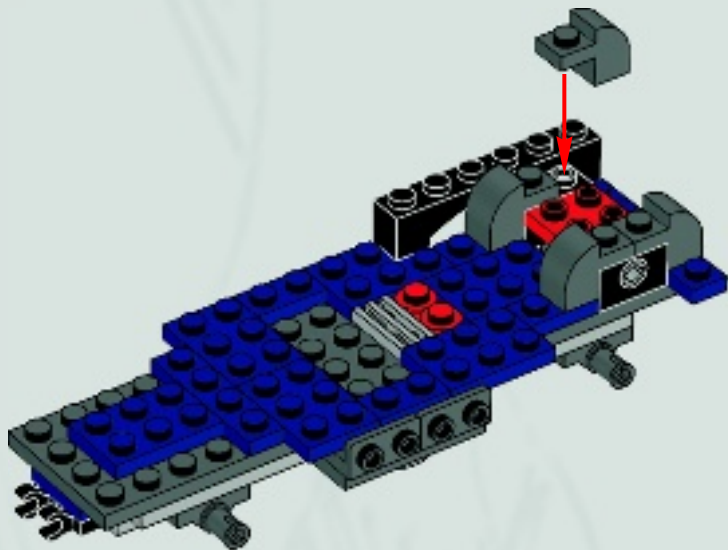



1x



2x

19

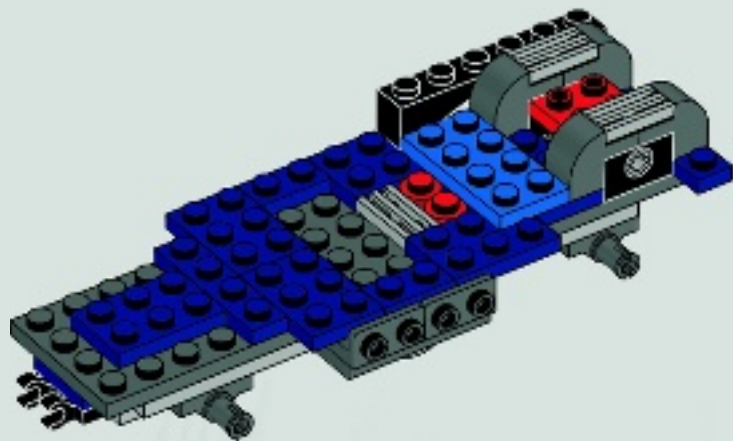

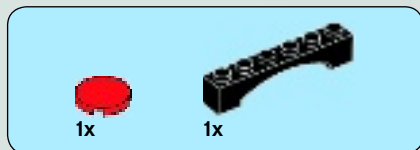

20

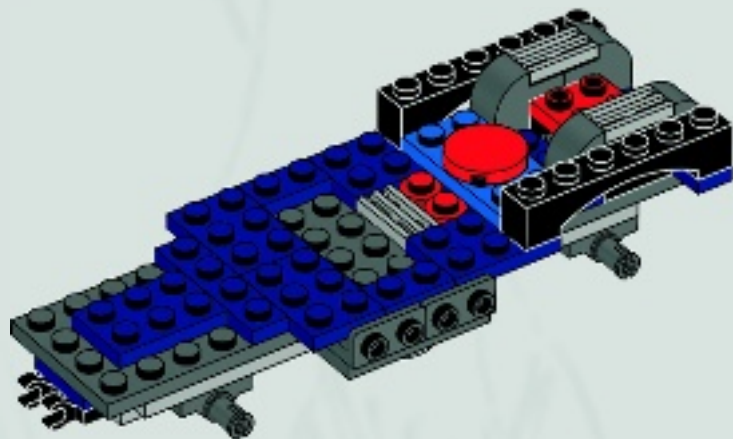

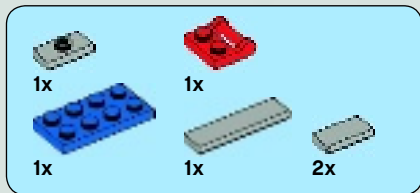

21

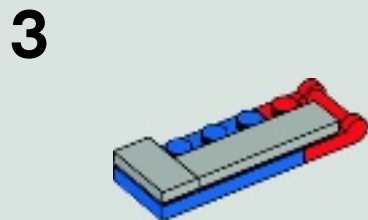
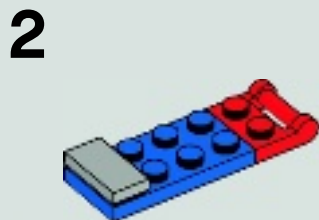
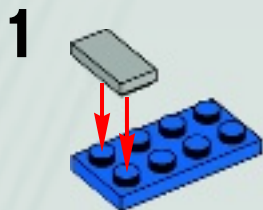

4

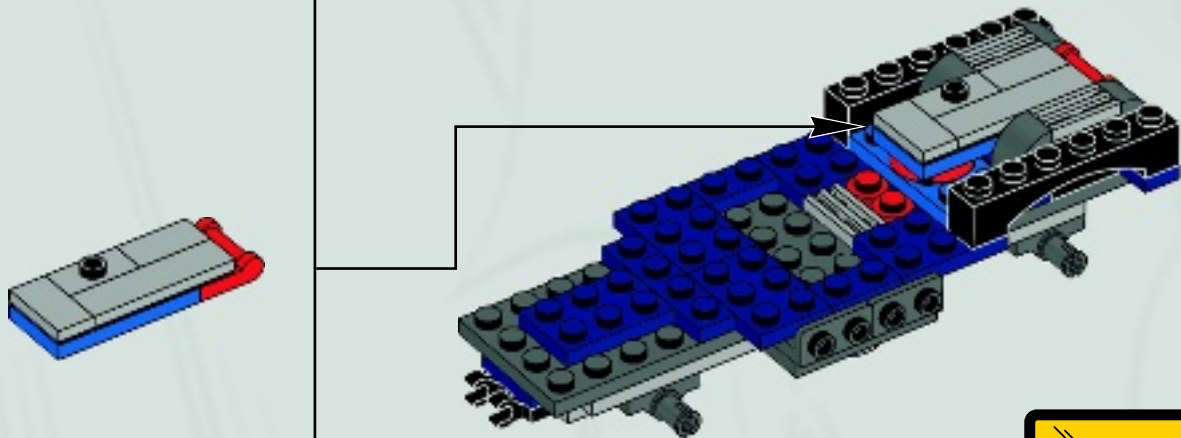

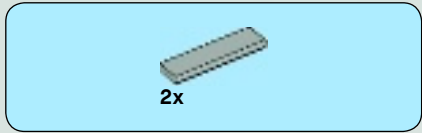

22

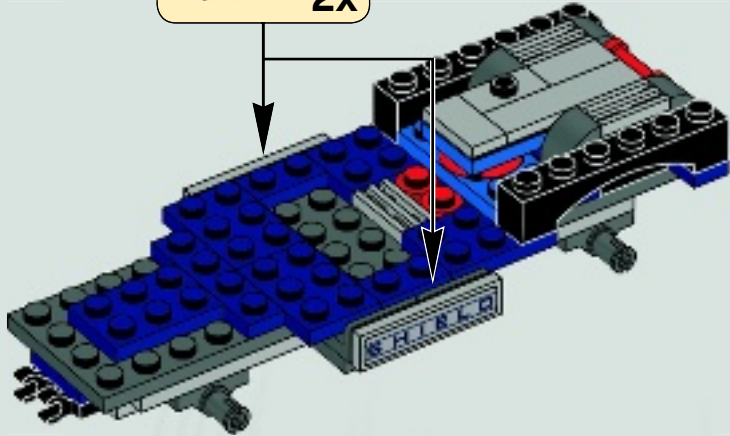
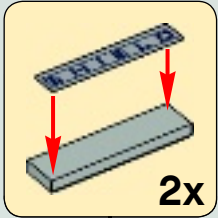



2x

23

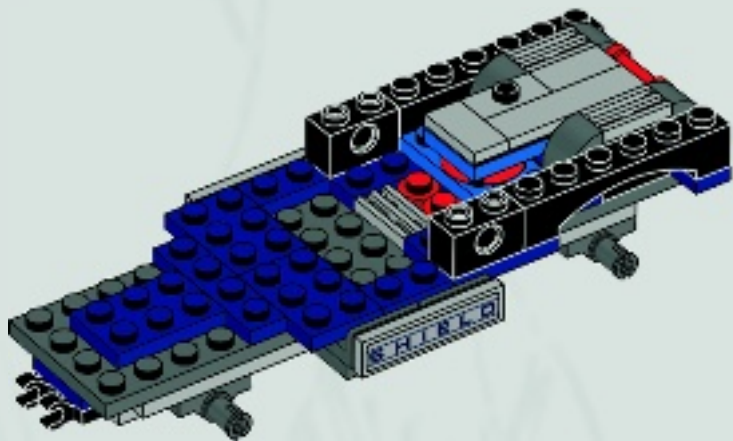

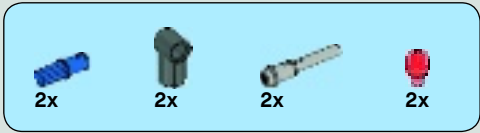

24

1

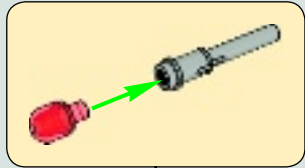
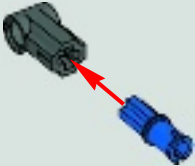

2

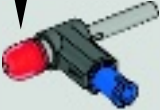

2x

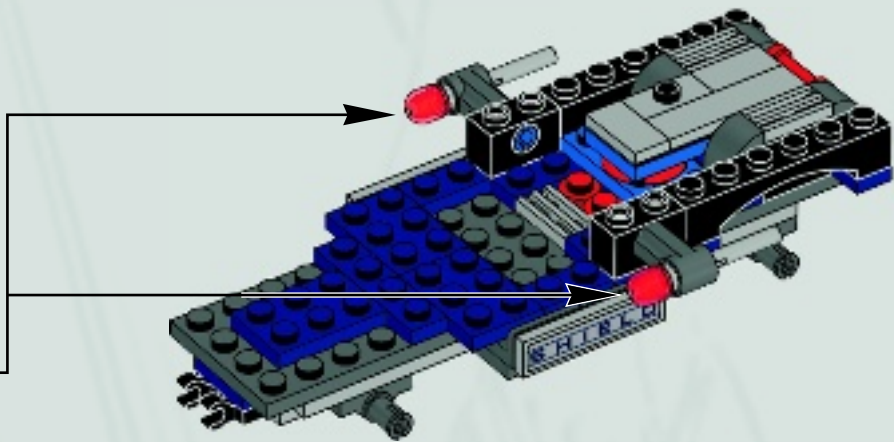



1x



1x



1x

25

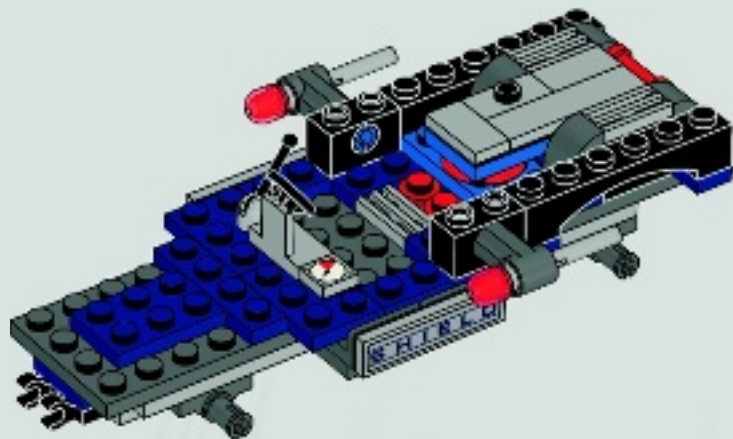



1x

26

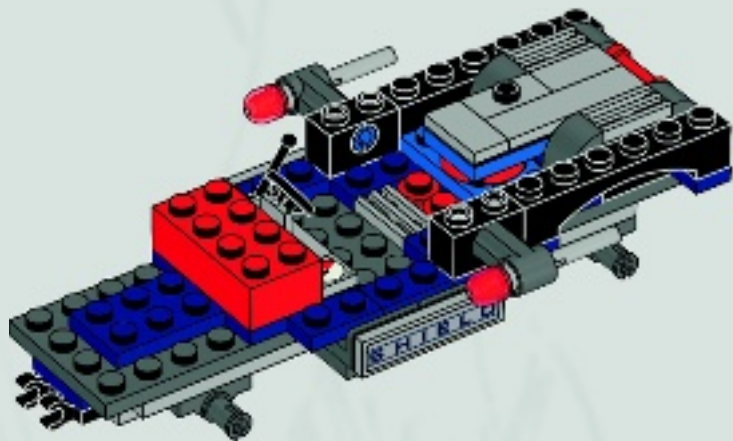

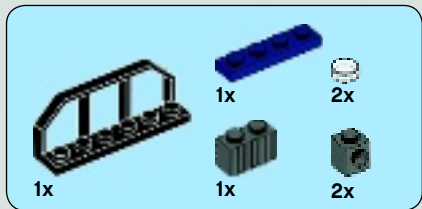

27

1



2

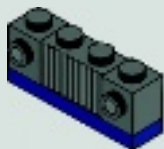

3

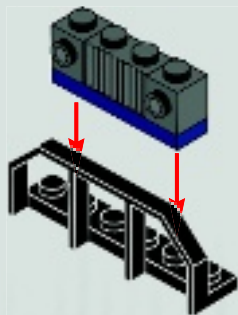

4

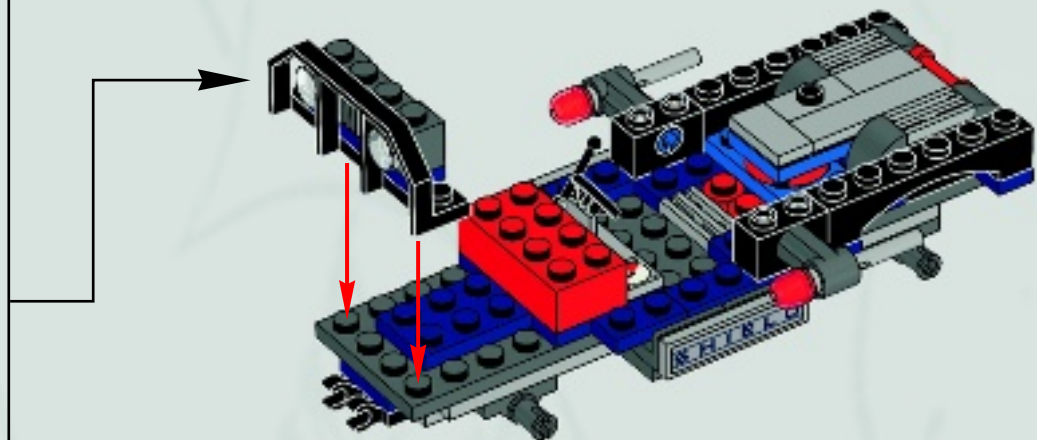
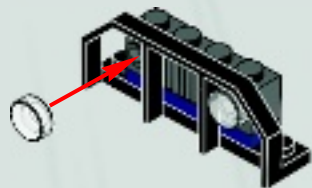



2x

28

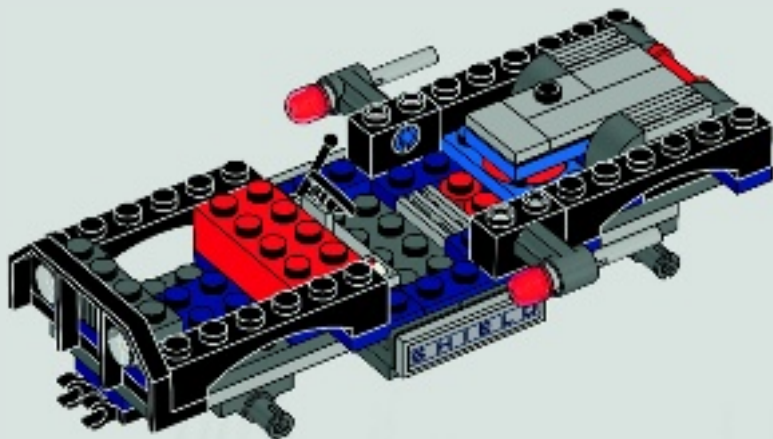



4x

29

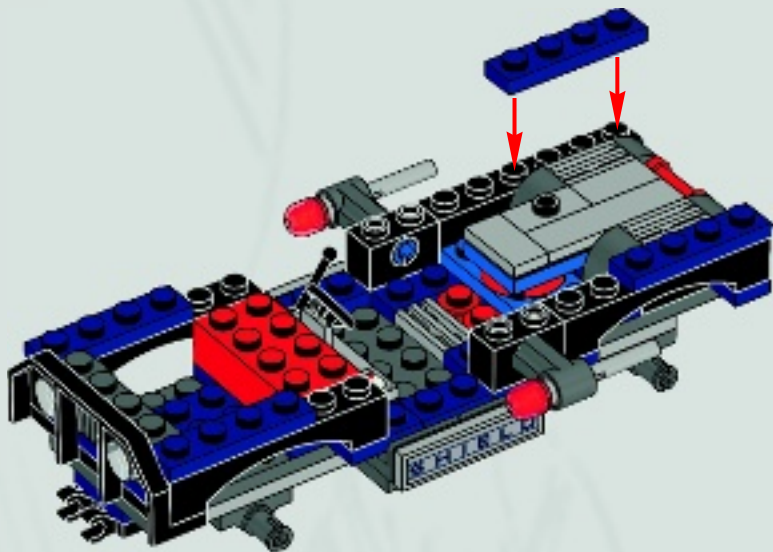



2x



2x

30

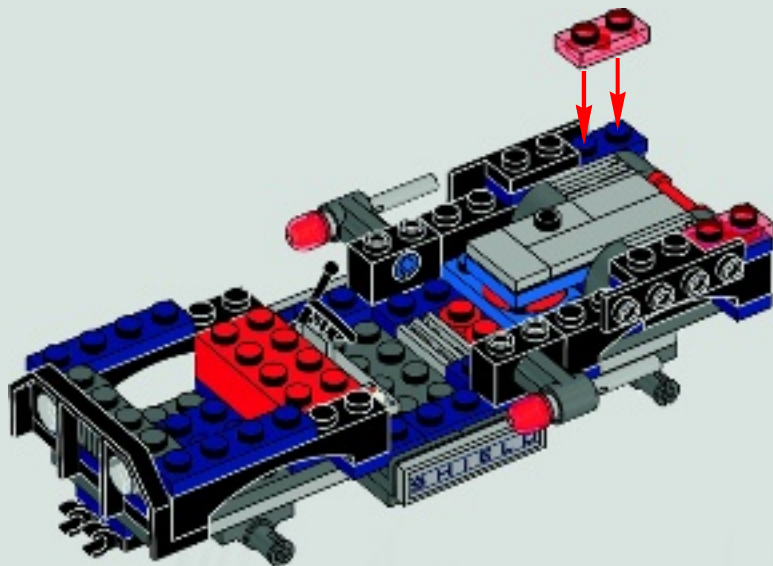



31

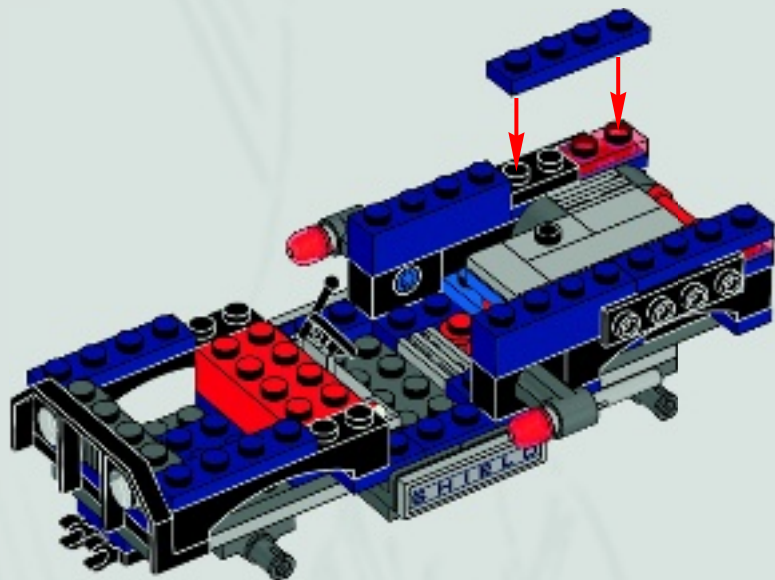

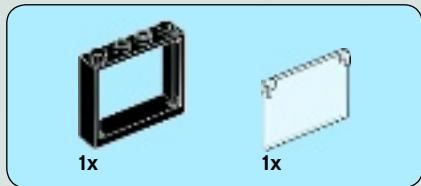

32

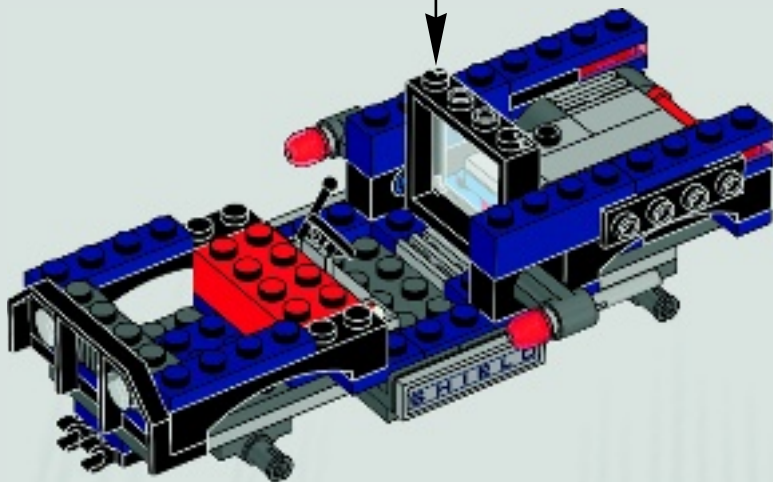
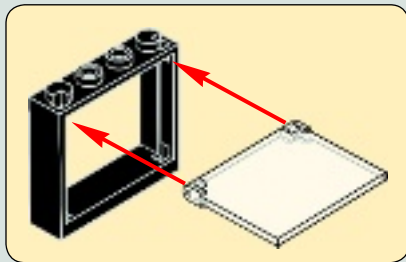



1x

33

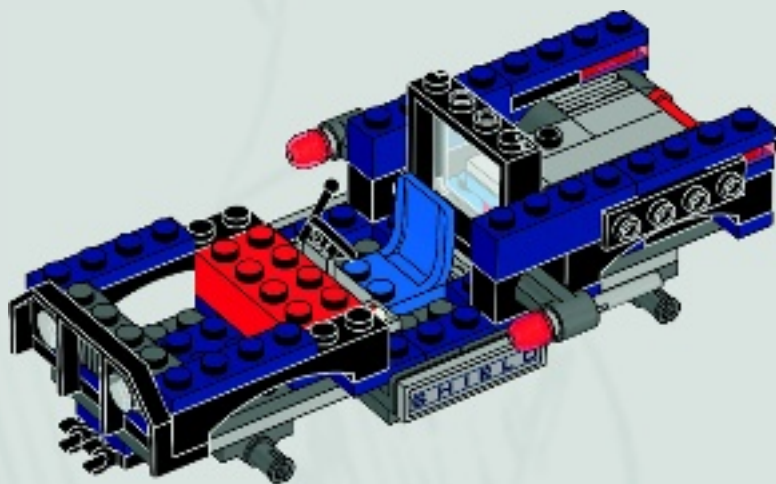

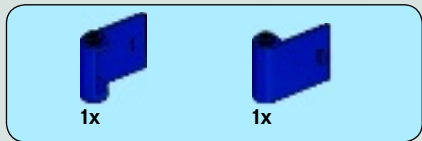

34

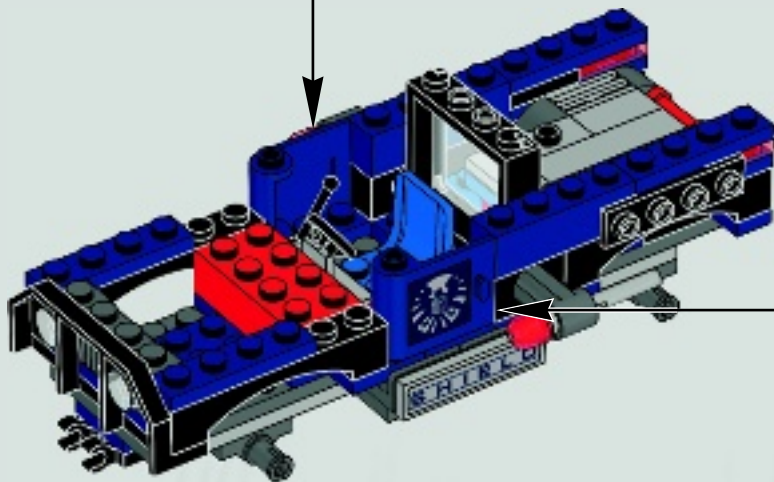
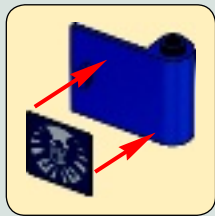



3x

35

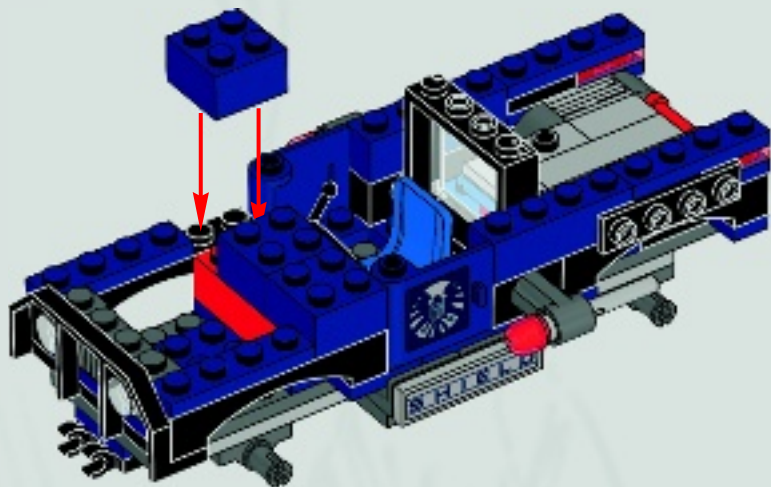



2x

36

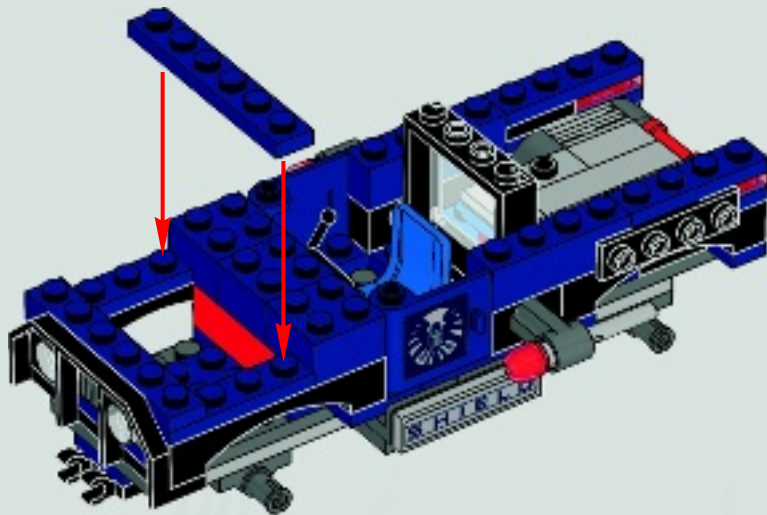



2x

37

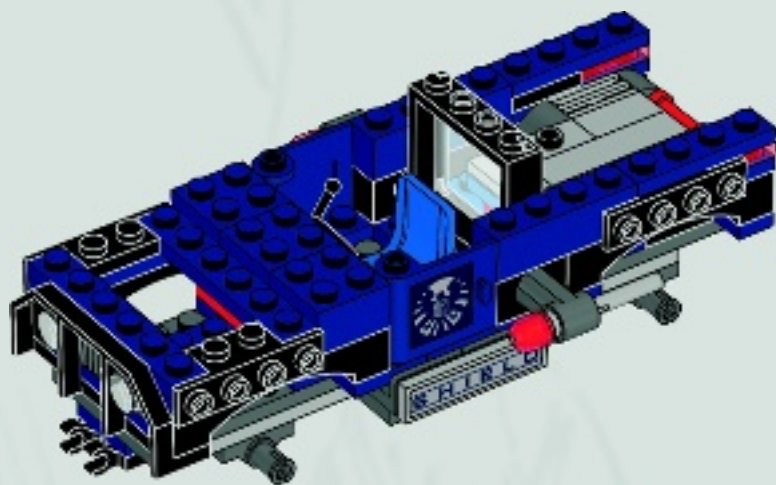



2x

38

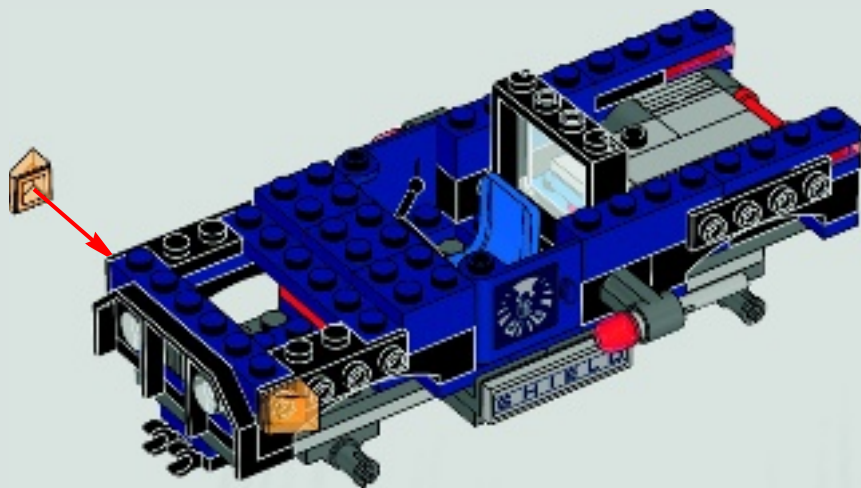



39

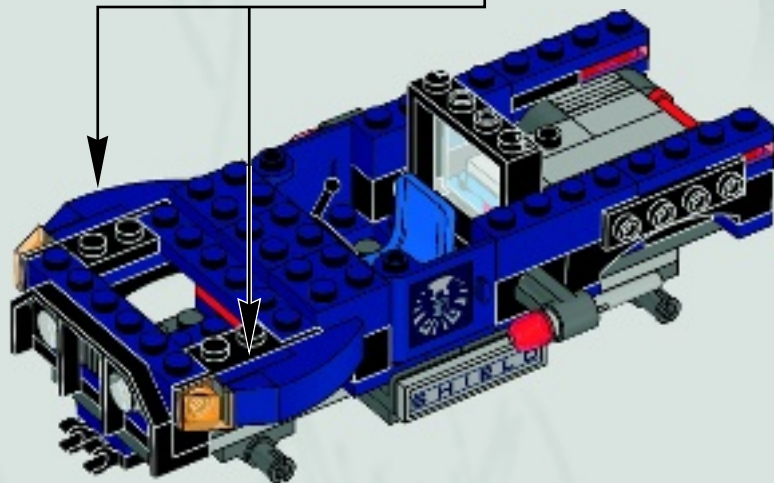
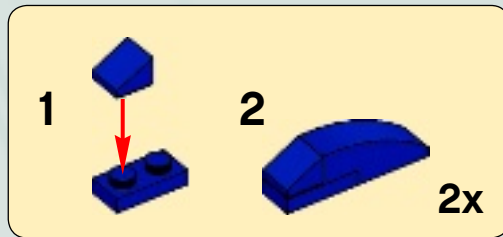

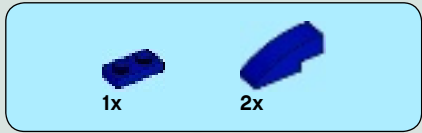

40

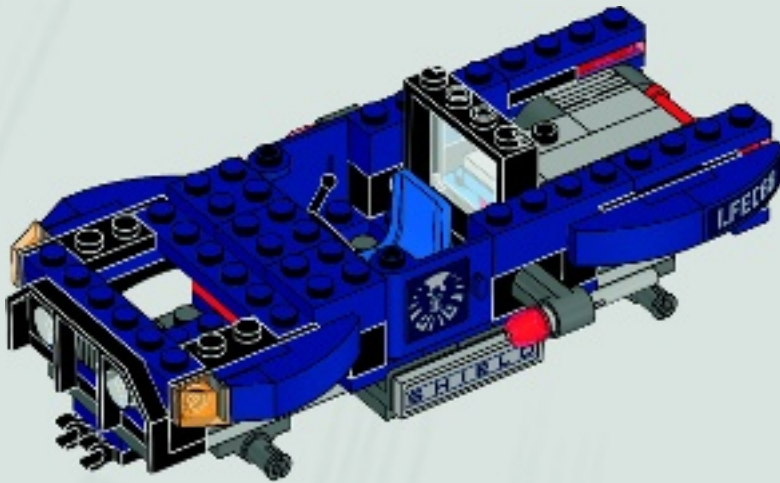
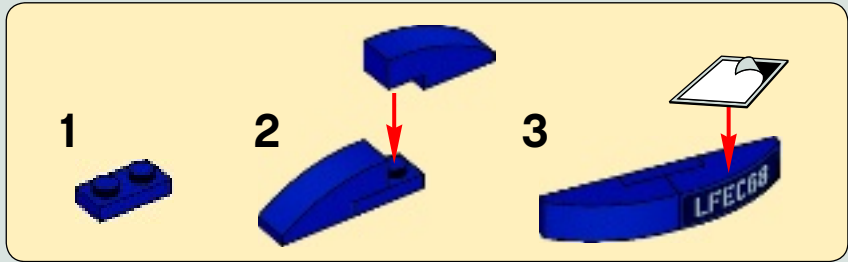



41

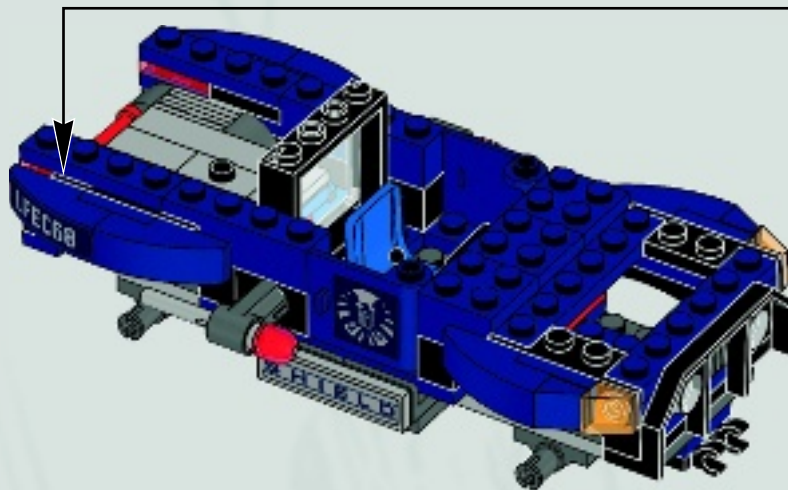
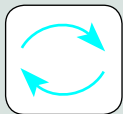
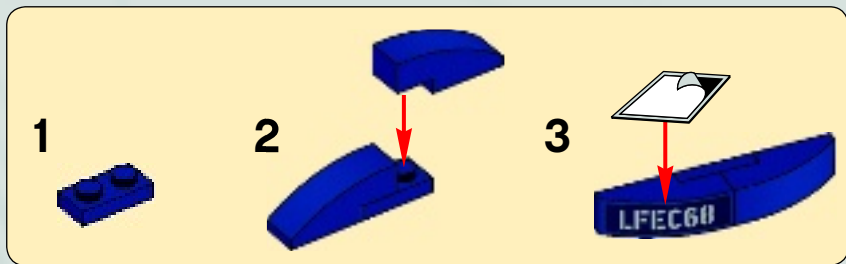

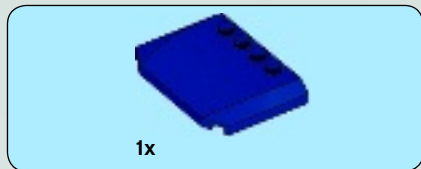

42

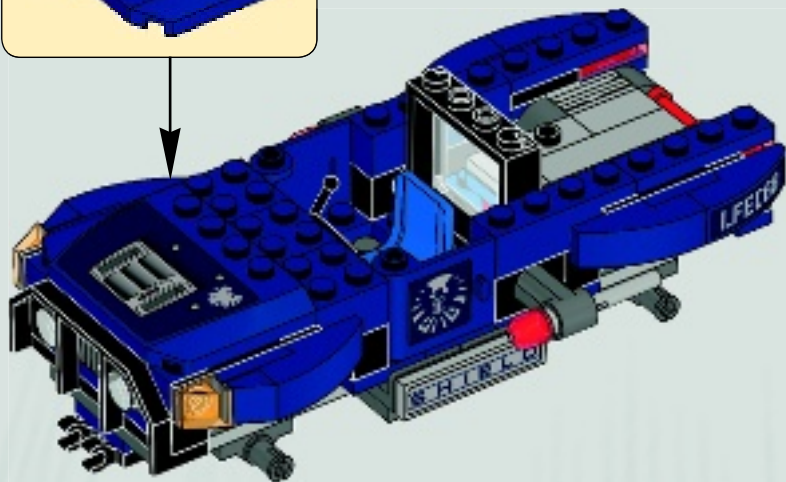
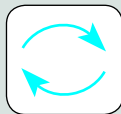



2x

43

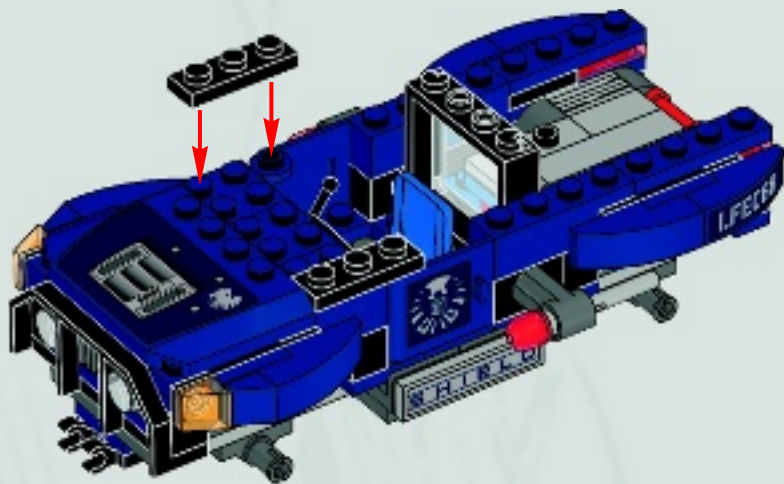



2x



2x

44

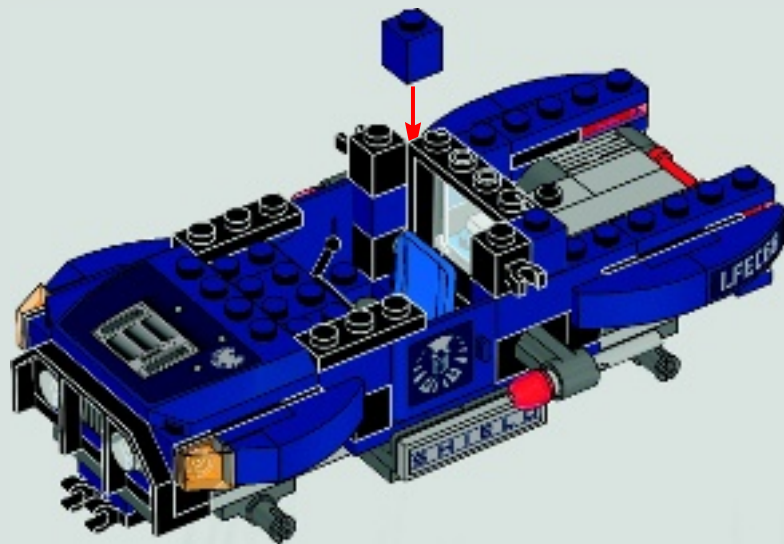



4x

45

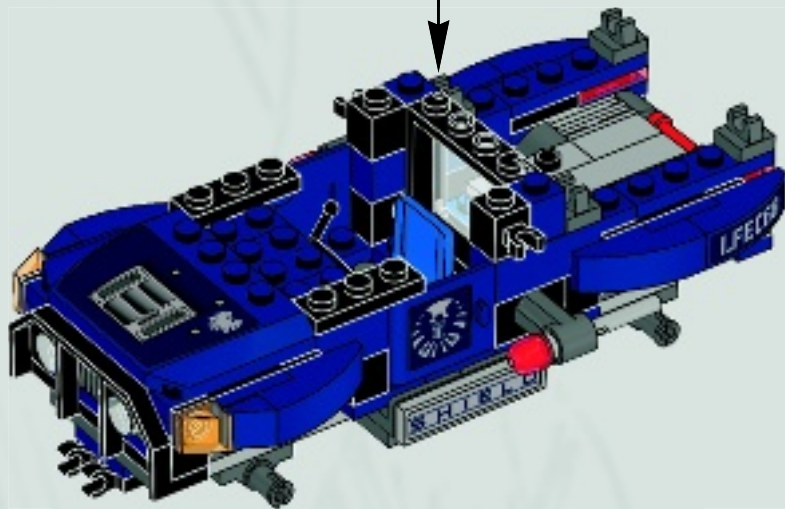

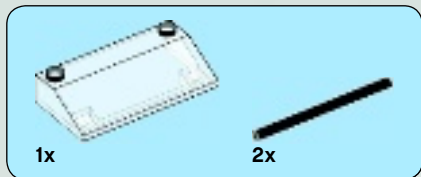

46

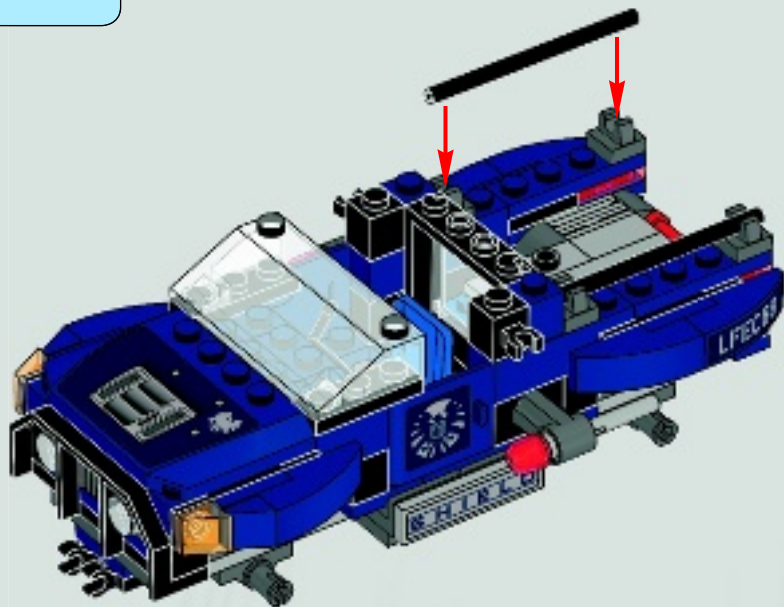



1x



2x

47

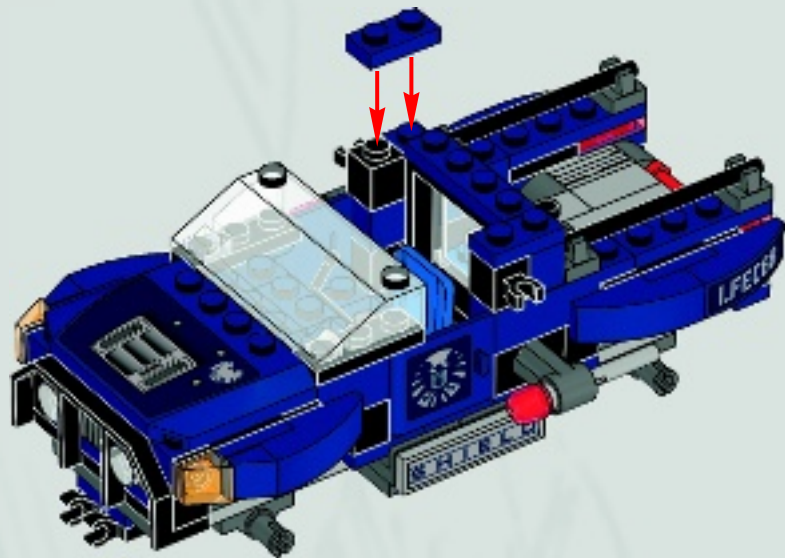

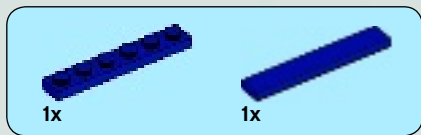

48

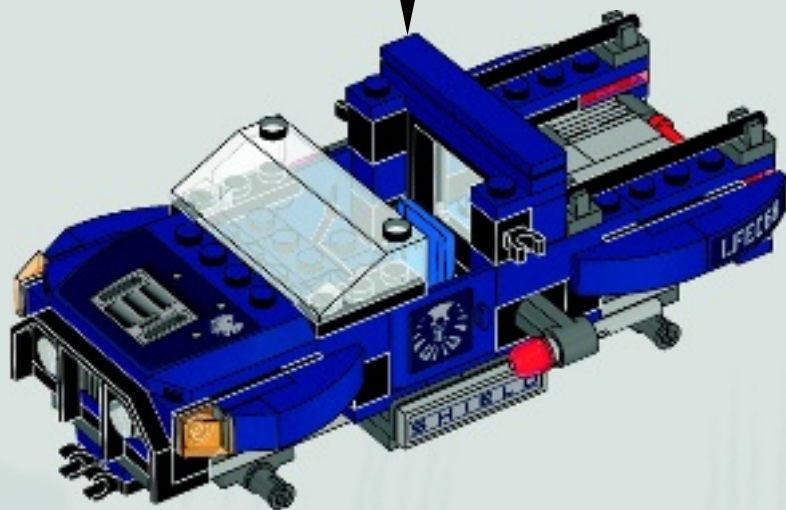
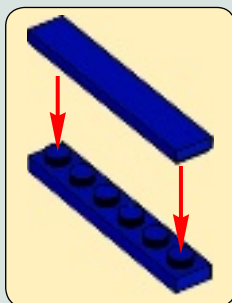

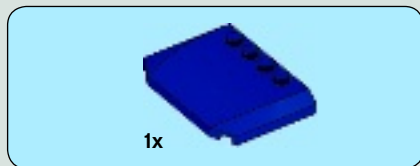

49

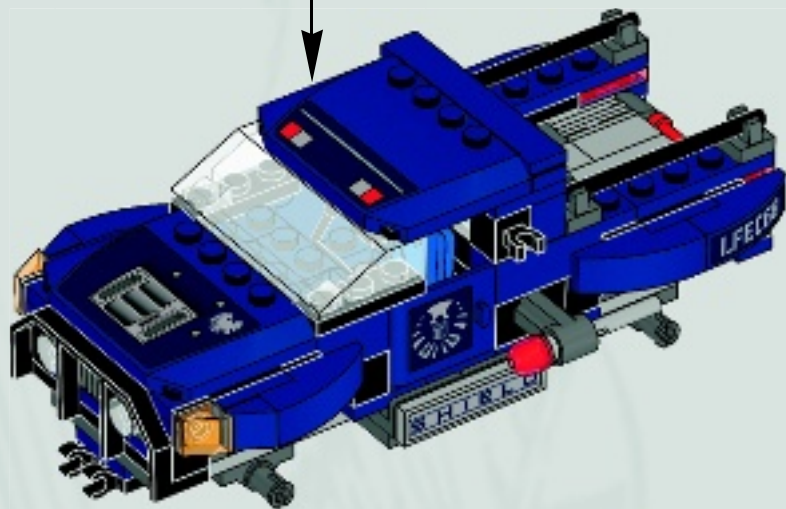
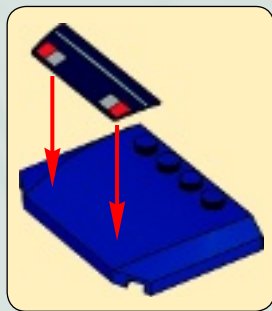



4x



1x



2x

50

1

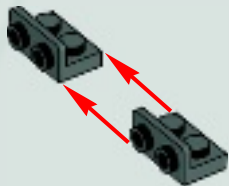

2



3

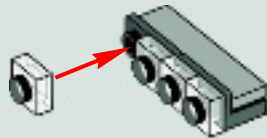

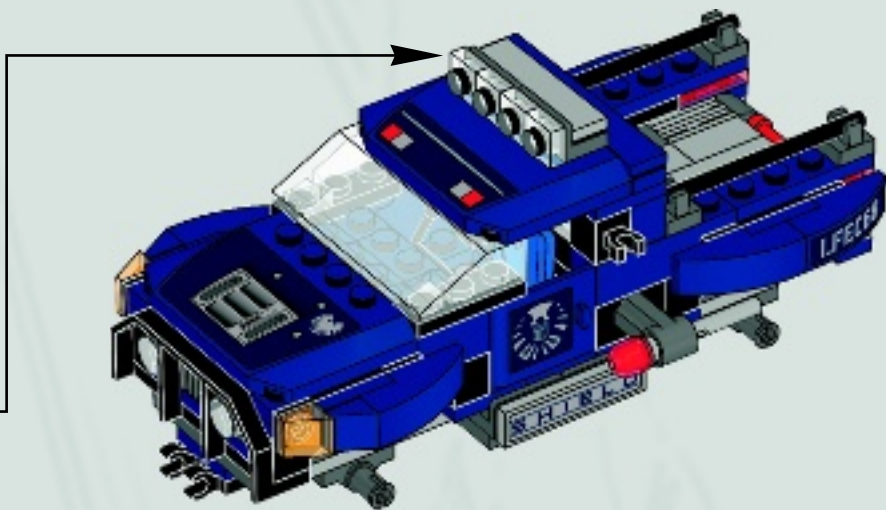



51

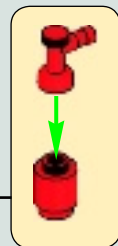
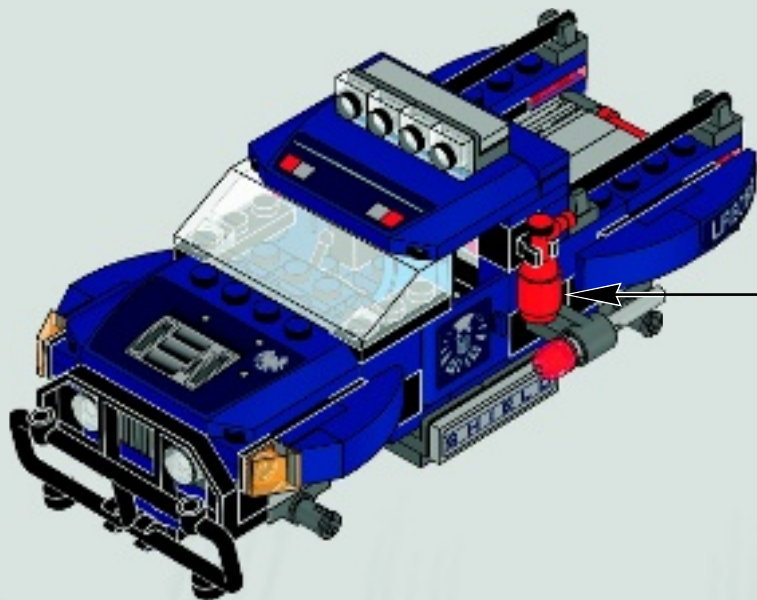

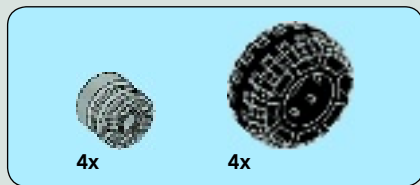

52

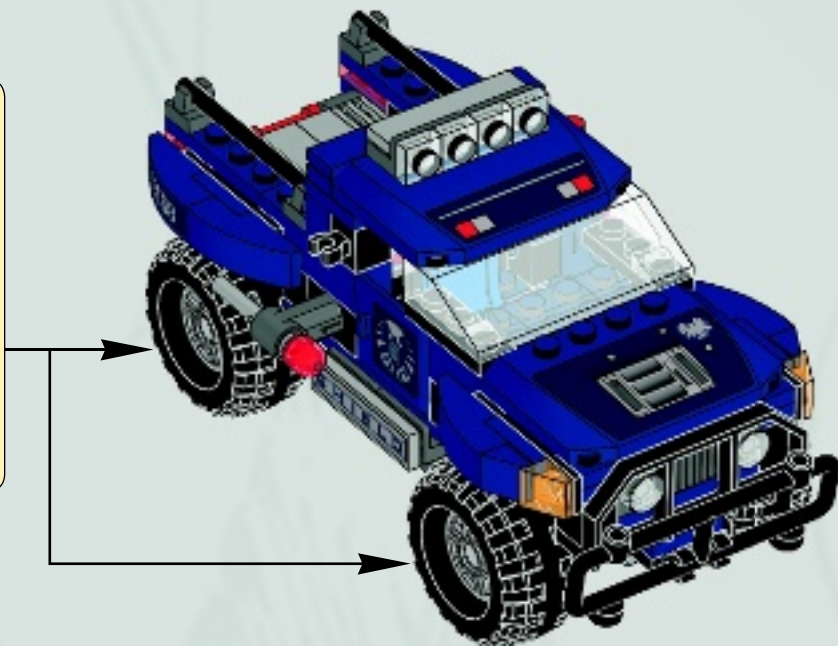
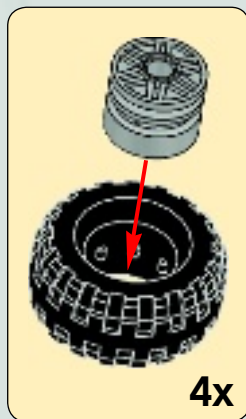

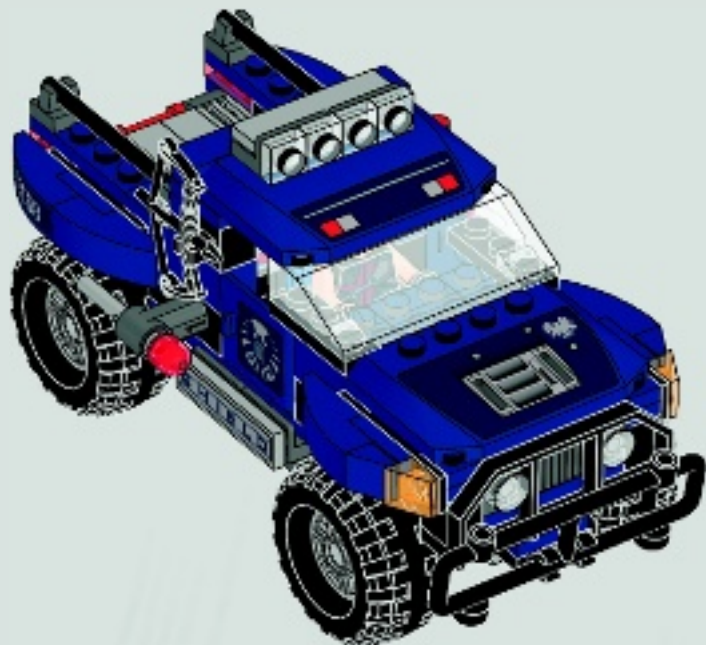



1x
300121



1x
306221



1x
415021



1x
4226876



1x
281721



2x
614121



1x
459921



2x
302023



1x
407923



2x
4206482



2x
4533771



4x
370026



4x
4620763



2x
362326



2x
4535739



4x
4282746



1x
4530589



1x
658326



1x
4544645



1x
6004895



1x
6005447



1x
6004944



4x
4506553



2x
4640742



1x
4636676



1x
4645394



4x
3000840



2x
4650498



1x
4552033



1x
4542700



2x
4201019



2x
4497943



2x
4183544



2x
4163917



2x
4255413



3x
4296785



2x
4264569



2x
4504374



6x
4540280



11x
4528981



7x
4530028



10x
4502089



4x
4508313



1x
4252437



1x
6005302



1x
6005301



2x
6003573



1x
6004893



1x
6005445



1x
6008352



1x
6008350



2x
4244369

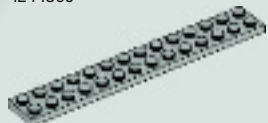

3x
4662161



4x
4211356



3x
4211350



2x
4211414



1x
4211451



1x
4255629



1x
4221775



4x
4299119



2x
4278273



1x
4226995



2x
4520320



2x
4211807



2x
4558955



1x
4210636



4x
4211115



4x
4210797



4x
4211069



6x
6000606



1x
4211042



1x
6004894



1x
6005446



2x
4509884



2x
4210658



1x
4610762



1x
4646866



1x
6005435



1x
4662141



1x
6003614



1x
6003610



1x
6008348



Customer Service

Kundenservice

Service Consommateurs

Servicio Al Consumidor

www.lego.com/service or dial



00800 5346 5555 :



1-800-422-5346 :





club™



www.LEGOclub.com/marvel

FREE*! GRATIS! GRATUIT!

*Paid subscription in Australia
and New Zealand

*Abonnement payant en
Australie et Nouvelle-Zélande



LEGO and the LEGO logo are
trademarks of the/son't des
marques de commerce de/son
marcas registradas de LEGO Group.
©2012 The LEGO Group.
TM & © 2012 Marvel & Subs.



WIN!

Go to www.LEGOsurvey.com/product to fill out a survey for a chance to win a cool LEGO® Product.

No purchase necessary.

Open to all residents where not prohibited.



www.LEGOsurvey.com/product

GEWINNE!

Nimm an der Umfrage auf www.LEGOsurvey.com/product teil und hab die Chance ein cooles LEGO® Produkt zu gewinnen! Die Teilnahme am Gewinnspiel führt zu keinerlei Kaufverpflichtungen. Teilnahme in allen nicht ausgeschlossenen Ländern möglich.

WIN!

Ga naar www.LEGOsurvey.com/product, vul een enquêteformulier in en maak kans op een cool LEGO® product. Geen aankoopverplichting. Iedereen mag deelnemen, uitgezonderd ingezetenden van landen waar een enquêteverbod geldt.

GAGNE!

Visite www.LEGOsurvey.com/product pour répondre à un questionnaire et avoir une chance de gagner un produit LEGO® très cool! Aucune obligation d'achat. Ouvert à tous les résidents des pays autorisés.

当てよう!

www.LEGOsurvey.com/product にアクセスして、アンケートにご記入ください。当選者にはレゴ®製品を差し上げます。お買い上げの必要はありません。禁止されていない限り、すべての皆様にご利用いただけます。



www.LEGO.com

6024049 / 6024050



www.marvel.com

TM & © 2012 Marvel & Subs.

LEGO and the LEGO logo are trademarks of the/son des marques de commerce de/son marcas registradas de LEGO Group. ©2012 The LEGO Group.