

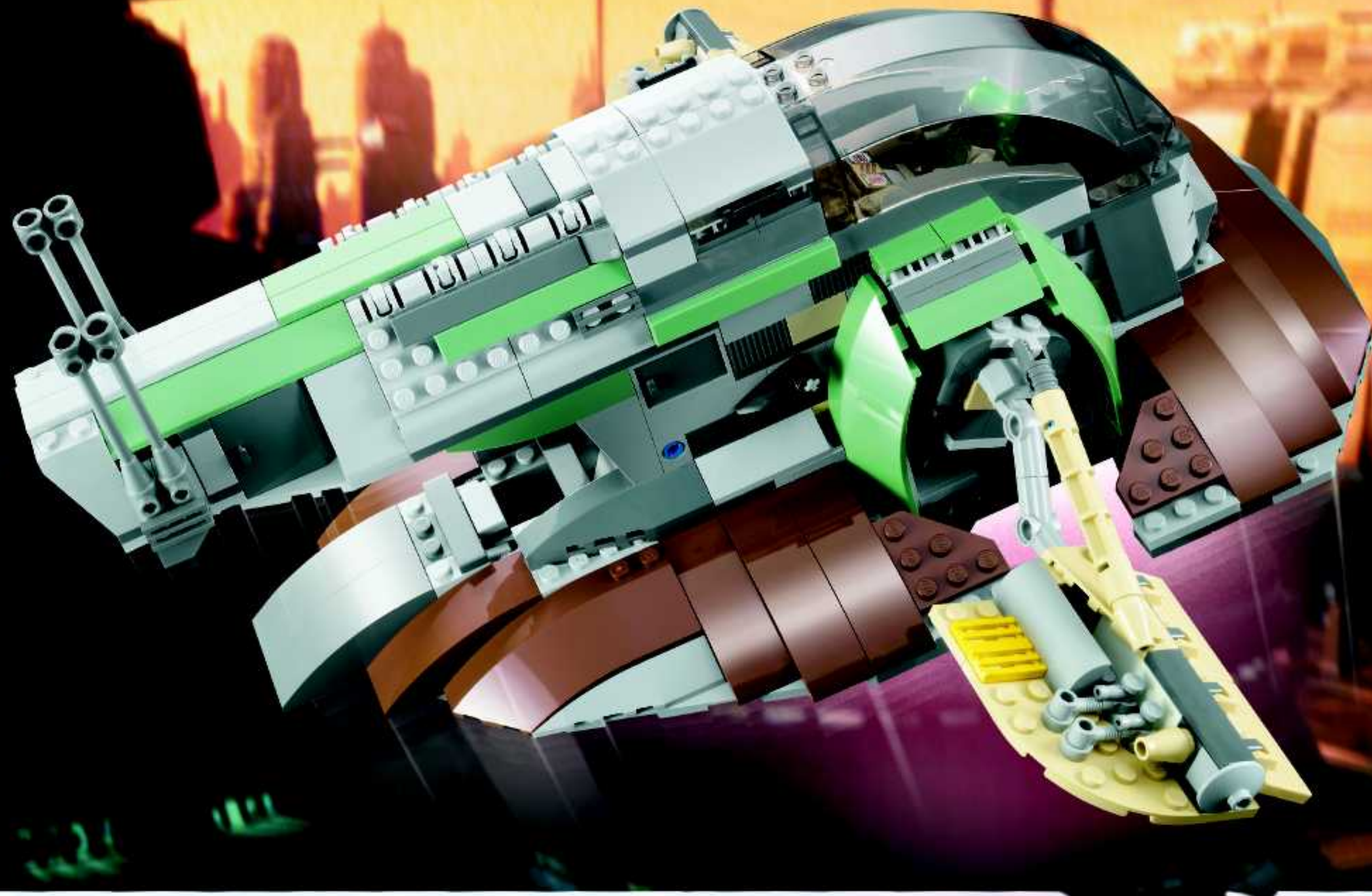

# STAR WARS



6209



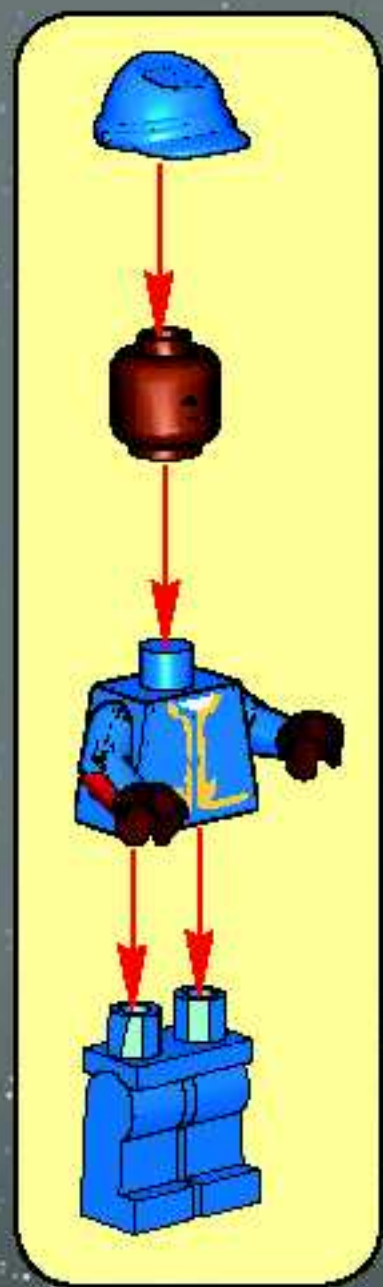

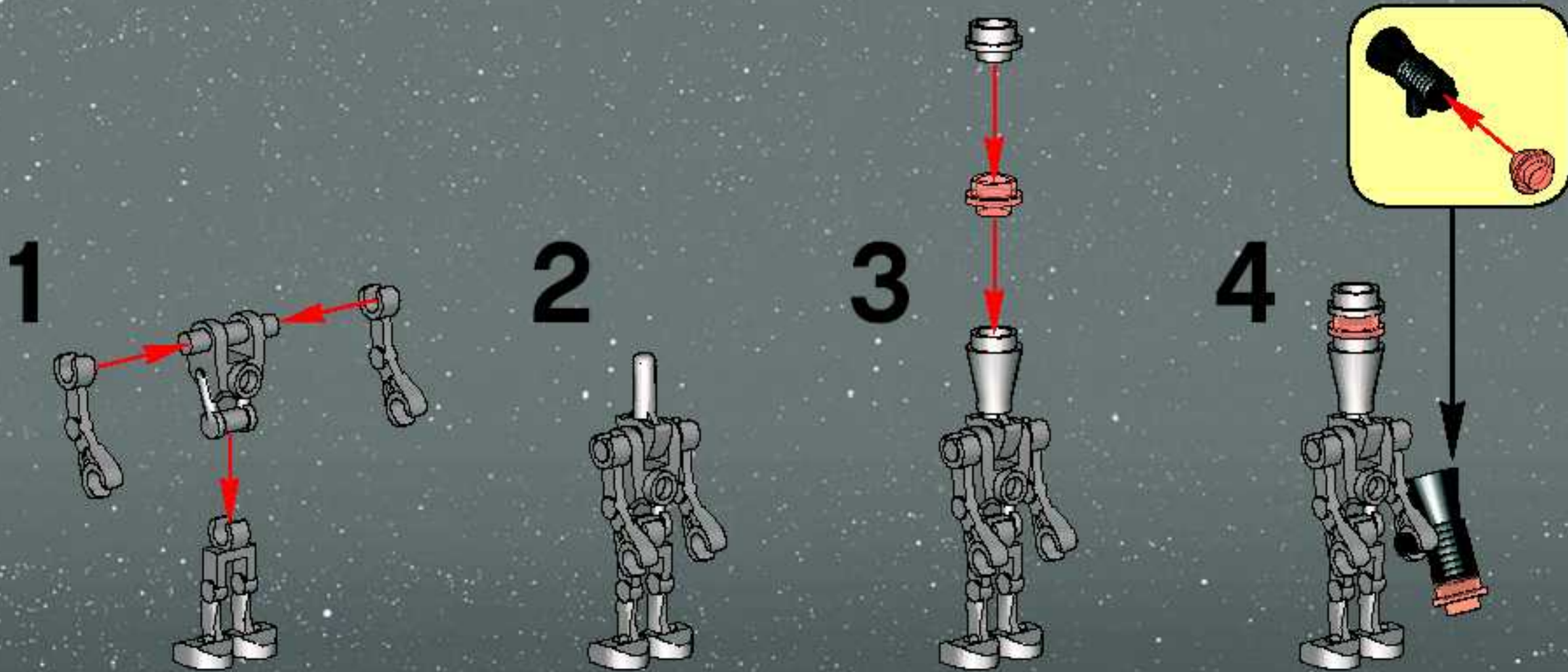
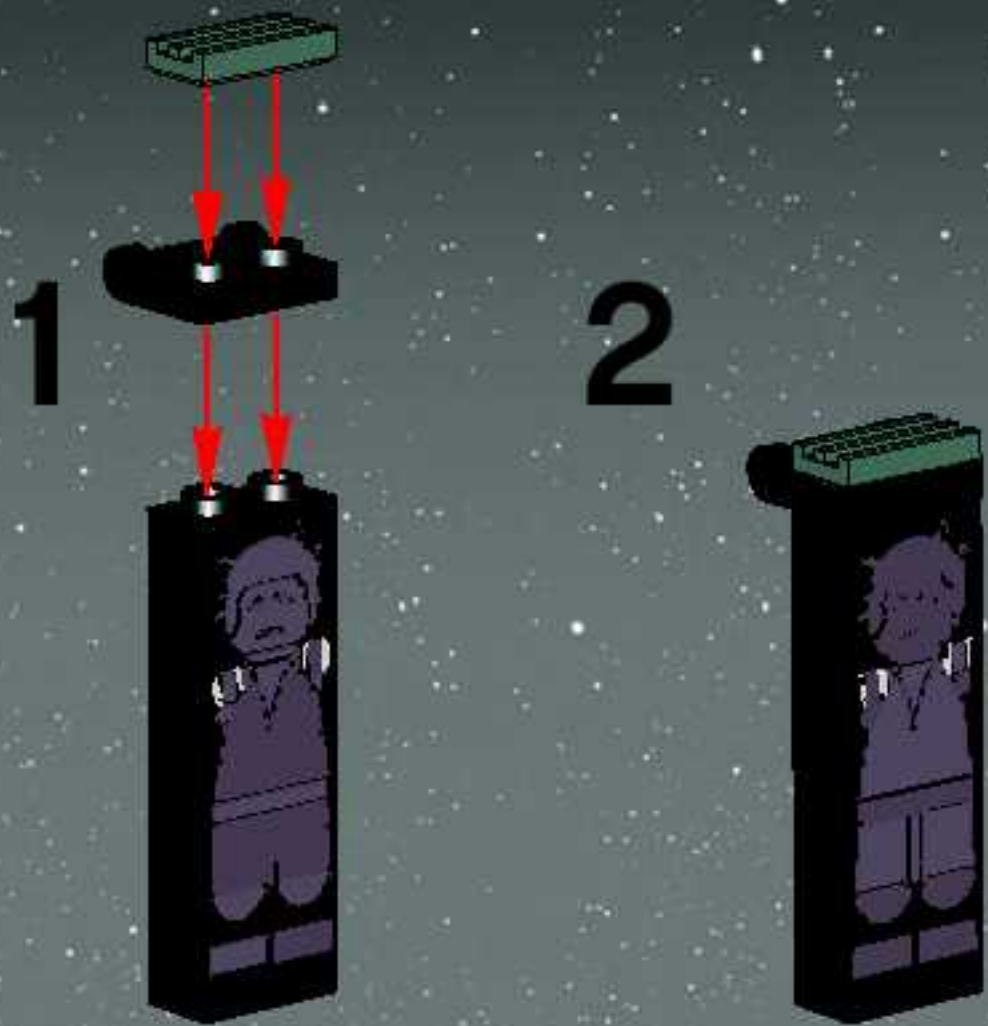

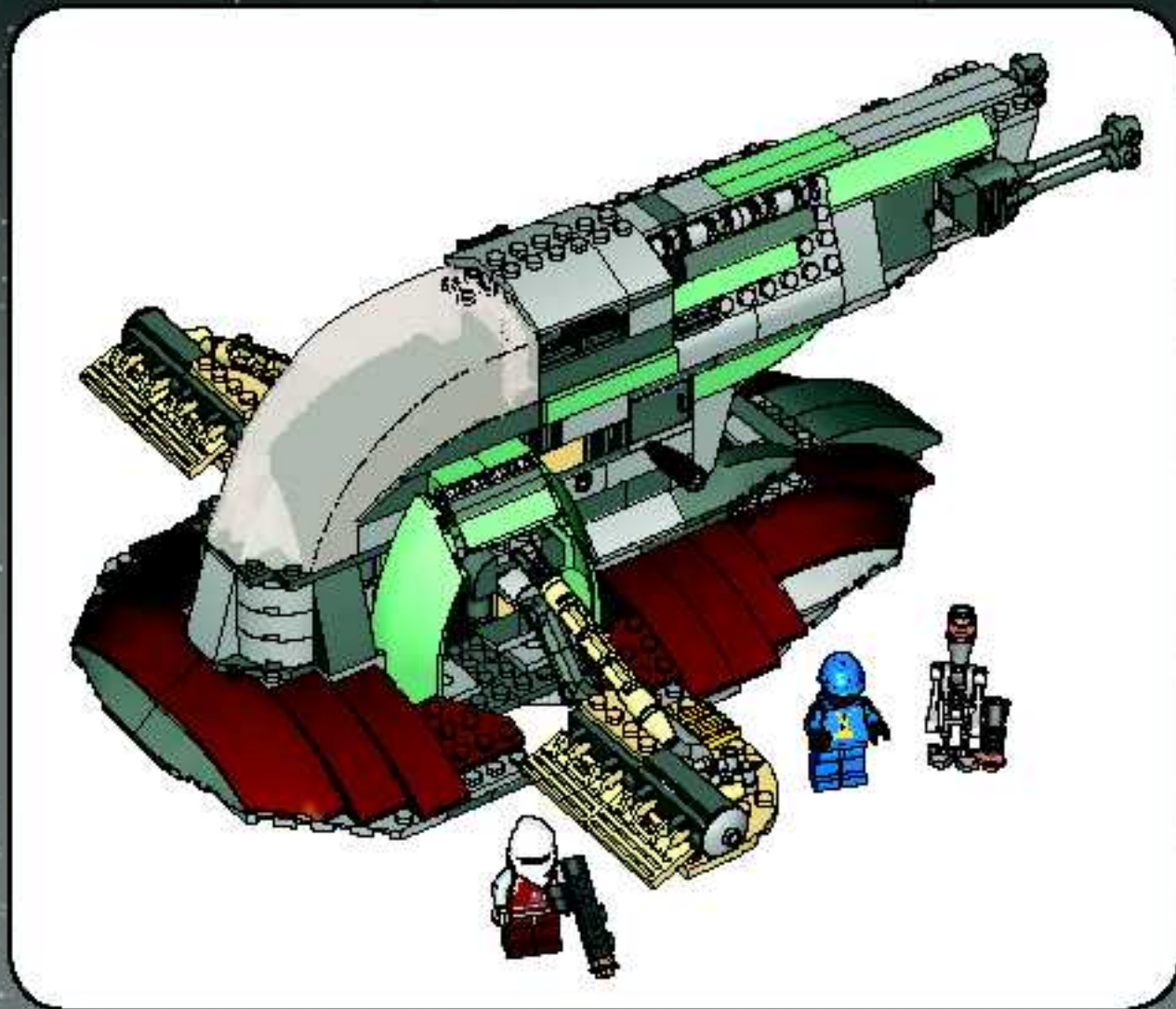

1

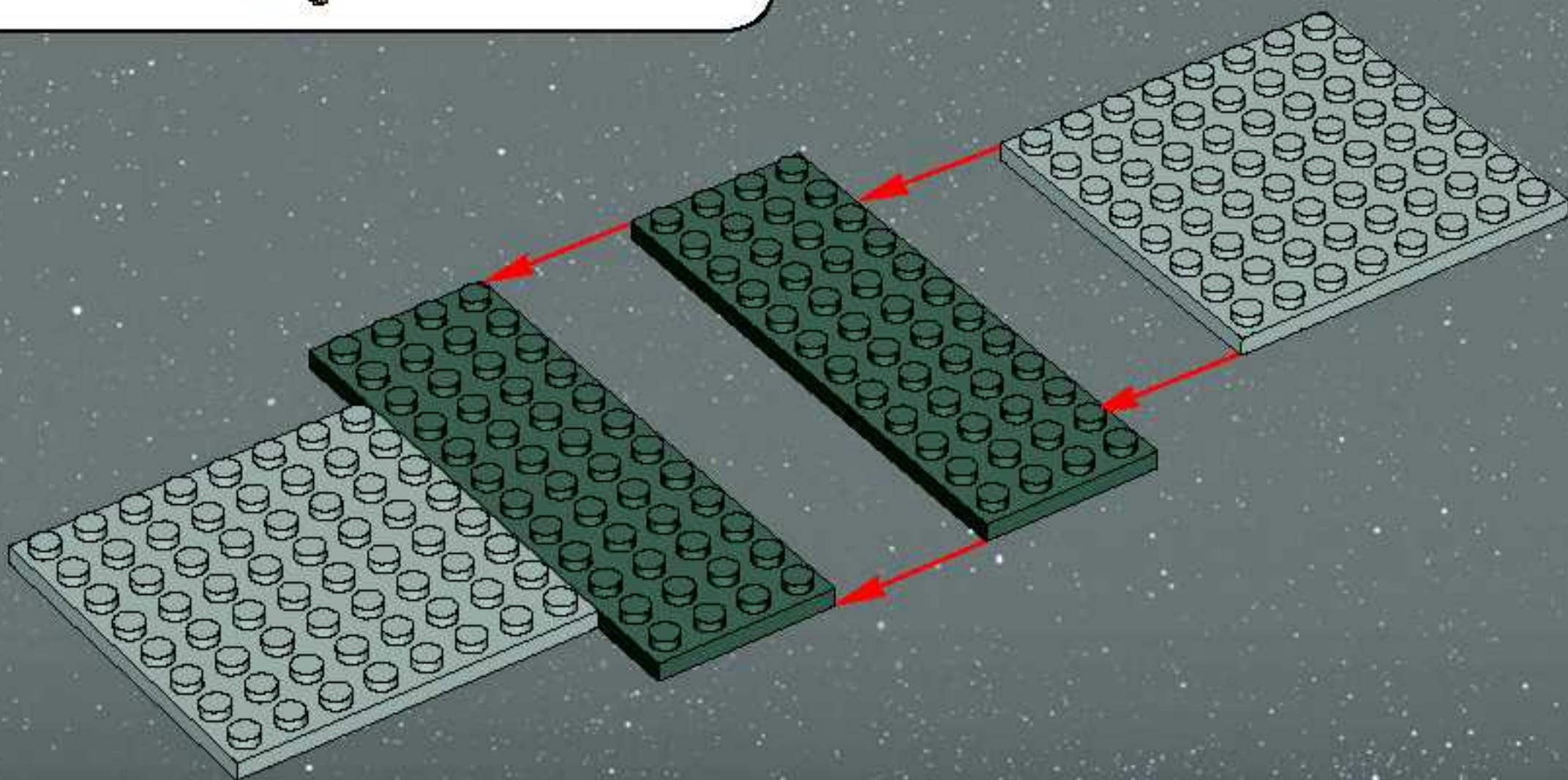

2

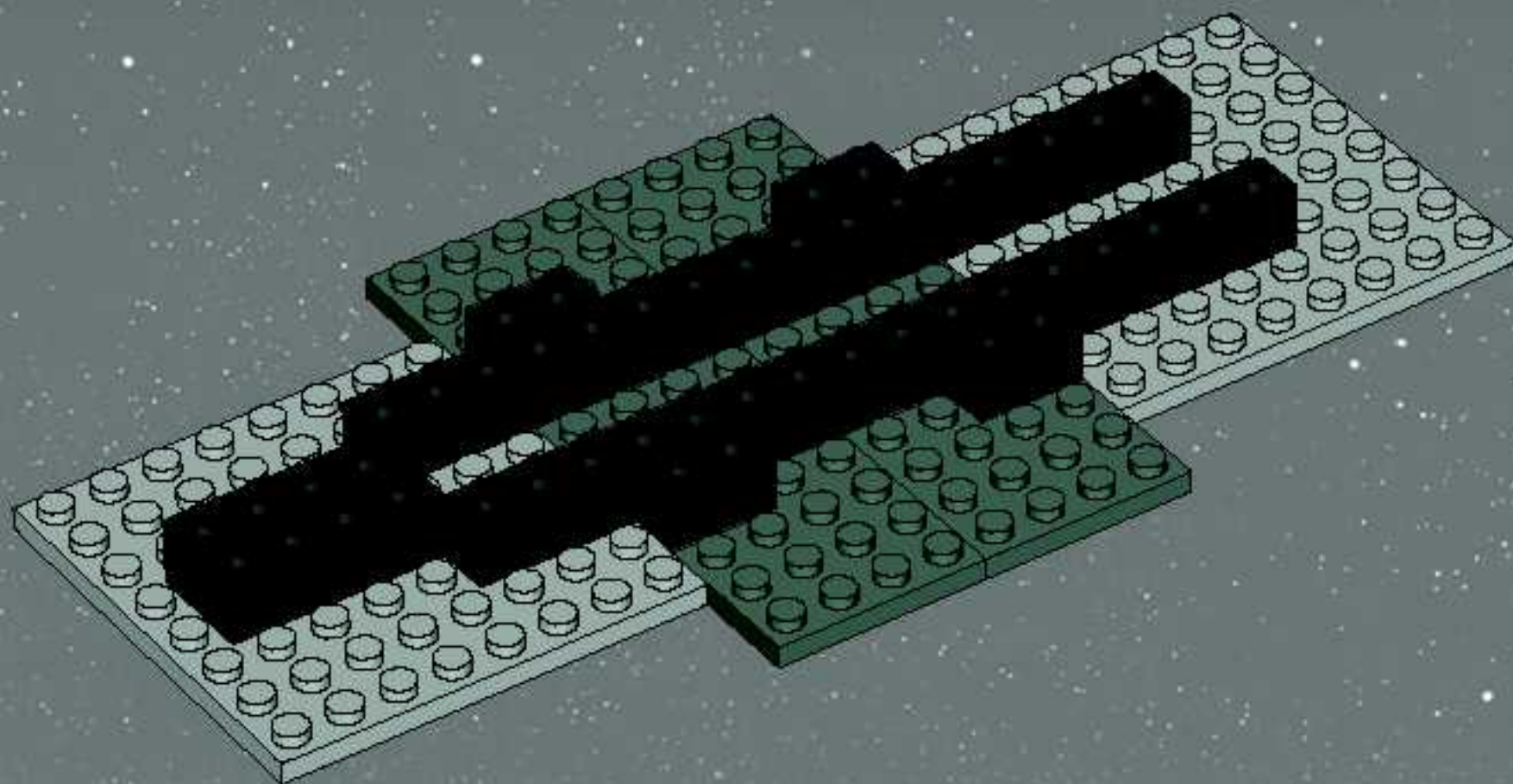

3

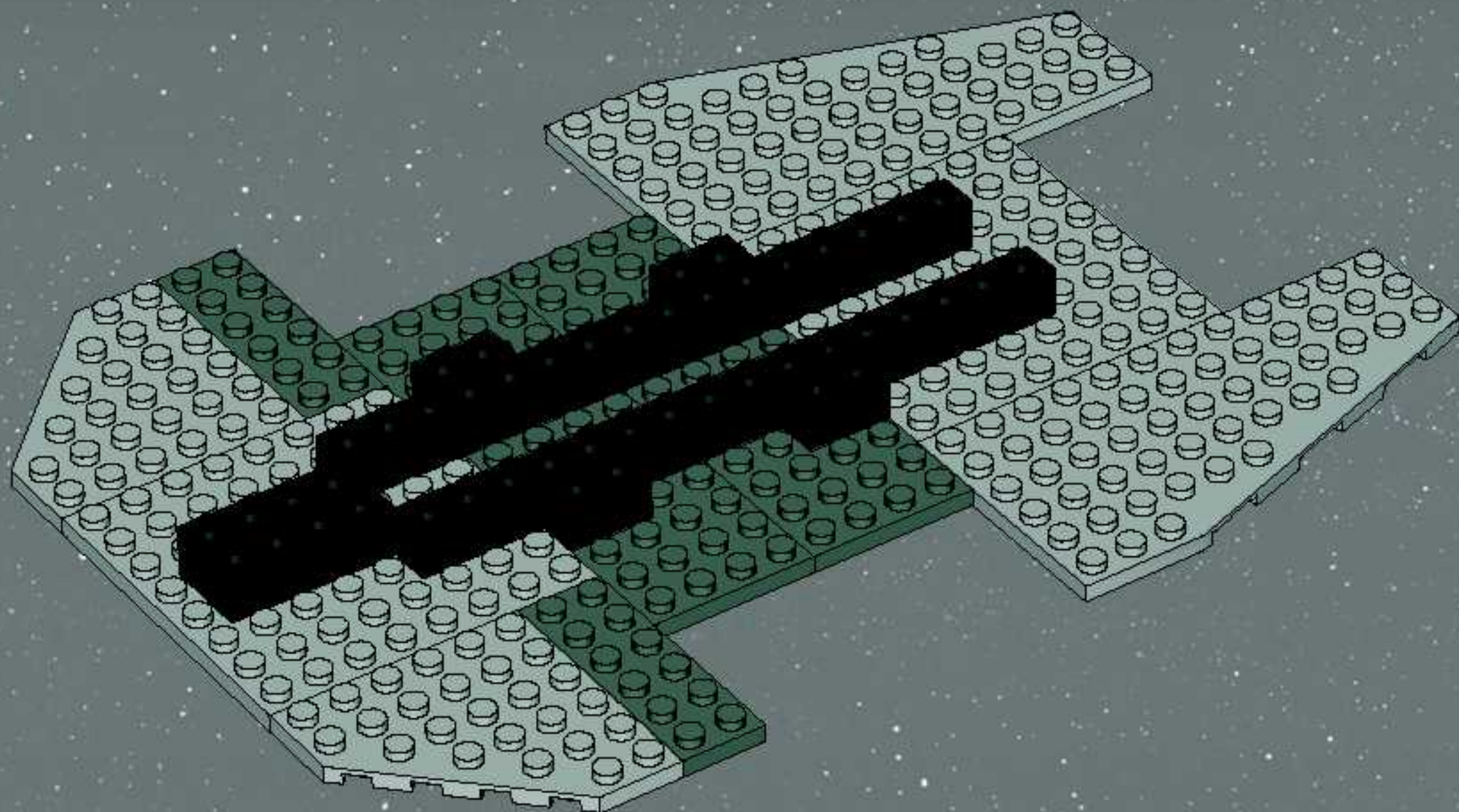

4

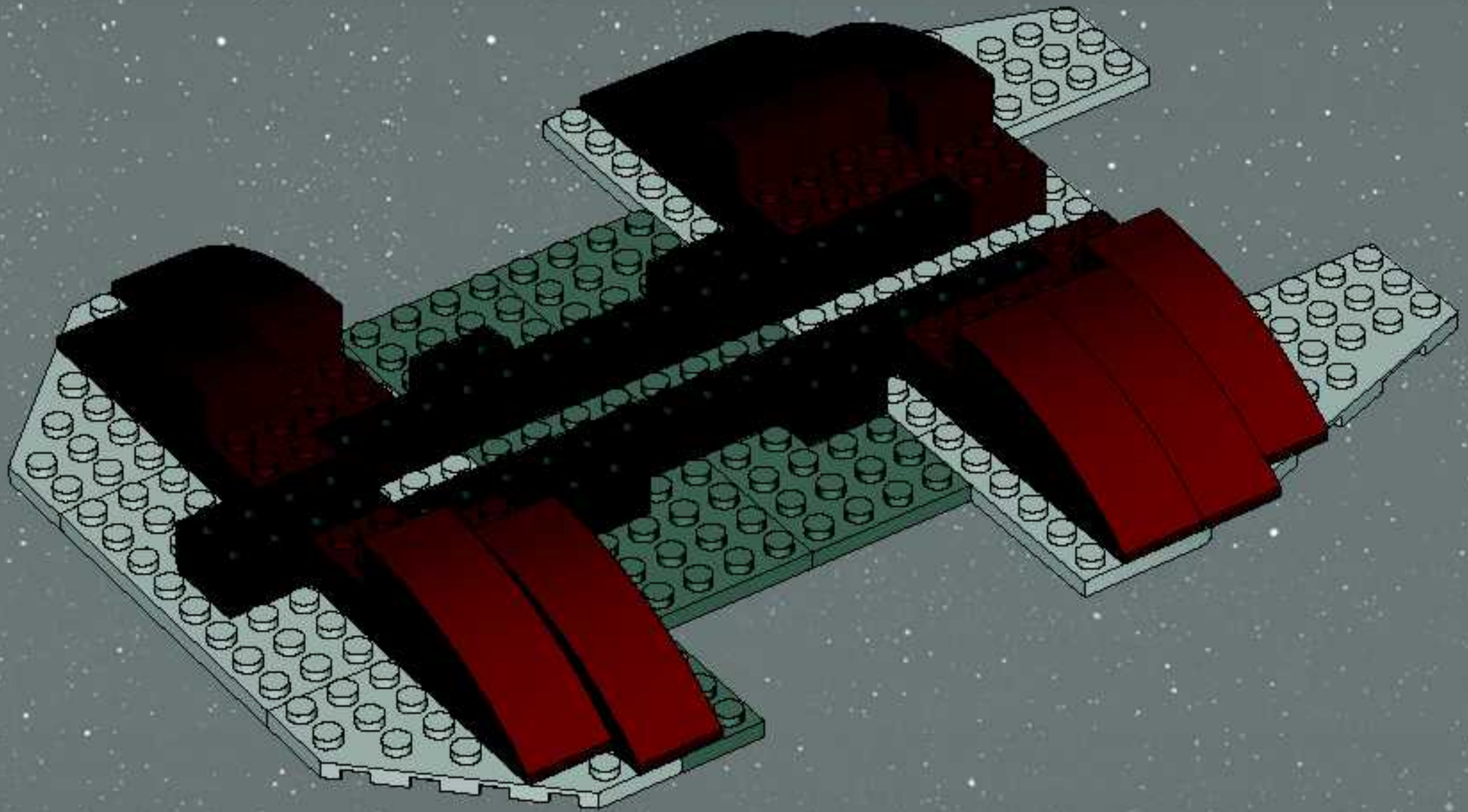

5

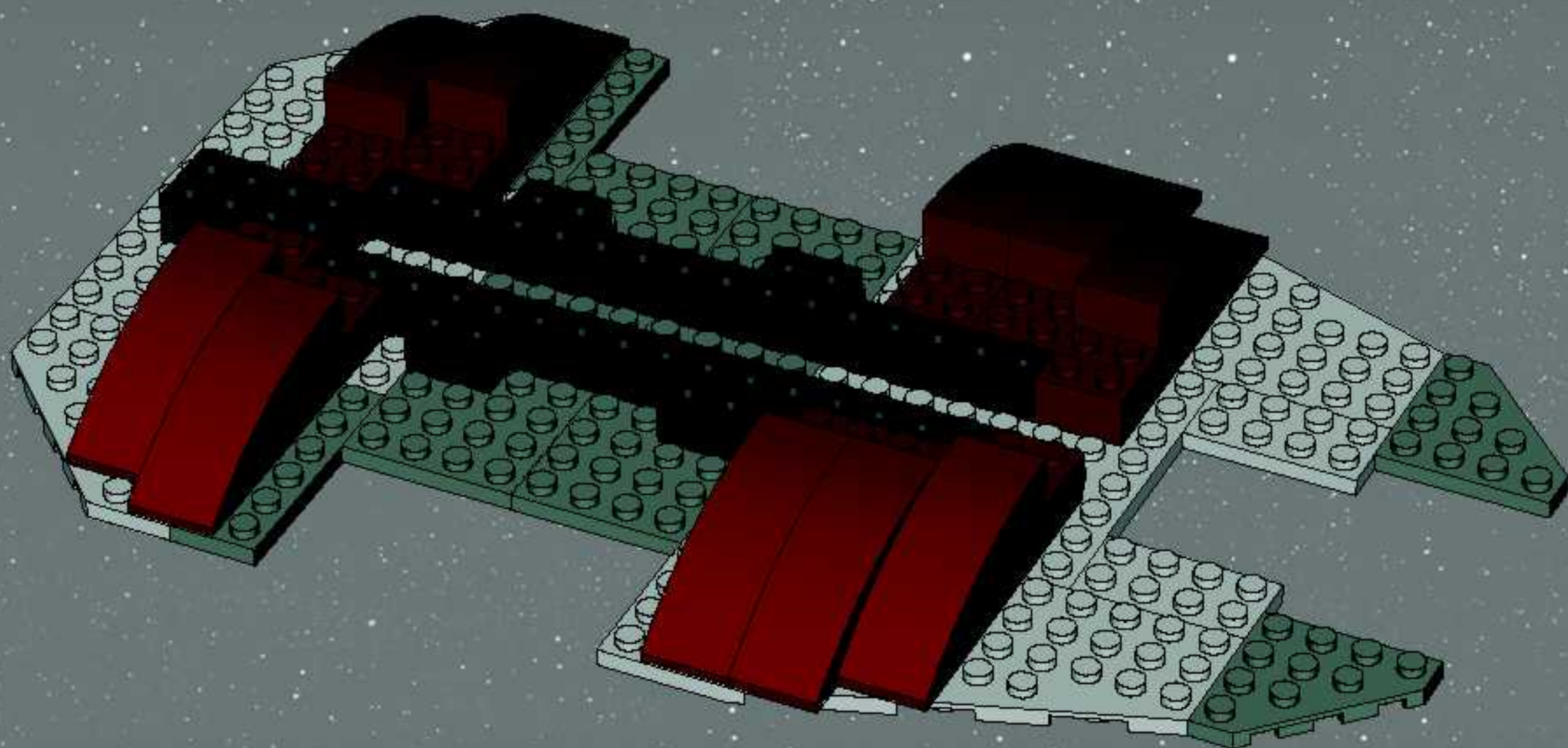



6

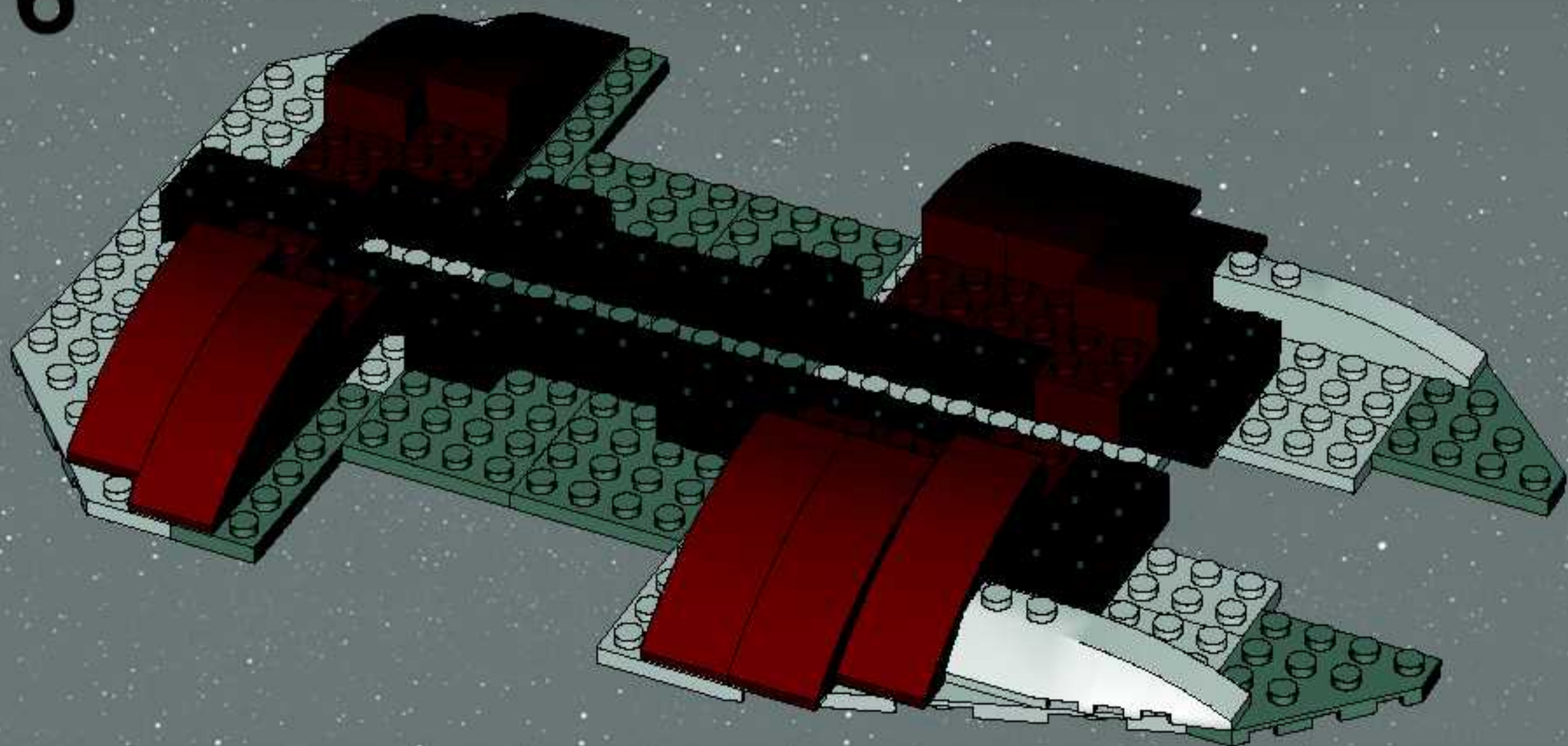

7

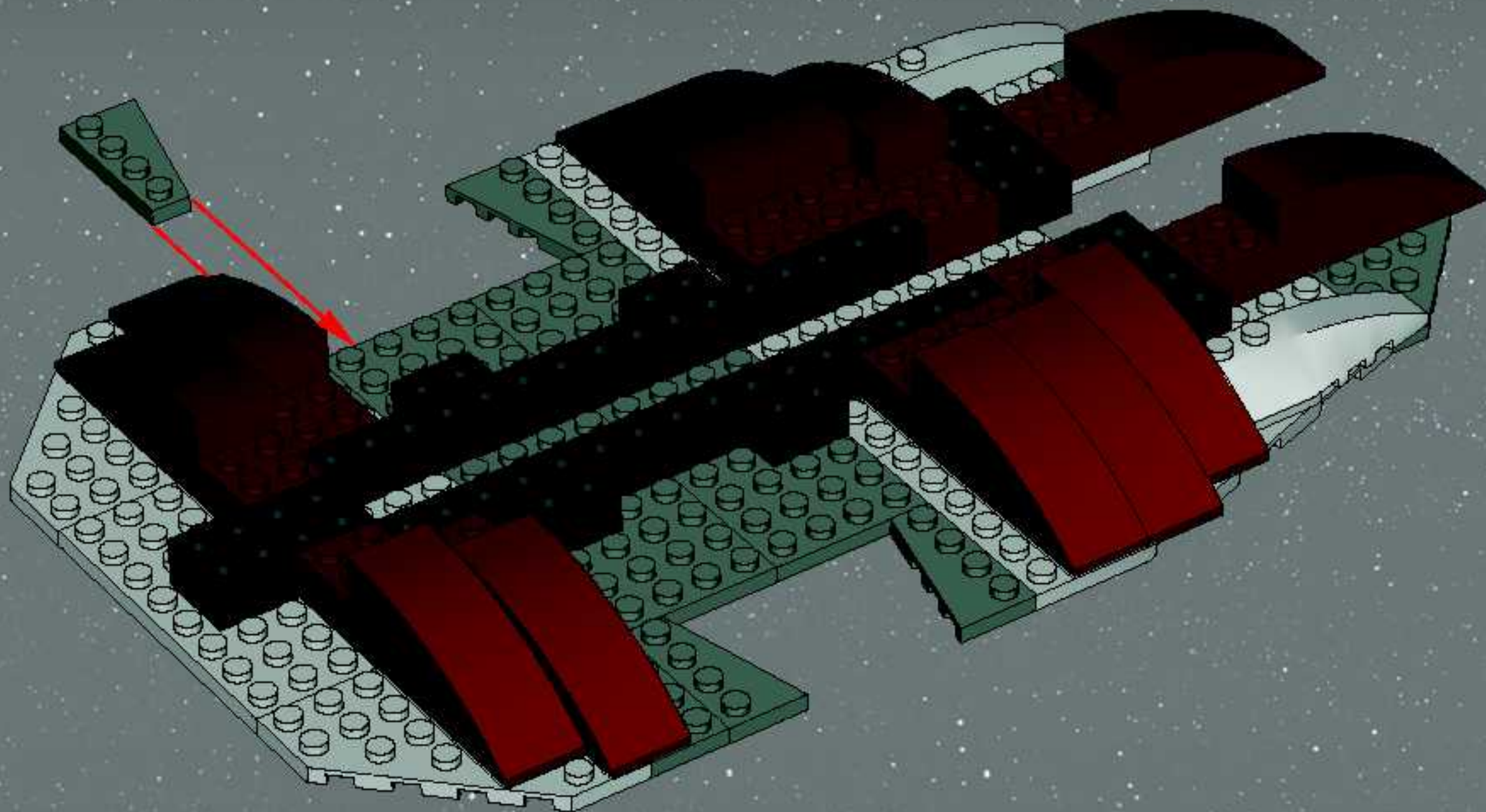

8

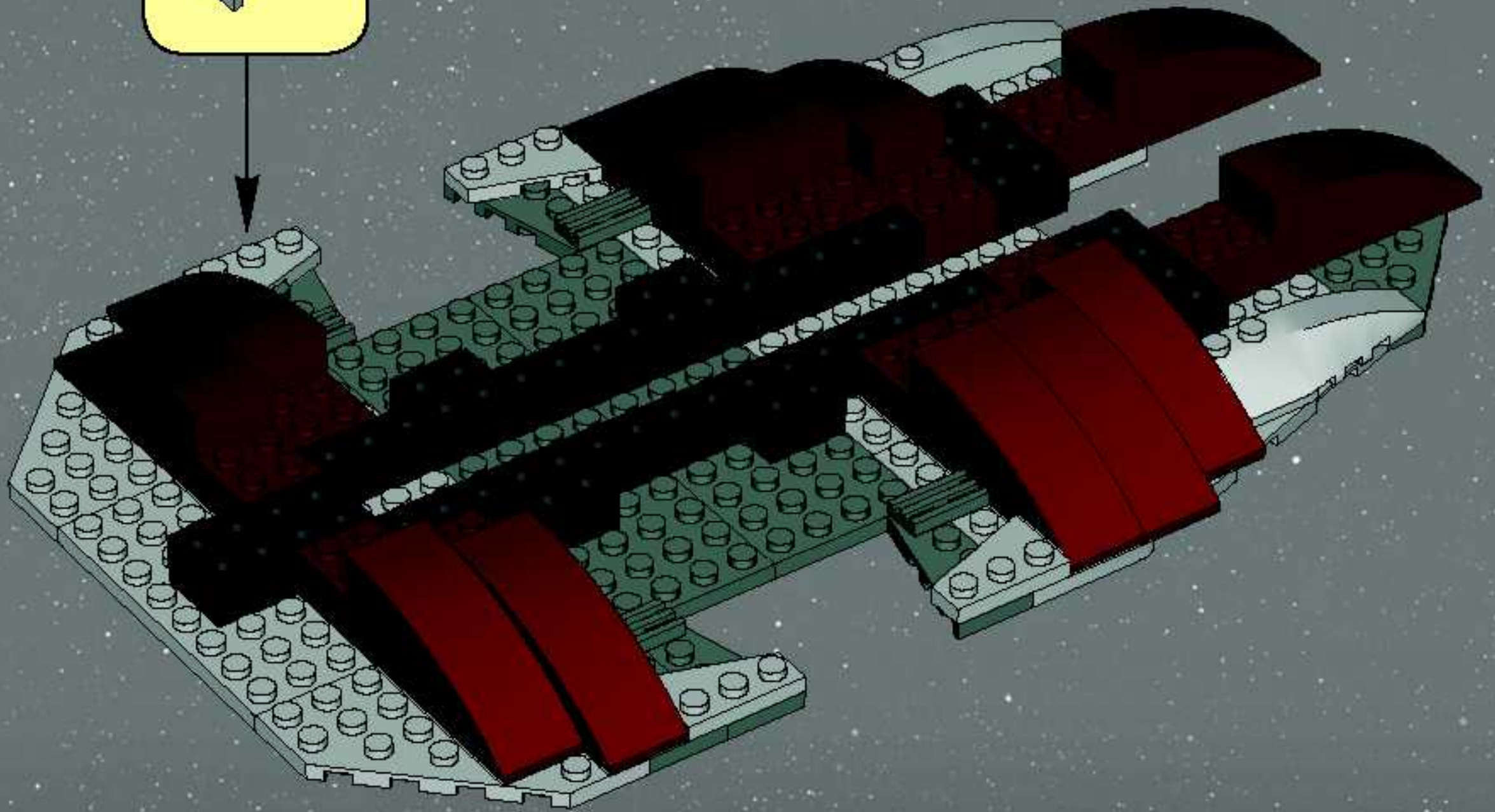
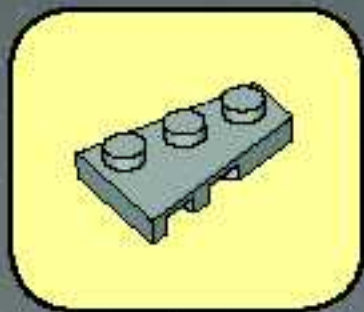

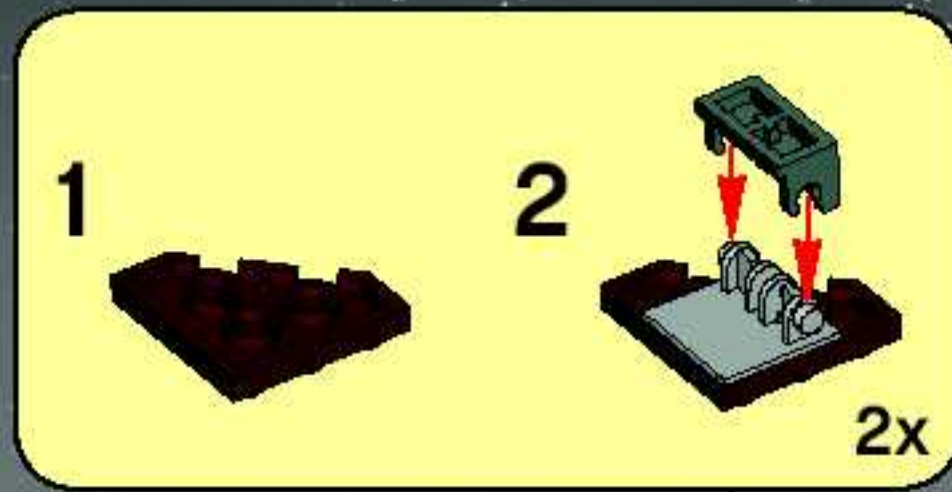

9

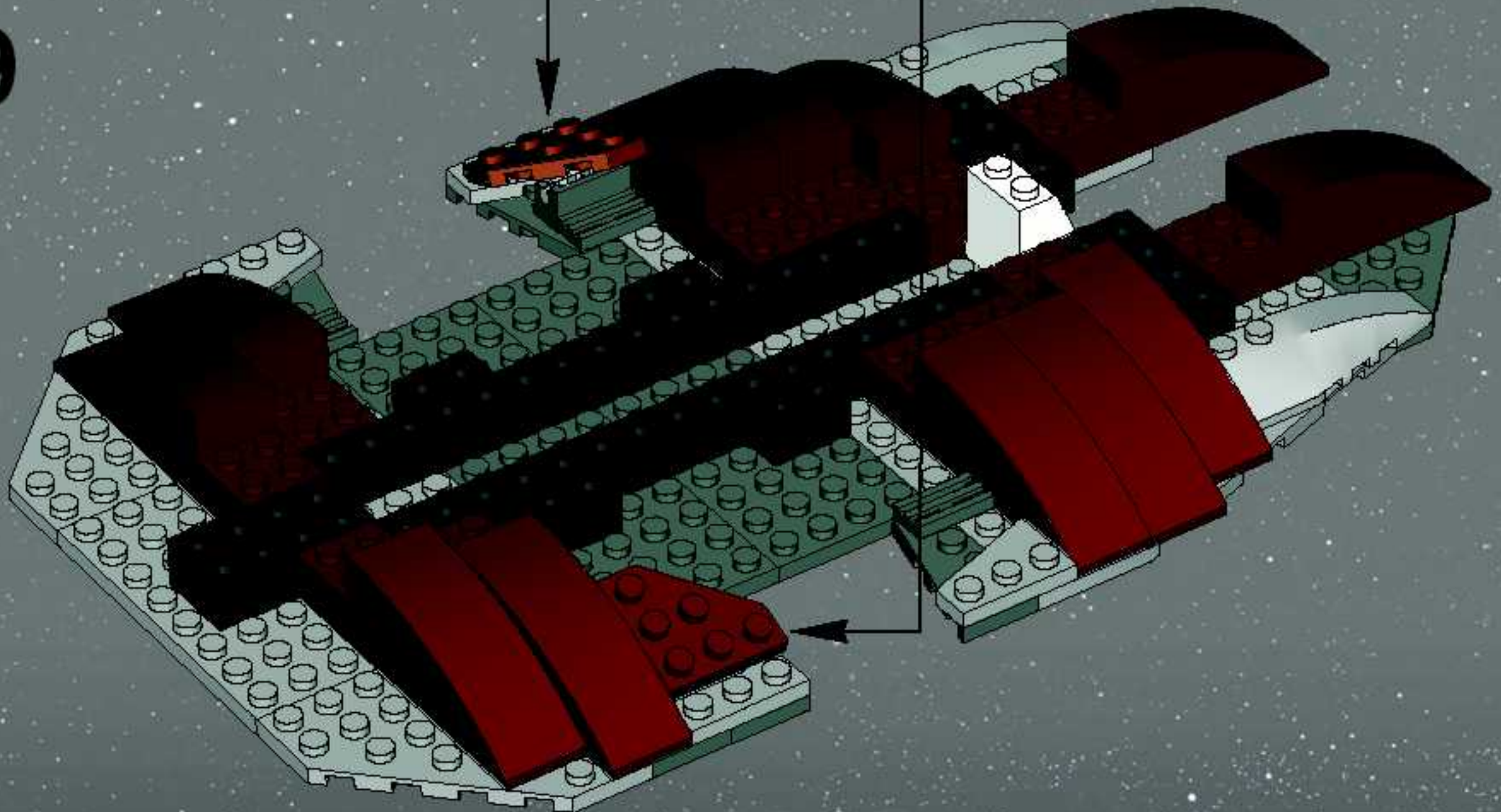

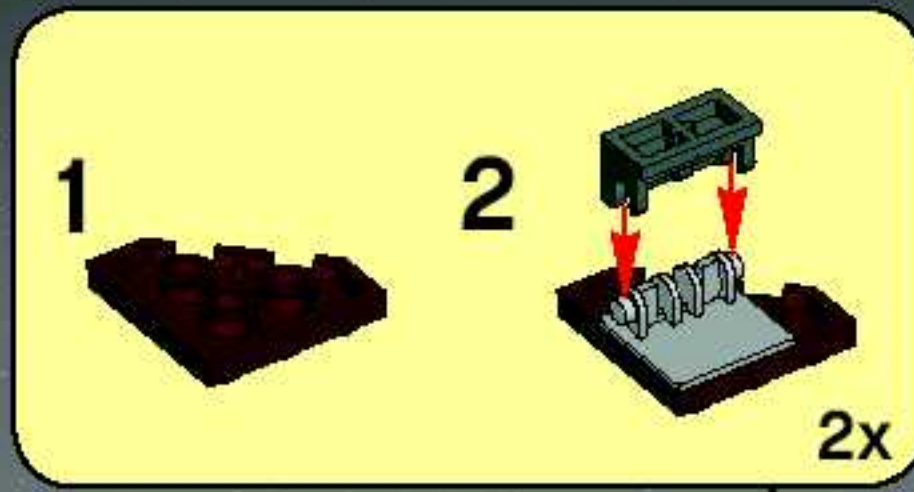

10

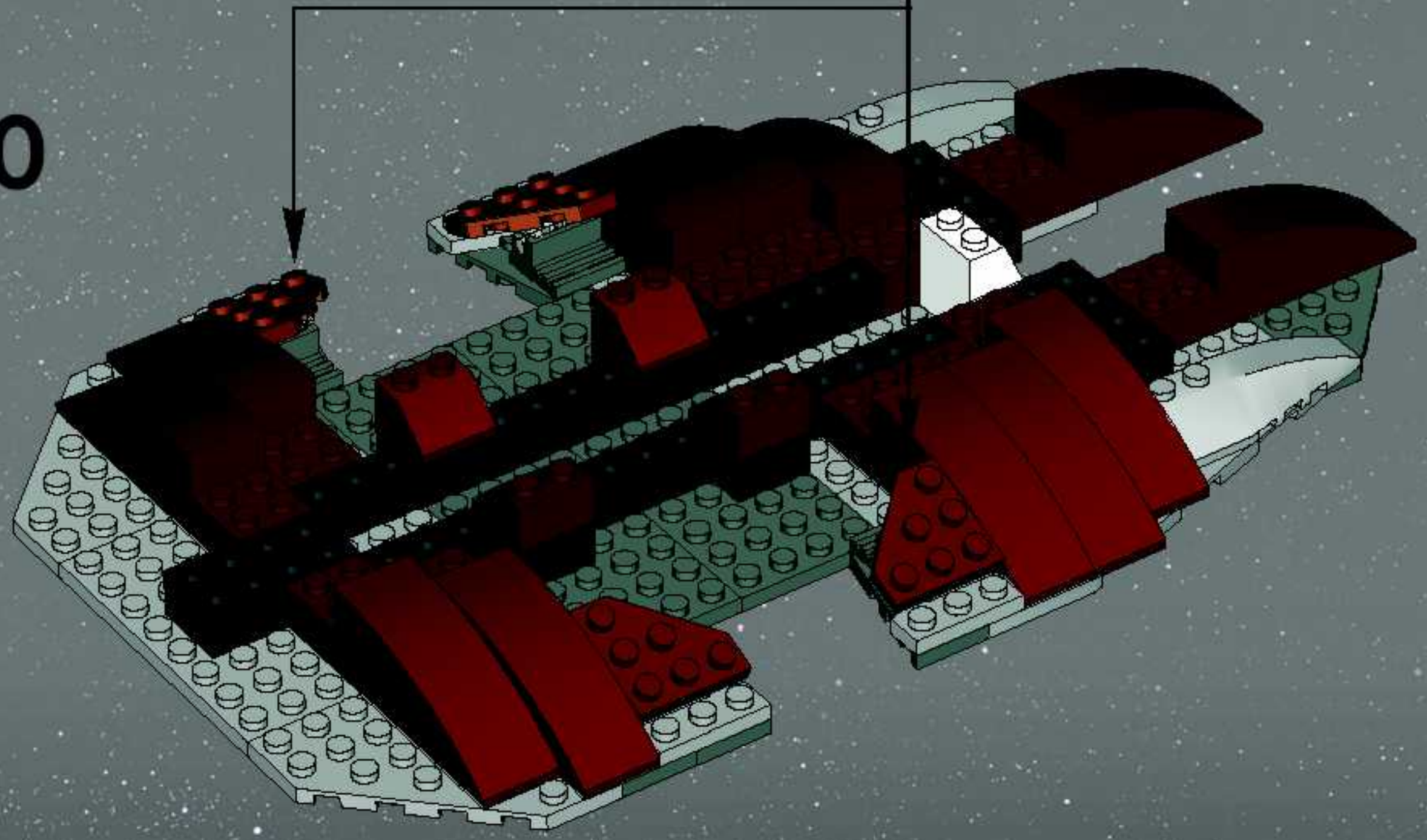

11



12

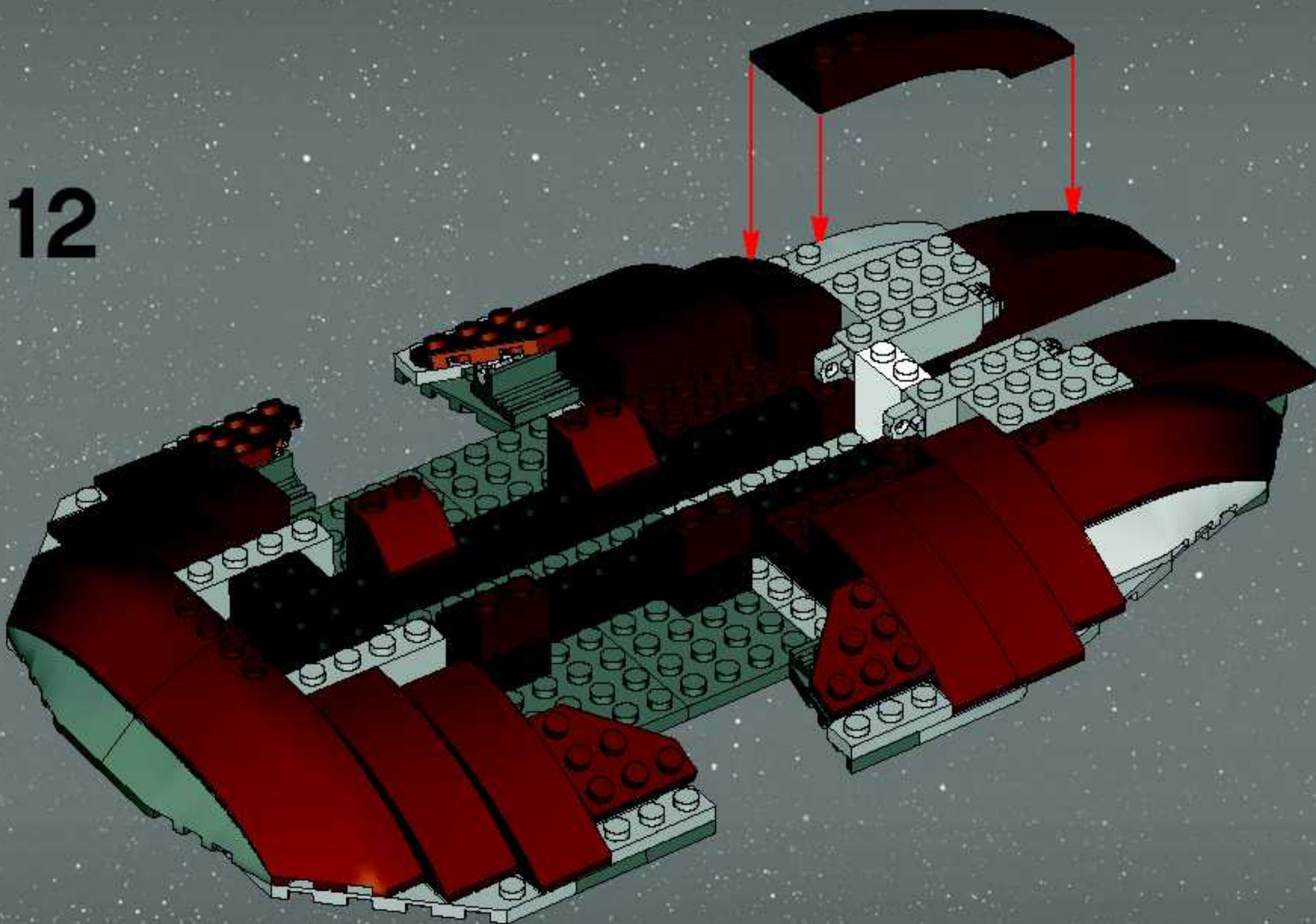

13

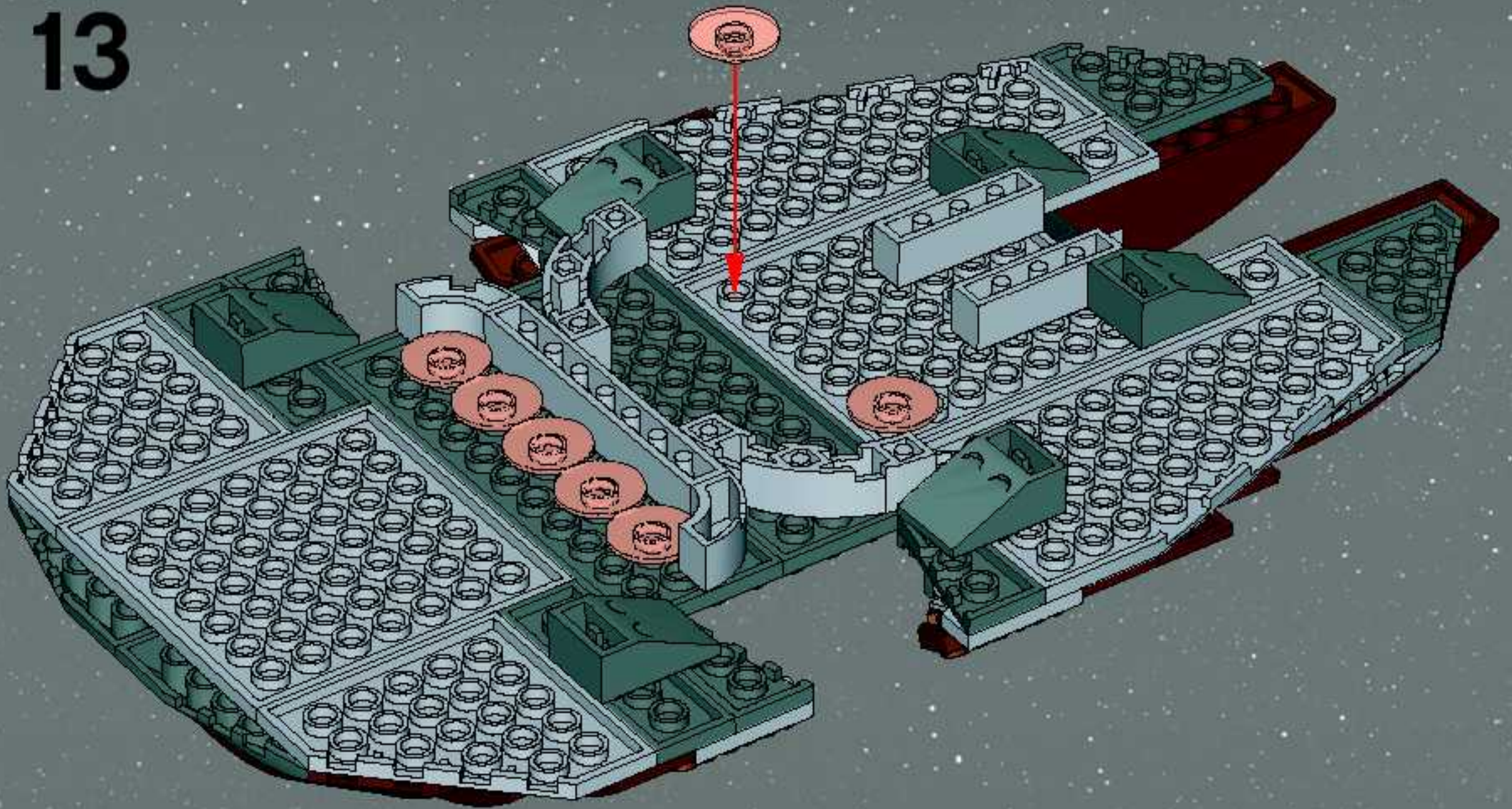



14

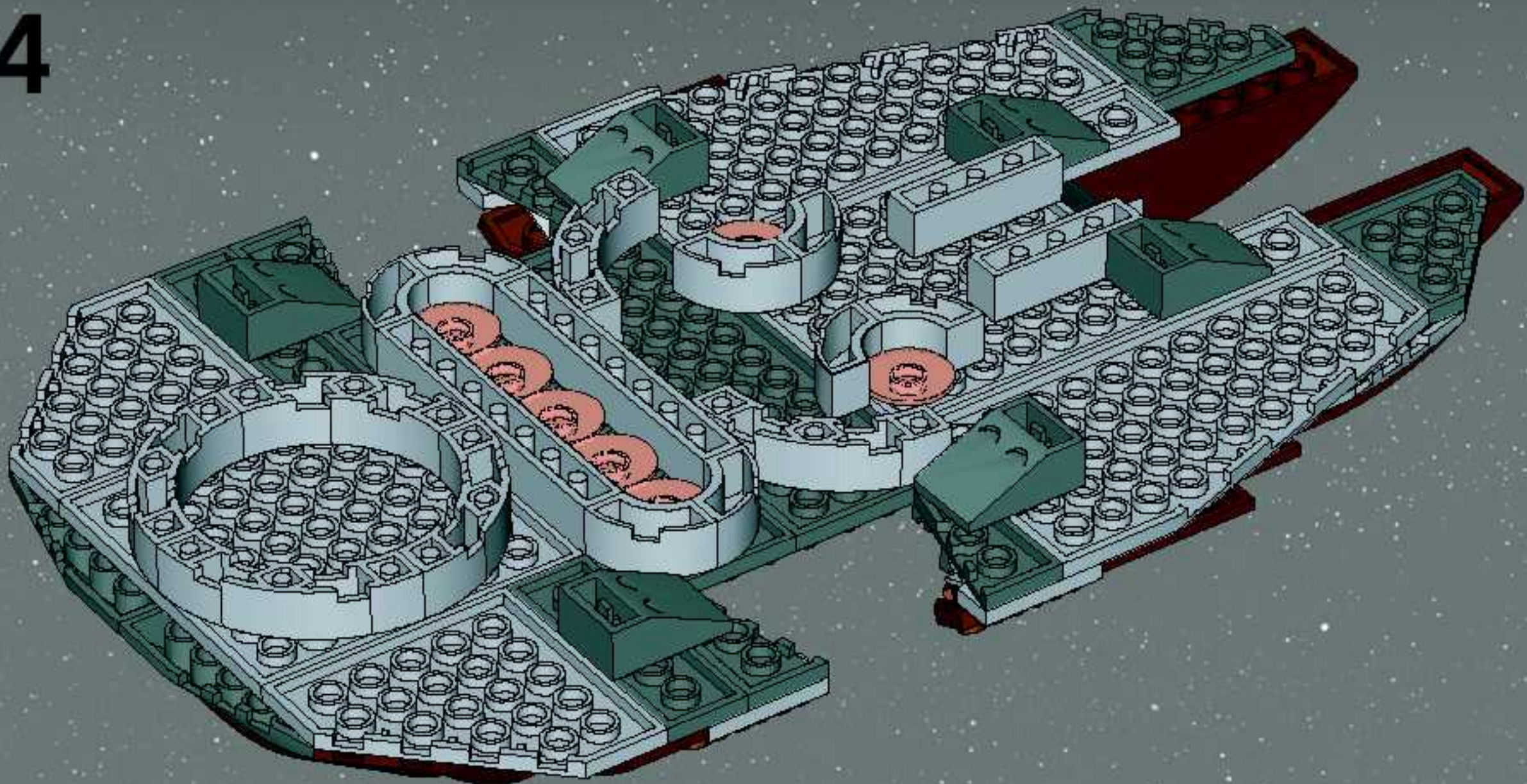

15



1



2

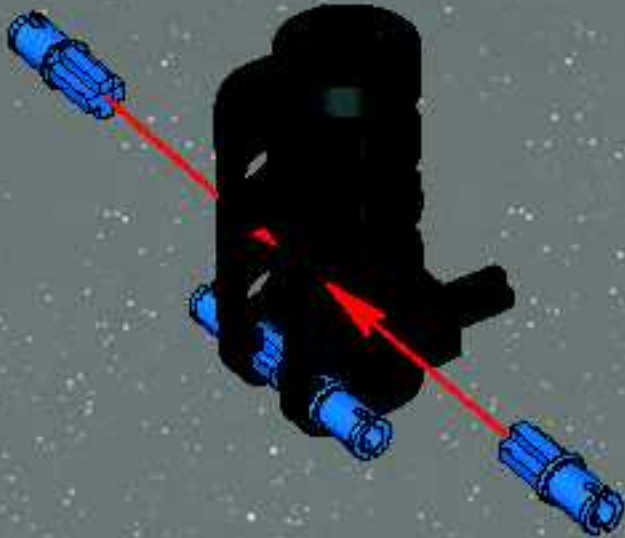

3

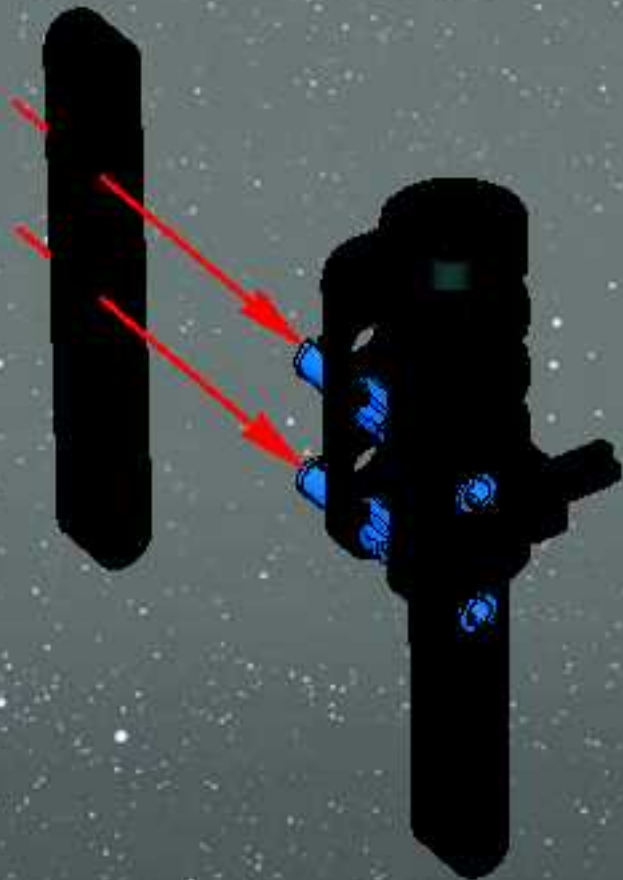

4

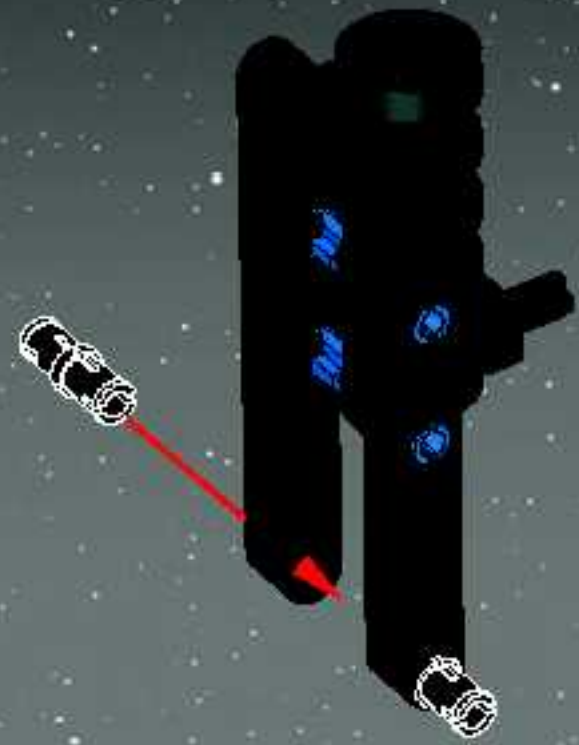

5

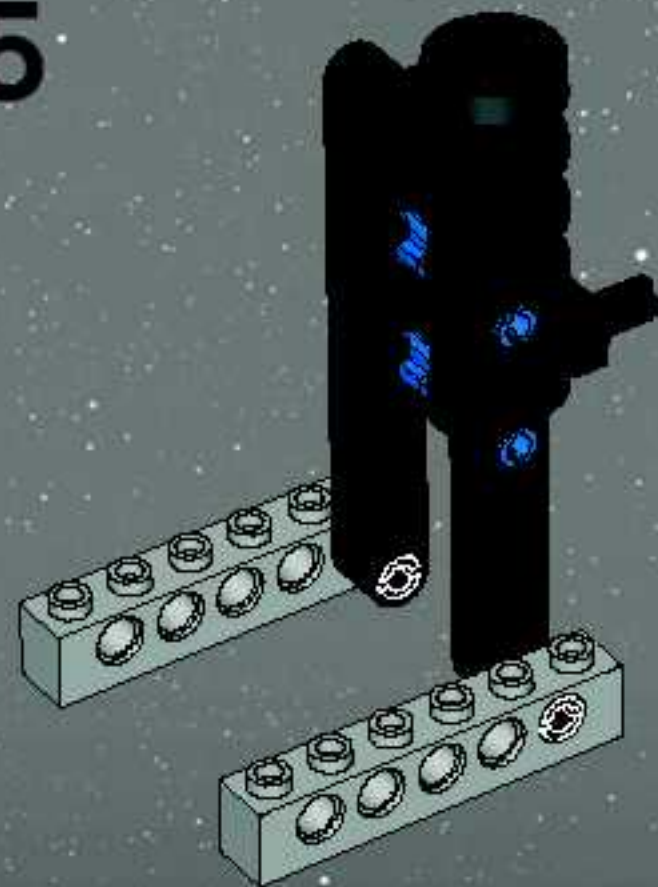

6

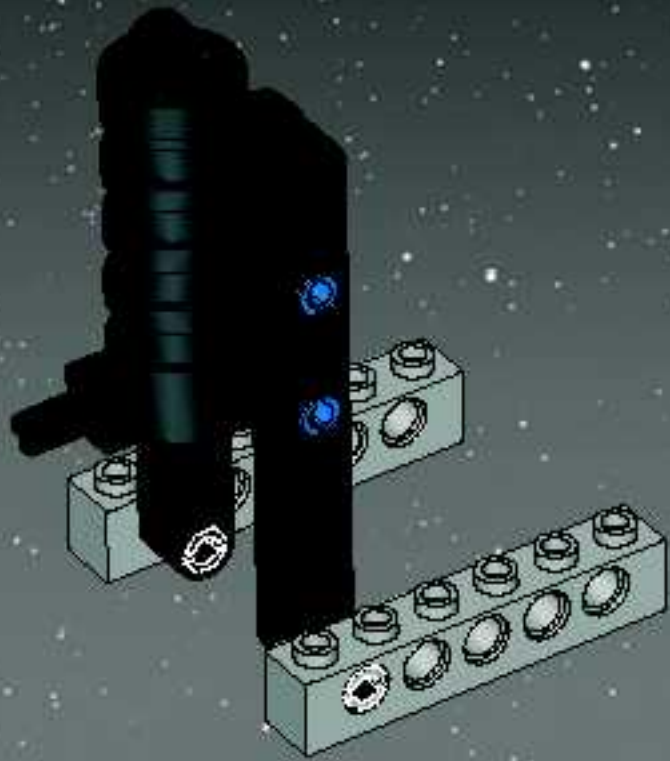

16



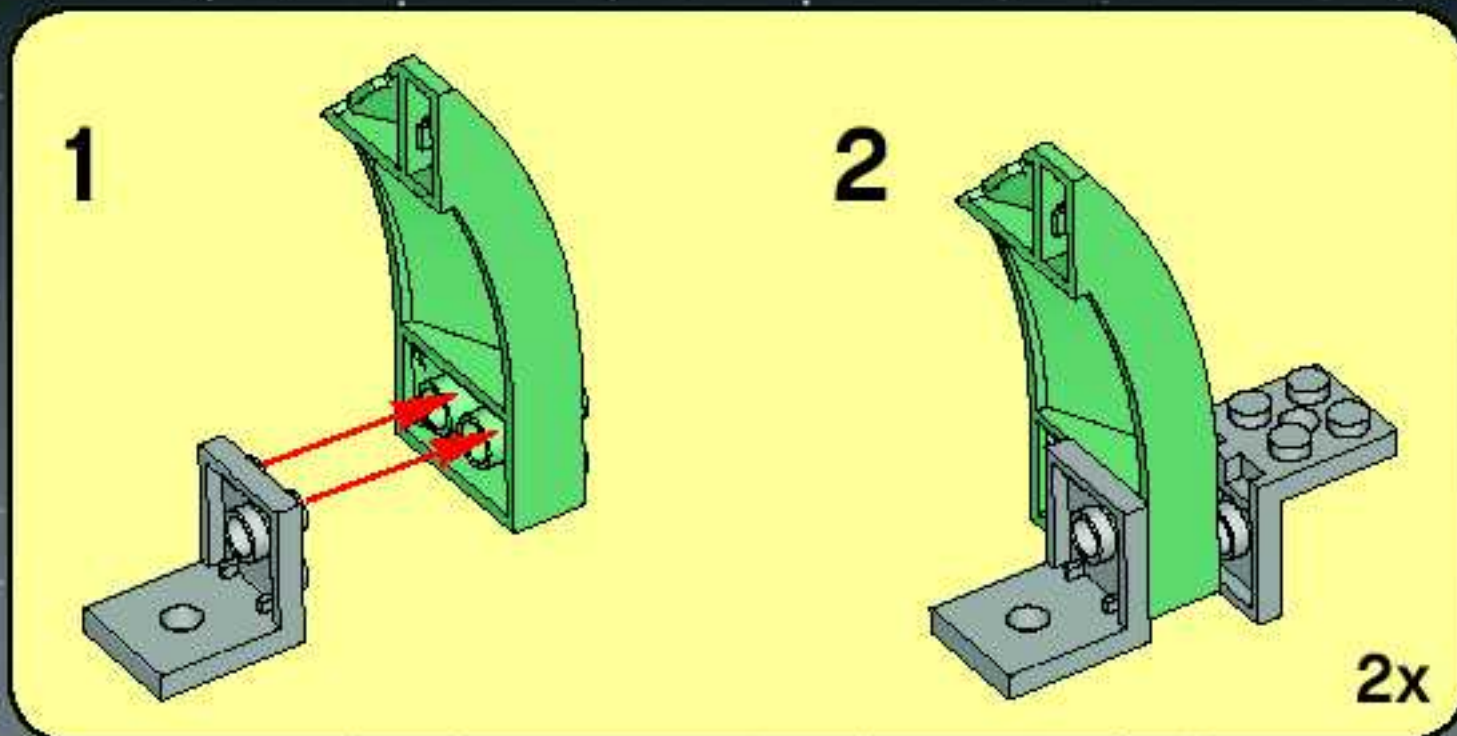

17

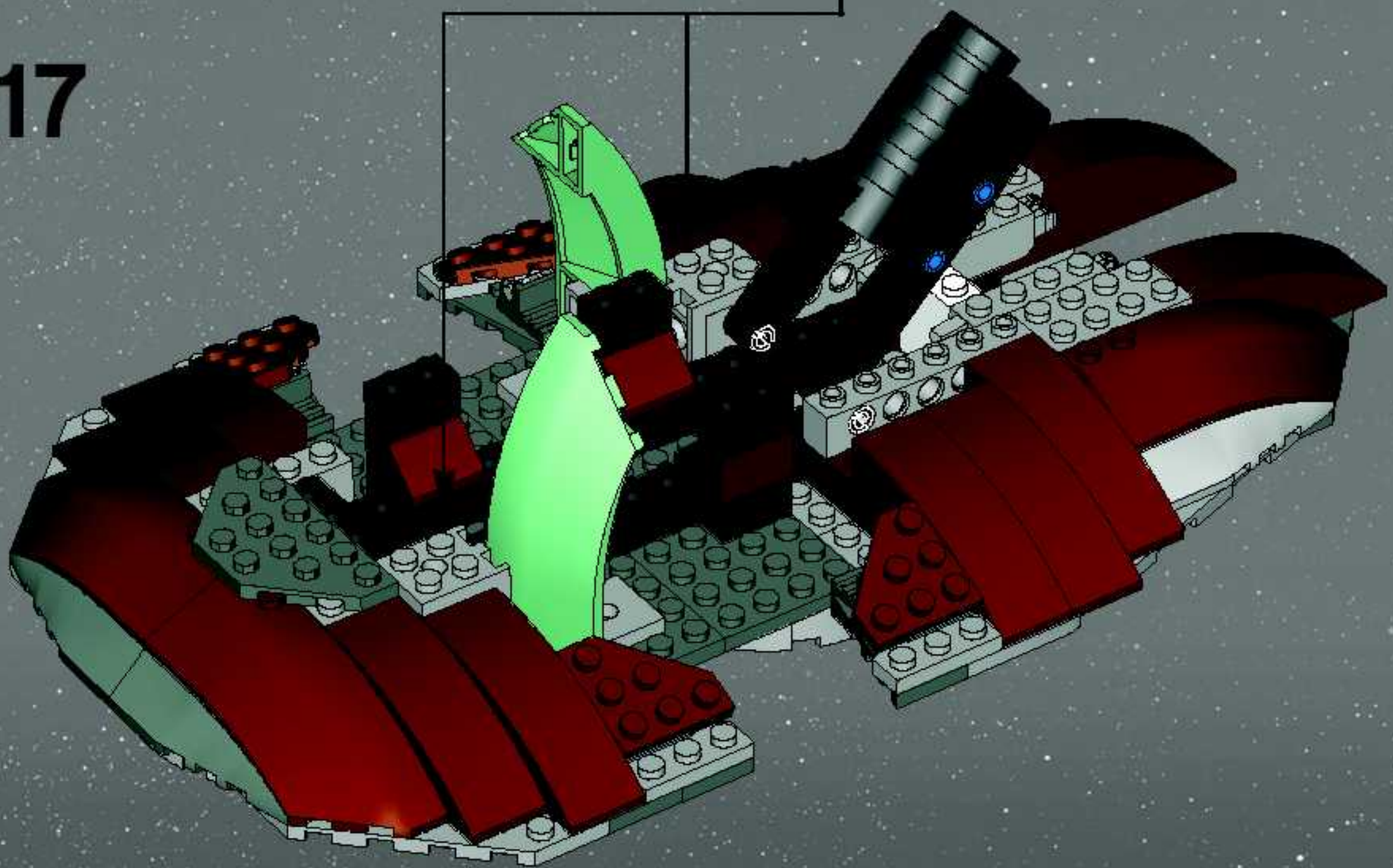

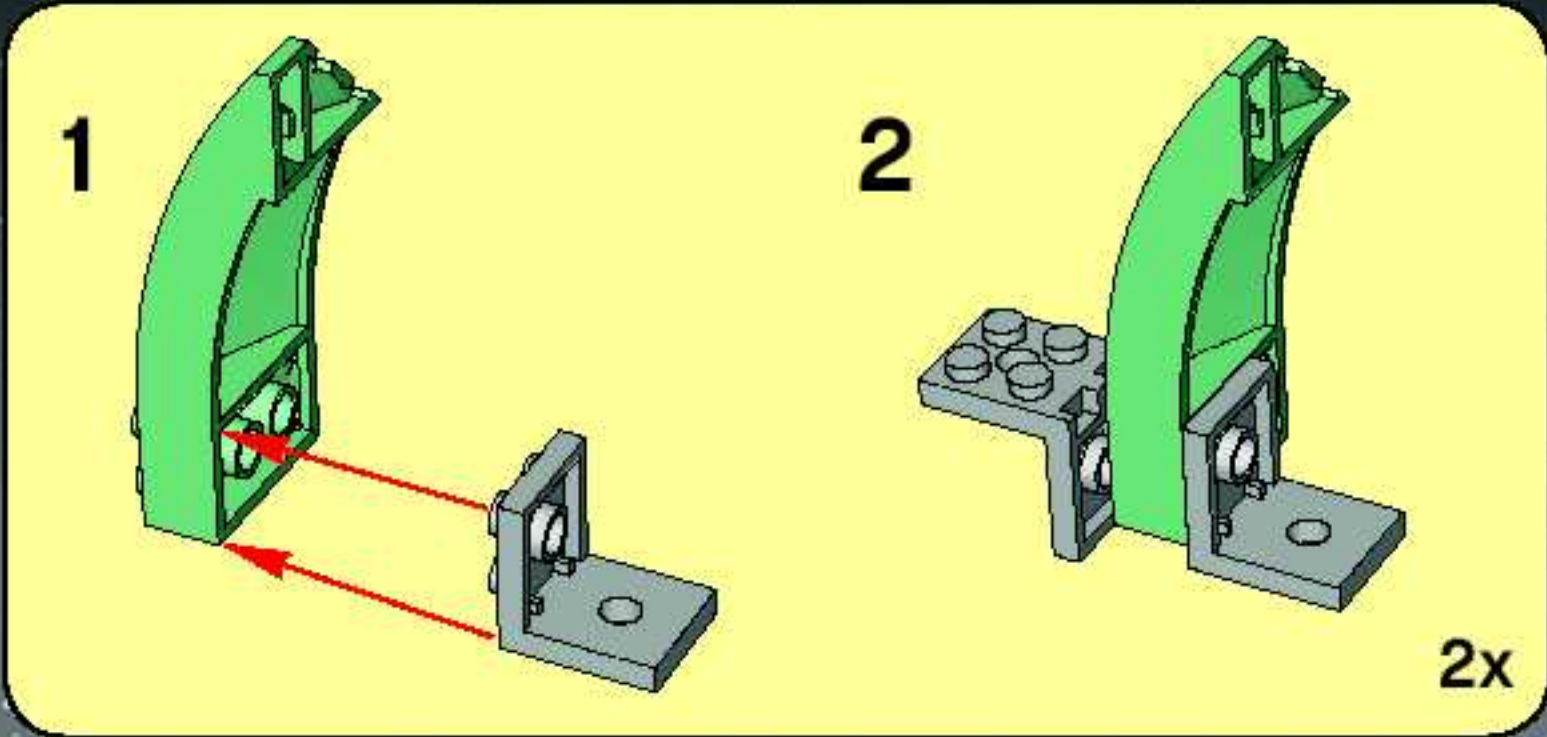

18

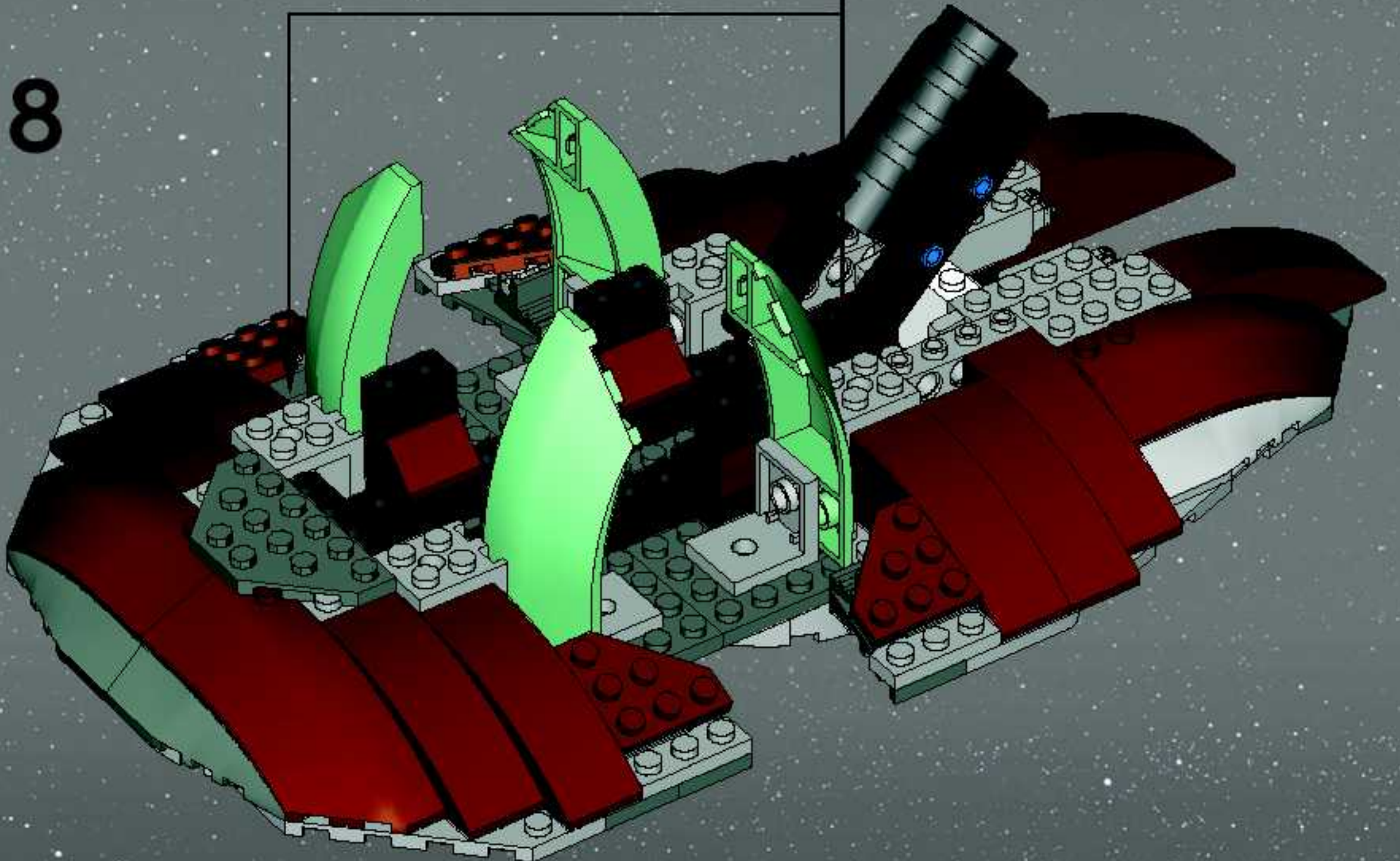

19



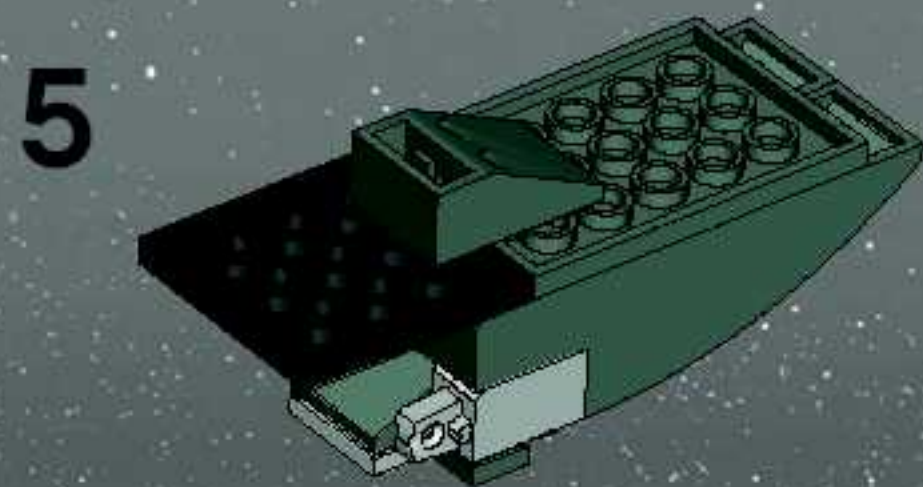
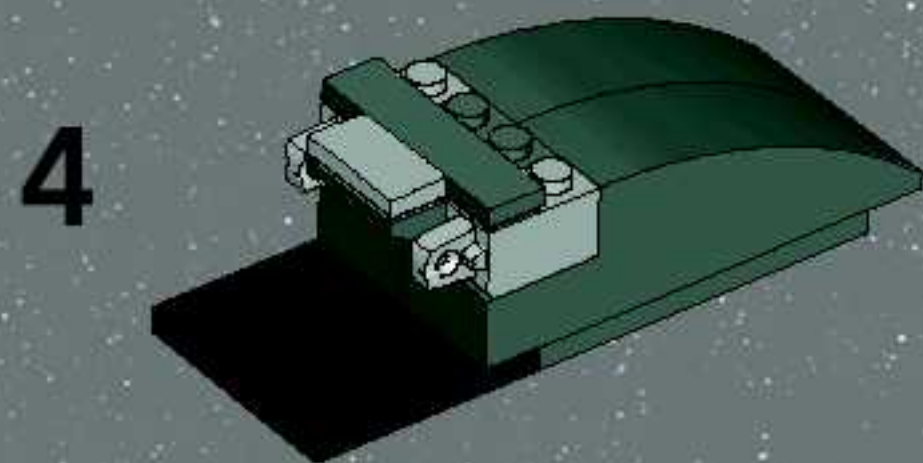
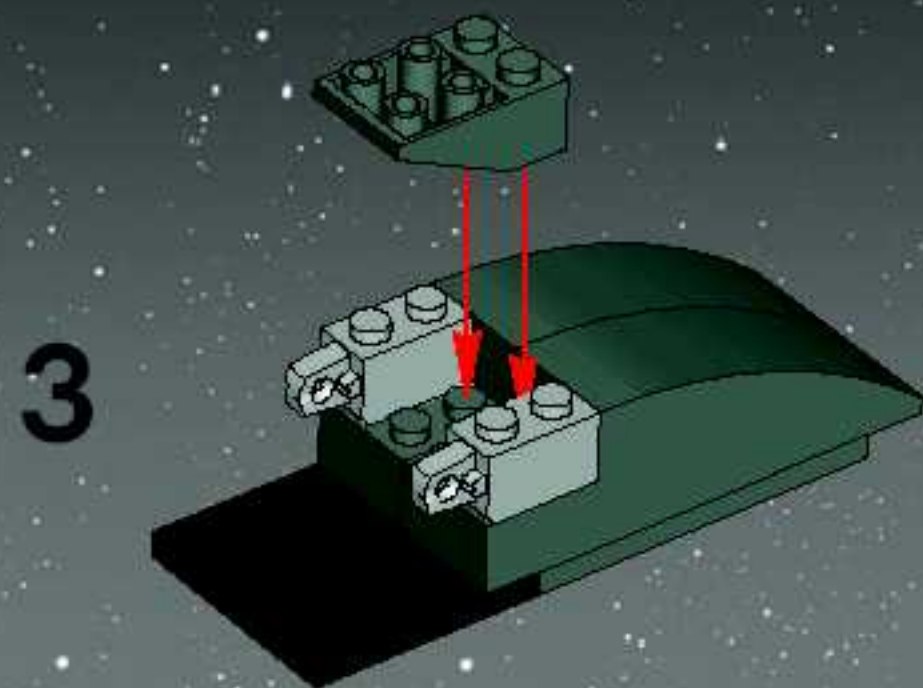
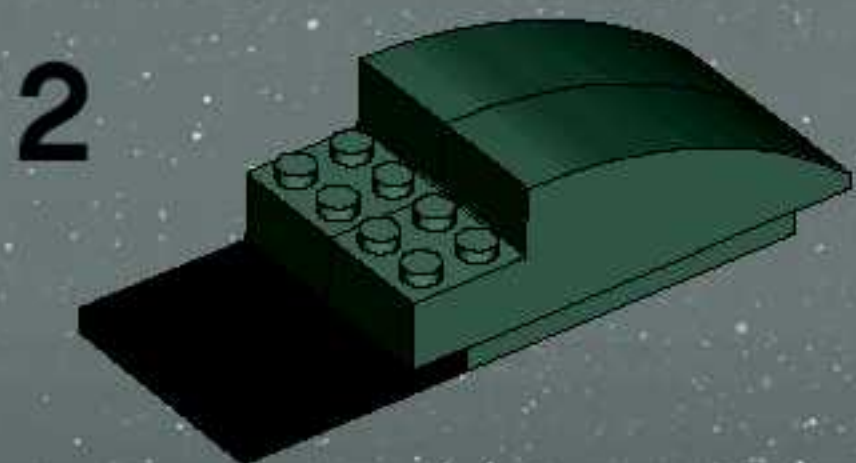
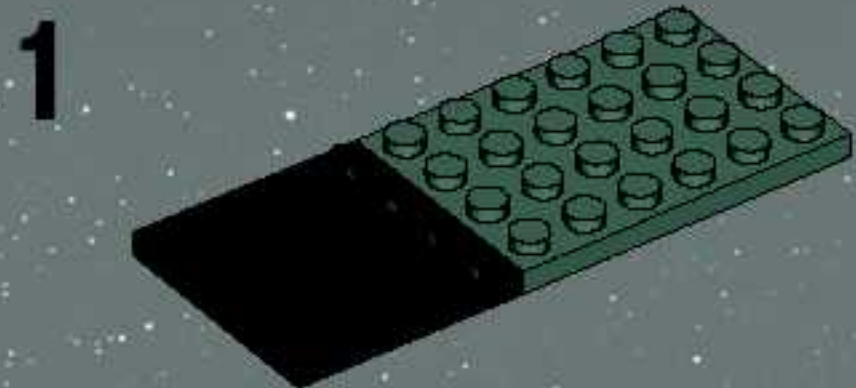



20



21

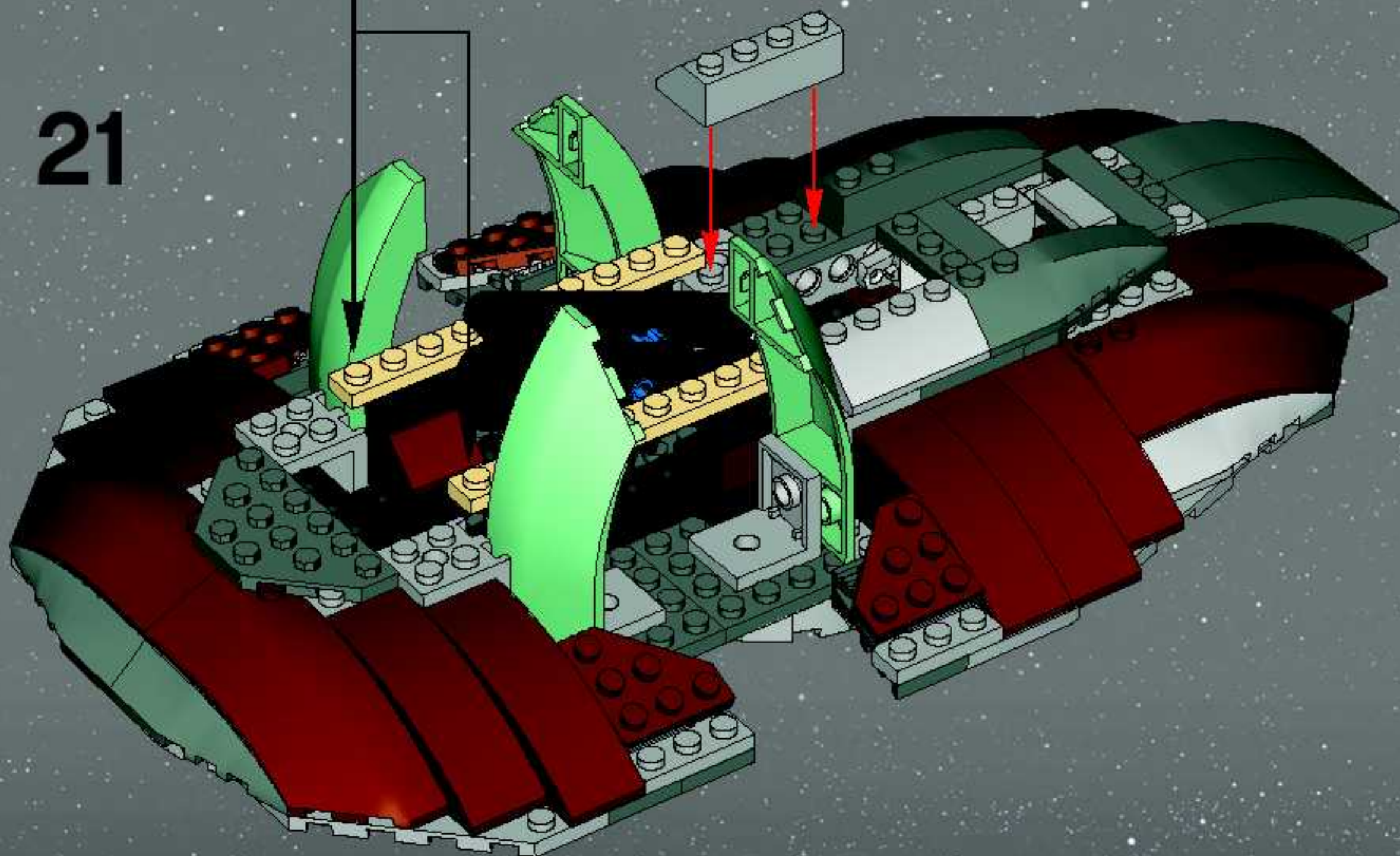
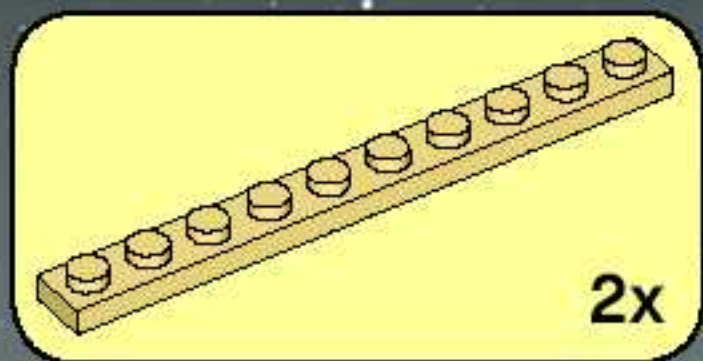

22



1



2

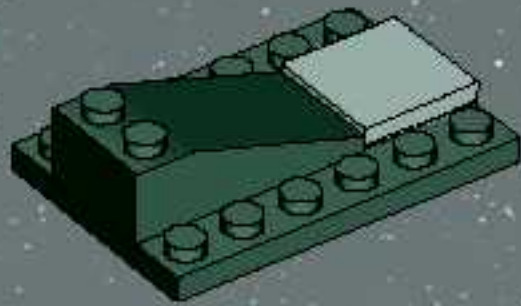

3

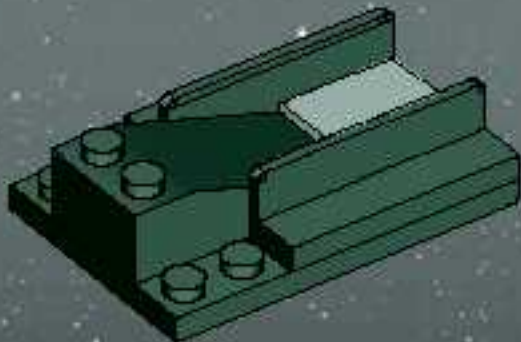

4

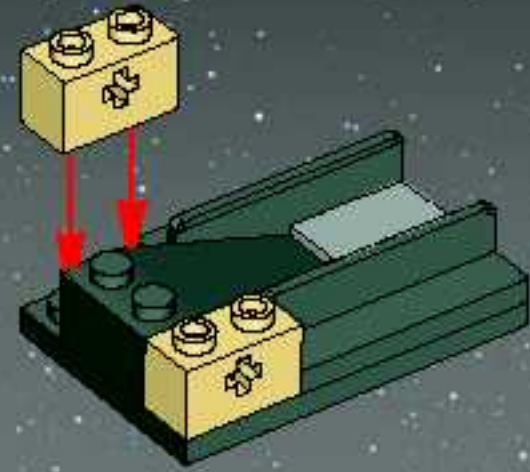

5

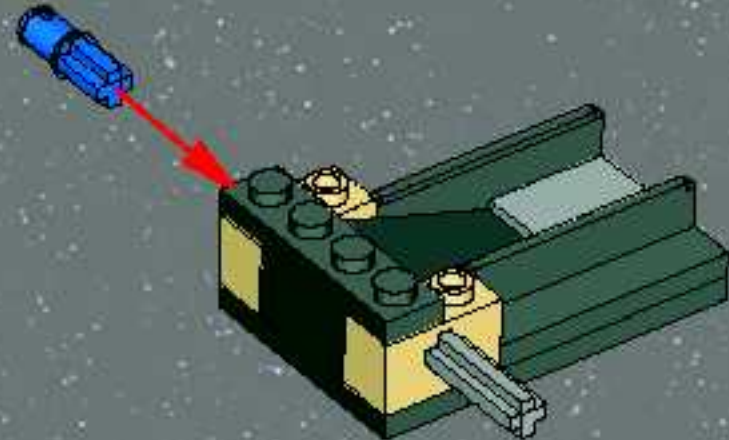

6

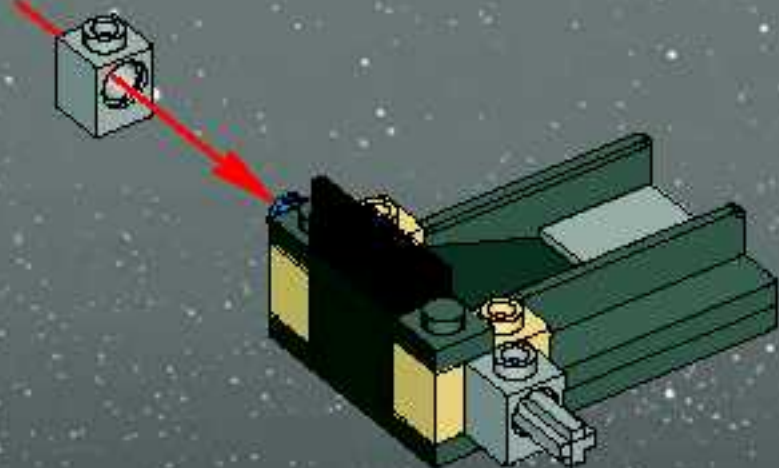

7



23

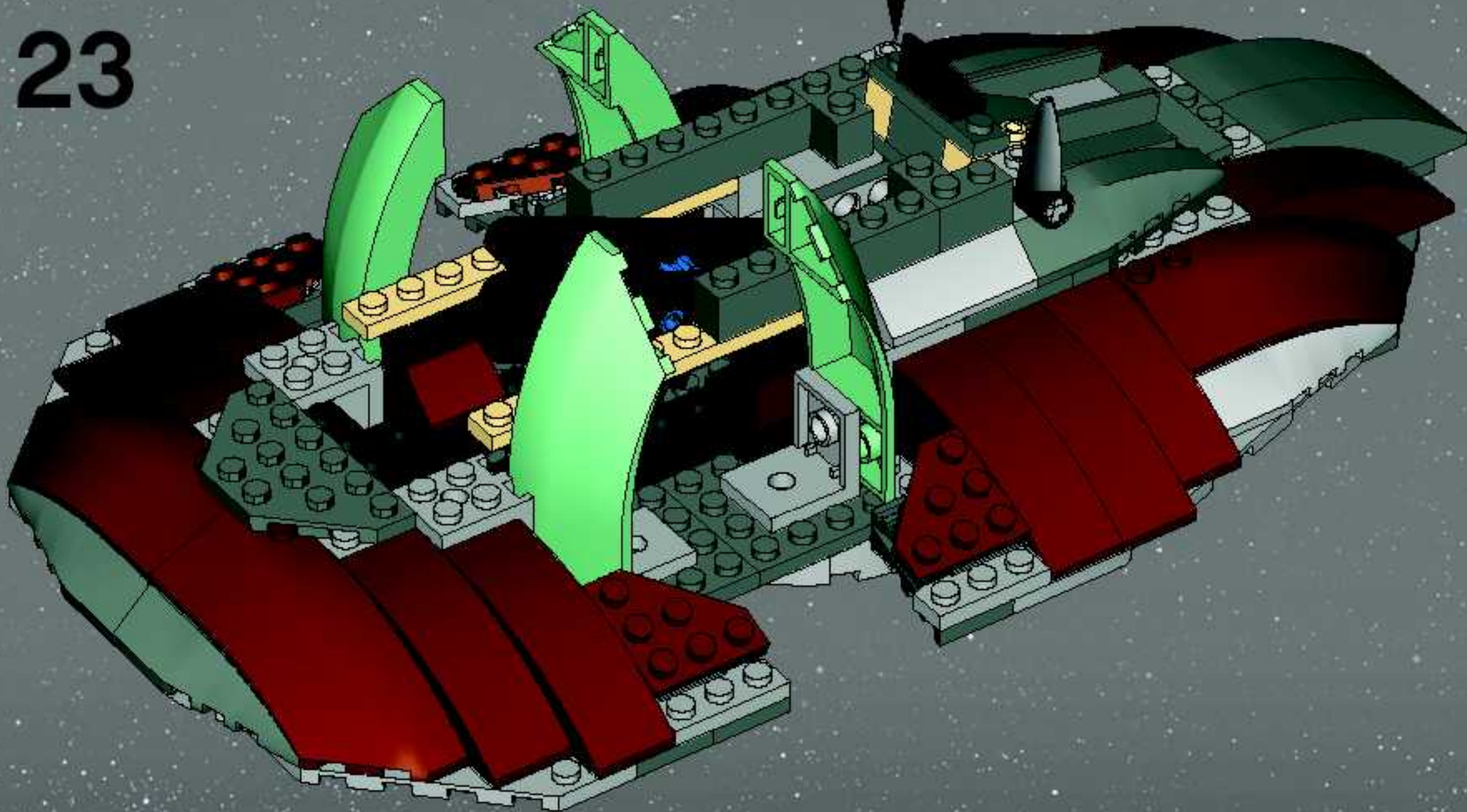

24

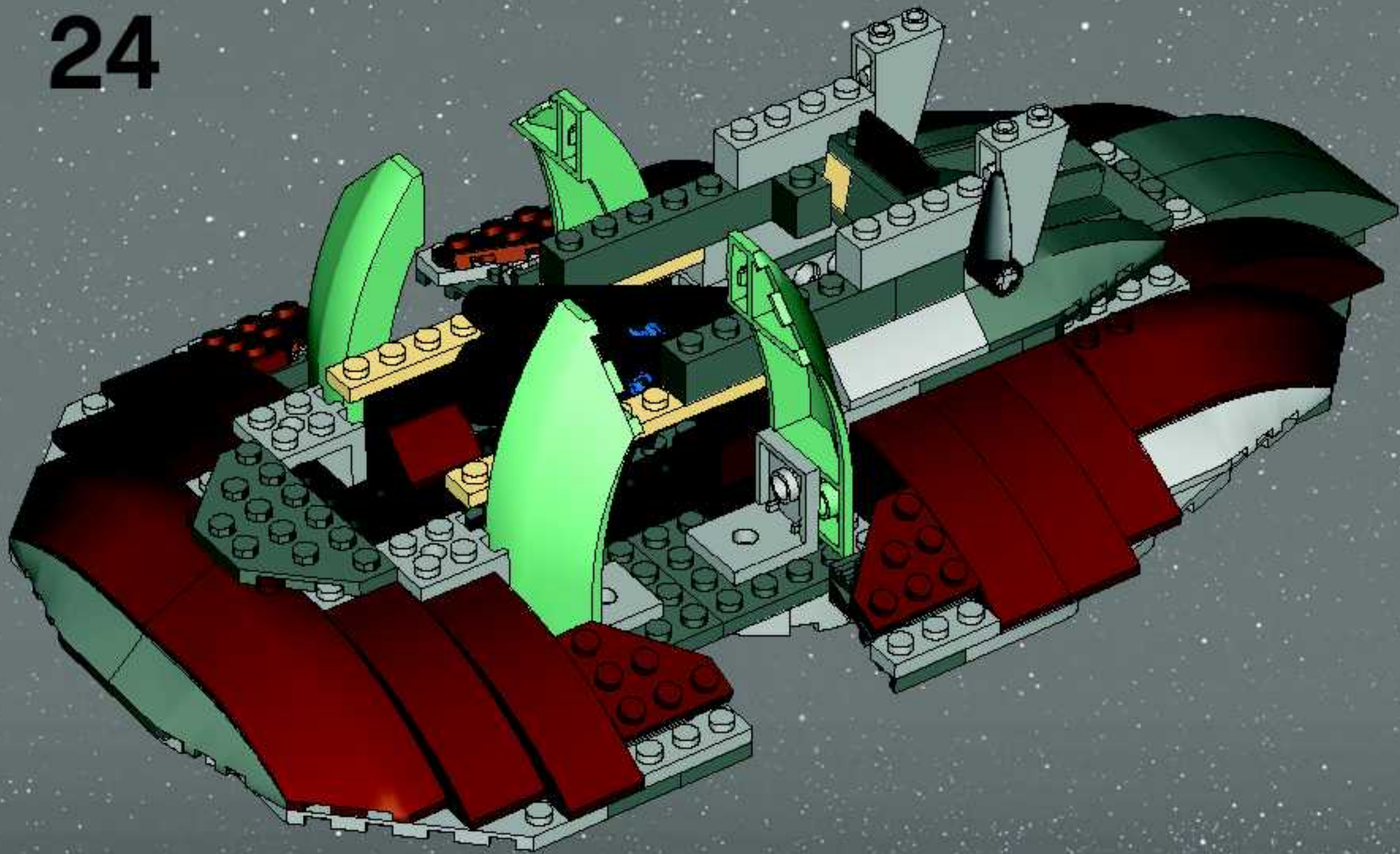

25

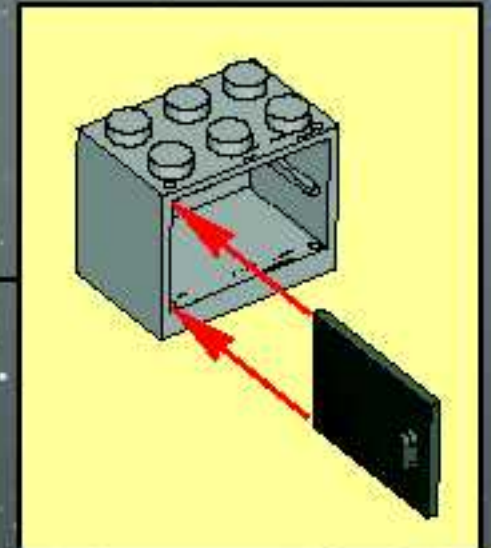
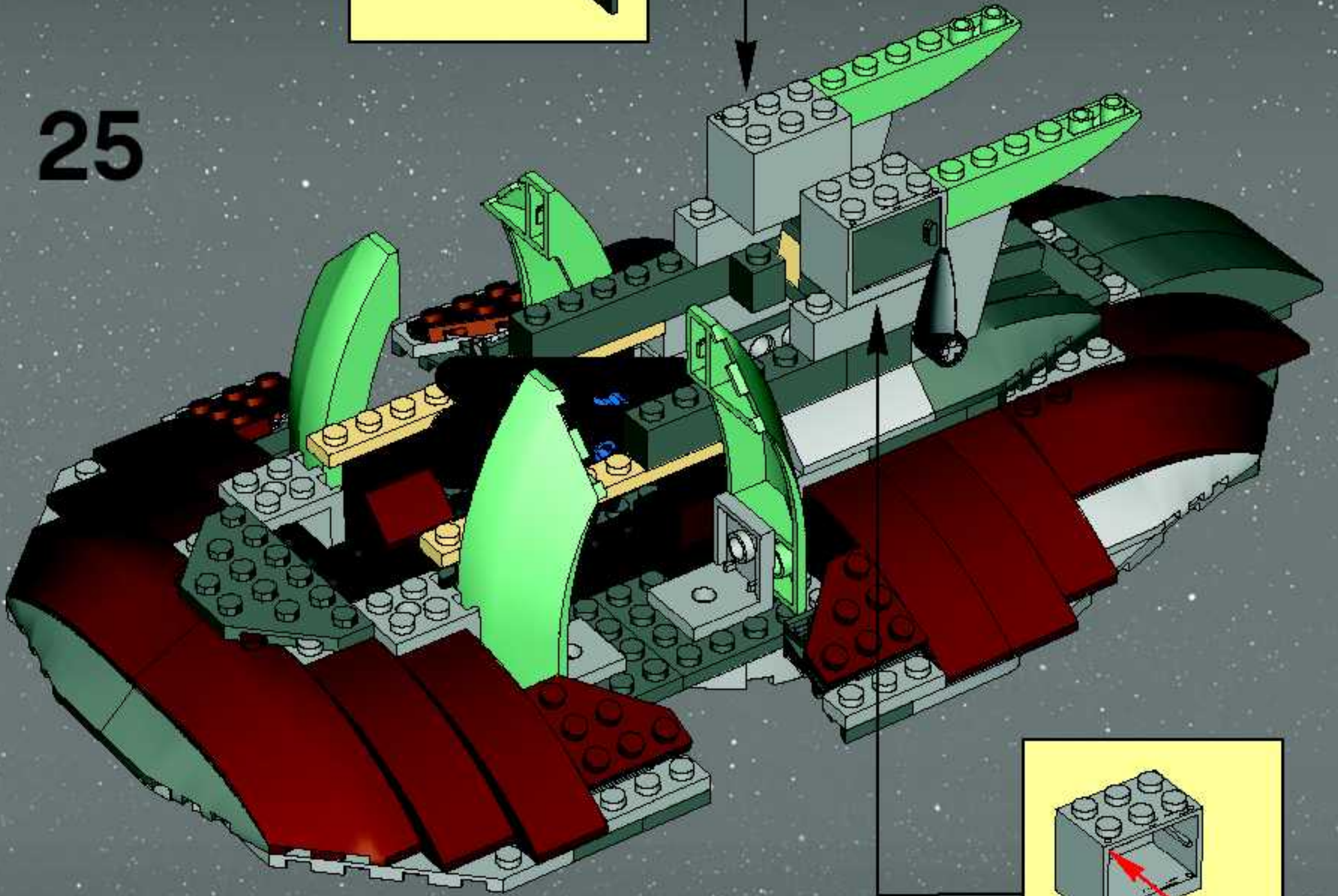
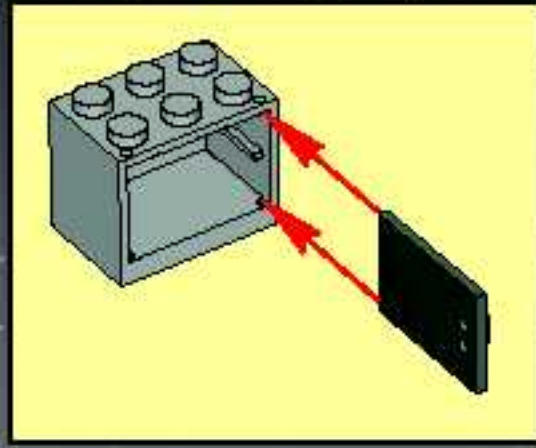

26

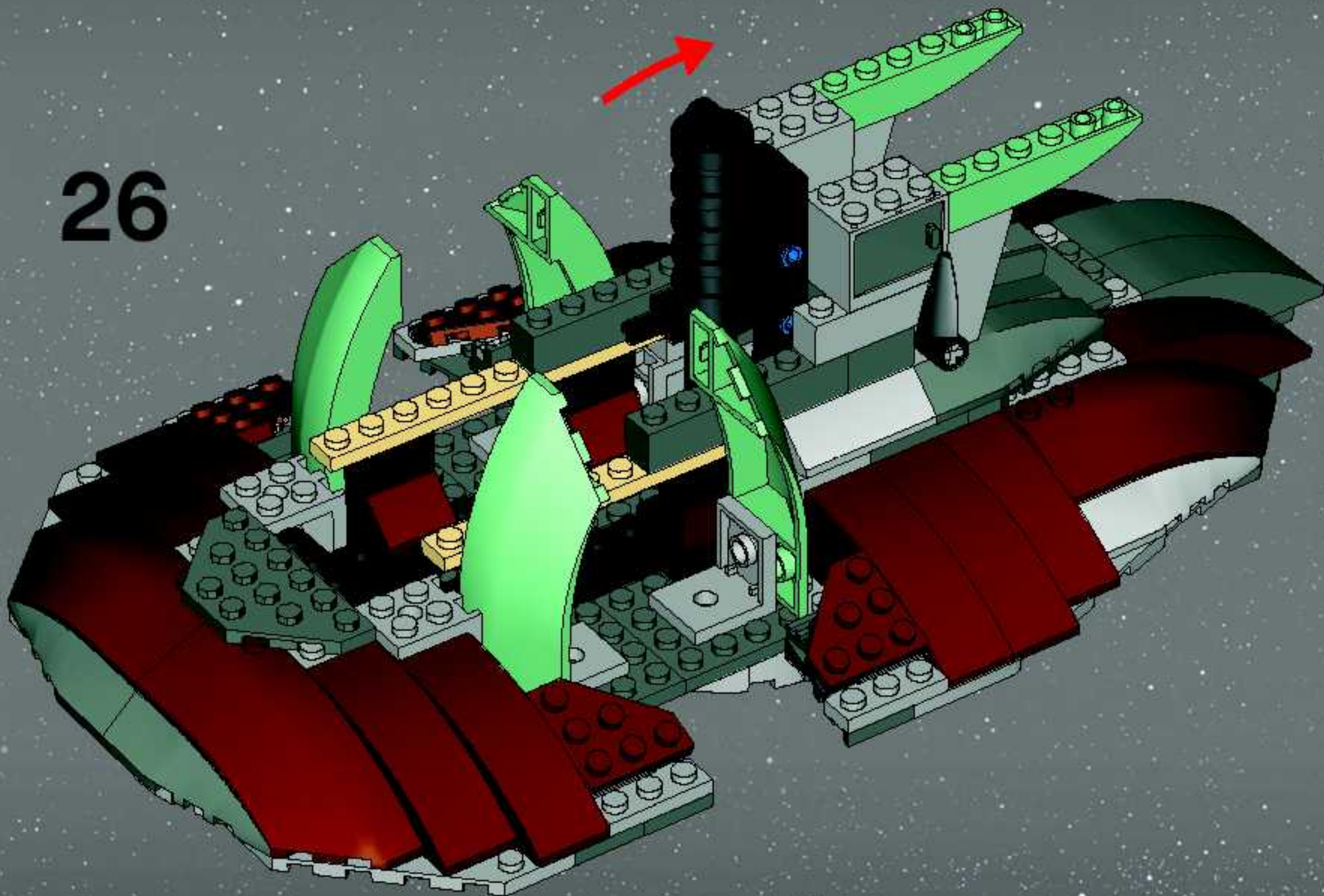



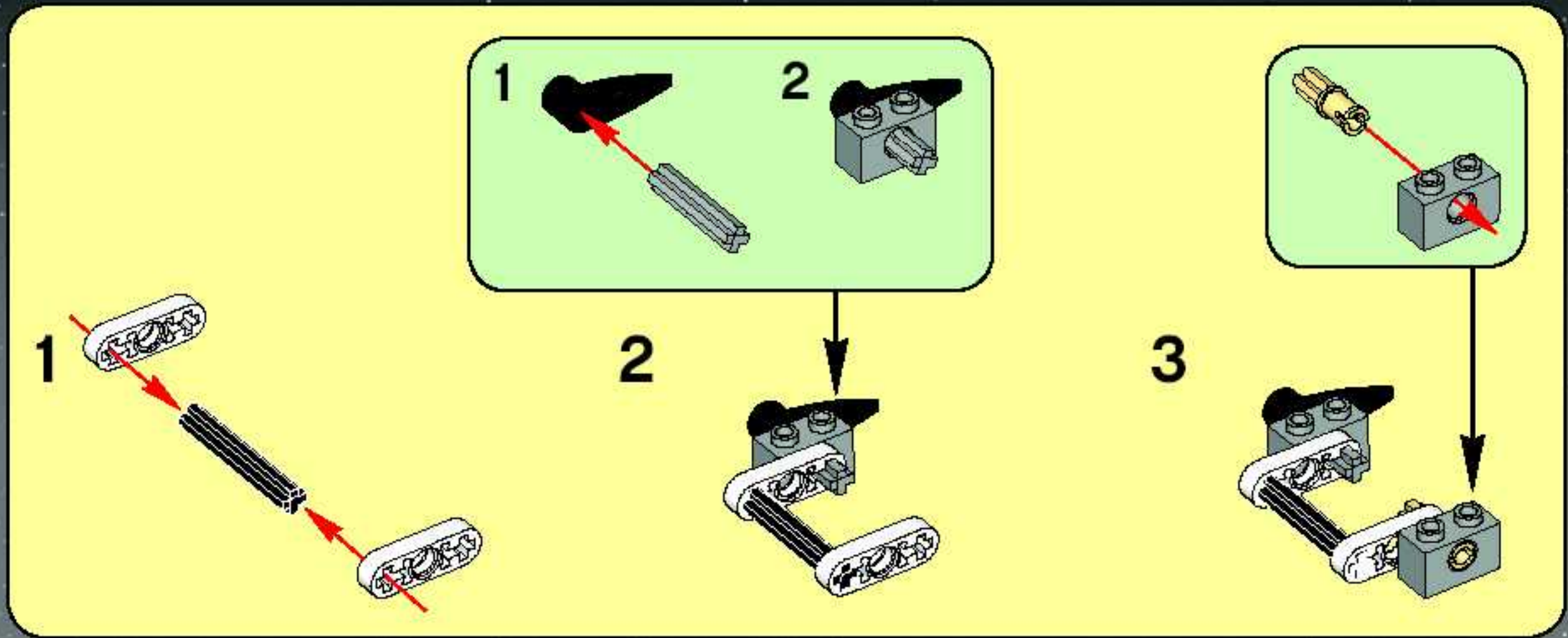

27

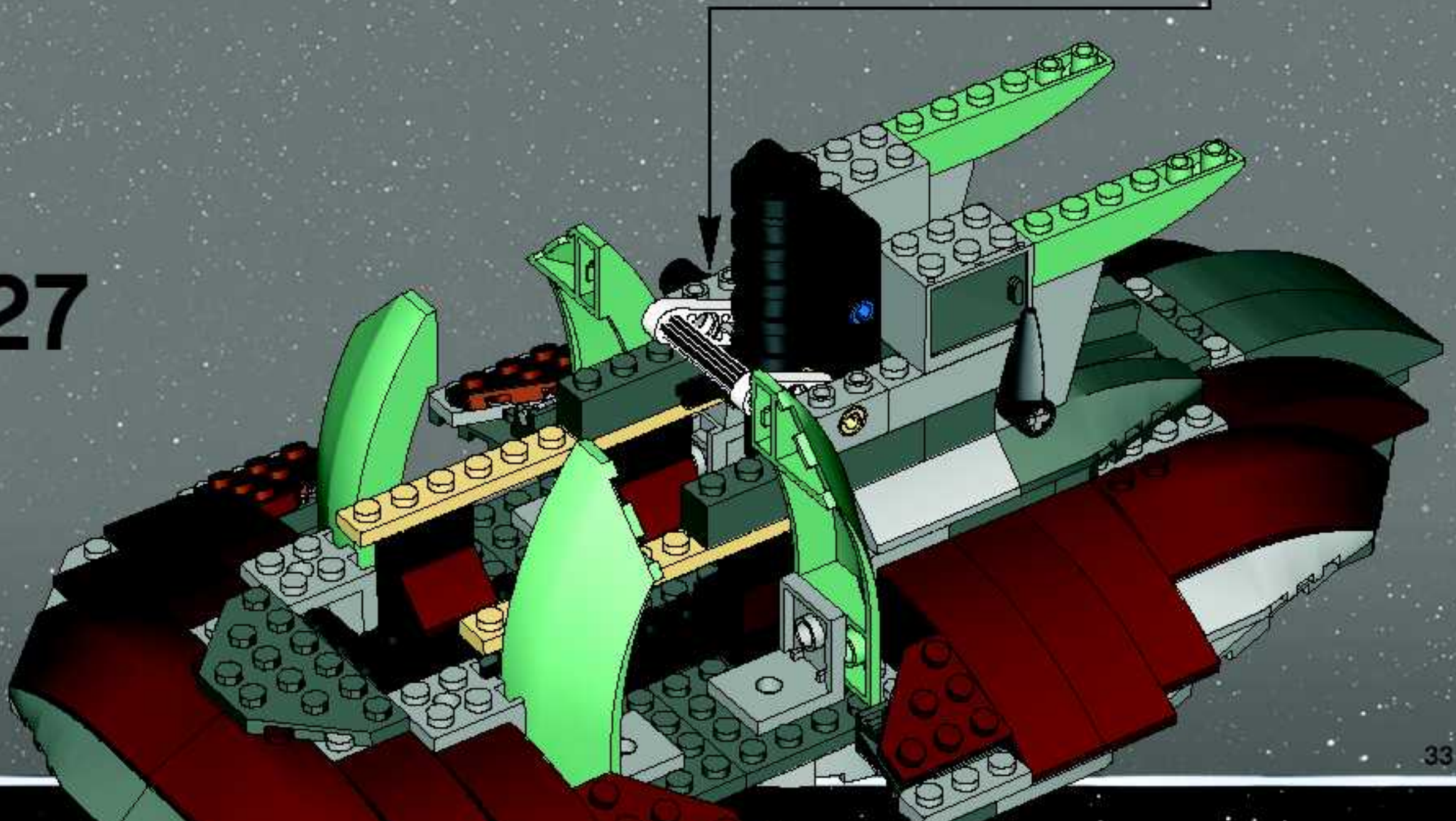

1

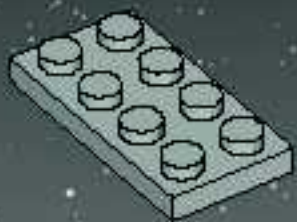

1

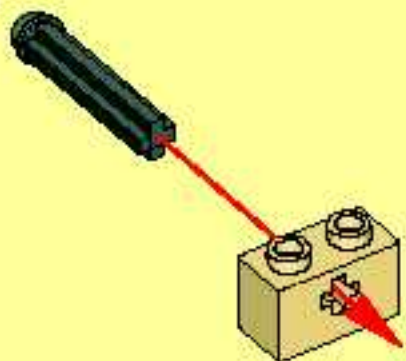

2

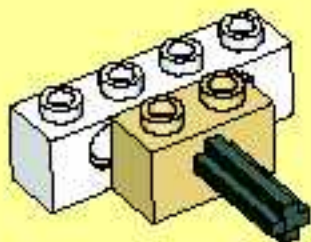

2x

2

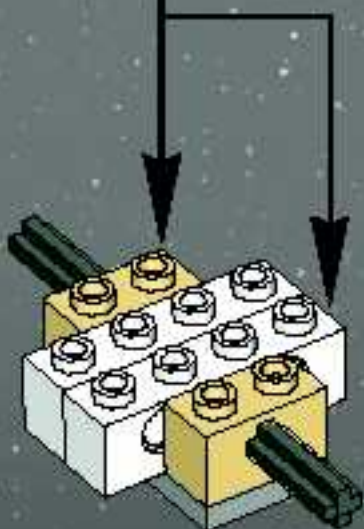

3

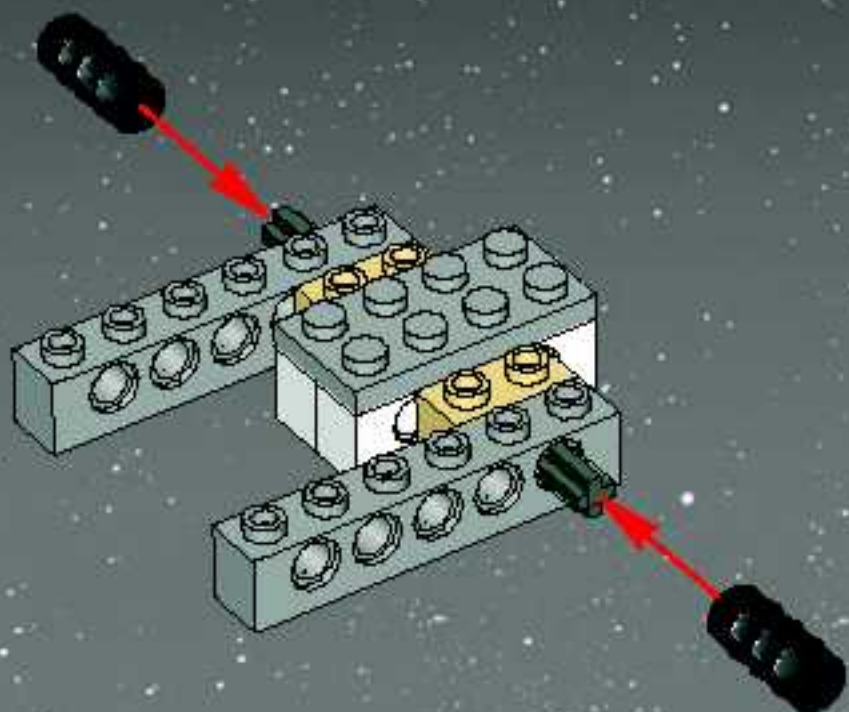

4

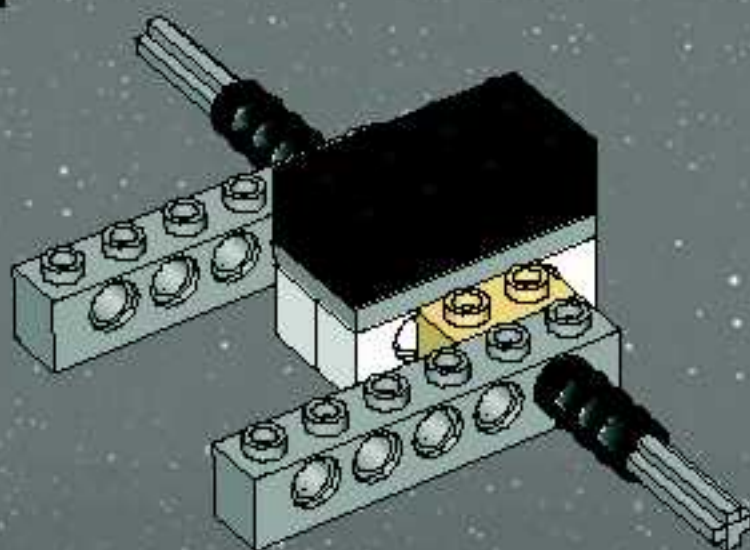

5

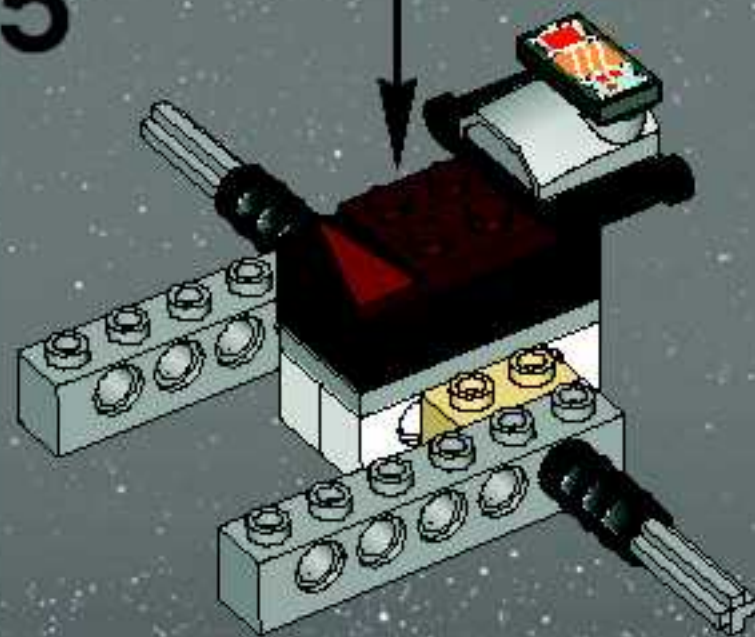

1

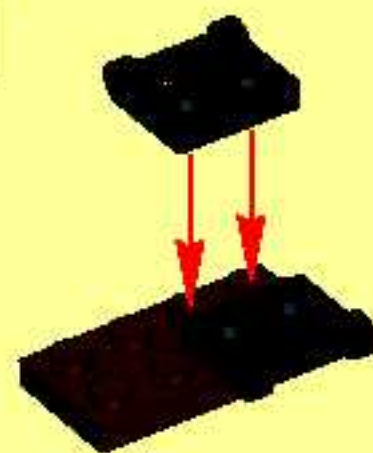

2

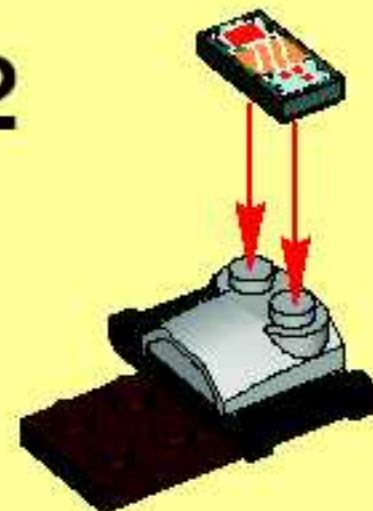

28

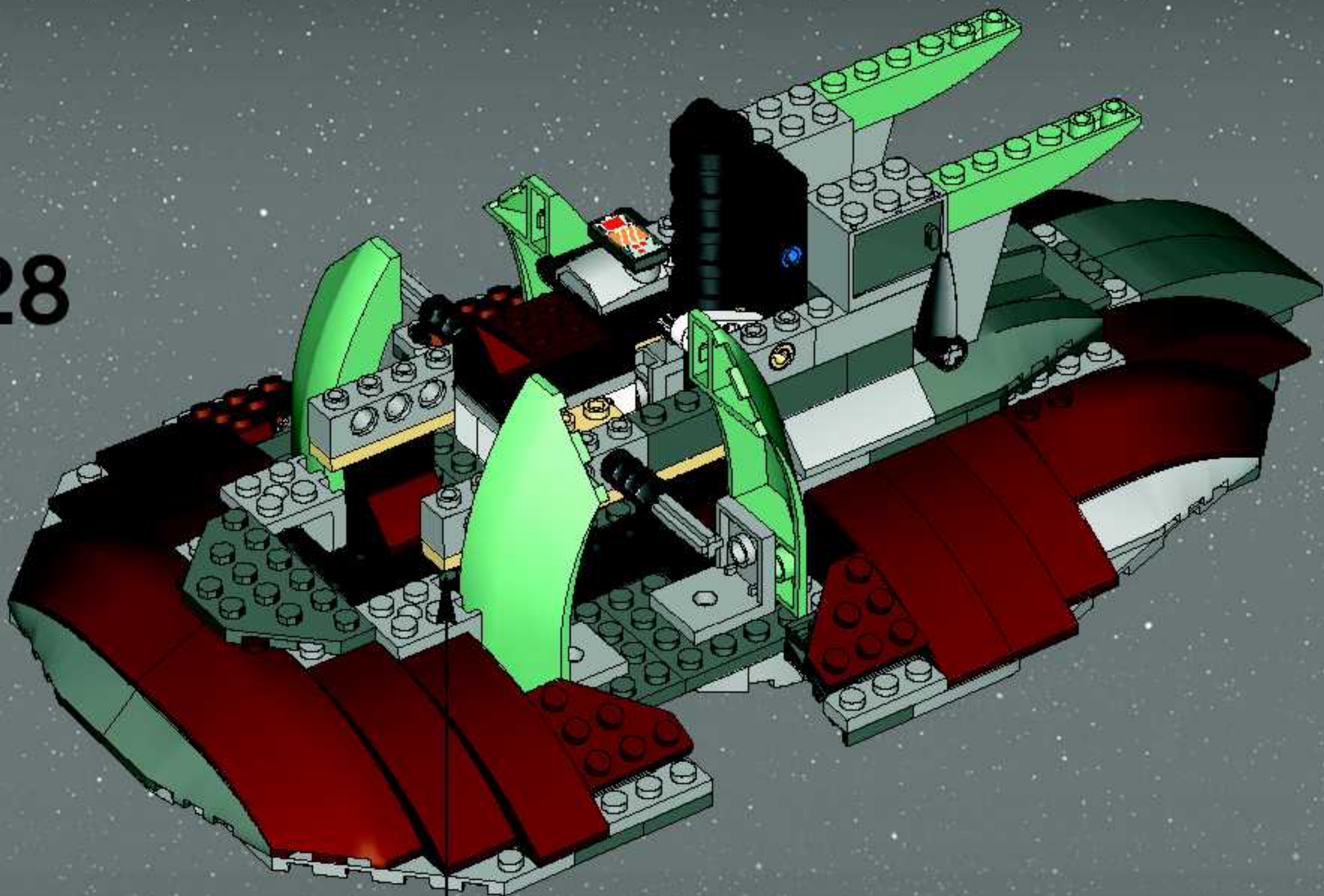

29

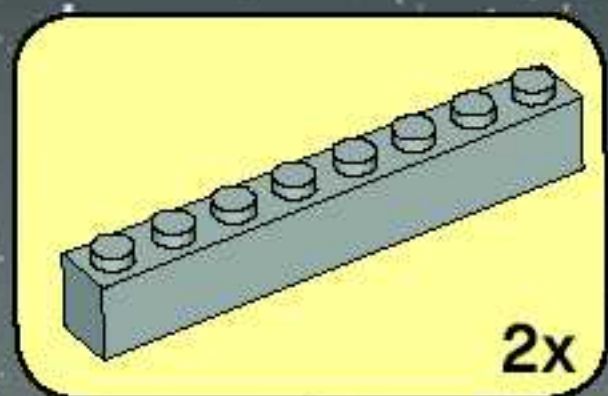

30

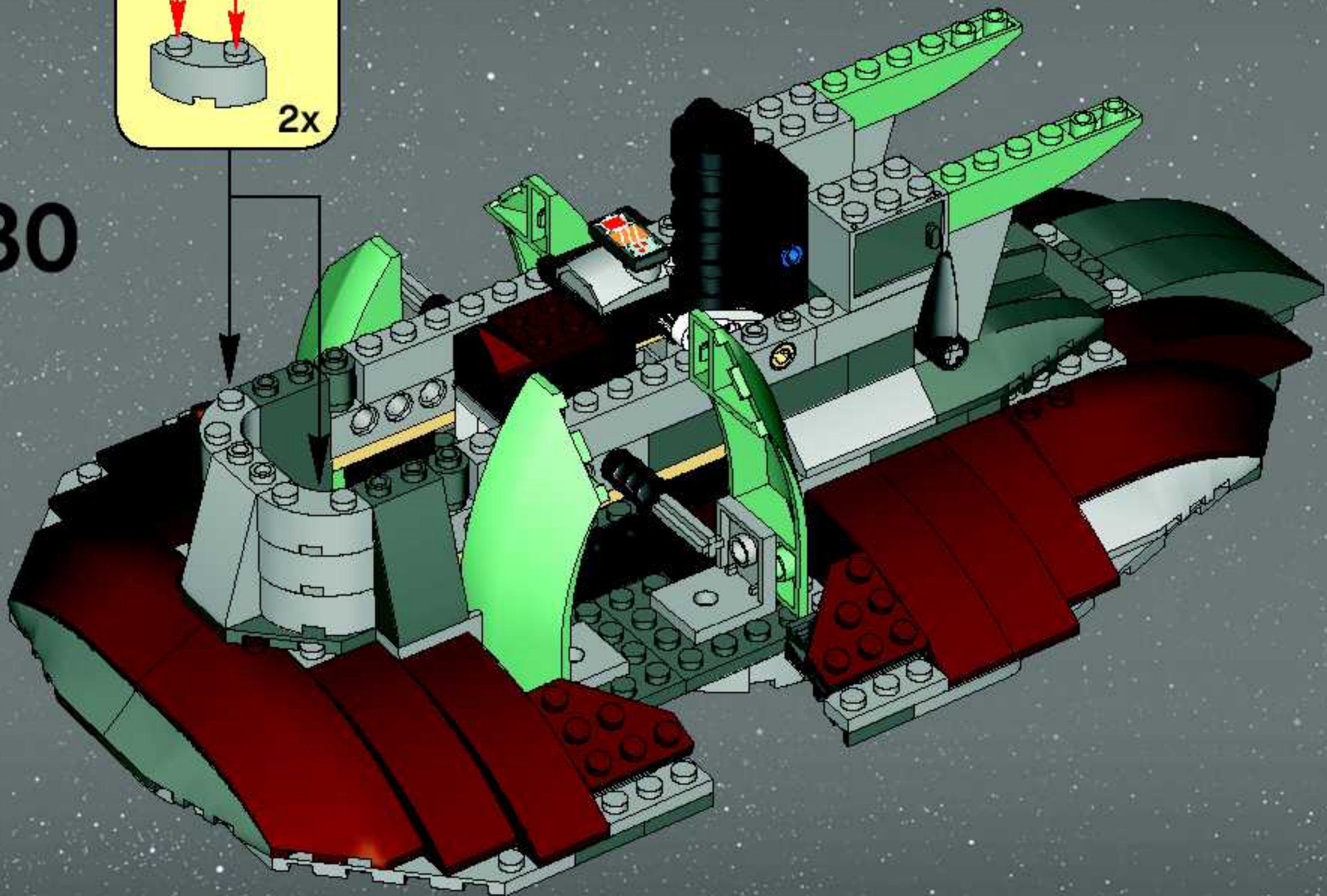
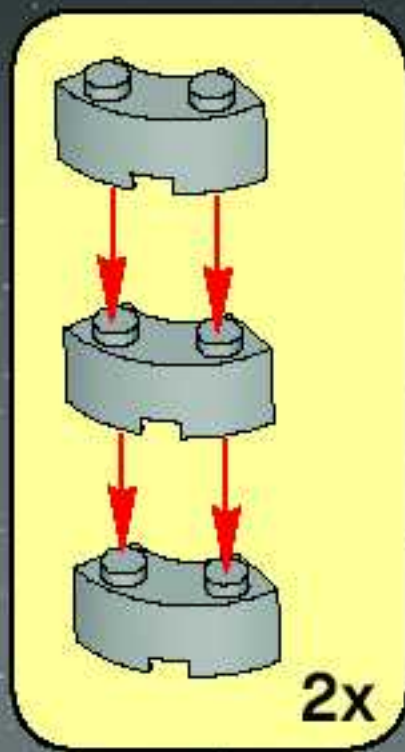

31

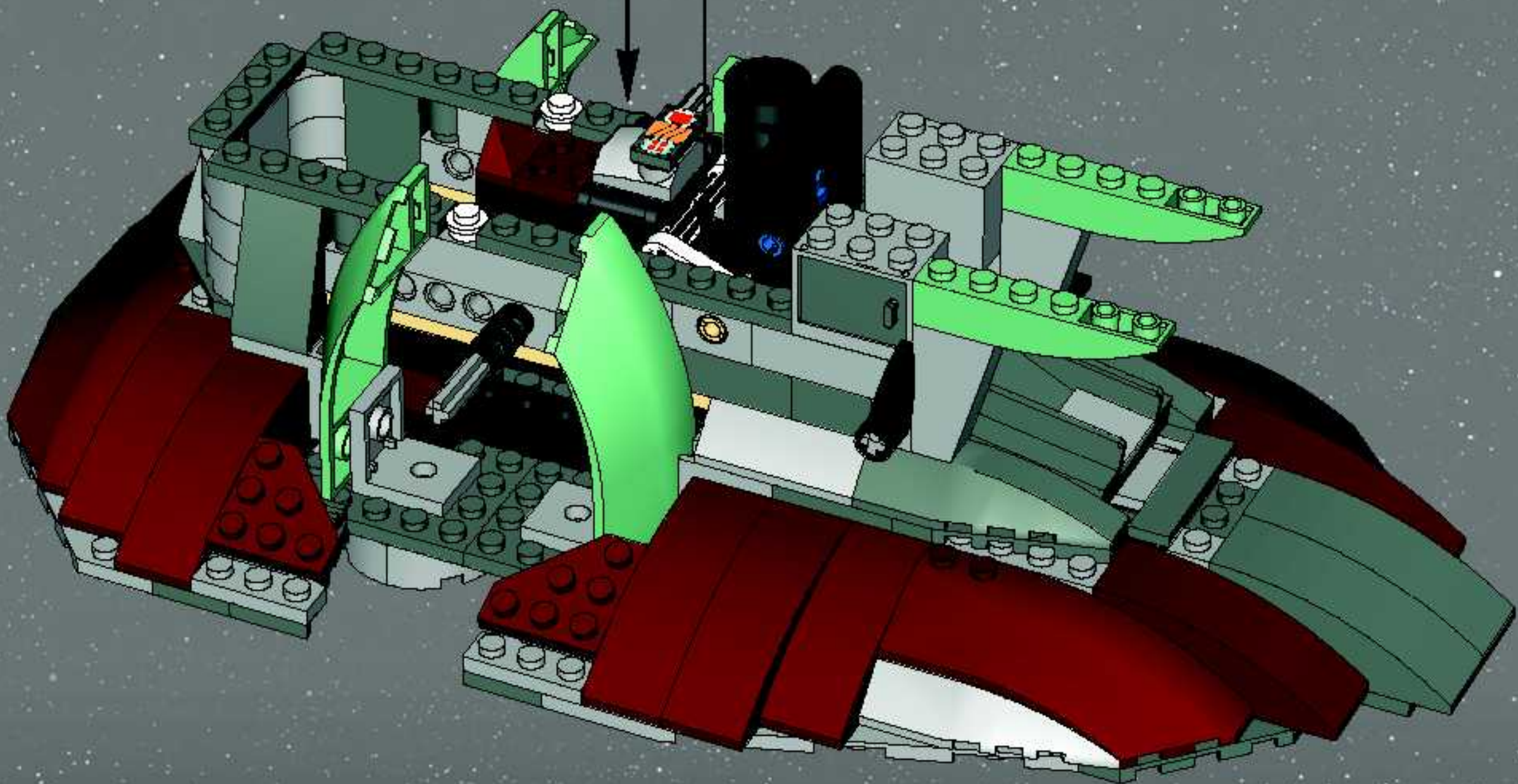
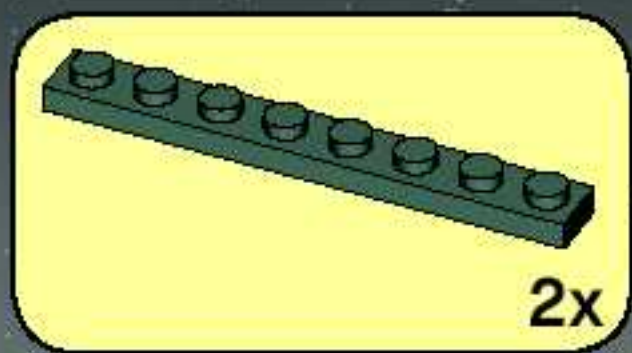

1

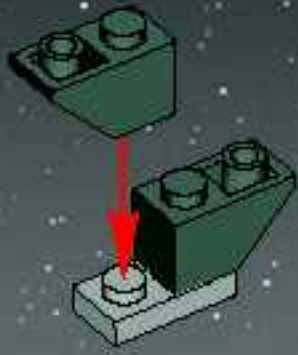

2



3

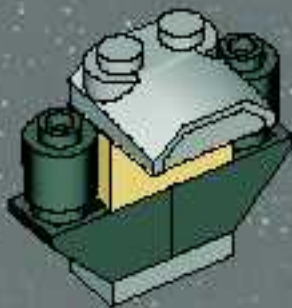

4

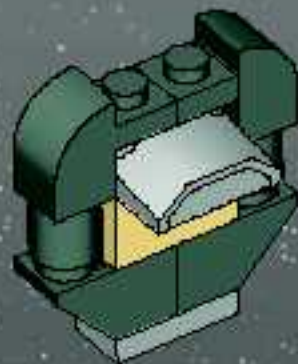

5

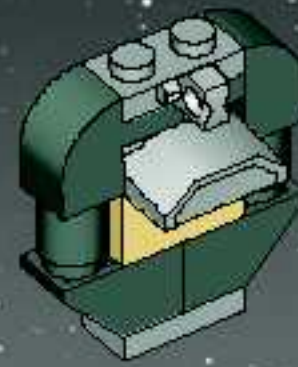

1

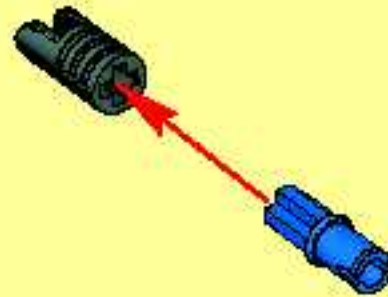

2

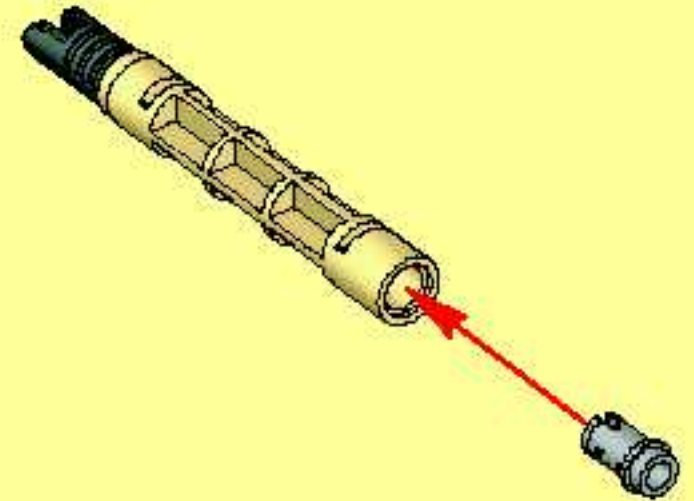

3

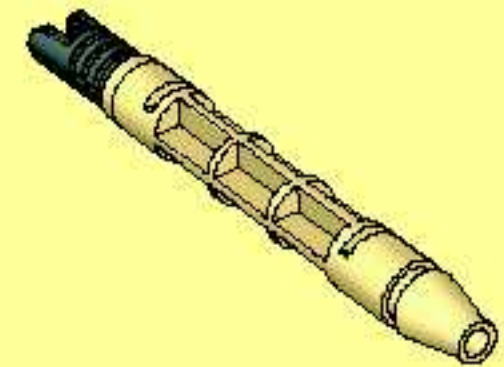

6

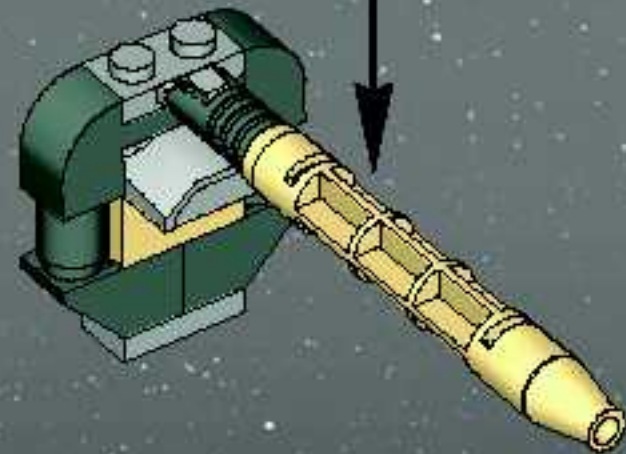

2x

32

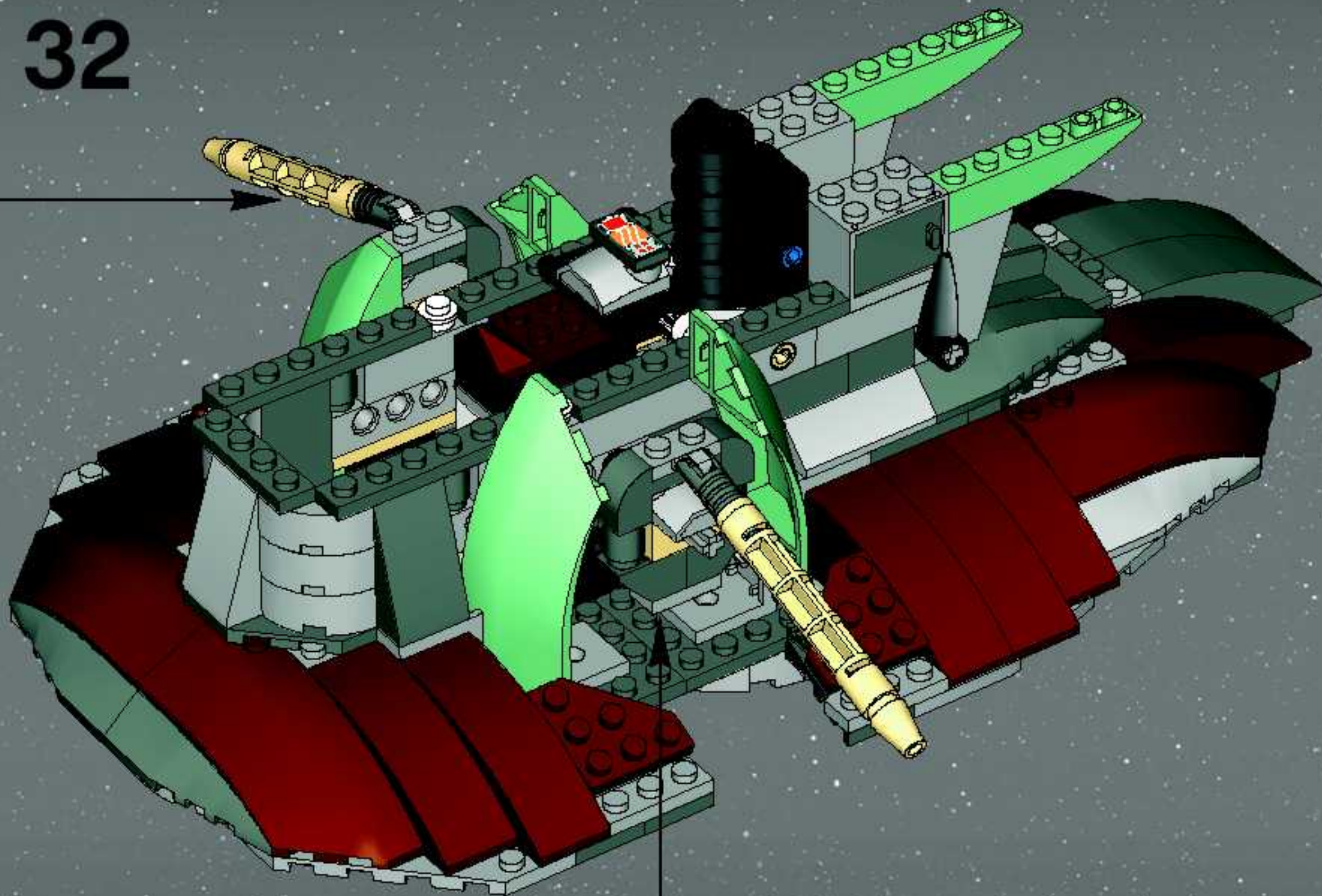





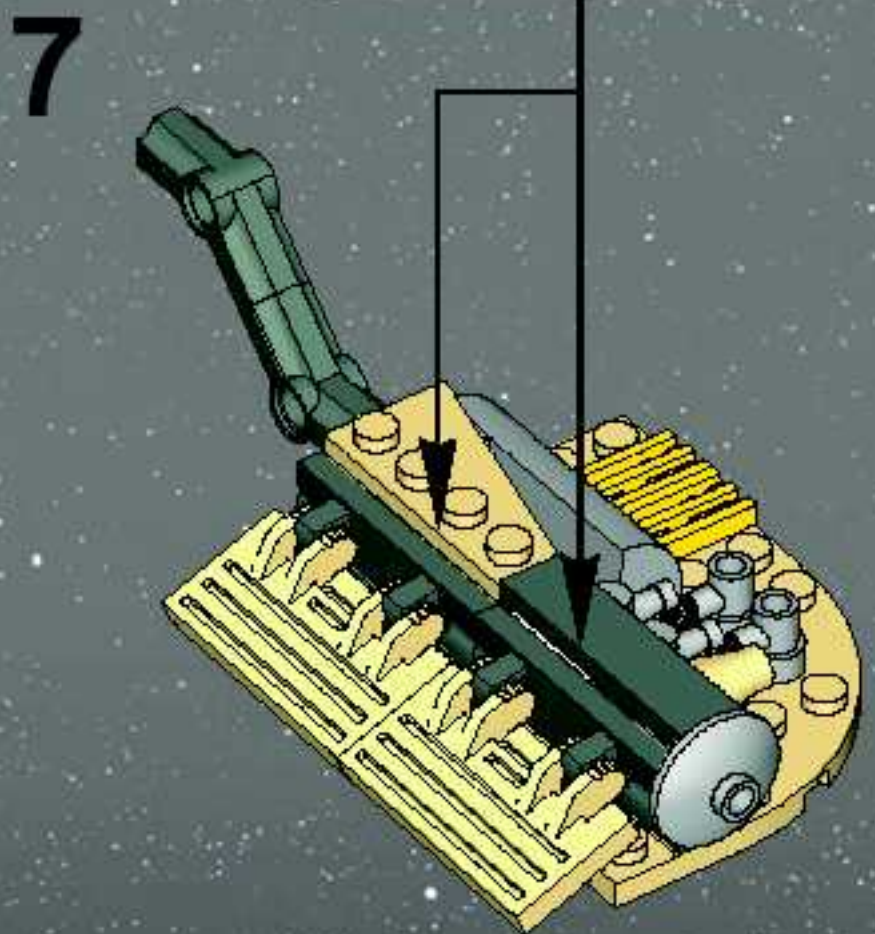
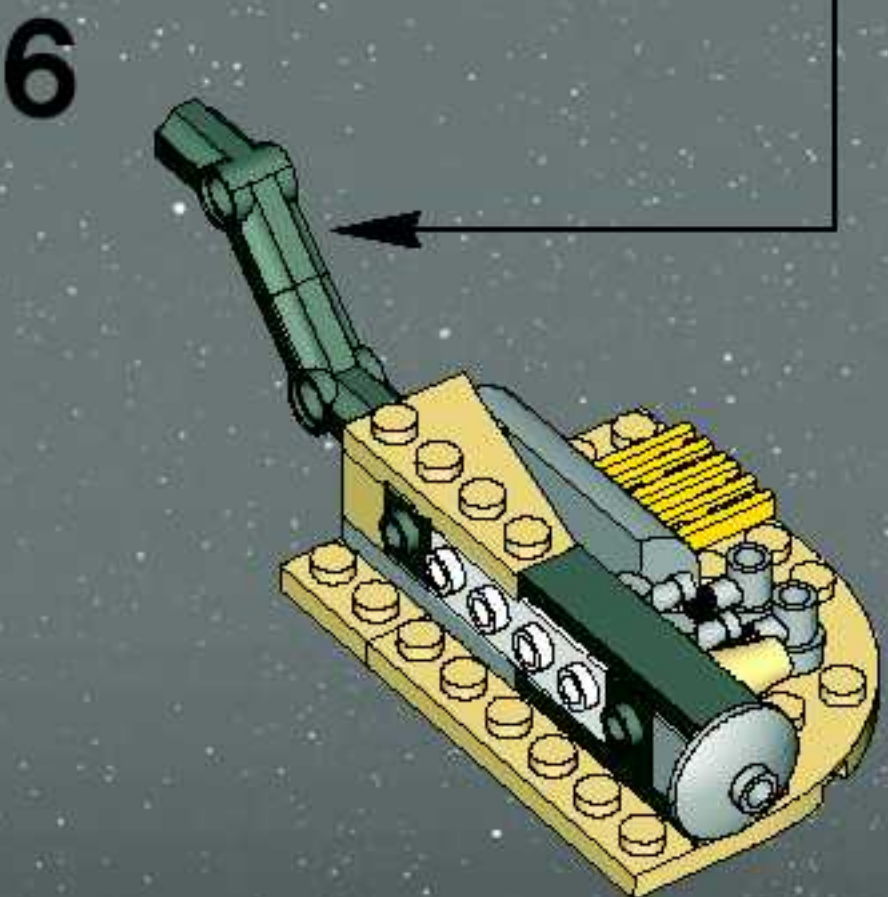
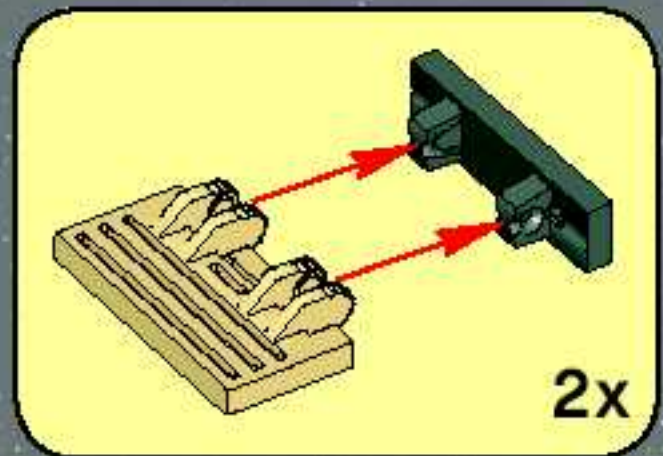
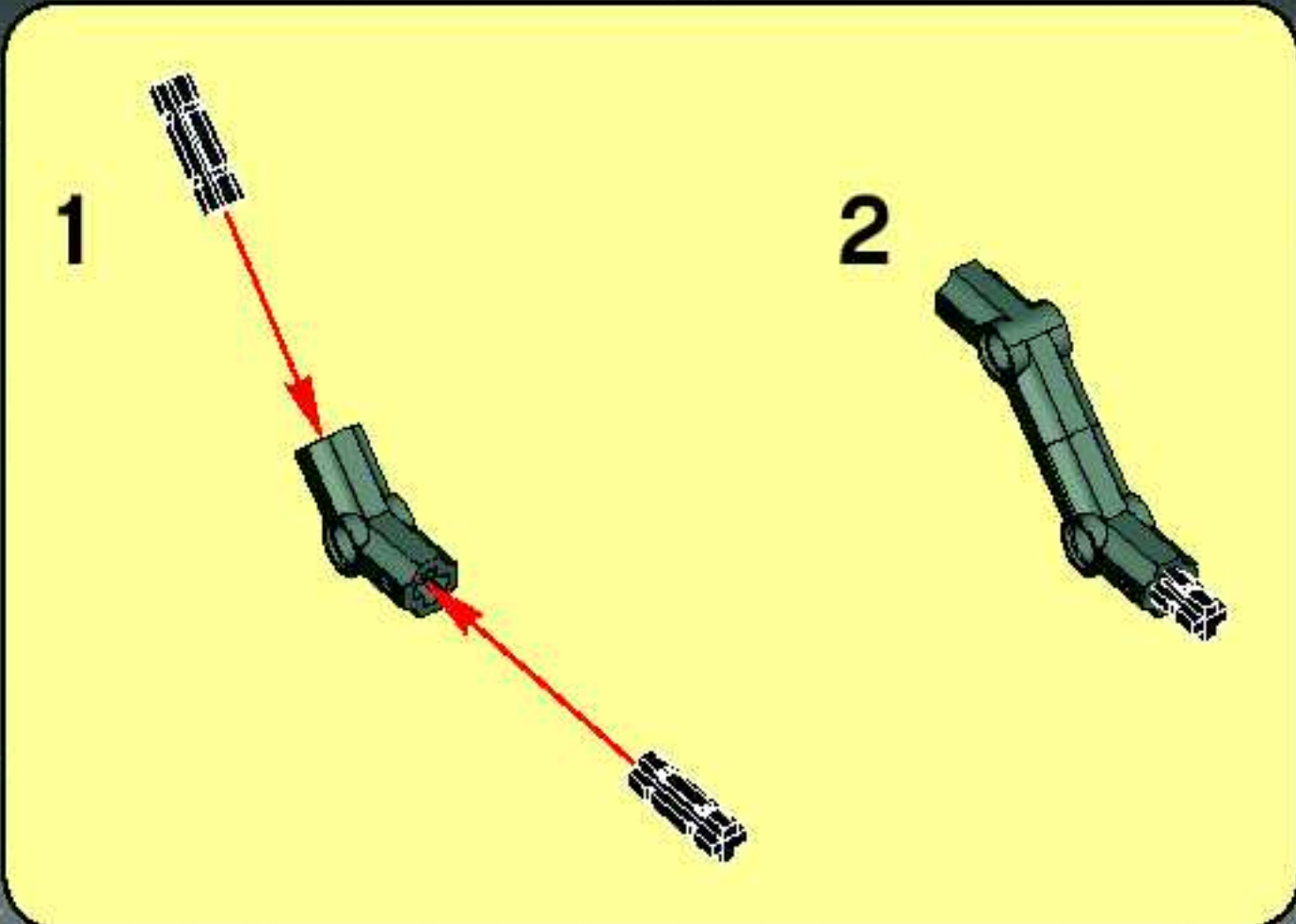

33

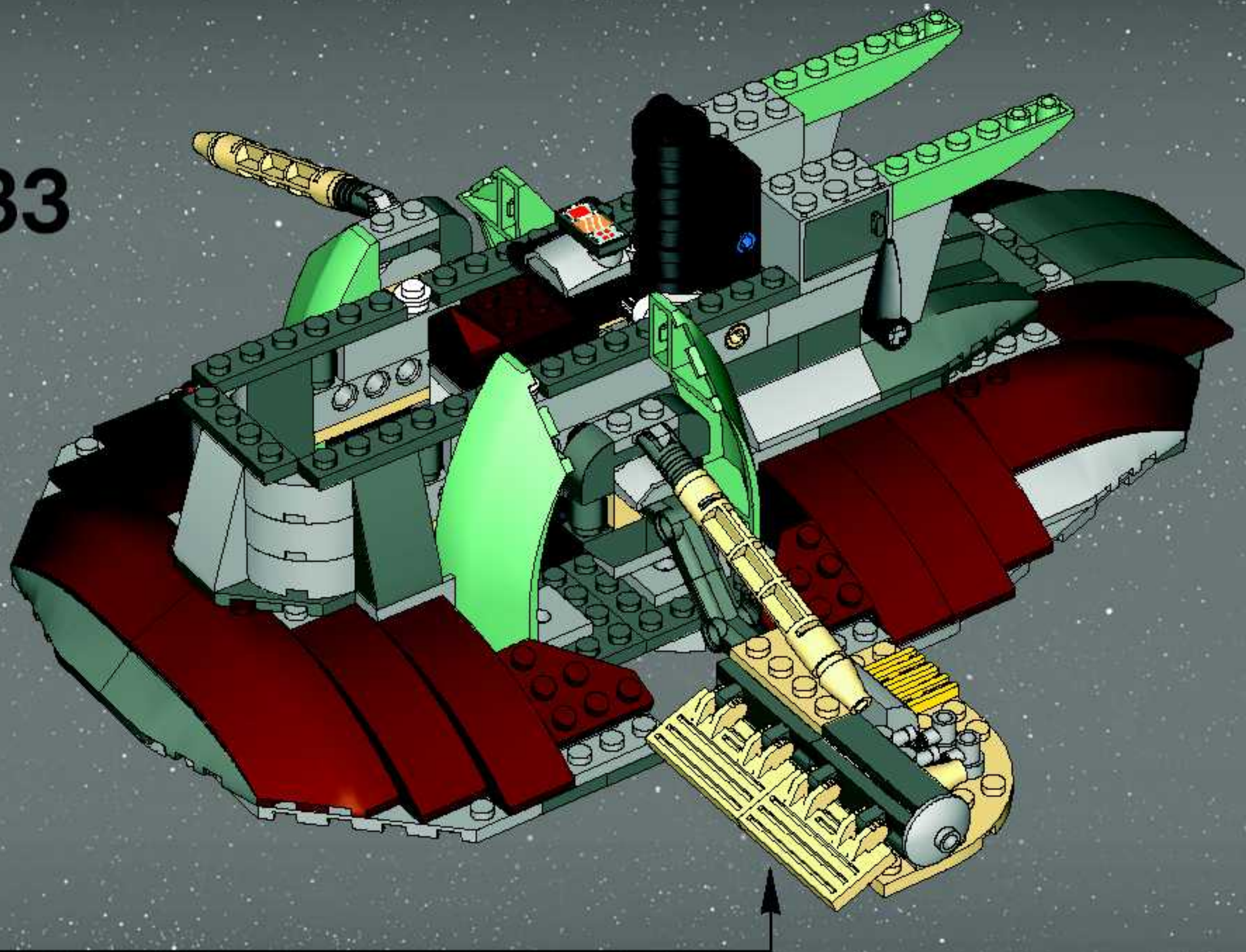

1

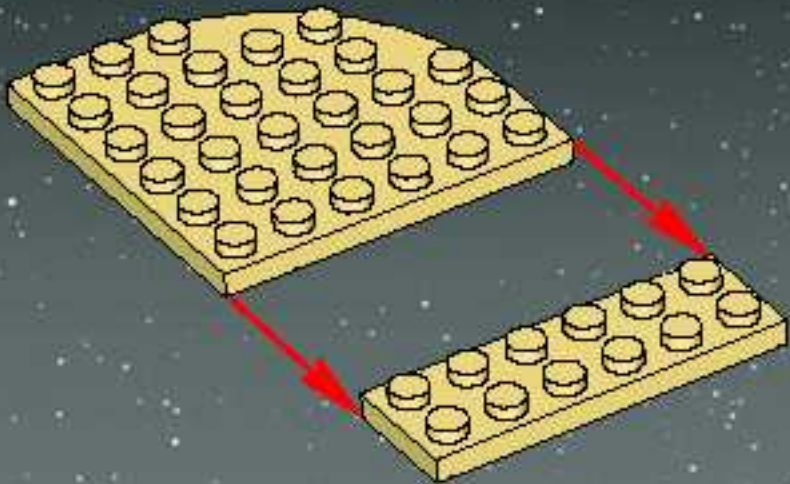

2

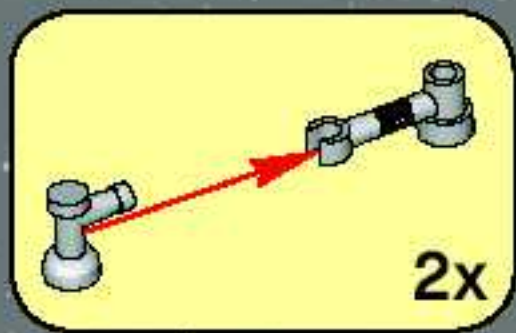

3

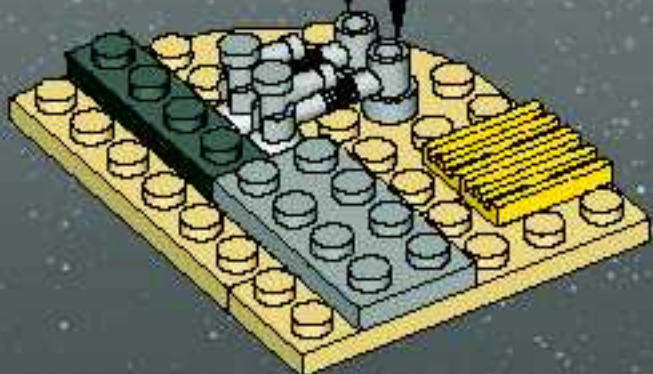

1

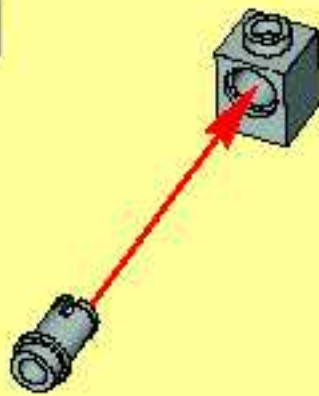

2



4

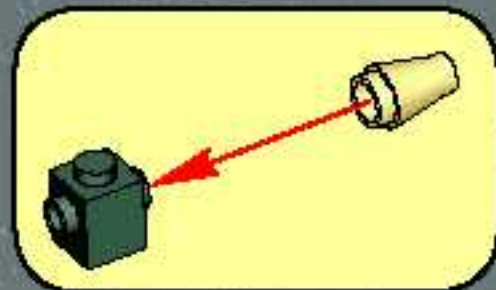
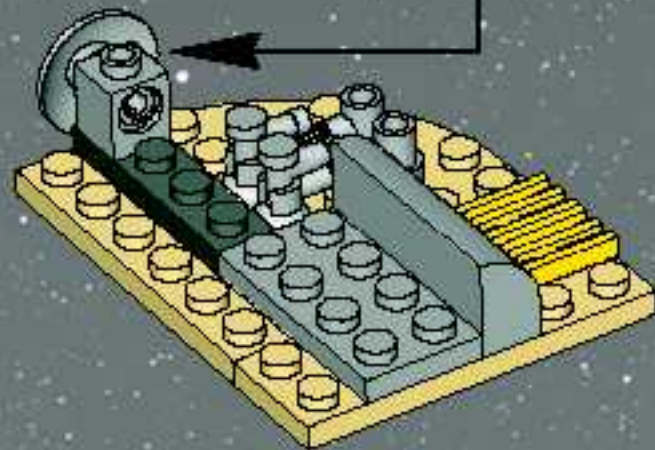

5



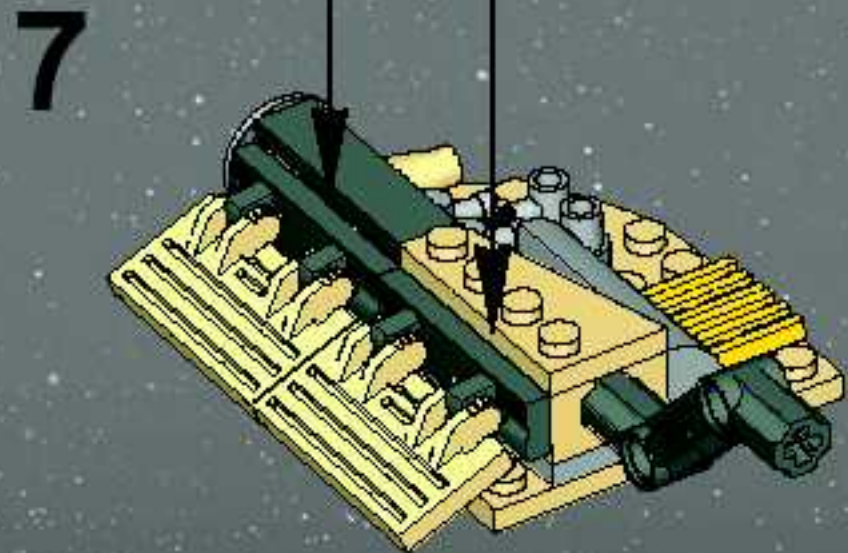
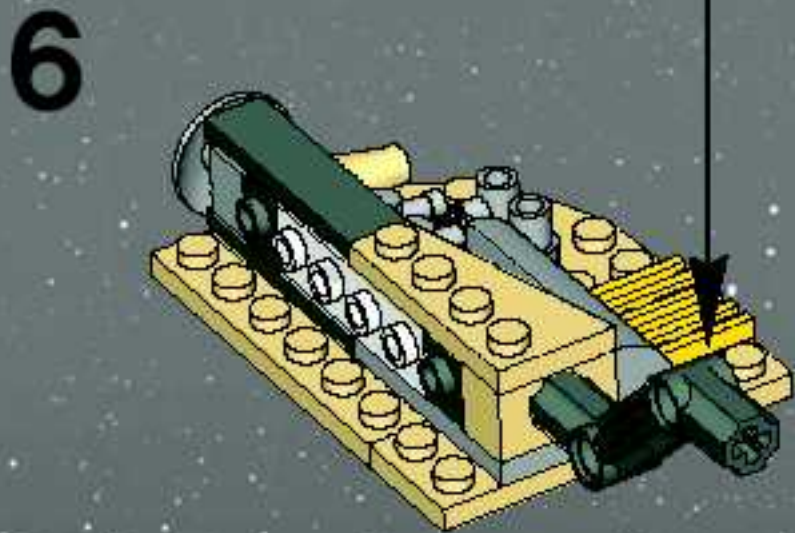
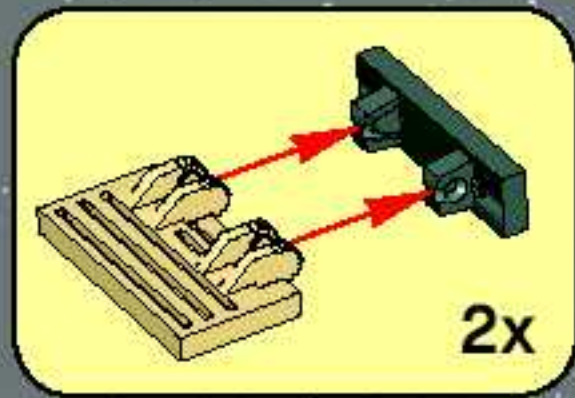
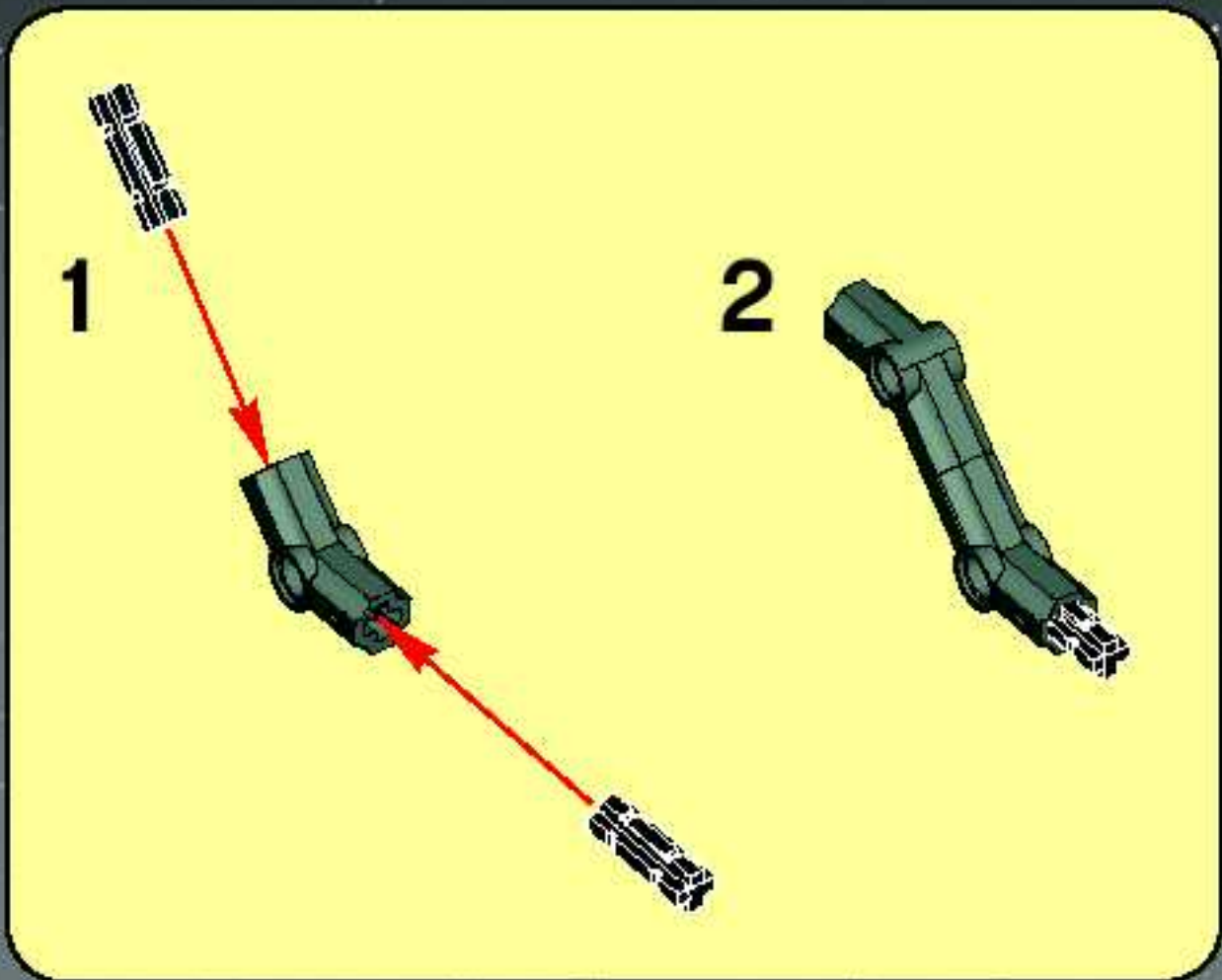

34

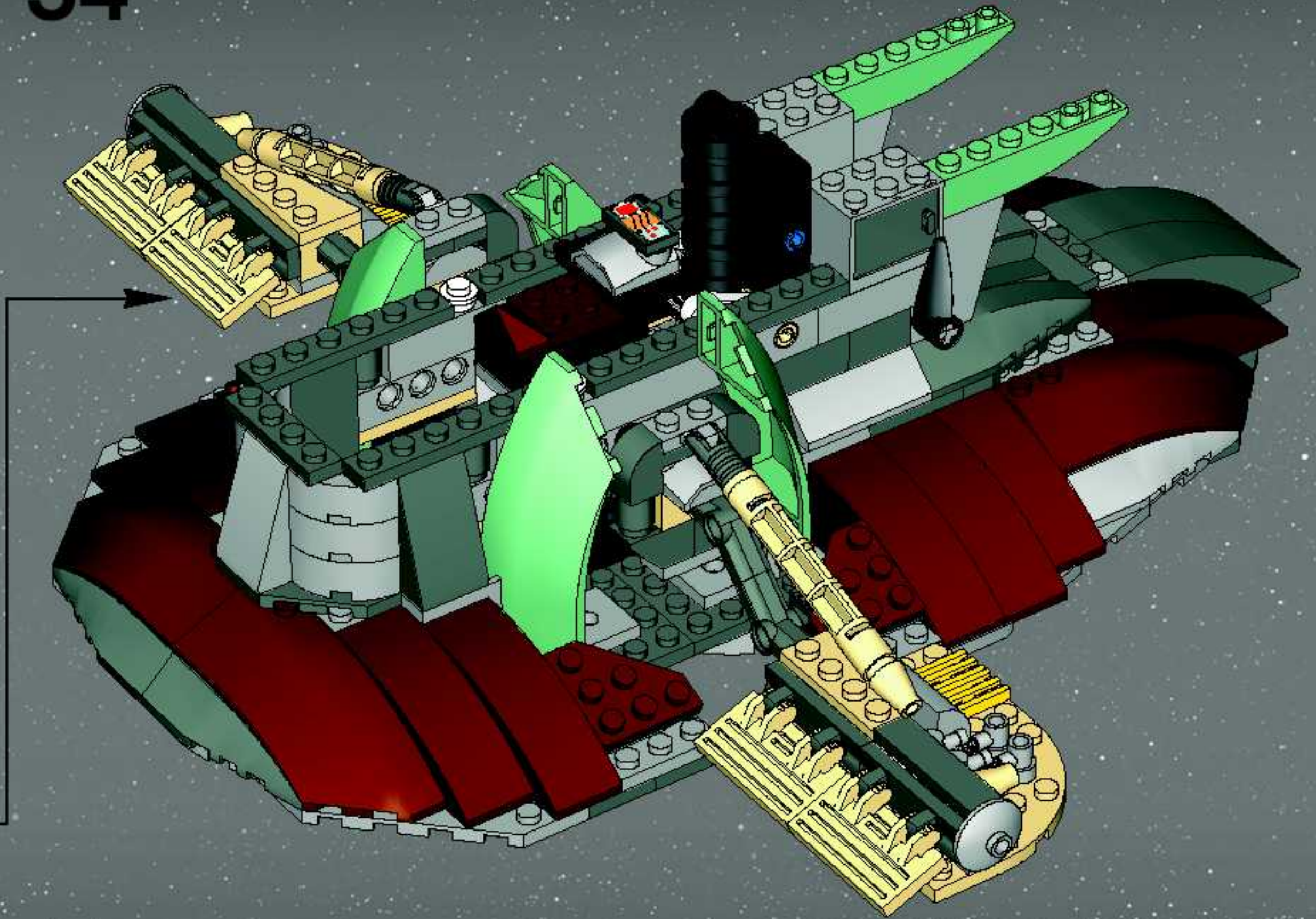

35

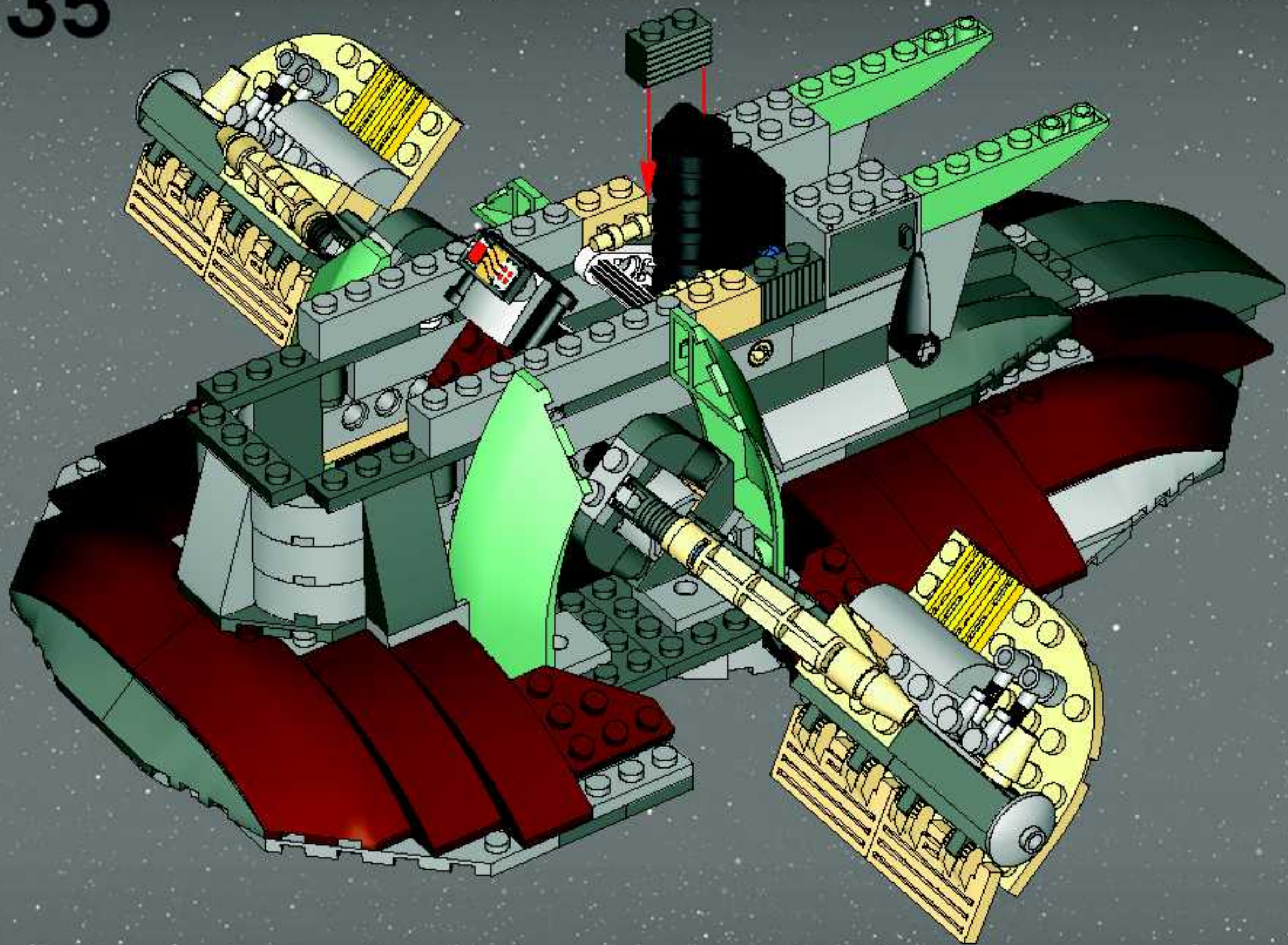

36

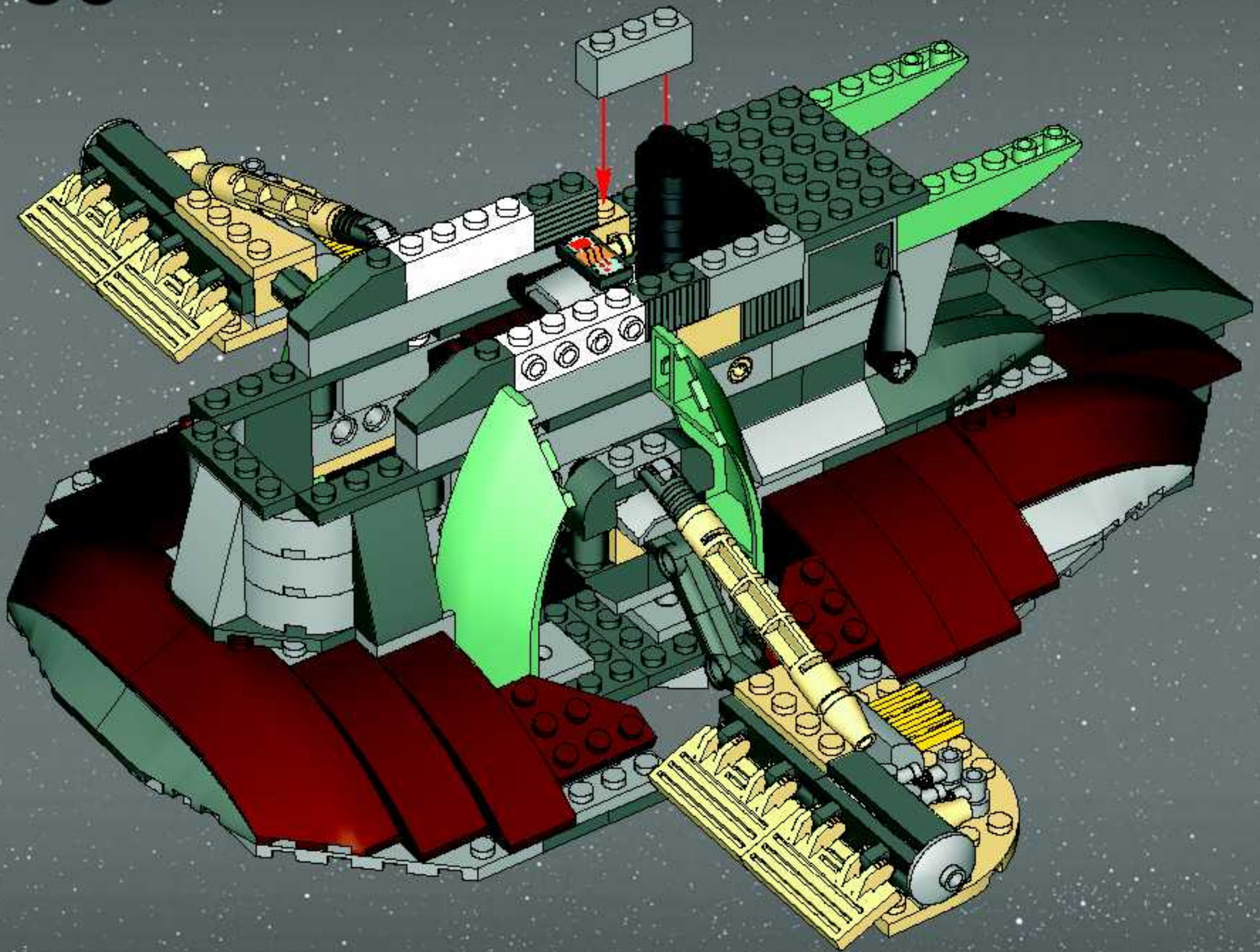



37

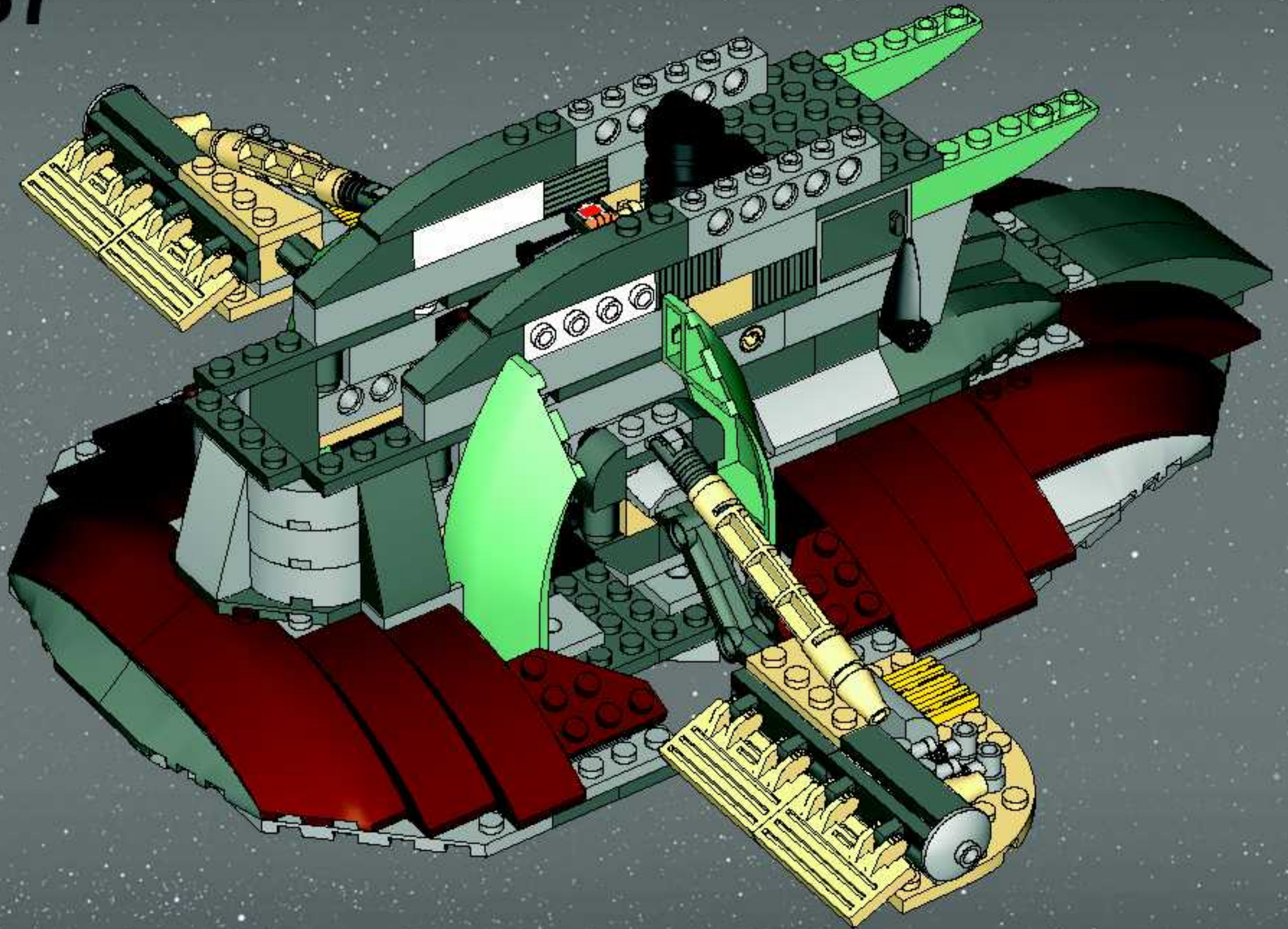

38

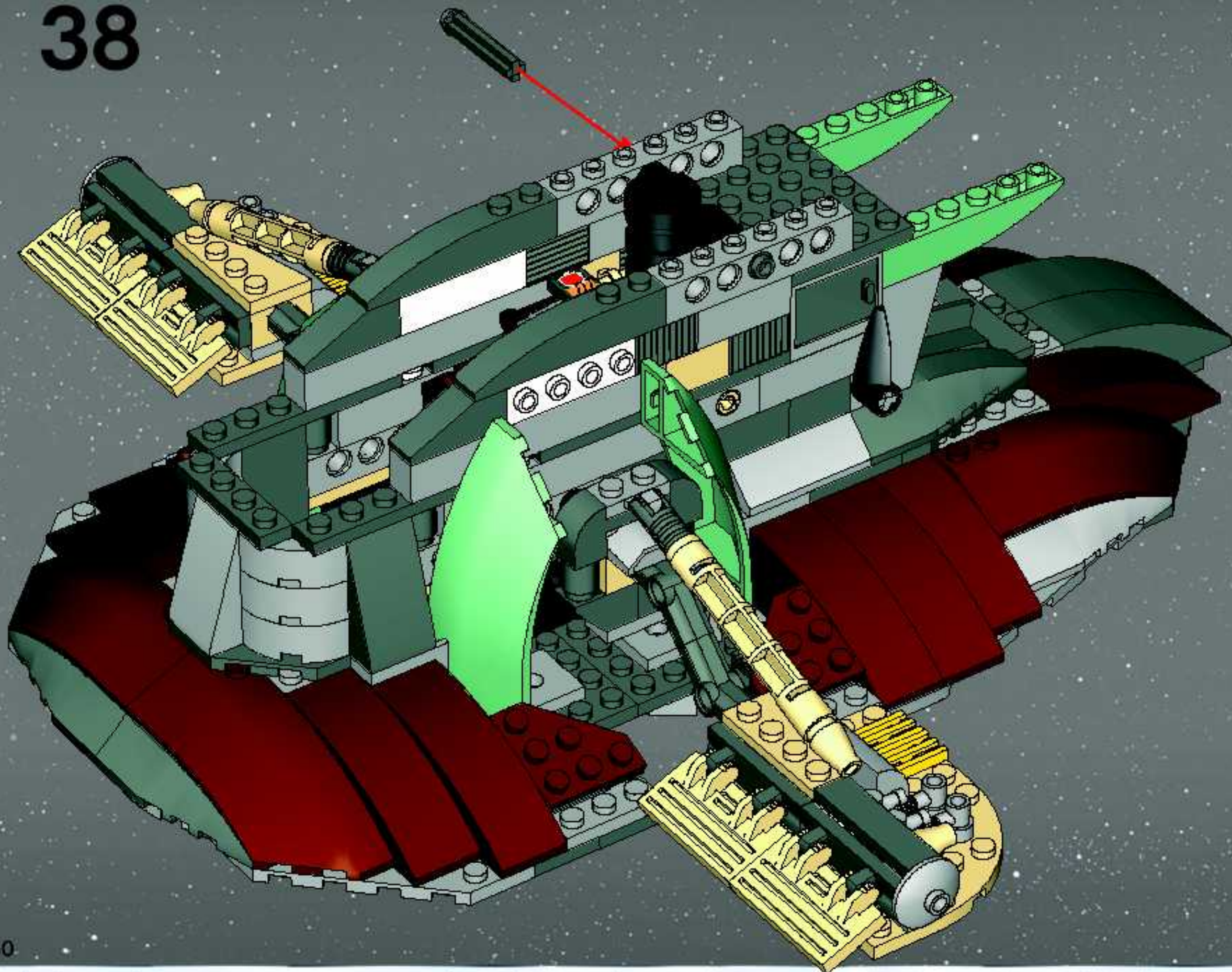

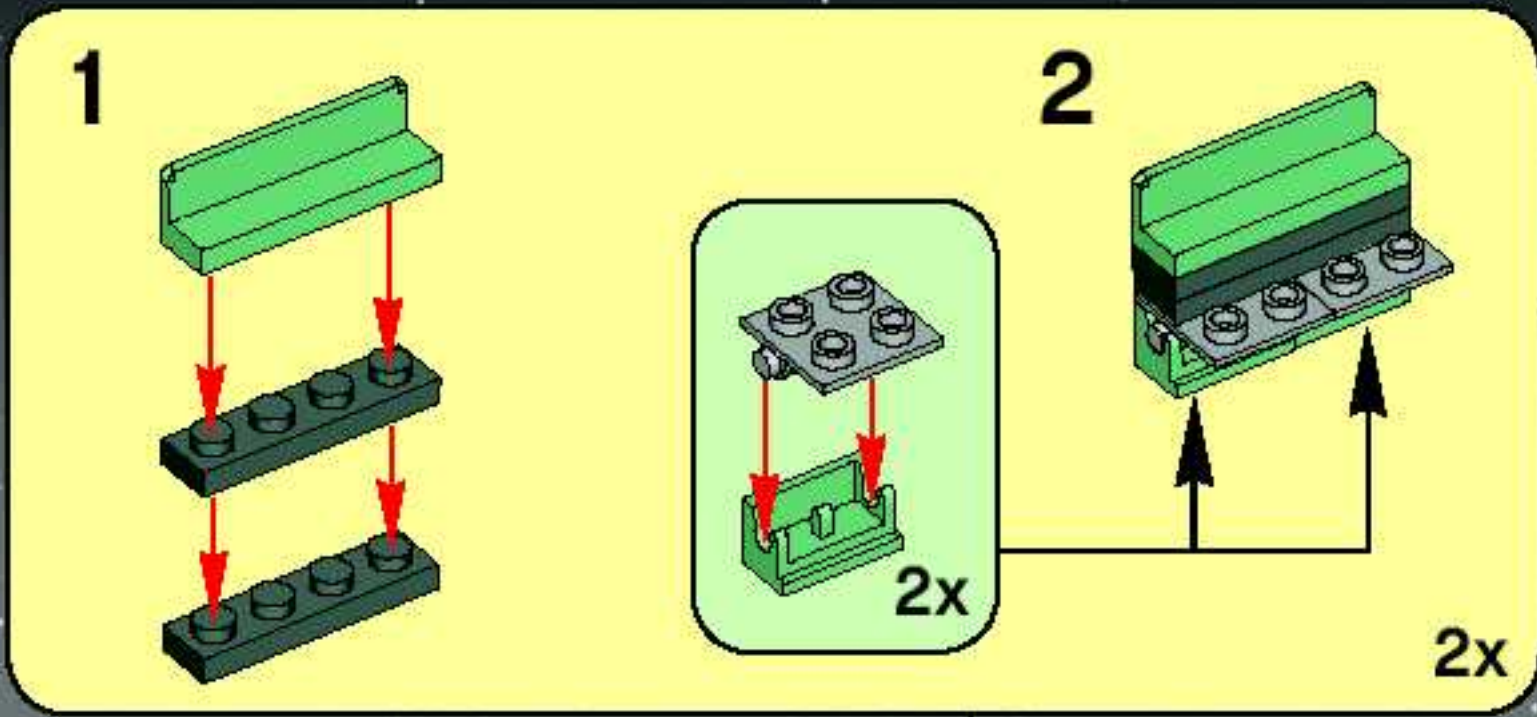

39

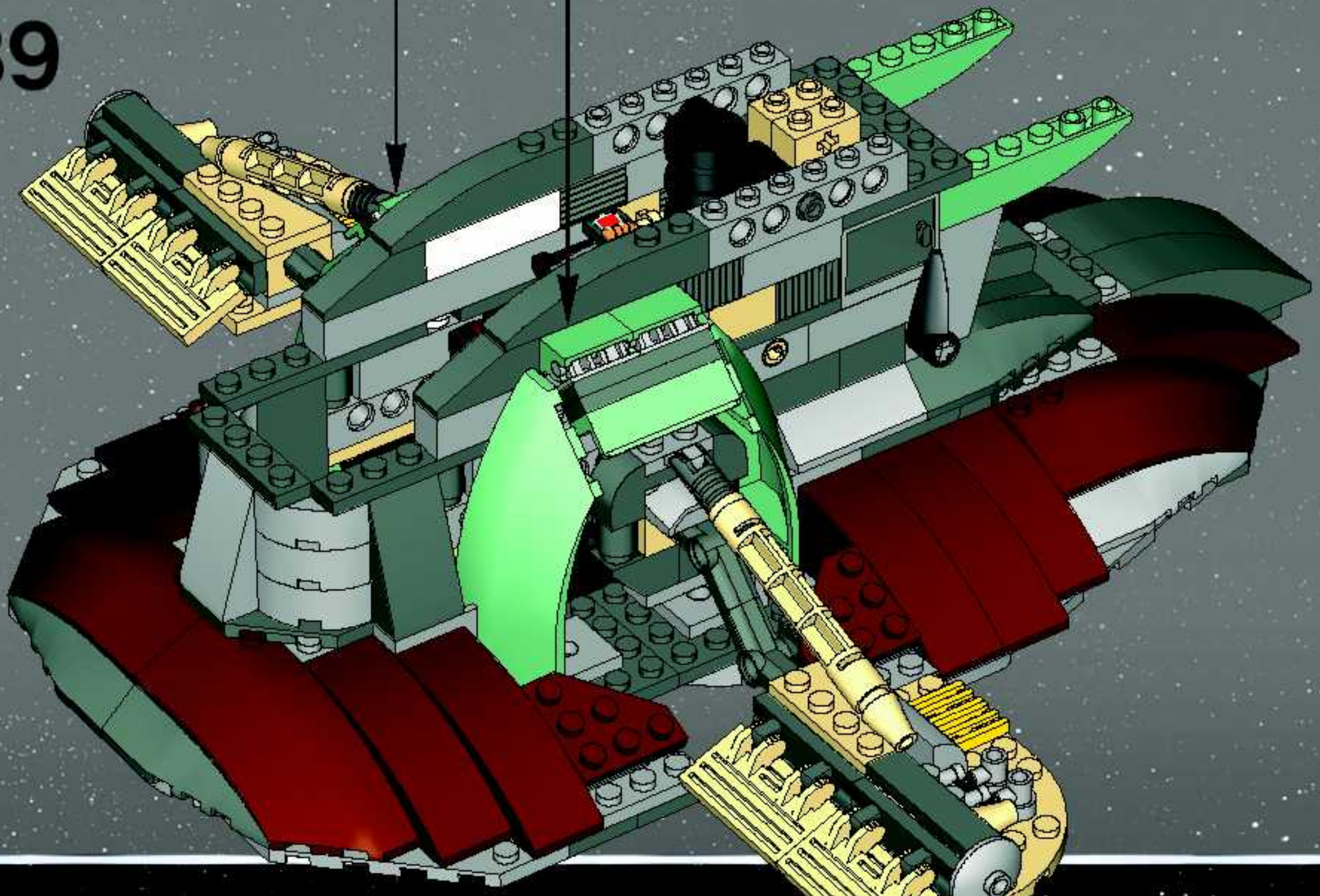

40

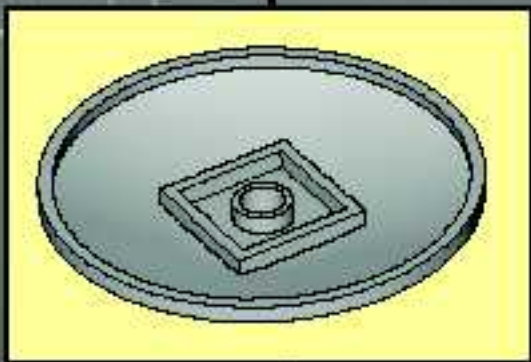
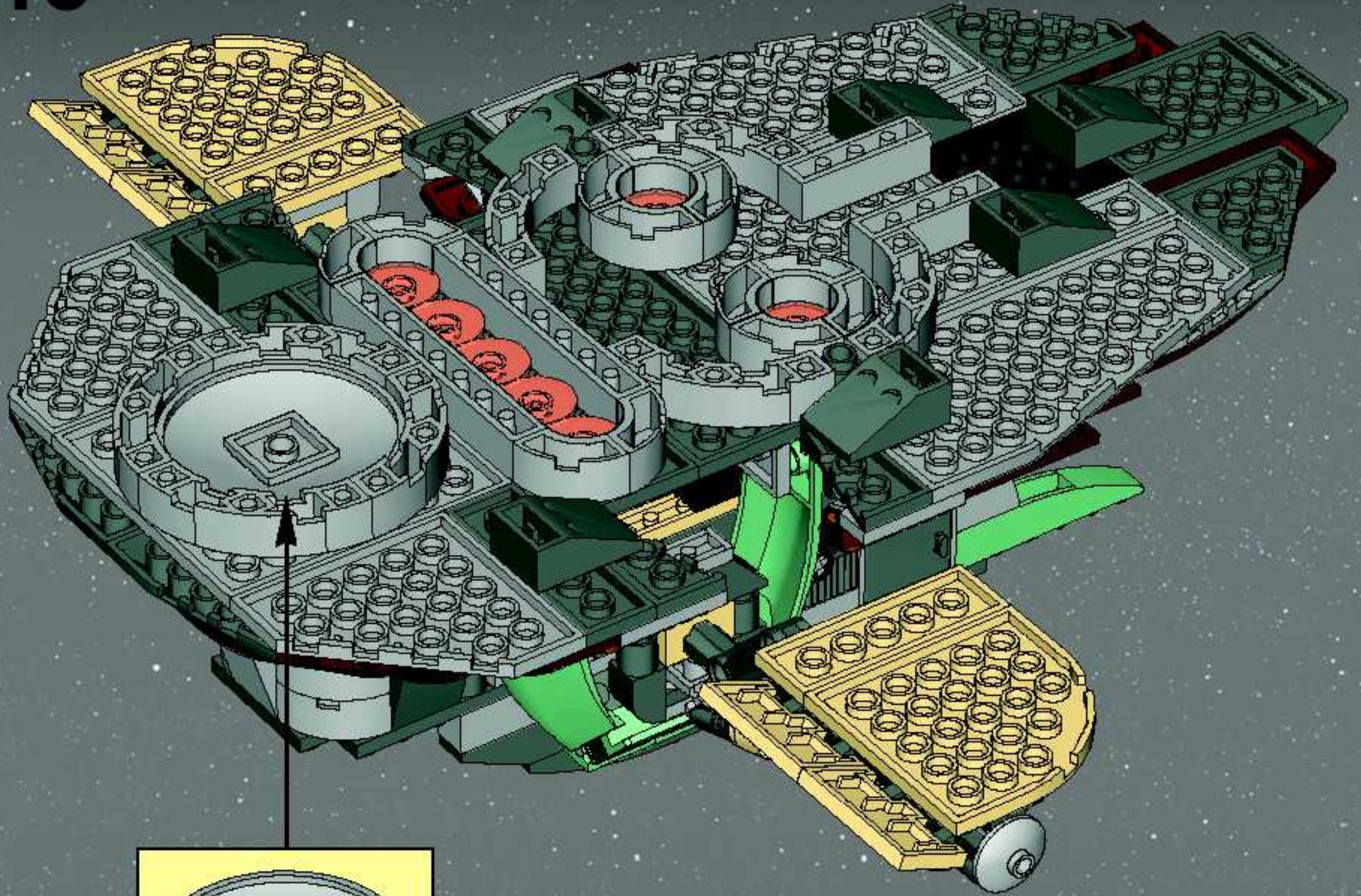

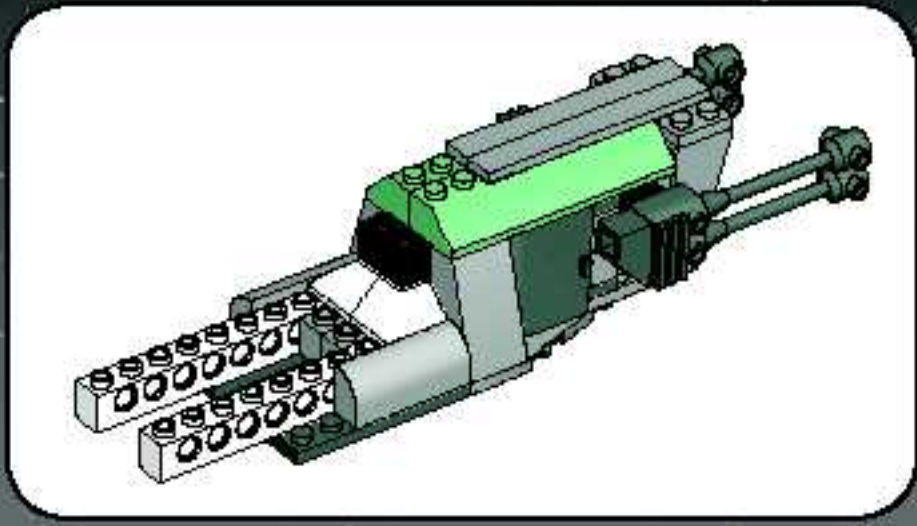

1

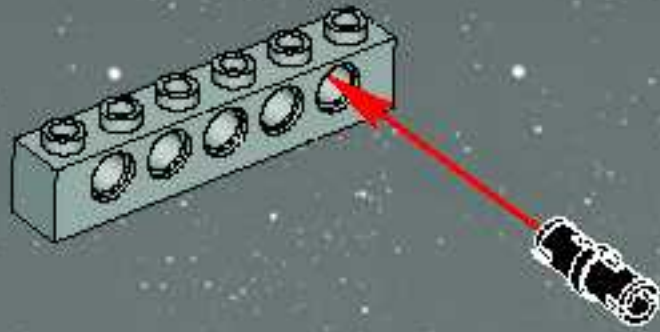

2

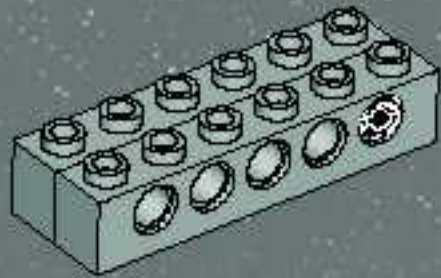

3

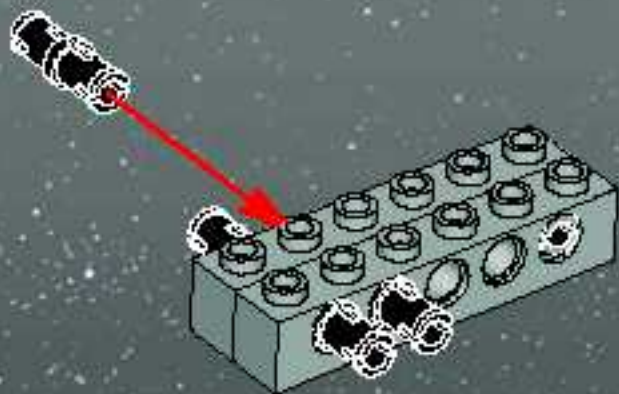

4

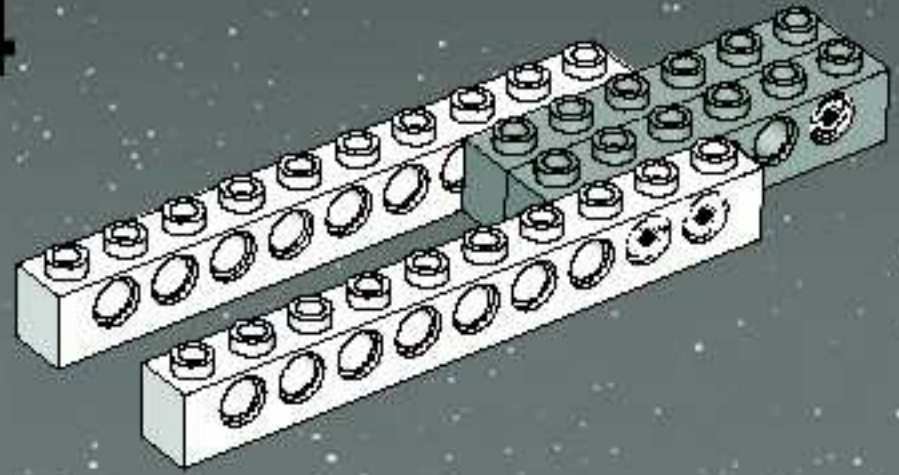

5

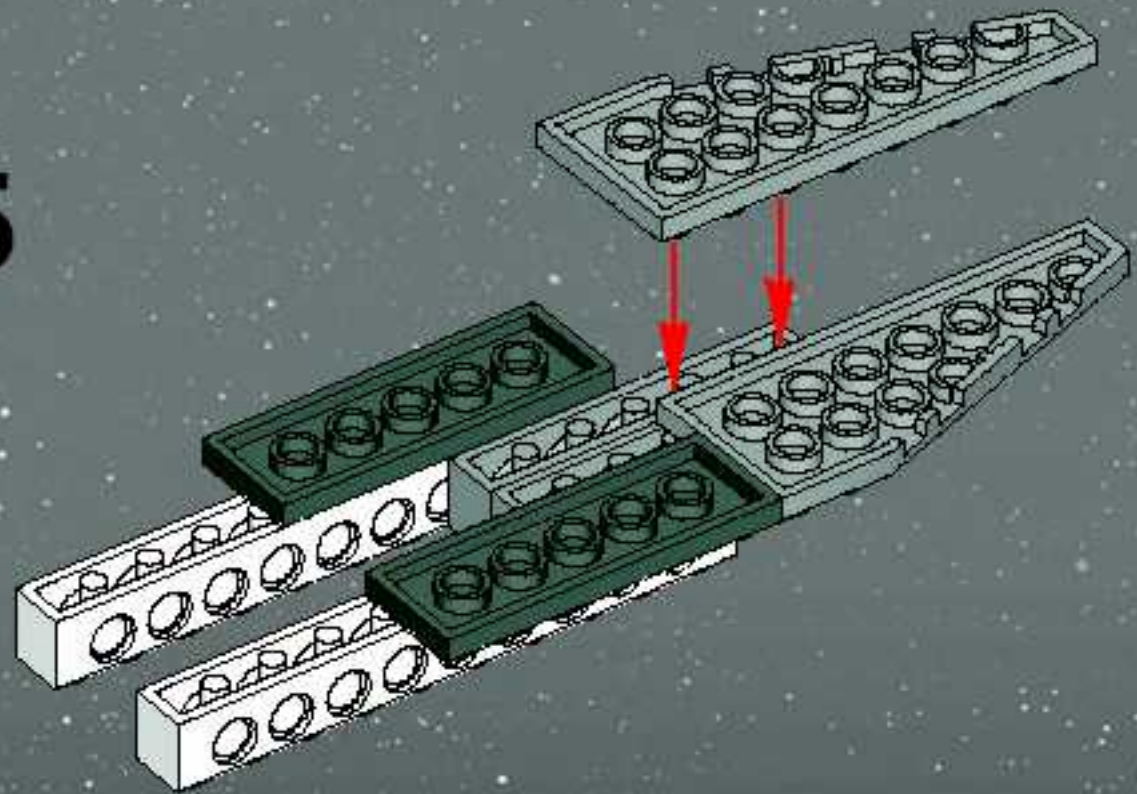

6

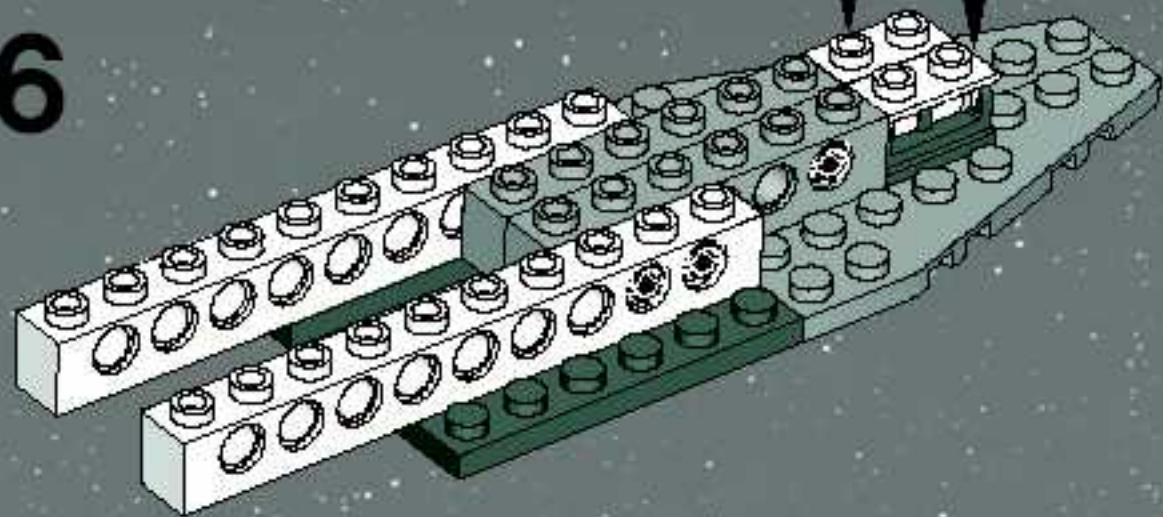

8

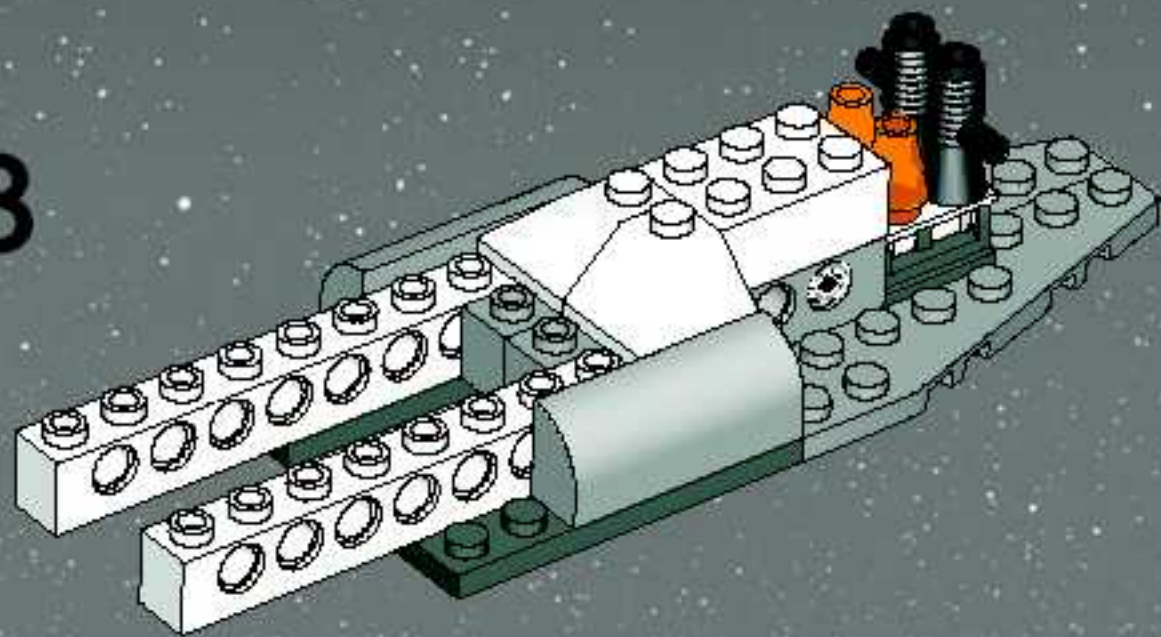

7

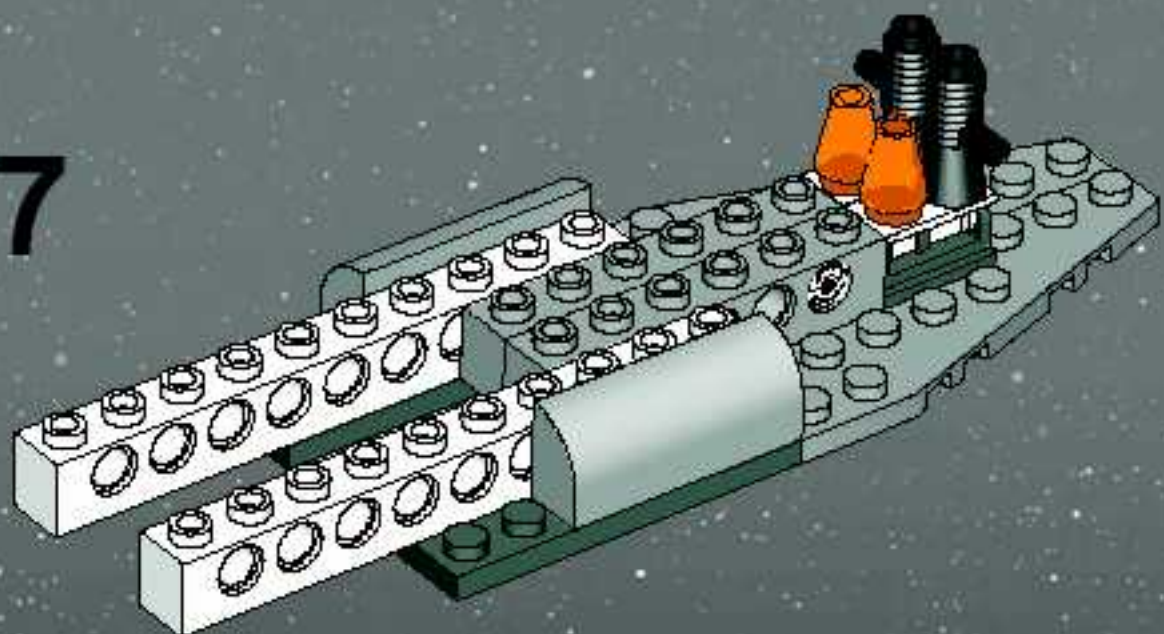

9

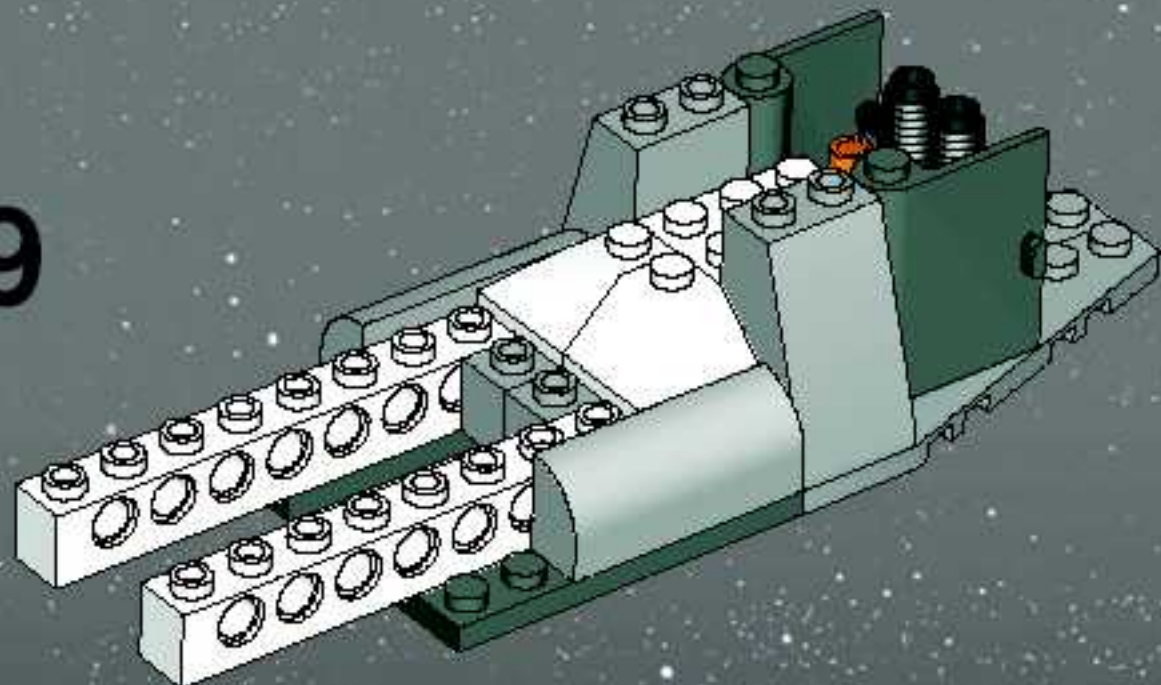

1

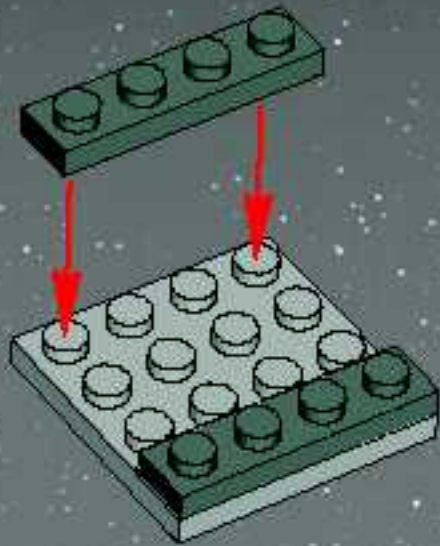

2

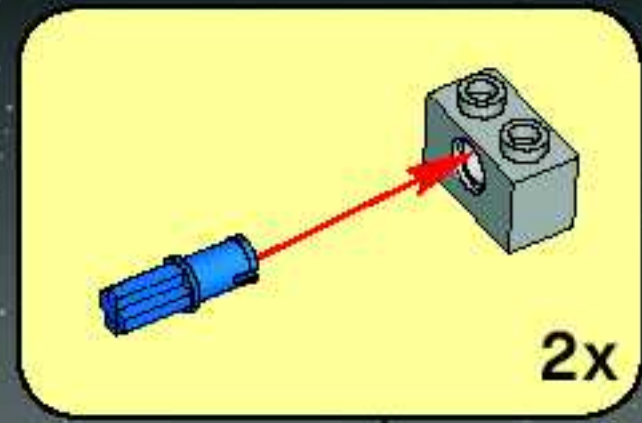
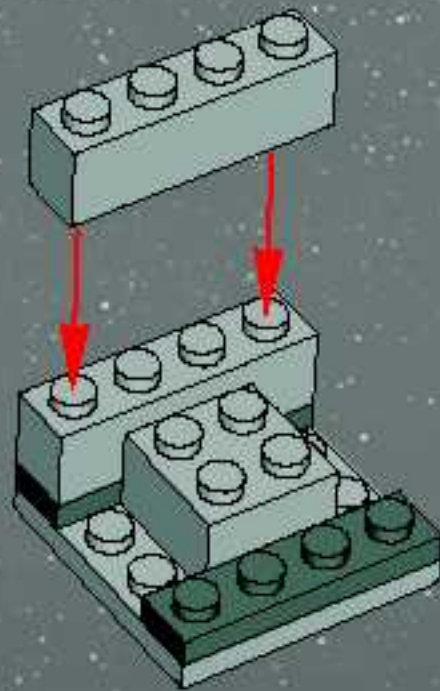

3

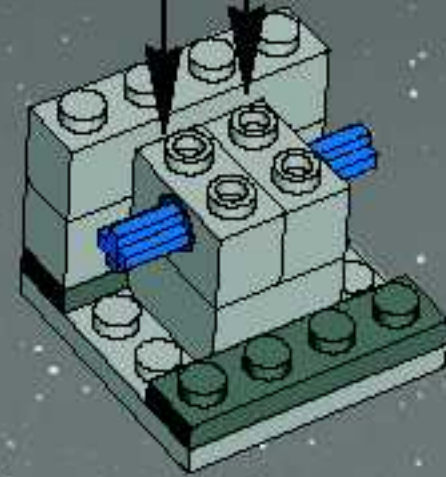

4

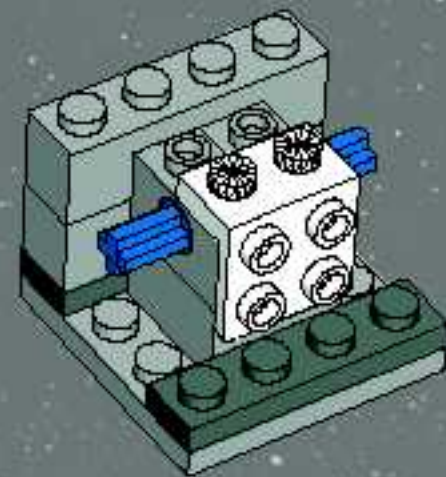

5

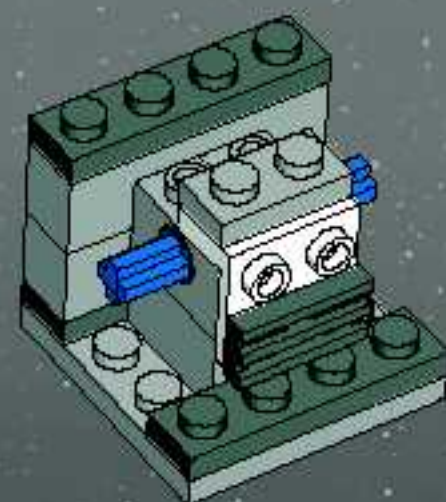





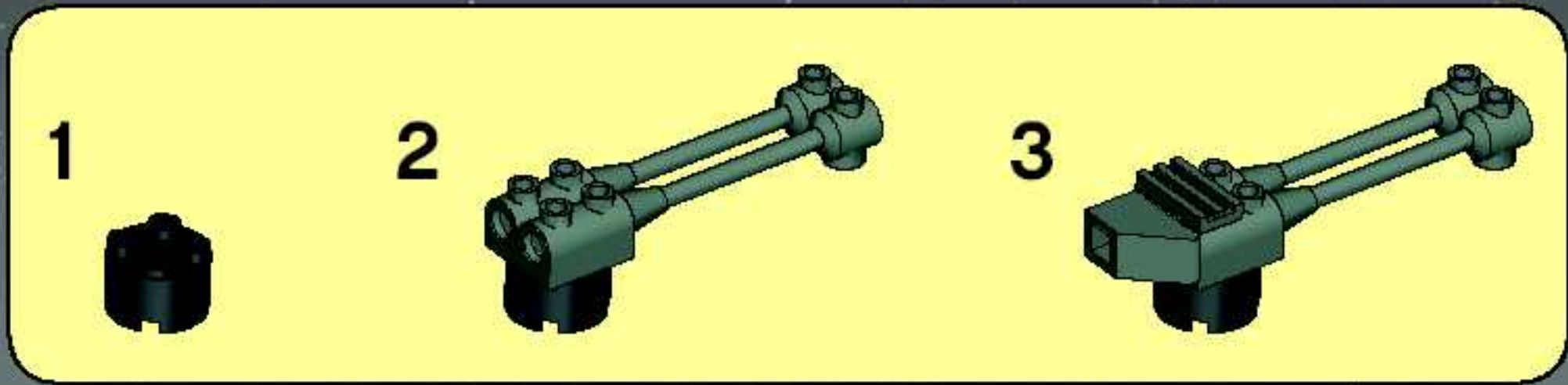

12

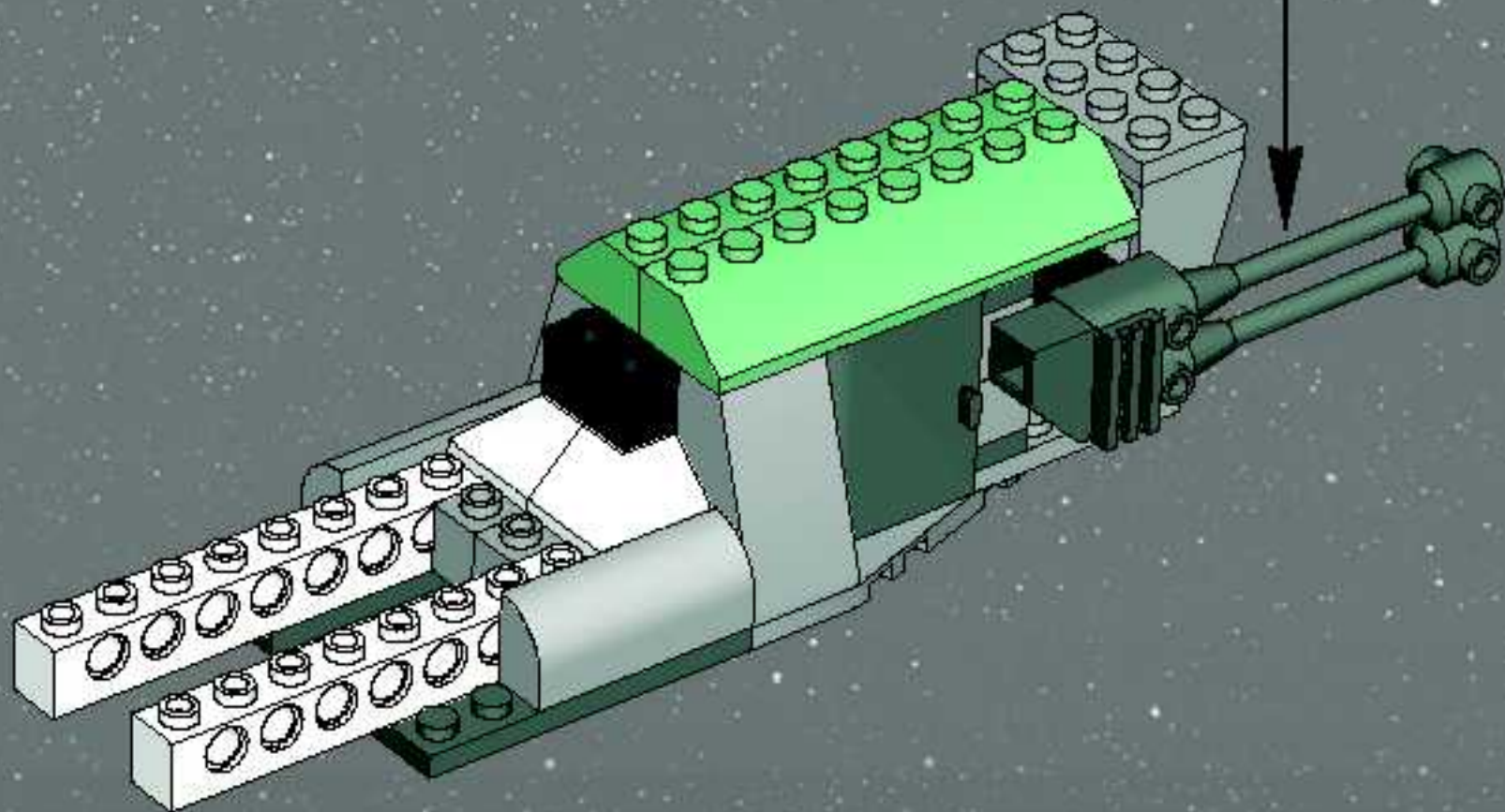

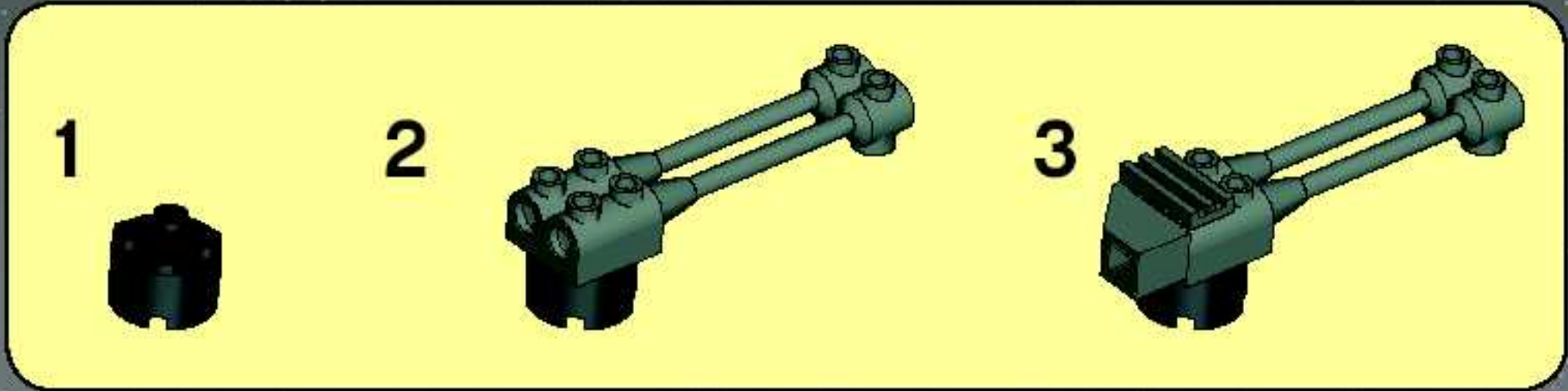

13

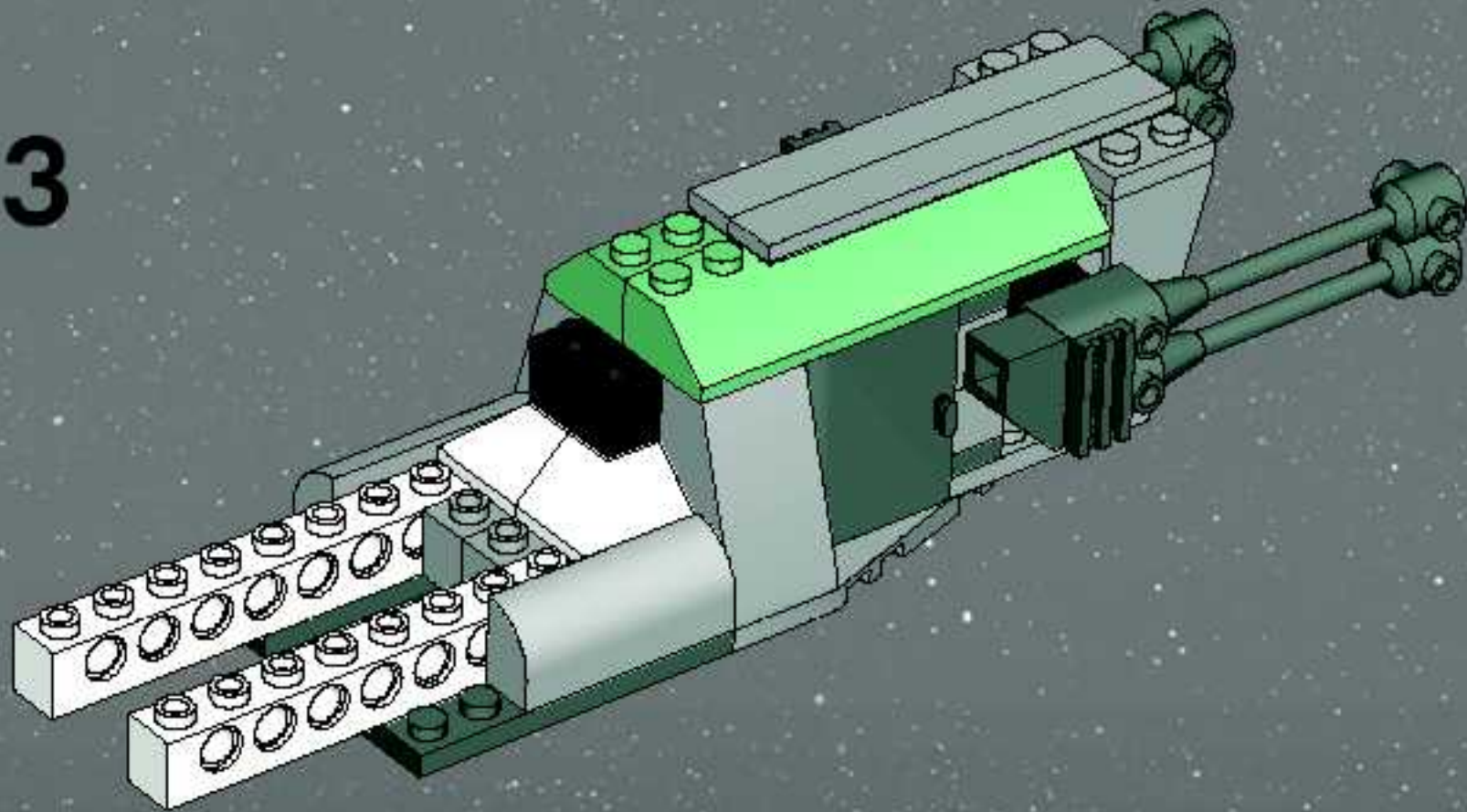

41

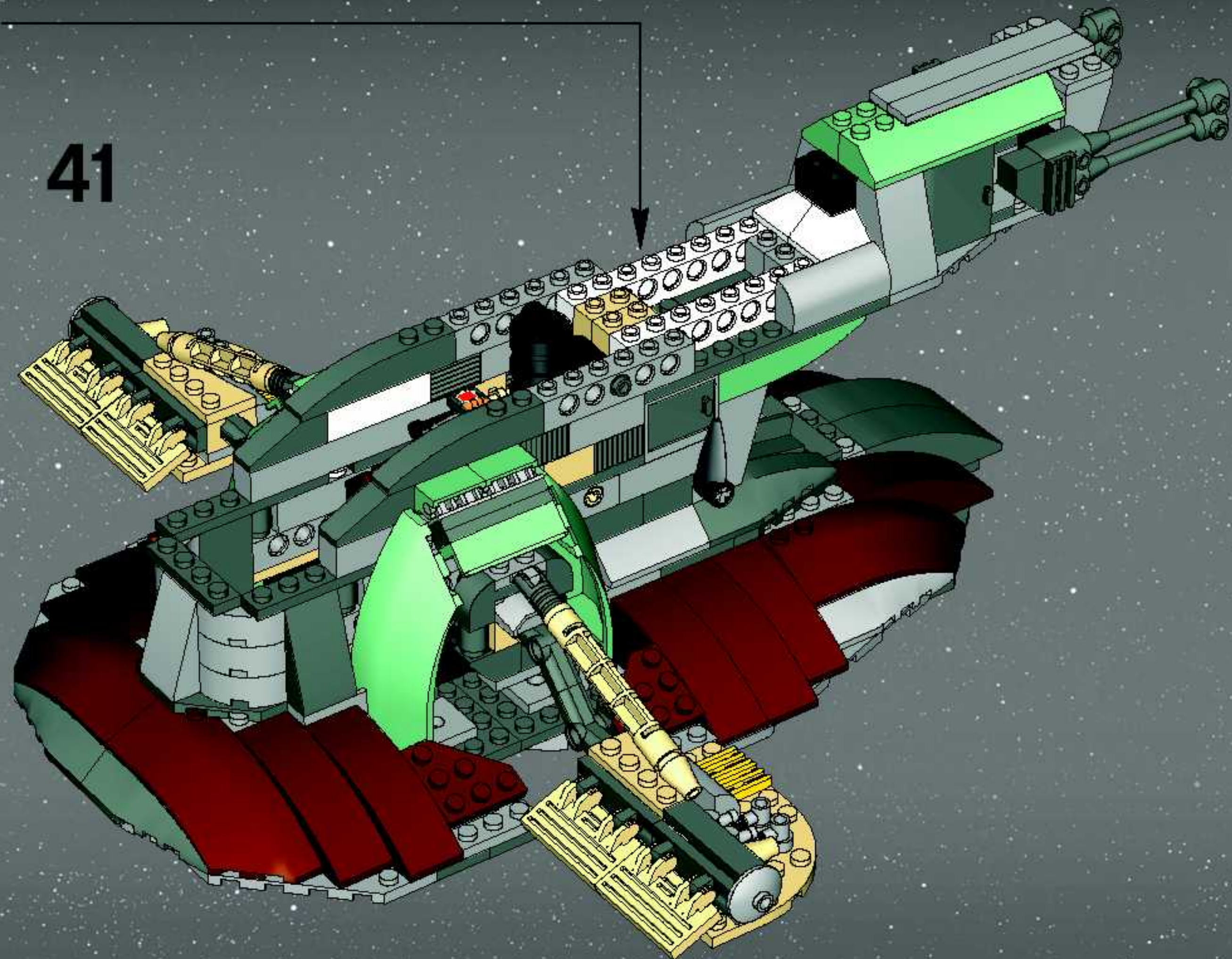

42

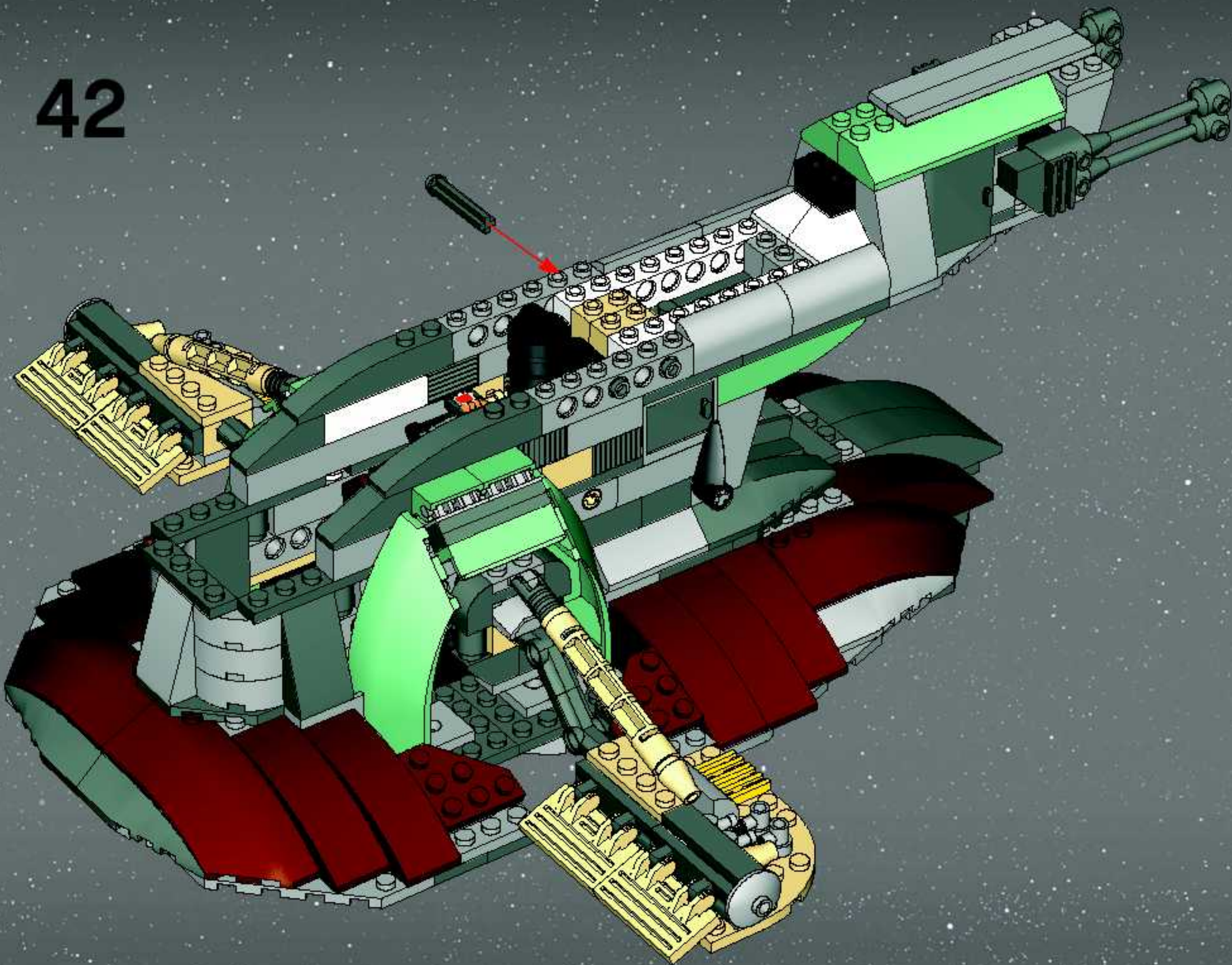

43

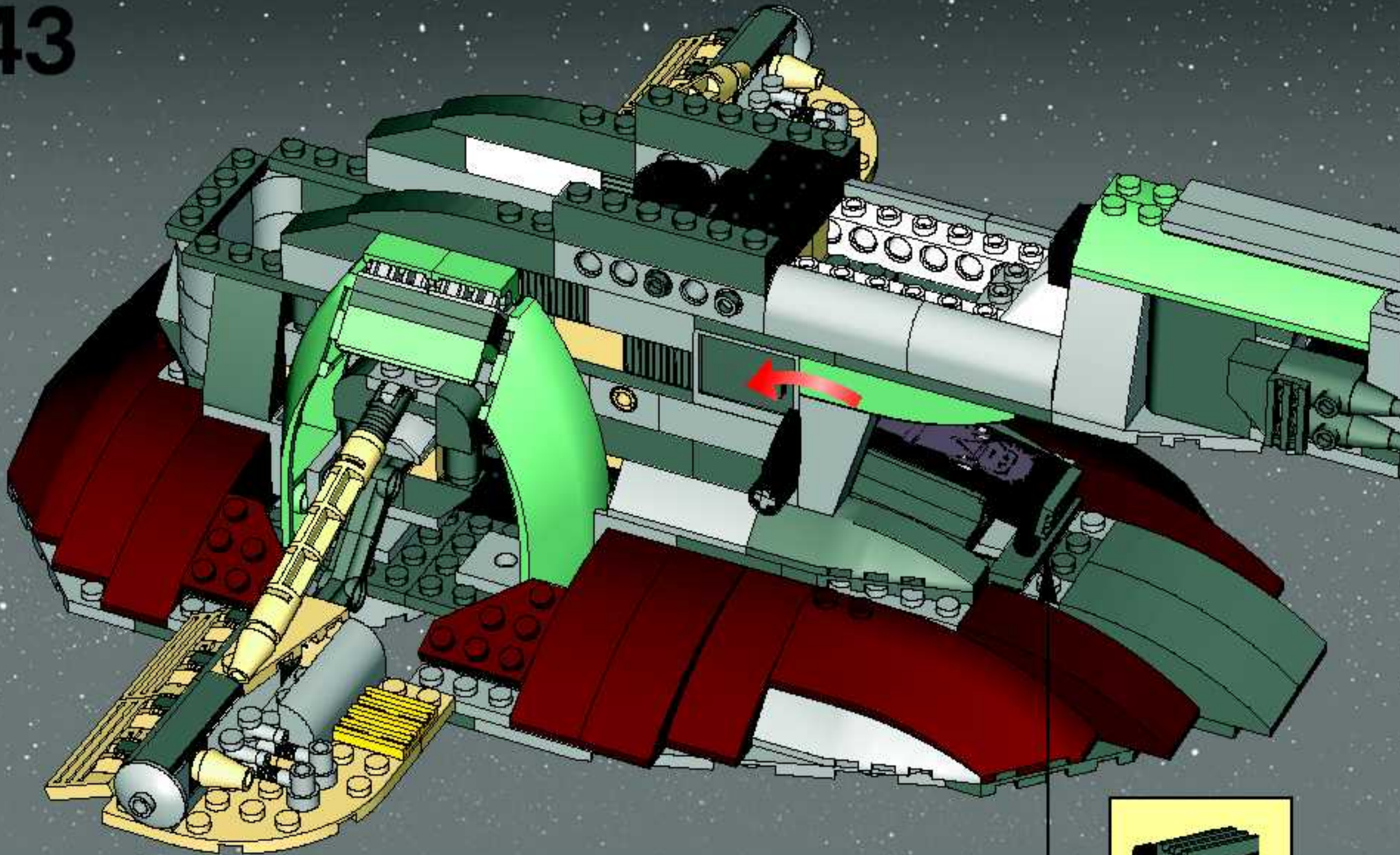

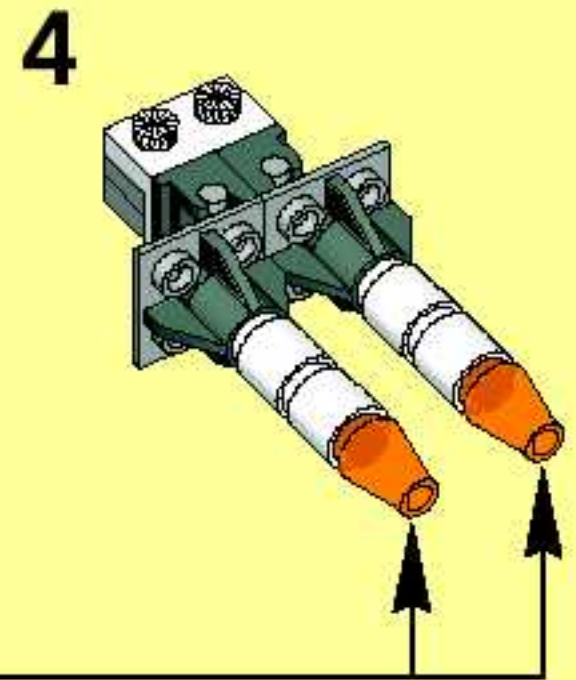
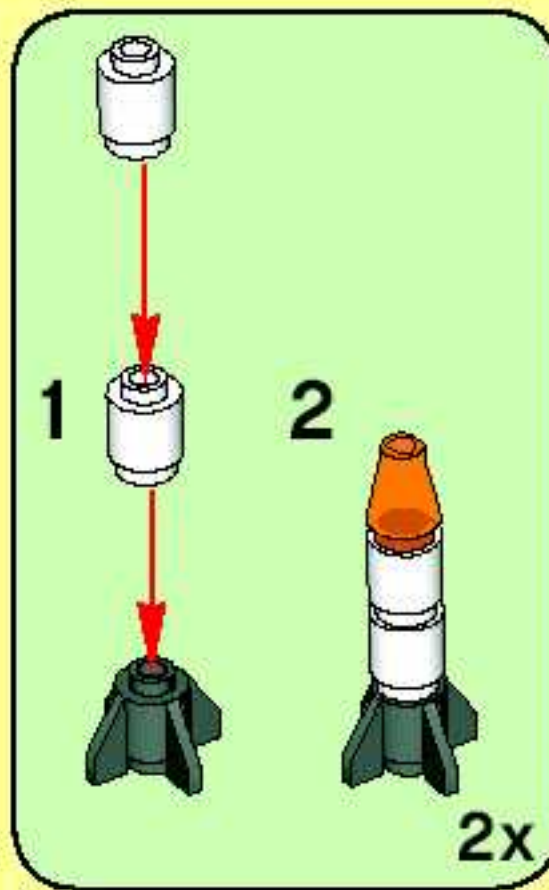
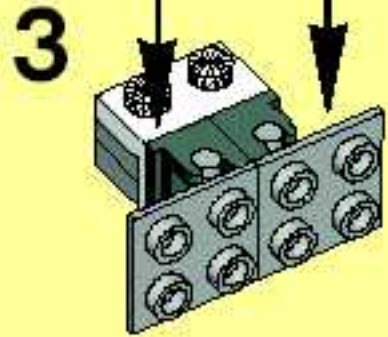
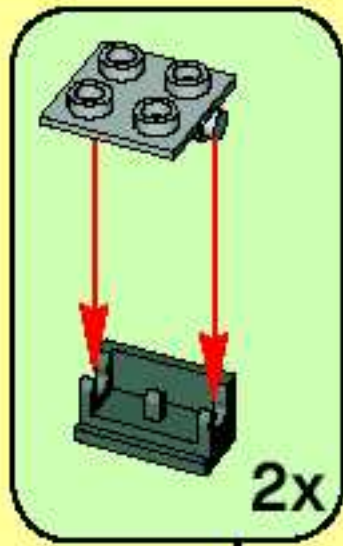
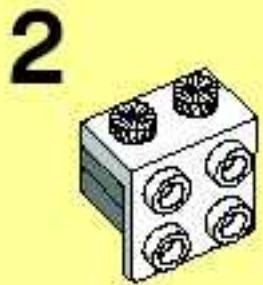
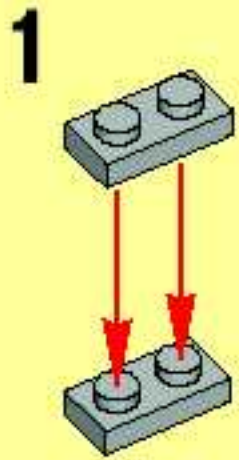

44

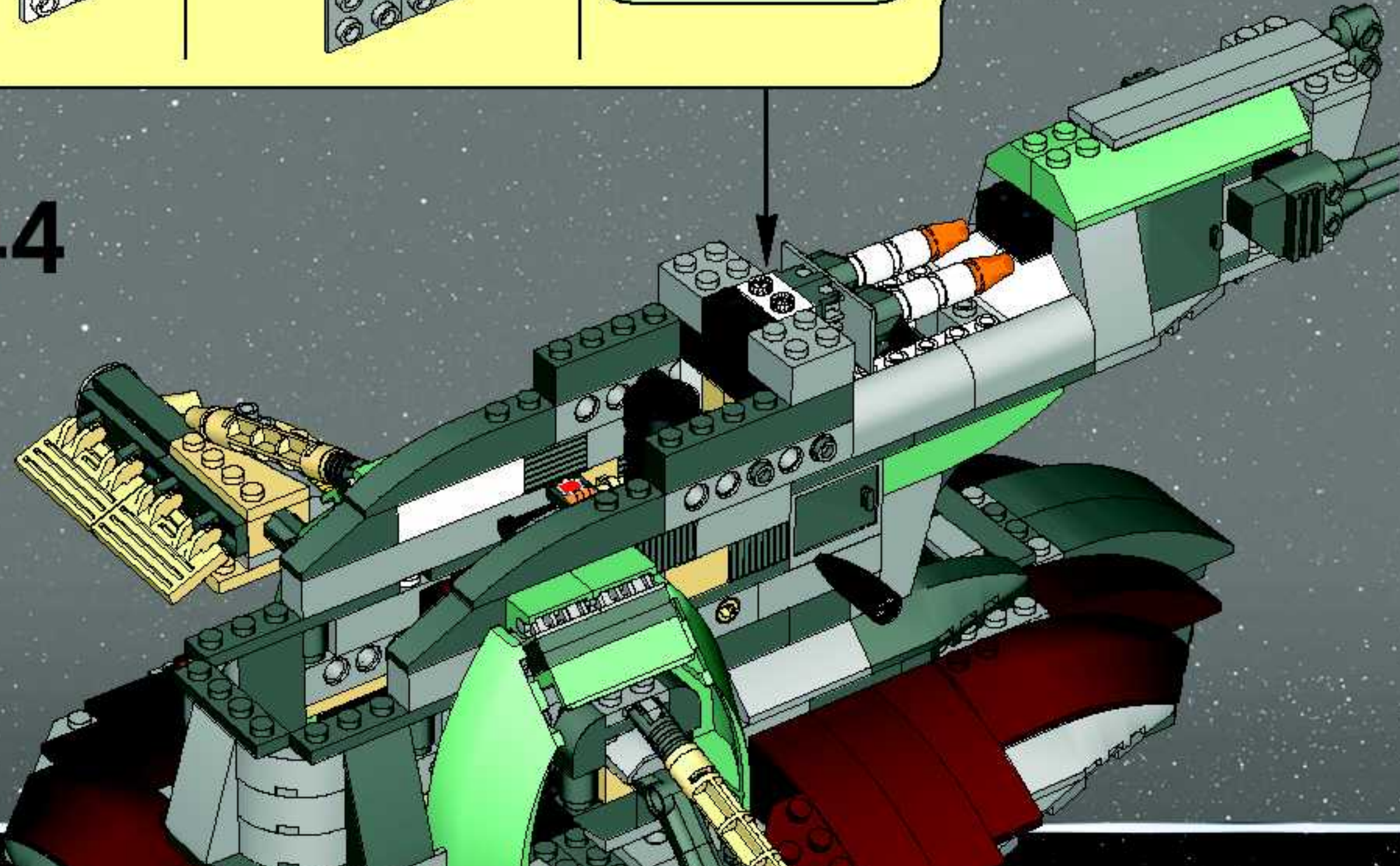

1

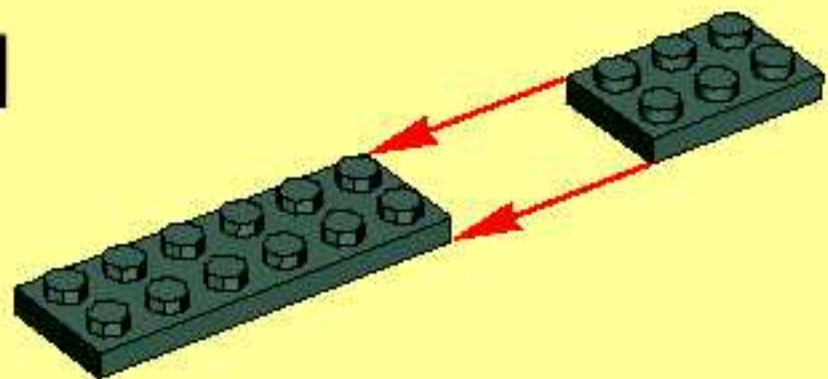

3

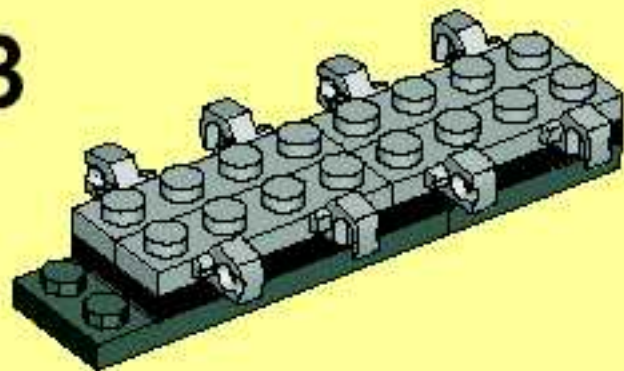

4

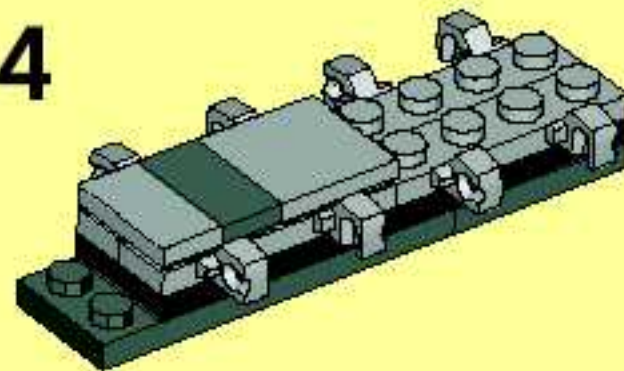

2

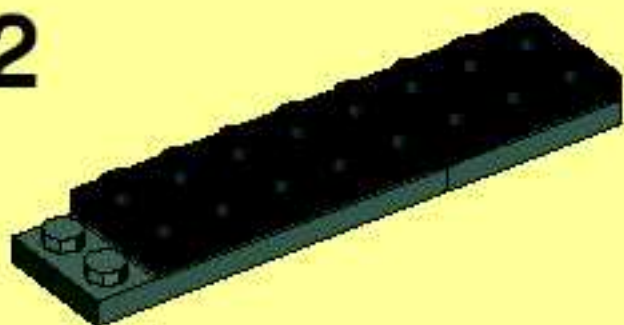

45

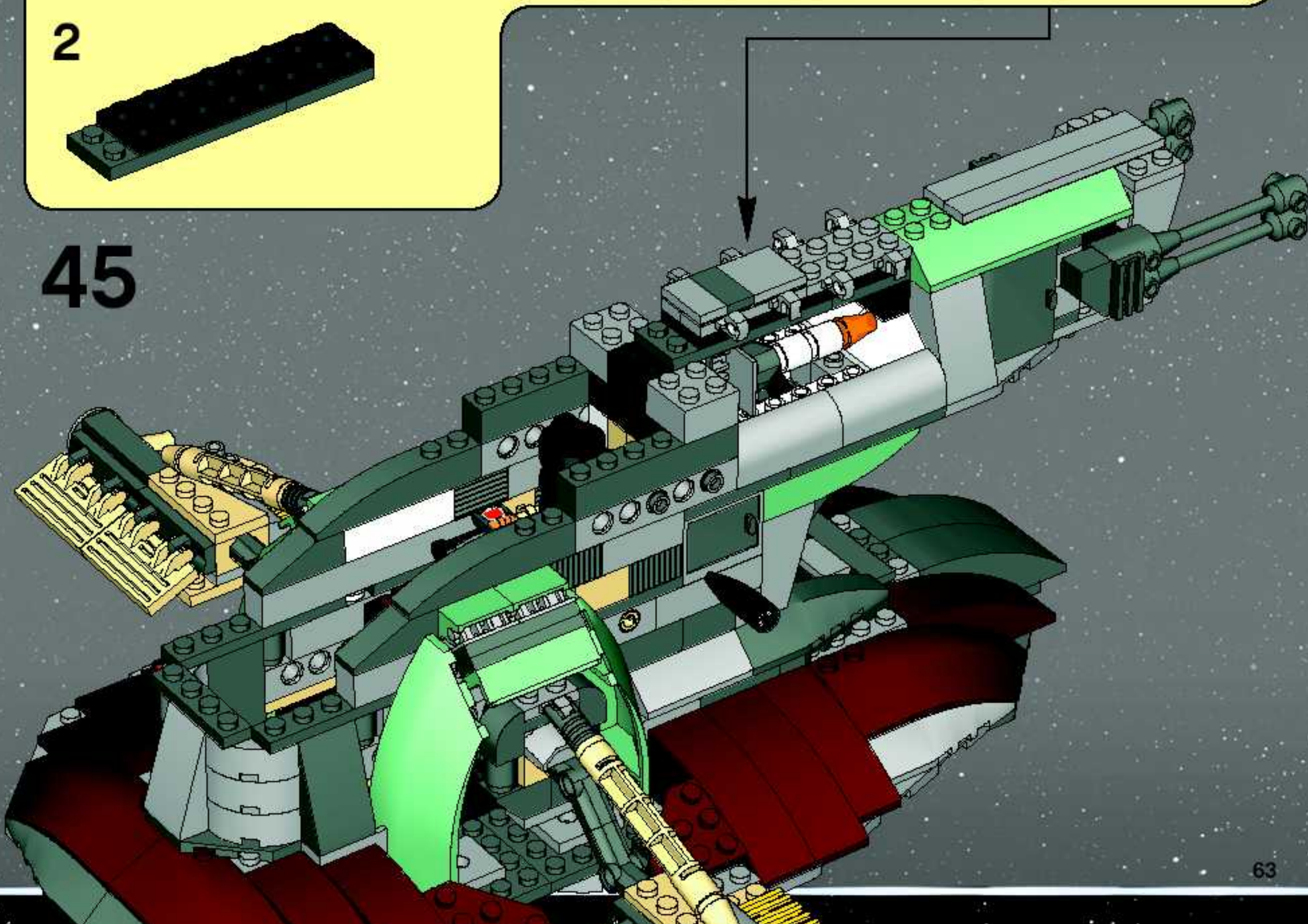

46

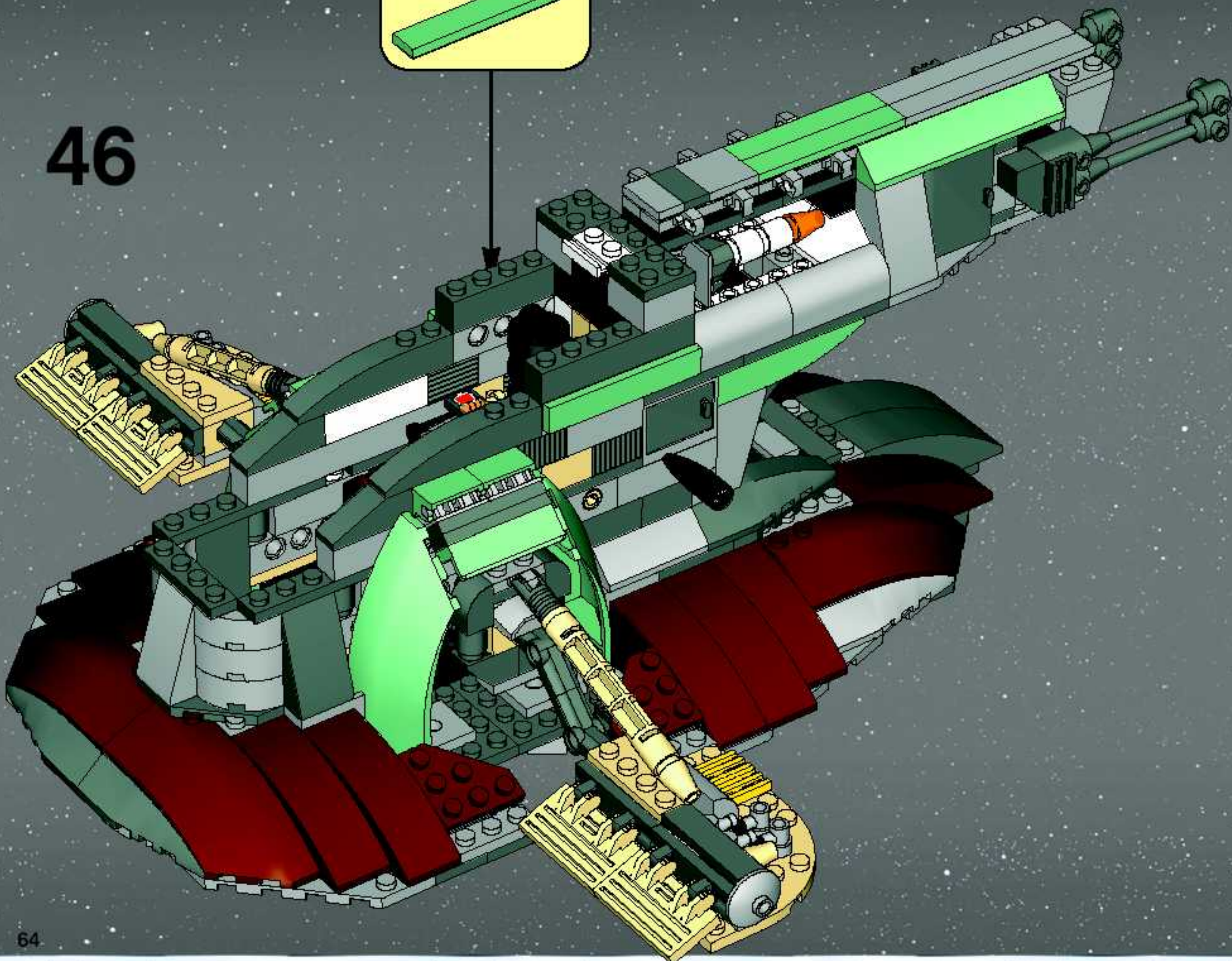
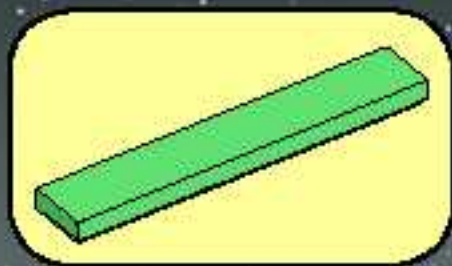



1

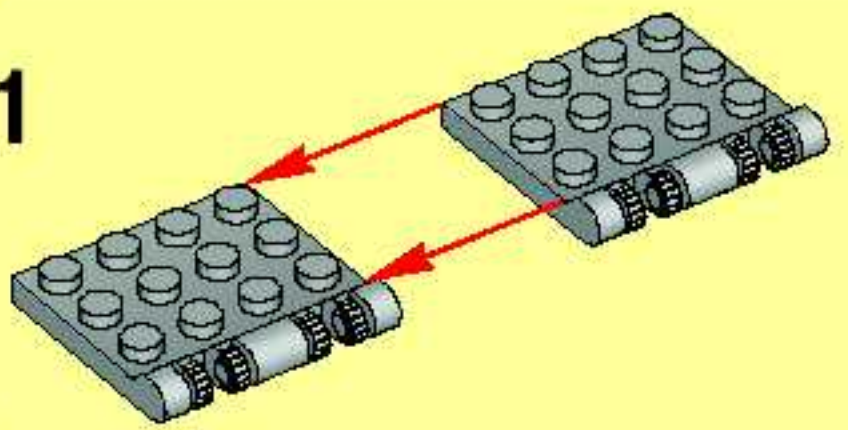

2

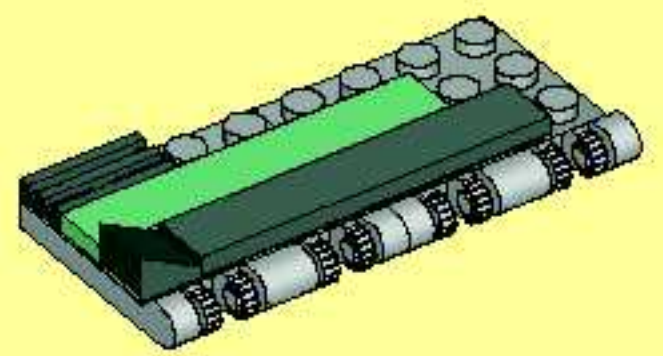

47



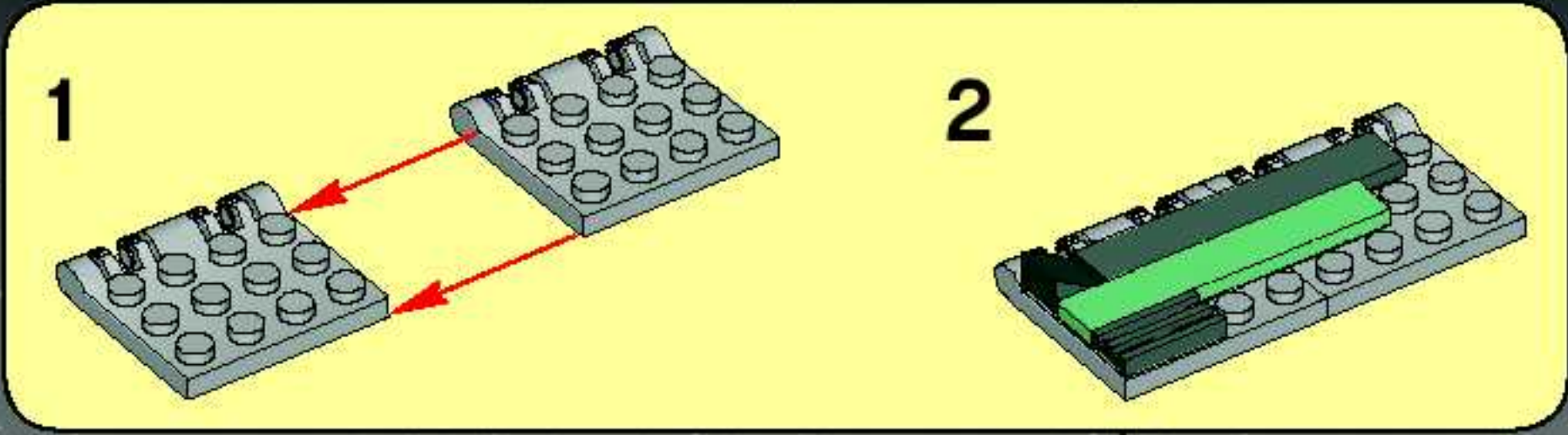

48

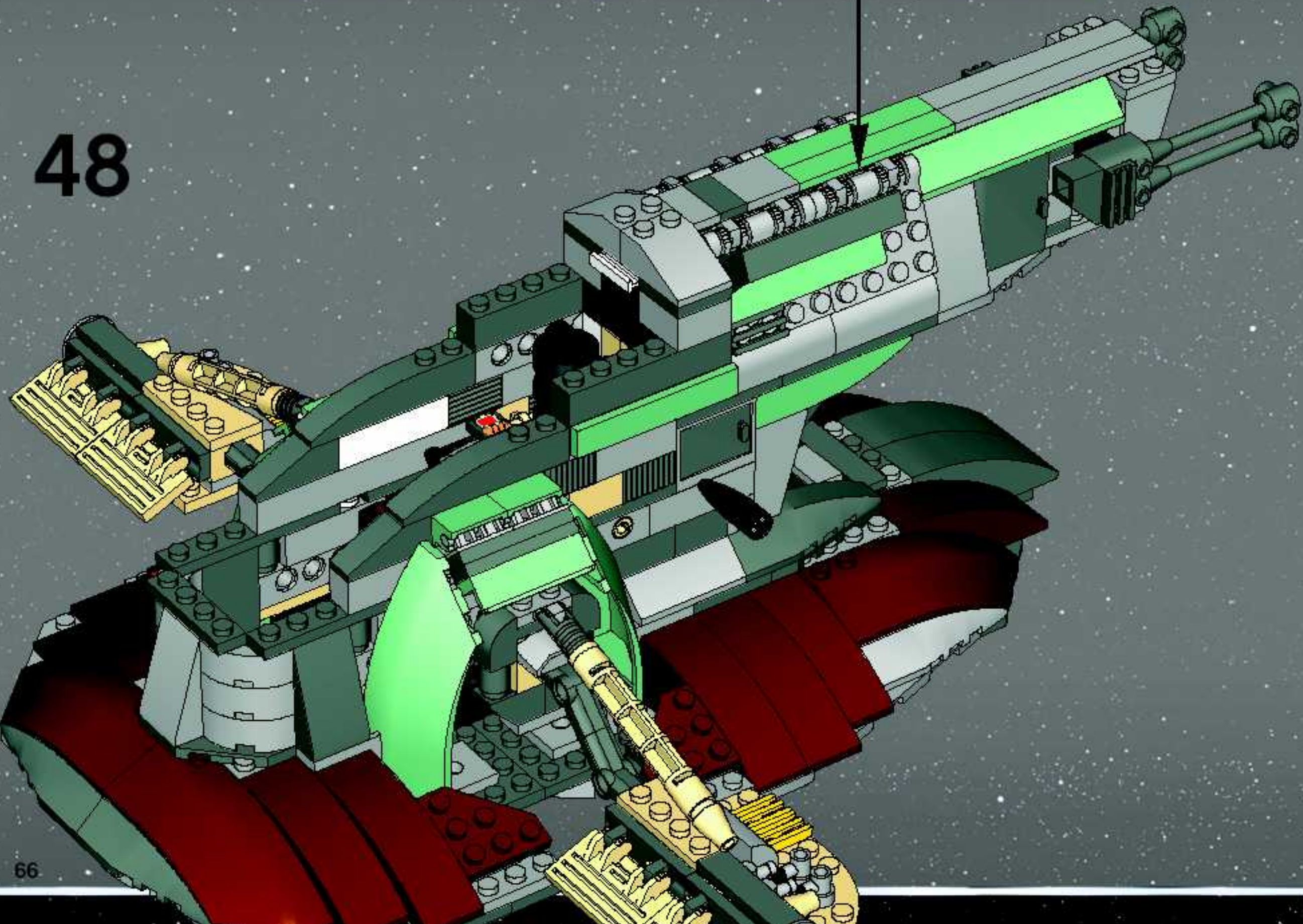

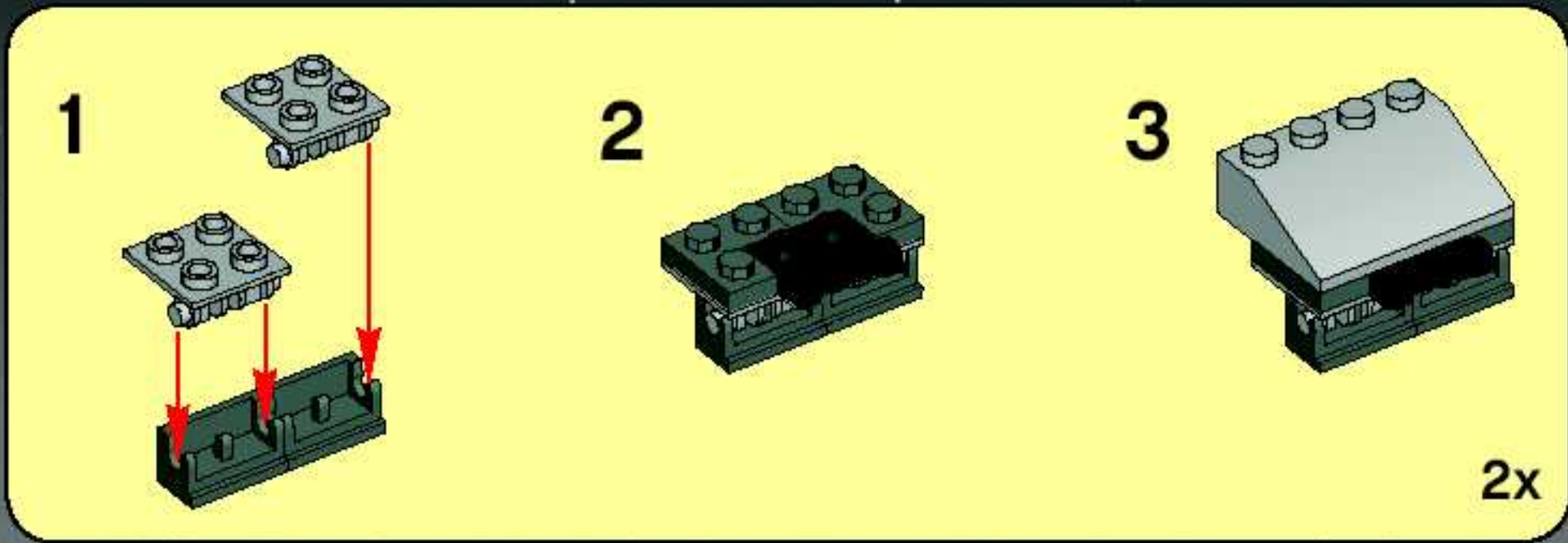

49

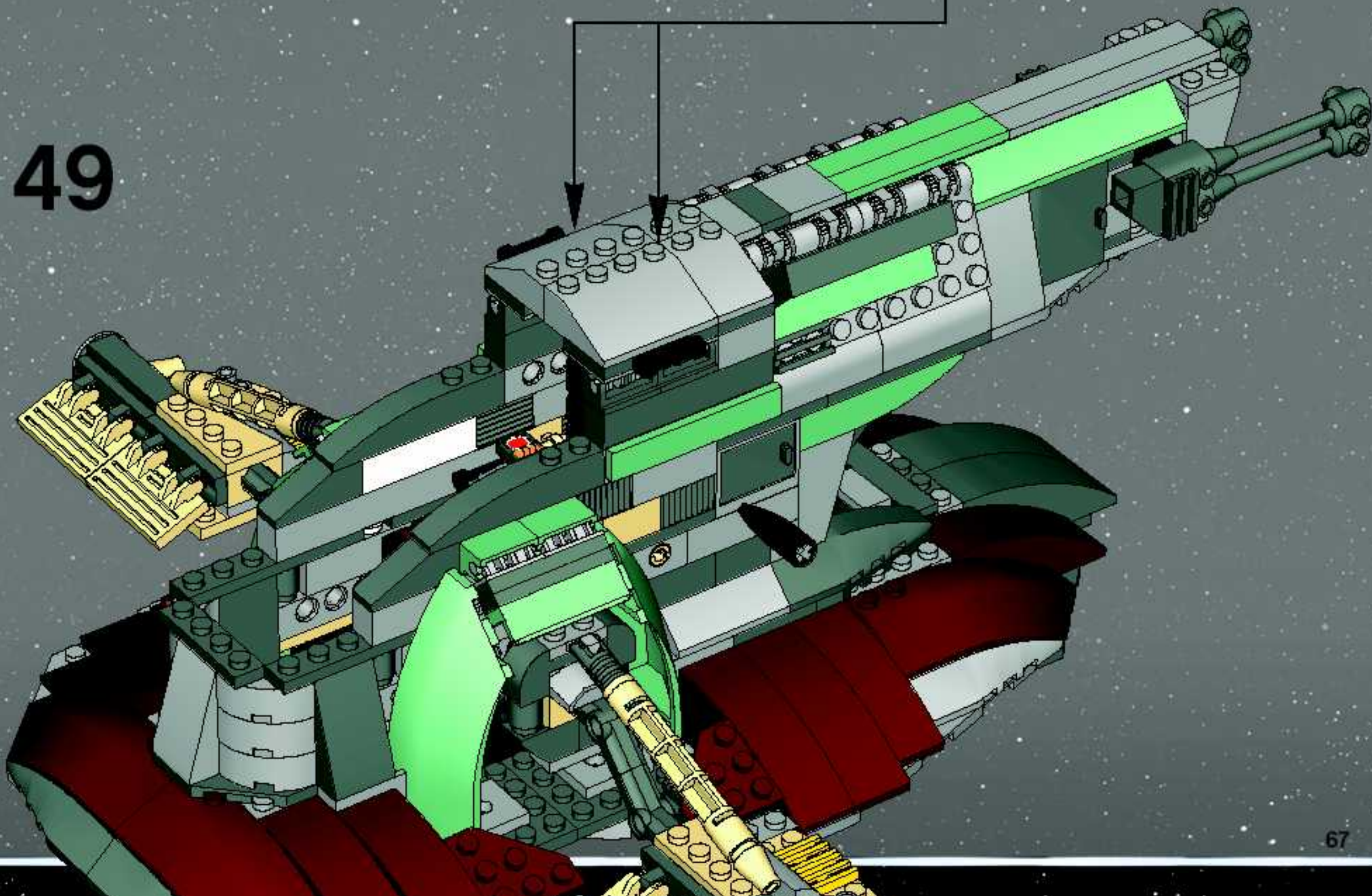

50

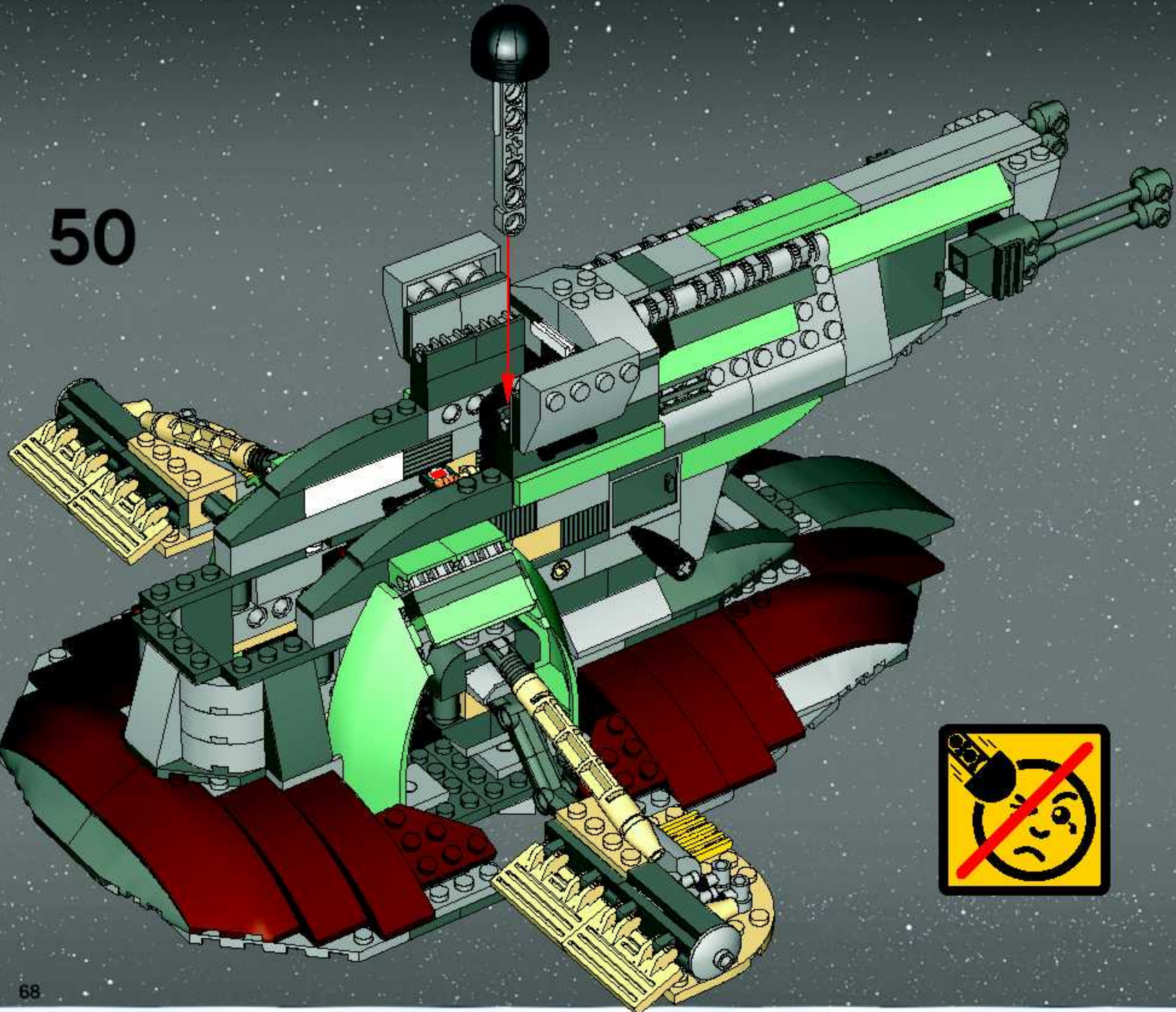

51

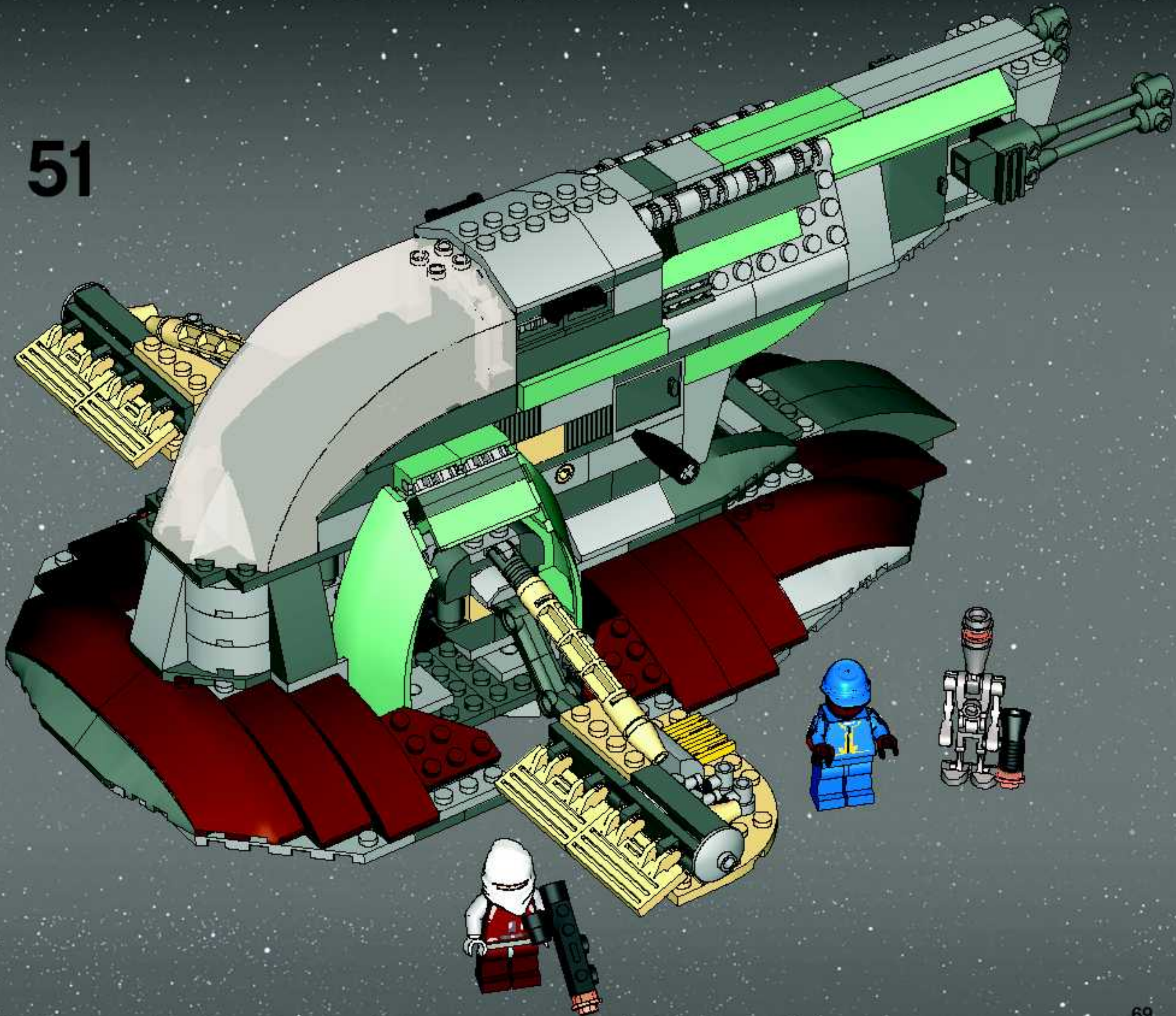

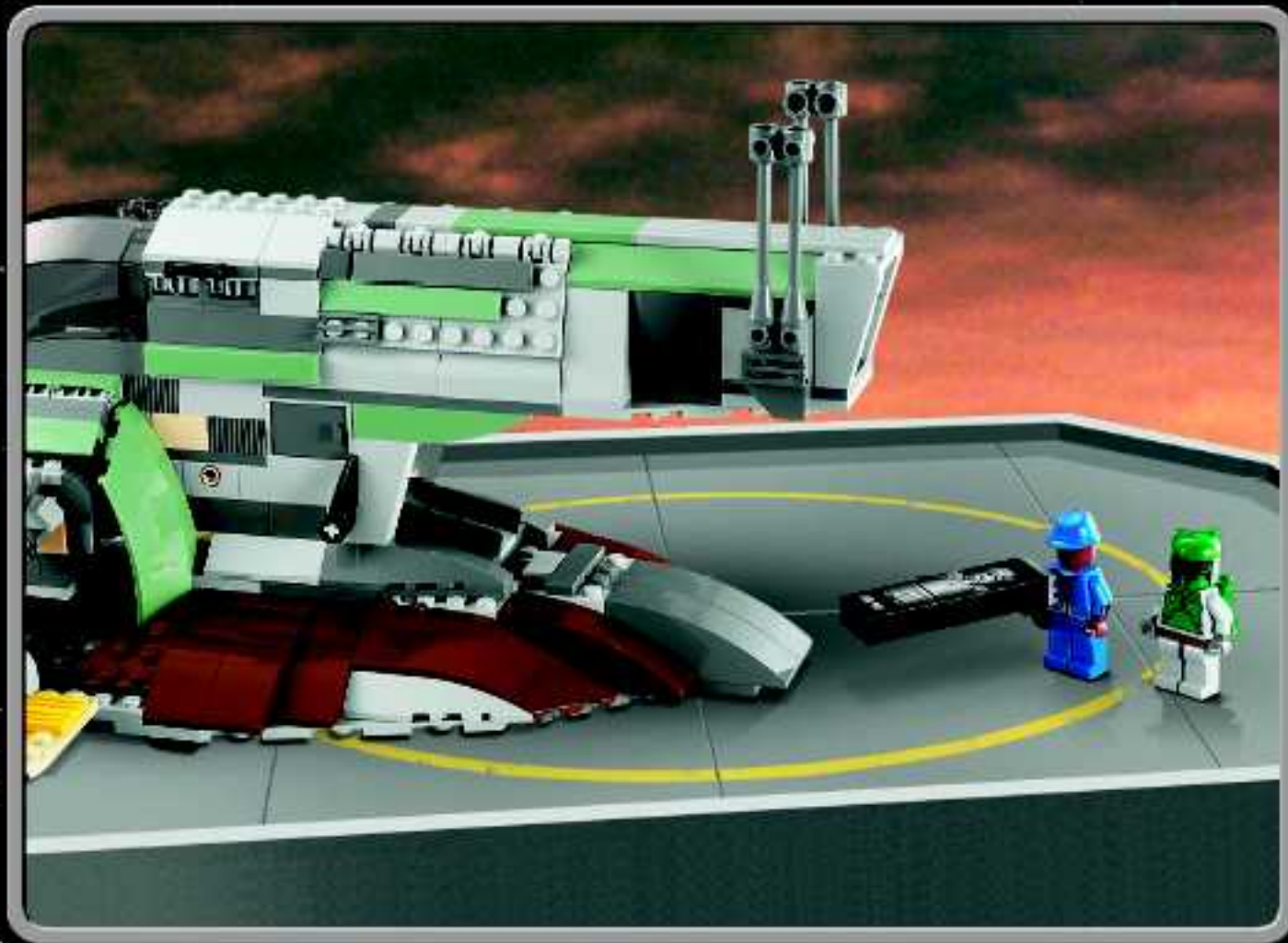

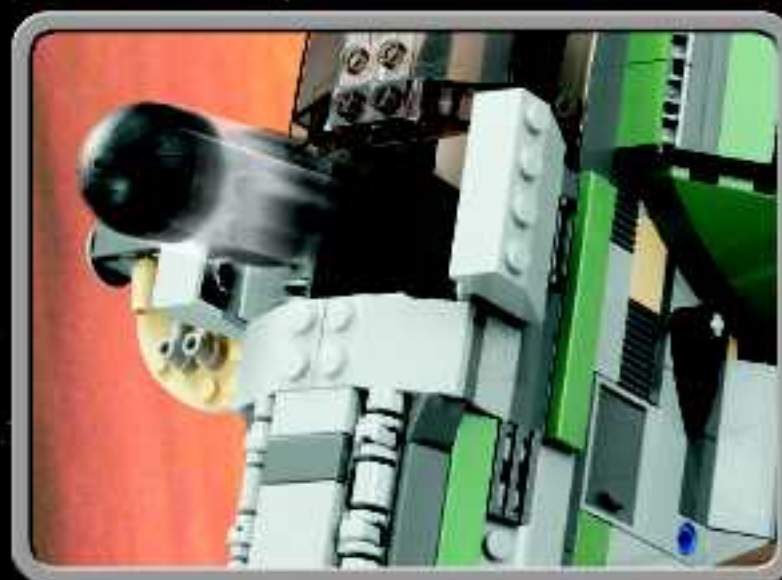
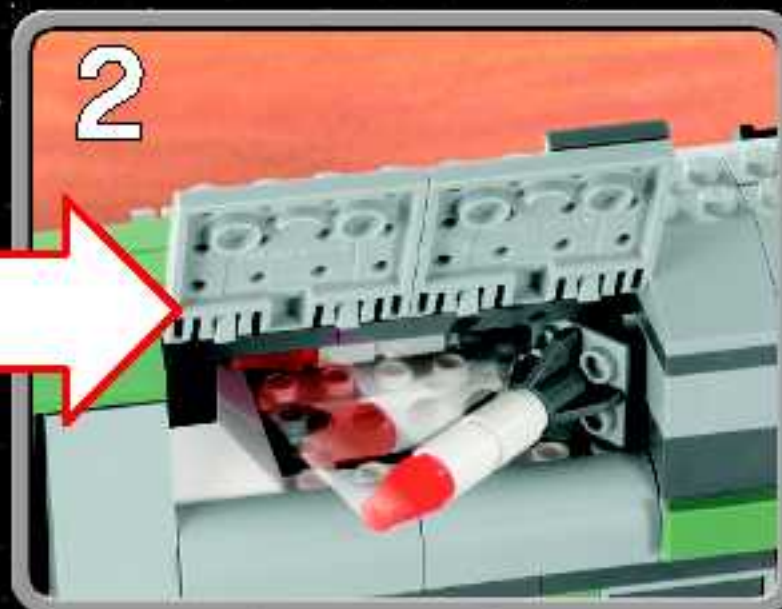
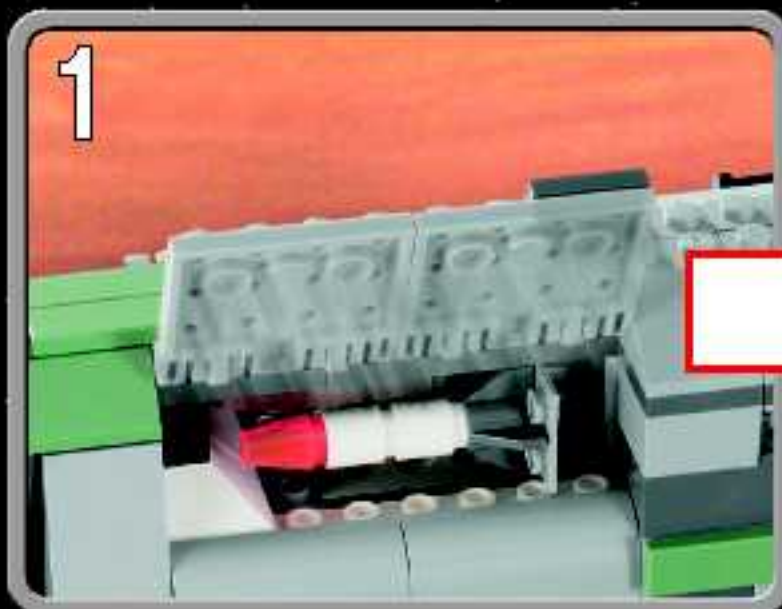
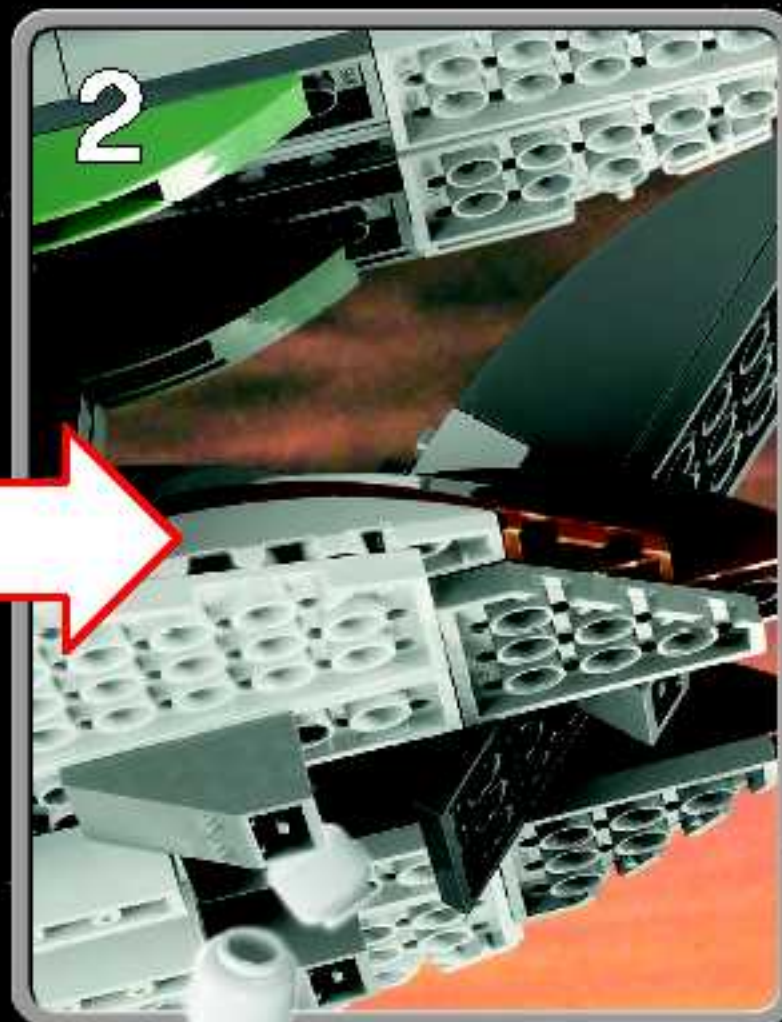
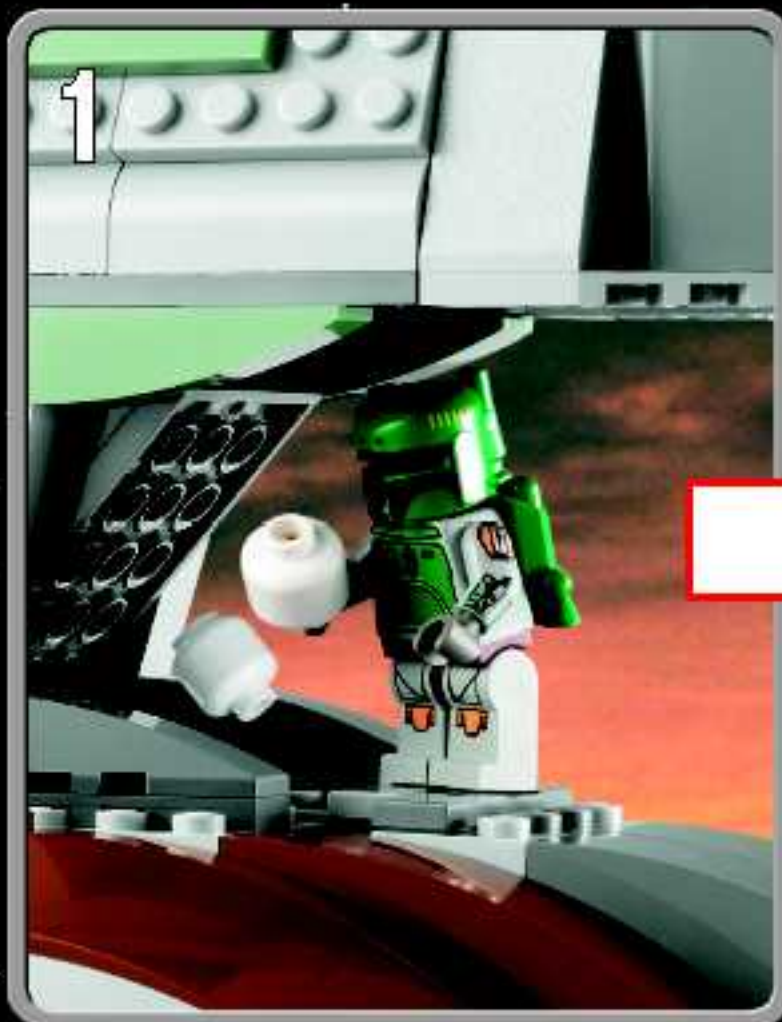











# club



**FREE!** Each LEGO Magazine Features...  
• Awesome creations by Kids like you!  
• Cool Comics & Stories  
• Building Tips & Ideas  
• Special Offers & Contests to WIN Prizes!

**GRATUIT!** Chaque Magazine LEGO offre...  
• Des créations épatantes par des jeunes comme toi!  
• Des bandes dessinées et des récits super cool  
• Des idées de construction  
• Des offres spéciales et des concours pour gagner des prix!

Join Today! Abonne-toi dès aujourd'hui!

# 1-866-534-6258

## www.LEGOclub.com



LEGO, the LEGO logo are trademarks of/ont des marques de commerce de/The LEGO Group. ©2005 The LEGO Group

# Win! Gagne!

### WIN LEGO® PRODUCTS

Log on to [www.acnielsen.aim.dk/LEGO](http://www.acnielsen.aim.dk/LEGO) for further instructions.

### GAGNE DES PRODUITS LEGO®

Visite [www.acnielsen.aim.dk/LEGO](http://www.acnielsen.aim.dk/LEGO) pour plus d'informations.

### ESTIMADO USARIO LEGO®

Al contestar algunas preguntas en Ingles, frances, aleman o Japones en el sitio [www.acnielsen.aim.dk/LEGO](http://www.acnielsen.aim.dk/LEGO), podras participar en el sorteo de algunas valiosos premios LEGO®.

[www.acnielsen.aim.dk/LEGO](http://www.acnielsen.aim.dk/LEGO)



### YES! I WANT TO JOIN THE LEGO® CLUB!

This coupon is good for 1 FREE 2-year Club membership. Additional kids may sign up for \$7.95 in the US and in Canada 10.70 (including taxes).

### OUI! JOIGNEZ-MOI AU CLUB LEGO®!

Ce coupon est valide pour 1 abonnement GRATUIT de 2 ans. Enfants additionnels peuvent s'inscrire pour 10,70 \$ (taxes incluses).

PLEASE PRINT IN ALL CAPITAL LETTERS

S.V.P. IMPRIMER EN LETTRES MAJUSCULES.

BIC26

Name/Nom \_\_\_\_\_ Age \_\_\_\_\_  Français  English

Address/Adresse \_\_\_\_\_  Girl/Fille  Boy/Garçon

City/Ville \_\_\_\_\_ State/Prov. \_\_\_\_\_ Postal Code Code Postal \_\_\_\_\_

E-mail Address/Courriel \_\_\_\_\_ Date of Birth Date de Naissance \_\_\_\_\_ / \_\_\_\_\_ / \_\_\_\_\_  
M DJ YA

Parent's Signature/Signature d'un parent \_\_\_\_\_

Mail to/Poster à:  
**LEGO Club**  
P. O. Box 1157  
Enfield, CT 06083-1157



Offer limited to residents of US and Canada. No photocopies will be accepted. Offer limited to two free memberships per family, group or organization. Please allow 4-6 weeks for delivery of your first mailing.

Offre limitée pour résidents du US et Canada. Photocopies ne seront pas acceptées. Offre limitée à deux abonnements gratuits par famille, groupe, ou organisation. Attendez 4-6 semaines pour la première livraison.

FREE  
LEGO Magazine  
with this coupon!  
Magazines LEGO  
GRATUITS  
avec ce coupon!



# SHOP at HOME

## The World's Biggest LEGO® Shop!



For a Free Catalog in the U.S.  
and Canada, call toll-free:  
**1-866-534-6737**  
Or go online:  
[www.LEGOshop.com/catalog](http://www.LEGOshop.com/catalog)

Pour obtenir un Catalogue GRATUIT  
aux États-Unis et au Canada,  
téléphonez sans frais au :  
**1-866-534-6737**  
Ou venez en ligne sur :  
[www.LEGOshop.com/catalog](http://www.LEGOshop.com/catalog)

Any questions  
regarding  
your new  
LEGO  
product,  
please contact:  
Customer Service

| Service  
Consom-  
mateurs |  
Servicio :

 1-800-422-5346

or  
[www.lego.com/service](http://www.lego.com/service)



LEGO, the LEGO logo are trademarks of the LEGO Group. ©2006 The LEGO Group.

### FREE LEGO® Catalog!

Please print with a pen in capital letters.

First Name  
Prénom \_\_\_\_\_

Last Name  
Nom \_\_\_\_\_

Address  
Adresse \_\_\_\_\_

City  
Ville \_\_\_\_\_

State  
Prov. \_\_\_\_\_

Zip Code  
Code Postal \_\_\_\_\_

Phone (optional)  
No de téléphone  
(optionnel) \_\_\_\_\_

Email (optional)  
Courriel (optionnel) \_\_\_\_\_

Check Below / Indiquer ci-bas

I speak English

Je parle Français

Boy/Garçon

Girl/Fille

### Catalogue LEGO® Gratuit!

S.V.P. Écrire en lettres majuscules avec un stylo à bille noir.

CRBP26

Mail to/Poster à:



P. O. Box 1221  
EnField, CT 06083-1221



U.S. and Canada only  
É-U et Canada seulement

Please allow 2-4 weeks for delivery.  
Veuillez s.v.p. allouer 2 à 4  
semaines pour l'expédition.

©2006 The LEGO Group.