



CITY

60397



1

2



Get excited about our new packaging!

We're switching from plastic to paper-based packaging. That's why you might find a mix of paper and plastic in our boxes!

Nos nouveaux emballages vous emballeront !

Nous passons des emballages en plastique aux emballages à base de papier. C'est pourquoi vous pourriez trouver un mélange de papier et de plastique dans nos boîtes !

¡Te presentamos nuestros nuevos empaques!

Estamos sustituyendo las bolsas de plástico por bolsas con base de papel. ¡Por eso, puedes encontrar una mezcla de papel y de plástico en nuestras cajas!

[LEGO.com/sustainable-packaging](https://www.lego.com/sustainable-packaging)



BUILDER



Apple and the Apple logo are trademarks of Apple Inc., registered in the U.S. and other countries and regions. App Store is a service mark of Apple Inc. Google Play and the Google Play logo are trademarks of Google LLC. Tencent and the Tencent logo are trademarks of Tencent Inc.

Q [LEGO.com/devicecheck](https://www.lego.com/devicecheck)

EN Ask parents' permission before going online | **DE** Eltern um Erlaubnis bitten, bevor du online gehst | **FR** Demande l'autorisation d'un parent avant d'aller en ligne | **IT** Chiedi il permesso ai tuoi genitori prima di andare online | **ES** Pídeles permiso a tus papás antes de conectarte a Internet | **PT** Pede autorização aos pais antes de acederes online | **ZH** 上网前应先征得父母的同意 | **PL** Poproś rodziców o zgodę, zanim wejdiesz do Internetu | **CS** Než půjdeš na internet, požádej rodiče o svolení | **SK** Skôr než pôjdeš na internet, vypýtaj si povolenie od rodičov | **HU** Kérj szülői engedélyt, mielőtt online csatlakoznál! | **RO** Cere permisiunea părinților înainte de a te conecta online | **BG** Поискайте разрешение от родител, преди да влезете онлайн | **LV** Pirms došanās tiešsaistē palūdz atļauju vecākiem | **ET** Enne Interneti kasutamist küsi vanematelt luba | **LT** Prieš prisijungdami prie interneto, atsiklauskite tėvų

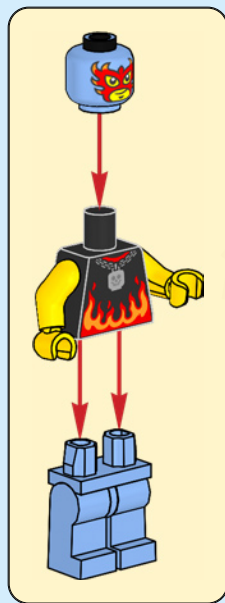

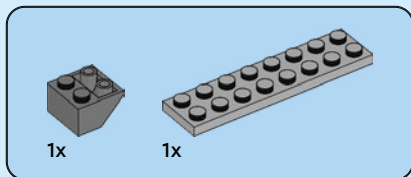

1

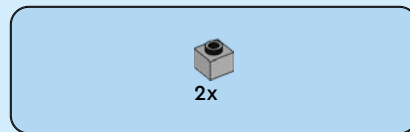
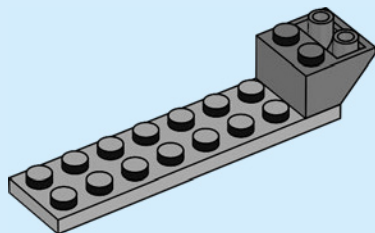

2

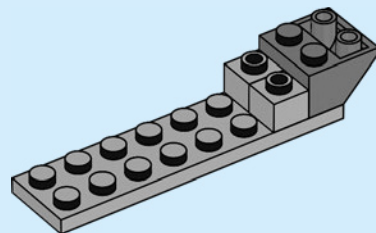



2x



1x

3

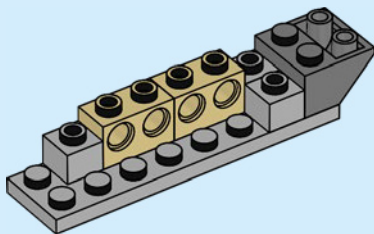



2x



1x

4

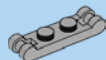
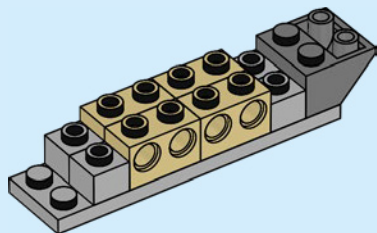

2x

5

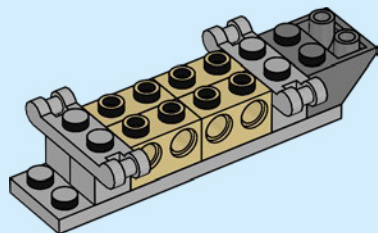



1x

6

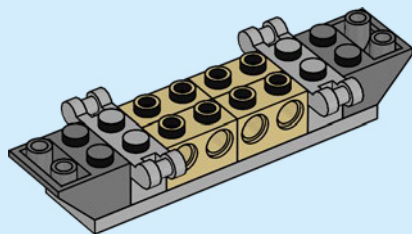

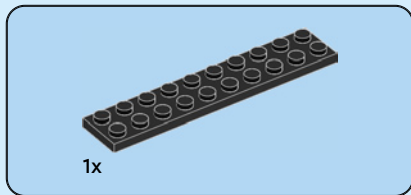

7

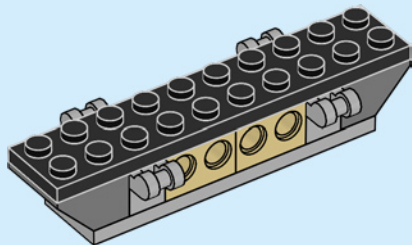

8

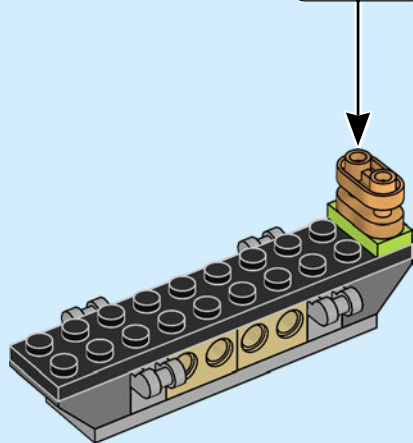
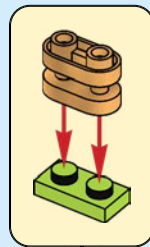

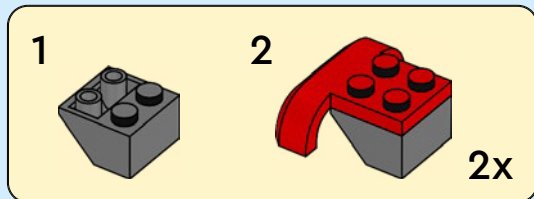
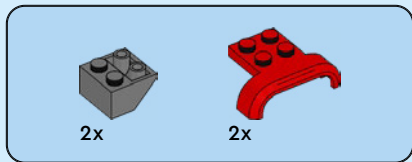

9

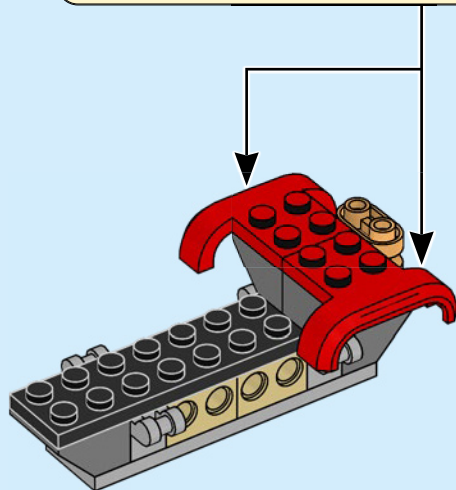

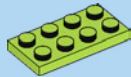

1x

10

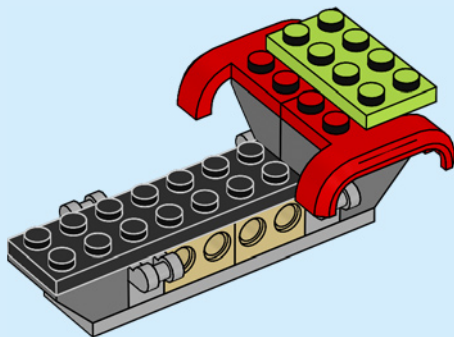

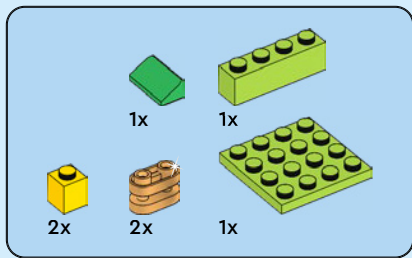

11

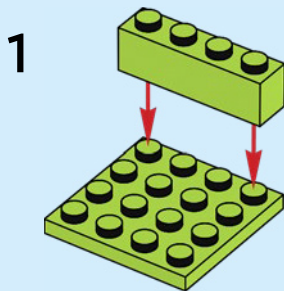

2

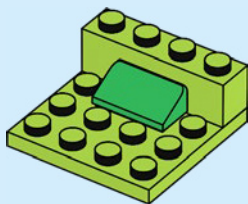

3

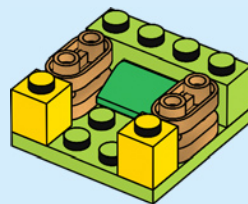

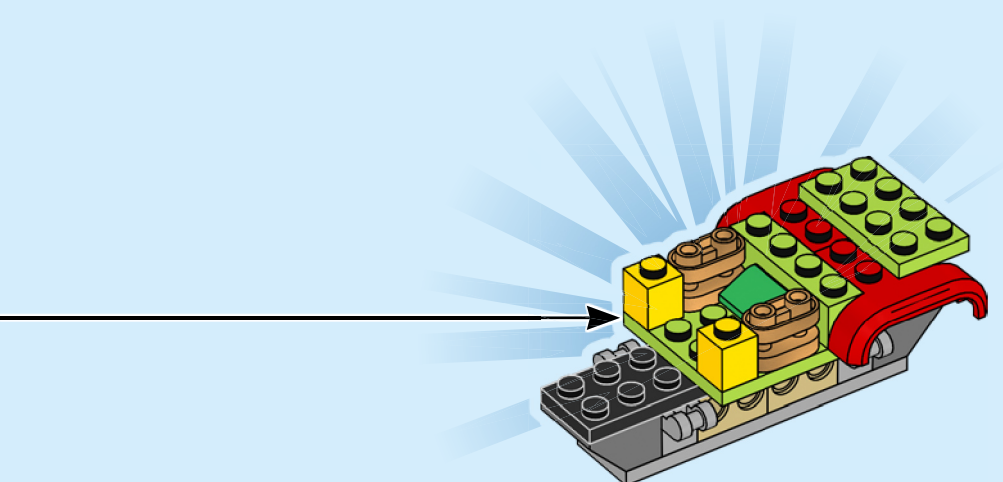

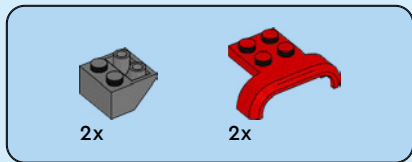

12

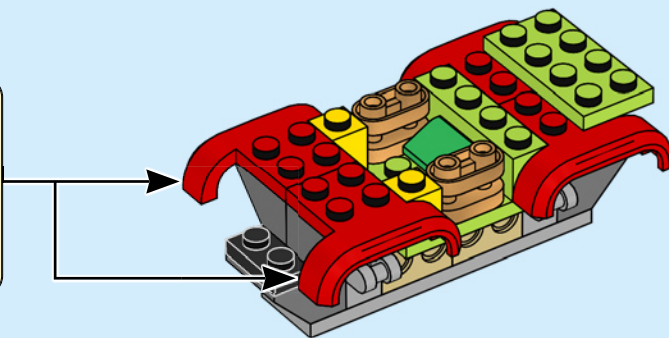
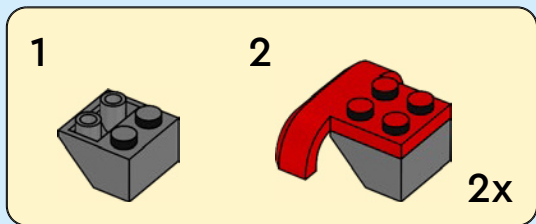

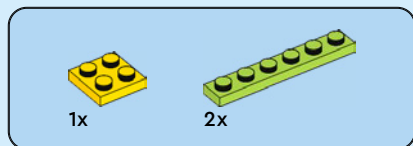

13

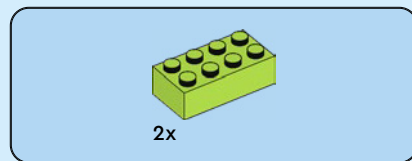
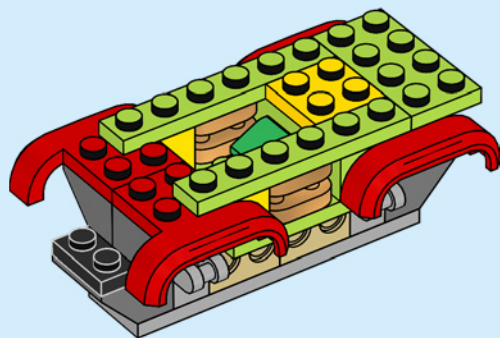

14

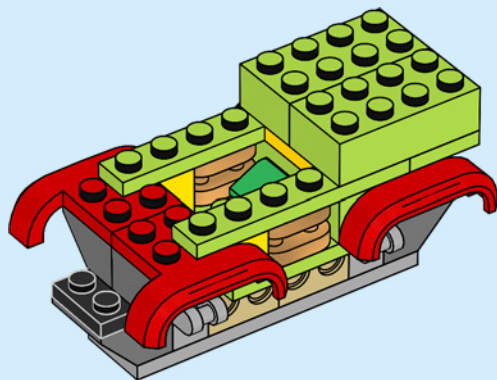

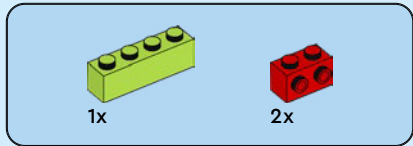

15

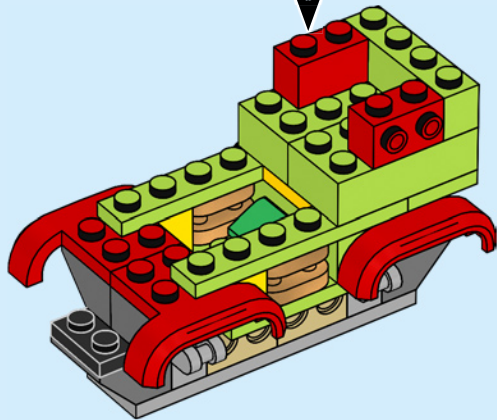
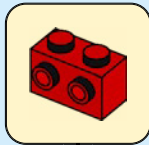

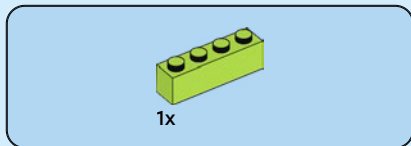

16

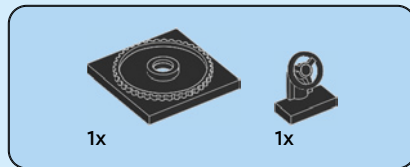
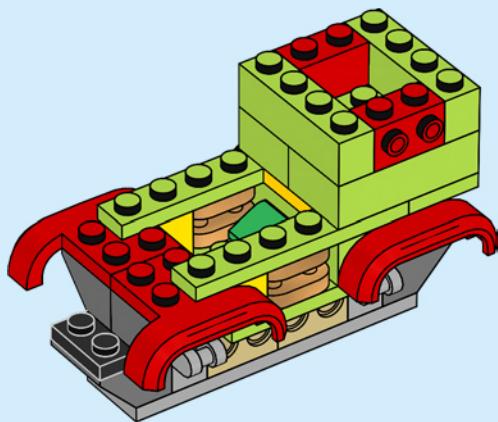

17

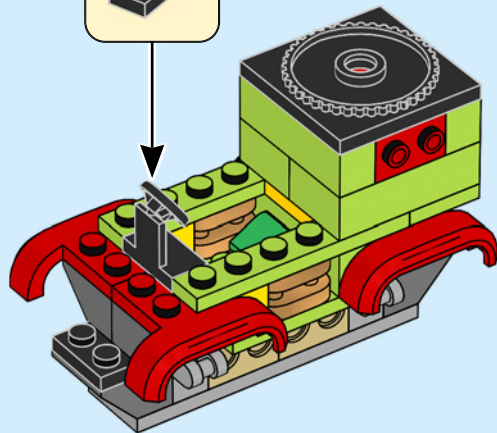
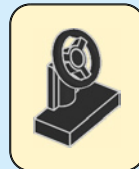



1x



1x

18

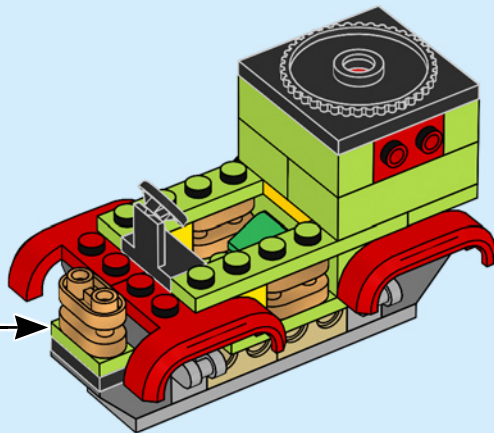
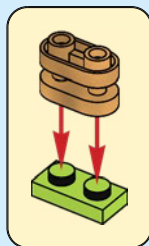

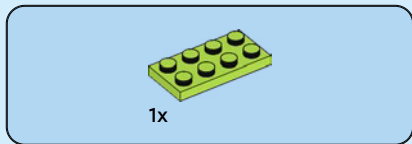

19

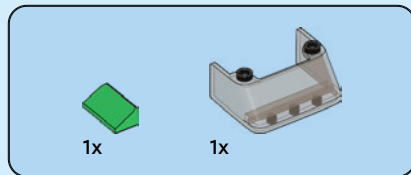
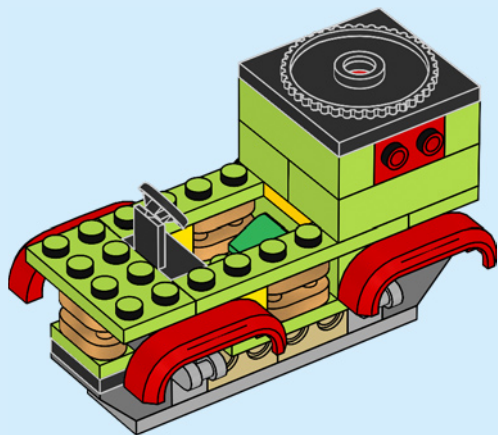

20

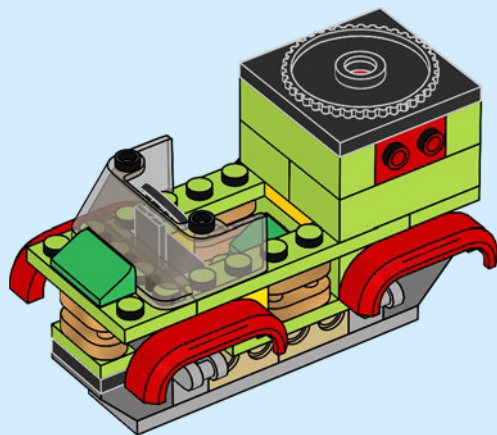

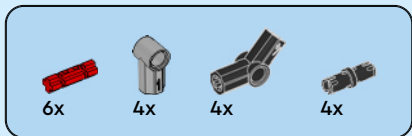
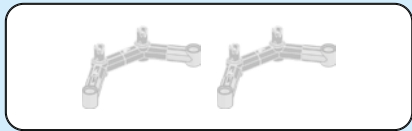

21

1

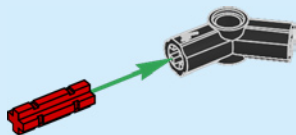

2

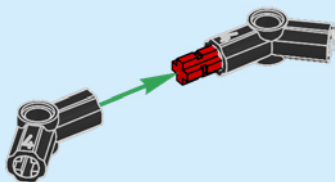

3

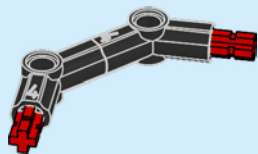

4

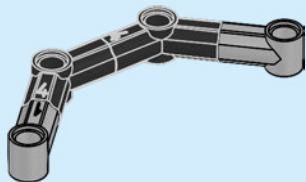

5

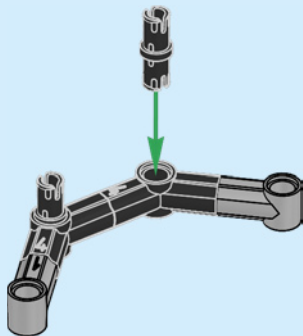

2x

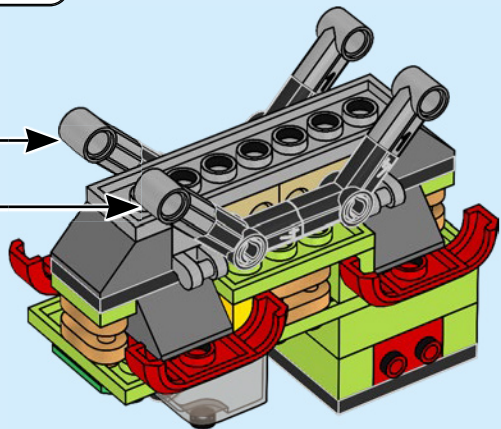
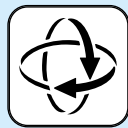

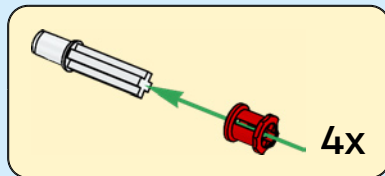
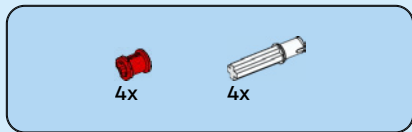

22

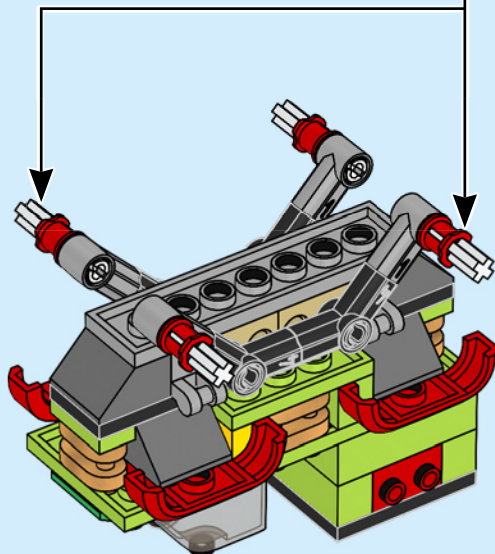



2x

23

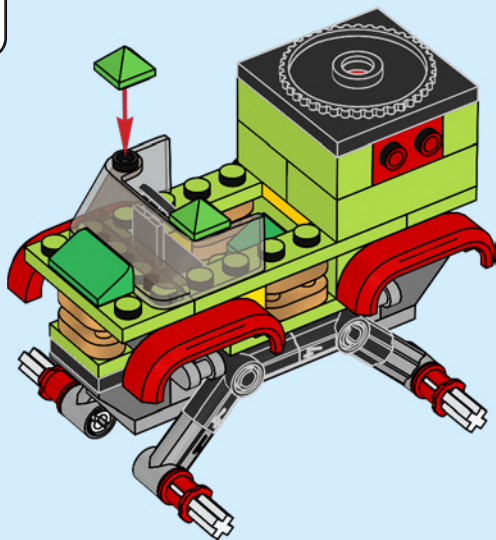
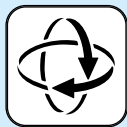

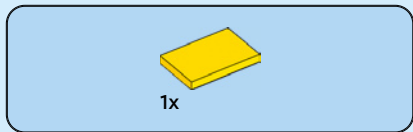

24

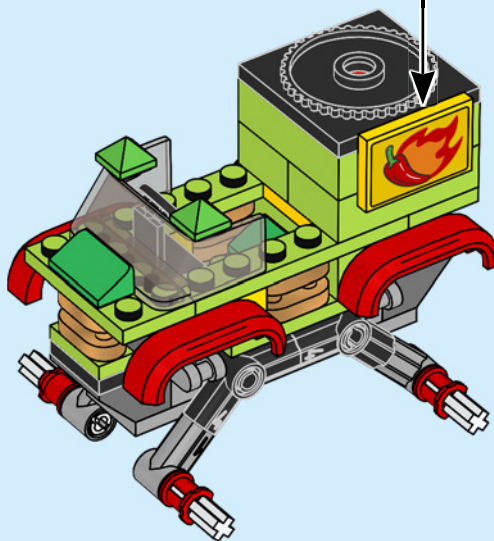
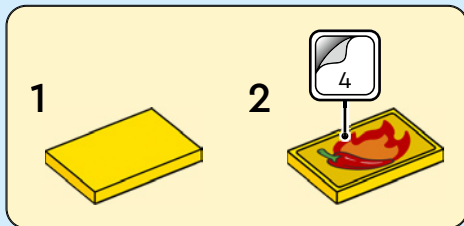

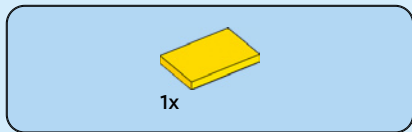

25

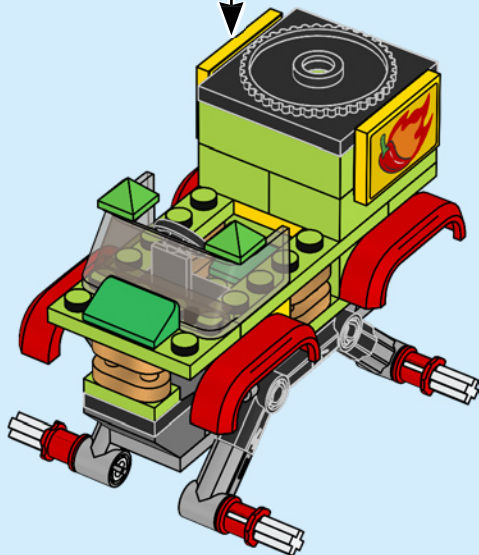
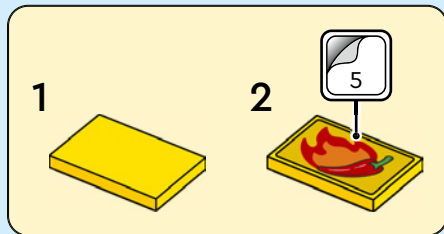

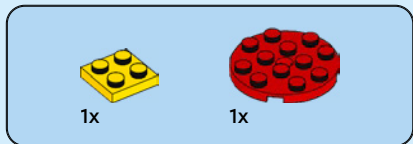
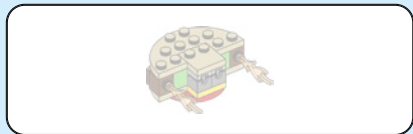

26

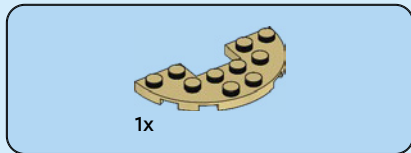
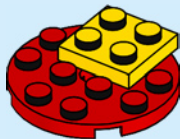

27



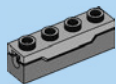

2x

28

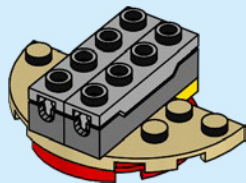

2x

29

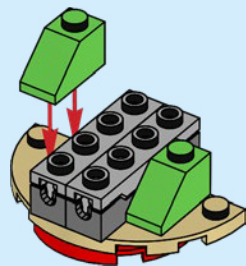

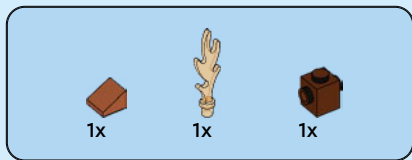

30

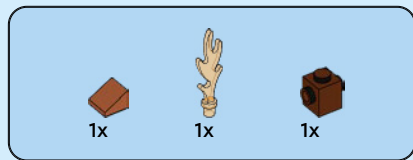
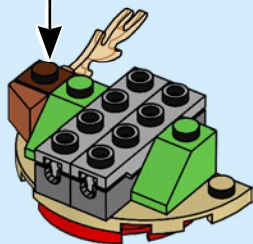
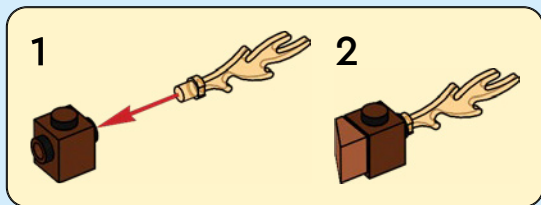

31

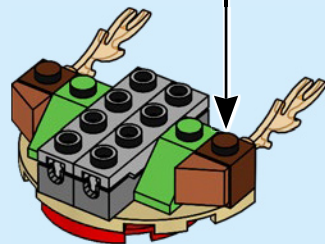
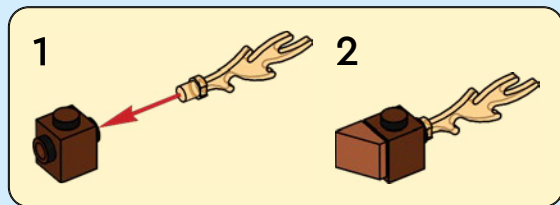

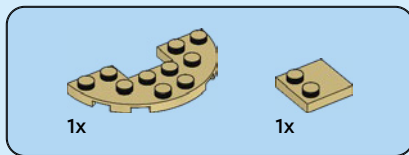

32

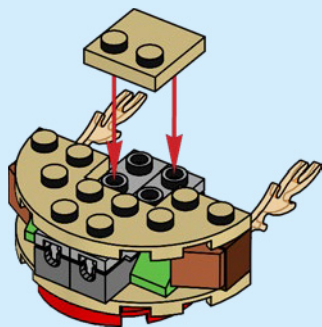

33

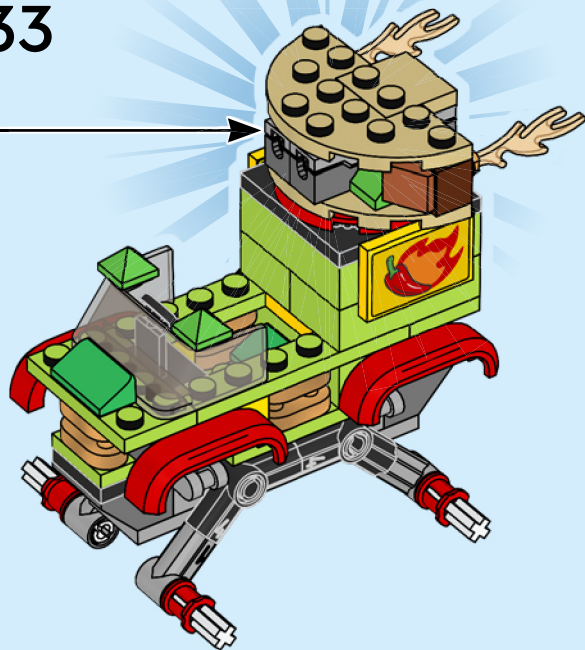

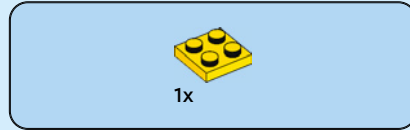
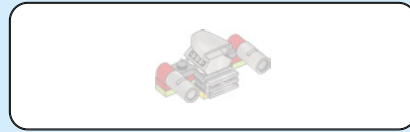

34



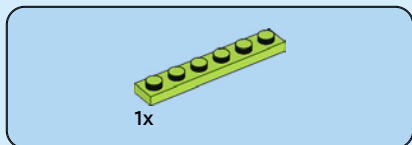

35

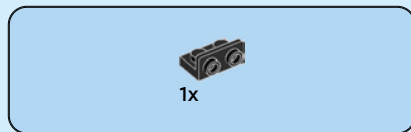
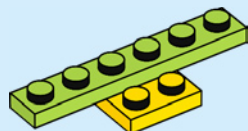

36

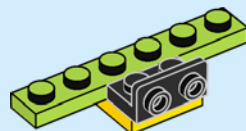



2x

37

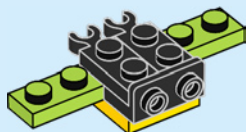

1x

38

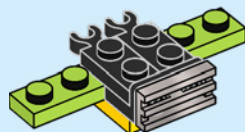



2x

39

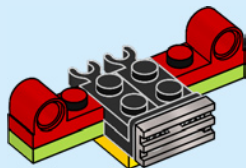

2x

40

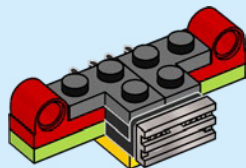



2x

41

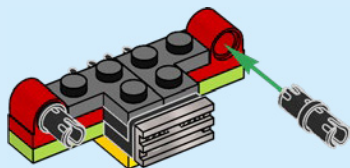



2x

42

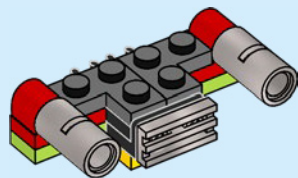

1x

43

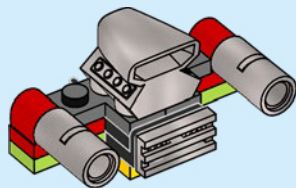

44

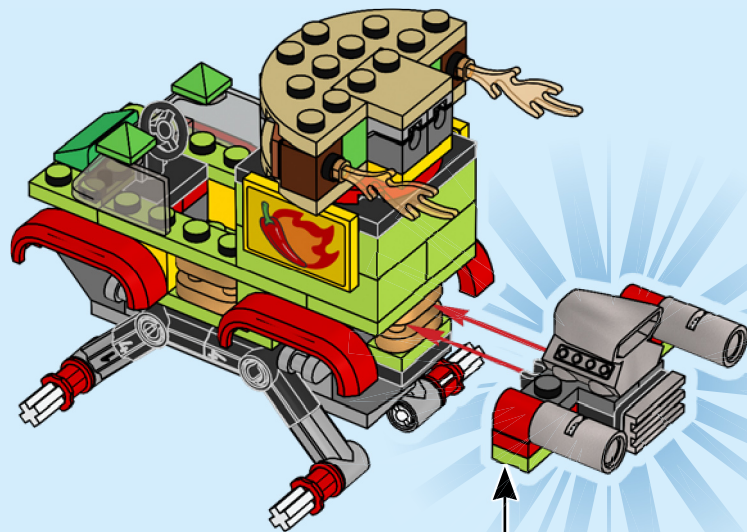

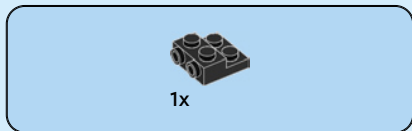

1x

45

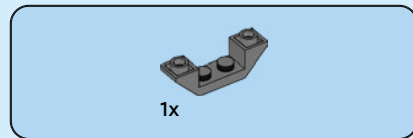
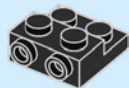

1x

46

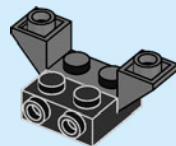



2x

47

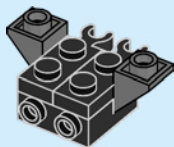

1x



1x

48





1x



1x

49

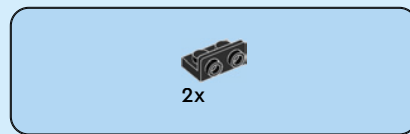
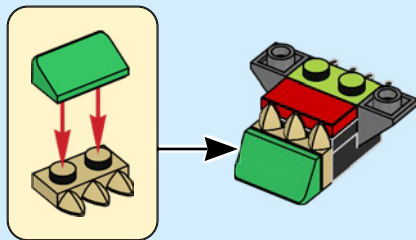

2x

50

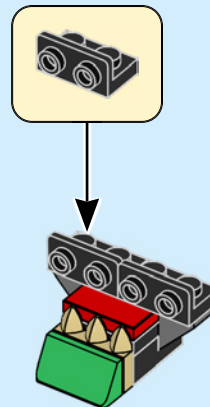



1x

51

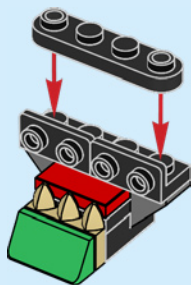



2x



1x

52

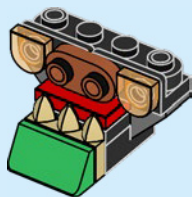

1x



2x

53

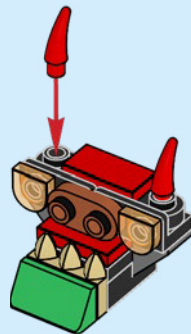

54

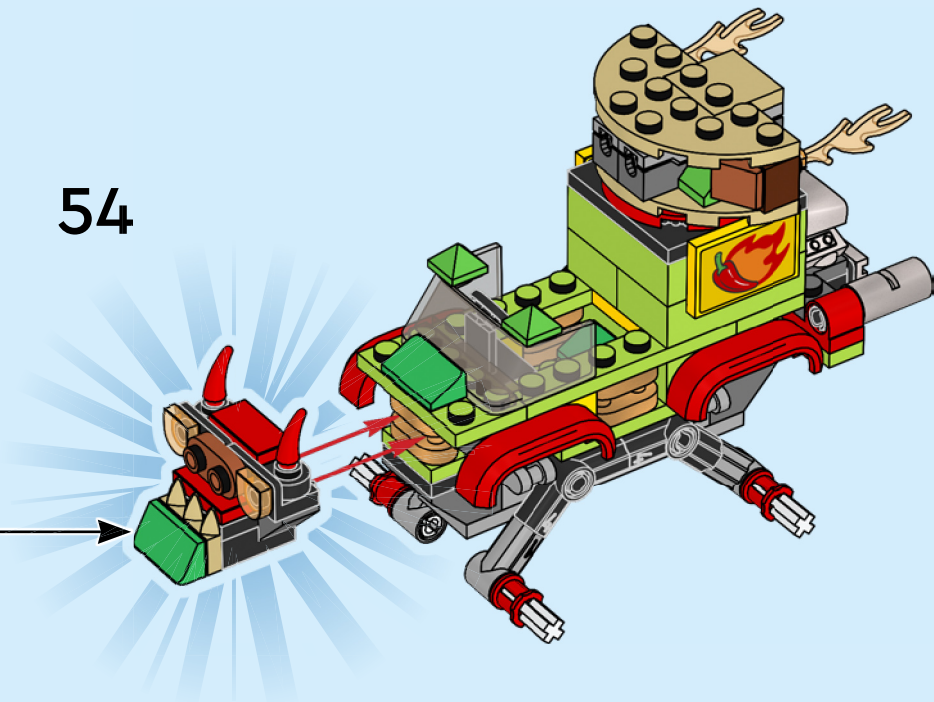

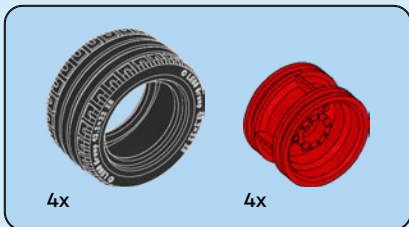

55

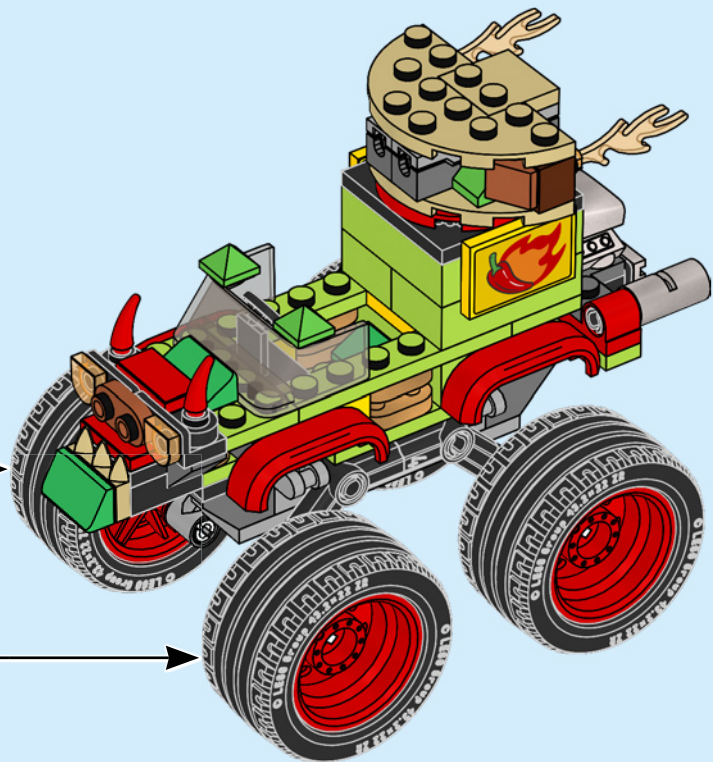
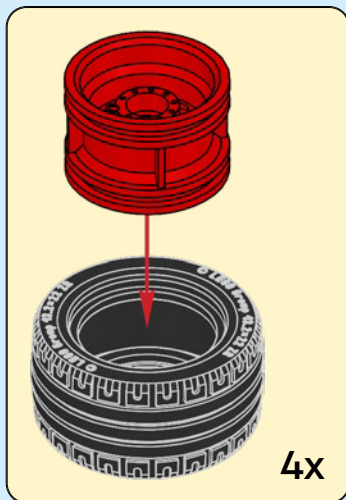



1x

56

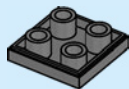

2x

57

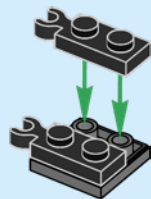



2x

58

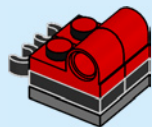

1x

59

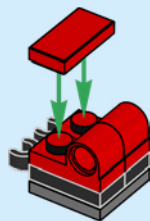



1x

60

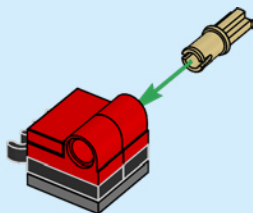

1x



1x

61

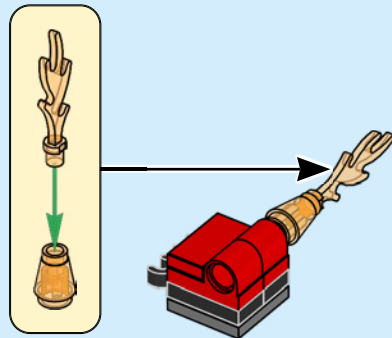



1x

62

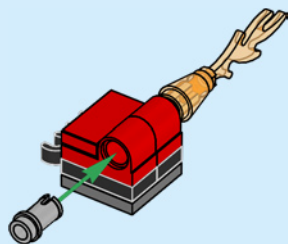

1x

63

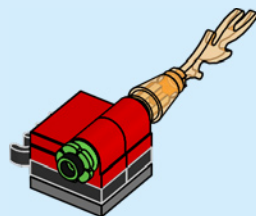

64

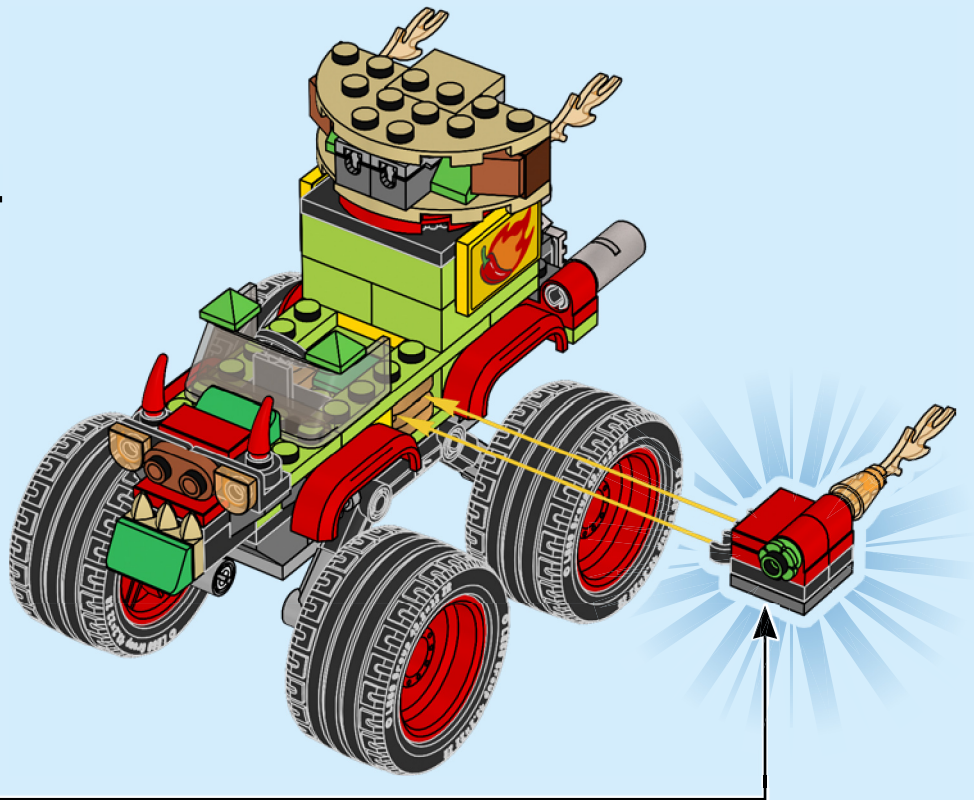



1x

65

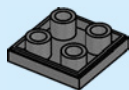

2x

66

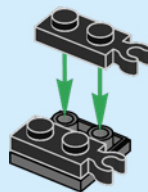



2x

67

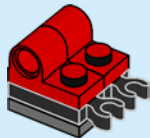

1x

68

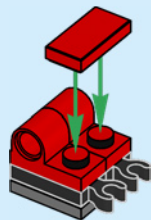



1x

69

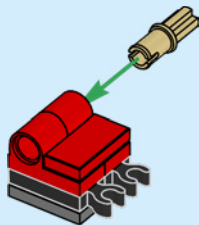

1x



1x

70

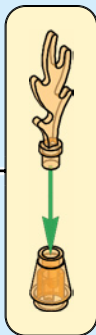
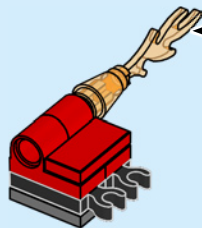



1x

71

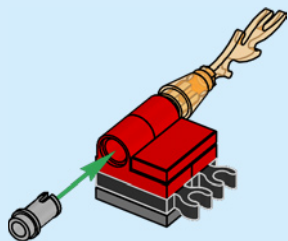

1x

72

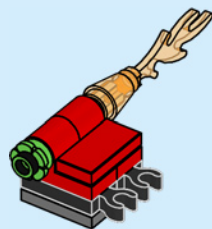

73

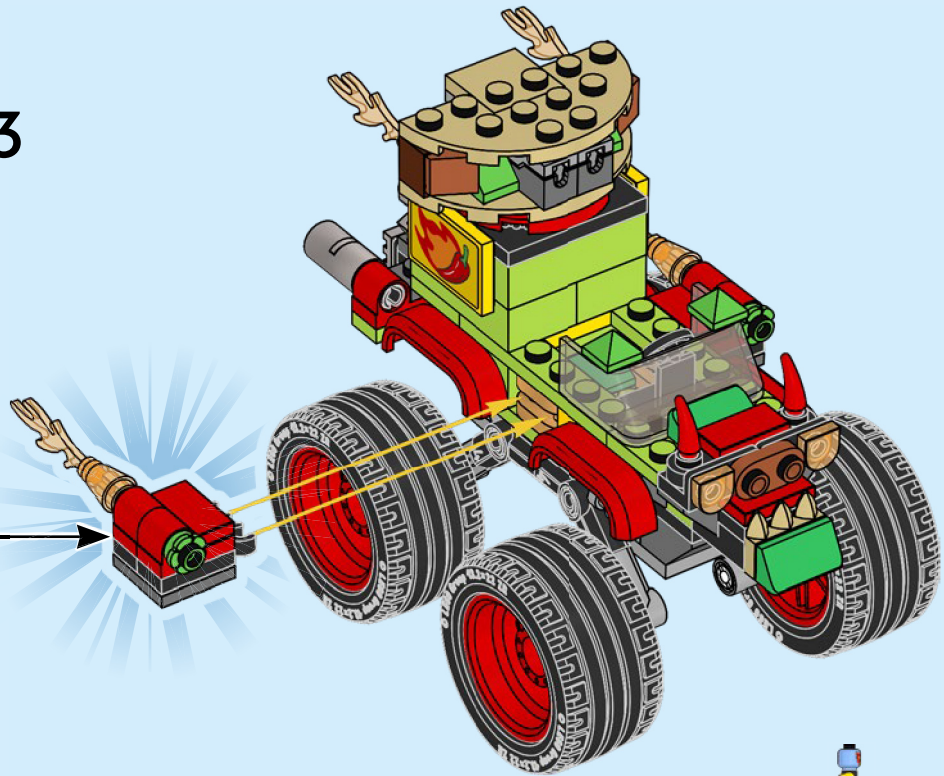

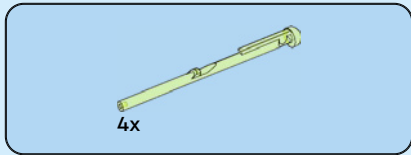

74

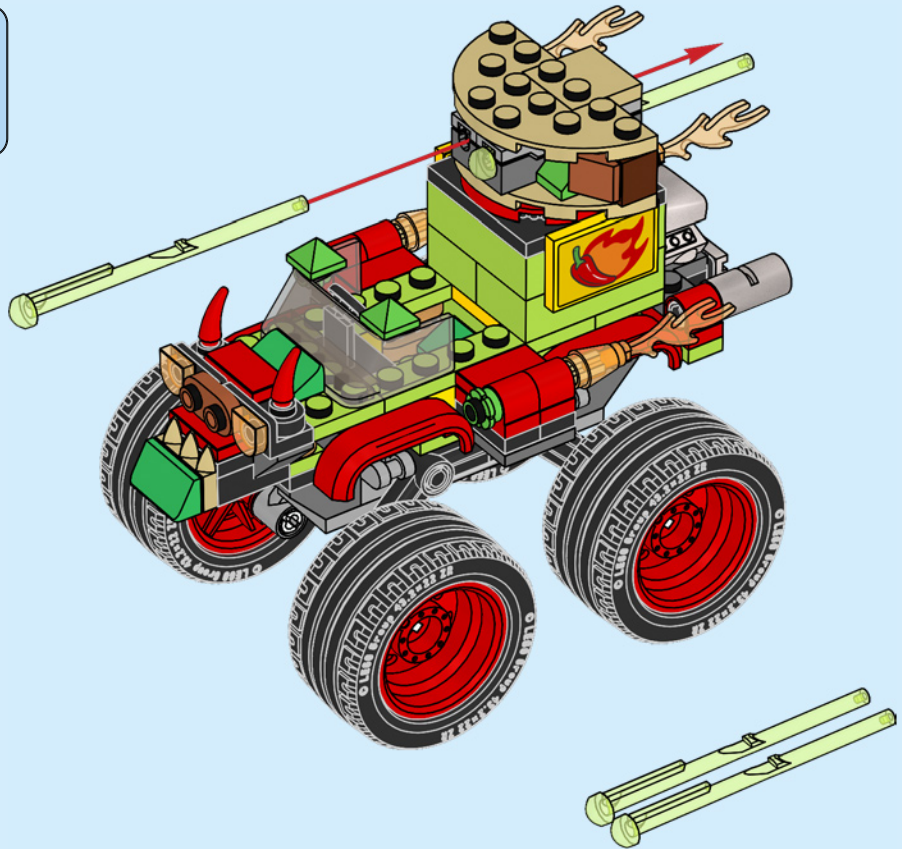

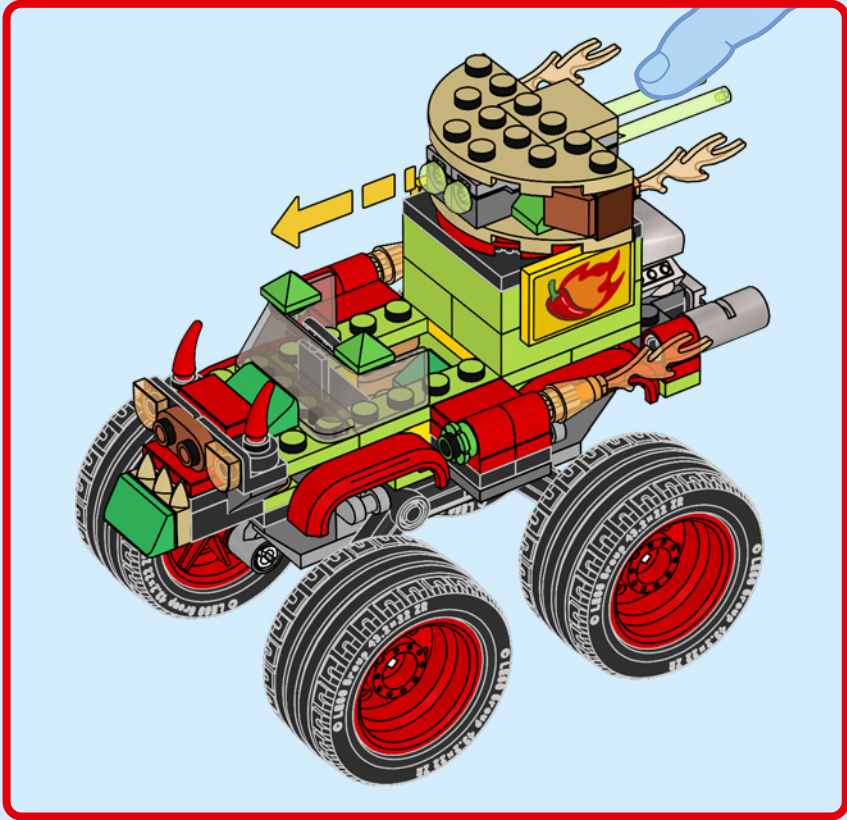

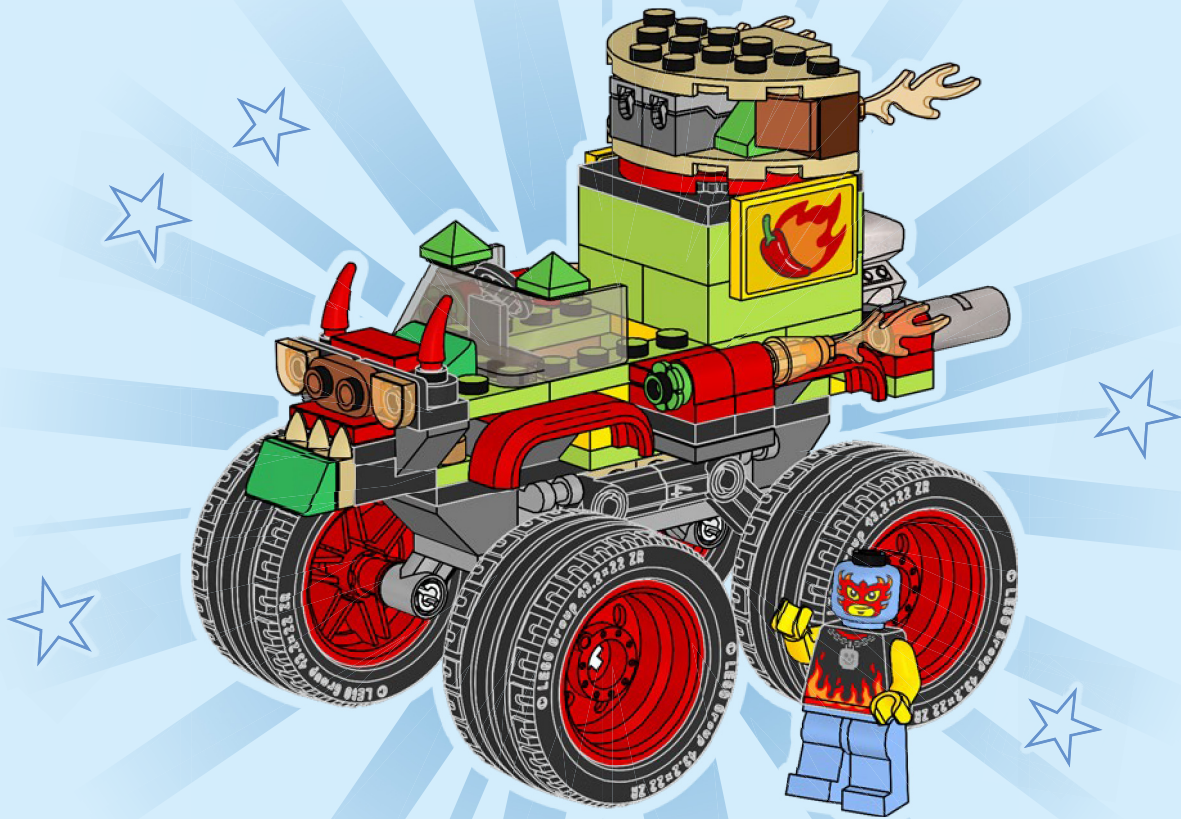

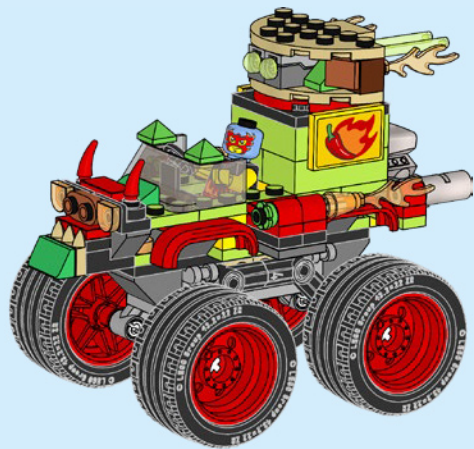
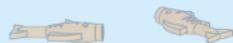
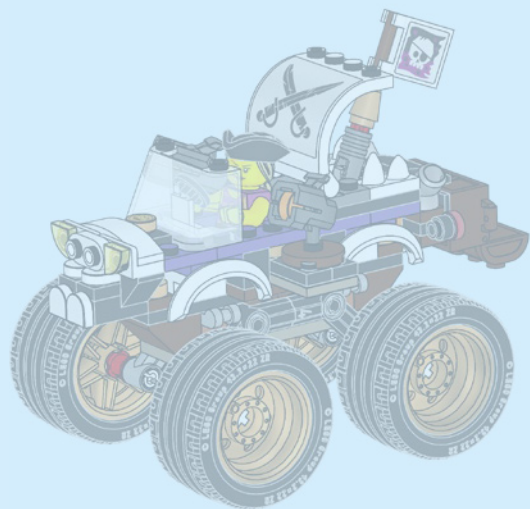



CITY



PLAY-IT-IN
LEGO 2K DRIVE

JOUEZ-AVEC-DANS
LEGO 2K DRIVE

JUEGA-CON-EL-MODELO-EN
LEGO 2K DRIVE





CITY

60368



60377



60378



60379





Rebuild
the
world™



LEGO and the LEGO logo are trademarks of the/sont des marques de commerce du/
son marcas registradas de LEGO Group. ©2023 The LEGO Group. 6475172